

TEST REPORT

Report No.: BCTC2202331521-1E

Applicant: DongGuan AnJu Electronic Technology Co., Ltd

Product Name: FAST WIRELESS CHARGING

Model/Type
reference: AW-ZD301B

Tested Date: 2022-02-15 to 2022-02-24

Issued Date: 2022-02-24



Shenzhen BCTC Testing Co., Ltd.

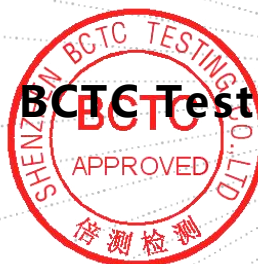

FCC ID:2AZ8P-AWZD301B

Product Name: FAST WIRELESS CHARGING
Trademark: N/A
Model/Type reference: AW-ZD301B
AW-ZD301
Prepared For: DongGuan AnJu Electronic Technology Co., Ltd
Address: No.1 Harmony Road, Shanwu Village, Shijie Town, Dongguan City China
Manufacturer: DongGuan AnJu Electronic Technology Co., Ltd
Address: No.1 Harmony Road, Shanwu Village, Shijie Town, Dongguan City China
Prepared By: Shenzhen BCTC Testing Co., Ltd.
Address: 1-2/F., Building B, Pengzhou Industrial Park, No.158, Fuyuan 1st Road, Tangwei,
Fuhai Subdistrict, Bao'an District, Shenzhen, Guangdong, China
Sample Received Date: 2022-02-15
Sample tested Date: 2022-02-15 to 2022-02-24
Issue Date: 2022-02-24
Report No.: BCTC2202331521-1E
Test Standards: FCC Part15.209
ANSI C63.10-2013
Test Results: PASS

Tested by:

Kelsey Tan/ Project Handler

Approved by:

Zero Zhou/Reviewer

The test report is effective only with both signature and specialized stamp. This result(s) shown in this report refer only to the sample(s) tested. Without written approval of Shenzhen BCTC Testing Co., Ltd, this report can't be reproduced except in full. The tested sample(s) and the sample information are provided by the client.

Table Of Content

Test Report Declaration	Page
1. Version	4
2. Test Summary	5
3. Measurement Uncertainty	6
4. Product Information And Test Setup	7
4.1 Product Information	7
4.2 Test Setup Configuration	7
4.3 Support Equipment	8
4.5 Test Mode	8
5. Test Facility And Test Instrument Used	9
5.1 Test Facility	9
5.2 Test Instrument Used	9
6. Conducted Emissions	11
6.1 Block Diagram Of Test Setup	11
6.2 Limit	11
6.3 Test procedure	11
6.4 EUT operating Conditions	11
6.5 Test Result	12
7. Radiated Emissions	14
7.1 Block Diagram Of Test Setup	14
7.2 Limit	15
7.3 Test procedure	15
7.4 Test Result	17
8. Bandwidth Test	20
8.1 Test Procedure	20
8.2 Test Setup	20
8.3 Test Result	21
9. Antenna Requirements	23
9.1 Limit	23
9.2 Test Result	23
10. EUT Photographs	24
11. EUT Test Setup Photographs	25

(Note: N/A Means Not Applicable)

1. Version

Report No.	Issue Date	Description	Approved
BCTC2202331521-1E	2022-02-24	Original	Valid

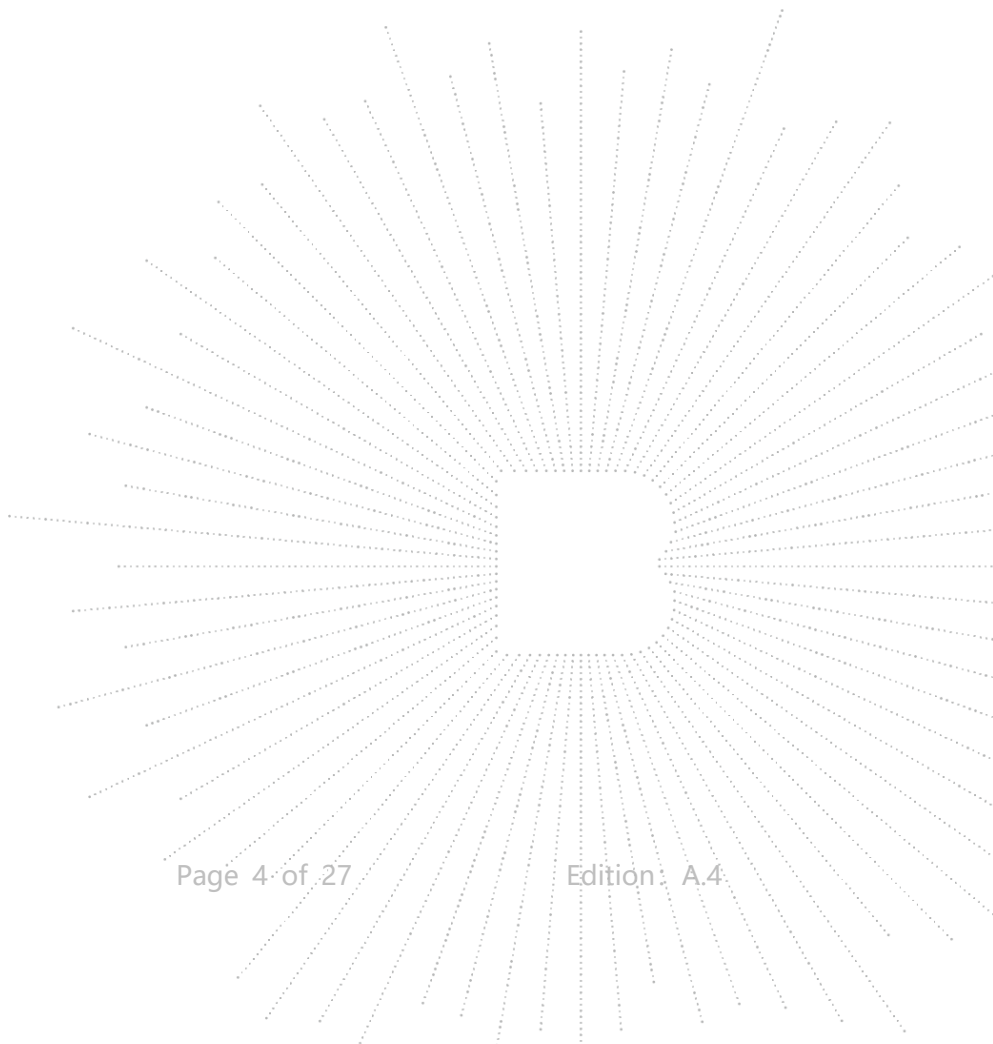

2. Test Summary

The Product has been tested according to the following specifications:

No.	Test Parameter	Clause No.	Results
1	Conducted Emission	15.207	PASS
2	Radiated Emission	15.209	PASS
3	20dB Bandwidth	15.215	PASS
4	Antenna Requirement	15.203	PASS

3. Measurement Uncertainty

Where relevant, the following measurement uncertainty levels have been estimated for tests performed on the Product as specified in CISPR 16-4-2. This uncertainty represents an expanded uncertainty expressed at approximately the 95% confidence level using a coverage factor of $k=2$.

No.	Item	Uncertainty
1	3m chamber Radiated spurious emission(30MHz-1GHz)	U=4.3dB
2	Conducted Emission (150kHz-30MHz)	U=3.2dB
3	humidity uncertainty	U=5.3%
4	Temperature uncertainty	U=0.59°C

4. Product Information And Test Setup

4.1 Product Information

Model/Type reference:	AW-ZD301B AW-ZD301
Model differences:	All the model are the same circuit and RF module, except model names.
Hardware Version:	N/A
Software Version:	N/A
Product Description:	FAST WIRELESS CHARGING
Operation Frequency:	Phone: 115 kHz-205kHz Watch: 300 kHz -350kHz Earphone: 115 kHz-205kHz
Antenna installation:	loop coil antenna
Ratings:	Input: 5V/2A, 9V/3A Phone Output: 10W/7.5W/5W Watch Output: 2.5W Earphone Output: 2.0W

4.2 Test Setup Configuration

See test photographs attached in *EUT TEST SETUP PHOTOGRAPHS* for the actual connections between Product and support equipment.

Conducted Emission/Radiated Spurious Emission:

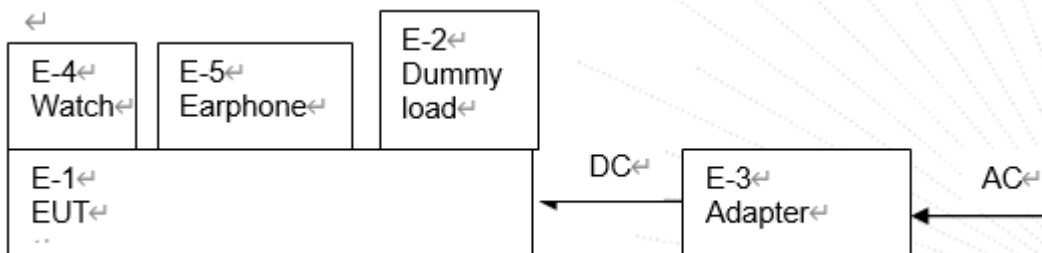

4.3 Support Equipment

No.	Device Type	Brand	Model	Series No.	Note
E-1	FAST WIRELESS CHARGING	N/A	AW-ZD301B	AW-ZD301	EUT
E-2	Dummy load	N/A	DL01	N/A	Auxiliary
E-3	Adapter	UGREEN	CD122	N/A	Auxiliary
E-4	watch	N/A	S7	N/A	Auxiliary
E-5	Earphone	N/A	AirPods pro	N/A	Auxiliary

Notes:

1. All the equipment/cables were placed in the worst-case configuration to maximize the emission during the test.
2. Grounding was established in accordance with the manufacturer's requirements and conditions for the intended use.

4.5 Test Mode

To investigate the maximum EMI emission characteristics generated from EUT, the test system was pre-scanning tested based on the consideration of following EUT operation mode or test configuration mode which possibly have effect on EMI emission level. Each of these EUT operation mode(s) or test configuration mode(s) mentioned above was evaluated respectively.

Test Mode 1	5W+2.5W+2W
Test Mode 2	7.5W+2.5W+2W
Test Mode 3	10W+2.5W+2W

5. Test Facility And Test Instrument Used

5.1 Test Facility

All measurement facilities used to collect the measurement data are located at Shenzhen BCTC Testing Co., Ltd. Address:1-2/F., Building B, Pengzhou Industrial Park, No.158, Fuyuan 1st Road, Tangwei, Fuhai Subdistrict, Bao'an District, Shenzhen, Guangdong, China. The site and apparatus are constructed in conformance with the requirements of ANSI C63.4 and CISPR 16-1-1 other equivalent standards.

FCC Test Firm Registration Number: 712850

IC Registered No.: 23583

5.2 Test Instrument Used

Conducted Emissions Test					
Equipment	Manufacturer	Model#	Serial#	Last Cal.	Next Cal.
Receiver	R&S	ESR3	102075	May 28, 2021	May 27, 2022
LISN	R&S	ENV216	101375	May 28, 2021	May 27, 2022
Software	Frad	EZ-EMC	EMC-CON 3A1	\	\
Attenuator	\	10dB DC-6GHz	1650	May 28, 2021	May 27, 2022

RF Conducted Test					
Equipment	Manufacturer	Model#	Serial#	Last Cal.	Next Cal.
Power Metter	Keysight	E4419	\	May 28, 2021	May 27, 2022
Power Sensor (AV)	Keysight	E9300A	\	May 28, 2021	May 27, 2022
Signal Analyzer 20kHz-26.5G Hz	Keysight	N9020A	MY49100060	May 28, 2021	May 27, 2022
Spectrum Analyzer 9kHz-40GHz	R&S	FSP 40	\	May 28, 2021	May 27, 2022

Radiated Emissions Test (966 Chamber)					
Equipment	Manufacturer	Model#	Serial#	Last Cal.	Next Cal.
966 chamber	ChengYu	966 Room	966	Jun. 06. 2020	Jun. 05, 2023
Receiver	R&S	ESR3	102075	May 28, 2021	May 27, 2022
Receiver	R&S	ESRP	101154	May 28, 2021	May 27, 2022
Amplifier	SKET	LAPA_01G18 G-45dB	\	May 28, 2021	May 27, 2022
Amplifier	Schwarzbeck	BBV9744	9744-0037	May 28, 2021	May 27, 2022
TRILOG Broadband Antenna	Schwarzbeck	VULB9163	942	Jun. 01, 2021	May 31, 2022
Horn Antenna	Schwarzbeck	BBHA9120D	1541	Jun. 02, 2021	Jun. 01, 2022
Horn Antenn (18GHz-40GHz)	Schwarzbeck	BBHA9170	00822	Jun. 15, 2021	Jun. 14, 2022
Amplifier (18GHz-40GHz)	MITEQ	TTA1840-35- HG	2034381	May 28, 2021	May 27, 2022
Loop Antenna (9kHz-30MHz)	Schwarzbeck	FMZB1519B	00014	Jun. 02, 2021	Jun. 01, 2022
RF cables1 (9kHz-30MHz)	Huber+Suhnar	9kHz-30MHz	B1702988-000 8	May 28, 2021	May 27, 2022
RF cables2 (30MHz-1GHz)	Huber+Suhnar	30MHz-1GHz	1486150	May 28, 2021	May 27, 2022
RF cables3 (1GHz-40GHz)	Huber+Suhnar	1GHz-40GHz	1607106	May 28, 2021	May 27, 2022
Power Metter	Keysight	E4419	\	May 28, 2021	May 27, 2022
Power Sensor (AV)	Keysight	E9300A	\	May 28, 2021	May 27, 2022
Signal Analyzer 20kHz-26.5G Hz	Keysight	N9020A	MY49100060	May 28, 2021	May 27, 2022
Spectrum Analyzer 9kHz-40GHz	R&S	FSP 40	\	May 28, 2021	May 27, 2022
Software	Frad	EZ-EMC	FA-03A2 RE	\	\

6. Conducted Emissions

6.1 Block Diagram Of Test Setup

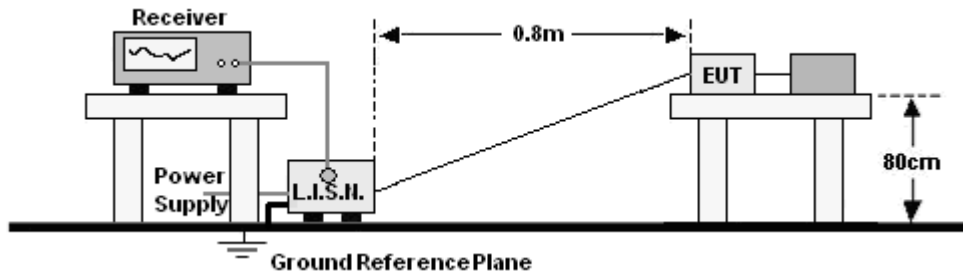

6.2 Limit

Frequency (MHz)	Limit (dBuV)	
	Quas-peak	Average
0.15 -0.5	66 - 56 *	56 - 46 *
0.50 -5.0	56.00	46.00
5.0 -30.0	60.00	50.00

Notes:
 1. *Decreasing linearly with logarithm of frequency.
 2. The lower limit shall apply at the transition frequencies.

6.3 Test procedure

Receiver Parameters	Setting
Attenuation	10 dB
Start Frequency	0.15 MHz
Stop Frequency	30 MHz
IF Bandwidth	9 kHz

- The Product was placed on a nonconductive table 0.8 m above the horizontal ground reference plane, and 0.4 m from the vertical ground reference plane, and connected to the main through Line Impedance Stability Network (L.I.S.N).
- The RBW of the receiver was set at 9 kHz in 150 kHz ~ 30MHz with Peak and AVG detector in Max Hold mode. Run the receiver's pre-scan to record the maximum disturbance generated from Product in all power lines in the full band.
- For each frequency whose maximum record was higher or close to limit, measure its QP and AVG values and record.

6.4 EUT operating Conditions

The EUT was configured for testing in a typical fashion (as a customer would normally use it). The EUT has been programmed to continuously transmit during test. This operating condition was tested and used to collect the included data.

6.5 Test Result

Temperature:	26 °C	Relative Humidity:	54%
Pressure:	101KPa	Phase :	L
Test Mode:	Mode 3	Test Voltage:	AC 120V/60Hz

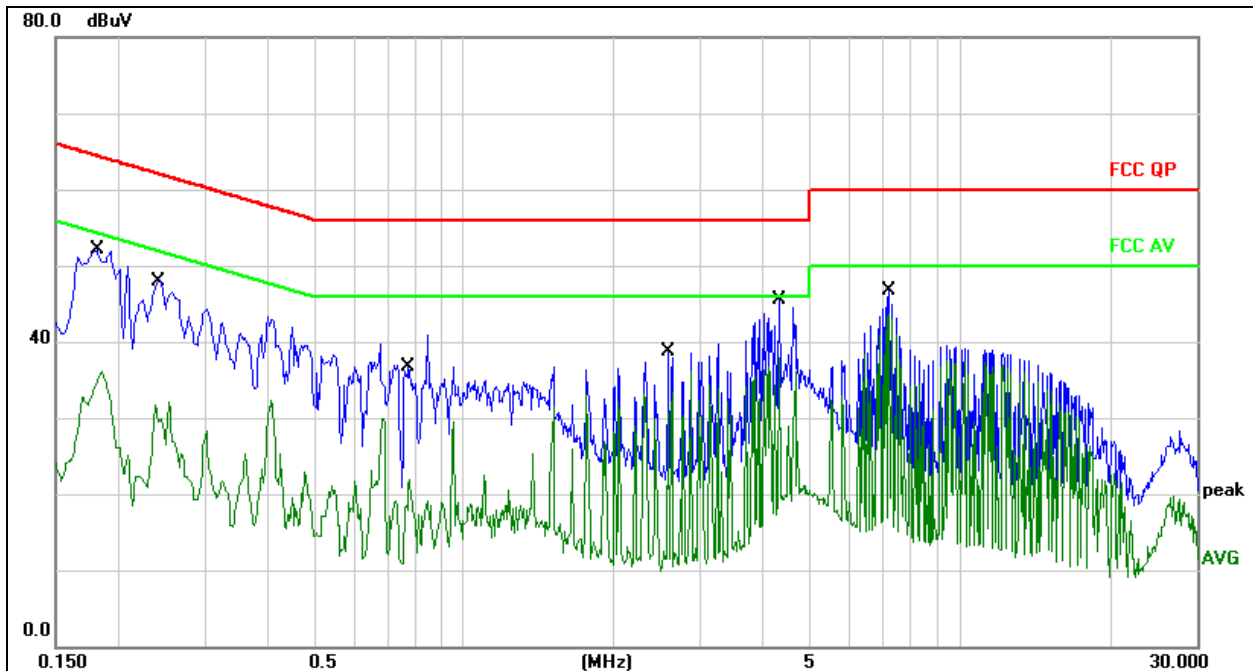

Remark:

1. All readings are Quasi-Peak and Average values.
2. Factor = Insertion Loss + Cable Loss.
3. Measurement = Reading Level + Correct Factor
4. Over = Measurement - Limit

No.	Mk.	Freq.	Reading Level	Correct Factor	Measurement	Limit	Over	Detector
		MHz	dBuV	dB	dBuV	dBuV	dB	
1		0.1819	42.02	9.99	52.01	64.39	-12.38	QP
2		0.1819	26.21	9.99	36.20	54.39	-18.19	AVG
3		0.2419	37.79	10.02	47.81	62.03	-14.22	QP
4		0.2419	22.07	10.02	32.09	52.03	-19.94	AVG
5		0.7780	30.70	10.14	40.84	56.00	-15.16	QP
6		0.7780	11.71	10.14	21.85	46.00	-24.15	AVG
7		2.5819	28.33	10.34	38.67	56.00	-17.33	QP
8		2.5819	23.05	10.34	33.39	46.00	-12.61	AVG
9		4.3299	34.90	10.64	45.54	56.00	-10.46	QP
10		4.3299	27.25	10.64	37.89	46.00	-8.11	AVG
11		7.1978	35.88	10.84	46.72	60.00	-13.28	QP
12	*	7.1978	32.92	10.84	43.76	50.00	-6.24	AVG

Temperature:	26 °C	Relative Humidity:	54%
Pressure:	101KPa	Phase :	N
Test Mode:	Mode 3	Test Voltage:	AC 120V/60Hz

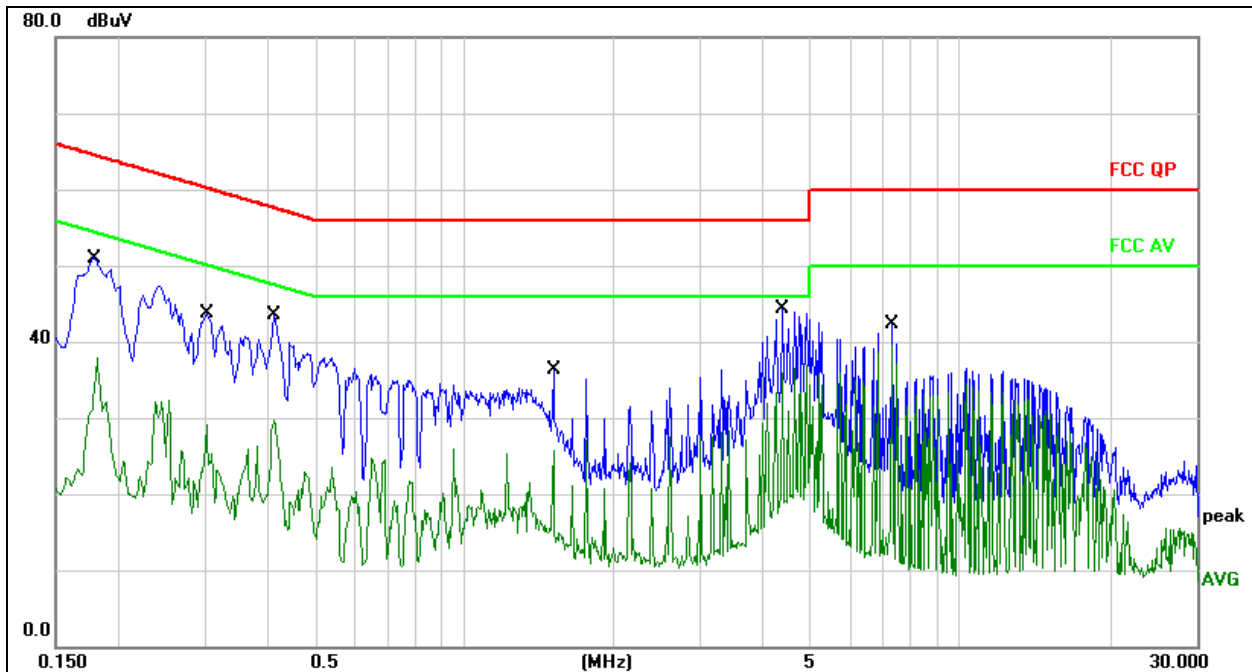
Remark:

1. All readings are Quasi-Peak and Average values.
2. Factor = Insertion Loss + Cable Loss.
3. Measurement = Reading Level + Correct Factor
4. Over = Measurement - Limit

No.	Mk.	Freq. MHz	Reading Level dBuV	Correct Factor dB	Measure- ment dBuV	Limit dBuV	Over dB	Detector
1		0.1819	40.33	9.99	50.32	64.39	-14.07	QP
2		0.1819	27.88	9.99	37.87	54.39	-16.52	AVG
3		0.3020	33.62	10.04	43.66	60.19	-16.53	QP
4		0.3020	19.06	10.04	29.10	50.19	-21.09	AVG
5		0.4140	33.33	10.08	43.41	57.57	-14.16	QP
6		0.4140	19.57	10.08	29.65	47.57	-17.92	AVG
7		1.5140	26.03	10.17	36.20	56.00	-19.80	QP
8		1.5140	15.45	10.17	25.62	46.00	-20.38	AVG
9		4.3859	33.58	10.65	44.23	56.00	-11.77	QP
10	*	4.3859	25.26	10.65	35.91	46.00	-10.09	AVG
11		7.2900	31.45	10.84	42.29	60.00	-17.71	QP
12		7.2900	28.62	10.84	39.46	50.00	-10.54	AVG

7. Radiated Emissions

7.1 Block Diagram Of Test Setup

(A) Radiated Emission Test-Up Frequency Below 30MHz

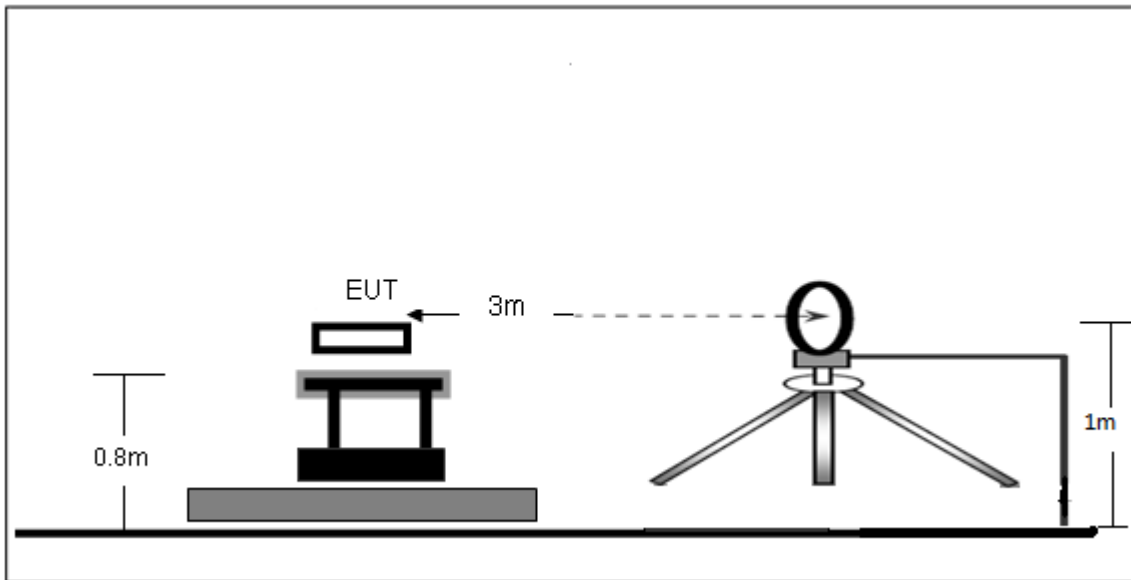

(B) Radiated Emission Test-Up Frequency 30MHz~1GHz

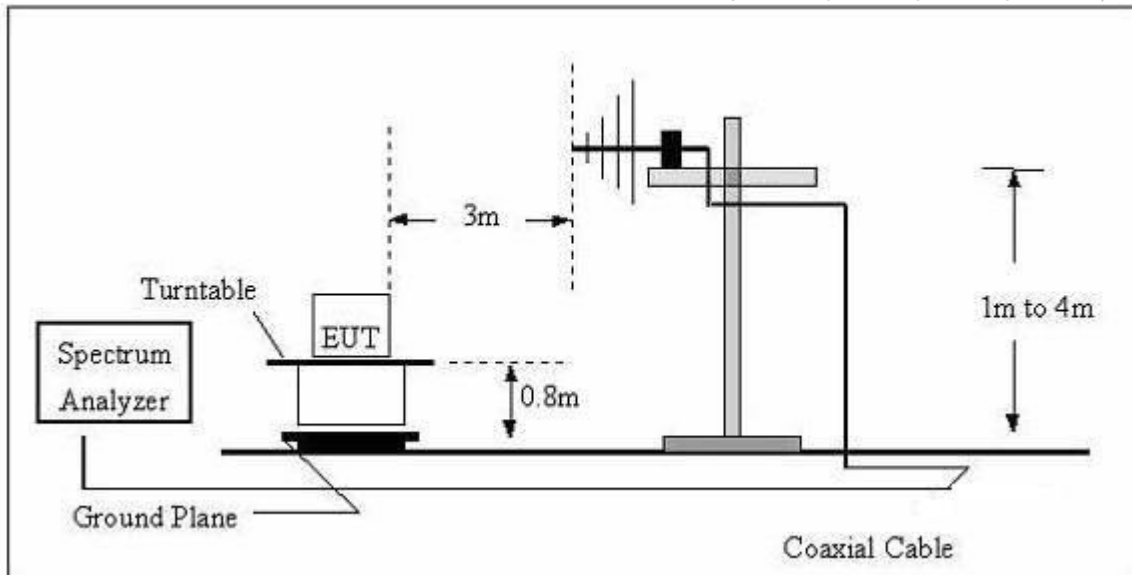

7.2 Limit

FCC §15.209; §15.205.

Test Standard	FCC Part15 C Section 15.209 and 15.205				
Test Limit	Frequency (MHz)	Field strength (microvolt/meter)	Limit (dBuV/m)	Remark	Measurement distance (m)
	0.009MHz~0.490MHz	2400/F(kHz)	-	-	300
	0.490MHz~1.705MHz	24000/F(kHz)	-	-	30
	1.705MHz~30MHz	30	-	-	30
	30MHz~88MHz	100	40.0	Quasi-peak	3
	88MHz~216MHz	150	43.5	Quasi-peak	3
	216MHz~960MHz	200	46.0	Quasi-peak	3
	960MHz~1000MHz	500	54.0	Quasi-peak	3
	Above 1000MHz	500	54.0	Average	3
-		74.0	Peak	3	

7.3 Test procedure

Receiver Parameter	Setting
Attenuation	Auto
9kHz~150kHz	RBW 200Hz for QP
150kHz~30MHz	RBW 9kHz for QP
30MHz~1000MHz	RBW 120kHz for QP

Below 1GHz test procedure as below:

- a. The EUT was placed on the top of a rotating table 0.8 meters above the ground at a 3 meter semi-anechoic chamber. The table was rotated 360 degrees to determine the position of the highest radiation.
- b. The EUT was set 3 meters away from the interference-receiving antenna, which was mounted on the top of a variable-height antenna tower.
- c. The antenna height is varied from one meter to four meters above the ground to determine the maximum value of the field strength. Both horizontal and vertical polarizations of the antenna are set to make the measurement.
- d. For each suspected emission, the EUT was arranged to its worst case and then the antenna was tuned to heights from 1 meter to 4 meters (for the test frequency of below 30MHz, the antenna was tuned to heights 1 meter) and the rotatable table was turned from 0 degrees to 360 degrees to find the maximum reading.
- e. The test-receiver system was set to Peak Detect Function and Specified Bandwidth with Maximum Hold Mode.

f. If the emission level of the EUT in peak mode was 10dB lower than the limit specified, then testing could be stopped and the peak values of the EUT would be reported. Otherwise the emissions that did not have 10dB margin would be re-tested one by one using peak, quasi-peak or average method as specified and then reported in a data sheet.

Above 1GHz test procedure as below:

g. Different between above is the test site, change from Semi- Anechoic Chamber to fully Anechoic Chamber and change form table 0.8 metre to 1.5 metre(Above 18GHz the distance is 1 meter and table is 1.5 metre).

h. Test the EUT in the lowest channel ,the middle channel ,the Highest channel.

Note:

Both horizontal and vertical antenna polarities were tested and performed pretest to three orthogonal axis. The worst case emissions were reported.

7.4 Test Result

9kHz-30MHz

Temperature:	26 °C	Relative Humidity:	54%
Pressure:	101KPa	Test Voltage:	AC 120V/60Hz
Test Mode:	Mode 3	Polarization :	---

Frequency (kHz)	Meter Reading (dB μ V)	Factor (dB)	Emission Level (dB μ V/m)	Limits (dB μ V/m)	Margin (dB)	Detector Type
22.51	64.22	20.15	84.37	140.56	-56.19	PK
22.51	40.48	20.15	60.63	120.56	-59.93	AV
60.63	52.40	20.33	72.73	131.95	-59.22	PK
60.63	38.01	20.33	58.34	111.95	-53.61	AV
152.66	68.63	20.55	89.18	123.93	-34.75	PK
152.66	54.98	20.55	75.53	103.93	-28.40	AV
517.33	25.14	20.64	45.78	73.33	-27.55	QP
751.07	29.03	21.26	50.29	70.09	-19.80	QP
1202.31	18.34	22.32	40.66	66.00	-25.34	QP

Note:

Pre-scan in the all of mode, the worst case in of was recorded.

Factor = antenna factor + cable loss – pre-amplifier.

Margin = Emission Level- Limit.

Temperature:	26 °C	Relative Humidity:	54%
Pressure:	101KPa	Phase :	Horizontal
Test Mode:	Mode 3	Test Voltage:	AC 120V/60Hz

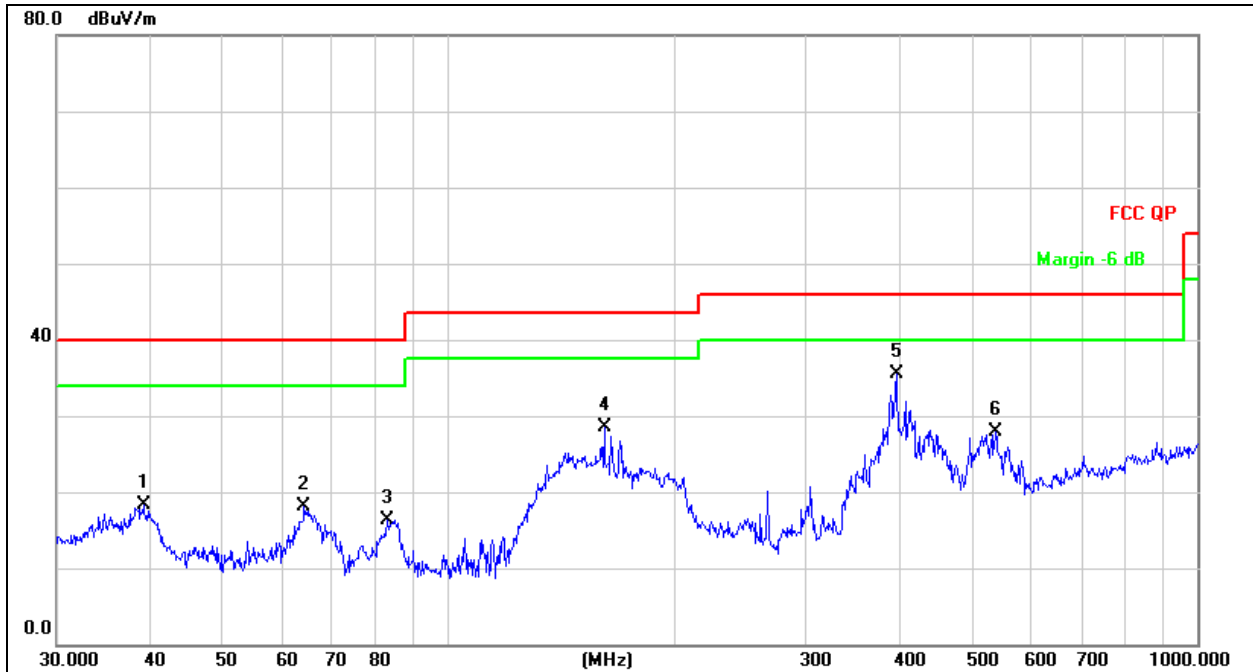
Remark:

1. Factor = Antenna Factor + Cable Loss – Pre-amplifier.
2. Measurement = Reading Level + Correct Factor
3. Over = Measurement - Limit

No.	Mk.	Freq. MHz	Reading Level dBuV	Correct Factor dB/m	Measure- ment dBuV/m	Limit dBuV/m	Over dB	Detector
1		39.1616	28.62	-10.38	18.24	40.00	-21.76	QP
2		64.2074	30.35	-12.21	18.14	40.00	-21.86	QP
3		82.9385	30.39	-14.07	16.32	40.00	-23.68	QP
4		161.4742	38.77	-10.21	28.56	43.50	-14.94	QP
5	*	396.2415	39.93	-4.44	35.49	46.00	-10.51	QP
6		537.5891	29.10	-1.25	27.85	46.00	-18.15	QP

Temperature:	26 °C	Relative Humidity:	54%
Pressure:	101KPa	Phase :	Vertical
Test Mode:	Mode 3	Test Voltage:	AC 120V/60Hz

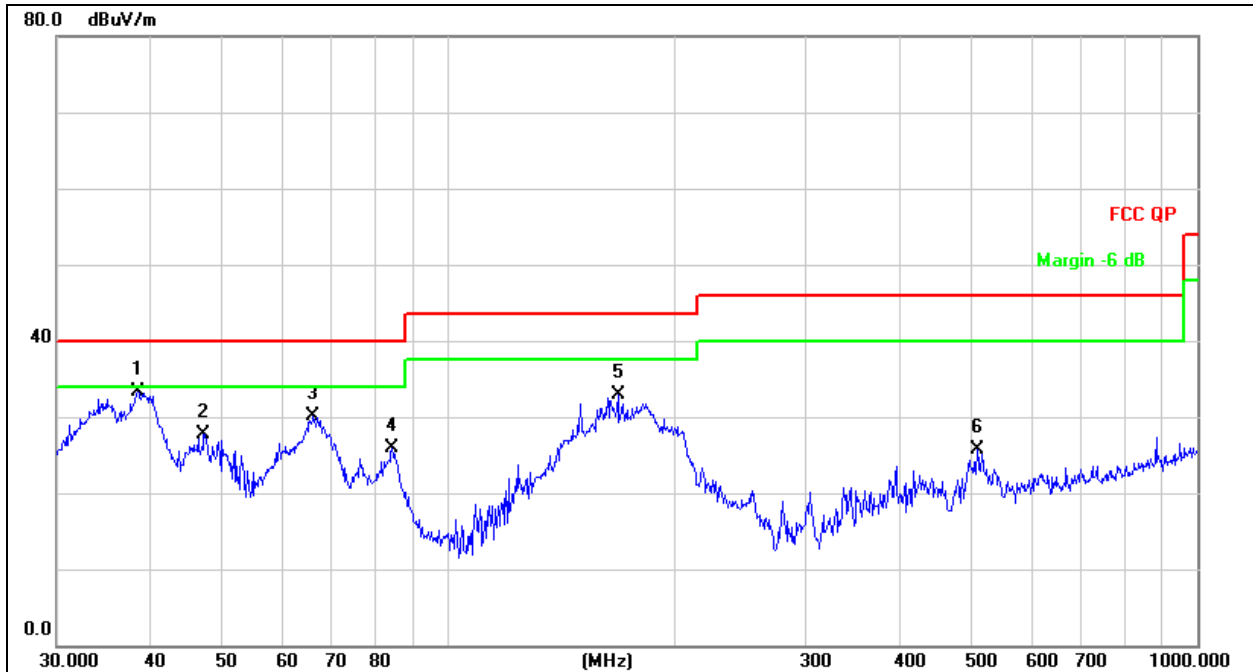
Remark:

1. Factor = Antenna Factor + Cable Loss – Pre-amplifier.
2. Measurement = Reading Level + Correct Factor
3. Over = Measurement - Limit

No.	Mk.	Freq. MHz	Reading Level dBuV	Correct Factor dB/m	Measure- ment dBuV/m	Limit dBuV/m	Over dB	Detector
1	*	38.4809	43.57	-10.26	33.31	40.00	-6.69	QP
2		47.1599	39.19	-11.49	27.70	40.00	-12.30	QP
3		66.0342	42.45	-12.41	30.04	40.00	-9.96	QP
4		84.1100	39.86	-14.04	25.82	40.00	-14.18	QP
5		168.4138	43.39	-10.53	32.86	43.50	-10.64	QP
6		508.2582	27.55	-1.85	25.70	46.00	-20.30	QP

8. Bandwidth Test

8.1 Test Procedure

1. Set RBW = 1%~5% OBW.
2. Set the video bandwidth (VBW) $\geq 3 \times$ RBW.
3. Detector = Peak.
4. Trace mode = max hold.
5. Sweep = auto couple.
6. Allow the trace to stabilize.
7. Measure the maximum width of the emission that is constrained by the frequencies associated with the two outermost amplitude points (upper and lower frequencies) that are attenuated by 20 dB relative to the maximum level measured in the fundamental emission.

8.2 Test Setup

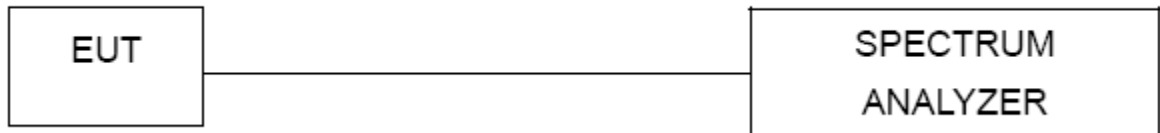

8.3 Test Result

Frequency (KHz)	20dB bandwidth (KHz)	99% bandwidth (KHz)	Result	Note
115.8	0.303	0.301	Pass	Earphone
326.3	0.163	0.255	Pass	Watch
128.1	0.327	0.387	Pass	Phone

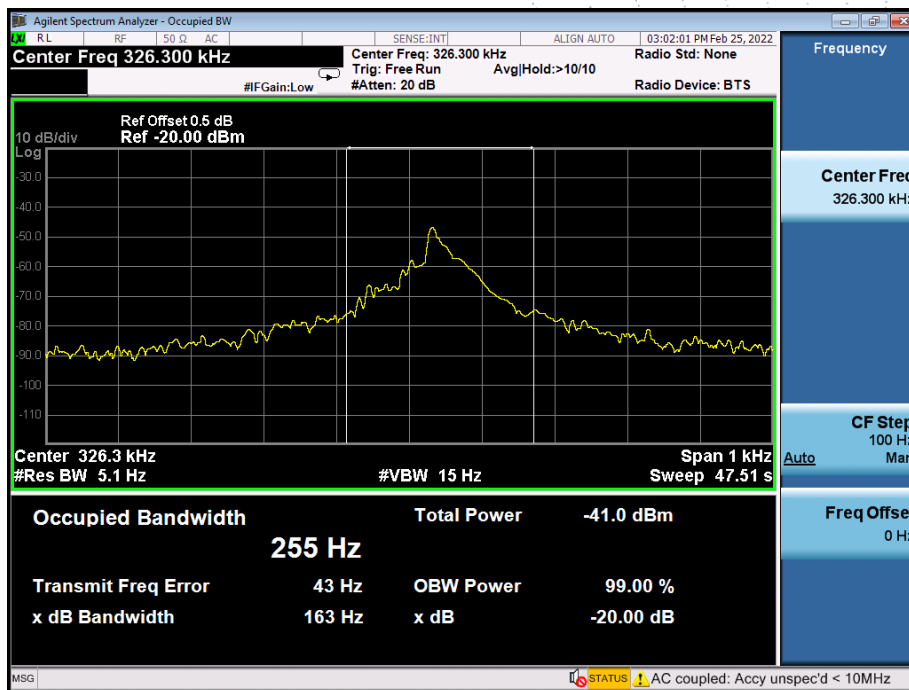
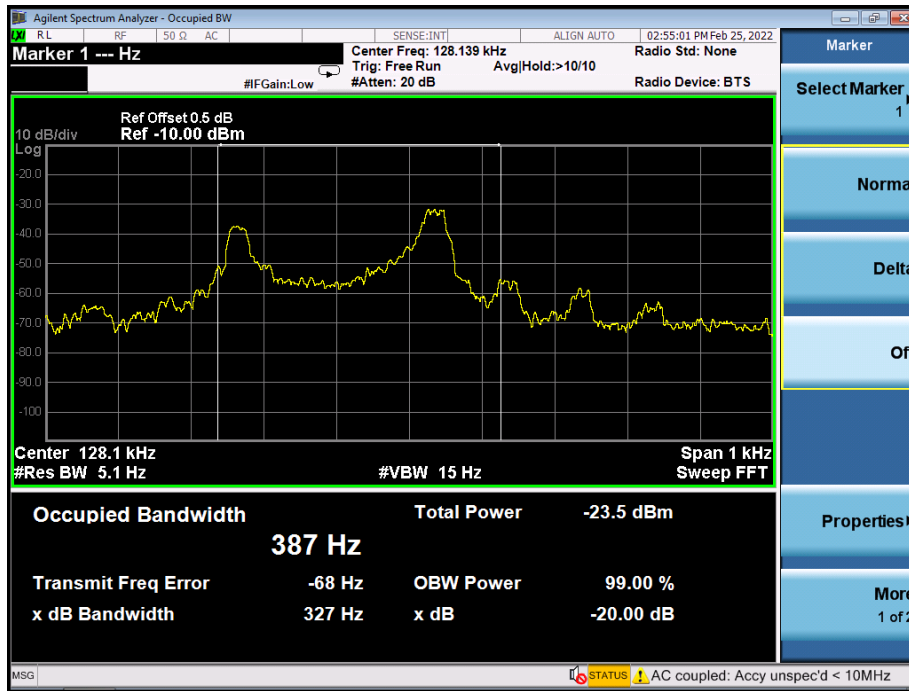

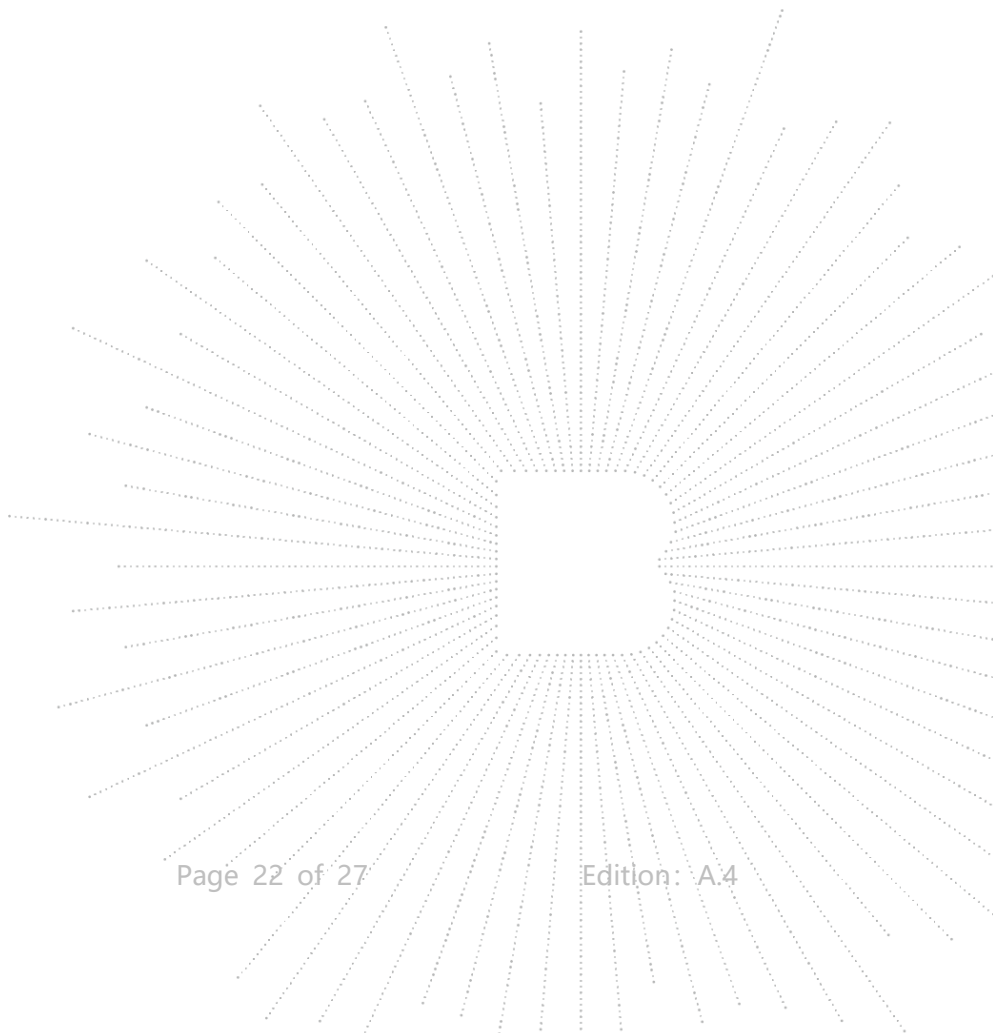
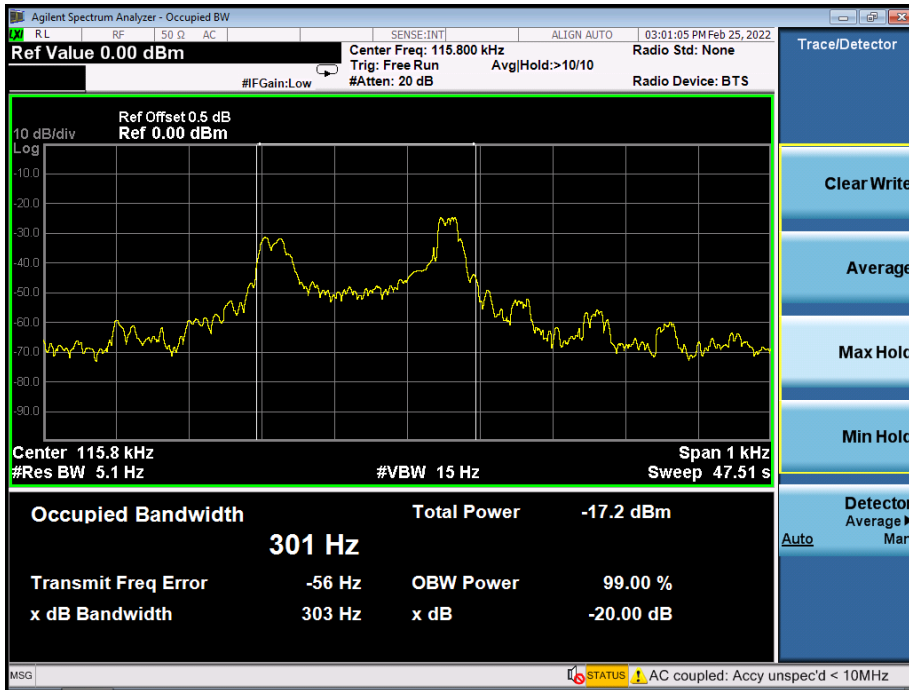

9. Antenna Requirements

9.1 Limit

For intentional device, according to FCC 47 CFR Section 15.203, An intentional radiator shall be designed to ensure that no antenna other than that furnished by the responsible party shall be used with the device. The use of a permanently attached antenna or of an antenna that uses a unique coupling to the intentional radiator shall be considered sufficient to comply with the provisions of this section. The manufacturer may design the unit so that a broken antenna can be replaced by the user, but the use of a standard antenna jack or electrical connector is prohibited.

9.2 Test Result

The EUT antenna is loop coil antenna, fulfill the requirement of this section.

10. EUT Photographs

EUT Photo 1



NOTE: Appendix-Photographs Of EUT Constructional Details



11. EUT Test Setup Photographs

Conducted emissions



Radiated Measurement Photos

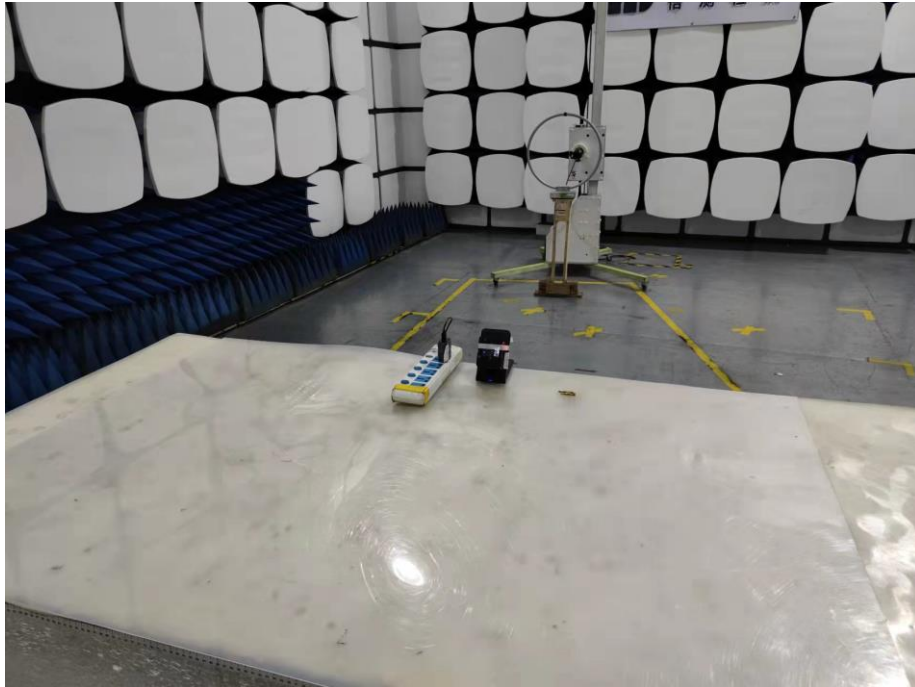

STATEMENT

- 1.The equipment lists are traceable to the national reference standards.
- 2.The test report can not be partially copied unless prior written approval is issued from our lab.
- 3.The test report is invalid without stamp of laboratory.
- 4.The test report is invalid without signature of person(s) testing and authorizing.
- 5.The test process and test result is only related to the Unit Under Test.
- 6.The quality system of our laboratory is in accordance with ISO/IEC17025.
- 7.If there is any objection to report, the client should inform issuing laboratory within 15 days from the date of receiving test report.

Address:

1-2/F., Building B, Pengzhou Industrial Park, No.158, Fuyuan 1st Road, Tangwei, Fuhai Subdistrict, Bao'an District, Shenzhen, Guangdong, China

TEL: 400-788-9558

P.C.: 518103

FAX: 0755-33229357

Website: <http://www.chnbctc.com>

E-Mail: bctc@bctc-lab.com.cn

***** END *****