

FCC TEST REPORT

FCC ID:2AZ6U-D90SE

Report Number. : ZKT-2105252041E

Date of Test May. 20, 2021 to May. 31, 2021

Date of issue : May. 31, 2021

Total number of pages 62

Test Result : PASS

Testing Laboratory : Shenzhen ZKT Technology Co., Ltd.

Address : 1/F, No. 101, Building B, No. 6, Tangwei Community Industrial Avenue, Fuhai Street, Bao'an District, Shenzhen, China

Applicant's name : Guangzhou TOPPING Electronics&Technology Co., Ltd

Address : 26th, Jiaomen Road, Huangge, Nansha, Guangzhou, China.

Manufacturer's name : Guangzhou TOPPING Electronics&Technology Co., Ltd

Address : 26th, Jiaomen Road, Huangge, Nansha, Guangzhou, China.

Test specification:

Standard : FCC CFR Title 47 Part 15 Subpart C Section 15.247
ANSI C63.10:2013

Test procedure : /

Non-standard test method : N/A

Test Report Form No. : TRF-EL-112_V0

Test Report Form(s) Originator : ZKT Testing

Master TRF : Dated: 2020-01-06

This device described above has been tested by ZKT, and the test results show that the equipment under test (EUT) is in compliance with the FCC requirements. And it is applicable only to the tested sample identified in the report.

This report shall not be reproduced except in full, without the written approval of ZKT, this document may be altered or revised by ZKT, personal only, and shall be noted in the revision of the document.

Product name : Audio DAC

Trademark : TOPPING

Model/Type reference : D90SE
D90Pro, D90Pro2

Ratings : Input: AC100-240V 50/60Hz 1A

Testing procedure and testing location:

Testing Laboratory: Shenzhen ZKT Technology Co., Ltd.

Address.....: 1/F, No. 101, Building B, No. 6, Tangwei Community
Industrial Avenue, Fuhai Street, Bao'an District,
Shenzhen, China

Tested by (name + signature).....: Alen He

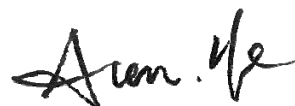

Reviewer (name + signature).....: Joe Liu

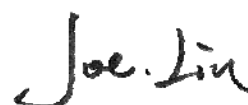

Approved (name + signature): Lake Xie



Table of Contents

	Page
1. VERSION	5
2. TEST SUMMARY	6
2.1 TEST FACILITY	7
2.2 MEASUREMENT UNCERTAINTY	7
3. GENERAL INFORMATION	8
3.1 GENERAL DESCRIPTION OF EUT	8
3.2 Test Setup Configuration	9
3.3 Support Equipment	9
3.4 Test Mode	10
3.5 EQUIPMENTS LIST FOR ALL TEST ITEMS	11
4. EMC EMISSION TEST	12
4.1 Conducted emissions	12
4.1.1 POWER LINE CONDUCTED EMISSION Limits	12
4.1.2 TEST PROCEDURE	12
4.1.3 DEVIATION FROM TEST STANDARD	12
4.1.4 TEST SETUP	13
4.1.5 EUT OPERATING CONDITIONS	13
4.1.6 Test Result	14
4.2 Radiated emissions	16
4.2.1 Radiated Emission Limits	16
4.2.2 TEST PROCEDURE	16
4.2.3 DEVIATION FROM TEST STANDARD	17
4.2.4 TEST SETUP	17
4.2.5 EUT OPERATING CONDITIONS	18
4.2.6 TEST RESULTS	19
5. RADIATED BAND EMISSION MEASUREMENT	26
5.1 Test Requirement:	26
5.2 TEST PROCEDURE	26
5.3 DEVIATION FROM TEST STANDARD	27
5.4 TEST SETUP	27
5.5 EUT OPERATING CONDITIONS	27
5.6 TEST RESULT	28
6. CONDUCTED BAND EDGE AND SPURIOUS EMISSION	29
6.1 Limit	29
6.2 Test Setup	29
6.3 Test procedure	29
6.4 DEVIATION FROM STANDARD	29
6.5 Test Result	30
7. 20DB BANDWIDTH	38
7.1 Test Setup	38
7.2 Limit	38
7.3 Test procedure	38
7.4 DEVIATION FROM STANDARD	38

7.5 Test Result	38
8. MAXIMUM PEAK OUTPUT POWER	43
8.1 Block Diagram Of Test Setup	43
8.2 Limit	43
8.3 Test procedure	43
8.4 DEVIATION FROM STANDARD	43
8.5 Test Result	43
9. HOPPING CHANNEL SEPARATION	48
9.1 Test Setup	48
9.2 Test procedure	48
9.3 DEVIATION FROM STANDARD	48
9.4 Test Result	48
10. NUMBER OF HOPPING FREQUENCY	53
10.1 Test Setup	53
10.2 Test procedure	53
10.3 DEVIATION FROM STANDARD	53
10.4 Test Result	54
11. DWELL TIME	56
11.1 Test Setup	56
11.2 Test procedure	56
11.3 DEVIATION FROM STANDARD	56
11.4 Test Result	57
12. ANTENNA REQUIREMENT	61
13. TEST SETUP PHOTO	62
14. EUT CONSTRUCTIONAL DETAILS	62

1. VERSION

Report No.	Version	Description	Approved
ZKT-2105252041E	Rev.01	Initial issue of report	May. 31, 2021

2. TEST SUMMARY

Test procedures according to the technical standards:

FCC Part15 (15.247) , Subpart C			
Standard Section	Test Item	Result	Remark
15.203/15.247 (c)	Antenna Requirement	PASS	
15.207	AC Power Line Conducted Emission	PASS	
15.247 (b)(1)	Conducted Peak Output Power	PASS	
15.247 (a)(1)	20dB Occupied Bandwidth	PASS	
15.247 (a)(1)	Carrier Frequencies Separation	PASS	
15.247 (a)(1)(iii)	Hopping Channel Number	PASS	
15.247 (a)(1)(iii)	Dwell Time	PASS	
15.205/15.209	Radiated Emission	PASS	
15.247(d)	Band Edge	PASS	

NOTE:

(1)" N/A" denotes test is not applicable in this Test Report

2.1 TEST FACILITY

Shenzhen ZKT Technology Co., Ltd.
Add. : 1/F, No. 101, Building B, No. 6, Tangwei Community Industrial Avenue, Fuhai Street,
Bao'an District, Shenzhen, China

FCC Test Firm Registration Number: 692225
Designation Number: CN1299
IC Registered No.: 27033

2.2 MEASUREMENT UNCERTAINTY

The reported uncertainty of measurement $y \pm U$, where expanded uncertainty U is based on a standard uncertainty multiplied by a coverage factor of $k=2$, providing a level of confidence of approximately 95%.

No.	Item	Uncertainty
1	Conducted Emission Test	$\pm 1.38\text{dB}$
2	RF power conducted	$\pm 0.16\text{dB}$
3	Spurious emissions conducted	$\pm 0.21\text{dB}$
4	All emissions radiated(<1G)	$\pm 4.68\text{dB}$
5	All emissions radiated(>1G)	$\pm 4.89\text{dB}$
6	Temperature	$\pm 0.5^\circ\text{C}$
7	Humidity	$\pm 2\%$

3. GENERAL INFORMATION

3.1 GENERAL DESCRIPTION OF EUT

Product Name:	Audio DAC
Model No.:	D90SE D90Pro, D90Pro2
Model Different.:	Only for different model name.
Serial No.:	N/A
Hardware Version:	H1.0
Software Version:	S1.0
Sample(s) Status:	Engineer sample
Channel numbers:	79
Channel separation:	2402MHz~2480MHz
Modulation technology:	GFSK, $\pi/4$ -DQPSK
Antenna Type:	External antenna
Antenna gain:	0dBi
Power supply:	Input: AC100-240V 50/60Hz 1A
SWITCHING POWER ADAPTER:	N/A

Operation Frequency each of channel							
Channel	Frequency	Channel	Frequency	Channel	Frequency	Channel	Frequency
1	2402MHz	21	2422MHz	41	2442MHz	61	2462MHz
2	2403MHz	22	2423MHz	42	2443MHz	62	2463MHz
3	2404MHz	23	2424MHz	43	2444MHz	63	2464MHz
4	2405MHz	24	2425MHz	44	2445MHz	64	2465MHz
5	2406MHz	25	2426MHz	45	2446MHz	65	2466MHz
6	2407MHz	26	2427MHz	46	2447MHz	66	2467MHz
7	2408MHz	27	2428MHz	47	2448MHz	67	2468MHz
8	2409MHz	28	2429MHz	48	2449MHz	68	2469MHz
9	2410MHz	29	2430MHz	49	2450MHz	69	2470MHz
10	2411MHz	30	2431MHz	50	2451MHz	70	2471MHz
11	2412MHz	31	2432MHz	51	2452MHz	71	2472MHz
12	2413MHz	32	2433MHz	52	2453MHz	72	2473MHz
13	2414MHz	33	2434MHz	53	2454MHz	73	2474MHz
14	2415MHz	34	2435MHz	54	2455MHz	74	2475MHz
15	2416MHz	35	2436MHz	55	2456MHz	75	2476MHz
16	2417MHz	36	2437MHz	56	2457MHz	76	2477MHz
17	2418MHz	37	2438MHz	57	2458MHz	77	2478MHz

18	2419MHz	38	2439MHz	58	2459MHz	78	2479MHz
19	2420MHz	39	2440MHz	59	2460MHz	79	2480MHz
20	2421MHz	40	2441MHz	60	2461MHz		

Note:

In section 15.31(m), regards to the operating frequency range over 10 MHz, the Lowest frequency, the middle frequency, and the highest frequency of channel were selected to perform the test, and the selected channel see below:

Test channel	Frequency
The lowest channel	2402MHz
The middle channel	2441MHz
The Highest channel	2480MHz

3.2 Test Setup Configuration

Conducted Emission

AC Line

EUT

Radiated Emission

EUT

Conducted Spurious

EUT

3.3 Support Equipment

The EUT has been tested as an independent unit together with other necessary accessories or support units. The following support units or accessories were used to form a representative test configuration during the tests.

Item	Equipment	Mfr/Brand	Model/Type No.	Series No.	Note
E-1	Audio DAC	N/A	D90SE	N/A	EUT

Item	Shielded Type	Ferrite Core	Length	Note

Note:

- (1) The support equipment was authorized by Declaration of Confirmation.
- (2) For detachable type I/O cable should be specified the length in cm in 『Length』 column.

3.4 Test Mode

Transmitting mode	Keep the EUT in continuously transmitting mode.
Remark: During the test, the test voltage was tuned from 85% to 115% of the nominal rated supply voltage, and found that the worst case was under the nominal rated supply condition. So the report just shows that condition's data.	

Test Software	BT Test Tool
Power level setup	<7dBm

3.5 EQUIPMENTS LIST FOR ALL TEST ITEMS
Radiation Test equipment

Item	Equipment	Manufacturer	Type No.	Serial No.	Last calibration	Calibrated until
1	Spectrum Analyzer (9kHz-26.5GHz)	KEYSIGHT	9020A	MY45109572	Sep. 22, 2020	Sep. 21, 2021
2	Spectrum Analyzer (1GHz-40GHz)	Agilent	E4446A	100363	Sep. 22, 2020	Sep. 21, 2021
3	Test Receiver (9kHz-7GHz)	R&S	ESCI7	101169	Sep. 22, 2020	Sep. 21, 2021
4	Bilog Antenna (30MHz-1400MHz)	Schwarzbeck	VULB9168	00877	Sep. 22, 2020	Sep. 21, 2021
5	Horn Antenna (1GHz-18GHz)	SCHWARZBEC K	BBHA9120D	1541	Sep. 22, 2020	Sep. 21, 2021
6	Horn Antenna (18GHz-40GHz)	A.H. System	SAS-574	588	Sep. 22, 2020	Sep. 21, 2021
7	Amplifier (30-1000MHz)	EM Electronics	EM330 Amplifier	N/A	Sep. 22, 2020	Sep. 21, 2021
8	Amplifier (1GHz-40GHz)	全聚达	DLE-161	097	Sep. 22, 2020	Sep. 21, 2021
9	Loop Antenna (9KHz-30MHz)	SCHWARZBEC K	FMZB1519B	014	Sep. 22, 2020	Sep. 21, 2021
10	RF cables1 (9kHz-30MHz)	N/A	9kHz-30MHz	N/A	Sep. 22, 2020	Sep. 21, 2021
11	RF cables2 (30MHz-1GHz)	N/A	30MHz-1GHz	N/A	Sep. 22, 2020	Sep. 21, 2021
12	RF cables3 (1GHz-40GHz)	N/A	1GHz-40GHz	N/A	Sep. 22, 2020	Sep. 21, 2021
13	CMW500 Test	R&S	CMW500	106504	Sep. 22, 2020	Sep. 21, 2021
14	ESG Signal Generator	Agilent	E4421B	GB40051203	Sep. 22, 2020	Sep. 21, 2021
15	Signal Generator	Agilent	N5182A	MY47420215	Sep. 22, 2020	Sep. 21, 2021
16	D.C. Power Supply	LongWei	TPR-6405D	\	\	\
17	Software	Frad	EZ-EMC	FA-03A2 RE	\	\

Conduction Test equipment

Item	Kind of Equipment	Manufacturer	Type No.	Serial No.	Last calibration	Calibrated until
1	LISN	R&S	ENV216	101471	Sep. 22, 2020	Sep. 21, 2021
2	LISN	CYBERTEK	EM5040A	E185040014 9	Sep. 22, 2020	Sep. 21, 2021
3	Test Cable	N/A	C01	N/A	Sep. 22, 2020	Sep. 21, 2021
4	Test Cable	N/A	C02	N/A	Sep. 22, 2020	Sep. 21, 2021
5	EMI Test Receiver	R&S	ESRP3	101946	Sep. 22, 2020	Sep. 21, 2021
6	Absorbing Clamp	DZ	ZN23201	N/A	Sep. 22, 2020	Sep. 21, 2021

4. EMC EMISSION TEST

4.1 Conducted emissions

Test Requirement:	FCC Part15 C Section 15.207
Test Method:	ANSI C63.10:2013
Test Frequency Range:	150KHz to 30MHz
Receiver setup:	RBW=9KHz, VBW=30KHz, Sweep time=auto

4.1.1 POWER LINE CONDUCTED EMISSION Limits

FREQUENCY (MHz)	Limit (dBuV)		Standard
	Quasi-peak	Average	
0.15 -0.5	66 - 56 *	56 - 46 *	FCC
0.50 -5.0	56.00	46.00	FCC
5.0 -30.0	60.00	50.00	FCC

Note:

(1) *Decreases with the logarithm of the frequency.

4.1.2 TEST PROCEDURE

- The EUT was placed 0.1 meters from the horizontal ground plane with EUT being connected to the power mains through a line impedance stabilization network (LISN). All other support equipments powered from additional LISN(s). The LISN provide 50 Ohm/ 50uH of coupling impedance for the measuring instrument.
- Interconnecting cables that hang closer than 40 cm to the ground plane shall be folded back and forth in the center forming a bundle 30 to 40 cm long.
- I/O cables that are not connected to a peripheral shall be bundled in the center. The end of the cable may be terminated, if required, using the correct terminating impedance. The overall length shall not exceed 1 m.
- LISN at least 80 cm from nearest part of EUT chassis.
- For the actual test configuration, please refer to the related Item –EUT Test Photos.

4.1.3 DEVIATION FROM TEST STANDARD

No deviation

4.1.4 TEST SETUP

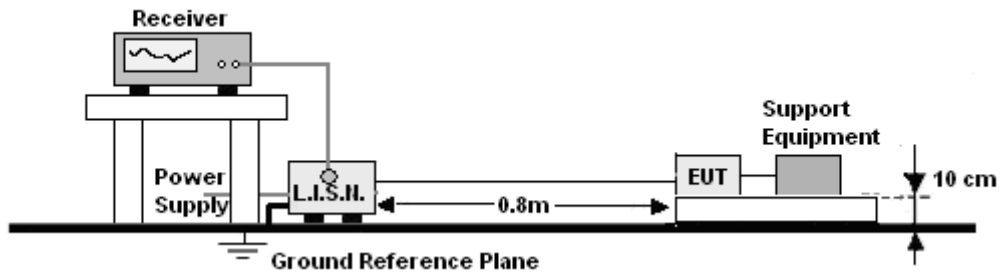

4.1.5 EUT OPERATING CONDITIONS

The EUT was configured for testing in a typical fashion (as a customer would normally use it). The EUT has been programmed to continuously transmit during test. This operating condition was tested and used to collect the included data.

We pretest AC 120V and AC 230V, the worst voltage was AC 120V and the data recording in the report.

4.1.6 Test Result

Temperature :	26°C	Relative Humidity:	54%
Pressure :	101kPa	Phase :	L
Test Voltage :	AC 120V/60Hz		

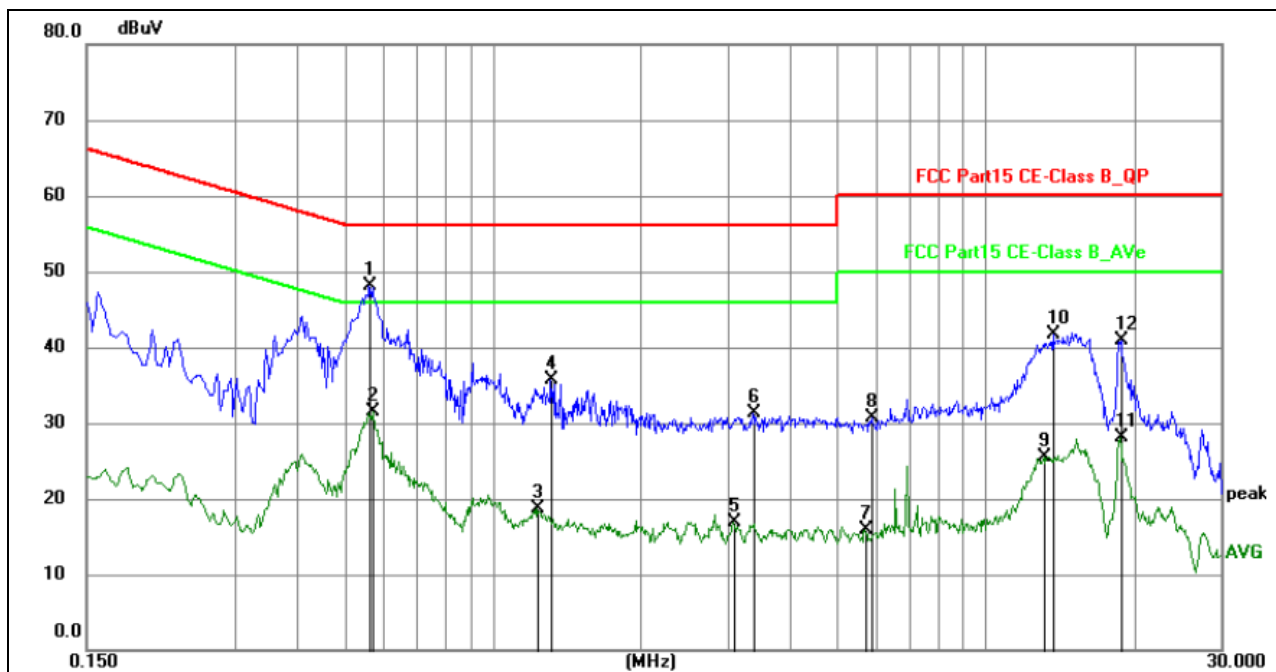

No.	Frequency (MHz)	Reading (dBuV)	Factor (dB)	Level (dBuV)	Limit (dBuV)	Margin (dB)	Detector	P/F	Remark
1	0.5639	37.53	10.53	48.06	56.00	-7.94	QP	P	
2	0.5730	20.98	10.53	31.51	46.00	-14.49	AVG	P	
3	1.2345	8.35	10.38	18.73	46.00	-27.27	AVG	P	
4	1.3154	25.27	10.36	35.63	56.00	-20.37	QP	P	
5	3.0795	6.92	9.89	16.81	46.00	-29.19	AVG	P	
6	3.3720	21.59	9.70	31.29	56.00	-24.71	QP	P	
7	5.7030	7.26	8.62	15.88	50.00	-34.12	AVG	P	
8	5.8740	22.03	8.62	30.65	60.00	-29.35	QP	P	
9	13.1595	16.68	8.90	25.58	50.00	-24.42	AVG	P	
10	13.7670	32.62	8.99	41.61	60.00	-18.39	QP	P	
11	18.7485	18.42	9.68	28.10	50.00	-21.90	AVG	P	
12	18.8610	31.15	9.70	40.85	60.00	-19.15	QP	P	

Notes:

1. An initial pre-scan was performed on the line and neutral lines with peak detector.
2. Quasi-Peak and Average measurement were performed at the frequencies with maximized peak emission.
3. Measurement Level = Reading level + Correct Factor

Temperature :	26°C	Relative Humidity:	54%
Pressure :	101kPa	Phase :	N
Test Voltage :	AC 120V/60Hz		

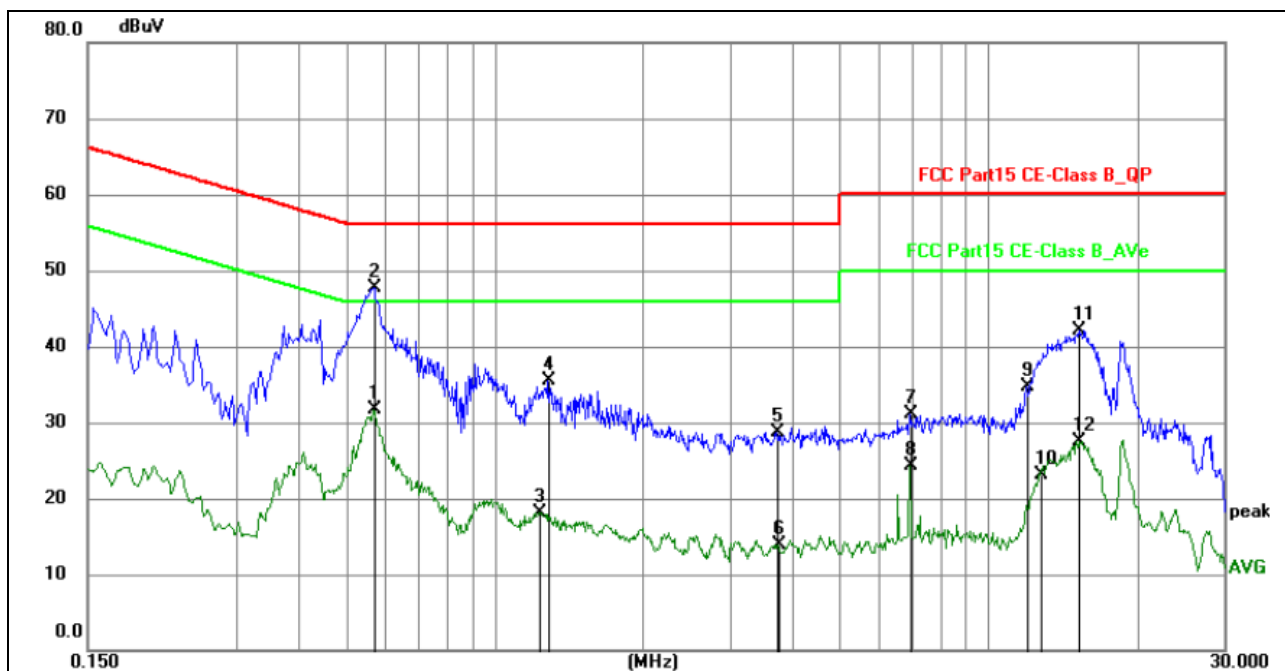

No.	Frequency (MHz)	Reading (dBuV)	Factor (dB)	Level (dBuV)	Limit (dBuV)	Margin (dB)	Detector	P/F	Remark
1	0.5685	21.24	10.53	31.77	46.00	-14.23	AVG	P	
2	0.5730	37.09	10.53	47.62	56.00	-8.38	QP	P	
3	1.2300	7.79	10.38	18.17	46.00	-27.83	AVG	P	
4	1.2885	25.08	10.37	35.45	56.00	-20.55	QP	P	
5	3.7275	19.23	9.47	28.70	56.00	-27.30	QP	P	
6	3.7545	4.38	9.45	13.83	46.00	-32.17	AVG	P	
7	6.9315	22.45	8.57	31.02	60.00	-28.98	QP	P	
8	6.9315	15.73	8.57	24.30	50.00	-25.70	AVG	P	
9	11.9895	26.03	8.74	34.77	60.00	-25.23	QP	P	
10	12.7275	14.25	8.84	23.09	50.00	-26.91	AVG	P	
11	15.2340	32.99	9.19	42.18	60.00	-17.82	QP	P	
12	15.2340	18.29	9.19	27.48	50.00	-22.52	AVG	P	

Notes:

1. An initial pre-scan was performed on the line and neutral lines with peak detector.
2. Quasi-Peak and Average measurement were performed at the frequencies with maximized peak emission.
3. Measurement Level = Reading level + Correct Factor

4.2 Radiated emissions

Test Requirement:	FCC Part15 C Section 15.209				
Test Method:	ANSI C63.10:2013				
Test Frequency Range:	9kHz to 25GHz				
Test site:	Measurement Distance: 3m				
Receiver setup:	Frequency	Detector	RBW	VBW	Value
	9KHz-150KHz	Quasi-peak	200Hz	600Hz	Quasi-peak
	150KHz-30MHz	Quasi-peak	9KHz	30KHz	Quasi-peak
	30MHz-1GHz	Quasi-peak	100KHz	300KHz	Quasi-peak
	Above 1GHz	Peak	1MHz	3MHz	Peak
		Peak	1MHz	10Hz	Average

4.2.1 Radiated Emission Limits

Frequencies (MHz)	Field Strength (micровolts/meter)	Measurement Distance (meters)
0.009~0.490	2400/F(KHz)	300
0.490~1.705	24000/F(KHz)	30
1.705~30.0	30	30
30~88	100	3
88~216	150	3
216~960	200	3
Above 960	500	3

LIMITS OF RADIATED EMISSION MEASUREMENT

FREQUENCY (MHz)	Limit (dBuV/m) (at 3M)	
	PEAK	AVERAGE
Above 1000	74	54

Notes:

- (1) The limit for radiated test was performed according to FCC PART 15C.
- (2) The tighter limit applies at the band edges.
- (3) Emission level (dBuV/m)=20log Emission level (uV/m).

4.2.2 TEST PROCEDURE

Below 1GHz test procedure as below:

- a. The EUT was placed on the top of a rotating table 0.1 meters above the ground at a 3 meter semi-anechoic chamber. The table was rotated 360 degrees to determine the position of the highest radiation.
- b. The EUT was set 3 meters away from the interference-receiving antenna, which was mounted on the top of a variable-height antenna tower.
- c. The antenna height is varied from one meter to four meters above the ground to determine the maximum value of the field strength. Both horizontal and vertical polarizations of the antenna are set to make the measurement.

- d. For each suspected emission, the EUT was arranged to its worst case and then the antenna was tuned to heights from 1 meter to 4 meters (for the test frequency of below 30MHz, the antenna was tuned to heights 1 meter) and the rotatable table was turned from 0 degrees to 360 degrees to find the maximum reading.
- e. The test-receiver system was set to Peak Detect Function and Specified Bandwidth with Maximum Hold Mode.
- f. If the emission level of the EUT in peak mode was 10dB lower than the limit specified, then testing could be stopped and the peak values of the EUT would be reported. Otherwise the emissions that did not have 10dB margin would be re-tested one by one using peak, quasi-peak or average method as specified and then reported in a data sheet.

Above 1GHz test procedure as below:

- g. Different between above is the test site, change from Semi- Anechoic Chamber to fully Anechoic Chamber and change form table 0.8 metre to 1.5 meter(Above 18GHz the distance is 1 meter and table is 1.5 meter).
- h. Test the EUT in the lowest channel ,the middle channel ,the Highest channel

Note:

Both horizontal and vertical antenna polarities were tested and performed pretest to three orthogonal axis. The worst case emissions were reported

4.2.3 DEVIATION FROM TEST STANDARD

No deviation

4.2.4 TEST SETUP

(A) Radiated Emission Test-Up Frequency Below 30MHz

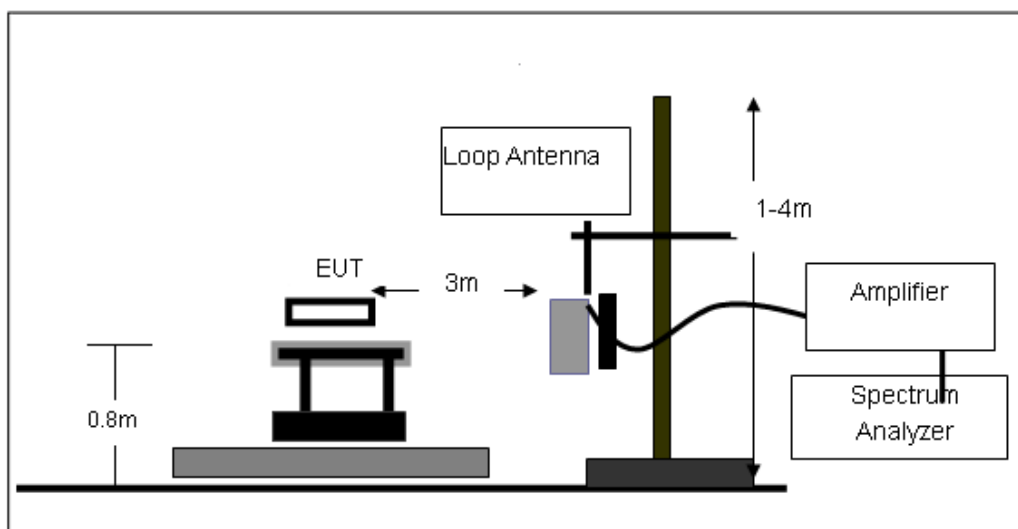

(B) Radiated Emission Test-Up Frequency 30MHz~1GHz

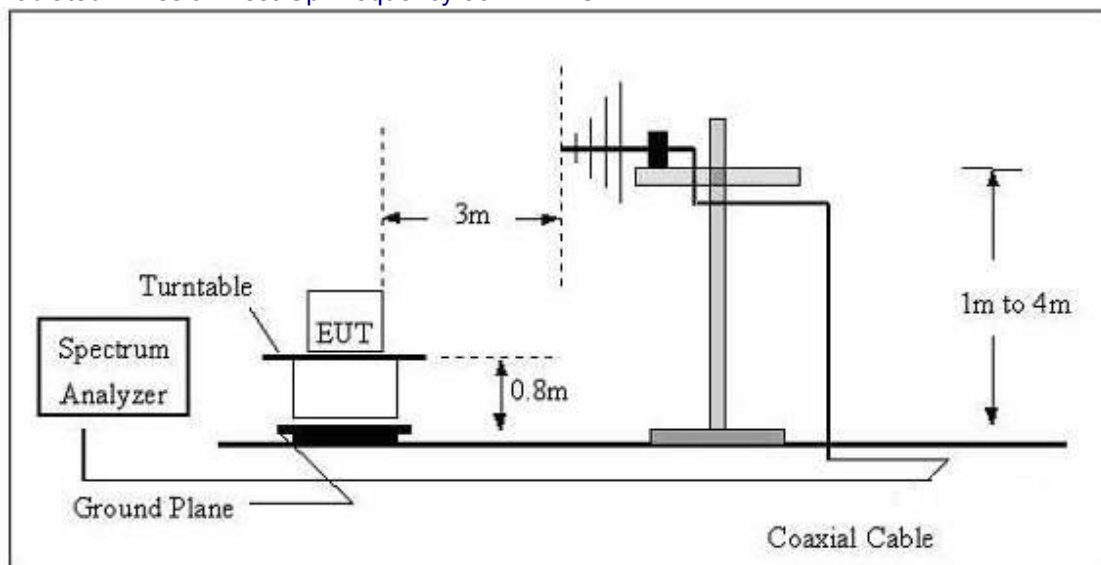

(C) Radiated Emission Test-Up Frequency Above 1GHz

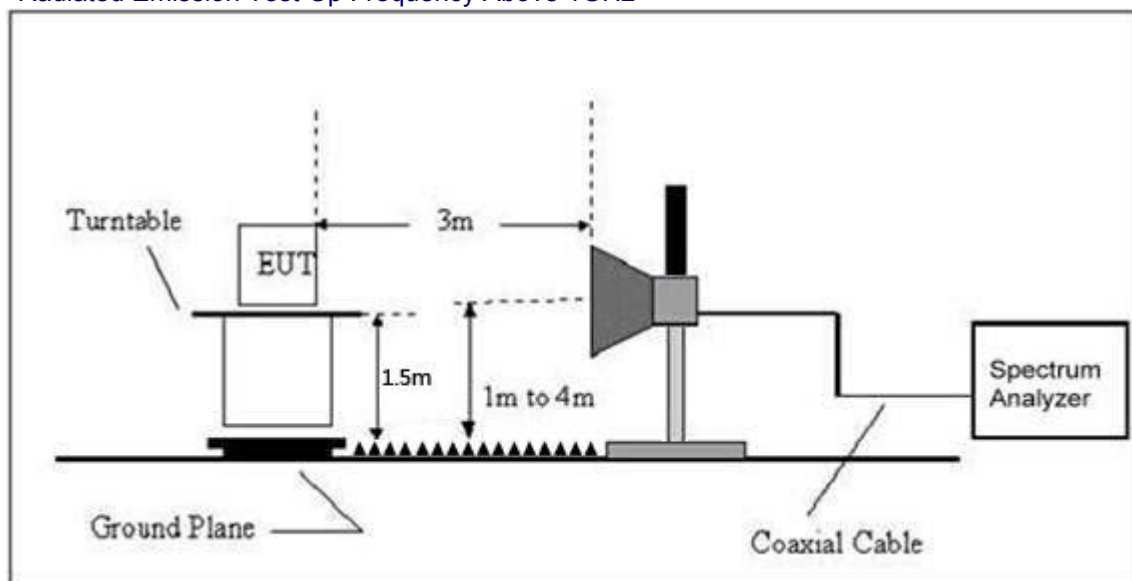

4.2.5 EUT OPERATING CONDITIONS

The EUT tested system was configured as the statements of 2.4 Unless otherwise a special operating condition is specified in the follows during the testing.

4.2.6 TEST RESULTS

Between 9KHz – 30MHz

The emission from 9 kHz to 30MHz was pre-tested and found the result was 20dB lower than the limit, and according to 15.31(o) & RSS-Gen 6.13, the test result no need to reported.

Between 30MHz – 1GHz

Temperature:	26°C	Relative Humidity:	54%
Pressure:	101 kPa	Polarization:	Horizontal
Test Voltage:	AC 120V/60Hz		

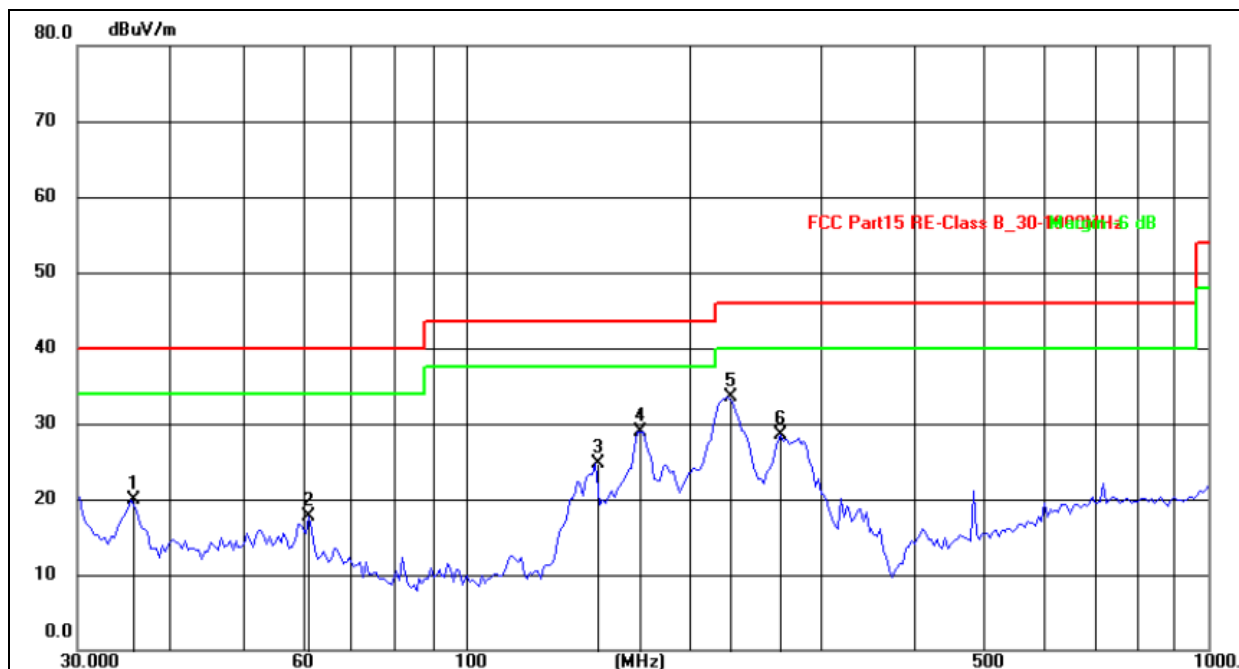

No.	Frequency (MHz)	Reading (dBuV)	Factor (dB/m)	Level (dBuV/m)	Limit (dBuV/m)	Margin (dB)	Detector
1	35.4371	34.77	-14.96	19.81	40.00	-20.19	QP
2	61.5618	32.45	-14.66	17.79	40.00	-22.21	QP
3	149.2239	41.78	-17.08	24.70	43.50	-18.80	QP
4	171.6933	46.80	-17.87	28.93	43.50	-14.57	QP
5	225.3080	52.08	-18.64	33.44	46.00	-12.56	QP
6	266.1419	45.26	-16.84	28.42	46.00	-17.58	QP

Temperature:	26°C	Relative Humidity:	54%
Pressure:	101kPa	Polarization:	Vertical
Test Voltage:	AC 120V/60Hz		

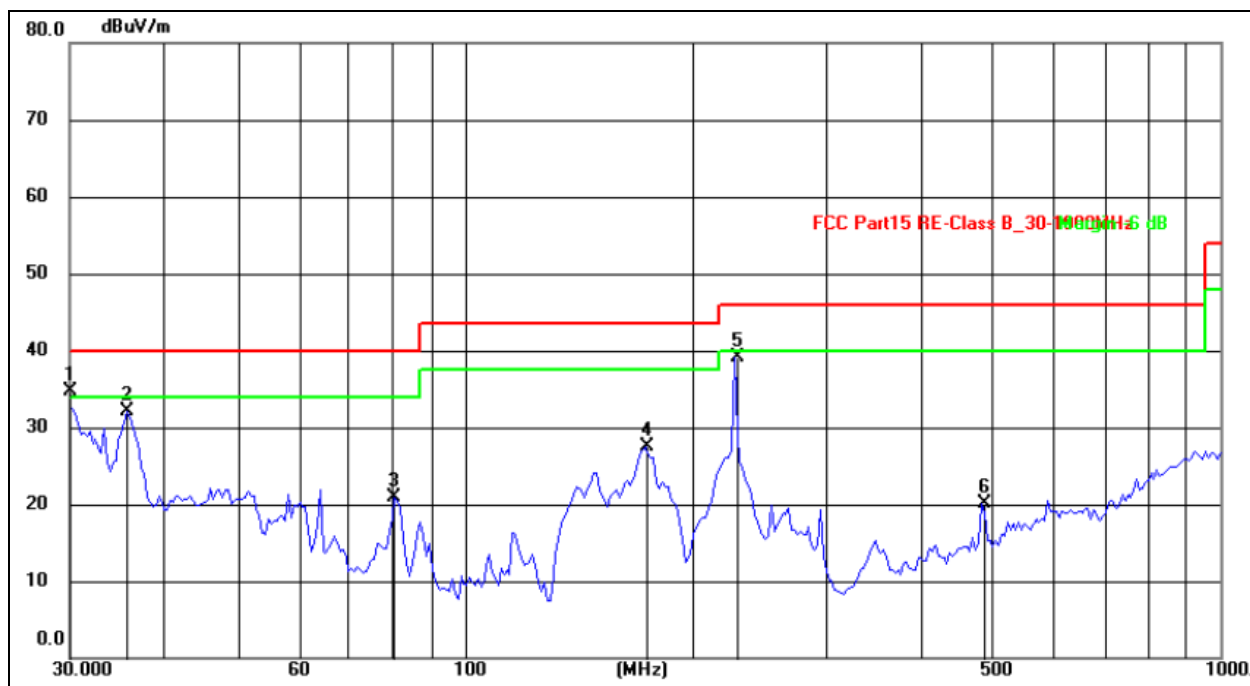

No.	Frequency (MHz)	Reading (dBuV)	Factor (dB/m)	Level (dBuV/m)	Limit (dBuV/m)	Margin (dB)	Detector
1	30.0000	53.22	-18.44	34.78	40.00	-5.22	QP
2	35.7490	49.63	-17.49	32.14	40.00	-7.86	QP
3	80.7857	42.78	-21.84	20.94	40.00	-19.06	QP
4	173.2051	48.20	-20.69	27.51	43.50	-15.99	QP
5	227.2918	60.78	-21.62	39.16	46.00	-6.84	QP
6	483.0618	34.21	-14.16	20.05	46.00	-25.95	QP

Remarks:

- 1.Final Level =Receiver Read level + Antenna Factor + Cable Loss – Preamplifier Factor
- 2.The emission levels of other frequencies are very lower than the limit and not show in test report.
- 3.The test data shows only the worst case GFSK mode

1GHz~25GHz

GFSK

Polar (H/V)	Frequency	Meter Reading	Pre-amplifier	Cable Loss	Antenna Factor	Emission Level	Limits	Margin	Detector Type
	(MHz)	(dBuV)	(dB)	(dB)	(dB)	(dBuV/m)	(dBuV/m)	(dB)	
Low Channel:2402MHz									
V	4804.00	51.51	30.55	5.77	24.66	51.39	74.00	-22.61	Pk
V	4804.00	42.07	30.55	5.77	24.66	41.95	54.00	-12.05	AV
V	7206.00	49.60	30.33	6.32	24.55	50.14	74.00	-23.86	Pk
V	7206.00	42.08	30.33	6.32	24.55	42.62	54.00	-11.38	AV
V	9608.00	50.10	30.85	7.45	24.69	51.39	74.00	-22.61	Pk
V	9608.00	42.08	30.85	7.45	24.69	43.37	54.00	-10.63	AV
V	12010.00	50.20	31.02	8.99	25.57	53.74	74.00	-20.26	Pk
V	12010.00	41.98	31.02	8.99	25.57	45.52	54.00	-8.48	AV
H	4804.00	52.15	30.55	5.77	24.66	52.03	74.00	-21.97	Pk
H	4804.00	41.70	30.55	5.77	24.66	41.58	54.00	-12.42	AV
H	7206.00	50.49	30.33	6.32	24.55	51.03	74.00	-22.97	Pk
H	7206.00	41.75	30.33	6.32	24.55	42.29	54.00	-11.71	AV
H	9608.00	50.49	30.85	7.45	24.69	51.78	74.00	-22.22	Pk
H	9608.00	41.75	30.85	7.45	24.69	43.04	54.00	-10.96	AV
H	12010.00	50.49	31.02	8.99	25.57	54.03	74.00	-19.97	Pk
H	12010.00	40.75	31.02	8.99	25.57	44.29	54.00	-9.71	AV

Polar (H/V)	Frequency	Meter Reading	Pre-amplifier	Cable Loss	Antenna Factor	Emission Level	Limits	Margin	Detector Type
	(MHz)	(dBuV)	(dB)	(dB)	(dB)	(dBuV/m)	(dBuV/m)	(dB)	
Middle Channel:2441MHz									
V	4882.00	50.51	30.55	5.77	24.66	50.39	74.00	-23.61	Pk
V	4882.00	41.40	30.55	5.77	24.66	41.28	54.00	-12.72	AV
V	7323.00	49.04	30.33	6.32	24.55	49.58	74.00	-24.42	Pk
V	7323.00	41.08	30.33	6.32	24.55	41.62	54.00	-12.38	AV
V	9764.00	49.11	30.85	7.45	24.69	50.4	74.00	-23.6	Pk
V	9764.00	41.08	30.85	7.45	24.69	42.37	54.00	-11.63	AV
V	12205.00	49.01	31.02	8.99	25.57	52.55	74.00	-21.45	Pk
V	12205.00	41.08	31.02	8.99	25.57	44.62	54.00	-9.38	AV
H	4882.00	51.87	30.55	5.77	24.66	51.75	74.00	-22.25	Pk
H	4882.00	41.43	30.55	5.77	24.66	41.31	54.00	-12.69	AV
H	7323.00	52.58	30.33	6.32	24.55	53.12	74.00	-20.88	Pk
H	7323.00	41.21	30.33	6.32	24.55	41.75	54.00	-12.25	AV
H	9764.00	52.58	30.85	7.45	24.69	53.87	74.00	-20.13	Pk
H	9764.00	41.21	30.85	7.45	24.69	42.5	54.00	-11.5	AV
H	12205.00	53.08	31.02	8.99	25.57	56.62	74.00	-17.38	Pk
H	12205.00	41.21	31.02	8.99	25.57	44.75	54.00	-9.25	AV

Polar (H/V)	Frequency	Meter Reading	Pre-amplifier	Cable Loss	Antenna Factor	Emission Level	Limits	Margin	Detector Type
	(MHz)	(dBuV)	(dB)	(dB)	(dB)	(dBuV/m)	(dBuV/m)	(dB)	
High Channel:2480MHz									
V	4960.00	50.23	30.55	5.77	24.66	50.11	74.00	-23.89	Pk
V	4960.00	41.77	30.55	5.77	24.66	41.65	54.00	-12.35	AV
V	7440.00	52.74	30.33	6.32	24.55	53.28	74.00	-20.72	Pk
V	7440.00	42.09	30.33	6.32	24.55	42.63	54.00	-11.37	AV

V	9920.00	52.74	30.85	7.45	24.69	54.03	74.00	-19.97	Pk
V	9920.00	43.08	30.85	7.45	24.69	44.37	54.00	-9.63	AV
V	12400.00	53.14	31.02	8.99	25.57	56.68	74.00	-17.32	Pk
V	12400.00	41.98	31.02	8.99	25.57	45.52	54.00	-8.48	AV
H	4960.00	50.32	30.55	5.77	24.66	50.2	74.00	-23.8	Pk
H	4960.00	41.99	30.55	5.77	24.66	41.87	54.00	-12.13	AV
H	7440.00	51.91	30.33	6.32	24.55	52.45	74.00	-21.55	Pk
H	7440.00	42.25	30.33	6.32	24.55	42.79	54.00	-11.21	AV
H	9920.00	52.51	30.85	7.45	24.69	53.80	74.00	-20.20	Pk
H	9920.00	42.35	30.85	7.45	24.69	43.64	54.00	-10.36	AV
H	12400.00	53.11	31.02	8.99	25.57	56.65	74.00	-17.35	Pk
H	12400.00	42.35	31.02	8.99	25.57	45.89	54.00	-8.11	AV

Remark:

1. Emission Level = Meter Reading + Antenna Factor + Cable Loss – Pre-amplifier,
Margin= Emission Level - Limit
2. If peak below the average limit, the average emission was no test.
3. The amplitude of spurious emissions which are attenuated by more than 20dB below the permissible value has no need to be reported.

π/4-DQPSK

Polar (H/V)	Frequency	Meter Reading	Pre-amplifier	Cable Loss	Antenna Factor	Emission Level	Limits	Margin	Detector Type
	(MHz)	(dBuV)	(dB)	(dB)	(dB)	(dBuV/m)	(dBuV/m)	(dB)	
Low Channel:2402MHz									
V	4804.00	51.31	30.55	5.77	24.66	51.19	74.00	-22.81	Pk
V	4804.00	41.07	30.55	5.77	24.66	40.95	54.00	-13.05	AV
V	7206.00	49.10	30.33	6.32	24.55	49.64	74.00	-24.36	Pk
V	7206.00	42.02	30.33	6.32	24.55	42.56	54.00	-11.44	AV
V	9608.00	49.51	30.85	7.45	24.69	50.8	74.00	-23.2	Pk
V	9608.00	41.58	30.85	7.45	24.69	42.87	54.00	-11.13	AV
V	12010.00	49.20	31.02	8.99	25.57	52.74	74.00	-21.26	Pk
V	12010.00	41.48	31.02	8.99	25.57	45.02	54.00	-8.98	AV
H	4804.00	51.65	30.55	5.77	24.66	51.53	74.00	-22.47	Pk
H	4804.00	41.50	30.55	5.77	24.66	41.38	54.00	-12.62	AV
H	7206.00	50.40	30.33	6.32	24.55	50.94	74.00	-23.06	Pk
H	7206.00	41.71	30.33	6.32	24.55	42.25	54.00	-11.75	AV
H	9608.00	50.42	30.85	7.45	24.69	51.71	74.00	-22.29	Pk
H	9608.00	41.73	30.85	7.45	24.69	43.02	54.00	-10.98	AV
H	12010.00	50.45	31.02	8.99	25.57	53.99	74.00	-20.01	Pk
H	12010.00	41.24	31.02	8.99	25.57	44.78	54.00	-9.22	AV

Polar (H/V)	Frequency	Meter Reading	Pre-amplifier	Cable Loss	Antenna Factor	Emission Level	Limits	Margin	Detector Type
	(MHz)	(dBuV)	(dB)	(dB)	(dB)	(dBuV/m)	(dBuV/m)	(dB)	
Middle Channel:2441MHz									
V	4882.00	50.31	30.55	5.77	24.66	50.19	74.00	-23.81	Pk
V	4882.00	41.20	30.55	5.77	24.66	41.08	54.00	-12.92	AV
V	7323.00	49.01	30.33	6.32	24.55	49.55	74.00	-24.45	Pk
V	7323.00	41.03	30.33	6.32	24.55	41.57	54.00	-12.43	AV
V	9764.00	49.09	30.85	7.45	24.69	50.38	74.00	-23.62	Pk
V	9764.00	41.05	30.85	7.45	24.69	42.34	54.00	-11.66	AV
V	12205.00	49.07	31.02	8.99	25.57	52.61	74.00	-21.39	Pk
V	12205.00	41.06	31.02	8.99	25.57	44.6	54.00	-9.4	AV
H	4882.00	51.57	30.55	5.77	24.66	51.45	74.00	-22.55	Pk
H	4882.00	41.33	30.55	5.77	24.66	41.21	54.00	-12.79	AV
H	7323.00	52.28	30.33	6.32	24.55	52.82	74.00	-21.18	Pk
H	7323.00	41.11	30.33	6.32	24.55	41.65	54.00	-12.35	AV
H	9764.00	52.48	30.85	7.45	24.69	53.77	74.00	-20.23	Pk
H	9764.00	41.11	30.85	7.45	24.69	42.4	54.00	-11.6	AV
H	12205.00	53.03	31.02	8.99	25.57	56.57	74.00	-17.43	Pk
H	12205.00	41.11	31.02	8.99	25.57	44.65	54.00	-9.35	AV

Polar (H/V)	Frequency	Meter Reading	Pre-amplifier	Cable Loss	Antenna Factor	Emission Level	Limits	Margin	Detector Type
	(MHz)	(dBuV)	(dB)	(dB)	(dB)	(dBuV/m)	(dBuV/m)	(dB)	
High Channel:2480MHz									
V	4960.00	50.2	30.55	5.77	24.66	50.08	74.00	-23.92	Pk
V	4960.00	41.7	30.55	5.77	24.66	41.58	54.00	-12.42	AV
V	7440.00	52.54	30.33	6.32	24.55	53.08	74.00	-20.92	Pk
V	7440.00	42.04	30.33	6.32	24.55	42.58	54.00	-11.42	AV
V	9920.00	53.14	30.85	7.45	24.69	54.43	74.00	-19.57	Pk
V	9920.00	43.08	30.85	7.45	24.69	44.37	54.00	-9.63	AV

V	12400.00	53.14	31.02	8.99	25.57	56.68	74.00	-17.32	Pk
V	12400.00	41.68	31.02	8.99	25.57	45.22	54.00	-8.78	AV
H	4960.00	50.22	30.55	5.77	24.66	50.1	74.00	-23.9	Pk
H	4960.00	41.89	30.55	5.77	24.66	41.77	54.00	-12.23	AV
H	7440.00	52.11	30.33	6.32	24.55	52.65	74.00	-21.35	Pk
H	7440.00	42.21	30.33	6.32	24.55	42.75	54.00	-11.25	AV
H	9920.00	52.41	30.85	7.45	24.69	53.7	74.00	-20.3	Pk
H	9920.00	42.25	30.85	7.45	24.69	43.54	54.00	-10.46	AV
H	12400.00	52.31	31.02	8.99	25.57	55.85	74.00	-18.15	Pk
H	12400.00	42.25	31.02	8.99	25.57	45.79	54.00	-8.21	AV

Remark:

1. Emission Level = Meter Reading + Antenna Factor + Cable Loss – Pre-amplifier,
Margin= Emission Level - Limit
2. If peak below the average limit, the average emission was no test.
3. The amplitude of spurious emissions which are attenuated by more than 20dB below the permissible value has no need to be reported.

5. RADIATED BAND EMISSION MEASUREMENT

5.1 Test Requirement:

Test Requirement:	FCC Part15 C Section 15.209 and 15.205				
Test Method:	ANSI C63.10: 2013				
Test Frequency Range:	All of the restrict bands were tested, only the worst band's (2310MHz to 2500MHz) data was showed.				
Test site:	Measurement Distance: 3m				
Receiver setup:	Frequency	Detector	RBW	VBW	Value
	Above 1GHz	Peak	1MHz	3MHz	Peak
		Average	1MHz	3MHz	Average

LIMITS OF RADIATED EMISSION MEASUREMENT (Above 1000MHz)

FREQUENCY (MHz)	Limit (dBuV/m) (at 3M)	
	PEAK	AVERAGE
Above 1000	74	54

Notes:

- (1) The limit for radiated test was performed according to FCC PART 15C.
- (2) The tighter limit applies at the band edges.
- (3) Emission level (dBuV/m)=20log Emission level (uV/m).

Spectrum Parameter	Setting
Attenuation	Auto
Start Frequency	2300MHz
Stop Frequency	2520
RB / VB (emission in restricted band)	1 MHz / 1 MHz for Peak, 1 MHz / 10Hz for Average

5.2 TEST PROCEDURE

Above 1GHz test procedure as below:

- a. 1. The EUT was placed on the top of a rotating table 1.5 meters above the ground at a 3 meter camber. The table was rotated 360 degrees to determine the position of the highest radiation.
- b. The EUT was set 3 meters away from the interference-receiving antenna, which was mounted on the top of a variable-height antenna tower.
- c. The antenna height is varied from one meter to four meters above the ground to determine the maximum value of the field strength. Both horizontal and vertical polarizations of the antenna are set to make the measurement.
- d. For each suspected emission, the EUT was arranged to its worst case and then the antenna was tuned to heights from 1 meter to 4 meters and the rota table was turned from 0 degrees to 360 degrees to find the maximum reading.
- e. The test-receiver system was set to Peak Detect Function and Specified Bandwidth with Maximum Hold Mode.
- f. If the emission level of the EUT in peak mode was 10dB lower than the limit specified, then testing could be stopped and the peak values of the EUT would be reported. Otherwise the emissions that did not have 10dB margin would be re-tested one by one using peak, quasi-peak or average method as specified and then reported in a data sheet.
- g. Test the EUT in the lowest channel,the Highest channel

Note:

Both horizontal and vertical antenna polarities were tested and performed pretest to three orthogonal axis. The worst case emissions were reported

5.3 DEVIATION FROM TEST STANDARD

No deviation

5.4 TEST SETUP

Radiated Emission Test-Up Frequency Above 1GHz

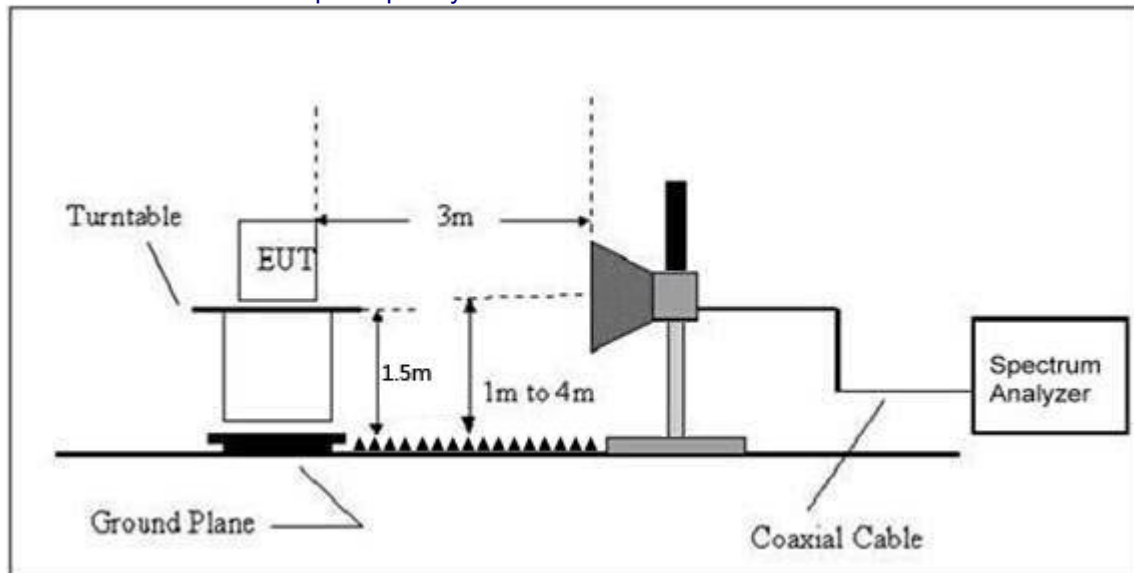

5.5 EUT OPERATING CONDITIONS

The EUT tested system was configured as the statements of 2.3 Unless otherwise a special operating condition is specified in the follows during the testing.

5.6 TEST RESULT

	Polar (H/V)	Frequency (MHz)	Meter Reading (dBuV)	Pre-amplifier (dB)	Cable Loss (dB)	Antenna Factor (dB/m)	Emission level (dBuV/m)	Limit (dBuV/m)	Detector Type	Result
GFSK	Low Channel: 2402MHz									
	H	2390.00	59.53	30.22	4.85	23.98	58.14	74.00	PK	PASS
	H	2390.00	51.36	30.22	4.85	23.98	49.97	54.00	AV	PASS
	H	2400.00	61.26	30.22	4.85	23.98	59.87	74.00	PK	PASS
	H	2400.00	51.36	30.22	4.85	23.98	49.97	54.00	AV	PASS
	V	2390.00	59.38	30.22	4.85	23.98	57.99	74.00	PK	PASS
	V	2390.00	51.26	30.22	4.85	23.98	49.87	54.00	AV	PASS
	V	2400.00	61.11	30.22	4.85	23.98	59.72	74.00	PK	PASS
	V	2400.00	51.36	30.22	4.85	23.98	49.97	54.00	AV	PASS
	High Channel: 2480MHz									
	H	2483.50	59.22	30.22	4.85	23.98	57.83	74.00	PK	PASS
	H	2485.50	50.26	30.22	4.85	23.98	48.87	54.00	AV	PASS
	H	2483.50	60.69	30.22	4.85	23.98	59.3	74.00	PK	PASS
	H	2485.50	51.14	30.22	4.85	23.98	49.75	54.00	AV	PASS
	V	2483.50	60.03	30.22	4.85	23.98	58.64	74.00	PK	PASS
	V	2485.50	51.63	30.22	4.85	23.98	50.24	54.00	AV	PASS
V	2483.50	60.22	30.22	4.85	23.98	58.83	74.00	PK	PASS	
V	2485.50	51.11	30.22	4.85	23.98	49.72	54.00	AV	PASS	
π/4-DQPSK	Low Channel: 2402MHz									
	H	2390.00	59.03	30.22	4.85	23.98	57.64	74.00	PK	PASS
	H	2390.00	51.26	30.22	4.85	23.98	49.87	54.00	AV	PASS
	H	2400.00	61.06	30.22	4.85	23.98	59.67	74.00	PK	PASS
	H	2400.00	51.16	30.22	4.85	23.98	49.77	54.00	AV	PASS
	V	2390.00	59.28	30.22	4.85	23.98	57.89	74.00	PK	PASS
	V	2390.00	51.06	30.22	4.85	23.98	49.67	54.00	AV	PASS
	V	2400.00	61.01	30.22	4.85	23.98	59.62	74.00	PK	PASS
	V	2400.00	51.06	30.22	4.85	23.98	49.67	54.00	AV	PASS
	High Channel: 2480MHz									
	H	2483.50	59.33	30.22	4.85	23.98	57.94	74.00	PK	PASS
	H	2485.50	51.06	30.22	4.85	23.98	49.67	54.00	AV	PASS
	H	2483.50	61.16	30.22	4.85	23.98	59.77	74.00	PK	PASS
	H	2485.50	51.26	30.22	4.85	23.98	49.87	54.00	AV	PASS
	V	2483.50	59.23	30.22	4.85	23.98	57.84	74.00	PK	PASS
	V	2485.50	51.16	30.22	4.85	23.98	49.77	54.00	AV	PASS
V	2483.50	61.21	30.22	4.85	23.98	59.82	74.00	PK	PASS	
V	2485.50	51.33	30.22	4.85	23.98	49.94	54.00	AV	PASS	
Remark:										
1. Emission Level = Meter Reading + Antenna Factor + Cable Loss – Pre-amplifier, Margin= Emission Level - Limit										

6. CONDUCTED BAND EDGE AND SPURIOUS EMISSION

Test Requirement:	FCC Part15 C Section 15.247 (d)
Test Method:	KDB558074 D0115.247 Meas Guidancev05r02

6.1 Limit

Regulation 15.247 (d), In any 100 kHz bandwidth outside the frequency band in which the spread spectrum or digitally modulated intentional radiator is operating, the radio frequency power that is produced by the intentional radiator shall be at least 20 dB below that in the 100 kHz bandwidth within the band that contains the highest level of the desired power, based on either an RF conducted or a radiated measurement, provided the transmitter demonstrates compliance with the peak conducted power limits. If the transmitter complies with the conducted power limits based on the use of RMS averaging over a time interval, as permitted under paragraph (b)(3) of this section, the attenuation required under this paragraph shall be 30 dB instead of 20 dB. Attenuation below the general limits specified in §15.209(a) is not required. In addition, radiated emissions which fall in the restricted bands, as defined in §15.205(a), must also comply with the radiated emission limits specified in §15.209(a) (see §15.205(c)).

6.2 Test Setup



6.3 Test procedure

Using the following spectrum analyzer setting:

- A) Set the RBW = 100KHz.
- B) Set the VBW = 300KHz.
- C) Sweep time = auto couple.
- D) Detector function = peak.
- E) Trace mode = max hold.
- F) Allow trace to fully stabilize.

6.4 DEVIATION FROM STANDARD

No deviation.

6.5 Test Result

GFSK mode:

Test channel:	Lowest channel
---------------	----------------

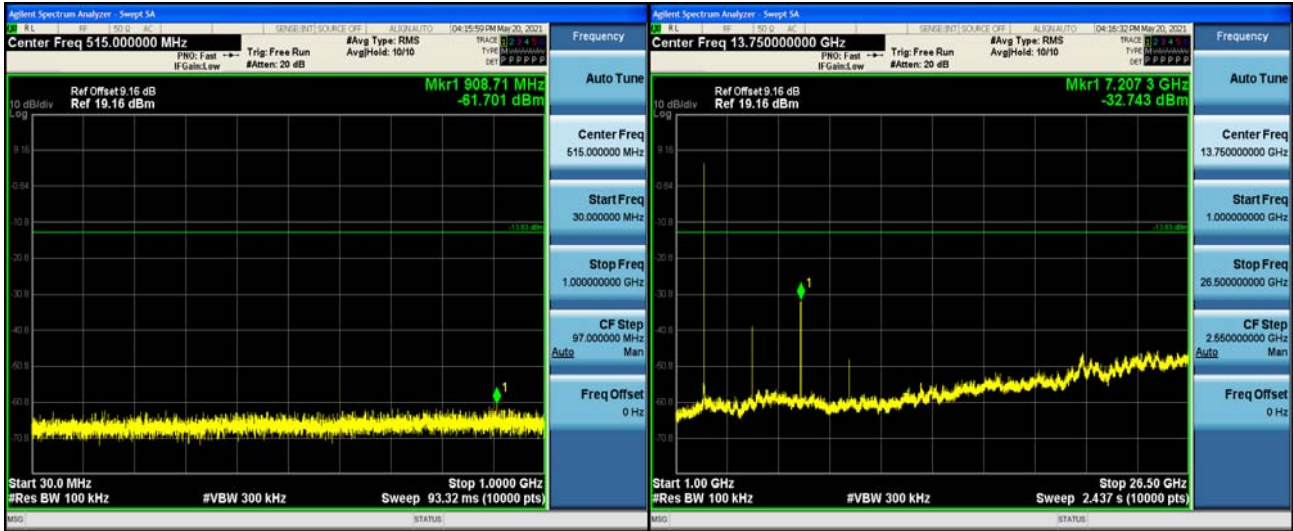

30MHz~26.5GHz

Test channel:	Middle channel
---------------	----------------

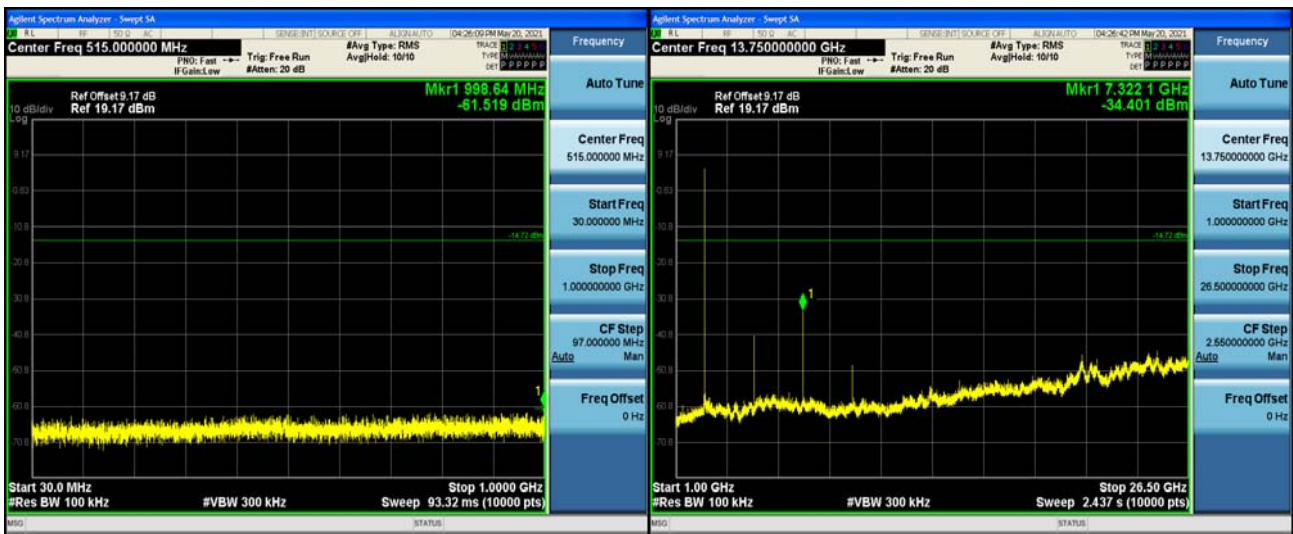

30MHz~26.5GHz

Test channel:	Highest channel
---------------	-----------------

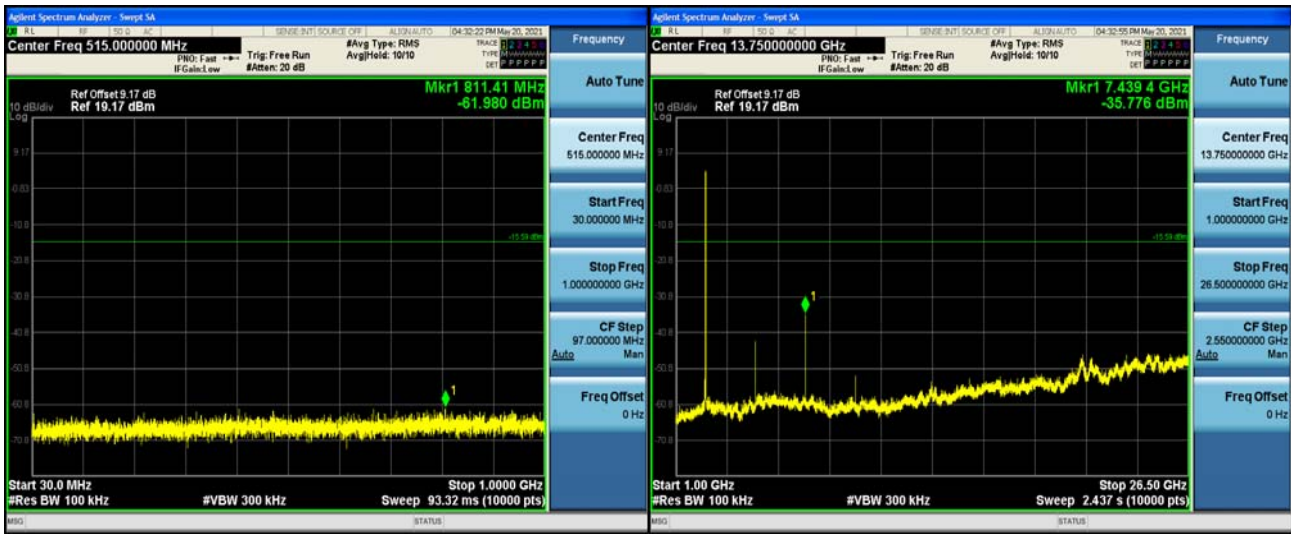

30MHz~26.5GHz

$\pi/4$ -DQPSK mode:

Test channel:	Lowest channel
---------------	----------------

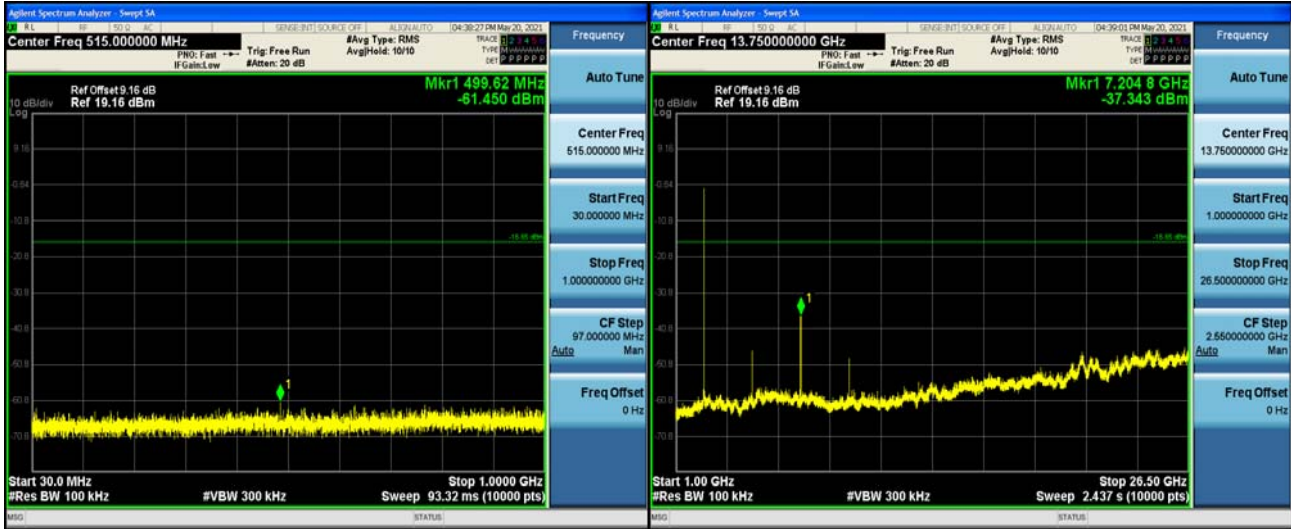

30MHz~26.5GHz

Test channel:	Middle channel
---------------	----------------

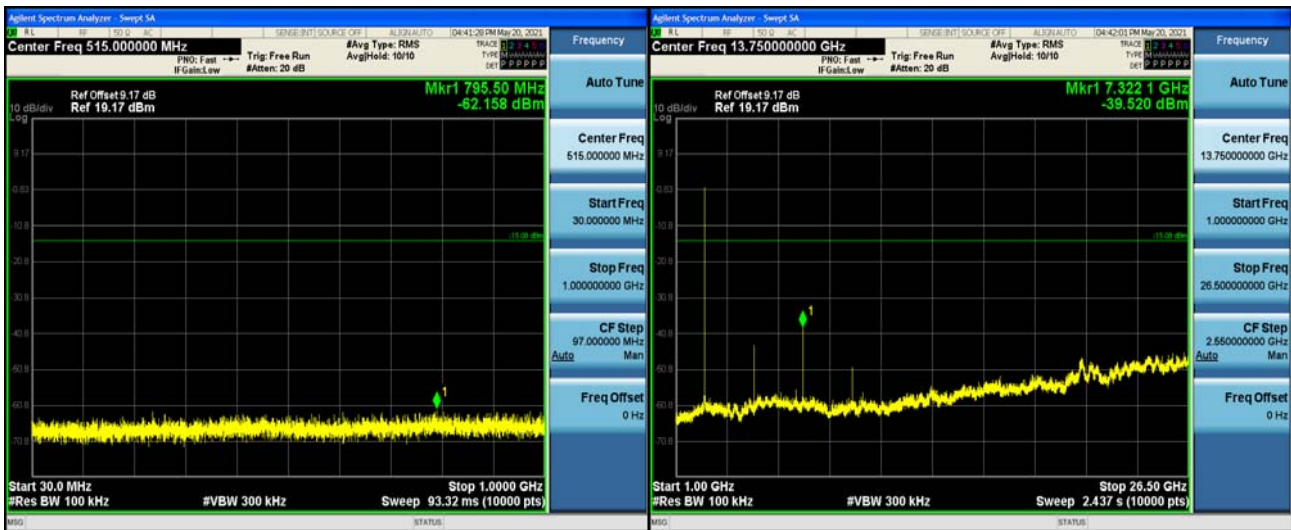

30MHz~26.5GHz

Test channel:	Highest channel
---------------	-----------------

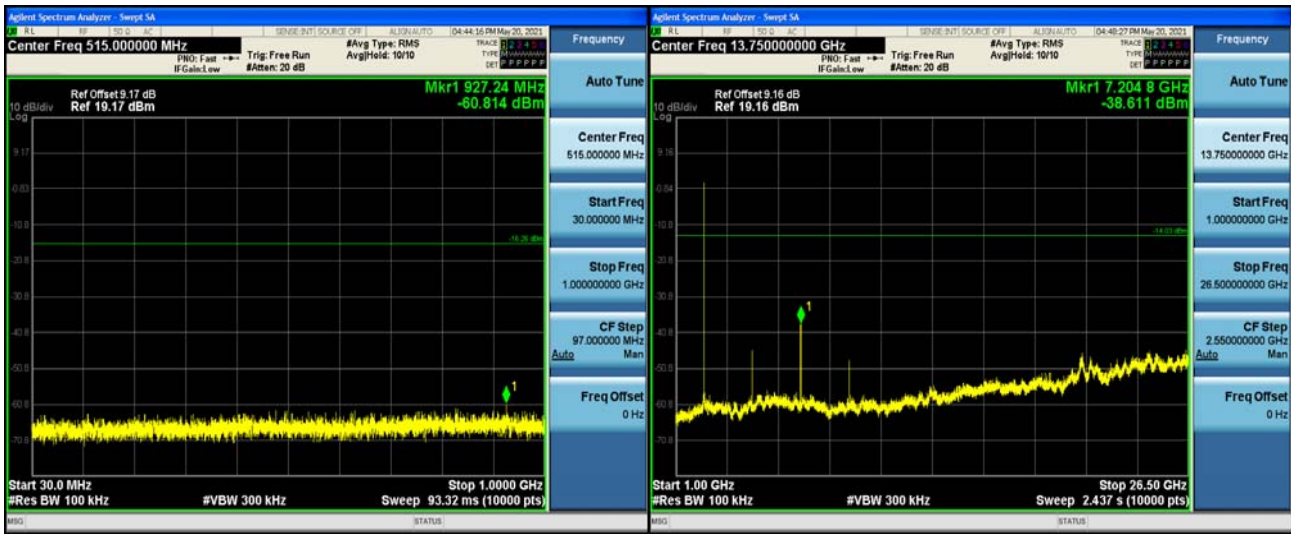

30MHz~26.5GHz

GFSK No-hopping Band edge-left side

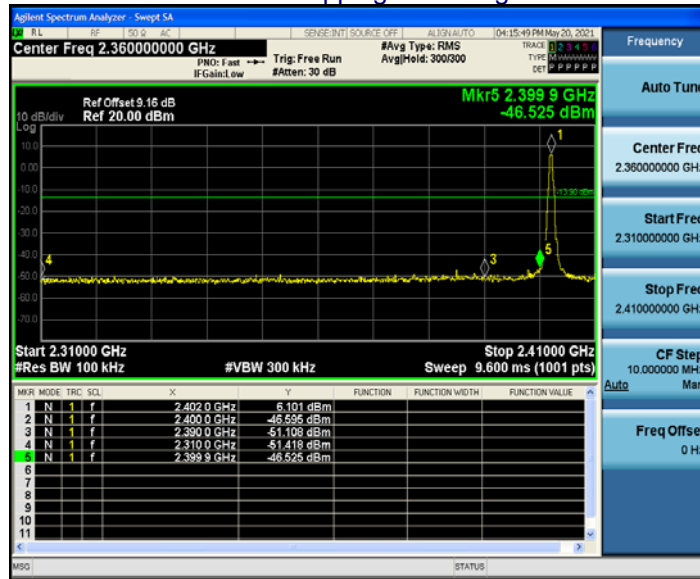

GFSK Hopping Band edge-left side

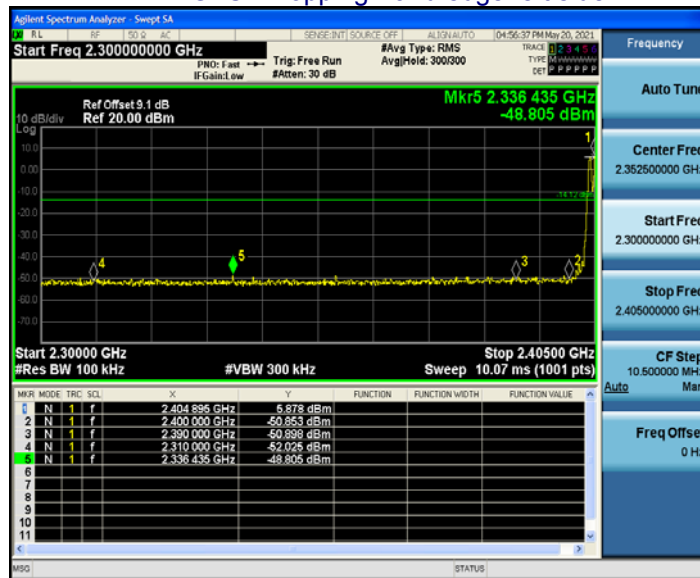

GFSK No-hopping Band edge-right side

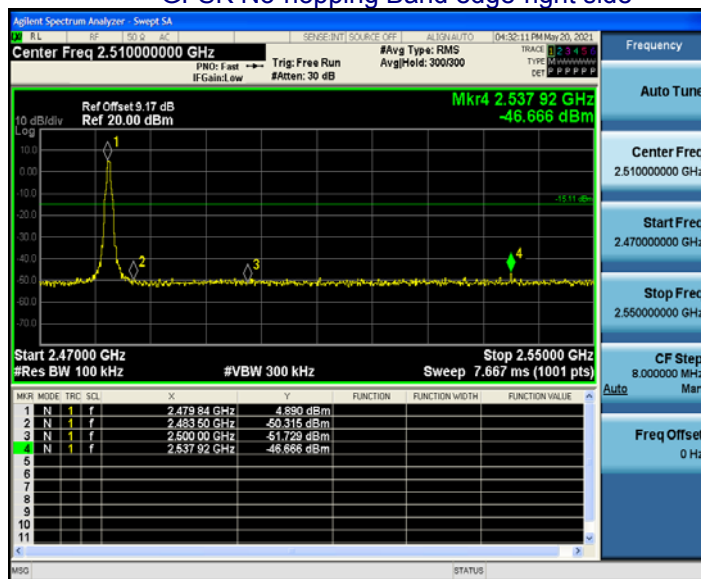

GFSK Hopping Band edge-right side

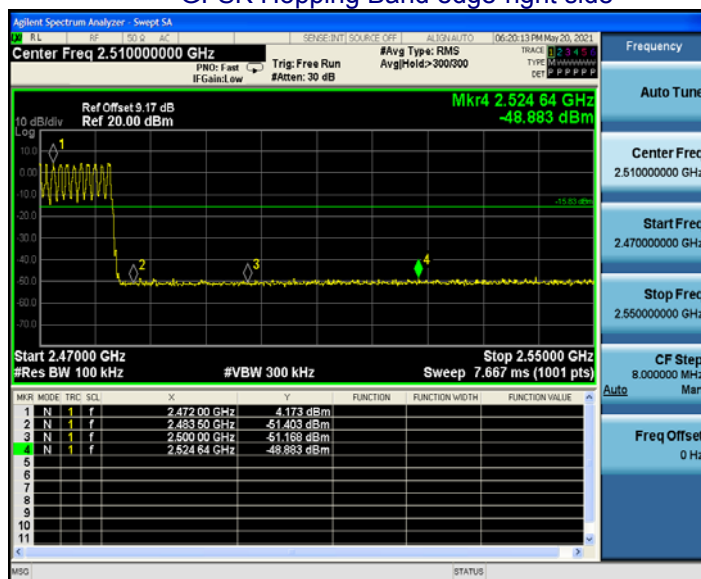

$\pi/4$ -DQPSK No-hopping Band edge-left side

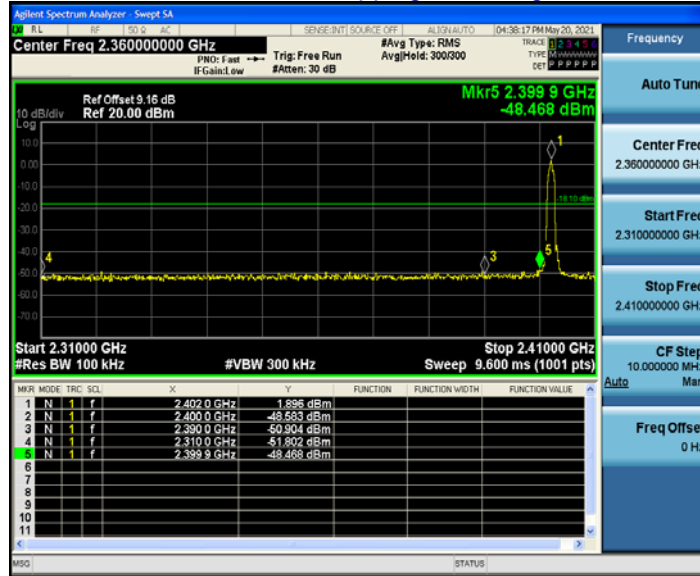

$\pi/4$ -DQPSK Hopping Band edge-left side

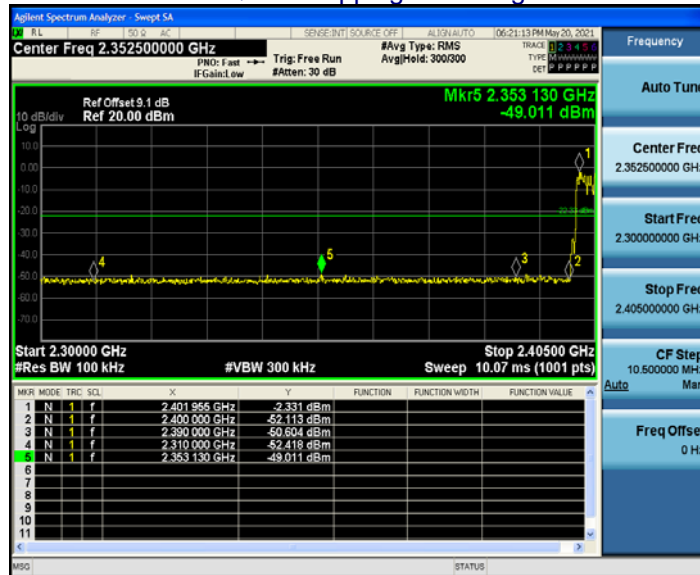

$\pi/4$ -DQPSK No-hopping Band edge-right side

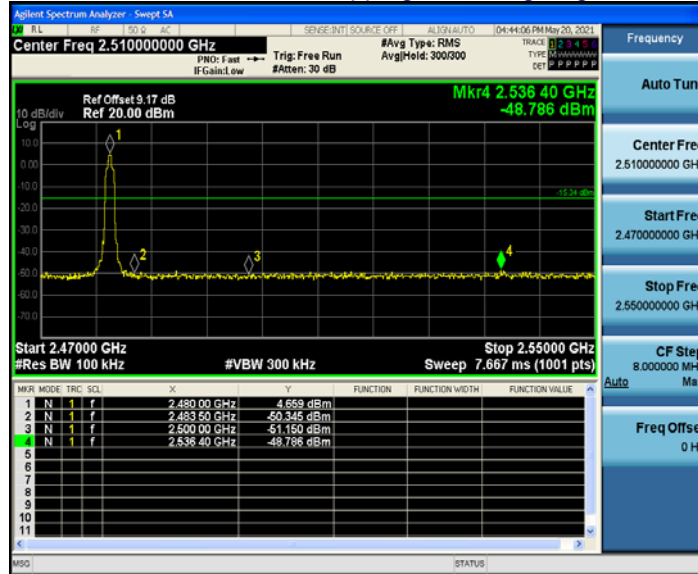

$\pi/4$ -DQPSK Hopping Band edge-right side

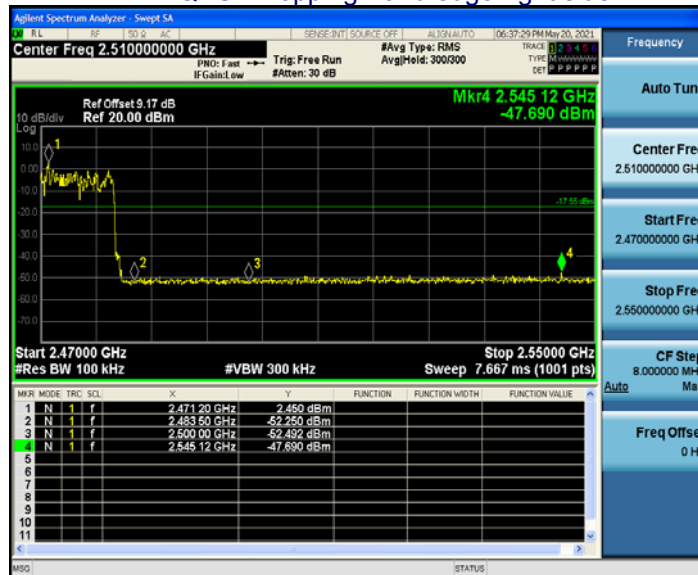

7. 20DB BANDWIDTH

Test Requirement:	FCC Part15 C Section 15.247 (a)(1)
Test Method:	ANSI C63.10:2013

7.1 Test Setup



7.2 Limit

N/A

7.3 Test procedure

1. Set RBW = 30 kHz.
2. Set the video bandwidth (VBW) $\geq 3 \times$ RBW.
3. Detector = Peak.
4. Trace mode = max hold.
5. Sweep = auto couple.
6. Allow the trace to stabilize.
7. Measure the maximum width of the emission that is constrained by the frequencies associated with the two outermost amplitude points (upper and lower frequencies) that are attenuated by 6 dB relative to the maximum level measured in the fundamental emission.

7.4 DEVIATION FROM STANDARD

No deviation.

7.5 Test Result

Mode	Test channel	20dB Emission Bandwidth (KHz)	Result
GFSK	Lowest	920.8	Pass
	Middle	958.8	
	Highest	932.5	
$\pi/4$ -DQPSK	Lowest	1230.0	Pass
	Middle	1272.0	
	Highest	1226.0	

Test plots

GFSK Low Channel



GFSK Middle Channel



GFSK High Channel

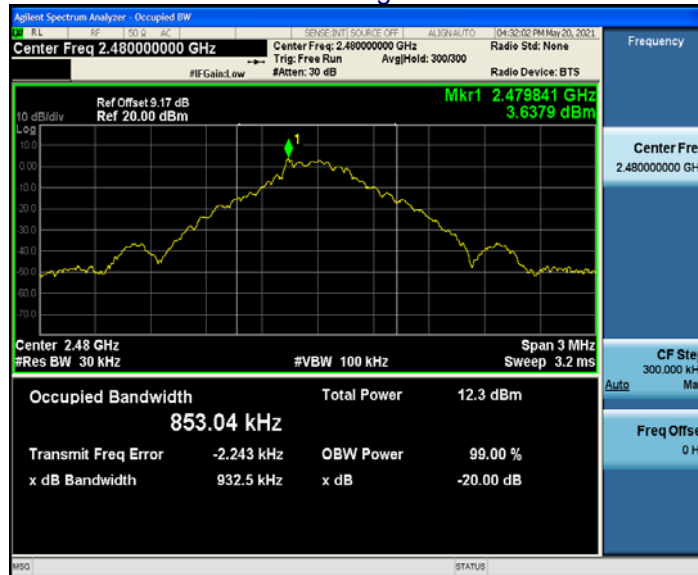

$\pi/4$ -DQPSK Low Channel



$\pi/4$ -DQPSK Middle Channel



$\pi/4$ -DQPSK High Channel

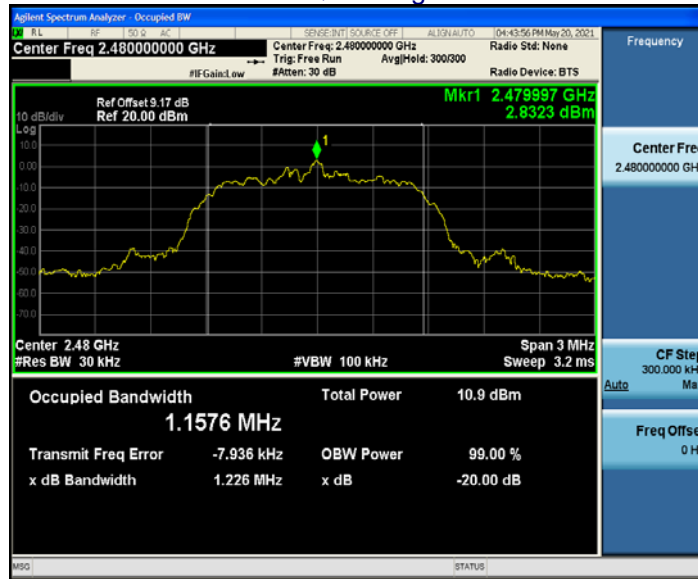

8. Maximum Peak Output Power

Test Requirement:	FCC Part15 C Section 15.247 (b)(1)
Test Method:	ANSI C63.10:2013
Limit:	30dBm(for GFSK), 20.97dBm(for EDR)

8.1 Block Diagram Of Test Setup

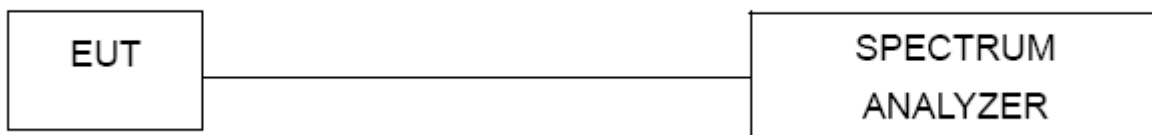

8.2 Limit

For frequency hopping systems operating in the 2400-2483.5 MHz band employing at least 75 non-overlapping hopping channels, and all frequency hopping systems in the 5725-5850 MHz band: 1 watt.
For all other frequency hopping systems in the 2400-2483.5 MHz band: 0.125 watts.

8.3 Test procedure

1. Remove the antenna from the EUT and then connect a low RF cable from the antenna port to the spectrum.
2. Set the spectrum analyzer: RBW = 3MHz. VBW = 3MHz. Sweep = auto; Detector Function = Peak.
3. Keep the EUT in transmitting at lowest, medium and highest channel individually. Record the max value.

8.4 DEVIATION FROM STANDARD

No deviation.

8.5 Test Result

Mode	Test channel	Peak Output Power (dBm)	Limit (dBm)	Result
GFSK	Lowest	6.430	30.00	Pass
	Middle	5.938		
	Highest	5.171		
$\pi/4$ -DQPSK	Lowest	6.511	20.97	Pass
	Middle	6.096		
	Highest	5.284		

Test plots
GFSK Low Channel

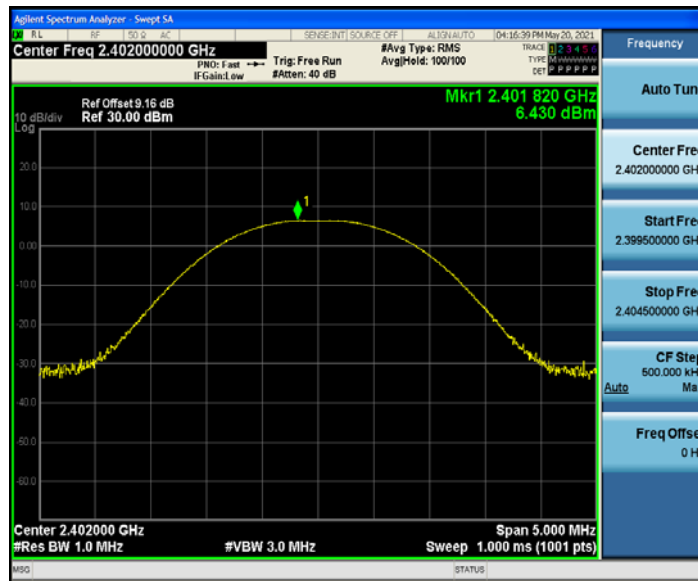

GFSK Middle Channel

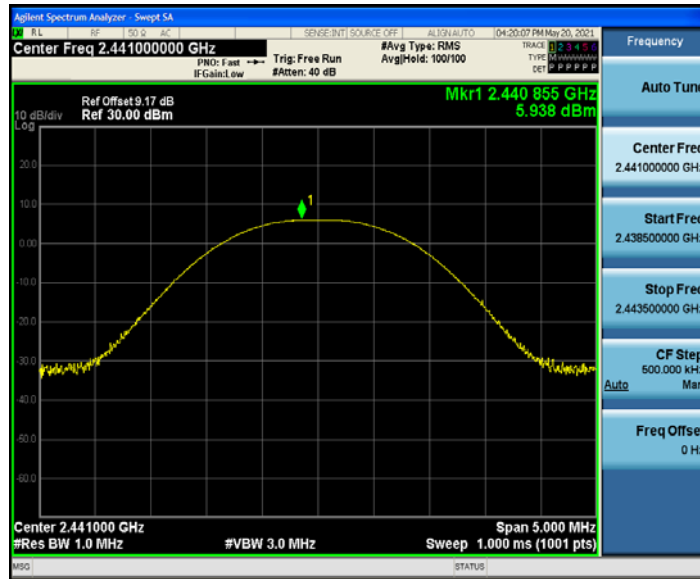

GFSK High Channel

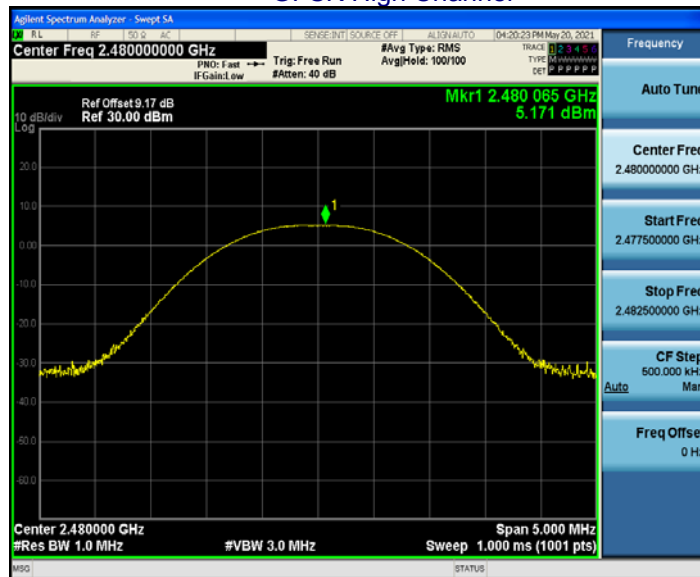

$\pi/4$ -DQPSK Low Channel

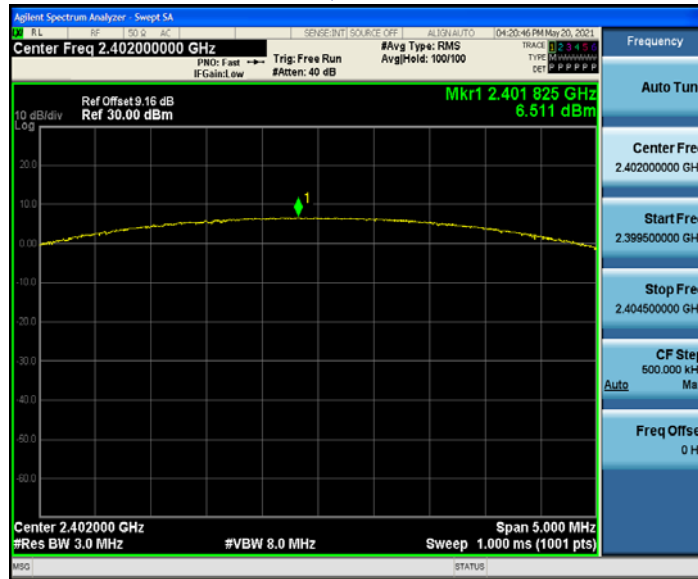

$\pi/4$ -DQPSK Middle Channel

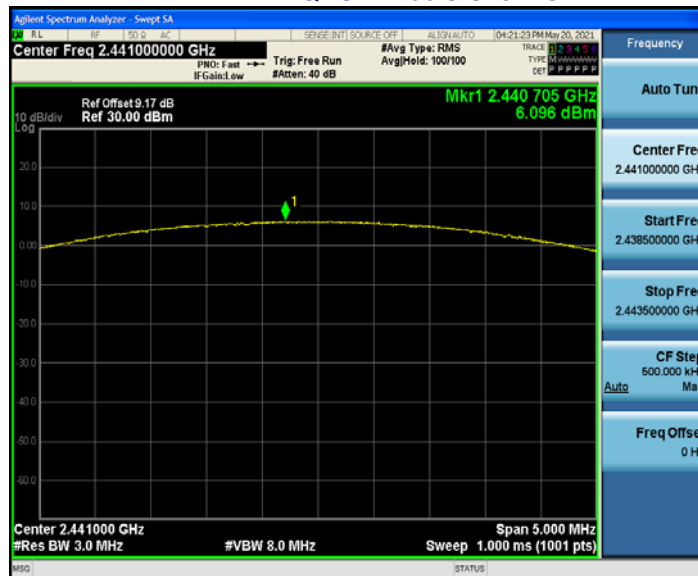

$\pi/4$ -DQPSK High Channel

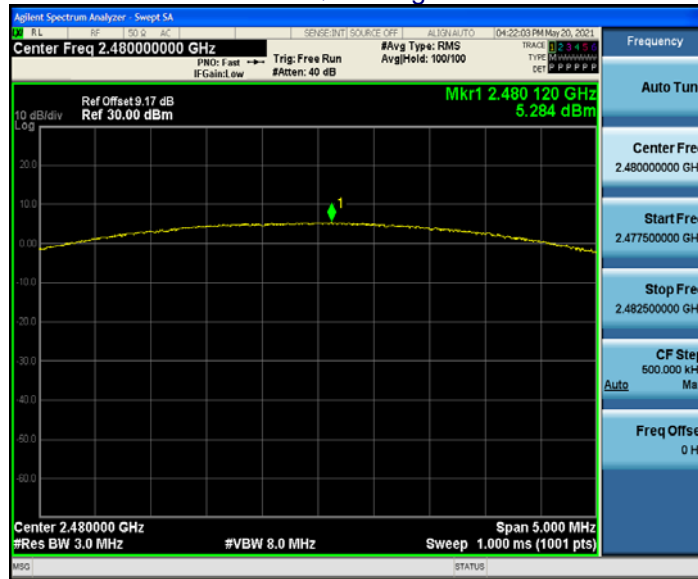

9. HOPPING CHANNEL SEPARATION

Test Requirement:	FCC Part15 C Section 15.247 (a)(1)
Test Method:	ANSI C63.10:2013
Receiver setup:	RBW=100KHz, VBW=300KHz, detector=Peak
Limit:	GFSK: 20dB bandwidth $\pi/4$ -DQPSK & 8DSK: 0.025MHz or 2/3 of the 20dB bandwidth (whichever is greater)

9.1 Test Setup

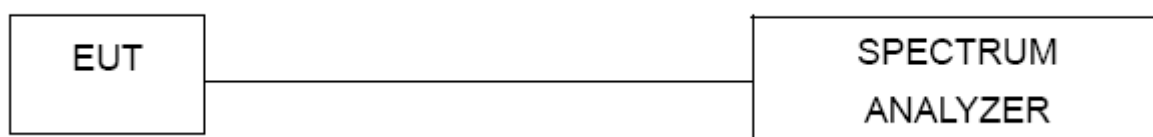

9.2 Test procedure

1. Remove the antenna from the EUT and then connect a low RF cable from the antenna port to the spectrum.
2. Set the spectrum analyzer: RBW = 100kHz. VBW = 300kHz , Span = 3.0MHz. Sweep = auto; Detector Function = Peak. Trace = Max hold.
3. Allow the trace to stabilize. Use the marker-delta function to determine the separation between the peaks of the adjacent channels. The limit is specified in one of the subparagraphs of this Section Submit this plot.

9.3 DEVIATION FROM STANDARD

No deviation.

9.4 Test Result

Modulation	Test Channel	Separation (MHz)	Limit(MHz)	Result
GFSK	Low	0.998	0.614	PASS
GFSK	Middle	1.002	0.639	PASS
GFSK	High	1.002	0.622	PASS
$\pi/4$ -DQPSK	Low	1.002	0.820	PASS
$\pi/4$ -DQPSK	Middle	1.000	0.848	PASS
$\pi/4$ -DQPSK	High	1.002	0.817	PASS

Test plots
GFSK Low Channel



GFSK Middle Channel

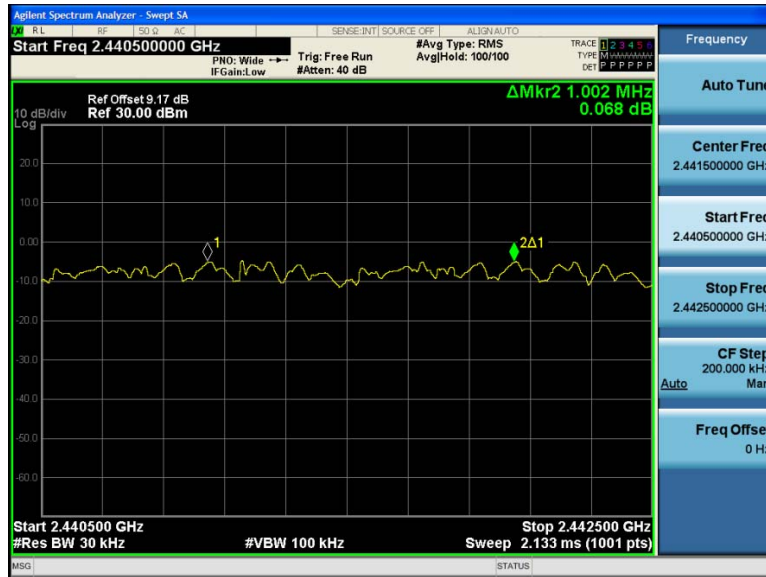

GFSK High Channel



$\pi/4$ -DQPSK Low Channel



$\pi/4$ -DQPSK Middle Channel

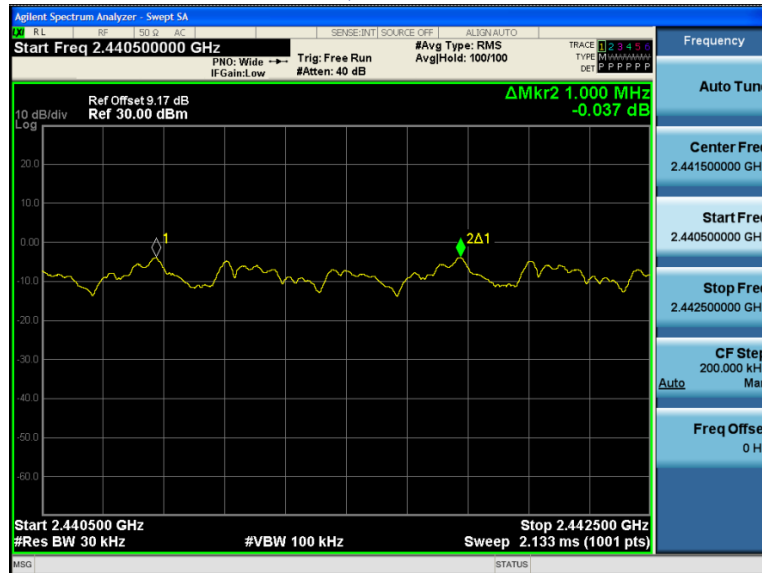

$\pi/4$ -DQPSK High Channel

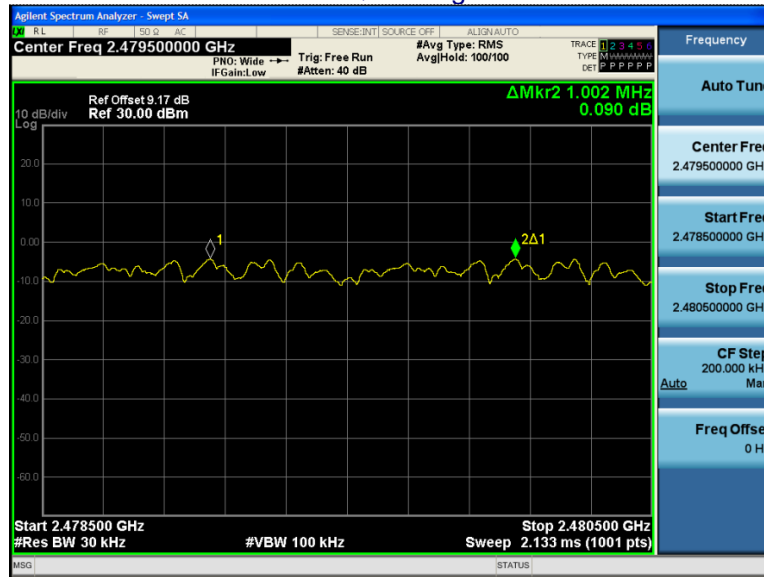

10. NUMBER OF HOPPING FREQUENCY

Test Requirement:	FCC Part15 C Section 15.247 (a)(1)(iii)
Test Method:	ANSI C63.10:2013
Receiver setup:	RBW=100kHz, VBW=300kHz, Frequency range=2400MHz-2483.5MHz, Detector=Peak
Limit:	15 channels

10.1 Test Setup



10.2 Test procedure

1. Remove the antenna from the EUT and then connect a low RF cable from the antenna port to the spectrum.
2. Set the spectrum analyzer: RBW = 100kHz. VBW = 300kHz. Sweep = auto; Detector Function = Peak. Trace = Max hold.
3. Allow the trace to stabilize. It may prove necessary to break the span up to sections. in order to clearly show all of the hopping frequencies. The limit is specified in one of the subparagraphs of this Section.
4. Set the spectrum analyzer: Start Frequency = 2.4GHz, Stop Frequency = 2.4835GHz. Sweep=auto;

10.3 DEVIATION FROM STANDARD

No deviation.

10.4 Test Result

Test Plots:
79 Channels in total
GFSK

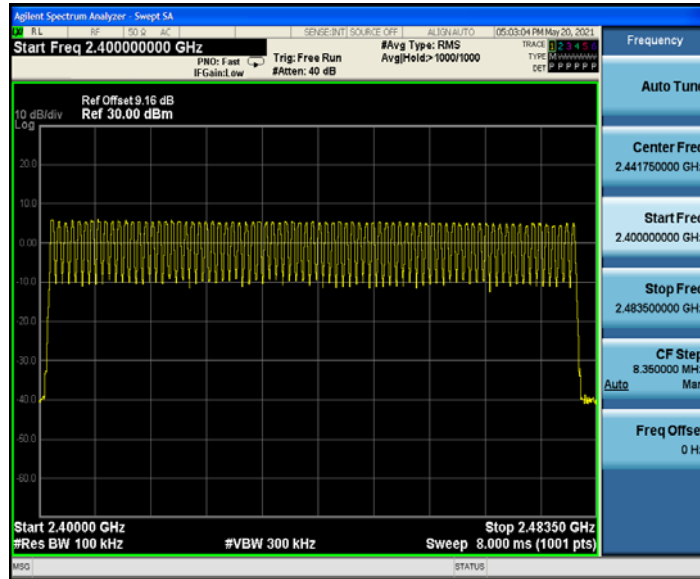

$\pi/4$ -DQPSK

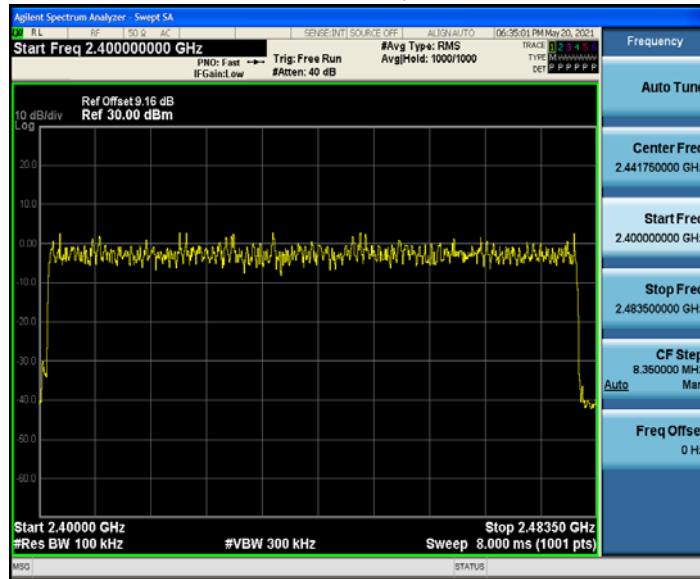

11. DWELL TIME

Test Requirement:	FCC Part15 C Section 15.247 (a)(1)(iii)
Test Method:	ANSI C63.10:2013
Receiver setup:	RBW=1MHz, VBW=3MHz, Span=0Hz, Detector=Peak
Limit:	0.4 Second

11.1 Test Setup



11.2 Test procedure

1. Remove the antenna from the EUT and then connect a low RF cable from the antenna port to the spectrum.
2. Set spectrum analyzer span = 0Hz;
3. Set RBW = 1MHz and VBW = 3MHz. Sweep = as necessary to capture the entire dwell time per hopping channel. Set the EUT for DH5, DH3 and DH1 packet transmitting.
4. Use the marker-delta function to determine the dwell time. If this value varies with different modes of operation (e.g.. data rate. modulation format. etc.). repeat this test for each variation. The limit is specified in one of the subparagraphs of this Section. Submit this plot(s).

11.3 DEVIATION FROM STANDARD

No deviation.

11.4 Test Result

GFSK mode:

Frequency	Packet	Dwell time(ms)	Limit(ms)	Result
2441MHz	DH1	124.48	400	Pass
2441MHz	DH3	263.04	400	Pass
2441MHz	DH5	308.48	400	Pass

Remarks:

The test period: $T = 0.4 \text{ Second/Channel} \times 79 \text{ Channel} = 31.6 \text{ s}$

Test channel: 2441MHz as blow

DH1 time slot = $0.369(\text{ms}) \times (1600 / (2 \times 79)) \times 31.6 = 124.48\text{ms}$

DH3 time slot = $1.625(\text{ms}) \times (1600 / (4 \times 79)) \times 31.6 = 263.04\text{ms}$

DH5 time slot = $2.874(\text{ms}) \times (1600 / (6 \times 79)) \times 31.6 = 308.48\text{ms}$

$\pi/4$ -DQPSK mode:

Frequency	Packet	Dwell time(ms)	Limit(ms)	Result
2441MHz	2DH1	127.68	400	Pass
2441MHz	2DH3	263.84	400	Pass
2441MHz	2DH5	308.80	400	Pass

Remarks:

The test period: $T = 0.4 \text{ Second/Channel} \times 79 \text{ Channel} = 31.6 \text{ s}$

Test channel: 2441MHz as blow

DH1 time slot = $0.378(\text{ms}) \times (1600 / (2 \times 79)) \times 31.6 = 127.68\text{ms}$

DH3 time slot = $1.649(\text{ms}) \times (1600 / (4 \times 79)) \times 31.6 = 263.84\text{ms}$

DH5 time slot = $2.874(\text{ms}) \times (1600 / (6 \times 79)) \times 31.6 = 308.80\text{ms}$

Test Plots

GFSK DH1

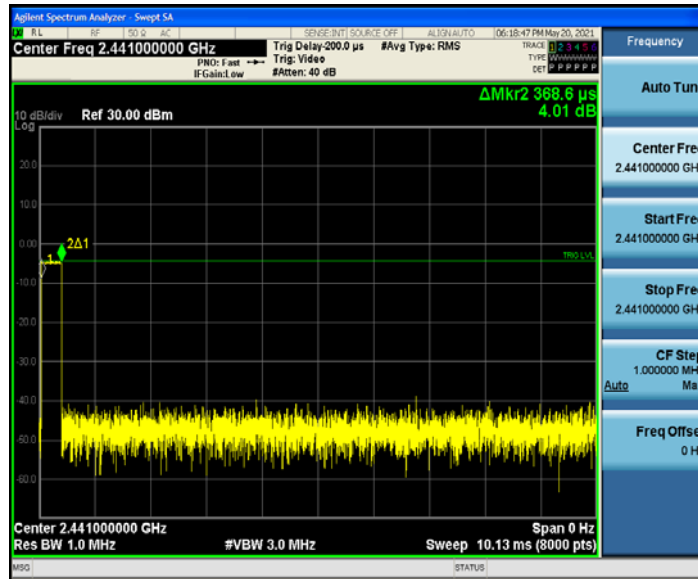

GFSK DH3

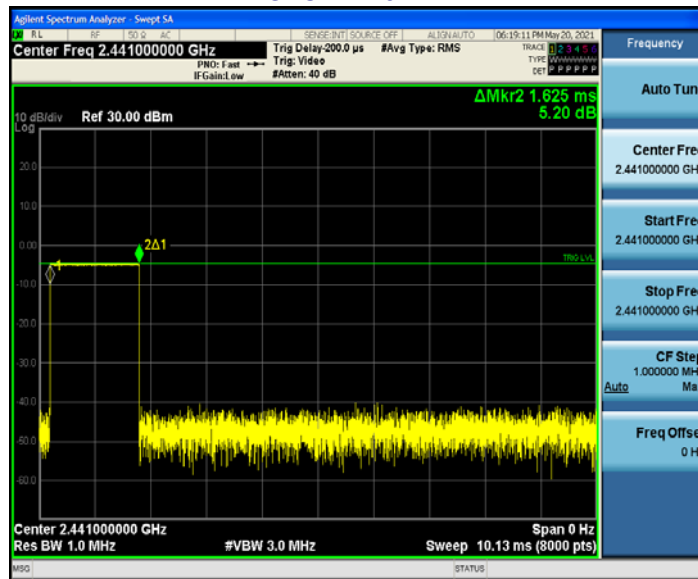

GFSK DH5

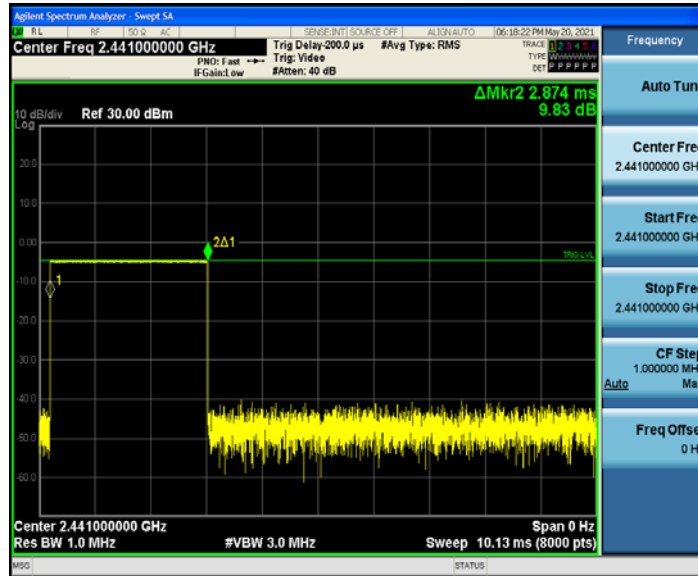

$\pi/4$ -DQPSK DH1

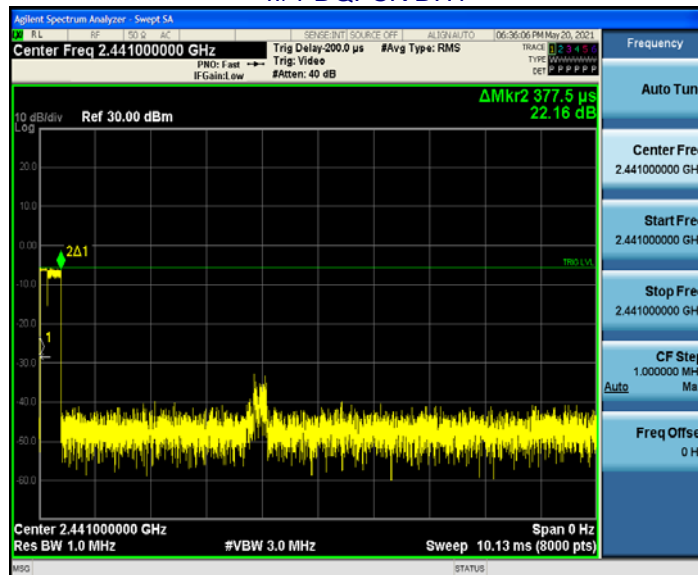

$\pi/4$ -DQPSK DH3

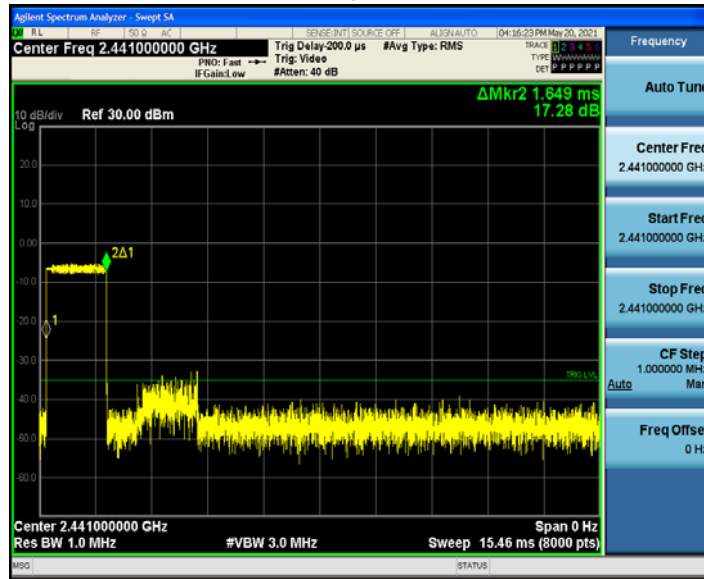

$\pi/4$ -DQPSK DH5

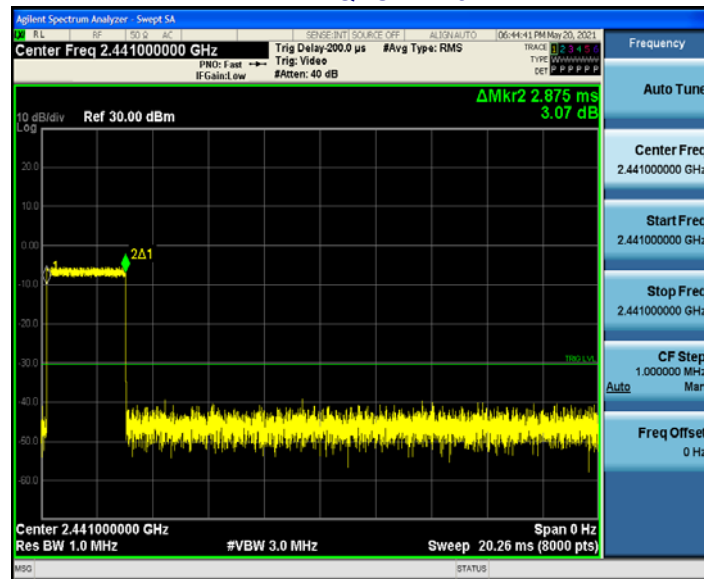

12. Antenna Requirement

Standard requirement:	FCC Part15 C Section 15.203 /247(c)
15.203 requirement: An intentional radiator shall be designed to ensure that no antenna other than that furnished by the responsible party shall be used with the device. The use of a permanently attached antenna or of an antenna that uses a unique coupling to the intentional radiator, the manufacturer may design the unit so that a broken antenna can be replaced by the user, but the use of a standard antenna jack or electrical connector is prohibited.	
15.247(c) (1)(i) requirement: (i) Systems operating in the 2400-2483.5 MHz band that is used exclusively for fixed. Point-to-point operations may employ transmitting antennas with directional gain greater than 6dBi provided the maximum conducted output power of the intentional radiator is reduced by 1 dB for every 3 dB that the directional gain of the antenna exceeds 6dBi.	
EUT Antenna:	
The antenna is External antenna, the best case gain of the antennas is 0dBi, reference to the appendix II for details	

13. Test Setup Photo

Reference to the appendix I for details.

14. EUT Constructional Details

Reference to the appendix II for details.

***** END OF REPORT *****