



FCC TEST REPORT

FCC ID: 2AZ60-C800

Equipment : Wireless Intercom System
Brand Name : Chtoocy
Test Model : C800
Series Model : N/A
Applicant : Shenzhen Weiguo Times Technology Co.,Ltd
Address : 8th Floor,Block C, Wanguo City Pingji Avenue, Nanwan Street,
Longgang District Shenzhen 518000 China
Manufacturer : Shenzhen Todakj Co., Ltd.
Address : No. 40 Huan Dong Road, Tie Gang Industrial District,
Baoan,Shenzhen,China
Date of Receipt : 2022.11-23
Date of Test : 2022.11-23-2022.12-19
Issued Date : 2022.12-19
Report Version : V1.0
Test Sample : Engineering Sample No.: AIT22112201-1
Standard(s) : FCC Part 15 Rules

Lab: Dongguan Yaxu (AiT) Technology Limited

Add: No.22, Jinqianling 3rd Street, Jitigang, Huangjiang,Dongguan,
Guangdong, China

Tel.: +86-769-8202 0499 Fax.: +86-769-8202 0495

This device described above has been tested by Dongguan Yaxu (AiT) Technology Limited and the test results show that the equipment under test (EUT) is in compliance with the FCC requirements. And it is applicable only to the tested sample identified in the report.

Note: This report shall not be reproduced except in full, without the written approval of Dongguan Yaxu (AiT) Technology Limited, this document may be altered or revised by Dongguan Yaxu (AiT) Technology Limited, personal only, and shall be noted in the revision of the document. This test report must not be used by the client to claim product endorsement.

Reviewed by: Simba Huang
Simba huang

Approved by: Seal Chen
Seal Chen



REPORT REVISE RECORD

Report Version	Revise Time	Issued Date	Valid Version	Notes
V1.0	/	200-12-19	Valid	Initial Release

TABLE OF CONTENTS

1. PRODUCT INFORMATION	4
2.IDENTIFICATION OF THE RESPONSIBLE TESTING LOCATION.....	5
3.LIST OF TEST EQUIPMENT:.....	6
4. SUPPORT EQUIPMENT LIST.....	7
5. SYSTEM DESCRIPTION.....	7
6. MEASUREMENT UNCERTAINTY.....	8
7. SUMMARY OF TEST RESULTS.....	8
8. FCC RADIATED EMISSION TEST.....	9
8.1 PROVISIONS APPLICABLE.....	9
8.2 TEST SETUP BLOCK DIAGRAM.....	9
8.3 TEST PROCEDURE.....	11
8.4 TEST RESULT.....	12
9. FCC CONDUCTED EMISSION TEST.....	15
9.1 PROVISIONS APPLICABLE.....	15
9.2 TEST SETUP BLOCK DIAGRAM.....	15
9.4 TEST RESULT.....	17
10. RADIATION SPURIOUS EMISSIONS FOR RECEIVERS.....	19
10.1 LIMIT.....	19
THE ANTENNA POWER OF THE RECEIVER AS DEFINED IN § 15.111 SHALL NOT EXCEED THE VALUES GIVEN IN THE FOLLOWING TABLES.....	19
10.1 TEST PROCEDURE.....	19
10.2 TEST SETUP BLOCK DIAGRAM.....	20
10.3 TEST SETUP BLOCK DIAGRAM.....	21
10. RADIATION SPURIOUS EMISSIONS FOR RECEIVERS.....	22
10.3 LIMIT.....	22
10.3 TEST SETUP.....	22
10.3 TEST PROCEDURE.....	22
10.3 TEST RESULT.....	22

1. PRODUCT INFORMATION

The EUT is a **Two-way radio** designed for voice communication. It is designed by way of utilizing the FM modulation achieves the system operating.

A major technical description of EUT is described as following:

Hardware Version	N/A
Software Version	N/A
Communication Type	Voice / Tone only
Operation Frequency Range	462.5625 - 462.7125MHz (1~7 channel)
	467.5625 - 467.7125MHz (8~14 channel)
	462.5500 - 462.7250MHz (15~22 channel)
Modulation Type	FM
Channel Separation	12.5 KHz
Emission Bandwidth	10.44 KHz
Emission Designator	10K4F3E
Number of Channels:	22 Channels
Rated Output Power	01119W/0.086W (It was fixed by the manufacturer, any individual can't arbitrarily change it.)
Maximum Transmitter Power	FRS:20.49dBm(2W-12.5KHz) FRS: 19.59dBm (0.5W-12.5KHz)
Antenna Designation	Inseparable
Antenna Gain	1.0dBi
Frequency Tolerance	1.011ppm

2.IDENTIFICATION OF THE RESPONSIBLE TESTING LOCATION

The test facility is recognized, certified, or accredited by the following organizations:

CNAS- Registration No: L6177

Dongguan Yaxu (AiT) technology Limited is accredited to ISO/IEC 17025:2017 general Requirements for the competence of testing and calibration laboratories (CNAS-CL01 Accreditation Criteria for the competence of testing and calibration laboratories) on April 17, 2022

FCC-Registration No.: 703111 Designation Number: CN1313

Dongguan Yaxu (AiT) technology Limited has been registered and fully described in a report filed with the (FCC) Federal Communications Commission. The acceptance letter from the FCC is maintained in our files.

IC —Registration No.: 6819A CAB identifier: CN0122

The 3m Semi-anechoic chamber of Dongguan Yaxu (AiT) technology Limited has been registered by Certification and Engineering Bureau of Industry Canada for radio equipment testing with Registration No.: 6819A

A2LA-Lab Cert. No.: 6317.01

Dongguan Yaxu (AiT) technology Limited has been accredited by A2LA for technical competence in the field of electrical testing, and proved to be in compliance with ISO/IEC 17025: 2017 General Requirements for the Competence of Testing and Calibration Laboratories and any additional program requirements in the identified field of testing.

3.List of Test Equipment:

TEST EQUIPMENT OF CONDUCTED EMISSION TEST

Equipment	Manufacturer	Model	S/N	Cal. Date	Cal. Due
EMI Test Receiver	R&S	ESCI	100124	2022.09.02	2023.09.01
LISN	Kyoritsu	KNW-242	8-837-4	2022.09.02	2023.09.01
LISN	Kyoritsu	KNW-407	8-1789-3	2022.09.02	2023.09.01
50Ω Coaxial Switch	Anritsu	MP59B	6200264417	2022.09.02	2023.09.01

TEST EQUIPMENT OF RADIATED EMISSION TEST

Equipment	Manufacturer	Model	S/N	Cal. Date	Cal. Due
EMI Measuring Receiver	R&S	ESR	101160	2022.09.02	2023.09.01
Low Noise Pre Amplifier	HP	HP8447E	1205323	2022.09.02	2023.09.01
TRILOG Super Broadband test Antenna	SCHWARZBECK	VULB9160	9160-3206	2021.08.29	2024.08.28
50Ω Coaxial Switch	Anritsu	MP59B	6200264416	2022.09.02	2023.09.01
Spectrum Analyzer	R&S	FSV40	101470	2021.0.8.30	2023.09.01
Low Noise Pre Amplifier	Tsj	MLA-0120-A02-34	2648A04738	2022.09.02	2023.09.01
Broadband Horn Antenna	Schwarzbeck	BBHA 9120D	452	2021.08.29	2024.08.28
Aglient	N9020A	M785556H02	21033028	2022.09.02	2023.09.01

4. SUPPORT EQUIPMENT LIST

Device Type	Manufacturer	Model Name	Serial No.	Data Cable	Power Cable
Adapter	--	--	-	-	DC 4.5V
Back clip	-	-	-	-	-
USB Cable	-	-	-	-	-
Lanyard	-	-	-	-	-

5. SYSTEM DESCRIPTION

EUT TEST PROCEDURE:

1. Connect EUT and peripheral devices.
2. Power on the EUT, the EUT begins to work.
3. Make sure the EUT normal working.

EMC TEST MODE:

No.	TEST MODES
1	Scanning Mode
2	Scanning Receiving Mode at FRS TX CHANNEL 4
3	Scanning Receiving Mode at FRS TX CHANNEL 11
4	Scanning Receiving Mode at FRS TX CHANNEL 19

Note: Only the result of the worst case-Mode2 was recorded in the report.

6. MEASUREMENT UNCERTAINTY

The uncertainty is calculated using the methods suggested in the “Guide to the Expression of Uncertainty in measurement” (GUM) published by CISPR and ANSI.

No.	Item	Frequency Range	U , Value
1	Power Line Conducted Emission	150KHz~30MHz	1.20 dB
2	Radiated Emission Test	30MHz~1GHz	3.75 dB
3	Radiated Emission Test	1GHz~6GHz	3.88 dB

7. SUMMARY OF TEST RESULTS

FCC RULES	DESCRIPTION OF TEST	RESULT
§15.107	Conduction Emission	Compliant
§15.109	Radiated Emission	Compliant
§15.121(b)	Scanning receivers and frequency converters used with scanning receivers	Compliant
§15.111	Antenna Conducted Power for receivers	Compliant

8. FCC RADIATED EMISSION TEST

8.1 PROVISIONS APPLICABLE

FCC CFR Title 47 Part 15 Subpart B Section 15.109:

Frequency	Limit (dBuV/m @3m)	Value
30MHz-88MHz	40.00	Quasi-peak
88MHz-216MHz	43.50	Quasi-peak
216MHz-960MHz	46.00	Quasi-peak
960MHz-1GHz	54.00	Quasi-peak
Above 1GHz	54.00	Average
	74.00	Peak

Note: The lower limit shall apply at the transition frequency. Because the EUT RX frequency range up to 480 MHz, so the upper the frequency range up to 2 GHz.

8.2 TEST SETUP BLOCK DIAGRAM

RADIATED EMISSION TEST SETUP 30MHz-1000MHz

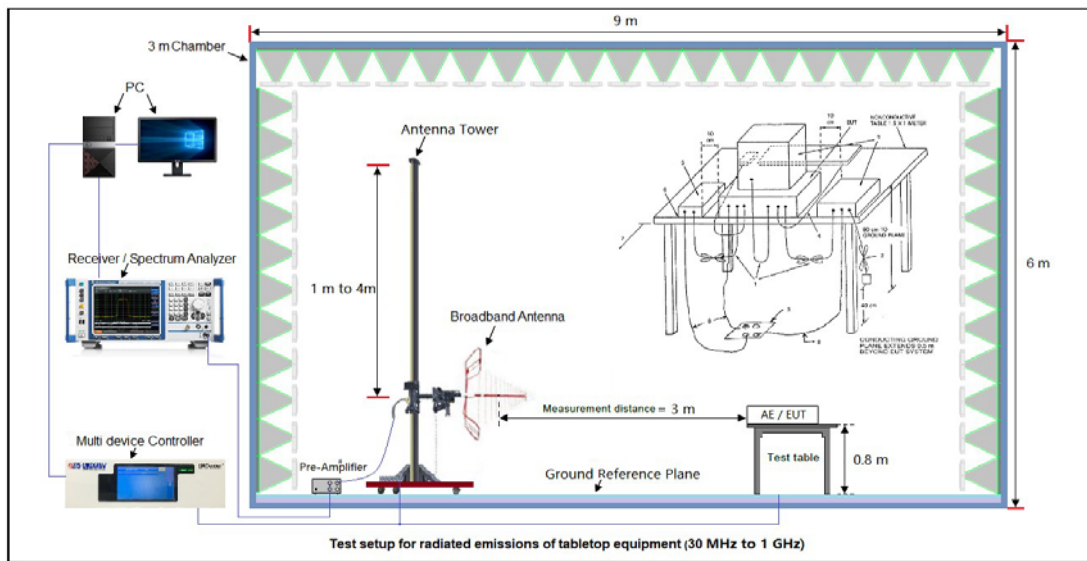

RADIATED EMISSION TEST SETUP ABOVE 1000MHz

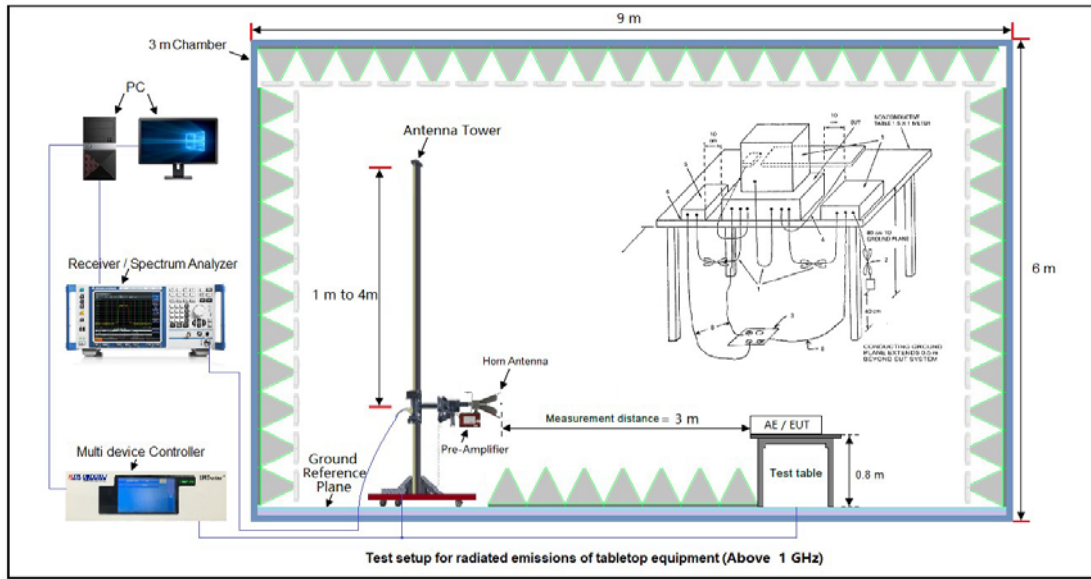

EMI TEST RECEIVER SETUP:

During the radiated emission test, the EMI test receiver was set with the following configurations:

Frequency Range	RBW	Video B/W	IF B/W	Measurement
30 MHz – 1000 MHz	100 kHz	300 kHz	120 kHz	QP
Above 1 GHz	1MHz	3 MHz	/	PK
	1MHz	10 Hz	/	Ave.

8.3 TEST PROCEDURE

1. The equipment was set up as per the test configuration to simulate typical actual usage per the user's manual. When the EUT is a tabletop system, a wooden turntable with a height of 0.8 meters is used which is placed on the ground plane as per ANSI C63.4 (see Test Facility for the dimensions of the ground plane used). When the EUT is floor-standing equipment, it is placed on the ground plane which has a 3-12 mm non-conductive covering to insulate the EUT from the ground plane.
2. Support equipment, if needed, was placed as per ANSI C63.4.
3. All I/O cables were positioned to simulate typical actual usage as per ANSI C63.4.
4. The EUT received power by AC 120V/60Hz.
5. The antenna was placed at 3 meter away from the EUT as stated in FCC Part 15. The antenna connected to the Analyzer via a cable and at times a pre-amplifier would be used.
6. The Analyzer / Receiver quickly scanned from 30MHz to 1000MHz. The EUT test program was started. Emissions were scanned and measured rotating the EUT to 360 degrees and positioning the antenna 1 to 4 meters above the ground plane, in both the vertical and the horizontal polarization, to maximize the emission reading level.
7. The test mode(s) were scanned during the test:
8. Recorded at least the six highest emissions. Emission frequency, amplitude, antenna position, polarization and turntable position were recorded into a computer in which correction factors were used to calculate the emission level and compare reading to the applicable limit and Q.P./Peak reading is presented. For emissions below 1GHz, use 120KHz RBW and VBW \geq 3RBW for QP reading.
9. For emissions above 1GHz, use 1MHz RBW and 3MHz VBW for peak reading. Then 1MHz RBW and 10Hz VBW for average reading in spectrum analyzer.
10. When the radiated emissions limits are expressed in terms of the average value of the emissions, and pulsed operation is employed, the measurement field strength shall be determined by averaging over one complete pulse train, including blanking intervals, as long as the pulse train does not exceed 0.1 seconds. As an alternative (provided the transmitter operates for longer than 0.1 seconds) or in cases where the pulse train exceeds 0.1 seconds, the measured field strength shall be determined from the average absolute voltage during a 0.1 second interval during which the field strength is at its maximum values.
11. If the emissions level of the EUT in peak mode was 3 dB lower than the average limit specified, then testing will be stopped and peak values of EUT will be reported, otherwise, the emissions which do not have 3 dB margin will be repeated one by one using the quasi-peak method for below 1GHz.
12. For testing above 1GHz, the emissions level of the EUT in peak mode was lower than average limit (that means the emissions level in peak mode also complies with the limit in average mode), then testing will be stopped and peak values of EUT will be reported, otherwise, the emissions will be measured in average mode again and reported.
13. In case the emission is lower than 30MHz, loop antenna has to be used for measurement and the recorded data should be QP measured by receiver. High - Low scan is not required in this case.

14. The test data of the worst case condition (mode 1) was reported on the following Data page.

8.4 TEST RESULT

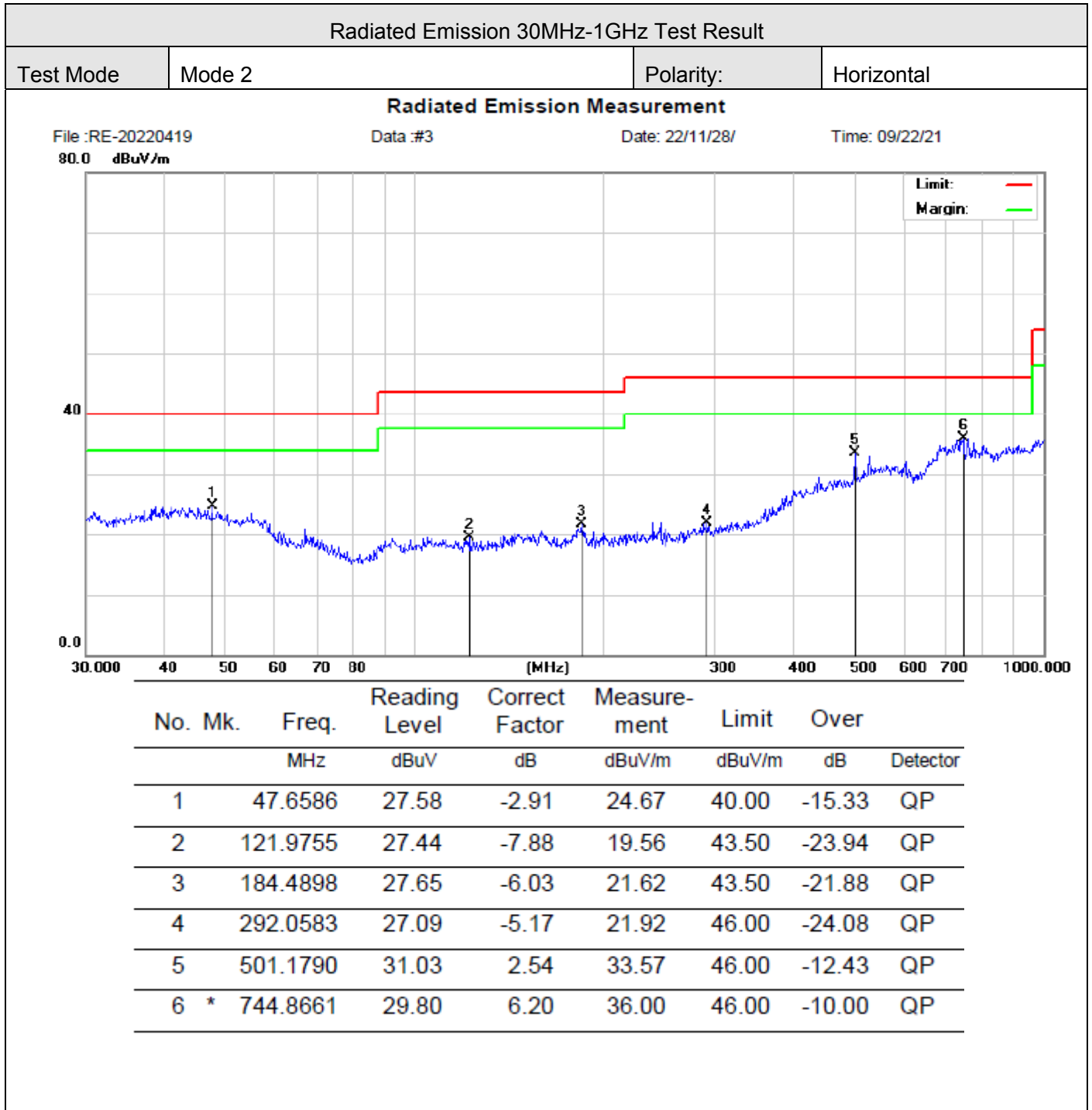

RESULT: PASS

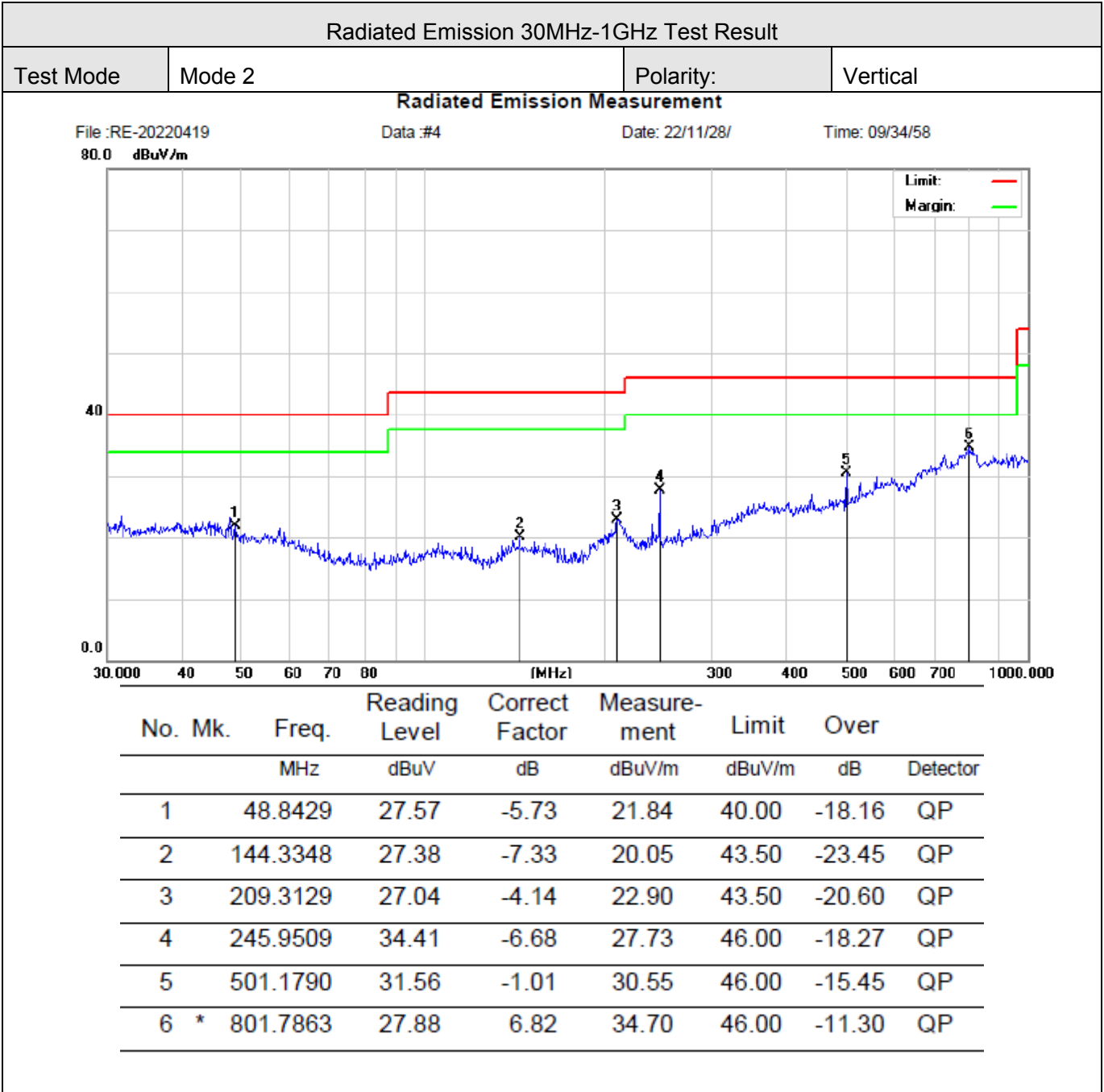

RESULT: PASS

Radiated Emission Above1GHz Test Result								
Test Mode	Mode 2				Polarity:	Horizontal		
NO.	Freq. [MHz]	Level [dB μ V/m]	Factor [dB]	Limit [dB μ V/m]	[dB]	Height [cm]	Angle [°]	Polarity
1	1096.0096	38.19	-16.73	74.00	35.81	100	320	Horizontal
2	2028.6029	42.01	-11.70	74.00	31.99	100	180	Horizontal
3	2565.6566	43.41	-9.67	74.00	30.59	100	170	Horizontal
4	3470.247	44.79	-7.70	74.00	29.21	100	220	Horizontal
5	4167.8168	45.65	-6.06	74.00	28.35	100	280	Horizontal
6	5719.972	46.28	-4.59	74.00	27.72	100	340	Horizontal

RESULT: PASS

Radiated Emission Above1GHz Test Result								
Test Mode	Mode 2				Polarity:	Vertical		
NO.	Freq. [MHz]	Level [dB μ V/m]	Factor [dB]	Limit [dB μ V/m]	Margin [dB]	Height [cm]	Angle [°]	Polarity
1	1097.5098	38.11	-16.74	74.00	35.89	100	160	Vertical
2	2043.1043	41.92	-11.64	74.00	32.08	100	220	Vertical
3	2643.6644	44.08	-9.61	74.00	29.92	100	240	Vertical
4	3708.7709	45.13	-7.14	74.00	28.87	100	310	Vertical
5	4796.3796	46.46	-4.92	74.00	27.54	100	340	Vertical
6	5716.9717	45.95	-4.60	74.00	28.05	100	310	Vertical

RESULT: PASS

Note: 1. Factor=Antenna Factor + Cable loss - Amplifier gain, Margin= Limit-Measurement.

2. The "Factor" value can be calculated automatically by software of measurement system.

9. FCC CONDUCTED EMISSION TEST

9.1 PROVISIONS APPLICABLE

For an intentional radiator that is designed to be connected to the public utility (AC) power line, the radio frequency voltage that is conducted back onto the AC power line on any frequencies within the band 150 KHz to 30 MHz shall not exceed the limits in the following table, as measured using a 50uH/50 ohms line impedance stabilization network (LISN). Compliance with the provisions of this paragraph shall be based on the measurement of the radio frequency voltage between each power line and ground at the power terminal. The lower limit applies at the boundary between the frequencies ranges.

Frequency of Emission (MHz)	Conducted Limit(dBuV)	
	Quasi-Peak	Average
0.15 – 0.5	66 to 56 *	56 to 46 *
0.5 – 5	56	46
5 – 30	60	50

* Decreases with the logarithm of the frequency.

9.2 TEST SETUP BLOCK DIAGRAM

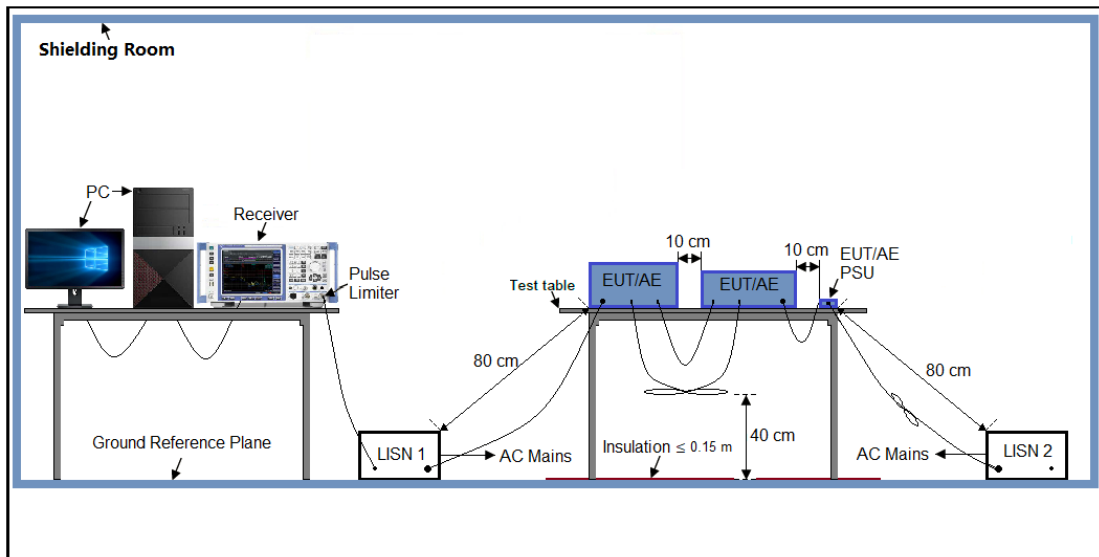

9.3 TEST PROCEDURE

1. The equipment was set up as per the test configuration to simulate typical actual usage per the user's manual. When the EUT is a tabletop system, a wooden table with a height of 0.8 meters is used and is placed on the ground plane as per ANSI C63.4 (see Test Facility for the dimensions of the ground plane used). When the EUT is a floor-standing equipment, it is placed on the ground plane which has a 3-12 mm non-conductive covering to insulate the EUT from the ground plane.
2. Support equipment, if needed, was placed as per ANSI C63.4.
3. All I/O cables were positioned to simulate typical actual usage as per ANSI C63.4.
4. The EUT received AC 120V/60Hz power through a Line Impedance Stabilization Network (LISN) which supplied power source and was grounded to the ground plane.
5. All support equipments received AC power from a second LISN, if any.
6. The EUT test program was started. Emissions were measured on each current carrying line of the EUT using a spectrum Analyzer / Receiver connected to the LISN powering the EUT. The LISN has two monitoring points: Line 1 (Hot Side) and Line 2 (Neutral Side). Two scans were taken: one with Line 1 connected to Analyzer / Receiver and Line 2 connected to a 50 ohm load; the second scan had Line 1 connected to a 50 ohm load and Line 2 connected to the Analyzer / Receiver.
7. Analyzer / Receiver scanned from 150 KHz to 30MHz for emissions in each of the test modes.
8. During the above scans, the emissions were maximized by cable manipulation.
9. The test data of the worst case condition (mode 1) was reported on the following Data page.

9.4 TEST RESULT

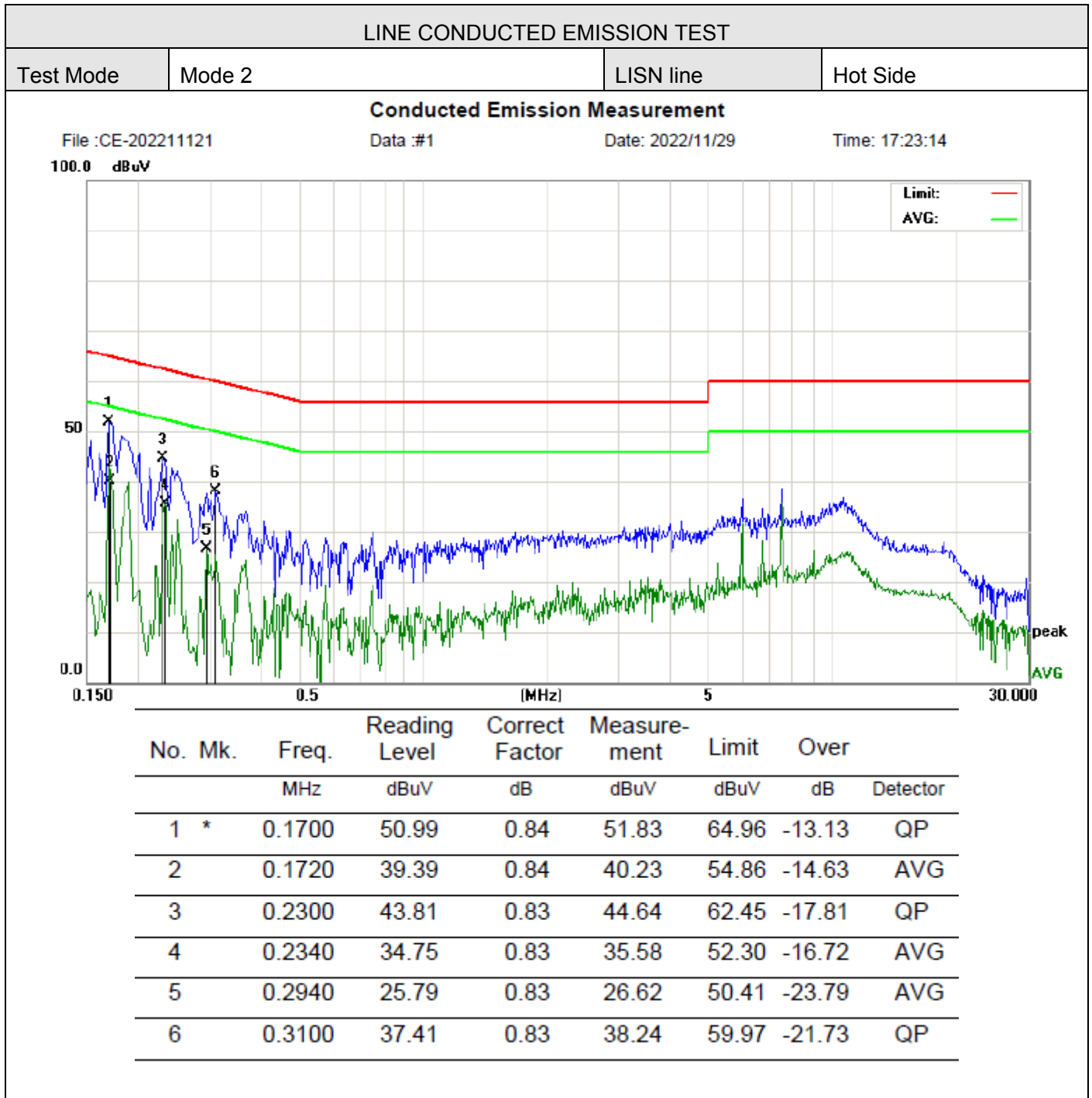

LINE CONDUCTED EMISSION TEST

Test Mode Mode 2 LISN line Neutral Side

Conducted Emission Measurement

File : CE-202211121

Data #2

Date: 2022/11/29

Time: 17:24:39

100.0 dBuV

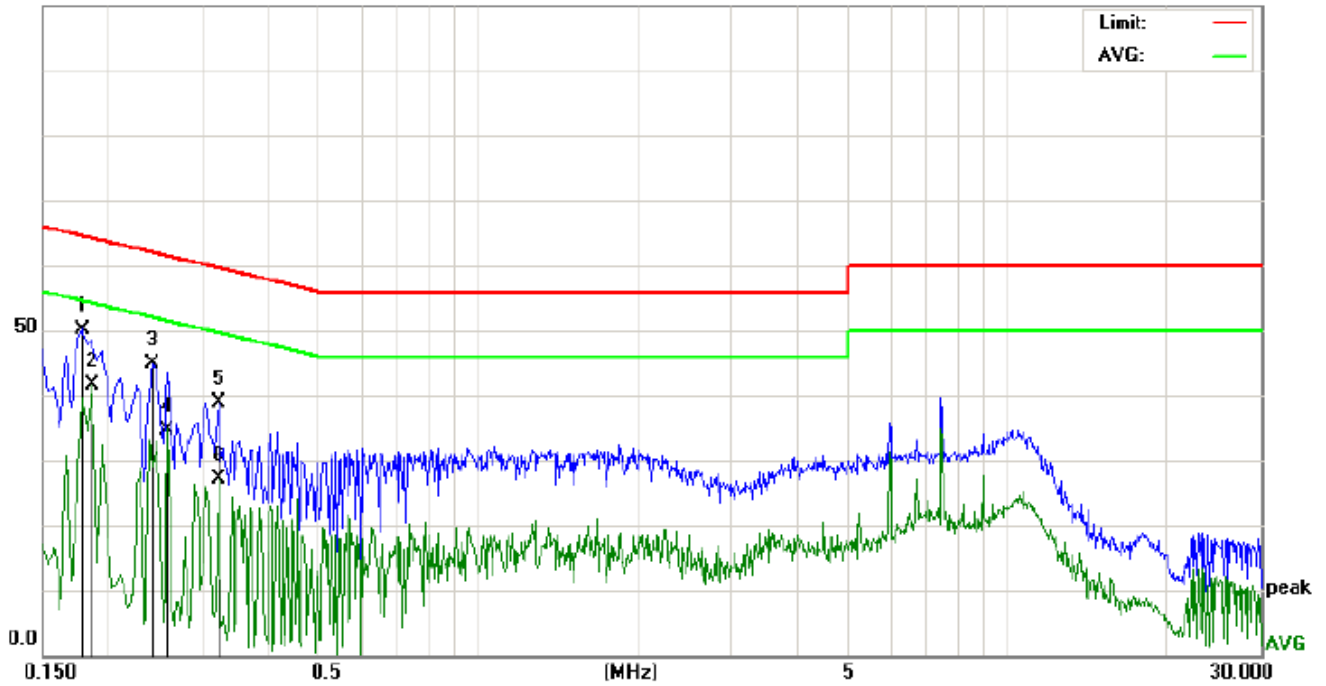

No.	Mk.	Freq. MHz	Reading Level dBuV	Correct Factor dB	Measure- ment dBuV	Limit dBuV	Over dB	Detector
1		0.1780	49.41	0.84	50.25	64.57	-14.32	QP
2	*	0.1860	40.67	0.84	41.51	54.21	-12.70	AVG
3		0.2420	44.07	0.83	44.90	62.02	-17.12	QP
4		0.2580	33.92	0.83	34.75	51.49	-16.74	AVG
5		0.3220	38.05	0.83	38.88	59.65	-20.77	QP
6		0.3220	26.34	0.83	27.17	49.65	-22.48	AVG

10. Radiation Spurious Emissions FOR RECEIVERS

10.1 Limit

The antenna power of the receiver as defined in §15.111 shall not exceed the values given in the following tables

Frequency Range	9 KHz to 2GHz
Limit	2.0 nW (-57 dBm)

10.1 Test Procedure

1.EUT was placed on a 0.8 meter high non-conductive stand at a 3 meter test distance from the receive antenna. A receiving antenna was placed on the antenna mast 3 meters from the EUT for emission measurements. The height of receiving antenna is 1.0m. Detected emissions were maximized at each frequency by rotating the EUT through 360° and adjusting the receiving antenna polarization. The radiated emission measurements of all test transmit frequencies were measured with peak detector.

2.The EUT is then put into continuously transmitting mode at its maximum power level during the test. Set Test Receiver or Spectrum 100 kHz below 1GHz and 1MHz above 1GHz, Sweep from 30MHz to the 10th harmonic of the fundamental frequency; and recorded the level of the concerned spurious emission point as (Pr).

3.The EUT then replaced by a substitution antenna. In the chamber, an substitution antenna for the frequency band of interest is placed at the reference point of the chamber. An RF Signal source for the frequency band of interest is connected to the substitution antenna with a cable that has been constructed to not interfere with the radiation pattern of the antenna. A power (PMea) is applied to the input of the substitution antenna, and adjust the level of the signal generator output until the value of the receiver reach the previously recorded (Pr). The power of signal source (PMea) is recorded. The test should be performed by rotating the test item and adjusting the receiving antenna polarization.

The measurement results are obtained as described below:

$$\text{Power (EIRP)} = \text{PMea} - \text{Pcl} + \text{Ga}$$

Where;

PMea is the recorded signal generator level

Pcl is the cable loss connect between instruments

Ga Substitution Antenna Gain

e. This value is EIRP since the measurement is calibrated using an antenna of known gain (2.15 dBi) and known input power.

f. ERP can be calculated from EIRP by subtracting the gain of the dipole, $\text{ERP} = \text{EIRP} - 2.15\text{dBi}$.

g. Test site anechoic chamber refer to ANSI C63.

10.2 TEST SETUP BLOCK DIAGRAM

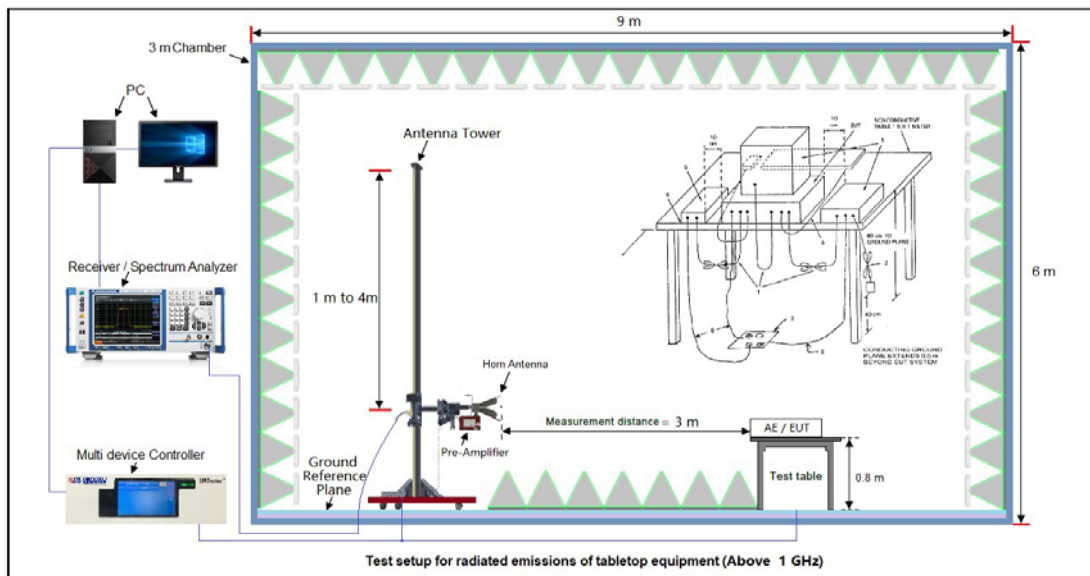
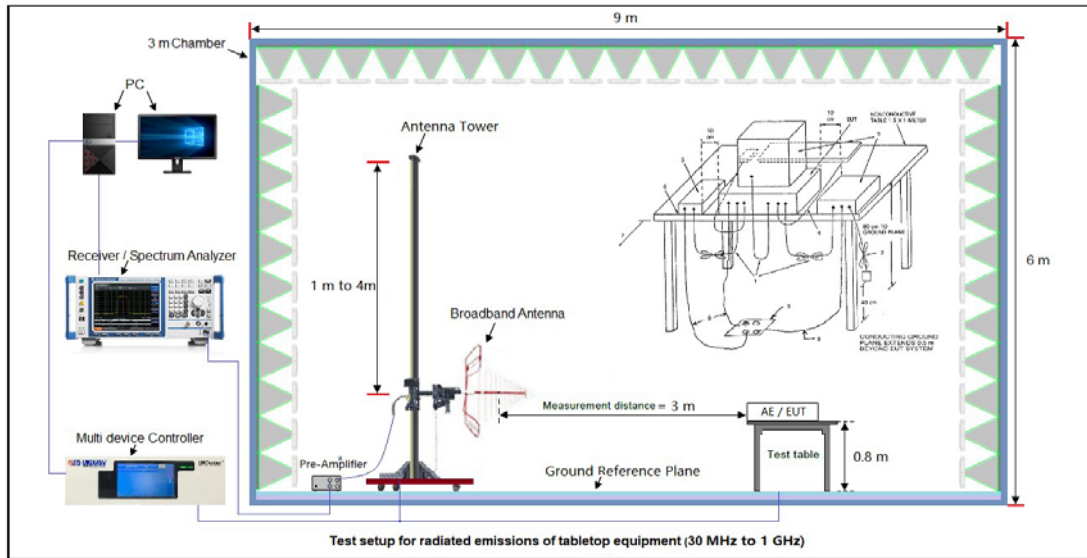

10.3 TEST SETUP BLOCK DIAGRAM

Maximum Frequency	Spurious Emission polarization and Level		Limit	Over Limit
	polarization	dBm	dBm	dB
37.358	Vertical	-73.74	-57.00	-16.74
200.089	Vertical	-70.84	-57.00	-13.84
461.567	Vertical	-67.27	-57.00	-10.27
50.603	Horizontal	-74.05	-57.00	-17.05
231.988	Horizontal	-67.61	-57.00	-10.61
606.500	Horizontal	-67.11	-57.00	-10.11

11. Radiation Spurious Emissions FOR RECEIVERS

11.1 LIMIT

Except as provided in paragraph (c) of this section, scanning receivers shall reject any signals from the Cellular Radiotelephone Service frequency bands that are 38 dB or lower based upon a 12 dB SINAD measurement, which is considered the threshold where a signal can be clearly discerned from any interference that may be present.

11.2 TEST SETUP

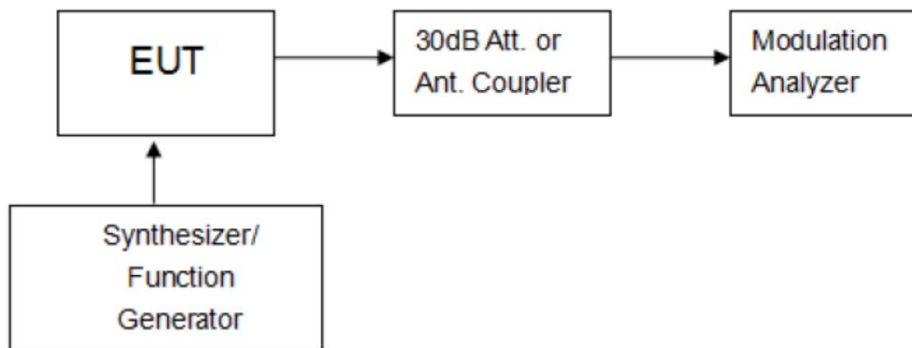

11.3 TEST PROCEDURE

Please review the FCC Part 15.121 b section requirements to meet the testing process

11.4 TEST RESULT

Modulation	Channel	Measurement Result (dB)	Over Limit	Result
FM	FRS TX CHANNEL 4	46.06	>38	PASS
	FRS TX CHANNEL 11	45.99	>38	PASS
	FRS TX CHANNEL 19	47.25	>38	PASS

-----END OF REPORT-----