



FULLJA

Digital Photo Frame

User Manual

1. Cautions

2. Precautions and maintenance

- For indoor use only.
- To avoid risk of fire or electric shock, do not expose the unit to moisture or condensation.
- To avoid overheating, do not block the ventilation holes on the back of the Digital Photo Frame.
- Keep the Digital Photo Frame out of direct sunlight.
- Always use the eject buttons on the memory storage card slots to remove the storage cards.
- Do not dismantle the Digital Photo Frame. There is a risk of electric shock and there are no user-serviceable parts inside. Dismantling the Digital Photo Frame will void your warranty.

Cleaning the LCD Screen

- Treat the screen carefully. Because the screen of the Digital Photo Frame is made of glass and it would easily be broken or scratched.
- If fingerprints or dust accumulate on the LCD screen, we recommend using a soft, non-abrasive cloth such as a camera lens cloth to clean the LCD screen.
- Moisten the cleaning cloth with the cleaning solution and apply the cloth to the screen.

WARNING:

Please power off the unit before inserting or removing a card or USB device.

Failure to do so may cause damage to the card/USB and the unit.

To reduce the risk of fire or electric shock, do not expose this appliance to rain or moisture.

3. introduction:

- Thank you for your purchase of the Digital Photo Frame. It is designed to allow quick and easy view of photos taken from your digital camera, mobile phone, or from a memory storage card.
- Please read this User Manual carefully to learn the correct way to use the Digital Photo Frame.

Features:

1. 9"(4:3) 1024x768 Pixels IPS Panel + Touch Screen
2. Android System with WIFI function Sharing Photos & Short video via APP/Email/PC Manager
3. 8GB Memory+ Weather Station+Stereo Speaker
4. Our Own R&D Software&Phone APP Supported by World Famous Cloud System
5. 10GB Online Cloud Storage
6. Support FHD 1080P Video Playback for Advertising
7. Newest Unique Design

Packaging Check List:

- | | | |
|----|---------------------|---------|
| 1. | digital photo frame | 1 piece |
| 2. | AC/DC adapter | 1 piece |
| 3. | USB Cable | 1 piece |
| 4. | User Manual | 1 piece |

Contents

Contents	3
1.Product Diagram	4
1.1 Bottom of the frame	4
2.Getting Started.	4
3.Email &Cloud Photo APP Operating Instruction	5
3.1 Connect Wi-Fi.	5
3.2 Download VPhoto APP	6
3.3 Link to Email, Cloud Frame APP	7
3.3.1 Email	7
3.3.2 VPhoto APP	7
4.General Operating Instruction	8
4.1 Pictures	9
4.2 Music	9
4.3 Videos	10
4.4 Clock	10
4.5 Calendar.....	11
4.6 Alarm	11
4.7 Weather	11
5. Settings	12
5.1 My Frame.....	12
5.2 Album Setting.....	12
5.3 Wi-Fi Setting	13
5.4 Factory date reset.....	13
5.5 Help	13
5.6 About	14
6. Suspended Ball	15
7. Technical Specifications.	15
8.Troubleshooting Guide.	16
9.Contact Us.....	17

1. Product Diagram

1.1 Bottom of the frame

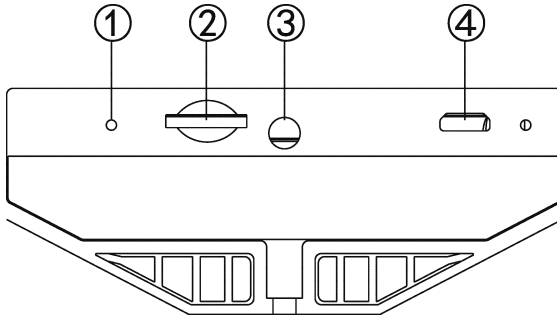

1. Reset Button
2. TF Card Slot
3. DC IN
4. Micro USB

2. Getting Started

2.1 Put the digital photo frame on a flat position steadily, then plug one end of the AC adapter into a standard 110-240V AC electrical outlet and the other end into the DC IN slot at the bottom of the frame.

2.2 Slowly remove the protective film covering on the Screen.

3. Email & Cloud Photo APP Operating Instruction

3.1 Connect Wi-Fi

Cloud frame will search for nearby Wi-Fi networks and show the names of those it finds. If it finds a network which was connected previously, it will connect automatically.

If not: Tap your Network and use the keyboard on screen to input the Password, then tap [Connect] to connect Wi-Fi. Tips: Check [Show password] which is under the password to ensure the password you inputted is right.

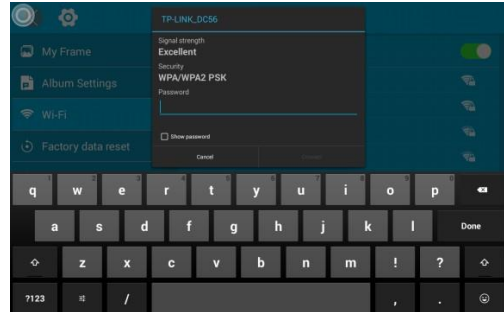
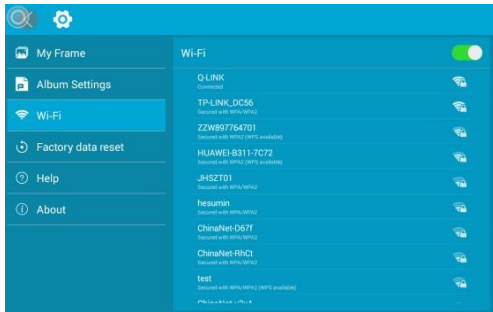

Connect your frame to WI-FI

Cloud frame will scan for available Wi-Fi networks and displays the names of those it finds. If it finds a network that you connected previously, it will connect to it automatically.

If not: Tap the Network you want to connect to. Use the keyboard to enter the Password. And check [Show password] to show password you entered. Tap [Connect] to connect Wi-Fi.

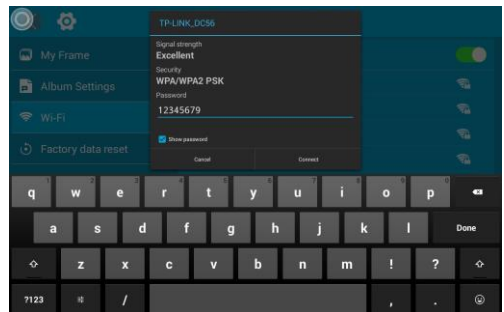
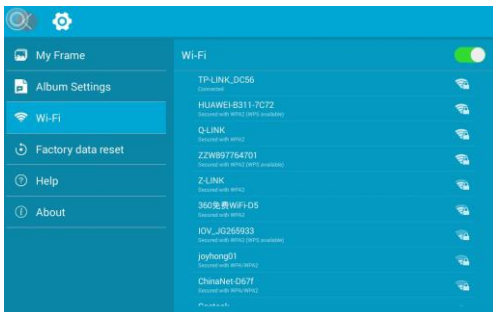

3.2 Download VPhoto APP

Step 1: For Android: Search [VPhoto] APP in Google Play and download the APP For IOS: Search [VPhoto] in iTunes Store and download the APP

Step 2: Log in Your Account in the APP

1. Open VPhoto APP, select Sign Up and fill in all the required information.

Step 3: Bind Your Frame

1. Please confirm you have signed in VPhoto APP.

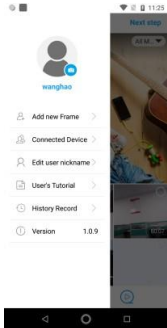

Tap the “Next Step” on the top right to add your new device on the APP.(or tap the icon on the top left, and then choose “Add Photo Frame”)

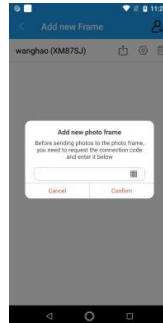

2. Tap “Setting → My Frame” on your digital frame to find the Connection code.



3. Enter the frame Connection code or scan the QR code. After sending your bind request on [VPhoto] APP, you will received a message “*** has bind your device” on your digital frame.

Note: Please connect to Wi-Fi network first to load it and click [🔄] to refresh code to the newest.

Note:

- 1.Connection Code is a 9-digit series number which can be found in your frame, device main interface→ Settings →My frame.
- 2.The Connection code and QR code will refresh every 12 hours.

3.3 Link to Email, Cloud Frame APP

3.3.1 Email

Way1: By Pressing [+] in [My Frame], then add email address

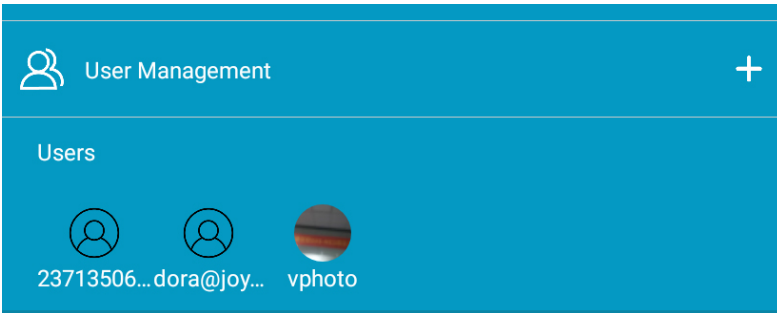

You could always manage all the users who is bound to your frame here.

Way2:

By emailing to the email address specified in [My Frame], with the subject: bd Connection Code (For Example bd123456789), and 123456789' is an example here, please use the real connection code instead.

Check if your email has been added to the user list of your photo frame. If so, send the picture and video as an attachment via email to the email address specified in [My Frame], and your photo frame will receive it.

3.3.2 VPhoto APP

How to download APP

For Android: Search [VPhoto] in Google Play and download the APP For IOS: Search [VPhoto] in iTunes Store and download the APP **How to bind cloud frame**

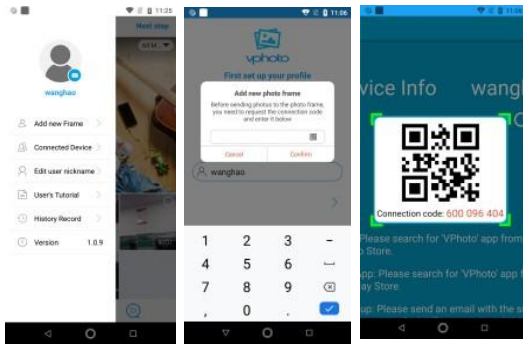

How to post picture, video to cloud frame.



4. General Operating Instruction



Open the VPhoto APP ,Tap [Next Step] on the the top right. (or tap the icon on the top left, and then choose [Add Photo Frame]) .

Enter the Connection Code or scan the QR Code. You can find the Connection Code and QR code in [Setting>My Frame]. Then tap [Confirm]. Once binding process is completed, you will see a message “*** has bind your device” on your digital frame.

Enter the VPhoto APP. Choose the picture or video you want to post. Tap [Next Step] on the top right. Choose a device then tap[▶] to send. A pop up message [Successful] will show on smart device. You can tap [Continue to send] to send other photos if you want.

After turn on cloud frame, it will show the start- up animation. Then enter main menu interface.

4.1 Pictures



Tap [Picture] on main menu to access to picture interface. Choose picture from internal memory, memory card, USB driver, cloud server and favorite. Then tap the picture to start slideshow picture.

Note: If you want to slideshow with background music. You need to choose the music you want to play in [Music] ,and tap [||] to pause. Then back to [Picture] to slideshow picture, it will play the background music.

If you want to turn off the background music, please tap the slideshow picture and then tap the setting icon, you can see the menu with the "Background Music" option, you can tap to choose turn on/ off the background music.

Copy and delete picture

Find the picture in Internal Storage, SD Card, USB or Favorites, Tap the [⋮] on the top right. Then choose the picture you want to copy or delete. Or tap the [○] to

select all . Tap the icon delete to delete the picture. Then tap [OK] to confirm.

While playing pictures from internal memory, tap [♥] to add this picture to favorite, tap [↻] to rotate this picture at 90 degree, [◀] to back to previous interface.

Note : Cloud frame doesn't support adding picture to favorite from memory card and USB driver.

Tap [Music] on main menu to access to music interface. Choose music from internal memory, memory card, USB driver. Then tap the music to start playing music.

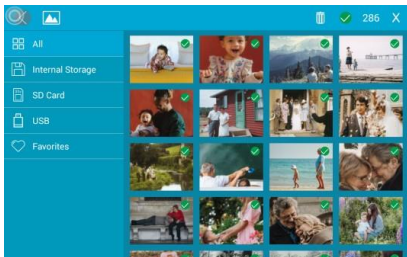

4.2 Music

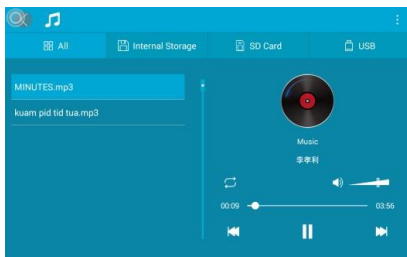

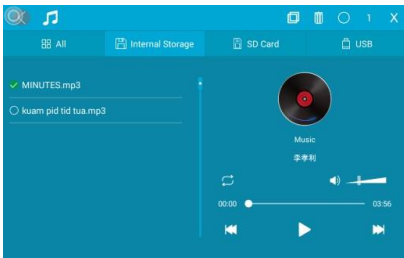

4.3 Videos

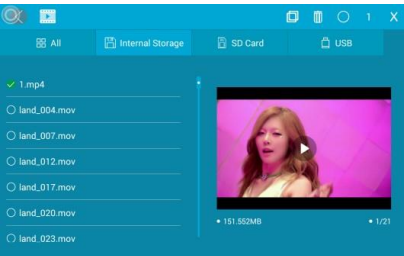
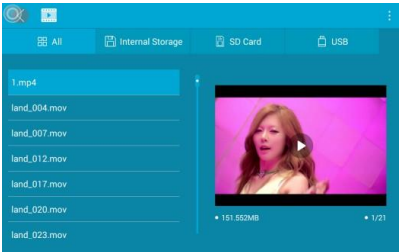

4.4 Clock

Tap [Clock] on main menu to access to clock interface. Double tap the clock and you can choose different clock skins.

Find the music in Internal Storage, SD Card, USB or Favorites, Tap the Music about 2 seconds. Or tap the [○] to select all. Then check the music you want to copy or delete. Tap the [□] to copy the music from memory card or USB driver to internal memory or copy the picture from internal memory to memory card or USB driver. Tap the icon delete to delete the music. Then tap [OK] to confirm. Tap [Video] on main menu to access to video interface. Choose video from internal memory, memory card, USB driver, cloud server. Then tap the video to start display video.

Find the video in Internal Storage, SD Card, USB or Favorites, Tap the video about 2 seconds. Or tap the [○] to select all. Then check the music you want to copy or delete. Tap the [□] to copy the video from memory card or USB driver to internal memory or copy the video from internal memory to memory card or USB driver. Tap the icon delete to delete the video. Then tap [OK] to confirm.



4.5 Calendar



4.6 Alarm

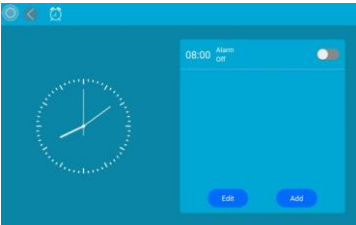

4.7 Weather



Tap [**Calendar**] on main menu to access to calendar.

Tap [**Alarm**] on main menu to access to alarm interface. Tap [**Add**] to add new alarm and tap [**Edit**] to edit or delete alarm.

Tap [**Weather**] on main menu to access to weather interface with weather of three days. Tap [°C] or [°F] to switch temperature format.

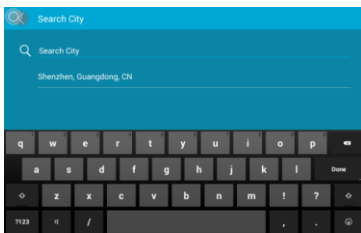

Tap [📍] you can switch the city. Tap [+], Enter city tap tap [🔍] name then to search city.

5. Settings

5.1 My Frame

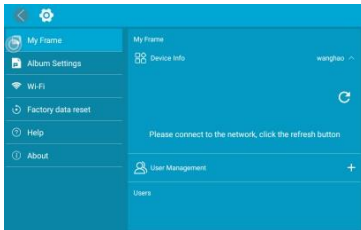

You can check cloud Connection code number and QR Code in [**My Frame**] and manage users that bound to this cloud frame.

In [**Album Settings**], you can adjust brightness and volume. Also you can set [**Touch Sounds**], [**Suspended ball**], [**Language**],

[**Slideshow**], [**Slideshow Mode**], [**Description**], [**Date And Time**], [**Sleep**] and [**Notification sound**]

Note: Turn on [**Auto on/off**] in [**Sleeping**]. And set [**Auto on time**], [**Auto off time**] and [**Repeat**]. Then cloud frame will auto power on or power off.

5.2 Album Setting

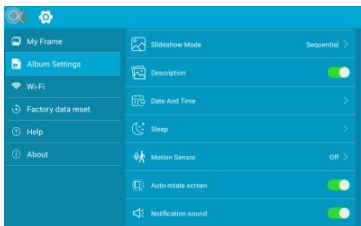
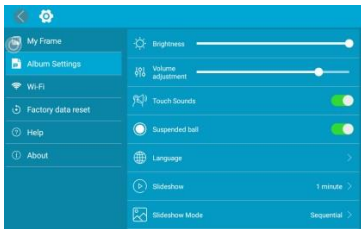

5.3 Wi-Fi Setting

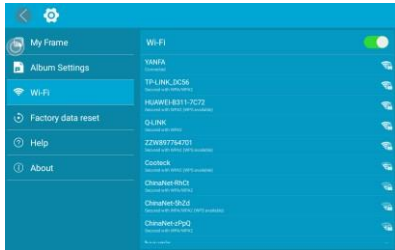

Turn on or turn off Wi-Fi connection and check available Wi-Fi network.

5.4 Factory date reset

In [Factory date reset], You can Reset device.

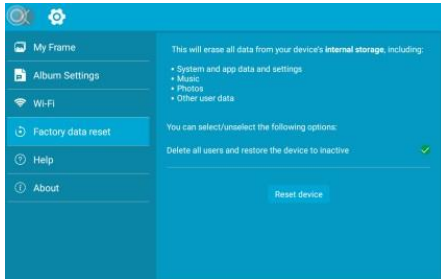

5.5 Help

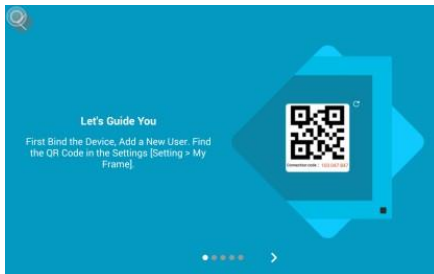

In [Help] you can learn how to use the device.

5.6 About

In **[About]** you can check firmware version, frame ID, memory space and other information.

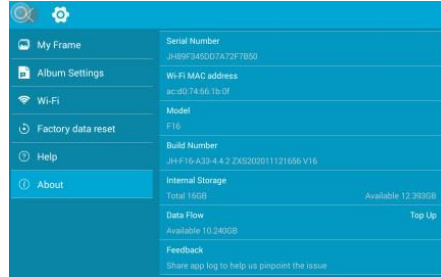
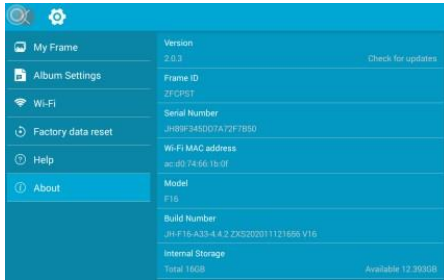

Version Upgrade

If new version was launched, tap **[Version]** and you will see a pop up message **[Find new version]**.

Then tap **[Download]** to download new version of cloud photo frame APP.

After download process is completed, tap **[Install]** to install new version of cloud photo frame APP and tap **[Cancel]** to cancel this process. After new version of cloud photo frame APP was installed. Tap **[Done]** or **[Open]**, then photo will return to main menu interface.

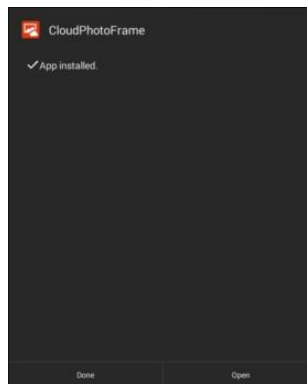
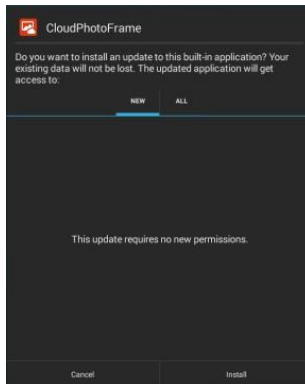

6.Suspended Ball



Turn on suspended ball in [System settings>Album Setting>Suspended Ball].Then suspended ball will appear on screen. Tap [←] access to previous page. Tap [🏠] access to main menu. Tap on [🔊] to increase volume. Tap on [🔊] to decrease volume. Tap on [🔌] to power off the device.

7.Technical Specifications

Adapter: Input AC 100-240V 50/60HZ Output DC 5V/2A

Picture File Format: JPEG/BMP /GIF/TIF/PNG.

Audio File Format: Mp3 / WMA / OGG / APE / FLAC / WAV.

Video/Movie File Format: MPEG1/2, MOV,MPEG4,, AVI, M-JPEG, H.263, H.264.

Memory Card Slot: TF Card Slot (Max. 32GB)

Built-in Memory: 8GB

USB Card Slot: Micro USB

Screen Parameter:

Screen Size: 9 inches

IPS Resolution : 1024*768 pixels

Aspect Ratio: 4:3

Brightness: 200-300 cd/m²

Contrast: 500:1

8. Troubleshooting Guide

If you come across when using the photo frame on problems, consult the suggested solutions below, and the corresponding sections of this manual. If you need additional assistance, please contact technical support.

● **No power:**

Please check whether the AC-Adaptor is inserted correctly.

● **Cannot read the Memory Card or USB-Device:**

Please confirm there are supported files on your memory card or USB device. Empty devices cannot be read.

● **Cannot play the file:**

Please confirm if the file format is compatible with the player.

● **Display too bright or too dark:**

Please adjust the brightness in the setup menu.

● **No sound**

Please check whether the volume is correct and the player is not in Mute mode.

● **No files after share video or picture to cloud server**

Please check whether the upload process is completed or not.

9. Contact Us

If you have any questions after read user manual. Please kindly contact us via below. We will give you best solution within 24 hours.

Email: service@comesourcing.com

FCC STATEMENT

1.This device complies with Part 15 of the FCC Rules. Operation is subject to the following two conditions:

(1) This device may not cause harmful interference.

(2) This device must accept any interference received, including interference that may cause undesired operation.

2. Changes or modifications not expressly approved by the party responsible for compliance could void the user's authority to operate the equipment.

NOTE: This equipment has been tested and found to comply with the limits for a Class B digital device, pursuant to Part 15 of the FCC Rules.

These limits are designed to provide reasonable protection against harmful interference in a residential installation.This equipment generates uses and can radiate radio frequency energy and, if not installed and used in accordance with the instructions, may cause harmful interference to radio communications. However, there is no guarantee that interference will not occur in a particular installation. If this equipment does cause harmful interference to radio or television reception, which can be determined by turning the equipment off and on, the user is encouraged to try to correct the interference by one or more of the following measures: Reorient or relocate the receiving antenna. Increase the separation between the equipment and receiver. Connect the equipment into an outlet on a circuit different from that to which the receiver is connected. Consult the dealer or an experienced radio/ TV technician for help.

FCC Radiation Exposure Statement This equipment complies with FCC radiation exposure limits set forth for an uncontrolled environment. This equipment should be installed and operated with minimum distance 20cm between the radiator & your body.

The logo for FULLJA, featuring the word "FULLJA" in a bold, italicized, sans-serif font. The letters are black with a white outline, giving it a three-dimensional appearance. The 'F' and 'J' are particularly stylized.

Shenzhen Good Sourcing E-commerce Co., LTD.

Copyright© 2021 Shenzhen Good Sourcing E-commerce Co., LTD. All right reserved. Reproduction in whole or in part without permission is prohibited. All other trademarks are the property of their respective owners.