



Mr. Christmas

Alexa Compatible LED
Christmas Tree

Instruction Manual

FOR INDOOR USE ONLY

Step 1: Check the contents of your box

- 1.1 Your tree will come in various combinations depending on the size. (Figure 1)
- 1.2 A metal tree stand with 3 eyebolts. (Figure 2)
- 1.3 Control box and power cord with adaptor. (Figure 3)
- 1.4 "Ornament" with voice activated command list. (Figure 4)
- 1.5 Number of spare bulbs for each: 4 (5ft) /6 (6.5ft) /10 (7 ft) /12 (9 ft) (Figure 5). These can be found in the poly bag attached to the end of the light strand inside the tree.

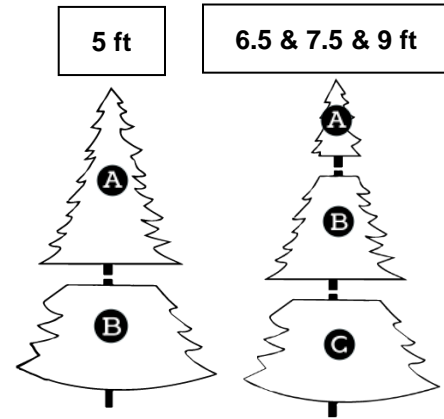

Figure 1



Figure 2



Figure 3



Figure 4



Figure 5

Step 2: Stand Assembly (Figure 6 ~ 8)

Place the stand in your desired location as once the tree is fully assembled it may be too difficult to move and relocate.

2.1 Open the tree stand to form an "X". (Figure 6 and Figure 7)

2.2 Align the threaded holes to insert each eyebolt. Make only a few clockwise turns leaving room to insert bottom section. (Figure 8)



Figure 6



Figure 7



Figure 8

Step 3-A Tree Assembly (Figure 9 ~ 11)

- 3.1 Locate the bottom section (B or C depending on tree size) and insert into the top of tree stand. (Figure 9).
- 3.2 Fully tighten the 3 pins into place. Secure the tree base firmly to the tree stand. (Figure 10).
- 3.3 Insert the remaining section (A or B+A depending on tree size) in the proper order. (Figure 11)

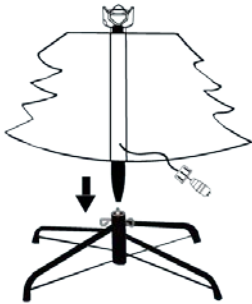

Figure 9

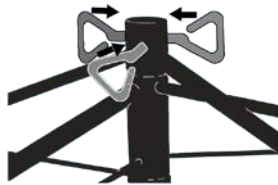

Figure 10

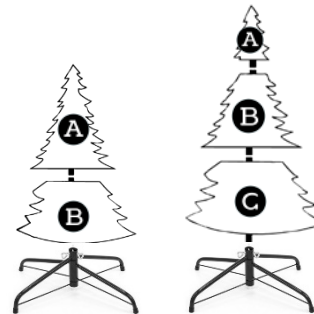

Figure 11

IMPORTANT TREE SET UP TIPS:

1. Shake the tree well after assembly to ensure the branches are extended.
2. Some shaping of the tree may be required for best appearance.
3. Spare bulbs are included in a small bag inside the tree. Remove from the tree and keep in case replacement is needed.



Step 3-B Extend all branches and twigs and shape until the tree looks full.

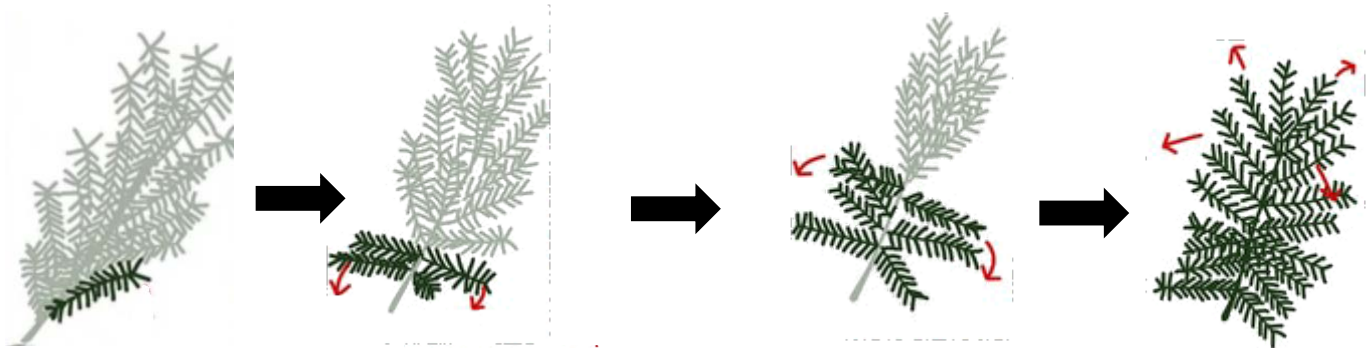

Before



After

Step 4: Connect Controller and AC Power Adapter (Figure 12).

Attach the power cord with adaptor to the control box, plug the adaptor into an AC power source.

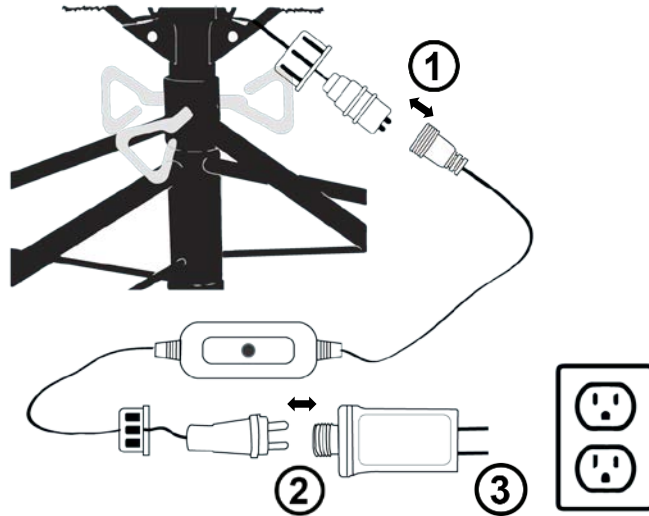

Figure 12

Step 5: Connect to Alexa

1. Download the “Amazon Alexa” application from the app store on your mobile device .
2. Install and open the “Amazon Alexa” application.
3. Go to the settings menu. ☰
4. Select “Add Device”
5. Select “Christmas Tree” and follow the on-screen instructions.
6. To set up a second tree, select “Second Christmas Tree” and follow the on-screen instructions. Alexa will ask for clarification if a command does not target a specific tree.

Barcode Scanning & Location (Figure 13)

Note that during device setup you may be asked to scan a device barcode. You can find this on the back of the controller, shown in Figure 13.

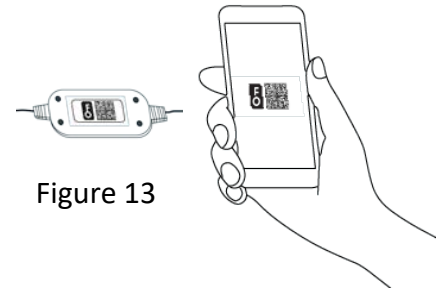

Figure 13

Step 6-A: Change your Christmas Tree LED lighting Mode using Alexa

Follow the voice commands for a list of functions to achieve up to 55 lighting functions. (Figure 14)



Figure 14

Color options

Command – “Set Christmas tree to” :

1. White
2. Red
3. Green
4. Yellow
5. Blue
6. Purple
7. Light blue
8. Starlight
9. Multi Color

Light functions

Command – “Set Christmas tree to” :

- A. Steady
- B. Fade
- C. Flip
- D. Sparkle
- E. Twinkle
- F. Trio

Brightness Settings

Command – “Set Christmas tree to” :

- I. High
- II. Medium
- III. Low

Step 6-B: Manually change your Christmas Tree LED lighting mode

Push Button on Control Box to switch Christmas Tree LED Light Mode.

There are a total of 55 lighting modes:

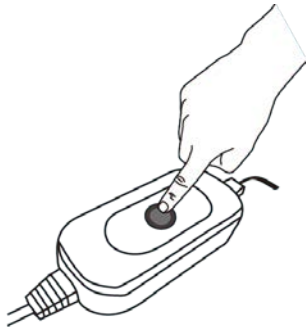

- | | |
|------------------------|----------------------|
| 00. Power Off | |
| 01. White Steady | 10. White Fade |
| 02. Red Steady | 11. Red Fade |
| 03. Green Steady | 12. Green Fade |
| 04. Yellow Steady | 13. Yellow Fade |
| 05. Blue Steady | 14. Blue Fade |
| 06. Purple Steady | 15. Purple Fade |
| 07. Light Blue Steady | 16. Light Blue Fade |
| 08. Starlight Steady | 17. Starlight Fade |
| 09. Multi Color Steady | 18. Multi Color Fade |

Step 6-B: Manually change your Christmas Tree LED lighting mode (cont'd)

- | | | | |
|----------------------|-------------------------|-------------------------|----------------------|
| 19. White Flip | 28. White Sparkle | 37. White Twinkle | 46. White Trio |
| 20. Red Flip | 29. Red Sparkle | 38. Red Twinkle | 47. Red Trio |
| 21. Green Flip | 30. Green Sparkle | 39. Green Twinkle | 48. Green Trio |
| 22. Yellow Flip | 31. Yellow Sparkle | 40. Yellow Twinkle | 49. Blue Trio |
| 23. Blue Flip | 32. Blue Sparkle | 41. Blue Twinkle | 50. Yellow Trio |
| 24. Light Blue Flip | 33. Purple Sparkle | 42. Purple Twinkle | 51. Light Blue Trio |
| 25. Purple Flip | 34. Light Blue Sparkle | 43. Light Blue Twinkle | 52. Purple Trio |
| 26. Starlight Flip | 35. Starlight Sparkle | 44. Starlight Twinkle | 53. Starlight Trio |
| 27. Multi Color Flip | 36. Multi Color Sparkle | 45. Multi Color Twinkle | 54. Multi Color Trio |
| | | | 55. Demo Mode |

Demo Mode: The Demo mode will start and play all 54 lighting functions every 8 seconds.

Step 6-C: Automate your Christmas Tree with Routines

Alexa Routines allow you to automate your Christmas Tree Functionality. With Routines, you can turn your tree on with custom commands (i.e. Good Morning) or turn the tree on/off at scheduled times (i.e. every day at 10AM)

How to Enable Routines with Alexa.

1. Open the Alexa app.
2. Go to the menu and select “Routines”
3. Select  Plus
4. Select “When this happens”, and then choose how to begin your Routine (i.e. “Good Morning, or a scheduled time).
5. Select “Add Action”, select “Smart Home”, and then select “Christmas Tree”. Configure the desired LED lighting mode for your selected action.

Example 1: Turn Christmas Tree ON



“Alexa, Turn Christmas tree: ON.”



Example 2: Set lighting mode to Red



“Alexa, Set Christmas tree to: Red.”

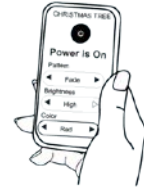

Example 3: Set brightness mode to High



“Alexa, Set Christmas tree to: High.”

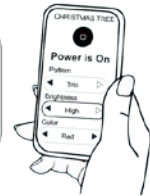

Example 4: Set lighting mode to Fade



“Alexa, Set Christmas tree to: Fade.”

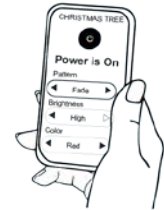

Example 5: Set lighting mode to Demo



“Alexa, Turn Christmas tree Demo On.”

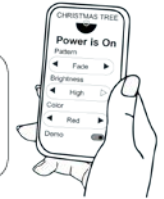

Example 6: Turn Christmas Tree on with Routine



“Alexa, Good Morning / Good Night.”



Connectivity Troubleshooting

1. I can't connect my device to Alexa.

- Check your WI-FI settings
 - Make sure that your Alexa device and your Christmas Tree are connected to the same Wi-Fi network.
 - Make sure that all devices have the most updated Wi-Fi password.
- Check the distance to your Alexa smart speaker
 - Check that your device is within 30 ft. (9 m) of your Christmas Tree.
- Check your software version
 - Check that your Alexa device and the Alexa app have the latest software version.

2. I can't get my Christmas Tree barcode to scan successfully.

- Make sure that there is enough light in the area for the bar code to be detected.
- If that does not work, then during the Alexa mobile app setup process, select "Don't Have a Barcode" and follow the on-screen instructions.

3. My Christmas Tree stopped working with Alexa.

- Try a power cycle: Unplug your Christmas Tree from the outlet, and then plug it back in.
- Perform a factory reset :

To reset your Alexa Tree: press and hold the button on the control box for 10 seconds. Indication of action done: 3 flashes of white light. Then follow the instructions below.

- Open the "Amazon Alexa" application.
- Go to the settings menu.
- Select "Add Device"
- Select "Christmas Tree" and follow the on-screen instructions.

4. I can only turn my Christmas Tree On and Off with Alexa.

- Although the Alexa tree can be added to a group, the color and function selections will not work using the group name.
- Color and Function can only be selected by using the utterance "Christmas Tree."

5. Alexa is not responding to some but not all of my utterances

- Alexa will not work if you have more than one Alexa device with a similar name
- Rename one of the devices.

It is recommended to always store the tree in a cool, dry location protected from excessive exposure to heat or sunlight.

6. Should a bulb get out of color sync in respect to the light set color selected by Alexa Command, this can be readily fixed by switching out the individual bulb with the replacement bulb provided.

IMPORTANT SAFETY INSTRUCTIONS

When using electrical products, basic precautions should always be followed including the Following:

- a) READ AND FOLLOW ALL SAFETY INSTRUCTIONS.
- b) Do not use seasonal products outdoors unless marked suitable for indoor and outdoor use. When products are used in outdoor applications, connect the product to a Ground Fault Circuit Interrupting (GFCI) outlet. If one is not provided contact a qualified for proper installation.
- c) This seasonal use product is not intended for permanent installation or use.
- d) Do not mount or place near gas or electric heaters, fireplace, candles or other similar sources of heat.
- e) Do not secure the wiring of the product with staples or nails, or place on sharp hooks or nails.
- f) Do not let bulbs rest on the supply cord or on any wire.
- g) Unplug the product when leaving the house, when retiring for the night, or if left unattended.
- h) This is an electric product-not a toy! To avoid risk of fire, burns, personal injury and electric shock it should not be played with or placed where small children can reach it.
- i) Do not use this product for other than its intended use.
- j) Do not hang ornaments or other objects from cord, wire, or light string.
- k) Do not close doors or windows on the product or extension cords as this may damage the wire insulation
- l) Do not cover the product with cloth, paper or any material not part of the product when in use.
- m) This product is equipped with push-in type bulbs. Do not twist bulbs.
- n) Read and follow a instructions that are on the product or provided with the product.
- o) **Save these instructions.**

User Servicing Instructions

Replace the bulb. (Figure 18)

1. Grasp plug and remove from the receptacle or other outlet device. Do not unplug by pulling on cord.
2. Pull bulb and plastic base straight out of bulb holder
3. Replace bulb with only 3 Volt 0.06 Watt LED type bulb (provided with product).

If the new bulb base does not fit in bulb holder, follow the steps below before step 3.

- a) Remove the base of burned out bulb by straightening bulb leads and gently pull bulb out.
- b) Thread leads of new bulb through holes in old base with one lead in each hole.
- c) After bulb is fully inserted into base, bend each lead up like other bulbs in the light set. so that the leads will touch the contacts inside the bulb holder.

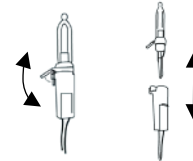

Figure 18

CAUTION

1. To reduce the risk of fire or electric shock do not attempt to replace bulbs or modify string.
2. To reduce the risk of fire and electric shock : a) Do not install on trees having needles, leaves or branch coverings of metal or materials which look like metal, and b) Do not mount or support strings in a manner that can cut or damage wire insulation.
3. This is not a toy, for decorative use only.

This device complies with Part 15 of the FCC Rules. Operation is subject to the following two conditions:

- (1) this device may not cause harmful interference, and
- (2) this device must accept any interference received, including interference that may cause undesired operation.

WARNING: Changes or modifications to this unit not expressly approved by the party responsible for compliance could void the user's authority to operate the equipment.

NOTE: This equipment has been tested and found to comply with the limits for a Class B digital device, pursuant to Part 15 of the FCC Rules. These limits are designed to provide reasonable protection against harmful interference in a residential installation. This equipment generates, uses and can radiate radio frequency energy and, if not installed and used in accordance with the instructions, may cause harmful interference to radio communications. However, there is no guarantee that interference will not occur in a particular installation. If this equipment does cause harmful interference to radio or television reception, which can be determined by turning the equipment off and on, the user is encouraged to try to correct the interference by one or more of the following measures:

- Reorient or relocate the receiving antenna.
- Increase the separation between the equipment and receiver.
- Connect the equipment into an outlet on a circuit different from that to which the receiver is connected.
- Consult the dealer or an experienced radio/TV technician for help.

Made in China

Model #: H259964, H259965, H259966, H259967

H259968, H259969, H25970, H259971

68341, 68342, 68343, 68344,

68345, 68346, 68347, 68348

Made by Mr. Christmas Inc.

6045 E. Shelby Dr., Suite 2, Memphis TN 38141-7601

Email: customerservice@mrchristmas.com

Customer service number: 1-800-453-1972

This device complies with part 15 of the FCC Rules. Operation is subject to the following two conditions: (1) this device may not cause harmful interference, and (2) this device must accept any interference received, including interference that may cause undesired operation.

Any changes or modifications not expressly approved by the party responsible for compliance could void the user's authority to operate the equipment.

NOTE: This equipment has been tested and found to comply with the limits for a Class B digital device, pursuant to Part 15 of the FCC Rules. These limits are designed to provide reasonable protection against harmful interference in a residential installation. This equipment generates, uses and can radiate radio frequency energy and, if not installed and used in accordance with the instructions, may cause harmful interference to radio communications.

However, there is no guarantee that interference will not occur in a particular installation.

If this equipment does cause harmful interference to radio or television reception, which can be determined by turning the equipment off and on, the user is encouraged to try to correct the interference by one or more of the following measures:

- Reorient or relocate the receiving antenna.
- Increase the separation between the equipment and receiver.
- Connect the equipment into an outlet on a circuit different from that to which the receiver is connected.
- Consult the dealer or an experienced radio/TV technician for help.

The device has been evaluated to meet general RF exposure requirement. The device can be used in portable exposure condition without restriction

FCC ID: 2AZ4R-68341