



# RF TEST REPORT

**Applicant** XCHENG TECH CO.,LIMITED  
**FCC ID** 2AZ4F-P1012-P10  
**Product** P10 Stylish POS Terminal  
**Brand** Kobile; Clip; YOCO; MPOS; Positivo  
**Model** P10  
**Report No.** R2208A0725-R4V1  
**Issue Date** September 5, 2022

TA Technology (Shanghai) Co., Ltd. tested the above equipment in accordance with the requirements in **FCC CFR47 Part 2 (2021)/ FCC CFR 47 Part 90S (2021)**. The test results show that the equipment tested is capable of demonstrating compliance with the requirements as documented in this report.

Prepared by: Xu Ying

Approved by: Xu Kai

---

**TA Technology (Shanghai) Co., Ltd.**

Building 3, No.145, Jintang Rd, Tangzhen Industry Park, Pudong Shanghai, China

TEL: +86-021-50791141/2/3

FAX: +86-021-50791141/2/3-8000



## TABLE OF CONTENT

1. Test Laboratory .....	5
1.1. Notes of the Test Report .....	5
1.2. Test facility .....	5
1.3. Testing Location .....	5
2. General Description of Equipment under Test .....	6
2.1. Applicant and Manufacturer Information .....	6
2.2. General Information .....	6
3. Applied Standards .....	7
4. Test Configuration .....	8
5. Test Case .....	9
5.1. RF Power Output and Effective Radiated Power .....	9
5.2. Occupied Bandwidth .....	10
5.3. Emission Mask .....	11
5.4. Peak-to-Average Power Ratio (PAPR) .....	12
5.5. Frequency Stability .....	13
5.6. Spurious Emissions at Antenna Terminals .....	15
5.7. Radiates Spurious Emission .....	16
6. Test Results .....	19
6.1. RF Power Output and Effective Radiated Power .....	19
6.2. Occupied Bandwidth .....	25
6.3. Emission Mask .....	31
6.4. Peak-to-Average Power Ratio (PAPR) .....	39
6.5. Frequency Stability .....	41
6.6. Spurious Emissions at Antenna Terminals .....	43
6.7. Radiates Spurious Emission .....	45
7. Main Test Instruments .....	47
ANNEX A: The EUT Appearance .....	48
ANNEX B: Test Setup Photos .....	49



Version	Revision description	Issue Date
Rev.0	Initial issue of report.	September 1, 2022
Rev.1	Update information and data.	September 5, 2022

Note: This revised report (Report No. R2208A0725-R4V1) supersedes and replaces the previously issued report (Report No. R2208A0725-R4). Please discard or destroy the previously issued report and dispose of it accordingly.



## Summary of measurement results

No.	Test Case	Clause in FCC rules	Verdict
1	RF Power Output and Effective Radiated Power	2.1046/90.635(b)	PASS
2	Occupied Bandwidth	2.1049/ 90.209	PASS
3	Emission Masks	2.1051 / 90.691	PASS
4	Peak-to-Average Power Ratio	KDB 971168 D01(5.7)	PASS
5	Frequency Stability	2.1055 / 90.213	PASS
6	Spurious Emissions at Antenna Terminals	2.1051 / 90.691	PASS
7	Radiates Spurious Emission	2.1053 /90.691	PASS
Date of Testing: August 6, 2022 ~ August 22, 2022			
Date of Sample Received: August 5, 2022			
Note: PASS: The EUT complies with the essential requirements in the standard. FAIL: The EUT does not comply with the essential requirements in the standard. All indications of Pass/Fail in this report are opinions expressed by TA Technology (Shanghai) Co., Ltd. based on interpretations and/or observations of test results. Measurement Uncertainties were not taken into account and are published for informational purposes only.			



## 1. Test Laboratory

### 1.1. Notes of the Test Report

This report shall not be reproduced in full or partial, without the written approval of **TA technology (shanghai) co., Ltd.** The results documented in this report apply only to the tested sample, under the conditions and modes of operation as described herein .Measurement Uncertainties were not taken into account and are published for informational purposes only. This report is written to support regulatory compliance of the applicable standards stated above.

### 1.2. Test facility

#### **FCC (Designation number: CN1179, Test Firm Registration Number: 446626)**

TA Technology (Shanghai) Co., Ltd. has been listed on the US Federal Communications Commission list of test facilities recognized to perform electromagnetic emissions measurements.

#### **A2LA (Certificate Number: 3857.01)**

TA Technology (Shanghai) Co., Ltd. has been listed by American Association for Laboratory Accreditation to perform electromagnetic emission measurement.

### 1.3. Testing Location

Company: TA Technology (Shanghai) Co., Ltd.  
Address: Building 3, No.145, Jintang Rd, Tangzhen Industry Park, Pudong Shanghai, China  
City: Shanghai  
Post code: 201201  
Country: P. R. China  
Contact: Xu Kai  
Telephone: +86-021-50791141/2/3  
Fax: +86-021-50791141/2/3-8000  
Website: <http://www.ta-shanghai.com>  
E-mail: [xukai@ta-shanghai.com](mailto:xukai@ta-shanghai.com)

## 2. General Description of Equipment under Test

### 2.1. Applicant and Manufacturer Information

Applicant	XCHENG TECH CO.,LIMITED
Applicant address	ROOM 401F, Building 5, No.3000 LONG DONG Avenue, Pudong New District, Shanghai, China
Manufacturer	XCHENG TECH CO.,LIMITED
Manufacturer address	ROOM 401F, Building 5, No.3000 LONG DONG Avenue, Pudong New District, Shanghai, China

### 2.2. General Information

EUT Description			
Model	P10		
IMEI	IMEI 1: 866805060000523 IMEI 2: 866805060002925		
Hardware Version	V1.0		
Software Version	SW1.0		
Power Supply	Battery / AC adapter		
Antenna Type	Dipole Antenna		
Antenna Gain	0 dBi		
Test Mode(s)	LTE Band 26;		
Test Modulation	QPSK, 16QAM, 64QAM;		
LTE Category	M1		
Maximum E.R.P.	LTE Band 26:	20.60 dBm	
Rated Power Supply Voltage	7.6 V		
Operating Voltage	Minimum: 7.2V    Maximum: 8.4V		
Operating Temperature	Lowest: -10°C    Highest: +45°C		
Testing Temperature	Lowest: -10°C    Highest: +45°C		
Operating Frequency Range(s)	Band	Tx (MHz)	Rx (MHz)
	LTE Band 26	814 ~ 824	859 ~ 869
EUT Accessory			
Adapter	Manufacturer: Chongqing Lianmao Electronics Co., Ltd Model: 1110303-K022002		
Battery	Manufacturer: Pow-Tech New Power CO., LTD. Model: 18650-2600mAh-2S1P-7.2V (P1012)		
Note: 1. The EUT is sent from the applicant to TA and the information of the EUT is declared by the applicant.			



### 3. Applied Standards

According to the specifications of the manufacturer, it must comply with the requirements of the following standards:

**Test standards:**

**FCC CFR 47 Part 90S (2021)**

**FCC CFR47 Part 2 (2021)**

**Reference standard:**

**ANSI C63.26-2015**

**KDB 971168 D01 Power Meas License Digital Systems v03r01**

### 4. Test Configuration

There is more than one SIM card slot, each one should be applied throughout the compliance test respectively, and however, only the worst case (SIM 1) will be recorded in this report.

Radiated measurements are performed by rotating the EUT in three different orthogonal test planes. EUT stand-up position (Z axis), lie-down position (X, Y axis). Receiver antenna polarization (horizontal and vertical), the worst emission was found in position (Z axis, vertical polarization) and the worst case was recorded.

All mode and data rates and positions were investigated.

The following testing in LTE is set based on the maximum RF Output Power.

Test modes are chosen as the worst case configuration below for LTE Band 26

Test items	Bandwidth (MHz)					Modulation		RB			Test Channel		
	1.4	3	5	10	15	QPSK	16QAM/64QAM	1	50%	100%	L	M	H
RF Power Output and Effective Radiated Power	O	O	O	O	-	O	O	O	O	O	O	O	O
Occupied Bandwidth	O	O	O	O	-	O	O	-	-	O	O	O	O
Emission Mask	O	O	O	O	-	O	O	O	-	O	O	-	O
Peak-to-Average Power Ratio	O	O	O	O	-	O	O	-	-	O	O	O	O
Frequency Stability	O	O	O	O	-	O	O	O	-	-	-	O	-
Spurious Emissions at Antenna Terminals	O	O	O	O	-	O	-	O	-	-	O	O	O
Radiates Spurious Emission	O	-	O	-	-	O	-	O	-	-	-	O	-
Note	1. The mark "O" means that this configuration is chosen for testing. 2. The mark "-" means that this configuration is not testing.												



## 5. Test Case

### 5.1. RF Power Output and Effective Radiated Power

#### Ambient condition

Temperature	Relative humidity
21°C ~25°C	40%~60%

#### Methods of Measurement

During the process of the testing, The EUT was connected to the Base Station Simulator with a known loss. The EUT is controlled by the Base Station Simulator test set to ensure max power transmission with proper modulation.

ERP can then be calculated as follows:

$$\text{EIRP (dBm)} = \text{Output Power (dBm)} - \text{Losses (dB)} + \text{Antenna Gain (dBi)}$$

where:dBd refers to gain relative to an ideal dipole.

$$\text{EIRP (dBm)} = \text{ERP (dBm)} + 2.15 \text{ (dB.)}$$

#### Test Setup

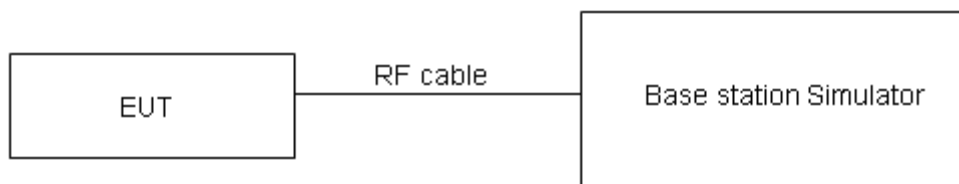

#### Limits

Part 90.635 (b) the maximum output power of the transmitter for mobile stations is 100 watts.

Rule Part 90.635(b) specifies that “The maximum output power of the transmitter for mobile stations is 100 watts”.

Limit	≤ 100 W (50 dBm)
-------	------------------

#### Measurement Uncertainty

The assessed measurement uncertainty to ensure 95% confidence level for the normal distribution is with the coverage factor k = 2, U= 0.4 dB for RF power output, k = 2, U= 1.19 dB for ERP.

#### Test Results

Refer to the section 6.1 of this report for test data.

## 5.2. Occupied Bandwidth

### Ambient condition

Temperature	Relative humidity
21°C ~25°C	40%~60%

### Method of Measurement

The EUT was connected to Spectrum Analyzer and Base Station Simulator via power Splitter. The occupied bandwidth is measured using spectrum analyzer.

RBW is set to 30 kHz, VBW is set to 91 kHz for LTE Band 26 (1.4MHz).

RBW is set to 62 kHz, VBW is set to 180 kHz for LTE Band 26 (3MHz).

RBW is set to 100 kHz, VBW is set to 300 kHz for LTE Band 26 (5MHz).

RBW is set to 200 kHz, VBW is set to 620kHz for LTE Band 26 (10MHz).

99% power and -26dBc occupied bandwidths are recorded. Spectrum analyzer plots are included on the following pages.

### Test Setup

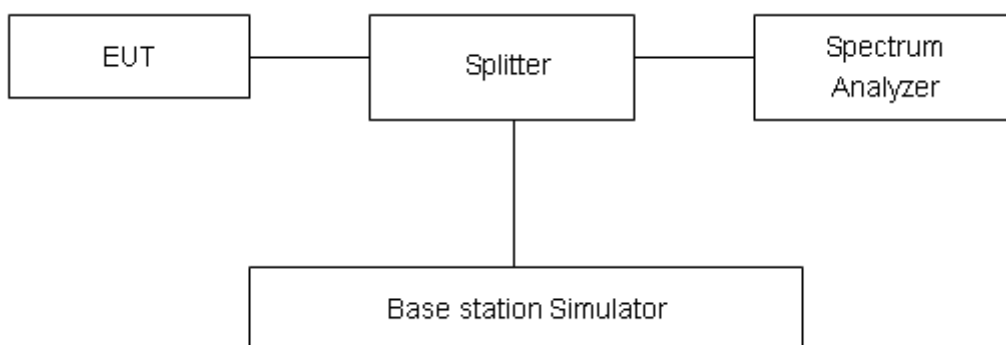

### Limits

No specific occupied bandwidth requirements in part 2.1049.

Part 90.209 (a) Each authorization issued to a station licensed under this part will show an emission designator representing the class of emission authorized. The designator will be prefixed by a specified necessary bandwidth. This number does not necessarily indicate the bandwidth occupied by the emission at any instant. In those cases where part 2.202 of this chapter does not provide a formula for the computation of necessary bandwidth, the occupied bandwidth, as defined in part 2 of this chapter, may be used in lieu of the necessary bandwidth.

### Measurement Uncertainty

The assessed measurement uncertainty to ensure 95% confidence level for the normal distribution is with the coverage factor  $k = 2$ ,  $U = 624\text{Hz}$ .

### Test Results

Refer to the section 6.2 of this report for test data.

### 5.3. Emission Mask

#### Ambient condition

Temperature	Relative humidity
21°C ~25°C	40%~60%

#### Method of Measurement

The EUT was connected to Spectrum Analyzer and Base Station Simulator via power Splitter. The band edge of the lowest and highest channels were measured. The average detector is used. For Section 90.691(a) compliance testing, use RBW = 300 Hz for offsets less than 37.5 kHz from a channel edge; RBW = 100 kHz for offsets greater than 37.5 kHz is allowed.

Spectrum analyzer plots are included on the following pages.

#### Test Setup

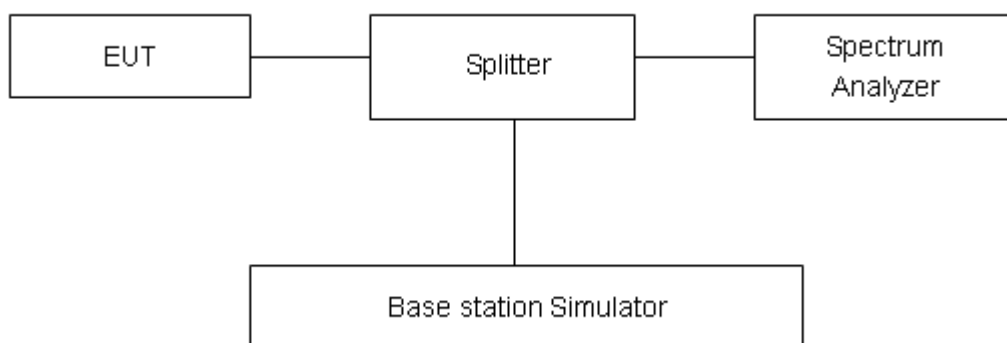

#### Limits

Rule Part 90.691(a) specifies that “ For any frequency removed from the EA licensee's frequency block by up to and including 37.5 kHz, the power of any emission shall be attenuated below the transmitter power (P) in watts by at least  $116 \text{ Log}_{10}(f/6.1)$  decibels or  $50 + 10 \text{ Log}_{10}(P)$  decibels or 80 decibels, whichever is the lesser attenuation, where f is the frequency removed from the center of the outer channel in the block in kilohertz and where f is greater than 12.5 kHz.”

#### Measurement Uncertainty

The assessed measurement uncertainty to ensure 95% confidence level for the normal distribution is with the coverage factor  $k = 1.96$ ,  $U=0.684\text{dB}$ .

#### Test Results

Refer to the section 6.3 of this report for test data.

### 5.4. Peak-to-Average Power Ratio (PAPR)

#### Ambient condition

Temperature	Relative humidity
21°C ~25°C	40%~60%

#### Methods of Measurement

Measure the total peak power and record as PPK. And measure the total average power and record as PAvg. Both the peak and average power levels must be expressed in the same logarithmic units (e.g., dBm). Determine the PAPR from:

$$PAPR (dB) = PPK (dBm) - PAvg (dBm).$$

#### Test Setup

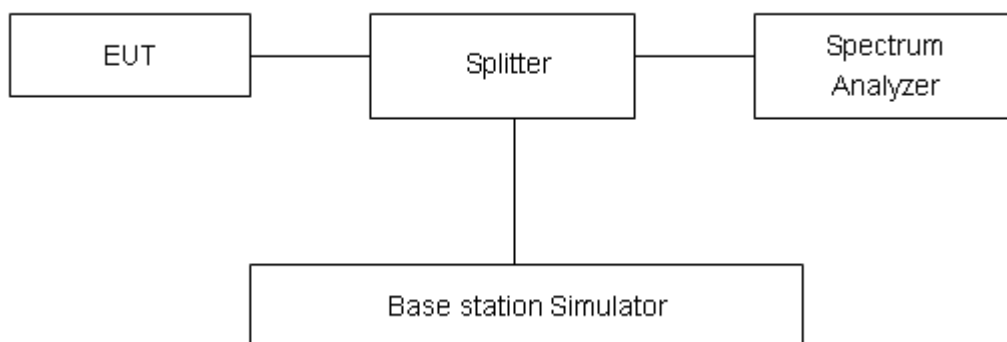

#### Limits

In measuring transmissions in this band using an average power technique, the peak-to-average ratio (PAR) of the transmission may not exceed 13 dB in 24.232(d).

#### Measurement Uncertainty

The assessed measurement uncertainty to ensure 95% confidence level for the normal distribution is with the coverage factor  $k = 2$ ,  $U = 0.4$  dB.

#### Test Results

Refer to the section 6.4 of this report for test data.

## 5.5. Frequency Stability

### Ambient condition

Temperature	Relative humidity
21°C ~25°C	40%~60%

### Method of Measurement

#### 1. Frequency Stability (Temperature Variation)

The temperature inside the climate chamber is varied from -10°C to +45°C in 10°C step size,

(1) With all power removed, the temperature was decreased to 0°C and permitted to stabilize for three hours.

(2) Measure the carrier frequency with the test equipment in a “call mode”. These measurements should be made within 1 minute of powering up the mobile station, to prevent significant self warming.

(3) Repeat the above measurements at 10°C increments from -10°C to +45°C. Allow at least 1.5 hours at each temperature, un-powered, before making measurements.

#### 2. Frequency Stability (Voltage Variation)

The frequency stability shall be measured with variation of primary supply voltage as follows:

**Primary Supply Voltage:** The primary supply voltage is varied from 85% to 115% of the nominal value for non hand-carried battery and AC powered equipment. For hand-carried, battery-powered equipment, primary supply voltage is reduced to the battery operating end point which shall be specified by the manufacturer.

This transceiver is specified to operate with an input voltage of between 7.2 V and 8.4 V, with a nominal voltage of 7.6V.

### Test setup

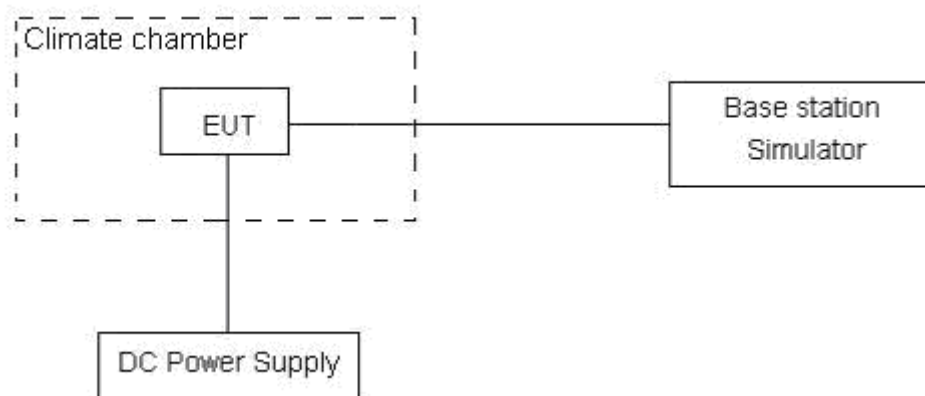

## Limits

According to the Sec. 90.213.(a) Unless noted elsewhere, transmitters used in the services governed by this part must have a minimum frequency stability as specified in the following table.

Minimum Frequency Stability

[Parts per million (ppm)]

Frequency range (MHz)	Fixed and base stations	Mobile stations	
		Over 2 watts output power	2 watts or less output power
814 ~ 824	1.5	2.5	2.5

## Measurement Uncertainty

The assessed measurement uncertainty to ensure 99.75% confidence level for the normal distribution is with the coverage factor  $k = 3$ ,  $U = 0.01$  ppm.

## Test Results

Refer to the section 6.5 of this report for test data.

### 5.6. Spurious Emissions at Antenna Terminals

#### Ambient condition

Temperature	Relative humidity
21°C ~25°C	40%~60%

#### Method of Measurement

The EUT was connected to Spectrum Analyzer and Base Station Simulator via power Splitter. The measurement is carried out using a spectrum analyzer. The spectrum analyzer scans from 30MHz to the 10th harmonic of the carrier. The peak detector is used. RBW and VBW are set to 100 kHz, RBW is set to 1 kHz (0.009MHz~ 0.15 MHz), RBW is set to 10 kHz (0.15 MHz~ 30 MHz) RBW is set to 100 kHz (30MHz~1000 MHz) RBW is set to 1000 kHz (above 1000MHz) Sweep is set to ATUO.

#### Test setup

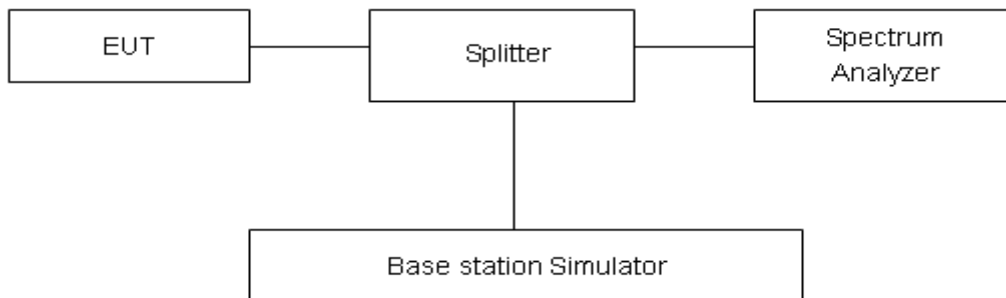

#### Limits

Rule Part 90.691 specifies that “The power of any emission outside of the authorized operating frequency ranges must be attenuated below the transmitting power (P) by a factor of at least 43 + 10 log (P) dB.”

Limit	-13 dBm
-------	---------

#### Measurement Uncertainty

The assessed measurement uncertainty to ensure 99.75% confidence level for the normal distribution is with the coverage factor  $k = 1.96$ .

Frequency	Uncertainty
9kHz-1GHz	0.684 dB
1GHz-12.75GHz	1.407 dB

#### Test Results

Refer to the section 6.6 of this report for test data.

## 5.7. Radiates Spurious Emission

### Ambient condition

Temperature	Relative humidity
21°C ~25°C	40%~60%

### Method of Measurement

1. The testing follows FCC KDB 971168 v03r01 Section 5.8 and ANSI C63.26-2015.
2. Below 1GHz: The EUT is placed on a turntable 0.8 meters above the ground in the chamber, 3 meter away from the antenna. The maximal emission value is acquired by adjusting the antenna height, polarisation and turntable azimuth. Normally, the height range of antenna is 1 m to 4 m, the azimuth range of turntable is 0° to 360°, and the receive antenna has two polarizations Vertical (V) and Horizontal (H). Above 1GHz: (Note: the FCC's permission to use 1.5m as an alternative per TCBC Conf call of Dec. 2, 2014.) The EUT is placed on a turntable 1.5 meters above the ground in the chamber, 3 meter away from the antenna. The maximal emission value is acquired by adjusting the antenna height, polarisation and turntable azimuth. Normally, the height range of antenna is 1 m to 4 m, the azimuth range of turntable is 0° to 360°, and the receive antenna has two polarizations Vertical (V) and Horizontal (H).
3. A loop antenna, A log-periodic antenna or horn antenna shall be substituted in place of the EUT. The log-periodic antenna will be driven by a signal generator and the level will be adjusted till the same power value on the spectrum analyzer or receiver. The level of the spurious emissions can be calculated through the level of the signal generator, cable loss, the gain of the substitution antenna and the reading of the spectrum analyzer or receiver.
4. The EUT is then put into continuously transmitting mode at its maximum power level during the test. Set Test Receiver or Spectrum RBW=100kHz,VBW=300kHz, and the maximum value of the receiver should be recorded as (Pr).
5. The EUT shall be replaced by a substitution antenna. In the chamber, an substitution antenna for the frequency band of interest is placed at the reference point of the chamber. An RF Signal source for the frequency band of interest is connected to the substitution antenna with a cable that has been constructed to not interfere with the radiation pattern of the antenna. A power (PMea) is applied to the input of the substitution antenna, and adjust the level of the signal generator output until the value of the receiver reach the previously recorded (Pr). The power of signal source (PMea) is recorded. The test should be performed by rotating the test item and adjusting the receiving antenna polarization.
6. A amplifier should be connected to the Signal Source output port. And the cable should be connect between the Amplifier and the Substitution Antenna. The cable loss (Pcl) ,the Substitution Antenna Gain (Ga) and the Amplifier Gain (PAg) should be recorded after test.
7. The measurement results are obtained as described below:  
Power(EIRP)=PMea- PAg - Pcl + Ga  
The measurement results are amend as described below:  
Power(EIRP)=PMea- Pcl + Ga
8. This value is EIRP since the measurement is calibrated using an antenna of known gain (2.15 dBi) and known input power. ERP can be calculated from EIRP by subtracting the gain of the dipole, ERP = EIRP-2.15dBi.



The modulation mode and RB allocation refer to section 5.1, using the maximum output power configuration.

**Test setup**

**9KHz~ 30MHz**

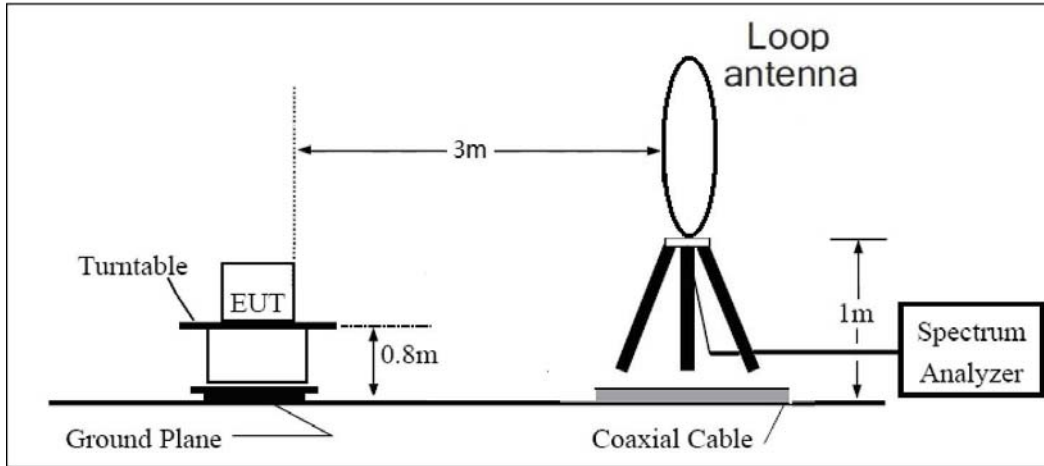

**30MHz~ 1GHz**

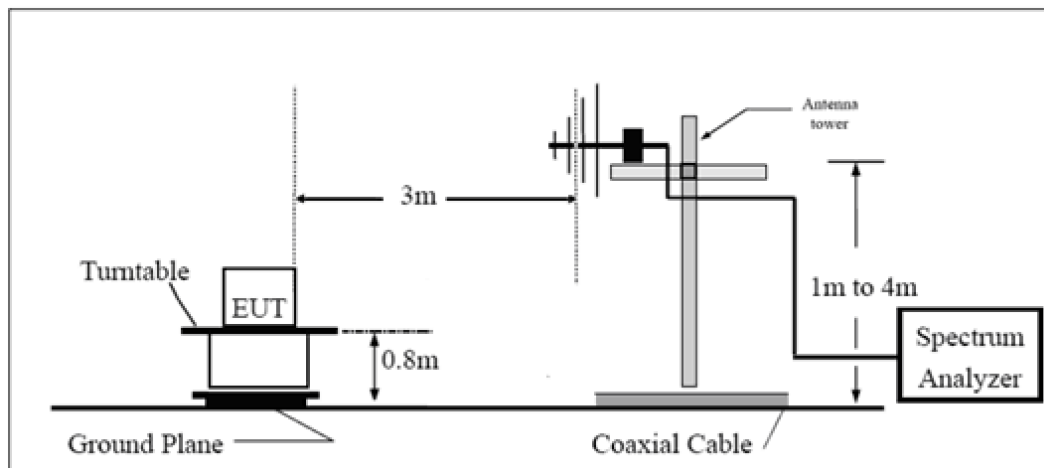

**Above 1GHz**

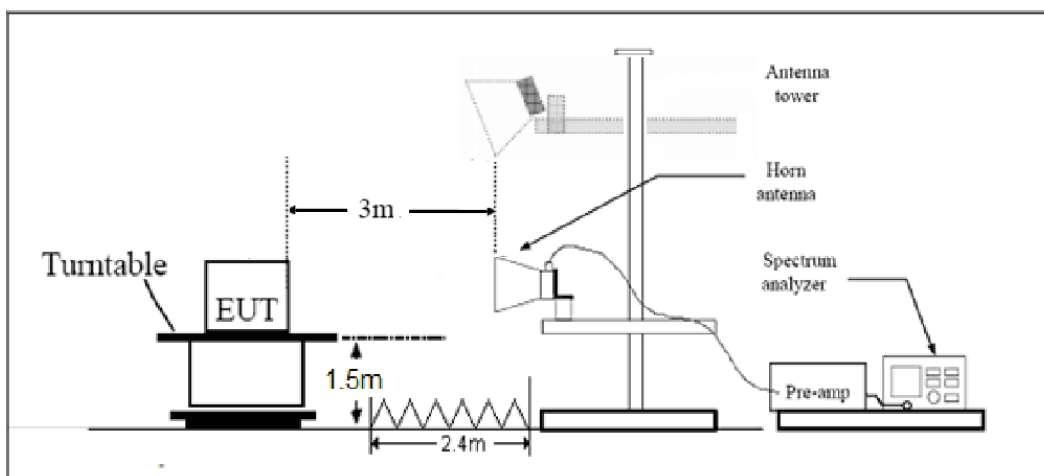

Note: Area side:2.4mX3.6m



## Limits

Rule Part 90.691 specifies that “The power of any emission outside of the authorized operating frequency ranges must be attenuated below the transmitting power (P) by a factor of at least  $43 + 10 \log(P)$  dB.”

Limit	-13 dBm
-------	---------

## Measurement Uncertainty

The assessed measurement uncertainty to ensure 95% confidence level for the normal distribution is with the coverage factor  $k = 1.96$ ,  $U = 3.55$  dB.

## Test Results

Refer to the section 6.7 of this report for test data.



## 6. Test Results

### 6.1. RF Power Output and Effective Radiated Power

Band	Bandwidth (MHz)	UL Channel	RB Size	RB Position	Modulation	Power (dBm)	ERP (dBm)
LTE Band26	1.4	26697	1	#0	QPSK	22.43	20.28
LTE Band26	1.4	26697	1	#Mid	QPSK	22.75	20.60
LTE Band26	1.4	26697	1	#Max	QPSK	22.43	20.28
LTE Band26	1.4	26697	3	#0	QPSK	22.51	20.36
LTE Band26	1.4	26697	3	#Mid	QPSK	22.48	20.33
LTE Band26	1.4	26697	3	#Max	QPSK	22.46	20.31
LTE Band26	1.4	26697	6	#0	QPSK	21.46	19.31
LTE Band26	1.4	26697	1	#0	16QAM	21.34	19.19
LTE Band26	1.4	26697	1	#Mid	16QAM	21.43	19.28
LTE Band26	1.4	26697	1	#Max	16QAM	21.31	19.16
LTE Band26	1.4	26697	3	#0	16QAM	21.41	19.26
LTE Band26	1.4	26697	3	#Mid	16QAM	21.41	19.26
LTE Band26	1.4	26697	3	#Max	16QAM	21.40	19.25
LTE Band26	1.4	26697	6	#0	16QAM	20.47	18.32
LTE Band26	1.4	26740	1	#0	QPSK	22.48	20.33
LTE Band26	1.4	26740	1	#Mid	QPSK	22.63	20.48
LTE Band26	1.4	26740	1	#Max	QPSK	22.46	20.31
LTE Band26	1.4	26740	3	#0	QPSK	22.45	20.30
LTE Band26	1.4	26740	3	#Mid	QPSK	22.45	20.30
LTE Band26	1.4	26740	3	#Max	QPSK	22.44	20.29
LTE Band26	1.4	26740	6	#0	QPSK	21.39	19.24
LTE Band26	1.4	26740	1	#0	16QAM	21.38	19.23
LTE Band26	1.4	26740	1	#Mid	16QAM	21.58	19.43
LTE Band26	1.4	26740	1	#Max	16QAM	21.39	19.24
LTE Band26	1.4	26740	3	#0	16QAM	21.53	19.38
LTE Band26	1.4	26740	3	#Mid	16QAM	21.55	19.40
LTE Band26	1.4	26740	3	#Max	16QAM	21.57	19.42
LTE Band26	1.4	26740	6	#0	16QAM	20.51	18.36
LTE Band26	1.4	26783	1	#0	QPSK	22.39	20.24
LTE Band26	1.4	26783	1	#Mid	QPSK	22.58	20.43
LTE Band26	1.4	26783	1	#Max	QPSK	22.39	20.24
LTE Band26	1.4	26783	3	#0	QPSK	22.44	20.29
LTE Band26	1.4	26783	3	#Mid	QPSK	22.41	20.26
LTE Band26	1.4	26783	3	#Max	QPSK	22.39	20.24
LTE Band26	1.4	26783	6	#0	QPSK	21.41	19.26
LTE Band26	1.4	26783	1	#0	16QAM	21.51	19.36



LTE Band26	1.4	26783	1	#Mid	16QAM	21.76	19.61
LTE Band26	1.4	26783	1	#Max	16QAM	21.54	19.39
LTE Band26	1.4	26783	3	#0	16QAM	21.39	19.24
LTE Band26	1.4	26783	3	#Mid	16QAM	21.40	19.25
LTE Band26	1.4	26783	3	#Max	16QAM	21.44	19.29
LTE Band26	1.4	26783	6	#0	16QAM	20.43	18.28
LTE Band26	3	26705	1	#0	QPSK	22.50	20.35
LTE Band26	3	26705	1	#Mid	QPSK	22.52	20.37
LTE Band26	3	26705	1	#Max	QPSK	22.50	20.35
LTE Band26	3	26705	8	#0	QPSK	21.44	19.29
LTE Band26	3	26705	8	#Mid	QPSK	21.45	19.30
LTE Band26	3	26705	8	#Max	QPSK	21.46	19.31
LTE Band26	3	26705	15	#0	QPSK	21.39	19.24
LTE Band26	3	26705	1	#0	16QAM	21.34	19.19
LTE Band26	3	26705	1	#Mid	16QAM	21.34	19.19
LTE Band26	3	26705	1	#Max	16QAM	21.30	19.15
LTE Band26	3	26705	8	#0	16QAM	20.47	18.32
LTE Band26	3	26705	8	#Mid	16QAM	20.47	18.32
LTE Band26	3	26705	8	#Max	16QAM	20.51	18.36
LTE Band26	3	26705	15	#0	16QAM	20.47	18.32
LTE Band26	3	26740	1	#0	QPSK	22.46	20.31
LTE Band26	3	26740	1	#Mid	QPSK	22.39	20.24
LTE Band26	3	26740	1	#Max	QPSK	22.40	20.25
LTE Band26	3	26740	8	#0	QPSK	21.41	19.26
LTE Band26	3	26740	8	#Mid	QPSK	21.41	19.26
LTE Band26	3	26740	8	#Max	QPSK	21.44	19.29
LTE Band26	3	26740	15	#0	QPSK	21.43	19.28
LTE Band26	3	26740	1	#0	16QAM	21.73	19.58
LTE Band26	3	26740	1	#Mid	16QAM	21.63	19.48
LTE Band26	3	26740	1	#Max	16QAM	21.69	19.54
LTE Band26	3	26740	8	#0	16QAM	20.46	18.31
LTE Band26	3	26740	8	#Mid	16QAM	20.46	18.31
LTE Band26	3	26740	8	#Max	16QAM	20.48	18.33
LTE Band26	3	26740	15	#0	16QAM	20.41	18.26
LTE Band26	3	26775	1	#0	QPSK	22.44	20.29
LTE Band26	3	26775	1	#Mid	QPSK	22.43	20.28
LTE Band26	3	26775	1	#Max	QPSK	22.44	20.29
LTE Band26	3	26775	8	#0	QPSK	21.40	19.25
LTE Band26	3	26775	8	#Mid	QPSK	21.41	19.26
LTE Band26	3	26775	8	#Max	QPSK	21.38	19.23
LTE Band26	3	26775	15	#0	QPSK	21.34	19.19
LTE Band26	3	26775	1	#0	16QAM	21.58	19.43
LTE Band26	3	26775	1	#Mid	16QAM	21.55	19.40



LTE Band26	3	26775	1	#Max	16QAM	21.52	19.37
LTE Band26	3	26775	8	#0	16QAM	20.44	18.29
LTE Band26	3	26775	8	#Mid	16QAM	20.46	18.31
LTE Band26	3	26775	8	#Max	16QAM	20.41	18.26
LTE Band26	3	26775	15	#0	16QAM	20.33	18.18
LTE Band26	5	26715	1	#0	QPSK	22.36	20.21
LTE Band26	5	26715	1	#Mid	QPSK	22.48	20.33
LTE Band26	5	26715	1	#Max	QPSK	22.34	20.19
LTE Band26	5	26715	12	#0	QPSK	21.36	19.21
LTE Band26	5	26715	12	#Mid	QPSK	21.35	19.20
LTE Band26	5	26715	12	#Max	QPSK	21.44	19.29
LTE Band26	5	26715	25	#0	QPSK	21.41	19.26
LTE Band26	5	26715	1	#0	16QAM	21.67	19.52
LTE Band26	5	26715	1	#Mid	16QAM	21.76	19.61
LTE Band26	5	26715	1	#Max	16QAM	21.63	19.48
LTE Band26	5	26715	12	#0	16QAM	20.34	18.19
LTE Band26	5	26715	12	#Mid	16QAM	20.32	18.17
LTE Band26	5	26715	12	#Max	16QAM	20.42	18.27
LTE Band26	5	26715	25	#0	16QAM	20.48	18.33
LTE Band26	5	26740	1	#0	QPSK	22.33	20.18
LTE Band26	5	26740	1	#Mid	QPSK	22.48	20.33
LTE Band26	5	26740	1	#Max	QPSK	22.29	20.14
LTE Band26	5	26740	12	#0	QPSK	21.39	19.24
LTE Band26	5	26740	12	#Mid	QPSK	21.36	19.21
LTE Band26	5	26740	12	#Max	QPSK	21.43	19.28
LTE Band26	5	26740	25	#0	QPSK	21.43	19.28
LTE Band26	5	26740	1	#0	16QAM	21.48	19.33
LTE Band26	5	26740	1	#Mid	16QAM	21.49	19.34
LTE Band26	5	26740	1	#Max	16QAM	21.41	19.26
LTE Band26	5	26740	12	#0	16QAM	20.32	18.17
LTE Band26	5	26740	12	#Mid	16QAM	20.22	18.07
LTE Band26	5	26740	12	#Max	16QAM	20.38	18.23
LTE Band26	5	26740	25	#0	16QAM	20.47	18.32
LTE Band26	5	26765	1	#0	QPSK	22.16	20.01
LTE Band26	5	26765	1	#Mid	QPSK	22.31	20.16
LTE Band26	5	26765	1	#Max	QPSK	22.02	19.87
LTE Band26	5	26765	12	#0	QPSK	21.28	19.13
LTE Band26	5	26765	12	#Mid	QPSK	21.39	19.24
LTE Band26	5	26765	12	#Max	QPSK	21.25	19.10
LTE Band26	5	26765	25	#0	QPSK	21.26	19.11
LTE Band26	5	26765	1	#0	16QAM	21.42	19.27
LTE Band26	5	26765	1	#Mid	16QAM	21.61	19.46
LTE Band26	5	26765	1	#Max	16QAM	21.30	19.15



LTE Band26	5	26765	12	#0	16QAM	20.25	18.10
LTE Band26	5	26765	12	#Mid	16QAM	20.25	18.10
LTE Band26	5	26765	12	#Max	16QAM	20.26	18.11
LTE Band26	5	26765	25	#0	16QAM	20.33	18.18
LTE Band26	10	26740	1	#0	QPSK	22.45	20.30
LTE Band26	10	26740	1	#Mid	QPSK	22.64	20.49
LTE Band26	10	26740	1	#Max	QPSK	22.23	20.08
LTE Band26	10	26740	25	#0	QPSK	21.05	18.90
LTE Band26	10	26740	25	#Mid	QPSK	21.09	18.94
LTE Band26	10	26740	25	#Max	QPSK	21.37	19.22
LTE Band26	10	26740	50	#0	QPSK	21.19	19.04
LTE Band26	10	26740	1	#0	16QAM	21.27	19.12
LTE Band26	10	26740	1	#Mid	16QAM	21.44	19.29
LTE Band26	10	26740	1	#Max	16QAM	21.19	19.04
LTE Band26	10	26740	25	#0	16QAM	20.05	17.90
LTE Band26	10	26740	25	#Mid	16QAM	20.14	17.99
LTE Band26	10	26740	25	#Max	16QAM	20.32	18.17
LTE Band26	10	26740	50	#0	16QAM	20.37	18.22
LTE Band26	1.4	26697	1	#0	64QAM	20.61	18.46
LTE Band26	1.4	26697	1	#Mid	64QAM	20.79	18.64
LTE Band26	1.4	26697	1	#Max	64QAM	20.59	18.44
LTE Band26	1.4	26697	3	#0	64QAM	20.74	18.59
LTE Band26	1.4	26697	3	#Mid	64QAM	20.73	18.58
LTE Band26	1.4	26697	3	#Max	64QAM	20.71	18.56
LTE Band26	1.4	26697	6	#0	64QAM	19.78	17.63
LTE Band26	1.4	26740	1	#0	64QAM	20.71	18.56
LTE Band26	1.4	26740	1	#Mid	64QAM	20.94	18.79
LTE Band26	1.4	26740	1	#Max	64QAM	20.71	18.56
LTE Band26	1.4	26740	3	#0	64QAM	20.86	18.71
LTE Band26	1.4	26740	3	#Mid	64QAM	20.86	18.71
LTE Band26	1.4	26740	3	#Max	64QAM	20.89	18.74
LTE Band26	1.4	26740	6	#0	64QAM	19.84	17.69
LTE Band26	1.4	26783	1	#0	64QAM	20.82	18.67
LTE Band26	1.4	26783	1	#Mid	64QAM	21.07	18.92
LTE Band26	1.4	26783	1	#Max	64QAM	20.86	18.71
LTE Band26	1.4	26783	3	#0	64QAM	20.75	18.60
LTE Band26	1.4	26783	3	#Mid	64QAM	20.74	18.59
LTE Band26	1.4	26783	3	#Max	64QAM	20.77	18.62
LTE Band26	1.4	26783	6	#0	64QAM	19.75	17.60
LTE Band26	3	26705	1	#0	64QAM	20.92	18.77
LTE Band26	3	26705	1	#Mid	64QAM	20.95	18.80
LTE Band26	3	26705	1	#Max	64QAM	20.86	18.71
LTE Band26	3	26705	8	#0	64QAM	19.75	17.60



LTE Band26	3	26705	8	#Mid	64QAM	19.75	17.60
LTE Band26	3	26705	8	#Max	64QAM	19.80	17.65
LTE Band26	3	26705	15	#0	64QAM	19.67	17.52
LTE Band26	3	26740	1	#0	64QAM	20.63	18.48
LTE Band26	3	26740	1	#Mid	64QAM	20.66	18.51
LTE Band26	3	26740	1	#Max	64QAM	20.64	18.49
LTE Band26	3	26740	8	#0	64QAM	19.78	17.63
LTE Band26	3	26740	8	#Mid	64QAM	19.76	17.61
LTE Band26	3	26740	8	#Max	64QAM	19.75	17.60
LTE Band26	3	26740	15	#0	64QAM	19.76	17.61
LTE Band26	3	26775	1	#0	64QAM	21.01	18.86
LTE Band26	3	26775	1	#Mid	64QAM	20.85	18.70
LTE Band26	3	26775	1	#Max	64QAM	20.95	18.80
LTE Band26	3	26775	8	#0	64QAM	19.66	17.51
LTE Band26	3	26775	8	#Mid	64QAM	19.42	17.27
LTE Band26	3	26775	8	#Max	64QAM	19.68	17.53
LTE Band26	3	26775	15	#0	64QAM	19.63	17.48
LTE Band26	5	26715	1	#0	64QAM	20.81	18.66
LTE Band26	5	26715	1	#Mid	64QAM	20.77	18.62
LTE Band26	5	26715	1	#Max	64QAM	20.46	18.31
LTE Band26	5	26715	12	#0	64QAM	19.10	16.95
LTE Band26	5	26715	12	#Mid	64QAM	19.13	16.98
LTE Band26	5	26715	12	#Max	64QAM	19.19	17.04
LTE Band26	5	26715	25	#0	64QAM	19.28	17.13
LTE Band26	5	26740	1	#0	64QAM	20.38	18.23
LTE Band26	5	26740	1	#Mid	64QAM	20.48	18.33
LTE Band26	5	26740	1	#Max	64QAM	20.33	18.18
LTE Band26	5	26740	12	#0	64QAM	19.14	16.99
LTE Band26	5	26740	12	#Mid	64QAM	19.17	17.02
LTE Band26	5	26740	12	#Max	64QAM	19.25	17.10
LTE Band26	5	26740	25	#0	64QAM	19.27	17.12
LTE Band26	5	26765	1	#0	64QAM	20.35	18.20
LTE Band26	5	26765	1	#Mid	64QAM	20.49	18.34
LTE Band26	5	26765	1	#Max	64QAM	20.35	18.20
LTE Band26	5	26765	12	#0	64QAM	19.16	17.01
LTE Band26	5	26765	12	#Mid	64QAM	19.20	17.05
LTE Band26	5	26765	12	#Max	64QAM	19.22	17.07
LTE Band26	5	26765	25	#0	64QAM	19.29	17.14
LTE Band26	10	26740	1	#0	64QAM	20.91	18.76
LTE Band26	10	26740	1	#Mid	64QAM	21.09	18.94
LTE Band26	10	26740	1	#Max	64QAM	20.91	18.76
LTE Band26	10	26740	25	#0	64QAM	19.74	17.59
LTE Band26	10	26740	25	#Mid	64QAM	19.74	17.59



LTE Band26	10	26740	25	#Max	64QAM	19.86	17.71
LTE Band26	10	26740	50	#0	64QAM	19.80	17.65





## 6.2. Occupied Bandwidth

LTE Band 26							
RB	Modulation	Bandwidth (MHz)	Channel	Frequency (MHz)	99% Power Bandwidth(MHz)	-26dBc Bandwidth(MHz)	
100%	QPSK	1.4	26697	814.7	1.097	1.288	
			26740	819	1.092	1.279	
			26783	823.3	1.092	1.303	
		3	26705	815.5	2.688	2.933	
			26740	819	2.703	2.930	
			26775	822.5	2.692	2.907	
		5	26715	816.5	4.496	4.912	
			26740	819	4.493	4.839	
			26765	821.5	4.500	4.868	
		10	26740	819	8.978	9.641	
		16QAM	1.4	26697	814.7	1.095	1.296
				26740	819	1.095	1.301
	26783			823.3	1.087	1.277	
	3		26705	815.5	2.686	2.888	
			26740	819	2.694	2.910	
			26775	822.5	2.685	2.914	
	5		26715	816.5	4.499	4.895	
			26740	819	4.509	4.914	
			26765	821.5	4.496	4.946	
	10		26740	819	8.970	9.675	
	64QAM		1.4	26697	814.7	1.095	1.288
				26740	819	1.093	1.305
		26783		823.3	1.089	1.266	
		3	26705	815.5	2.687	2.908	
			26740	819	2.689	2.917	
			26775	822.5	2.691	2.925	
		5	26715	816.5	4.494	4.858	
			26740	819	4.505	4.914	
			26765	821.5	4.500	4.865	
		10	26740	819	9.008	9.626	

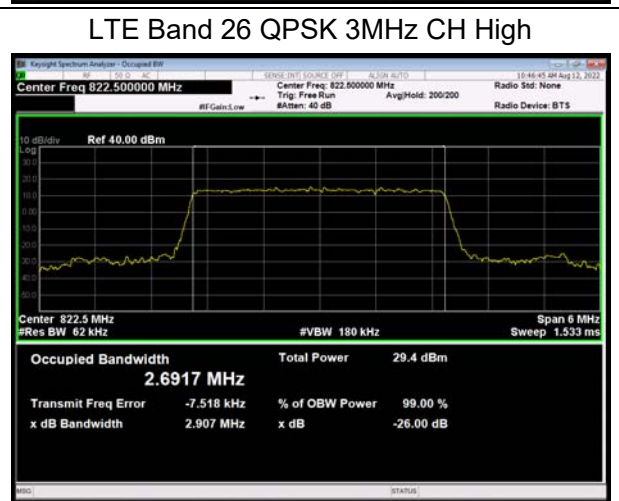
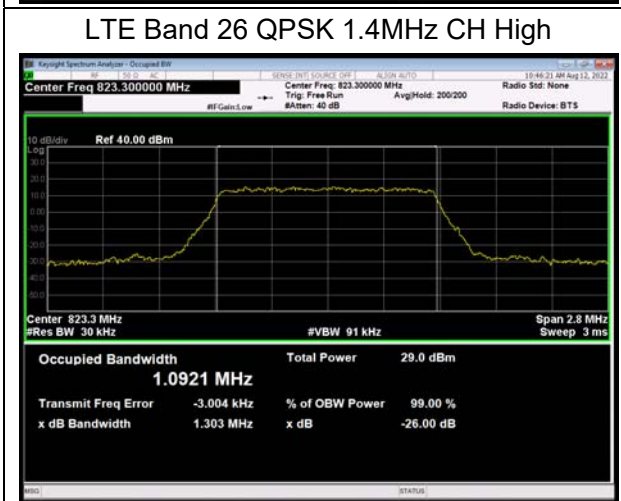
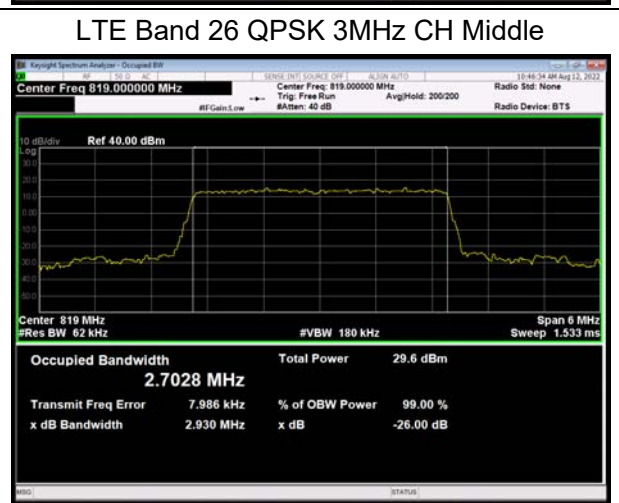
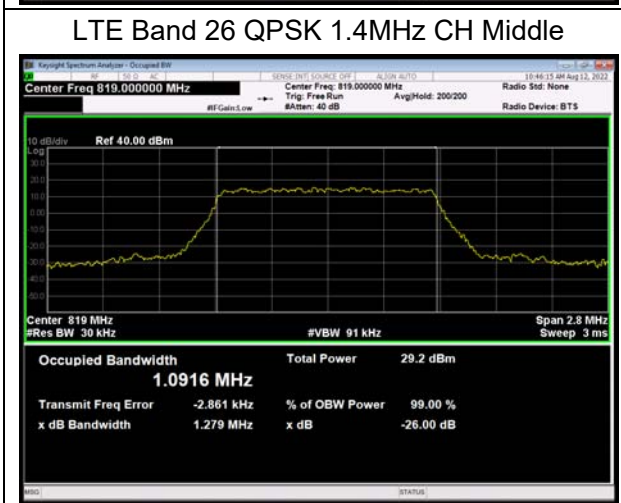
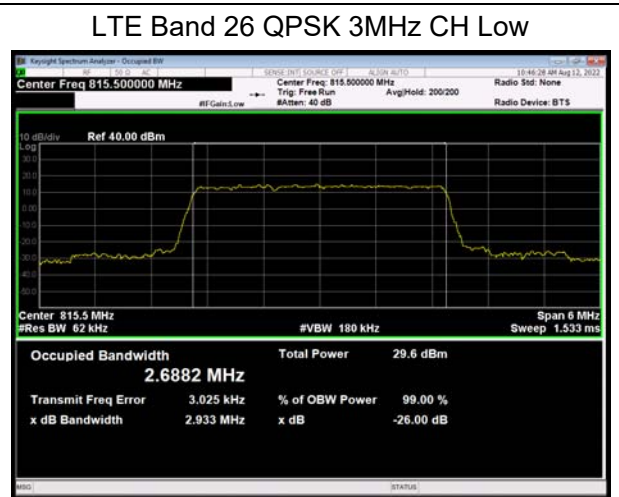
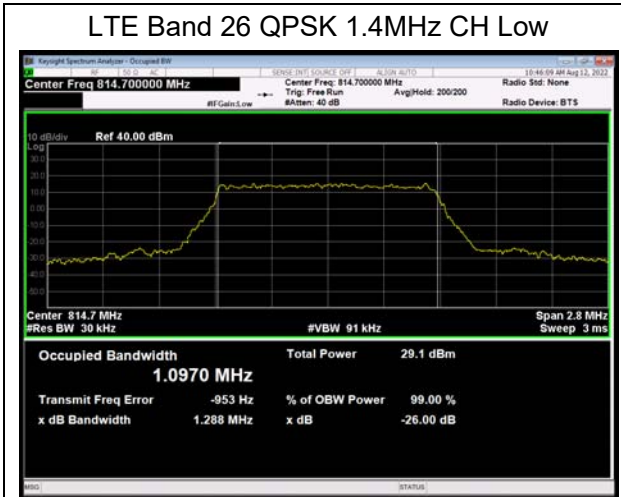



LTE Band 26 QPSK 5MHz CH Low

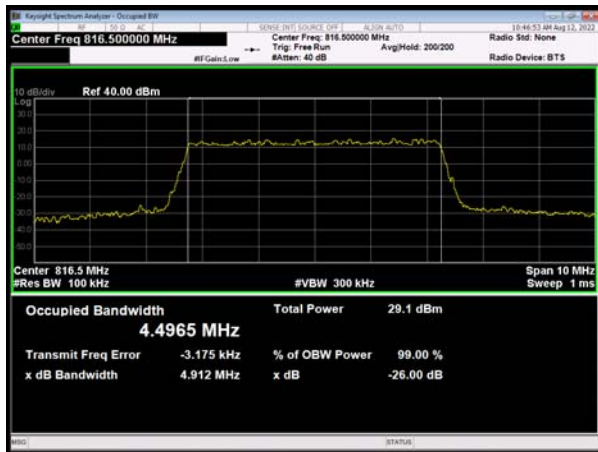

LTE Band 26 QPSK 5MHz CH Middle

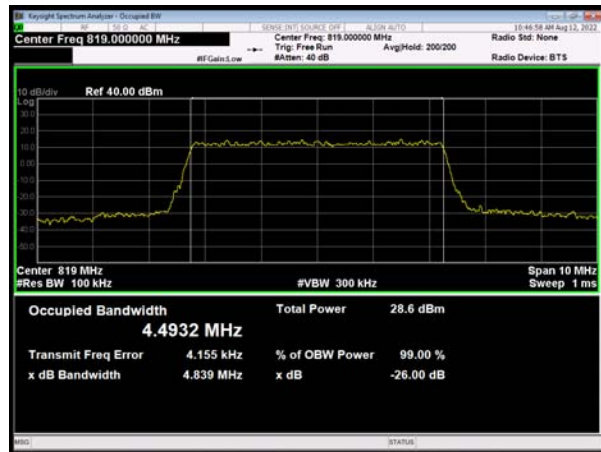

LTE Band 26 QPSK 5MHz CH High

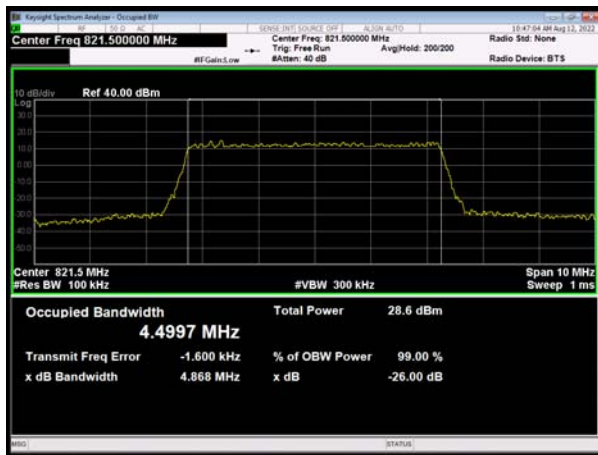

LTE Band 26 QPSK 10MHz CH Middle



LTE Band 26 16QAM 1.4MHz CH Low

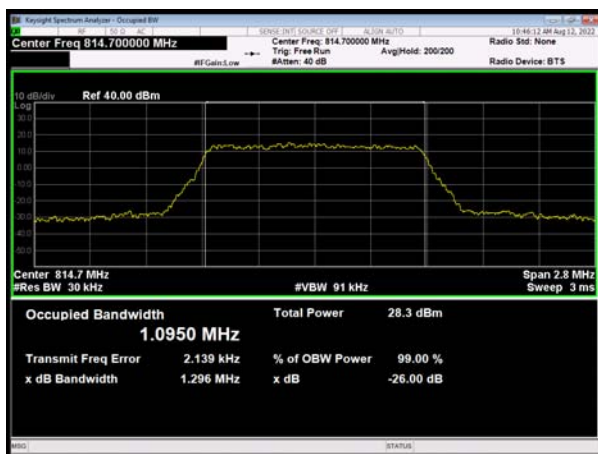

LTE Band 26 16QAM 3MHz CH Low





LTE Band 26 16QAM 1.4MHz CH Middle

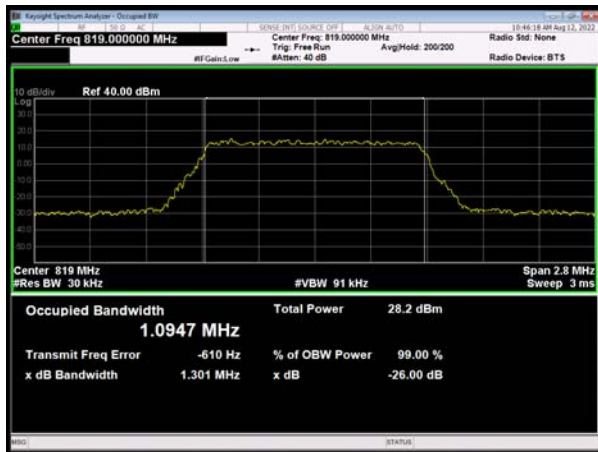

LTE Band 26 16QAM 3MHz CH Middle



LTE Band 26 16QAM 1.4MHz CH High

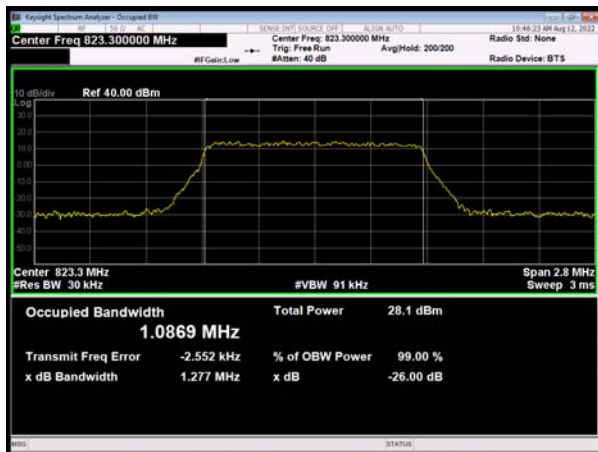

LTE Band 26 16QAM 3MHz CH High

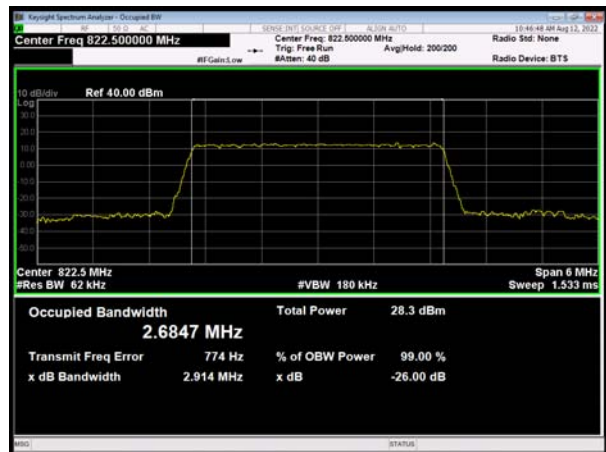

LTE Band 26 16QAM 5MHz CH Low

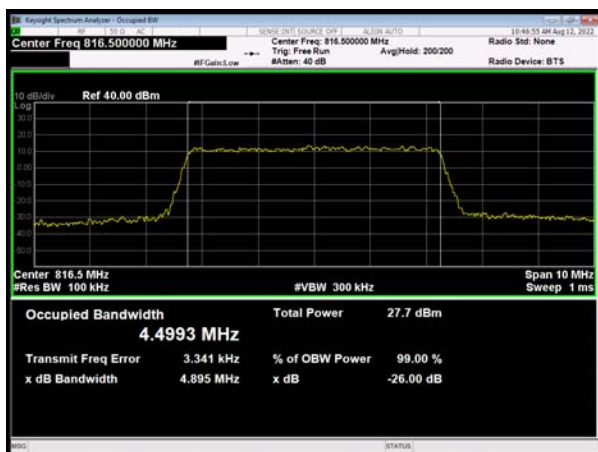

LTE Band 26 16QAM 5MHz CH Middle

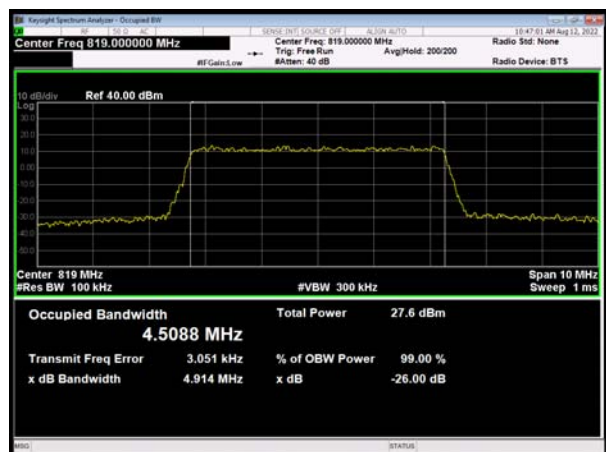

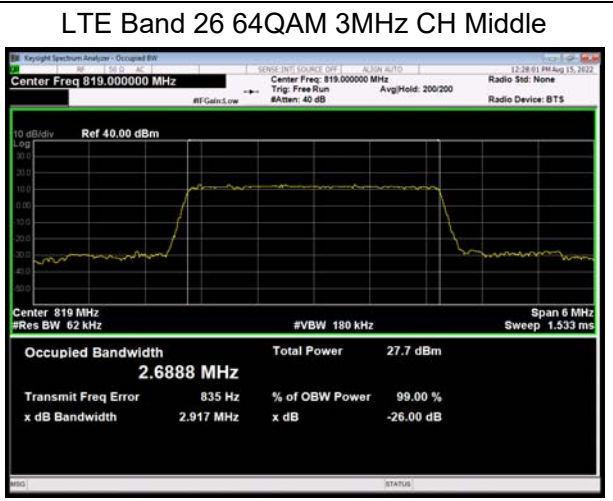
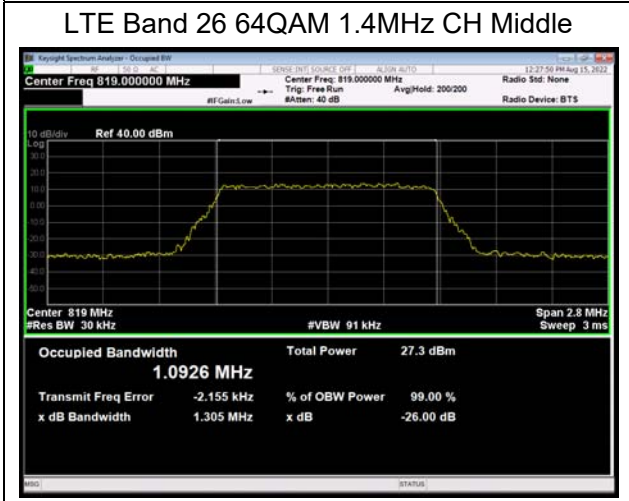
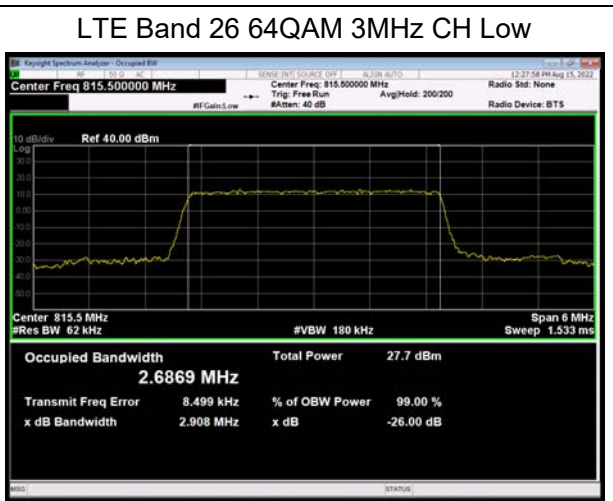
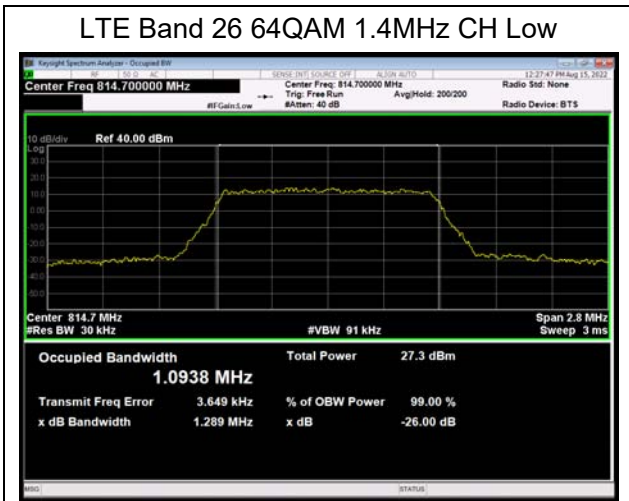
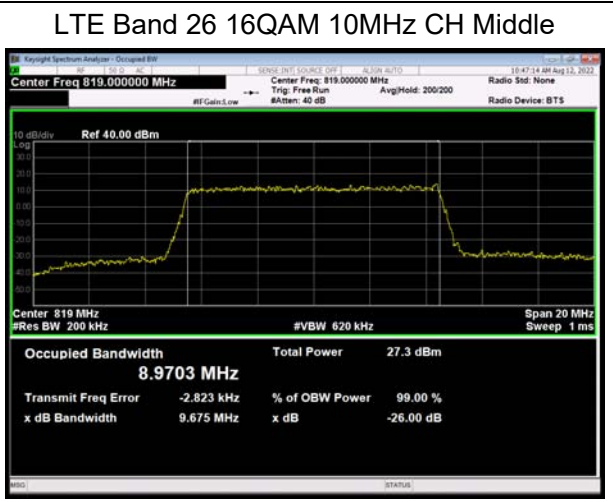
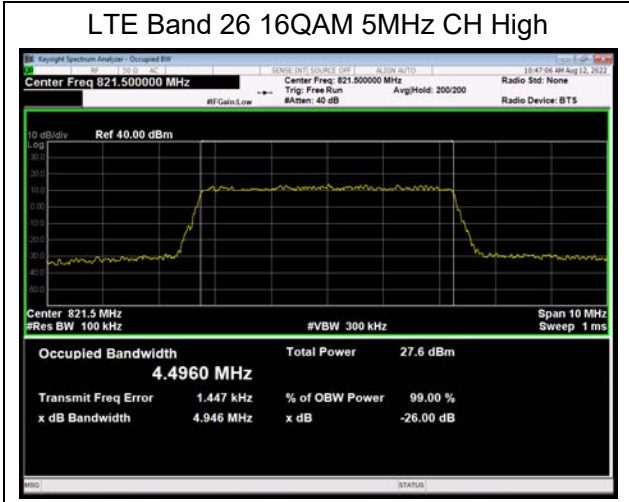

LTE Band 26 64QAM 1.4MHz CH High

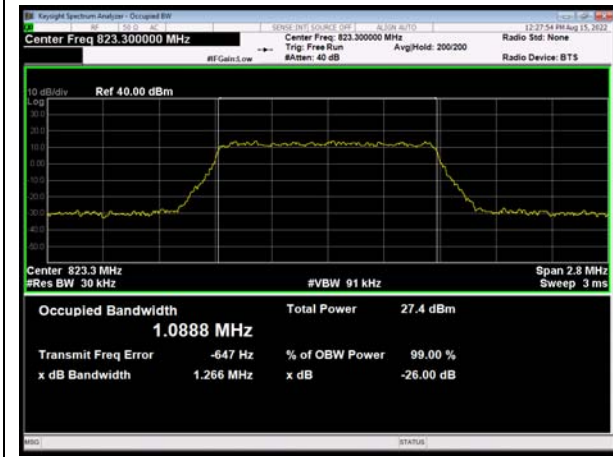

LTE Band 26 64QAM 3MHz CH High

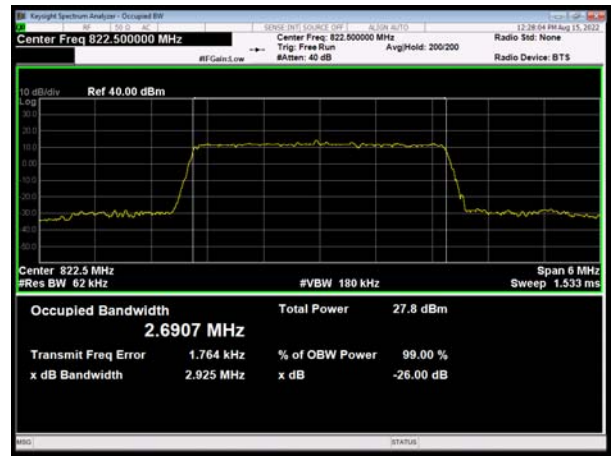

LTE Band 26 64QAM 5MHz CH Low

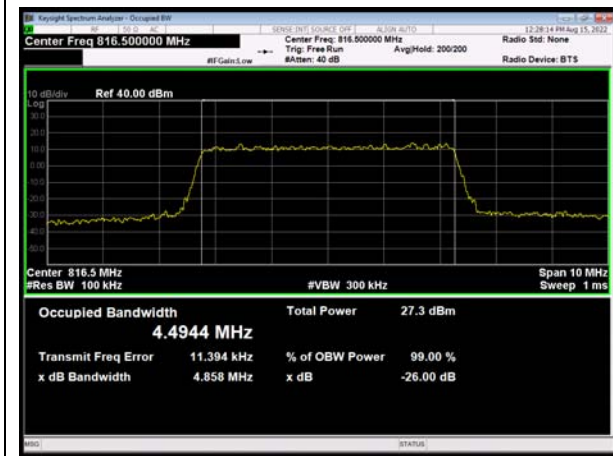

LTE Band 26 64QAM 5MHz CH Middle

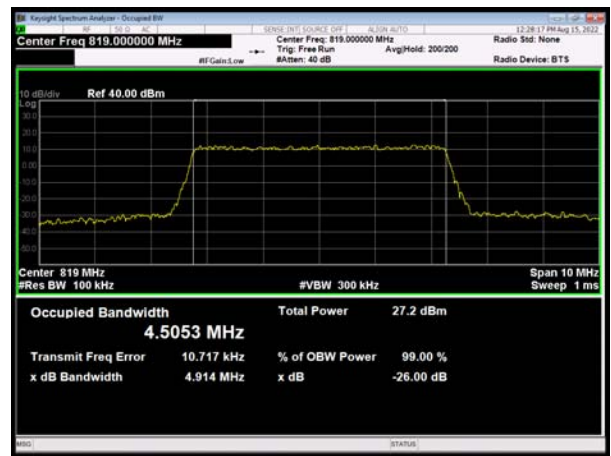

LTE Band 26 64QAM 5MHz CH High

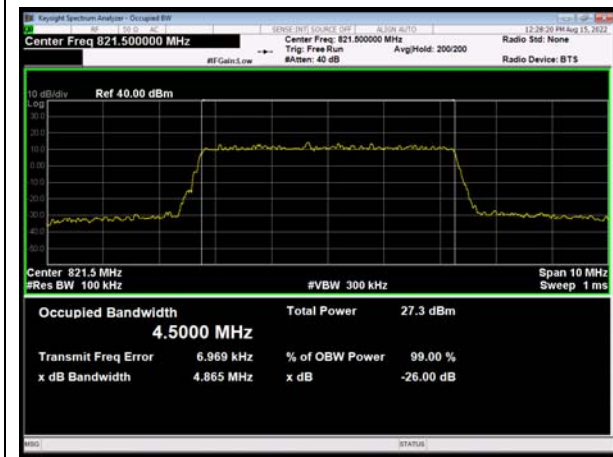

LTE Band 26 64QAM 10MHz CH Middle



### 6.3. Emission Mask

LTE Band 26 QPSK 1.4MHz CH-Low 1RB

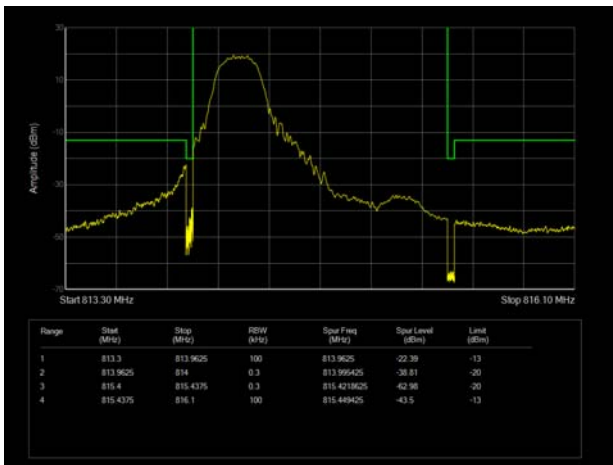

LTE Band 26 QPSK 1.4MHz CH-High 1RB

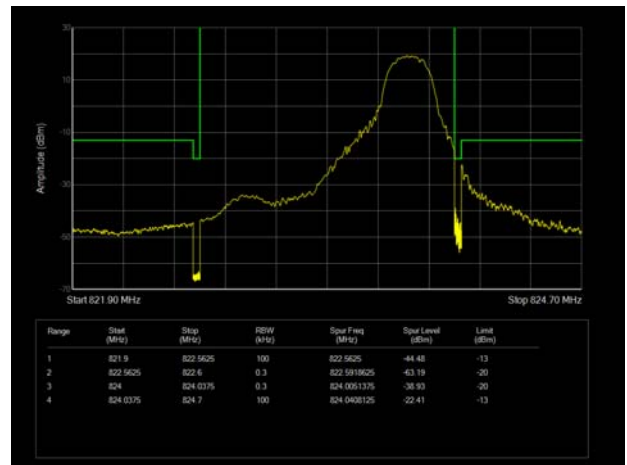

LTE Band 26 QPSK 1.4MHz CH-Low 100%RB

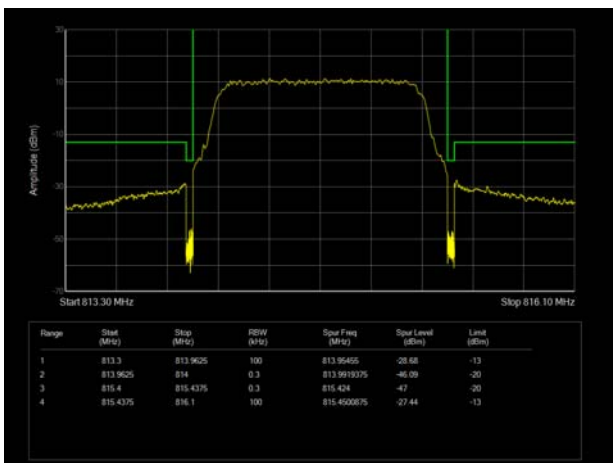

LTE Band 26 QPSK 1.4MHz CH-High 100%RB

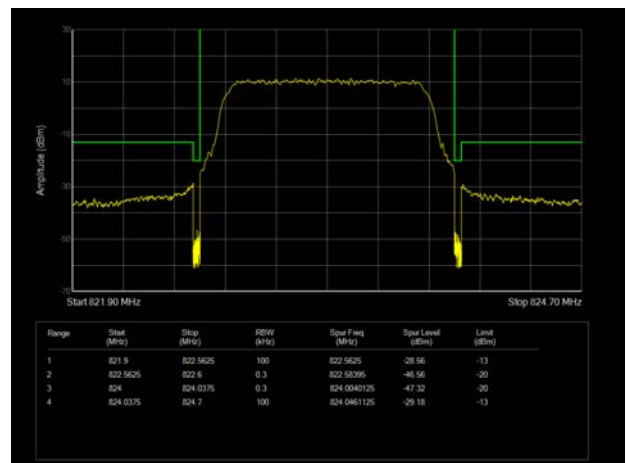

LTE Band 26 QPSK 3MHz CH-Low 1RB

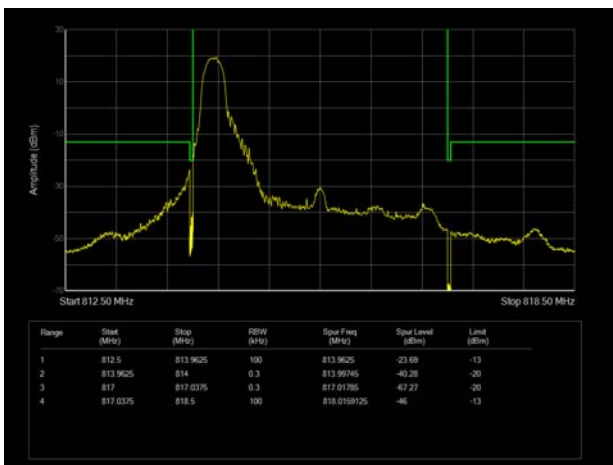

LTE Band 26 QPSK 3MHz CH-High 1RB

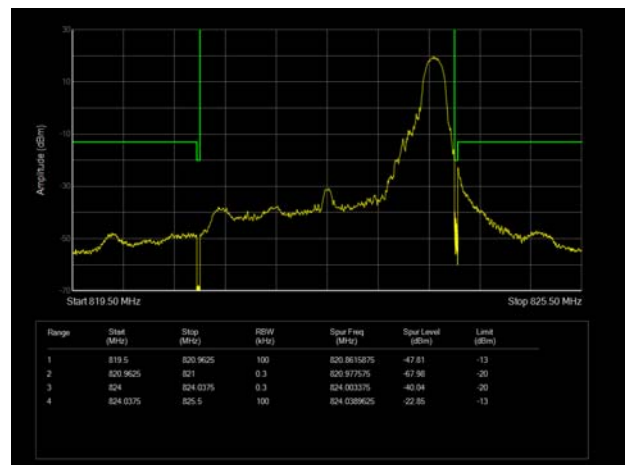

LTE Band 26 QPSK 3MHz CH-Low 100%RB

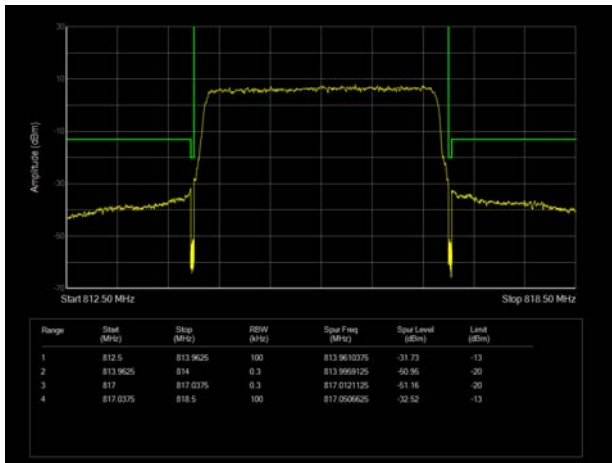

LTE Band 26 QPSK 3MHz CH-High 100%RB

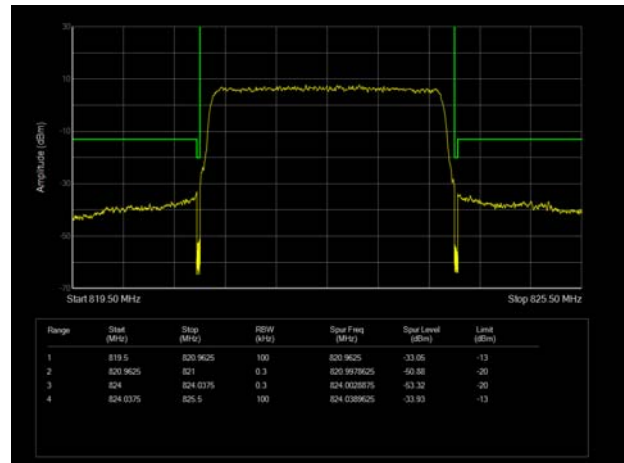

LTE Band 26 QPSK 5MHz CH-Low 1RB

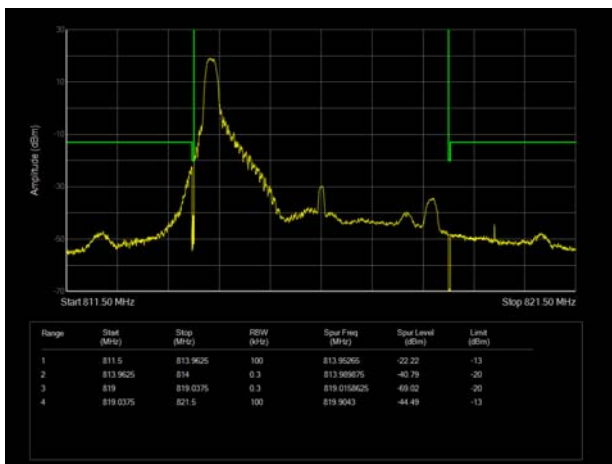

LTE Band 26 QPSK 5MHz CH-High 1RB

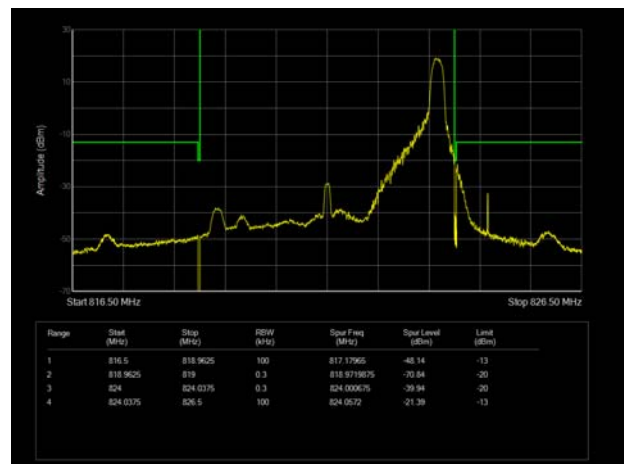

LTE Band 26 QPSK 5MHz CH-Low 100%RB

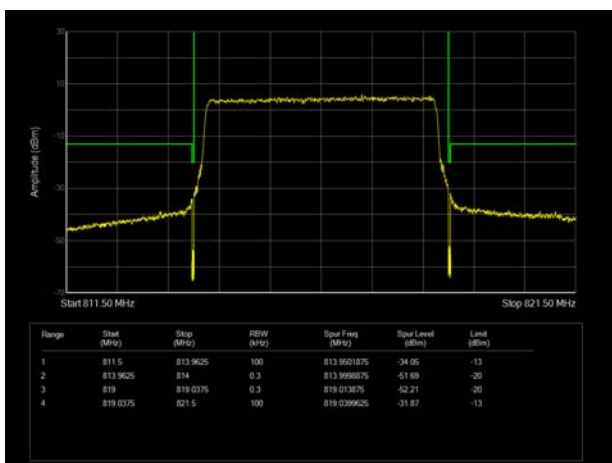

LTE Band 26 QPSK 5MHz CH-High 100%RB

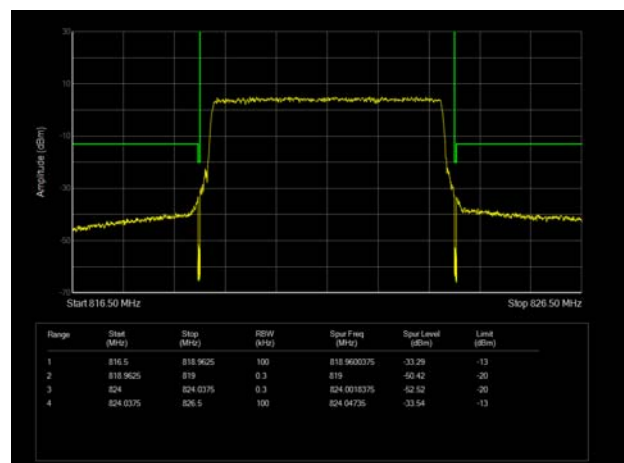



LTE Band 26 QPSK 10MHz CH-Low 1RB

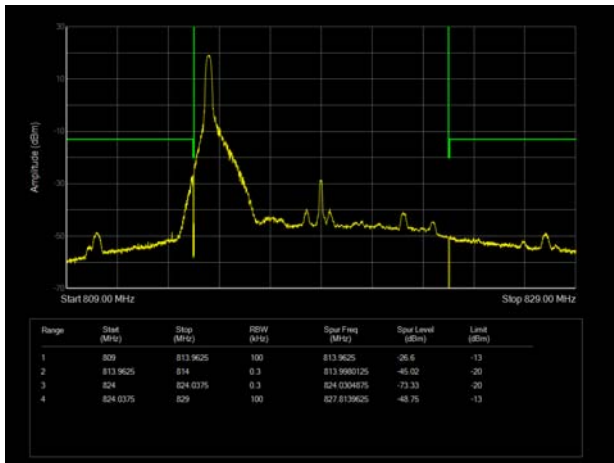

LTE Band 26 QPSK 10MHz CH-High 1RB

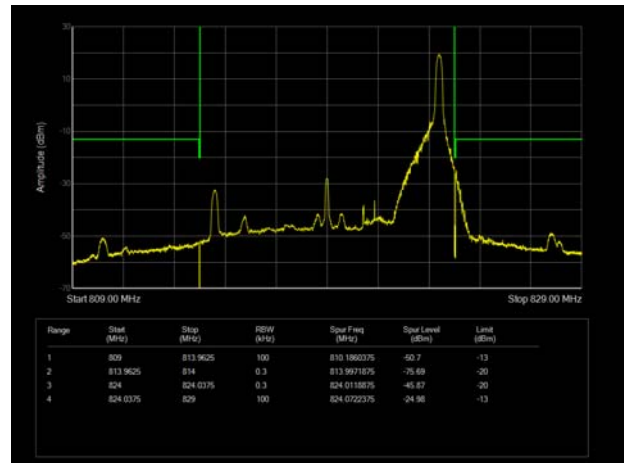

LTE Band 26 QPSK 10MHz CH-Low 100%RB

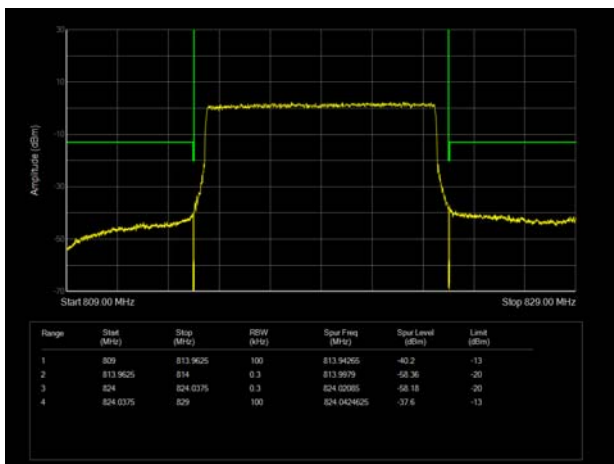

LTE Band 26 QPSK 10MHz CH-High 100%RB

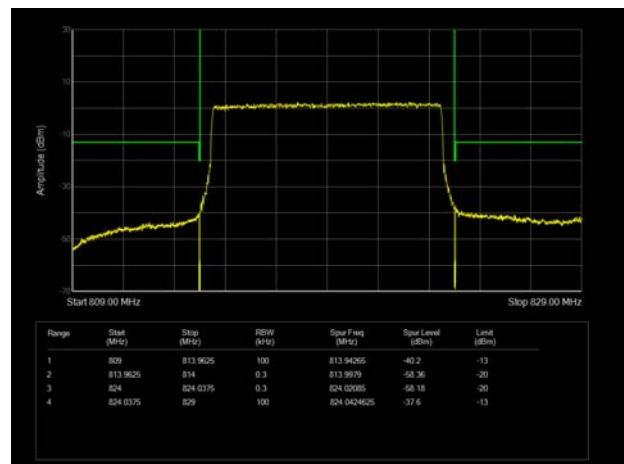

LTE Band 26 16QAM 1.4MHz CH-Low 1RB

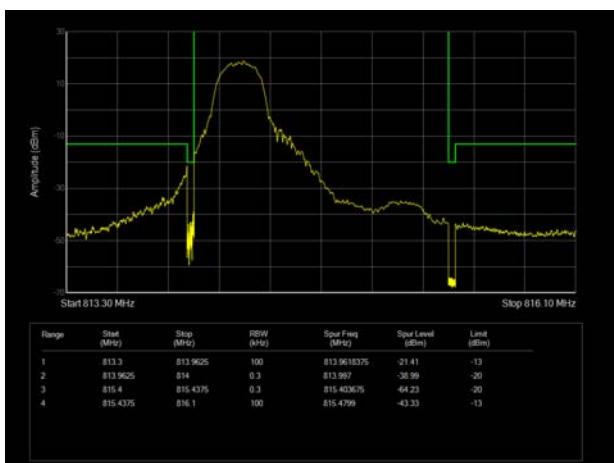

LTE Band 26 16QAM 1.4MHz CH-High 1RB

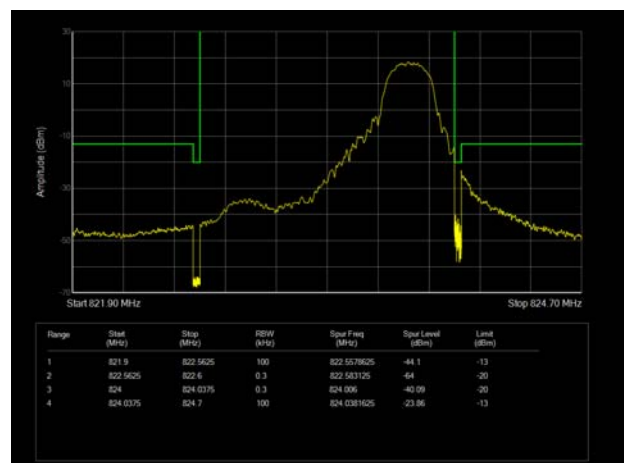

LTE Band 26 16QAM 1.4MHz CH-Low 100%RB

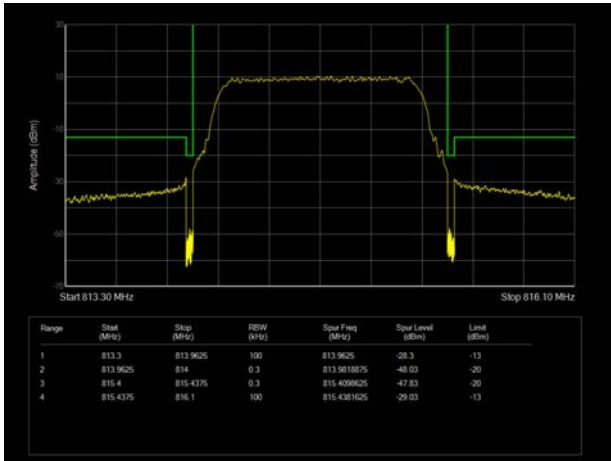

LTE Band 26 16QAM 1.4MHz CH-High 100%RB

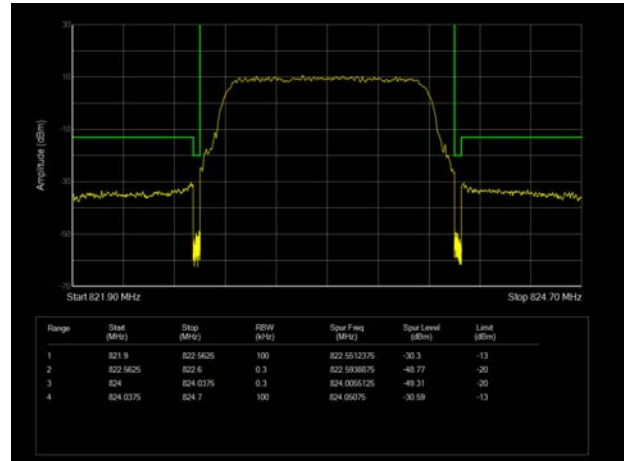

LTE Band 26 16QAM 3MHz CH-Low 1RB

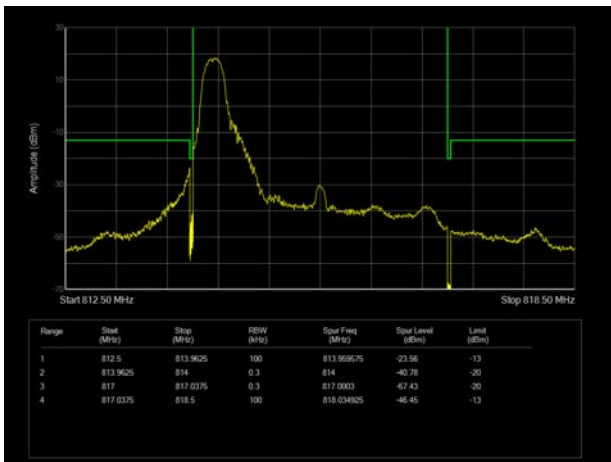

LTE Band 26 16QAM 3MHz CH-High 1RB

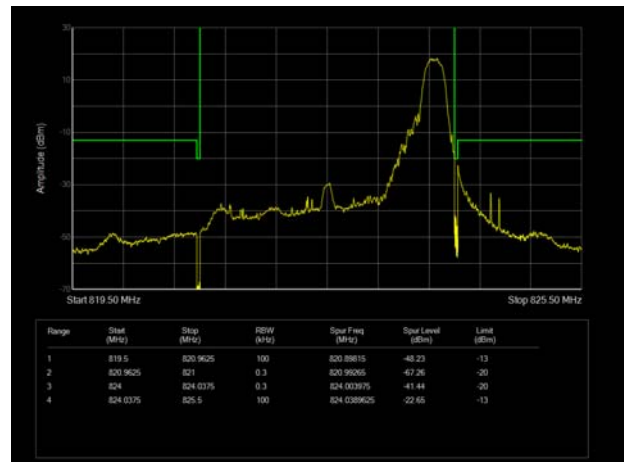

LTE Band 26 16QAM 3MHz CH-Low 100%RB

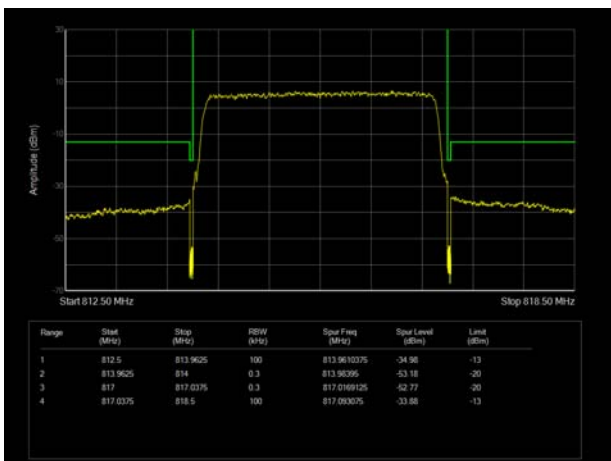

LTE Band 26 16QAM 3MHz CH-High 100%RB

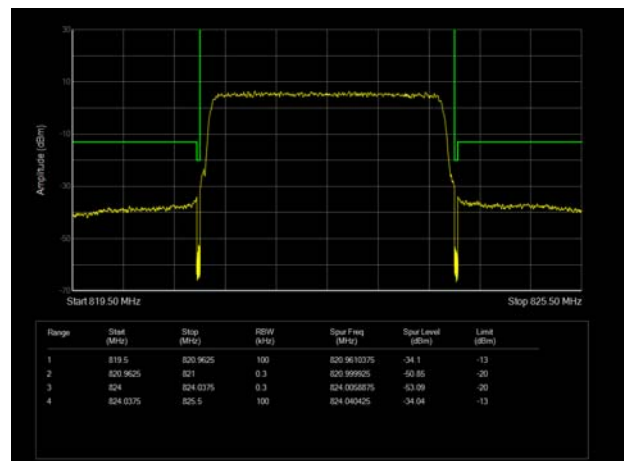

LTE Band 26 16QAM 5MHz CH-Low 1RB

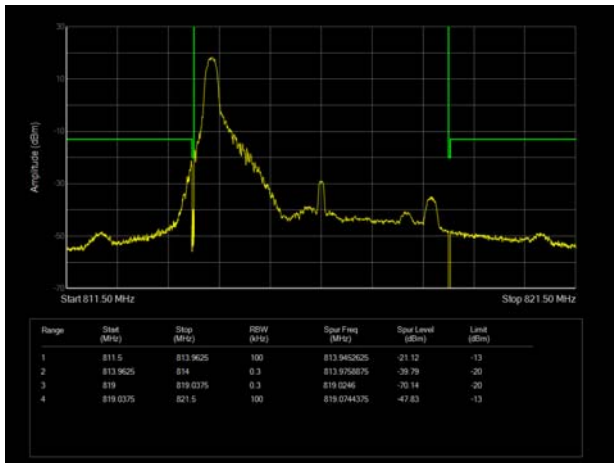

LTE Band 26 16QAM 5MHz CH-High 1RB

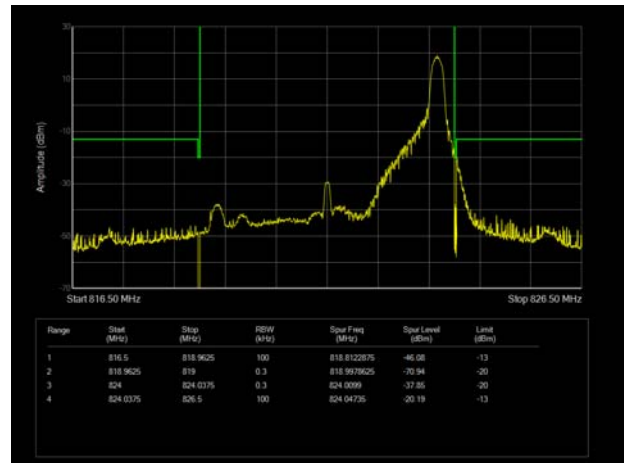

LTE Band 26 16QAM 5MHz CH-Low 100%RB

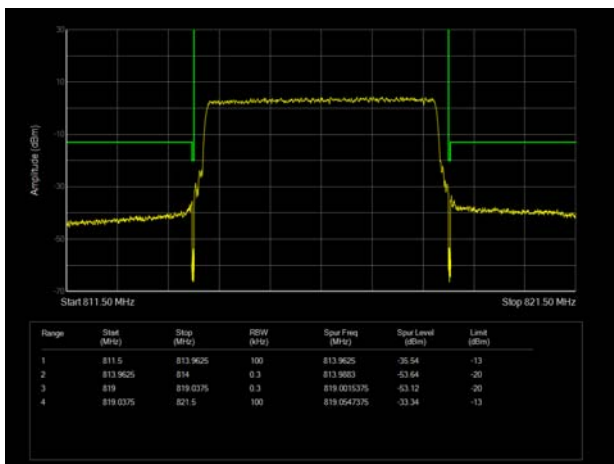

LTE Band 26 16QAM 5MHz CH-High 100%RB

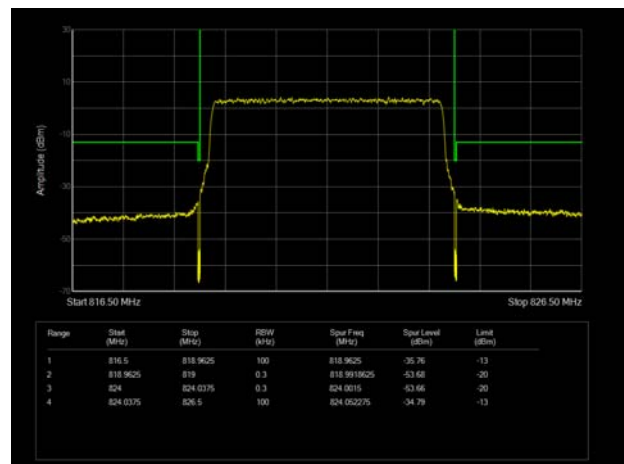

LTE Band 26 16QAM 10MHz CH-Low 1RB

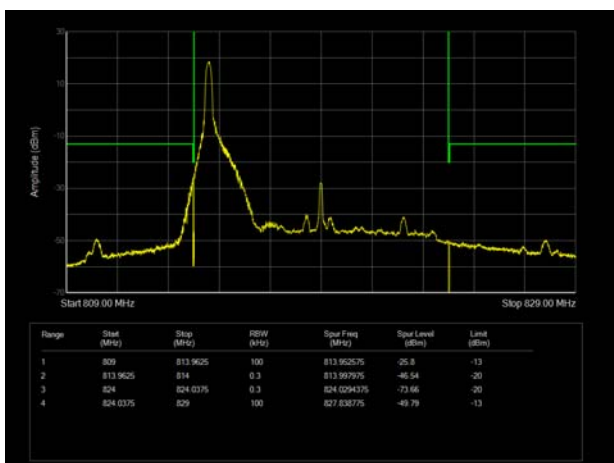

LTE Band 26 16QAM 10MHz CH-High 1RB

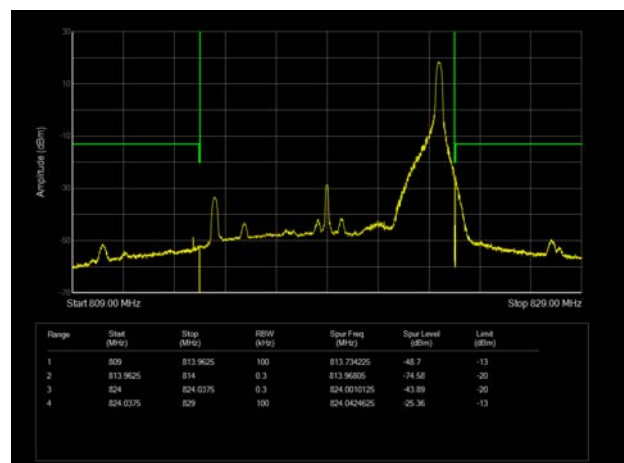

LTE Band 26 16QAM 10MHz CH-Low 100%RB

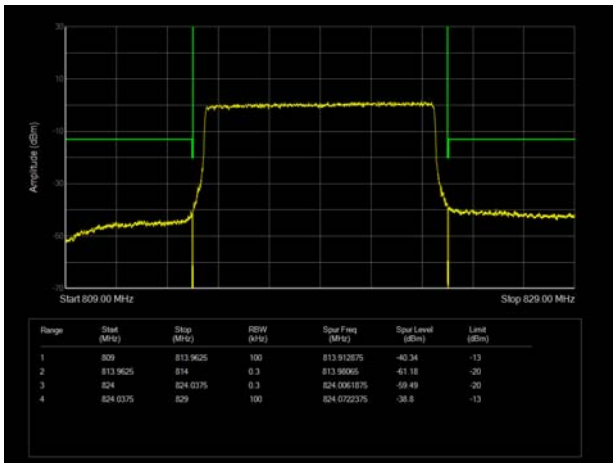

LTE Band 26 16QAM 10MHz CH-High 100%RB

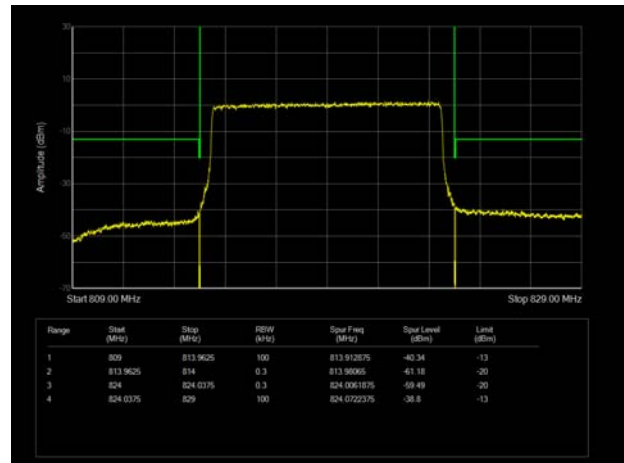

LTE Band 26 64QAM 1.4MHz CH-Low 1RB

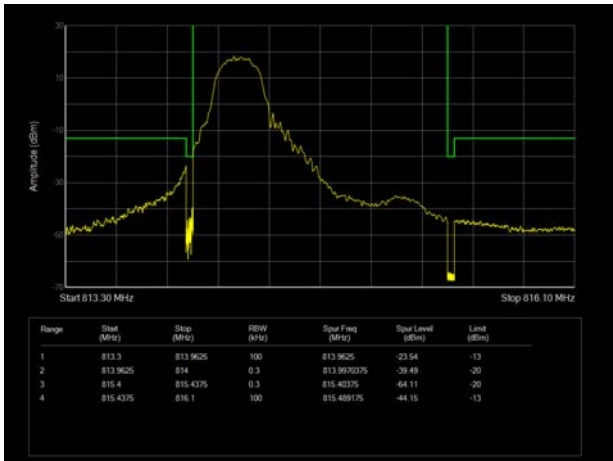

LTE Band 26 64QAM 1.4MHz CH-High 1RB

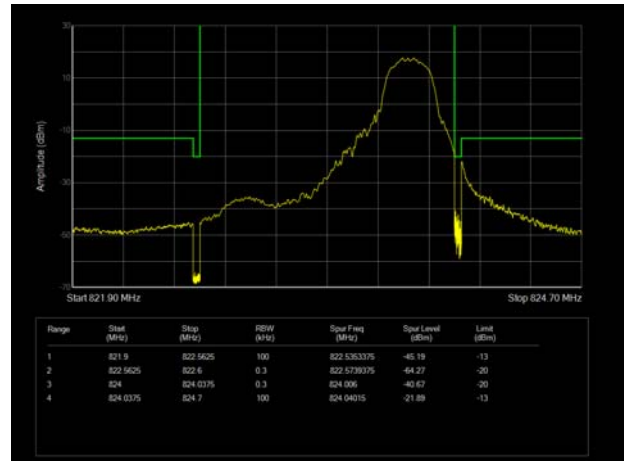

LTE Band 26 64QAM 1.4MHz CH-Low 100%RB

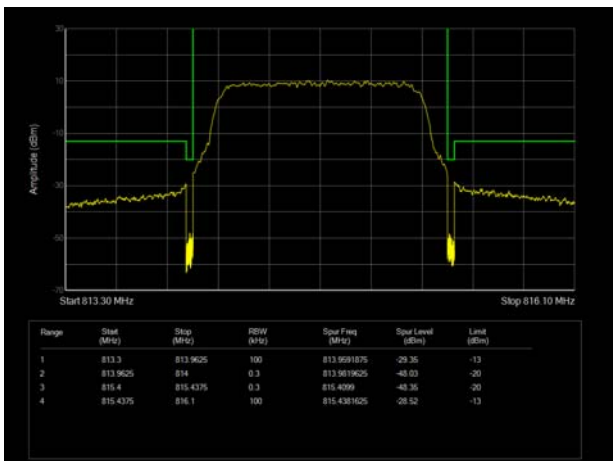

LTE Band 26 64QAM 1.4MHz CH-High 100%RB

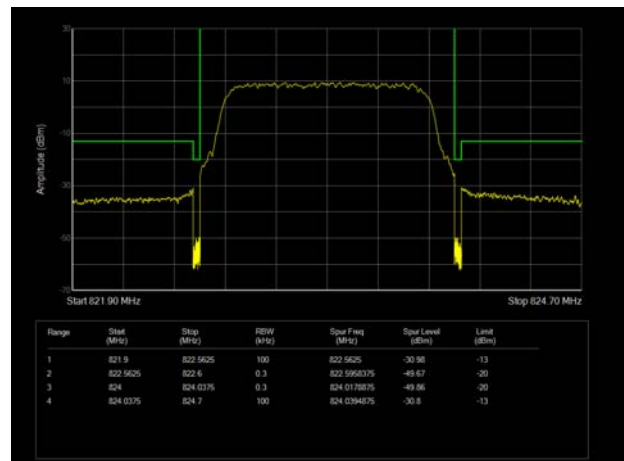

LTE Band 26 64QAM 3MHz CH-Low 1RB

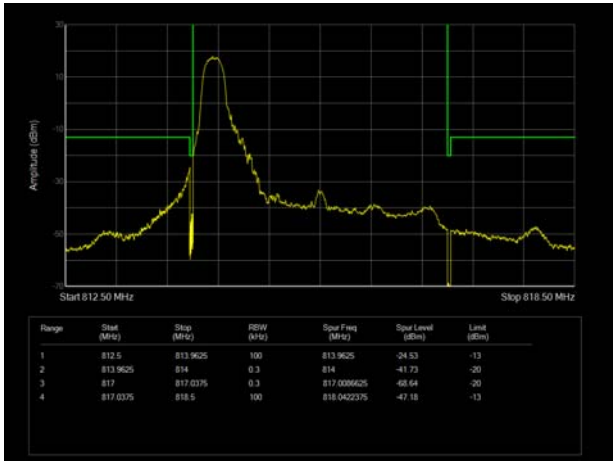

LTE Band 26 64QAM 3MHz CH-High 1RB

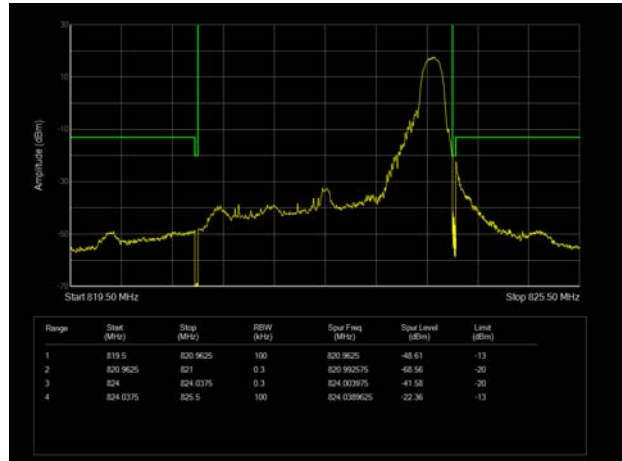

LTE Band 26 64QAM 3MHz CH-Low 100%RB

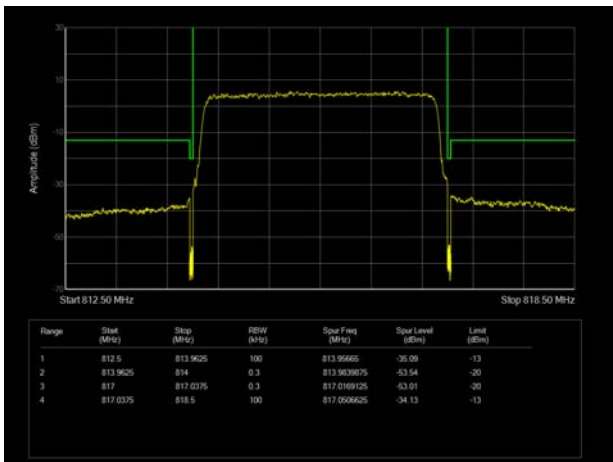

LTE Band 26 64QAM 3MHz CH-High 100%RB

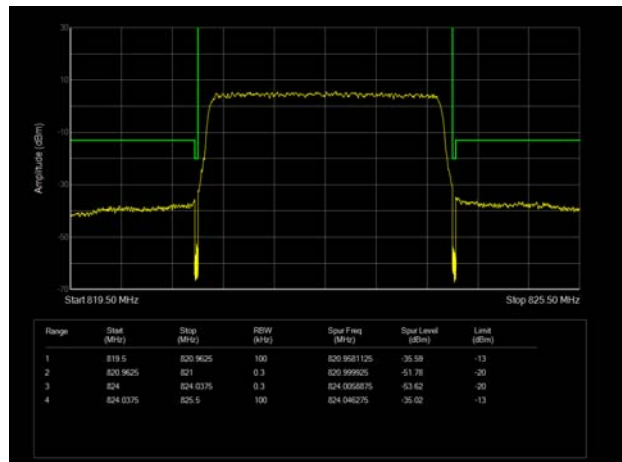

LTE Band 26 64QAM 5MHz CH-Low 1RB

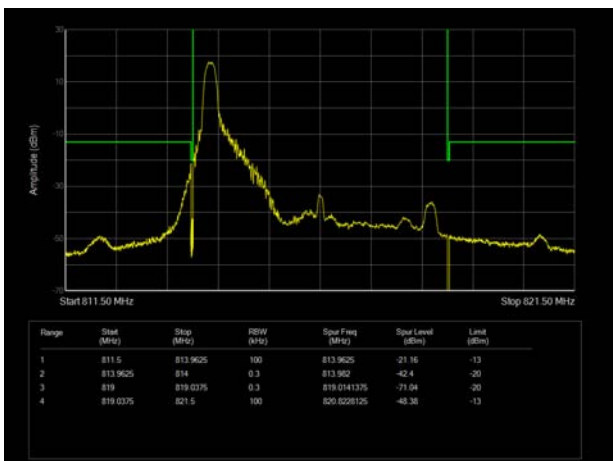

LTE Band 26 64QAM 5MHz CH-High 1RB

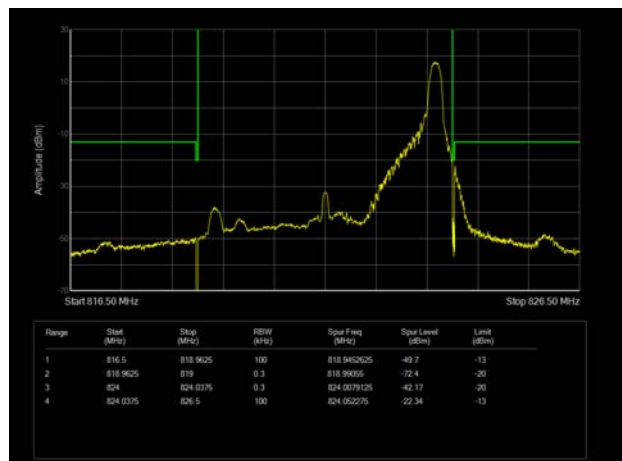

LTE Band 26 64QAM 5MHz CH-Low 100%RB

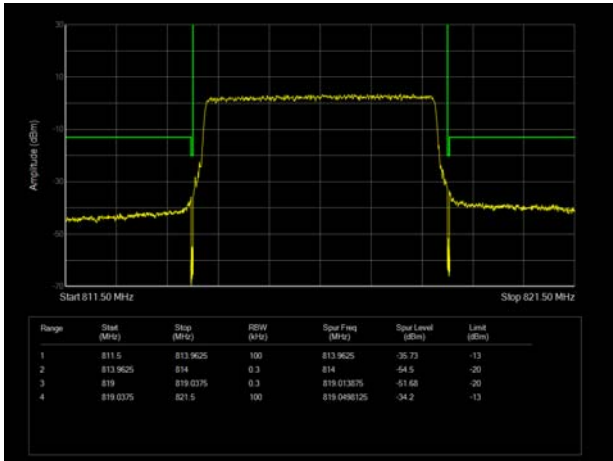

LTE Band 26 64QAM 5MHz CH-High 100%RB

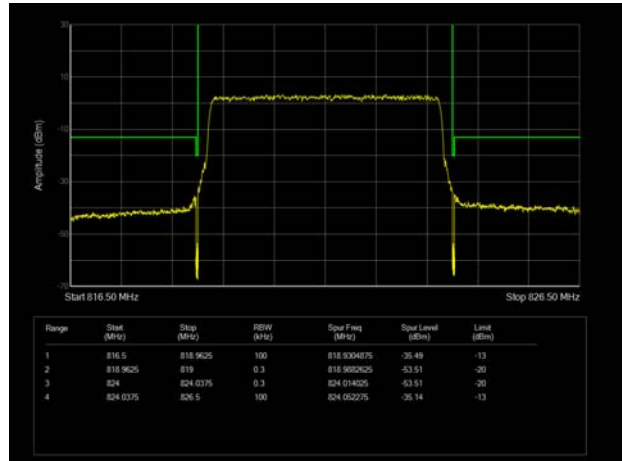

LTE Band 26 64QAM 10MHz CH-Low 1RB

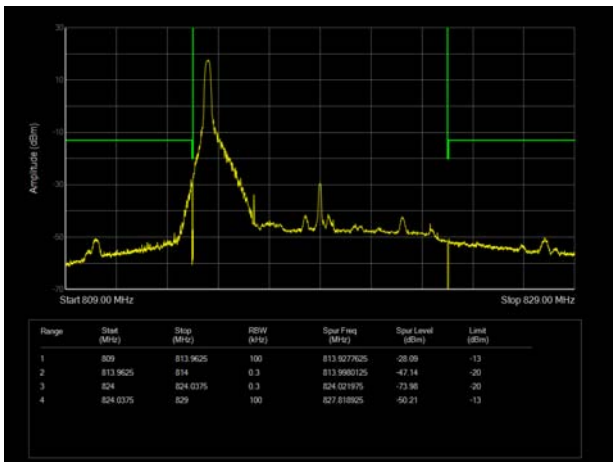

LTE Band 26 64QAM 10MHz CH-High 1RB

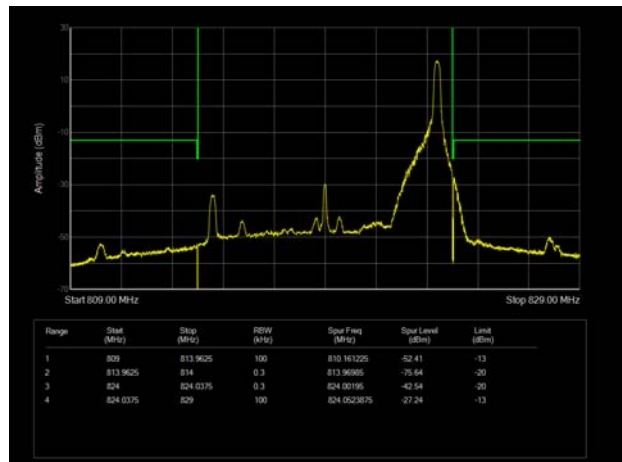

LTE Band 26 64QAM 10MHz CH-Low 100%RB

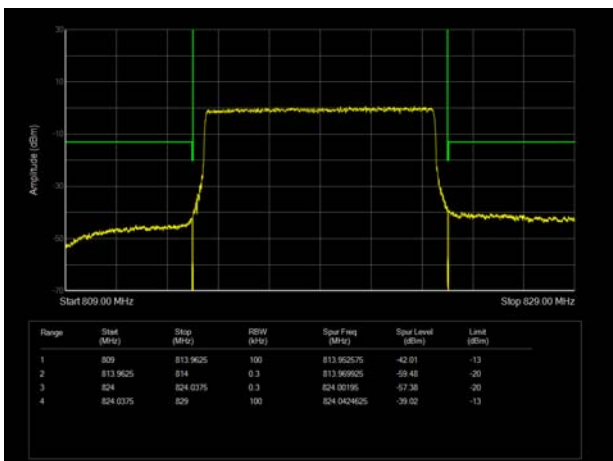

LTE Band 26 64QAM 10MHz CH-High 100%RB

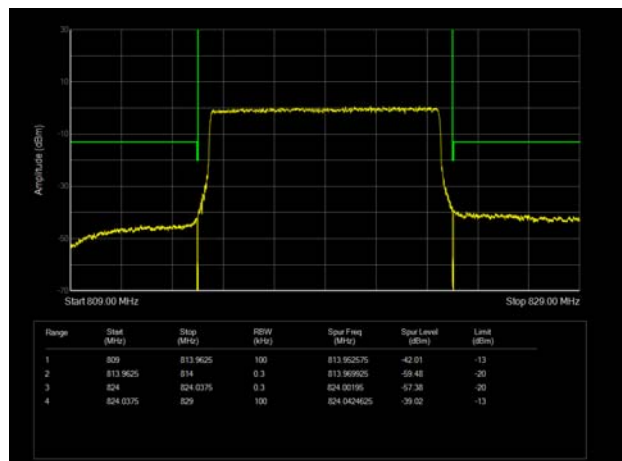

**6.4. Peak-to-Average Power Ratio (PAPR)**

Mode	Channel	Frequency (MHz)	Peak(dBm)	Avg(dBm)	PAPR(dB)	Limit(dB)	Conclusion
1.4 MHz (QPSK)	26697	814.7	26.82	21.07	5.75	13	PASS
	26740	819	26.46	20.99	5.47	13	PASS
	26783	823.3	26.31	20.94	5.37	13	PASS
3 MHz (QPSK)	26697	814.7	26.52	21.00	5.52	13	PASS
	26740	819	26.50	21.02	5.48	13	PASS
	26783	823.3	26.54	21.00	5.54	13	PASS
5 MHz (QPSK)	26697	814.7	26.59	21.02	5.57	13	PASS
	26740	819	26.67	21.05	5.62	13	PASS
	26783	823.3	26.54	20.99	5.55	13	PASS
10 MHz (QPSK)	26740	819	26.54	21.04	5.50	13	PASS

Mode	Channel	Frequency (MHz)	Peak(dBm)	Avg(dBm)	PAPR(dB)	Limit(dB)	Conclusion
1.4 MHz (16QAM)	26697	814.7	26.35	20.04	6.31	13	PASS
	26740	819	26.15	20.02	6.13	13	PASS
	26783	823.3	26.12	19.84	6.28	13	PASS
3 MHz (16QAM)	26697	814.7	26.32	20.04	6.28	13	PASS
	26740	819	26.30	20.07	6.23	13	PASS
	26783	823.3	26.27	20.02	6.25	13	PASS
5 MHz (16QAM)	26697	814.7	26.36	20.06	6.30	13	PASS
	26740	819	26.28	20.07	6.21	13	PASS
	26783	823.3	26.24	20.02	6.22	13	PASS
10 MHz (16QAM)	26740	819	26.30	20.05	6.25	13	PASS



Mode	Channel	Frequency (MHz)	Peak(dBm)	Avg(dBm)	PAPR(dB)	Limit(dB)	Conclusion
1.4 MHz (64QAM)	26697	814.7	24.85	18.65	6.20	13	PASS
	26740	819	24.79	18.64	6.15	13	PASS
	26783	823.3	24.91	18.70	6.21	13	PASS
3 MHz (64QAM)	26697	814.7	24.92	18.60	6.32	13	PASS
	26740	819	24.94	18.64	6.30	13	PASS
	26783	823.3	24.90	18.65	6.25	13	PASS
5 MHz (64QAM)	26697	814.7	24.84	18.63	6.21	13	PASS
	26740	819	24.92	18.65	6.27	13	PASS
	26783	823.3	24.80	18.60	6.20	13	PASS
10 MHz (64QAM)	26740	819	24.91	18.61	6.30	13	PASS





## 6.5. Frequency Stability

Band 26								
Condition		Freq.Error (Hz)	Freq.Error (Hz)	Freq.Error (Hz)	Frequency Stability (ppm)	Frequency Stability (ppm)	Frequency Stability (ppm)	Verdict
BANDWIDTH	1.4MHz							
Temperature	Voltage	64QAM	16QAM	QPSK	64QAM	16QAM	QPSK	
Normal (25°C)	Normal	5.77	6.02	12.48	0.00705	0.00736	0.01524	PASS
Extreme (45°C)		3.27	14.91	17.26	0.00399	0.01821	0.02107	PASS
Extreme (40°C)		9.13	8.13	13.63	0.01114	0.00993	0.01664	PASS
Extreme (30°C)		14.89	12.59	17.03	0.01818	0.01538	0.02080	PASS
Extreme (20°C)		15.35	5.34	6.31	0.01874	0.00652	0.00771	PASS
Extreme (10°C)		10.85	12.78	17.35	0.01325	0.01560	0.02118	PASS
Extreme (0°C)		2.24	3.30	14.73	0.00274	0.00402	0.01799	PASS
Extreme (-10°C)		3.77	11.39	13.49	0.00461	0.01390	0.01647	PASS
25°C	LV	16.26	2.82	3.71	0.01985	0.00344	0.00453	PASS
	HV	17.66	2.10	9.77	0.02156	0.00257	0.01193	PASS
Condition		Freq.Error (Hz)	Freq.Error (Hz)	Freq.Error (Hz)	Frequency Stability (ppm)	Frequency Stability (ppm)	Frequency Stability (ppm)	Verdict
BANDWIDTH	3MHz							
Temperature	Voltage	64QAM	16QAM	QPSK	64QAM	16QAM	QPSK	
Normal (25°C)	Normal	16.90	13.22	9.75	0.02063	0.01614	0.01190	PASS
Extreme (45°C)		2.83	11.96	12.64	0.00346	0.01460	0.01543	PASS
Extreme (40°C)		15.01	16.45	6.32	0.01833	0.02009	0.00772	PASS
Extreme (30°C)		4.11	8.04	17.67	0.00502	0.00981	0.02158	PASS
Extreme (20°C)		5.99	9.06	4.12	0.00731	0.01107	0.00503	PASS
Extreme (10°C)		12.44	1.45	12.75	0.01519	0.00177	0.01556	PASS
Extreme (0°C)		10.16	4.12	5.28	0.01240	0.00503	0.00645	PASS
Extreme (-10°C)		17.08	16.17	17.13	0.02086	0.01974	0.02092	PASS
25°C	LV	8.11	3.81	6.10	0.00991	0.00465	0.00745	PASS
	HV	5.74	1.65	10.03	0.00700	0.00202	0.01225	PASS
Condition		Freq.Error (Hz)	Freq.Error (Hz)	Freq.Error (Hz)	Frequency Stability (ppm)	Frequency Stability (ppm)	Frequency Stability (ppm)	Verdict
BANDWIDTH	5MHz							
Temperature	Voltage	64QAM	16QAM	QPSK	64QAM	16QAM	QPSK	
Normal (25°C)	Normal	14.11	15.97	4.24	0.01723	0.01950	0.00518	PASS
Extreme (45°C)		13.22	6.53	15.37	0.01614	0.00797	0.01876	PASS
Extreme (40°C)		17.46	4.72	5.85	0.02132	0.00577	0.00714	PASS
Extreme (30°C)		3.85	8.06	6.99	0.00470	0.00984	0.00853	PASS
Extreme (20°C)		3.73	17.91	2.43	0.00456	0.02187	0.00297	PASS



Extreme (10°C)		17.40	16.80	9.10	0.02125	0.02052	0.01111	PASS
Extreme (0°C)		10.59	1.14	8.17	0.01293	0.00140	0.00997	PASS
Extreme (-10°C)		5.10	3.36	9.07	0.00623	0.00410	0.01108	PASS
25°C	LV	7.50	1.02	1.89	0.00915	0.00125	0.00230	PASS
	HV	4.69	8.72	2.36	0.00573	0.01065	0.00288	PASS
Condition		Freq.Error (Hz)	Freq.Error (Hz)	Freq.Error (Hz)	Frequency Stability (ppm)	Frequency Stability (ppm)	Frequency Stability (ppm)	Verdict
BANDWIDTH	10MHz							
Temperature	Voltage	64QAM	16QAM	QPSK	64QAM	16QAM	QPSK	
Normal (25°C)	Normal	12.67	9.87	7.85	0.01547	0.01205	0.00958	PASS
Extreme (45°C)		3.52	4.32	14.25	0.00430	0.00528	0.01739	PASS
Extreme (40°C)		5.60	9.47	9.72	0.00684	0.01157	0.01187	PASS
Extreme (30°C)		12.12	9.75	14.47	0.01480	0.01190	0.01767	PASS
Extreme (20°C)		11.73	11.59	5.14	0.01432	0.01416	0.00627	PASS
Extreme (10°C)		5.04	1.83	10.43	0.00615	0.00223	0.01273	PASS
Extreme (0°C)		5.94	5.70	12.82	0.00725	0.00696	0.01565	PASS
Extreme (-10°C)		5.99	4.49	9.76	0.00732	0.00549	0.01191	PASS
25°C	LV	6.55	5.89	4.40	0.00800	0.00720	0.00537	PASS
	HV	8.92	4.07	3.32	0.01089	0.00497	0.00405	PASS

### 6.6. Spurious Emissions at Antenna Terminals

If disturbances were found more than 20dB below limit line, the mark is not required for the EUT. The signal beyond the limit is carrier.

LTE Band 26 1.4MHz CH Low 9KHz~10GHz

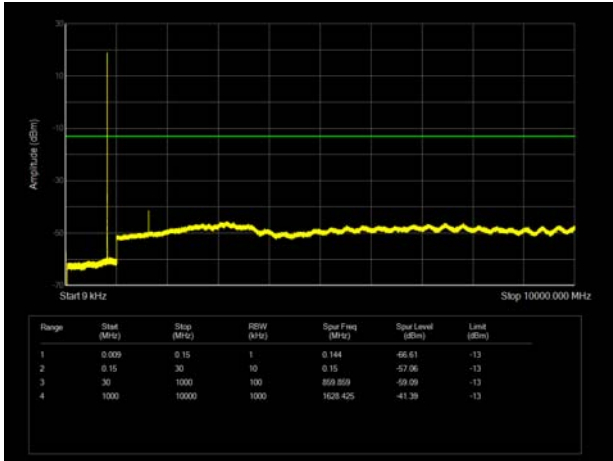

LTE Band 26 1.4MHz CH Middle 9KHz~10GHz

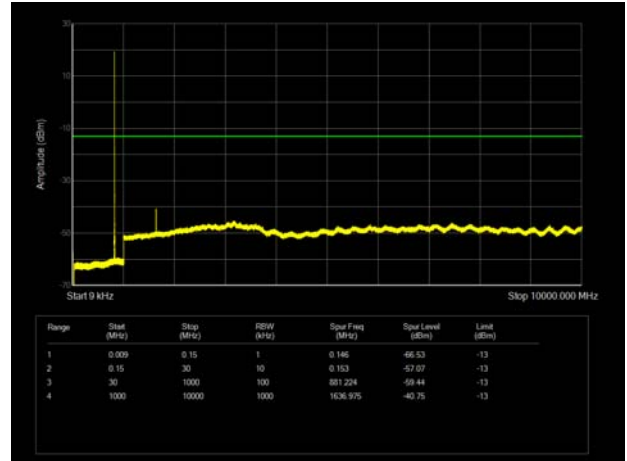

LTE Band 26 1.4MHz CH High 9KHz~10GHz

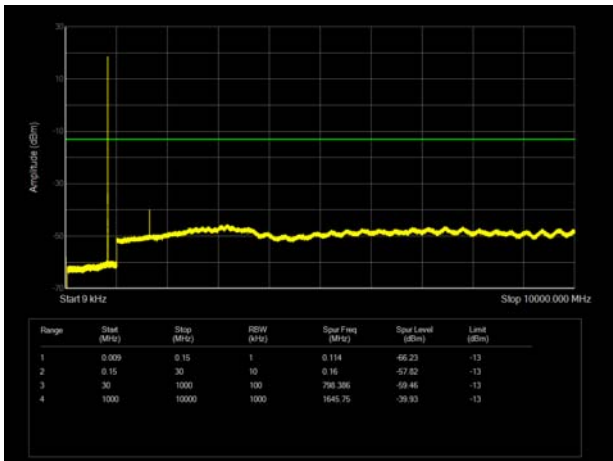

LTE Band 26 3MHz CH Low 9KHz~10GHz

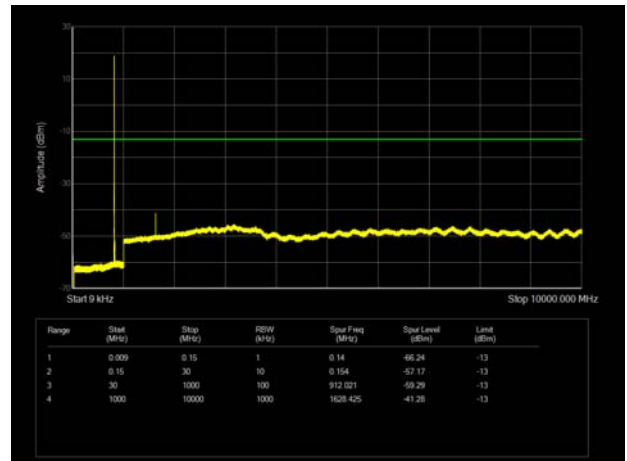

LTE Band 26 3MHz CH Middle 9KHz~10GHz

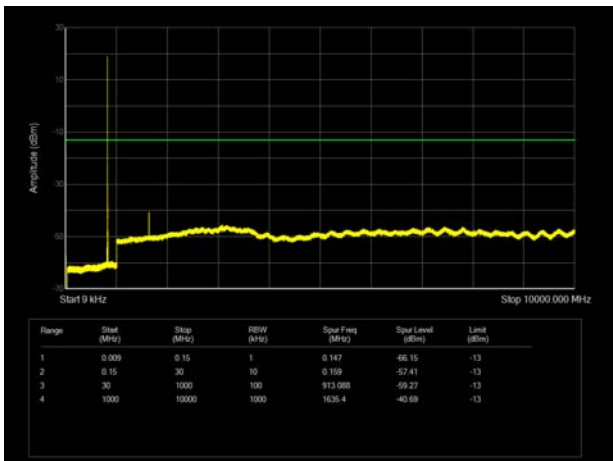

LTE Band 26 3MHz CH High 9KHz~10GHz

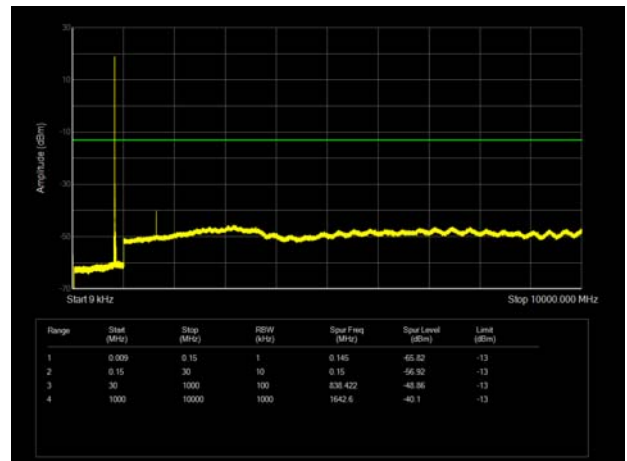



LTE Band 26 5MHz CH Low 9KHz~10GHz

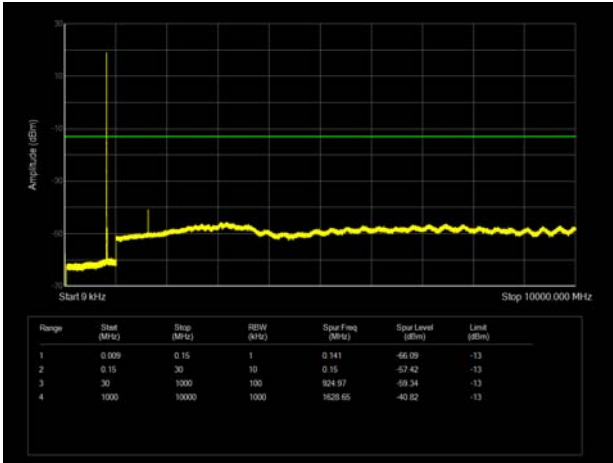

LTE Band 26 5MHz CH Middle 9KHz~10GHz

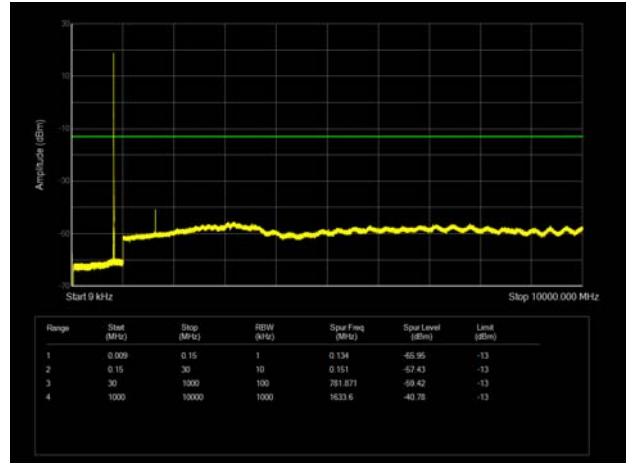

LTE Band 26 5MHz CH High 9KHz~10GHz

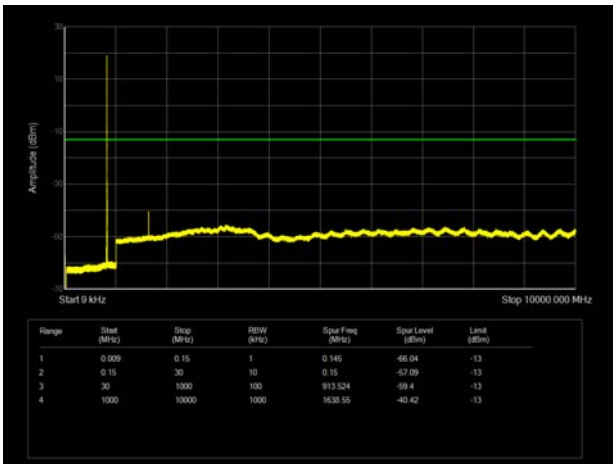

LTE Band 26 10MHz CH Middle 9KHz~10GHz

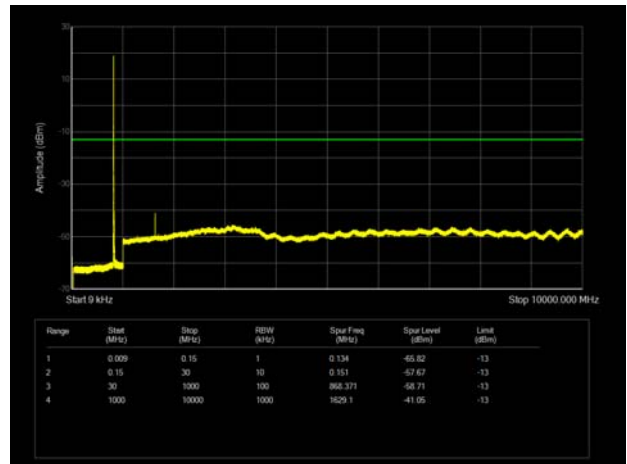

### 6.7. Radiates Spurious Emission

Sweep the whole frequency band through the range from 30MHz to the 10th harmonic of the carrier, the emissions below the noise floor will not be recorded in the report.

LTE Band 26 1.4MHz CH Low

Harmonic	Frequency (MHz)	SG (dBm)	Cable Loss (dB)	Gain (dBi)	Antenna Polarization	ERP Level (dBm)	Limit (dBm)	Margin (dB)	Azimuth (deg)
2	1637.25	-55.68	1.70	8.70	Vertical	-53.10	-13.00	40.10	45
3	2454.90	-63.66	2.30	12.00	Vertical	-56.90	-13.00	43.90	315
4	3273.20	-65.05	2.20	13.10	Vertical	-56.30	-13.00	43.30	0
5	4091.50	-62.77	3.00	12.50	Vertical	-54.34	-13.00	41.34	315
6	4909.80	-61.02	3.10	12.50	Vertical	-52.51	-13.00	39.51	90
7	5728.10	-60.92	3.40	12.50	Vertical	-54.34	-13.00	41.34	180
8	6546.40	-55.71	3.80	11.50	Vertical	-49.93	-13.00	36.93	0
9	7364.70	-52.96	4.20	12.20	Vertical	-47.70	-13.00	34.70	315
10	8183.00	-54.23	4.30	12.30	Vertical	-48.34	-13.00	35.34	180

Note: 1.The other Spurious RF Radiated emissions level is no more than noise floor.  
 2.The worst emission was found in the antenna is Vertical position.

LTE Band 26 5MHz CH Low

Harmonic	Frequency (MHz)	SG (dBm)	Cable Loss (dB)	Gain (dBi)	Antenna Polarization	ERP Level (dBm)	Limit (dBm)	Margin (dB)	Azimuth (deg)
2	1633.40	-59.97	1.70	8.70	Vertical	-55.12	-13.00	42.12	270
3	2450.65	-63.60	2.30	12.00	Vertical	-56.05	-13.00	43.05	225
4	3266.00	-65.39	2.20	13.10	Vertical	-56.64	-13.00	43.64	45
5	4082.50	-61.23	3.00	12.50	Vertical	-53.88	-13.00	40.88	315
6	4899.00	-60.53	3.10	12.50	Vertical	-53.28	-13.00	40.28	270
7	5715.50	-58.39	3.40	12.50	Vertical	-51.44	-13.00	38.44	225
8	6532.00	-53.35	3.80	11.50	Vertical	-47.80	-13.00	34.80	45
9	7348.50	-54.31	4.20	12.20	Vertical	-48.46	-13.00	35.46	180
10	8165.00	-54.18	4.30	12.30	Vertical	-48.33	-13.00	35.33	0

Note: 1.The other Spurious RF Radiated emissions level is no more than noise floor.  
 2.The worst emission was found in the antenna is Vertical position.



## LTE Band 26 10MHz CH Low

Harmonic	Frequency (MHz)	SG (dBm)	Cable Loss (dB)	Gain (dBi)	Antenna Polarization	ERP Level (dBm)	Limit (dBm)	Margin (dB)	Azimuth (deg)
2	1629.15	-55.68	1.70	8.70	Vertical	-50.83	-13.00	37.83	45
3	2443.80	-63.66	2.30	12.00	Vertical	-56.11	-13.00	43.11	180
4	3256.00	-65.05	2.20	13.10	Vertical	-56.30	-13.00	43.30	315
5	4070.00	-62.77	3.00	12.50	Vertical	-55.42	-13.00	42.42	90
6	4884.00	-61.02	3.10	12.50	Vertical	-53.77	-13.00	40.77	180
7	5698.00	-60.92	3.40	12.50	Vertical	-53.97	-13.00	40.97	0
8	6512.00	-55.71	3.80	11.50	Vertical	-50.16	-13.00	37.16	315
9	7326.00	-52.96	4.20	12.20	Vertical	-47.11	-13.00	34.11	180
10	8140.00	-54.23	4.30	12.30	Vertical	-48.38	-13.00	35.38	45

Note: 1.The other Spurious RF Radiated emissions level is no more than noise floor.

2.The worst emission was found in the antenna is Vertical position.

## 7. Main Test Instruments

Name	Manufacturer	Type	Serial Number	Calibration Date	Expiration Date
Climate Chamber	ESPEC	SU-242	93000506	2021-12-12	2022-12-11
Comprehensive tester	R&S	CMW500	150415	2022-05-14	2023-05-13
Spectrum Analyzer	Keysight	N9020A	MY50510203	2021-12-12	2022-12-11
Wireless communication tester	Agilent	E5515C	GB44400275	2021-12-12	2022-12-11
Spectrum Analyzer	R&S	FSV40	101297	2021-12-12	2022-12-11
<b>Radiated Spurious Emissions</b>					
Spectrum Analyzer	R&S	FSV30	104028	2021-12-12	2022-12-11
log periodic antenna	Schwarzbeck	VULB 9163	01111	2019-09-12	2022-09-11
high frequency horn antenna	Schwarzbeck	BBHA 9120D	1594	2020-12-17	2023-12-16
software	R&S	EMC32	10.35.10	/	/

\*\*\*\*\*END OF REPORT \*\*\*\*\*



## **ANNEX A: The EUT Appearance**

The EUT Appearance is submitted separately.





## **ANNEX B: Test Setup Photos**

The Test Setup Photos is submitted separately.