FCC Test Report

Report No: WD-RF-R-220243-B0

Product Name : R170 5MP Microdome Camera
Model Name : R170
Series Model Name : R170xxxxxx (x=0~9,A~Z,- or Space)
FCC ID : 2AZ3JR170
Applicant : Rhombus Systems, Inc
Received Date : May 12, 2022
Tested Date : Jul. 20, 2022 ~ Sep. 08, 2022
Applicable Standard : 47 CFR FCC Part 15, Subpart C (Section 15.247)
KDB 558074 D01 DTS Meas. Guidance v05
ANSI C63.10 : 2013



Wendell Industrial Co., Ltd
Wendell EMC & RF Laboratory

Caution:

This report sets forth our findings solely with respect to the test samples identified herein. The results set forth in this report are not indicative or representative of the quality or characteristics of the lot from which a test sample was taken or any similar or identical product unless specifically and expressly noted.

The test results shown in the test report are traceable to the national/international standard through the calibration report of the equipment.

Please note that the measurement uncertainty are provided for informational purpose only and are not used in determining the Pass/Fail results.

This report must not be used to claim product endorsement by TAF or any agency of the government.

The test report shall not be reproduced without the written approval of Wendell Industrial Co., Ltd..

Test Report

Issued Date: September 12, 2022

Project No.: 22Q051202

Product Name	R170 5MP Microdome Camera
Trade Name	rhombus systems
Brand Trademark	
Model Name	R170
Series Model Name	R170xxxxxx (x=0~9,A~Z,- or Space)
FCC ID	2AZ3JR170
Applicant	Rhombus Systems, Inc
Manufacturer	DYNACOLOR INC
EUT Rated Voltage	PoE 37V ~ 57V
EUT Test Voltage	AC 120V / 60Hz
EUT Supports Radios Application	Bluetooth BR/EDR/LE
Applicable Standard	47 CFR FCC Part 15, Subpart C (Section 15.247) KDB 558074 D01 DTS Meas. Guidance v05 ANSI C63.10 : 2013
Output Power	7.94 dBm
Test Result	Complied

Documented :

(Specialist / Emma Lu)

Technical Engineer :

(Section Manager / Jack Chang)

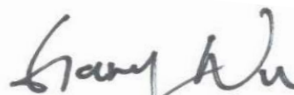
Approved :

(Project Manager / Gary Wu)

Table of Contents

Document Revision History	5
Summary of Test Result	6
1 Generation Information	7
1.1 Applicant	7
1.2 Manufacturer	7
1.3 Description of Equipment under Test	7
1.4 Test Mode Applicability And Tested Channel Detail	10
1.5 Configuration of Tested System	12
1.6 EUT Exercise Software	13
1.7 Tested System Details	13
1.8 Test Facility	14
1.9 Measurement Uncertainty	15
1.10 List of Test Equipment	16
2 Test Result	19
2.1 Antenna Requirement	19
2.1.1 Applicable Standard	19
2.1.2 Antenna Connected Construction	19
2.1.3 Antenna Gain	19
2.2 Peak Output Power Measurement	20
2.2.1 Limit	20
2.2.2 Test Setup	20
2.2.3 Test Procedure	20
2.2.4 Test Result	20
2.3 6dB Bandwidth Measurement	21
2.3.1 Limit	21
2.3.2 Test Setup	21
2.3.3 Test Procedure	21
2.3.4 Test Result	22
2.4 Power Spectral Density Measurement	23
2.4.1 Limit	23
2.4.2 Test Setup	23
2.4.3 Test Procedure	23
2.4.4 Test Result	24
2.5 Conducted Band Edges and Spurious Emission Measurement	25
2.5.1 Limit	25
2.5.2 Test Setup	25
2.5.3 Test Procedure	25
2.5.4 Test Result	26
2.6 Radiated Band Edges and Spurious Emission Measurement	29
2.6.1 Limit	29
2.6.2 Test Setup	30
2.6.3 Test Procedure	31
2.6.4 Duty Cycle	32
2.6.5 Test Result of Radiated Band Edge Measurement	32
2.6.6 Test Result of Radiated Spurious Emission Measurement	37
2.7 AC Conducted Emissions Measurement	46
2.7.1 Limit	46

2.7.2 Test Setup..... 46
2.7.3 Test Procedure..... 47
2.7.4 Test Result 48

Attachment 1: EUT Test Photographs

Attachment 2: EUT Detailed Photographs

Document Revision History

Report No.	Issue date	Description
WD-RF-R-220243-B0	September 12, 2022	Initial report

Summary of Test Result

Ref. Std. Clause	Test Items	Result
15.203 15.247(C)	Antenna Requirement	Pass
15.247(b)	Peak Output Power	Pass
15.247(a)(2)	6dB Bandwidth	Pass
15.247(e)	Power Spectral Density	Pass
15.247(d)	Conducted Band Edges and Conducted Spurious Emission	Pass
15.247(d)	Radiated Band Edges and Radiated Spurious Emission	Pass
15.207	AC Conducted Emission	Pass

1 Generation Information

1.1 Applicant

Rhombus Systems, Inc
1920 20th Street Sacramento, CA 95811

1.2 Manufacturer

DYNACOLOR INC
116 JOU TZ ST NEIHU TAIPEI TAIWAN

1.3 Description of Equipment under Test

Product Name	R170 5MP Microdome Camera
Model No.	R170
Series Model Name	R170xxxxxx (x=0~9,A~Z,- or Space)
Model Difference	Market segmentation
FCC ID	2AZ3JR170
Frequency Range	2402 ~ 2480 MHz
Number of Channels	40CH
Channel separation	2 MHz
Type of Modulation	GFSK(1 Mbps)
Antenna Information	Refer to the table "Antenna List"
EUT Supports Radios Application	Bluetooth BR/EDR/LE
EUT Rated Voltage	PoE 37V ~ 57V
EUT Test Voltage	AC 120V / 60Hz

Antenna List

No.	Manufacturer	Model No.	Antenna Type	Peak Gain
1	PSA	RFFPA232003IMAB301	FPC Antenna	4 dBi for 2.4GHz

Remark: The antenna of EUT is conforming to FCC 15.203

Channel List

Channel	Frequency (MHz)	Channel	Frequency (MHz)	Channel	Frequency (MHz)	Channel	Frequency (MHz)
00	2402	10	2422	20	2442	30	2462
01	2404	11	2424	21	2444	31	2464
02	2406	12	2426	22	2446	32	2466
03	2408	13	2428	23	2448	33	2468
04	2410	14	2430	24	2450	34	2470
05	2412	15	2432	25	2452	35	2472
06	2414	16	2434	26	2454	36	2474
07	2416	17	2436	27	2456	37	2476
08	2418	18	2438	28	2458	38	2478
09	2420	19	2440	29	2460	39	2480

Test Frequencies in each operating band

Frequency range over which the device operates in each operating band (Note 1)	Number of test frequencies required	Location of test frequencies inside the operating frequency range (Note 1,2)
≤ 1 MHz	1	near center
> 1 MHz and ≤ 10 MHz	2	1 near high end, 1 near low end
> 10 MHz	3	1 near high end, 1 near center, and 1 near low end

Note 1: The frequency range over which the device operates in a given operating band is the difference between the highest and lowest frequencies on which the device can be tuned within that given operating band. The frequency range can be smaller than or equal to the operating band, but cannot be greater than the operating band.

Note 2: In the third column of table 1, “near” means as close as possible to or at the center / low end / high end of the frequency range over which the device operates.

Firmware / Software Version

1	Product Name	R170 5MP Microdome Camera
2	Model No.	R170
3	Test SW Version	PuTTY release 0.63
4	RF power setting in TEST SW	<input checked="" type="checkbox"/> RF power setting was not able to alter during testing. <input type="checkbox"/> RF power setting was able to alter during testing. (See the following table)

Parameters of test software setting

Type of Modulation	Channel	Frequency (MHz)	Set Value
GFSK(1Mbps)	00	2402	Default
	19	2440	Default
	39	2480	Default

1.4 Test Mode Applicability And Tested Channel Detail

1. This device is a R170 5MP Microdome Camera with a built-in Bluetooth transceiver.
2. These tests were performed on a sample of equipment to demonstrate compliance with 47 CFR FCC Part 15, Subpart C (Section 15.247).
3. Pre-Scan has been conducted to determine the worst-case mode from all possible combinations between available modulations, data rates, XYZ axis and antenna ports.
4. The worst case was found when positioned on X axis for radiated emission. Following test modes were selected for the final test, and the final worst case is recorded in the report:

EUT Configure Mode	RE < 1G	RE ≥ 1G	ACM	ACP	Description
--	<input checked="" type="checkbox"/>	<input checked="" type="checkbox"/>	<input checked="" type="checkbox"/>	<input type="checkbox"/>	Transmit BLE
--	<input type="checkbox"/>	<input type="checkbox"/>	<input type="checkbox"/>	<input checked="" type="checkbox"/>	Normal mode

Note : RE<1G: Radiated Emission below 1GHz RE≥1G: Radiated Emission above 1GHz
 ACM: Antenna Port Conducted Measurement ACP: AC Power Line Conducted Emission

Following channel(s) was (were) selected for the final test as listed below:

Radiated Spurious Emission Measurement(Below 1GHz):

EUT Configure Mode	Mode	Available Channel	Tested Channel	Modulation Type	Data Rate (Mbps)
--	BLE	0 ~ 39	19	GFSK	1

Radiated Spurious Emission Measurement(Above 1GHz):

EUT Configure Mode	Mode	Available Channel	Tested Channel	Modulation Type	Data Rate (Mbps)
--	BLE	0 ~ 39	0, 19, 39	GFSK	1

Radiated Band Edge Emission Measurement(Above 1GHz):

EUT Configure Mode	Mode	Available Channel	Tested Channel	Modulation Type	Data Rate (Mbps)
--	BLE	0 ~ 39	0, 39	GFSK	1

Peak Output Power, 6dB Bandwidth, Power Spectral Density, Conducted Spurious Emission:

EUT Configure Mode	Mode	Available Channel	Tested Channel	Modulation Type	Data Rate (Mbps)
--	BLE	0 ~ 39	0, 19, 39	GFSK	1

Conducted Band Edges:

EUT Configure Mode	Mode	Available Channel	Tested Channel	Modulation Type	Data Rate (Mbps)
--	BLE	0 ~ 39	0, 39	GFSK	1

AC Conducted Emission:

EUT Configure Mode	Mode	Available Channel	Tested Channel	Modulation Type	Data Rate (Mbps)
--	BLE	0 ~ 39	19	GFSK	1

1.5 Configuration of Tested System

Radiation

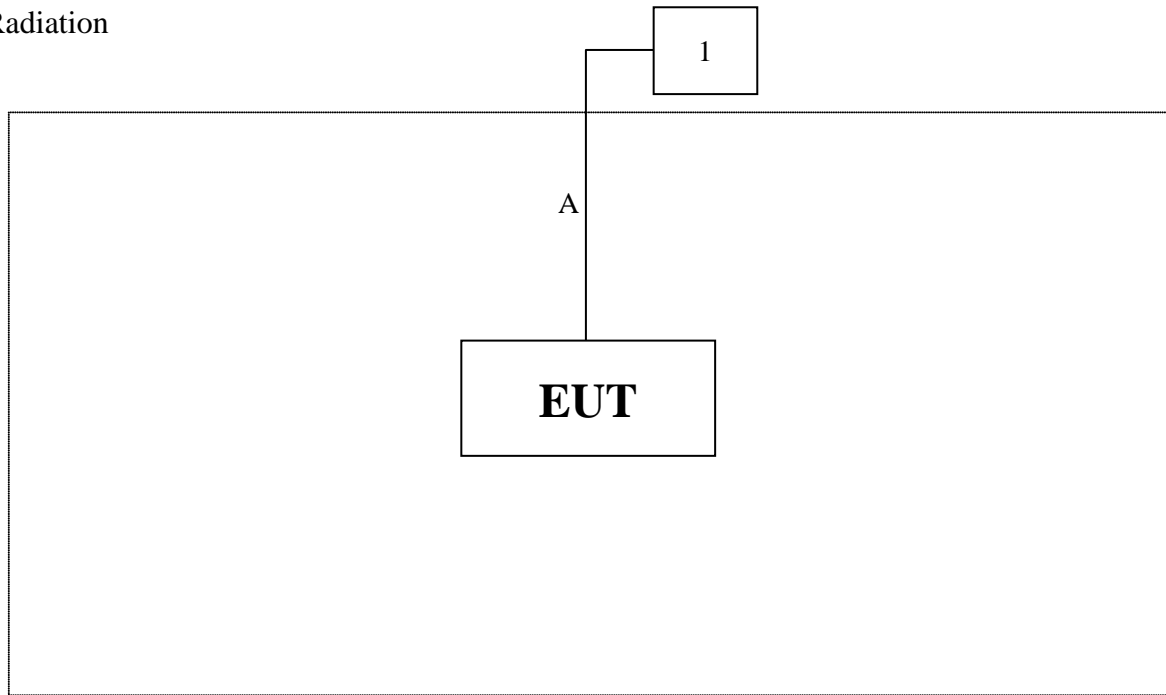

Test Table

AC Conduction

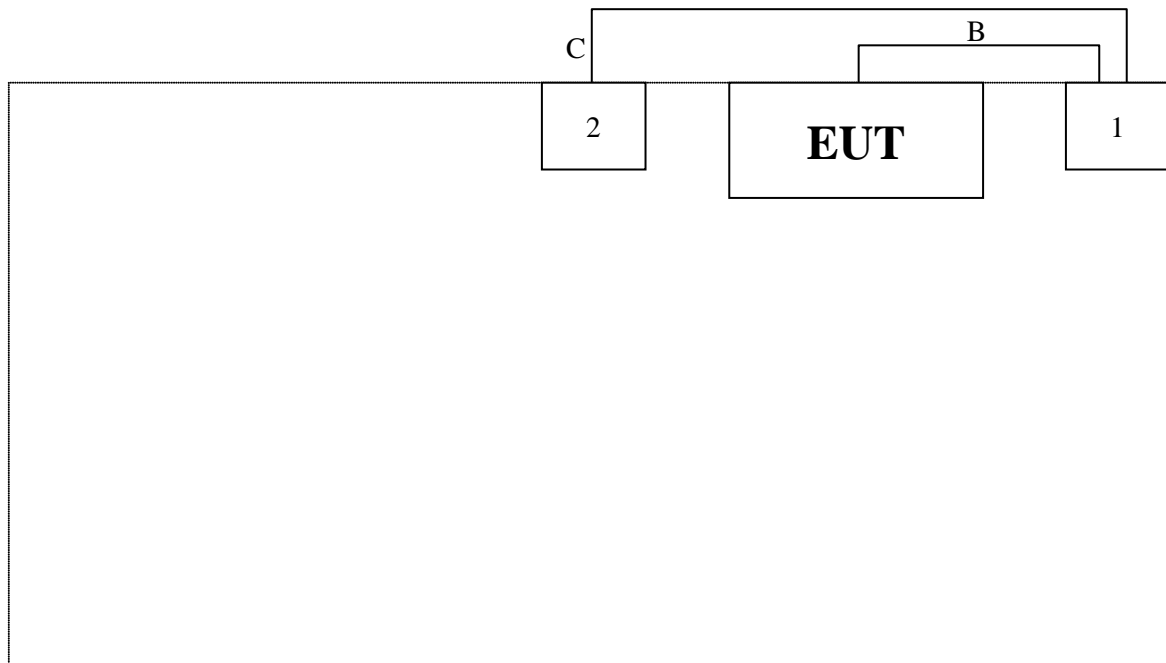

Test Table

1.6 EUT Exercise Software

1. Setup the EUT as shown in Section 1.5
2. Execute software “PuTTY release 0.63”.
3. Configure the test mode, the test channel, and the data rate.
4. Press “OK” to start the continuous transmit.
5. Verify that the EUT works properly.

1.7 Tested System Details

The types for all equipment, plus descriptions of all cables used in the tested system (including inserted cards) are:

No.	Product	Manufacturer	Model No.	Serial No.	Power Cord
1	PoE	Microsemi	PD-9501GR/AC	C19146230000001316	N/A
2	Notebook PC	acer	N17W3	NXVJ7TA00302301D496600	Non-shielded, 1 Core, 1.6m

No.	Signal Cable Type	Signal cable Description
A	LAN Cable	Non-shielded, Non-Core, 12m
B	LAN Cable	Non-shielded, Non-Core, 1.0m
C	LAN Cable	Non-shielded, Non-Core, 1.8m

1.8 Test Facility

Items	Required (IEC 60068-1)	Actual
Temperature (°C)	15-35	20~25
Humidity (% RH)	25-75	45~55
Barometric pressure (mbar)	860-1060	990~1020

Description: Accredited by TAF
Accredited Number: 2965

Issued by: Wendell Industrial Co., Ltd

Lab Address: 6F/6F-1, No.188, Baoqiao Rd., Xindian Dist.,
New Taipei City 23145, Taiwan R.O.C

Test Lab: Wendell EMC & RF Laboratory

Test Location: No. 119, Wugong 3rd Rd., Wugu Dist.,
New Taipei City 248, Taiwan (R.O.C.)

Designation Number: TW0025

Test Firm Registration Number: 665221

1.9 Measurement Uncertainty

ISO/IEC 17025 requires that an estimate of the measurement uncertainties associated with the emissions test results be included in the report. The measurement uncertainties given below are based on a 95% confidence (level based on a coverage factor K=2)

Measurement Project	Condition	Expended Uncertainty
AC Conducted Emission	0.150 ~ 30 MHz	2.64 dB
Radiated Emission	0.009 ~ 30 MHz	± 4.2 dB
	30 ~ 1000 MHz	± 3.9 dB
	1000 ~ 18000 MHz	± 4.1 dB
	18000 ~ 40000 MHz	± 3.9 dB
RF Power, Conducted	Conducted Measuring	± 0.5 dB
Occupied Bandwidth	Conducted Measuring	± 2.4 %
Power Density	Conducted Measuring	± 1.7 dB
Duty Cycle and Dwell Time	Conducted Measuring	± 1.3 %
Conducted Unwanted Emission Strength	Conducted Measuring	± 1.8 dB
DC Power Supply	--	± 3.2 %
Temperature	--	± 1.1 °C
Humidity	--	± 3.4 %

Note: Please note that the measurement uncertainty are provided for informational purpose only and are not used in determining the Pass/Fail results.

1.10 List of Test Equipment

For Conducted measurements / W08-Conducted Measurement

Equipment	Manufacturer	Model No.	Serial No.	Cal. Date	Due Date
✓ Spectrum analyzer	Keysight	N9010A	SG50420005	2022/08/01	2023/07/31
✓ Wideband Peak Power Meter	Anritsu	ML2495A	1733007	2021/09/07	2022/09/06
✓ Pulse Power Sensor + Precision Adaptor	Anritsu	MA2411B	1726022	2021/09/07	2022/09/06
Temperature Chamber	TAICHY	MHK-225LK	1061121	2022/04/22	2023/04/21
Wireless Connectivity Tester	R&S	CMW270	101307	2022/05/23	2023/05/22
✓ Attenuator	MVE	MVE2211-10	CT-9-056	2022/08/10	2023/08/09
Attenuator	MVE	MVE2211-20	CT-9-057	2022/08/10	2023/08/09
Attenuator	MVE	MVE2211-30	CT-9-058	2022/08/10	2023/08/09
Power Divider	MVE	MVE8546	170826003	2022/08/11	2023/08/10
Power Splitter	MVE	MVE8547	170302047	2022/08/10	2023/08/09
DC Power Supply	GW INSTEK	GPC-3060D	GER817636	2022/08/09	2023/08/08

Remark:

1. All equipments are calibrated every one year.
2. The test instruments marked with “✓” are used to measure the final test results.

For AC Conduction measurements / W08-CE

	Equipment	Manufacturer	Model No.	Serial No.	Cal. Date	Due Date
✓	EMI Test Receiver	R&S	ESR3	102309	2022/6/15	2023/6/14
✓	2-Line V-Network LISN	R&S	ENV216	101185	2022/6/20	2023/6/19
✓	LISN	SCHWARZBECK	NSLK 8127RC	05028	2022/6/20	2023/6/19
✓	Transient Limiter	EM Electronics Corporation	EM-7600	857	2022/6/20	2023/6/19
✓	50ohm Cable	EMCI	EMCCFD300-BM-BM-5000	170612	2022/6/17	2023/6/16
✓	50 ohm terminal impedance	HUBER+SUHNER	50 ohm terminal impedance	CT-1-109-1	2022/6/17	2023/6/16

Remark:

1. All equipments are calibrated every one year.
2. The test instruments marked with “✓” are used to measure the final test results.
3. Test Software version: FARAD EZ-EMC Ver.EMC-CON 3A1

For Radiated measurements / W08-996-2

Equipment	Manufacturer	Model No.	Serial No.	Cal. Date	Due Date
✓ EMI Receiver	Keysight	N9038A	MY51210173	2022/08/17	2023/08/16
✓ Spectrum Analyzer	Keysight	N9010A	MY52220228	2022/08/16	2023/08/15
✓ Loop Antenna	EMCI	LPA600	277	2022/08/22	2023/08/21
✓ TRILOG super broad Antenna	Schwarzbeck	VULB 9168	VULB 9168-700 & 1421	2022/08/12	2023/08/11
✓ Horn Antenna	Schwarzbeck	BBHA 9120D	01767	2022/05/31	2023/05/30
✓ Horn Antenna	Schwarzbeck	BBHA 9170	703	2022/06/16	2023/06/15
✓ Pre-Amplifier	EM	EMC330	060774	2022/08/17	2023/08/16
✓ Pre-Amplifier	EMEC	EM01G18G	060648	2022/08/18	2023/08/17
✓ Pre-Amplifier	JPT	JPA0118-55-303K	1910001800055003	2022/08/18	2023/08/17
✓ Pre-Amplifier	EMCI	EMC184045SE	980515	2022/08/18	2023/08/17
✓ Cable	EMEC	EM-CB400	105060103	2022/08/18	2023/08/17
✓ Cable	EMEC	EM-CB400	105060102	2022/08/18	2023/08/17
✓ Cable	EMEC	EM-CB400	105060101	2022/08/18	2023/08/17
✓ RF Cable	HUBER+SUHNER	SF102	MY2752/2	2022/08/17	2023/08/16
✓ Cable	MVE	280280.LL266.1200	B60028C	2022/08/17	2023/08/16
✓ RF Cable	HUBER+SUHNER	SF102	MY2751/2	2022/08/17	2023/08/16
✓ Cable	EMCI	EMC102-KM-KM-600	190646	2022/08/17	2023/08/16
✓ RF Filter	EMEC	BRF-2400-2500	002	2022/08/11	2023/08/10
RF Filter	EMEC	BRF-5150-5350	104	2022/08/11	2023/08/10
RF Filter	EMEC	BRF-5470-5725	092	2022/08/11	2023/08/10
RF Filter	EMEC	BRF-5725-5875	091	2022/08/11	2023/08/10
✓ RF Filter	EMEC	HPF-2800	002	2022/08/11	2023/08/10
RF Filter	EMEC	HPF-5850	059	2022/08/11	2023/08/10
SMA Notch Filter	MVE	MFN-902.928.S1	190604001	2022/08/17	2023/08/16

Remark:

1. All equipments are calibrated every one year.
2. The test instruments marked with "✓" are used to measure the final test results.
3. Test Software version: FARAD EZ-EMC Ver.WD-03A1-1

2 Test Result

2.1 Antenna Requirement

2.1.1 Applicable Standard

An intentional radiator shall be designed to ensure that no antenna other than that furnished by the responsible party shall be used with the device. The use of a permanently attached antenna or of an antenna that uses a unique coupling to the intentional radiator shall be considered sufficient to comply with the provisions of this section. The manufacturer may design the unit so that a broken antenna can be replaced by the user, but the use of a standard antenna jack or electrical connector is prohibited.

An intentional radiator shall be designed to ensure that no antenna other than as furnished by the responsible party shall be used with the device. If transmitting antennas of directional gain greater than 6dBi are using the power shall be reduced by the amount in dB that the directional gain of the antenna exceeds 6 dBi, for compliance to FCC 47CFR 15.247 (c) requirements.

2.1.2 Antenna Connected Construction

Non-standard antenna connector is used.

2.1.3 Antenna Gain

No.	Manufacturer	Model No.	Antenna Type	Peak Gain
1	PSA	RFFPA232003IMAB301	FPC Antenna	4 dBi for 2.4GHz

2.2 Peak Output Power Measurement

2.2.1 Limit

For systems using digital modulation in the 2400-2483.5MHz, the limit for peak output power is 1W. If transmitting antenna of directional gain greater than 6dBi is used, the peak output power from the intentional radiator shall be reduced below the above stated value by the amount in dB that the directional gain of the antenna exceeds 6 dBi. In case of point-to-point operation, the limit has to be reduced by 1dB for every 3dB that the directional gain of the antenna exceeds 6dBi.

2.2.2 Test Setup

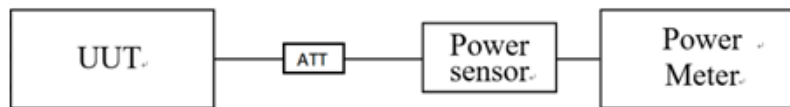

2.2.3 Test Procedure

1. Reference ANSI C63.10 : 2013 chapter 11.9.1.3
2. Enable the EUT transmit continuously.
3. Let EUT be connected to the power meter, and record the max. reading.
4. Measurement using a gated RF average power meter, since this measurement is made only during the ON time of the transmitter, no duty cycle correction is required.

2.2.4 Test Result

Protocol	Channel	Frequency (MHz)	Peak Power (dBm)	Limit (dBm)	Result
BLE	00	2402	6.08	≤ 30	Pass
	19	2440	7.94	≤ 30	Pass
	39	2480	7.33	≤ 30	Pass

Remark:

1. Peak Power = Reading value on power meter + cable loss
2. $10 \text{ Log}(X/\text{mW}) = \text{dBm}$, $X=1 \text{ watt (Limit)}$
 $1 \text{ watt} = 30 \text{ dBm}$

2.3 6dB Bandwidth Measurement

2.3.1 Limit

The minimum 6 dB bandwidth shall be at least 500 kHz.

2.3.2 Test Setup



2.3.3 Test Procedure

1. Reference ANSI C63.10 : 2013 chapter 11.8.2
2. Enable the EUT transmit continuously.
3. Spectrum analyzer set:
 - a) RBW = 100 kHz
 - b) VBW \geq 3 RBW
 - c) Detector = peak
 - d) Sweep time = auto couple
 - e) Trace mode = max hold.

2.3.4 Test Result

Protocol	Channel	Frequency (MHz)	6dB BW (kHz)	Limit (kHz)	Result
BLE	00	2402	721.300	≥ 500	Pass
	19	2440	726.700		Pass
	39	2480	722.800		Pass

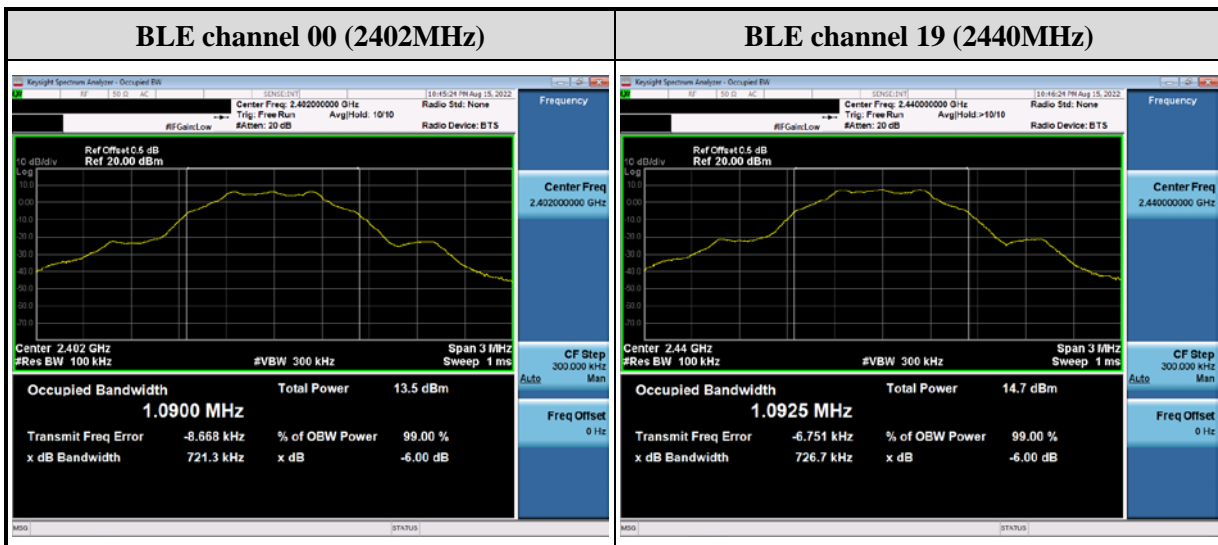

BLE channel 39 (2480MHz)

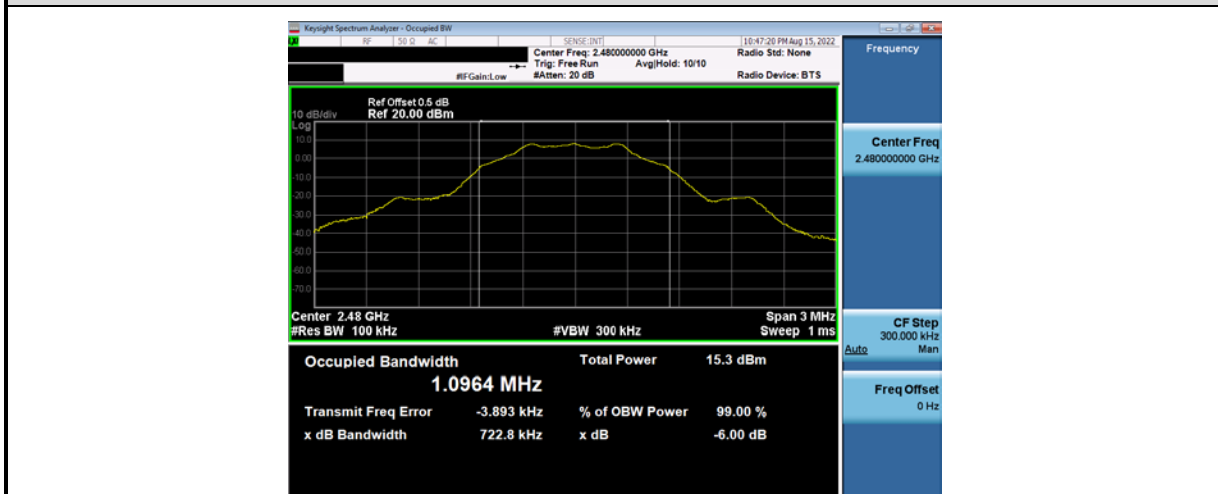

2.4 Power Spectral Density Measurement

2.4.1 Limit

The peak power spectral density shall not be greater than 8dBm in any 3kHz band at any time interval of continuous transmission.

2.4.2 Test Setup



2.4.3 Test Procedure

1. Reference ANSI C63.10 : 2013 chapter 11.10.2
2. Enable the EUT transmit continuously.
3. Spectrum analyzer set:
 - a) RBW = 3 kHz ~ 100 kHz
 - b) VBW \geq 3 RBW
 - c) Span = 1.5 times DTS Channel 6dB Bandwidth
 - d) Detector = peak
 - e) Sweep time = auto couple
 - f) Trace mode = max hold.

2.4.4 Test Result

Protocol	Channel	Frequency (MHz)	PSD (dBm)	Limit (dBm)	Result
BLE	00	2402	-7.258	≤ 8	Pass
	19	2440	-6.037		Pass
	39	2480	-5.617		Pass

Remark: PSD = Reading value on spectrum analyzer + cable loss

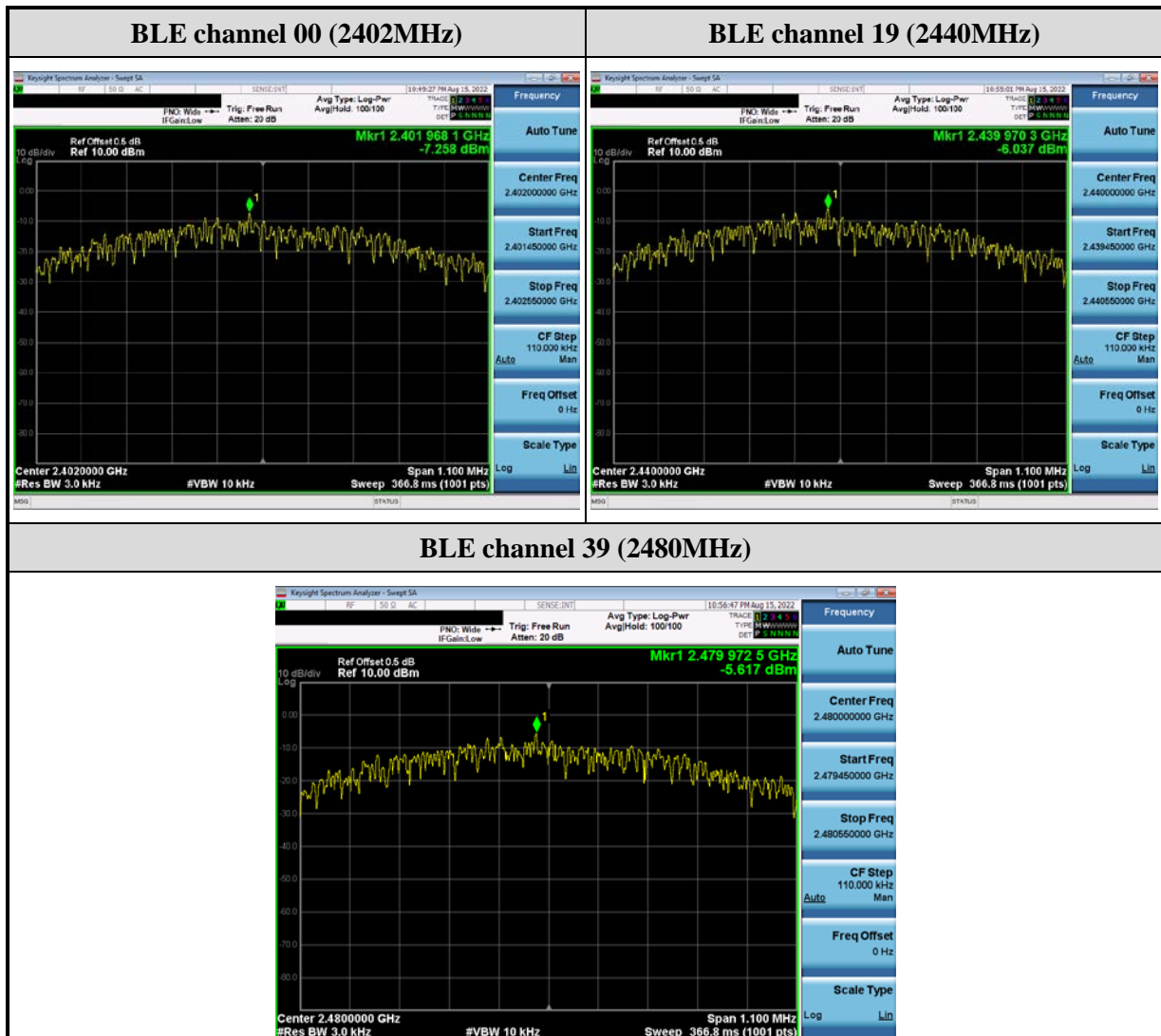

2.5 Conducted Band Edges and Spurious Emission Measurement

2.5.1 Limit

In any 100 KHz bandwidth outside the frequency bands in which the spread spectrum intentional radiator is operating, the radio frequency power that is produced by the intentional radiator shall be at least 20dB below that in the 100KHz bandwidth within the band that contains the highest level of the desired power, In addition, radiated emissions which fall in the restricted bands, as defined in must also comply with the radiated emission limits. If the transmitter complies with the conducted power limits based on the use of RMS averaging over a time interval, the attenuation required under this paragraph shall be 30 dB instead of 20 dB

2.5.2 Test Setup



2.5.3 Test Procedure

1. Reference ANSI C63.10 : 2013 chapter 6.10
2. Enable the EUT transmit continuously.
3. Spectrum analyzer set :
 - a) RBW = 100 kHz
 - b) VBW \geq 3 RBW
 - c) Detector = peak
 - d) Sweep time = auto couple
 - e) Trace mode = max hold.

2.5.4 Test Result

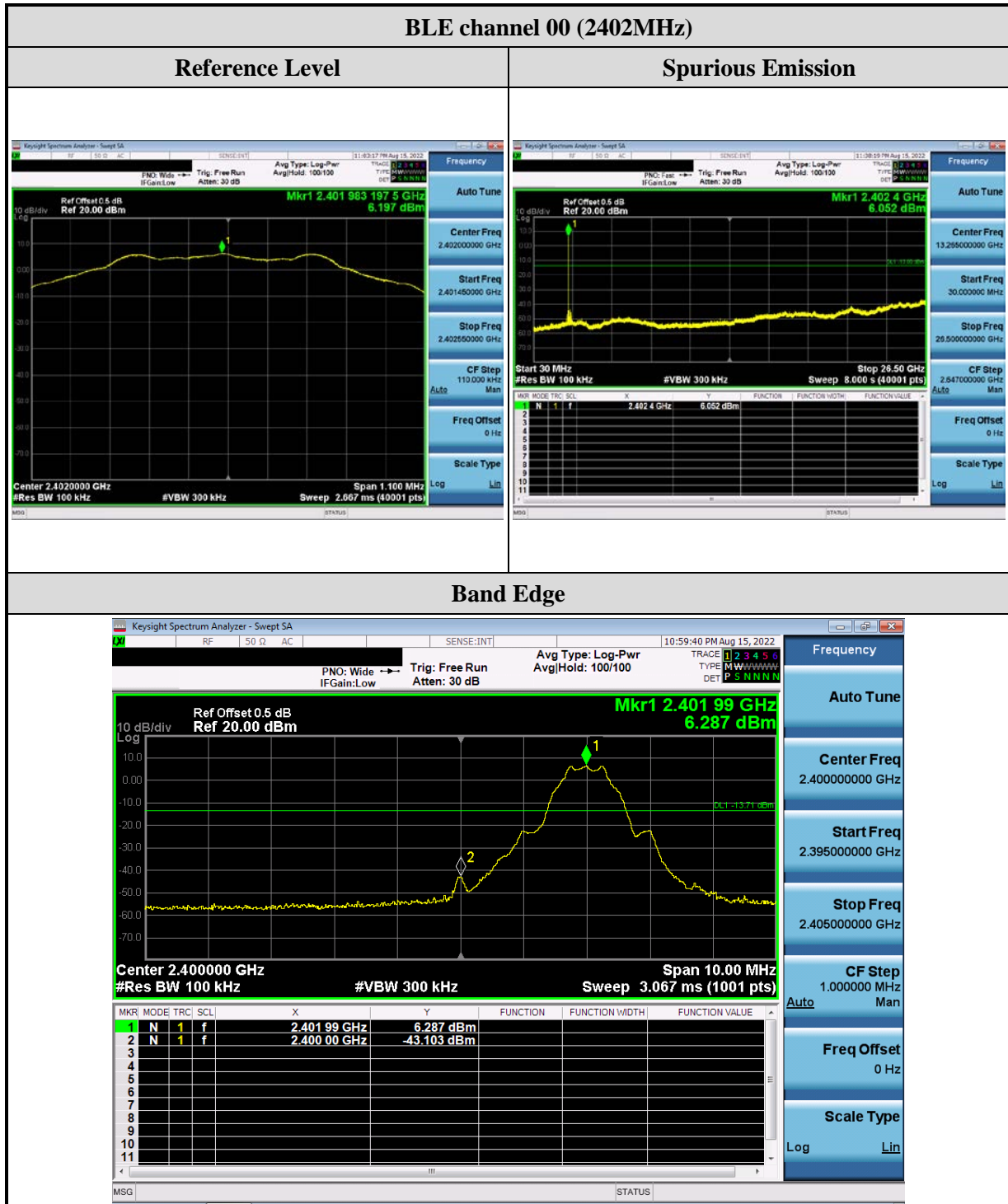

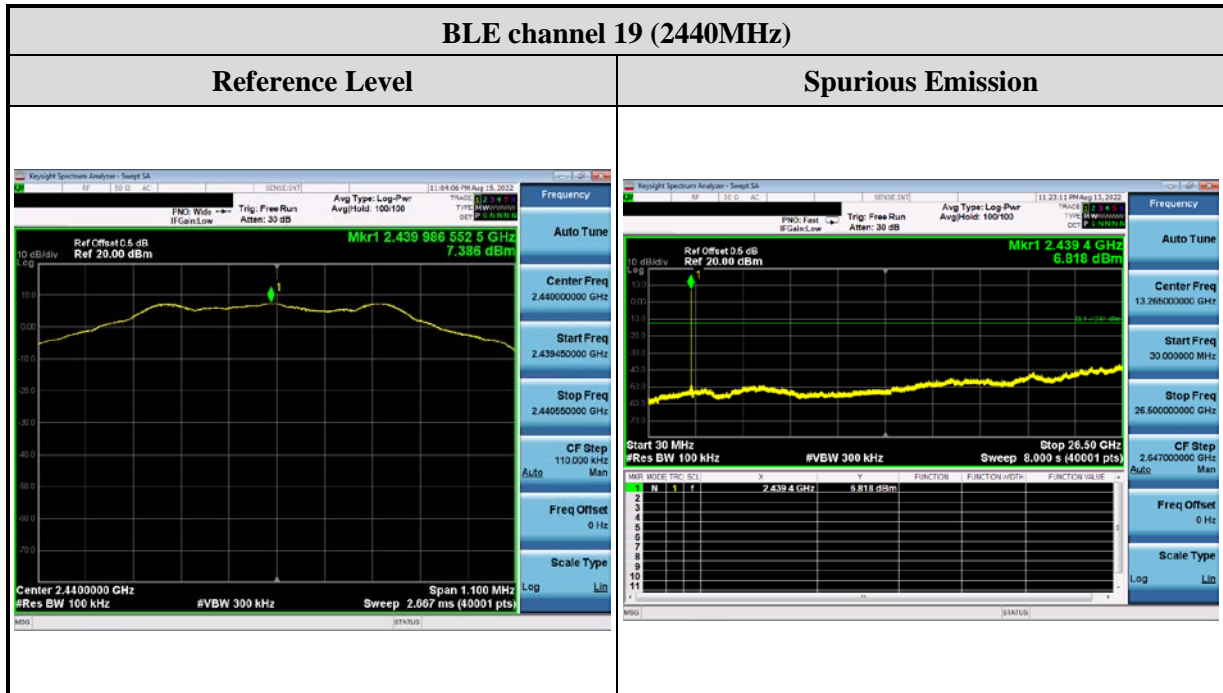

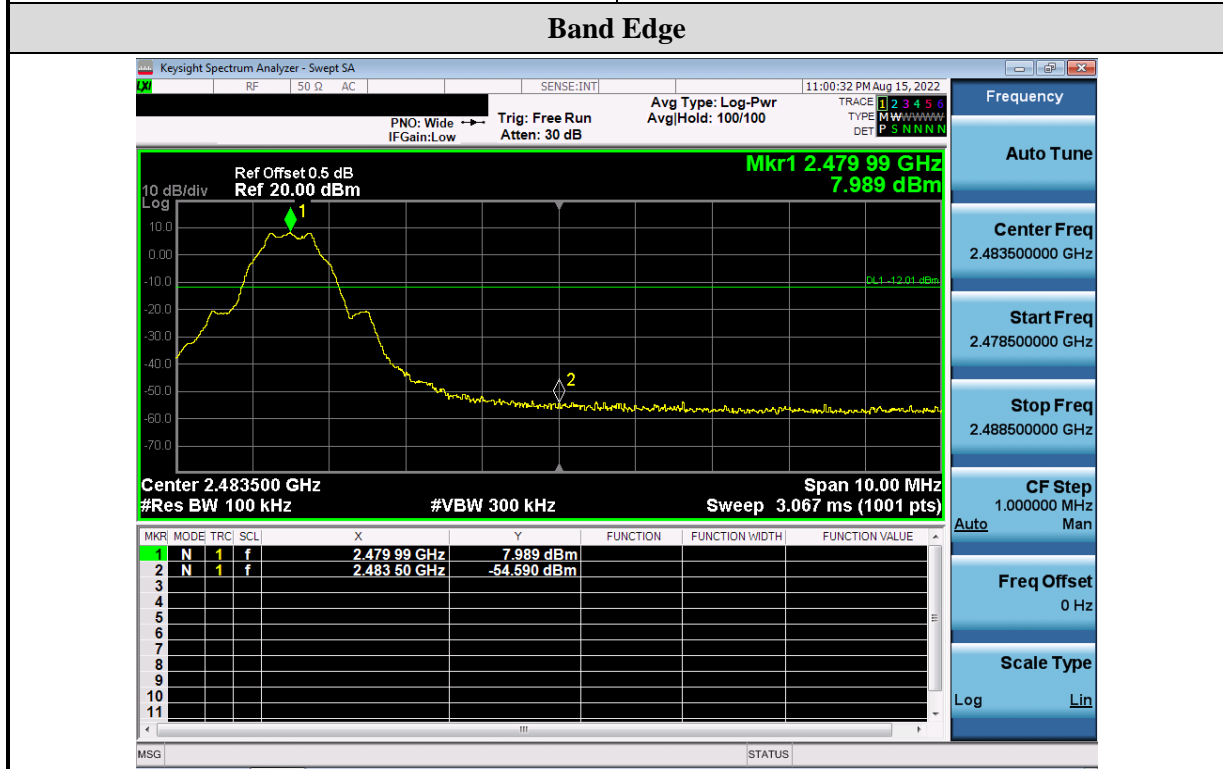
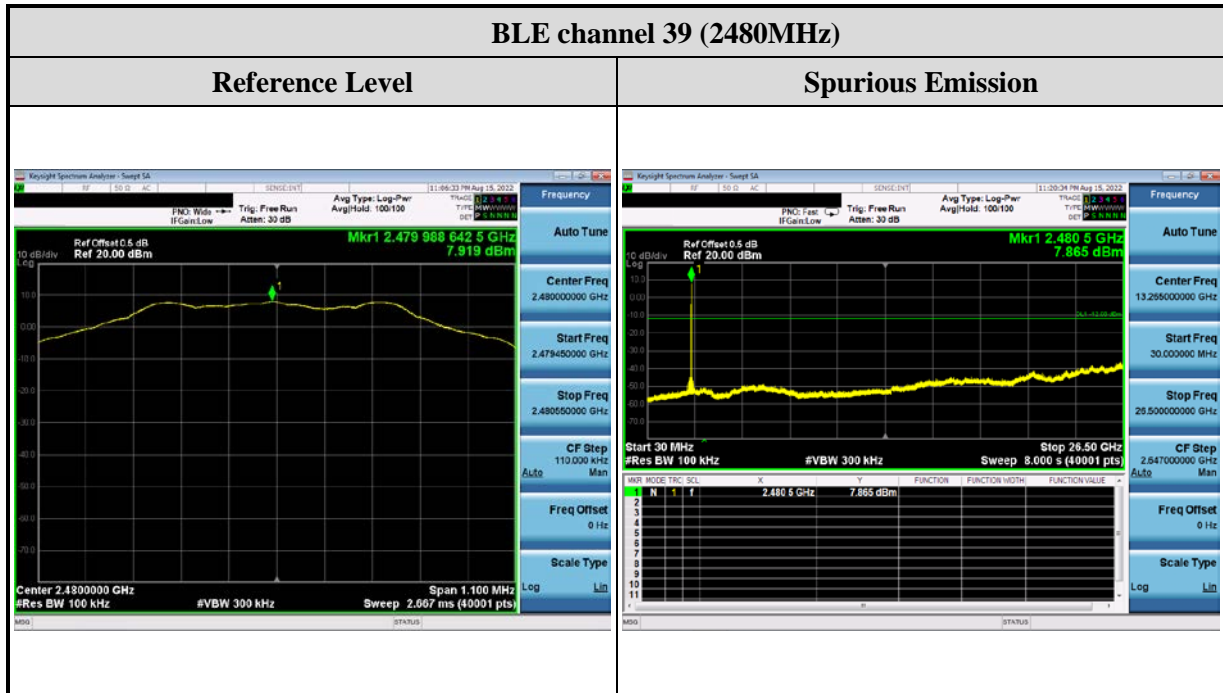

2.6 Radiated Band Edges and Spurious Emission Measurement

2.6.1 Limit

Frequency (MHz)	Field Strength ($\mu\text{V}/\text{m}$)	Measurement Distance (m)
0.009 – 0.490	2400/F(kHz)	300
0.490 – 1.705	24000/F(kHz)	30
1.705 – 30.0	30	30
30 – 88	100	3
88 – 216	150	3
216 - 960	200	3
Above 960	500	3

Remarks:

1. RF Voltage (dBuV) = $20 \log$ RF Voltage(μV)
2. In the Above Table, the tighter limit applies at the band edges.
3. Distance refers to the distance in meters between the measuring instrument antenna and the closed point of any part of the device or system

2.6.2 Test Setup

Below 30MHz

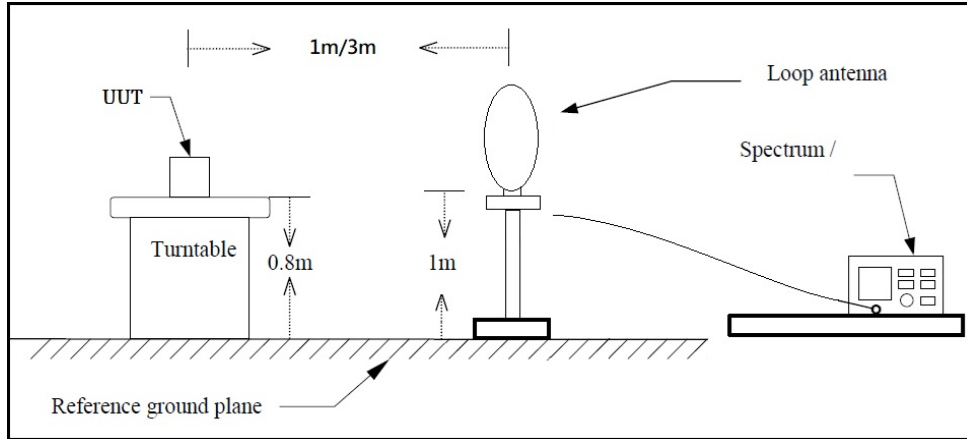

30MHz~1GHz

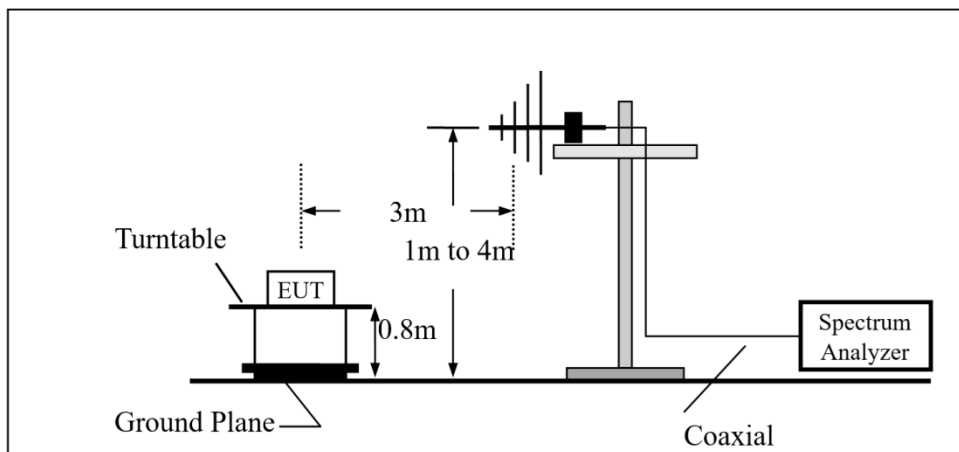

Above 1GHz

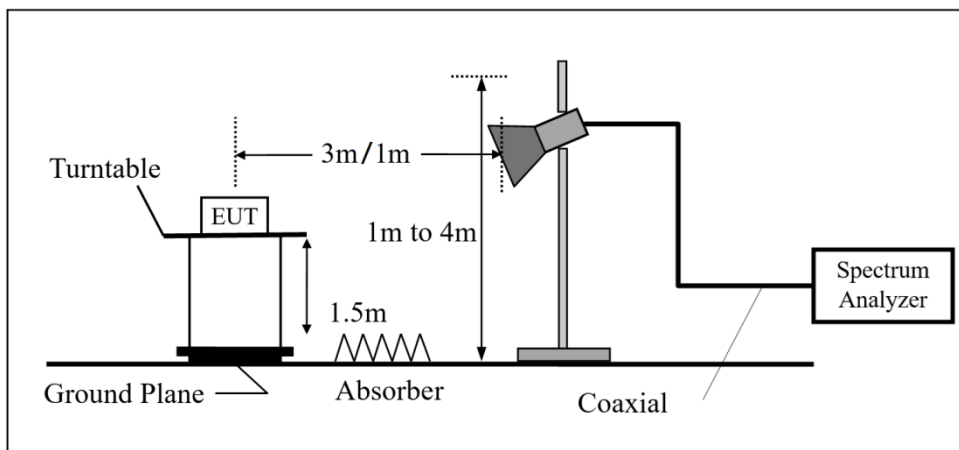

2.6.3 Test Procedure

The EUT was setup according to ANSI C63.10 : 2013 chapter 6.4, 6.5, 6.6 and tested according test procedure of KDB 558074 for compliance to FCC 47CFR 15.247 requirements.

For Radiated emission below 30MHz

- (1) The EUT was placed on the top of a rotating table 0.8 meters above the ground in a 3 meter chamber room. The table was rotated 360 degrees to determine the position of the highest radiation.
- (2) The EUT was set 3 meters away from the interference-receiving antenna, which was mounted on the top of a variable-height antenna tower.
- (3) Parallel, perpendicular, and ground-parallel orientations of the antenna are set to make the measurement.
- (4) For each suspected emission, the EUT was arranged to its worst case and the rotatable table was turned from 0 degrees to 360 degrees to find the maximum reading.
- (5) The test-receiver system was set to Quasi-Peak Detect Function and Specified Bandwidth with Maximum Hold Mode.

For Radiated emission Above 30MHz

- (1) The EUT was placed on the top of a rotating table 0.8 meters (for below 1GHz) / 1.5 meters (for above 1GHz) above the ground at 3 meter chamber room for the test. The table was rotated 360 degrees to determine the position of the highest radiation.
- (2) The EUT was set 3 meters away from the interference-receiving antenna, the height of the antenna is varied from 1 meter to 4 meters above the ground to determine the maximum value of the field strength.
- (3) Parallel, perpendicular, and ground-parallel orientations of the antenna are set to make the measurement.
- (4) For each suspected emission, the EUT was arranged to its worst case and the rotatable table was turned from 0 degrees to 360 degrees to find the maximum reading.
- (5) The test-receiver system was set to quasi-peak detect function and specified bandwidth with maximum hold mode when the test frequency is below 1 GHz.
- (6) The test-receiver system was set to peak and average detect function and specified bandwidth with maximum hold mode when the test frequency is above 1 GHz. If the peak reading value also meets the average limit, measurement with the average detector is unnecessary.

2.6.4 Duty Cycle

Protocol	Frequency (MHz)	on time (ms)	on+off time (ms)	Duty cycle	Duty Factor (dB)	1/T Minimum VBW (kHz)
BLE	2402	0.398	0.626	0.636	1.967	2.513

2.6.5 Test Result of Radiated Band Edge Measurement

The following tables for radiated measurement, pre-scanned in three orthogonal panels, X, Y, Z. The worst cases (X axis) were recorded in this report.

Test Frequency	
RF	BLE
Tx	CH00 (2402MHz)
	CH39 (2480MHz)

Test Mode :	Transmit BLE	Test Date :	2022/08/23
Test Channel :	CH00(2402MHz)	Temperature :	25.8 °C
Polarization :	Horizontal	Relative Humidity :	30 %

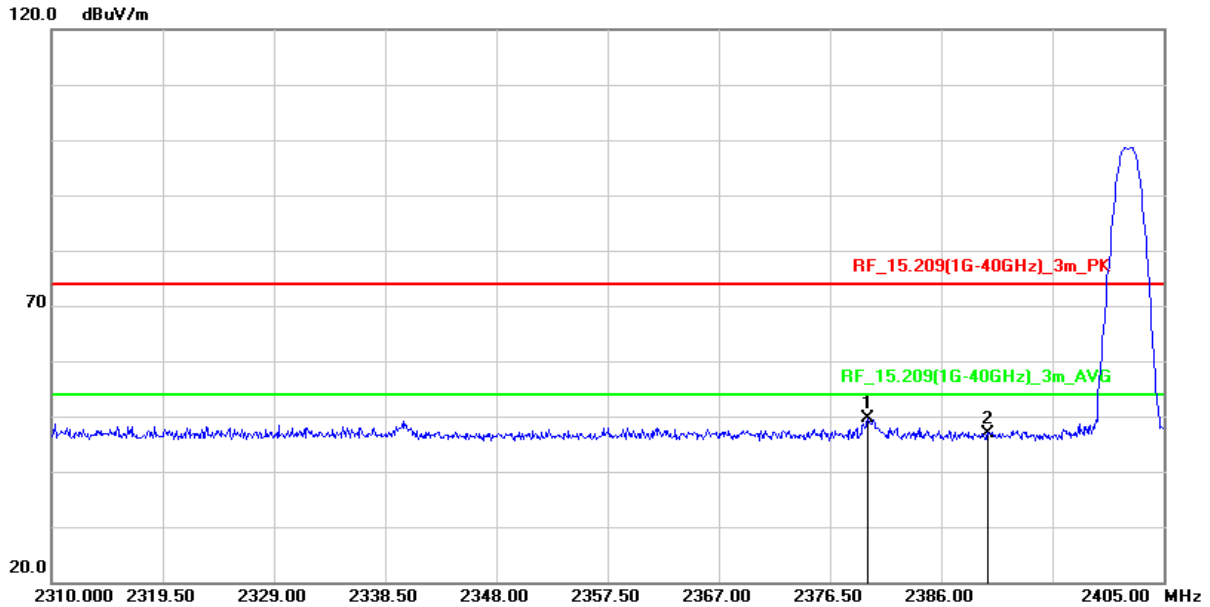

No.	Frequency (MHz)	Reading (dBuV/m)	Correct Factor (dB/m)	Result (dBuV/m)	Limit (dBuV/m)	Margin (dB)	Remark
1	2379.730	56.22	-6.71	49.51	74.00	-24.49	peak
2	2390.000	53.53	-6.69	46.84	74.00	-27.16	peak

Remark :

1. Correction Factor = Antenna factor + Cable loss – Amplifier gain
2. Result Value = Reading Level + Correct Factor
3. Margin Level = Result Value – Limit Value
4. The other emission levels were very low against the limit

Test Mode :	Transmit BLE	Test Date :	2022/08/23
Test Channel :	CH00(2402MHz)	Temperature :	25.8 °C
Polarization :	Vertical	Relative Humidity :	30 %

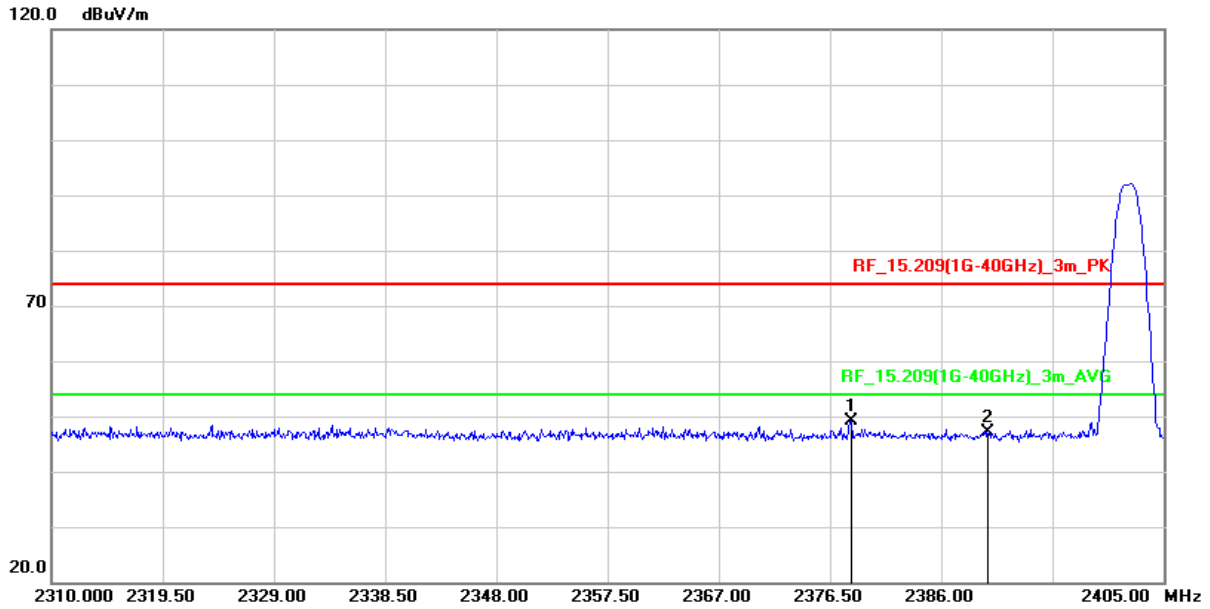

No.	Frequency (MHz)	Reading (dBuV/m)	Correct Factor (dB/m)	Result (dBuV/m)	Limit (dBuV/m)	Margin (dB)	Remark
1	2378.305	55.81	-6.71	49.10	74.00	-24.90	peak
2	2390.000	53.70	-6.69	47.01	74.00	-26.99	peak

Remark :

1. Correction Factor = Antenna factor + Cable loss – Amplifier gain
2. Result Value = Reading Level + Correct Factor
3. Margin Level = Result Value – Limit Value
4. The other emission levels were very low against the limit

Test Mode :	Transmit BLE	Test Date :	2022/08/23
Test Channel :	CH39(2480MHz)	Temperature :	25.8 °C
Polarization :	Horizontal	Relative Humidity :	30 %

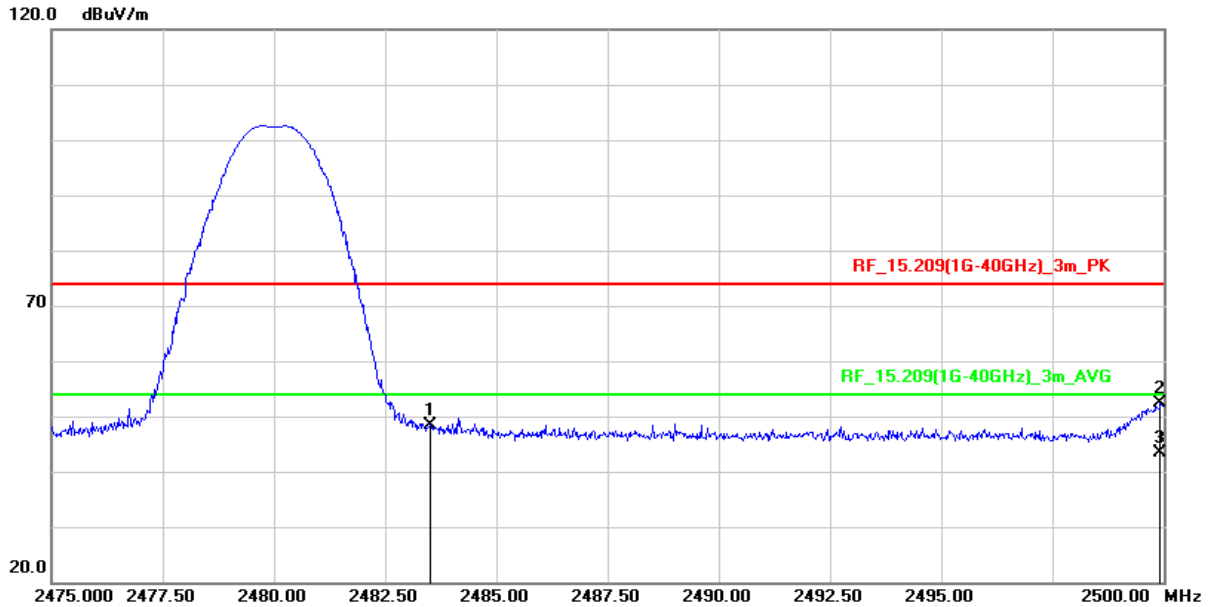

No.	Frequency (MHz)	Reading (dBuV/m)	Correct Factor (dB/m)	Result (dBuV/m)	Limit (dBuV/m)	Margin (dB)	Remark
1	2483.500	55.04	-6.61	48.43	74.00	-25.57	peak
2	2499.925	58.92	-6.58	52.34	74.00	-21.66	peak
3	2499.925	49.84	-6.58	43.26	54.00	-10.74	AVG

Remark :

1. Correction Factor = Antenna factor + Cable loss – Amplifier gain
2. Result Value = Reading Level + Correct Factor
3. Margin Level = Result Value – Limit Value
4. The other emission levels were very low against the limit

Test Mode :	Transmit BLE	Test Date :	2022/08/23
Test Channel :	CH39(2480MHz)	Temperature :	25.8 °C
Polarization :	Vertical	Relative Humidity :	30 %

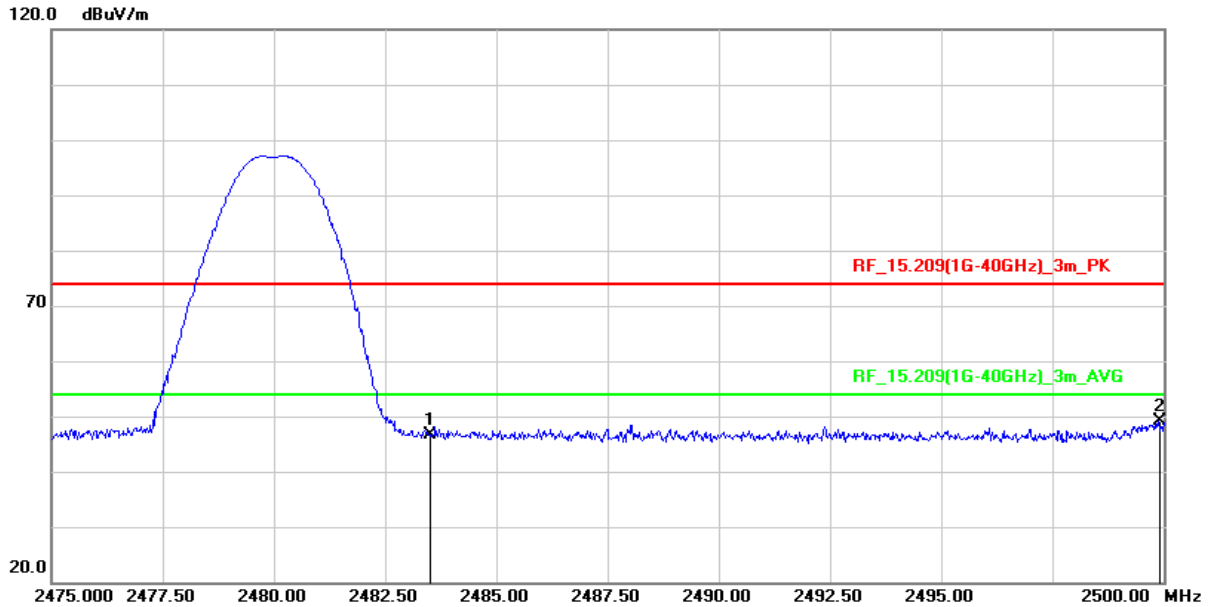

No.	Frequency (MHz)	Reading (dBuV/m)	Correct Factor (dB/m)	Result (dBuV/m)	Limit (dBuV/m)	Margin (dB)	Remark
1	2483.500	53.23	-6.61	46.62	74.00	-27.38	peak
2 *	2499.900	55.77	-6.58	49.19	74.00	-24.81	peak

Remark :

1. Correction Factor = Antenna factor + Cable loss – Amplifier gain
2. Result Value = Reading Level + Correct Factor
3. Margin Level = Result Value – Limit Value
4. The other emission levels were very low against the limit

2.6.6 Test Result of Radiated Spurious Emission Measurement

- (1) The radiation measurement frequency is 9kHz ~ 30MHz. The interference value of this frequency range is less than the limit value of 20 dB. It is considered that the background noise value is not recorded.
- (2) The following table shows the radiation measurement frequency from 30MHz to 26.5GHz, pre-scanning in the X, Y and Z axes. The worst case (**X**-axis) is documented in this report.

Test Frequency	
RF	BLE
Tx	CH00 (2402MHz)
	CH19 (2440MHz)
	CH39 (2480MHz)

Above 1GHz Data

Test Mode :	Transmit BLE	Test Date :	2022/08/23
Test Channel :	CH00(2402MHz)	Temperature :	25.8 °C
Polarization :	Horizontal	Relative Humidity :	30 %

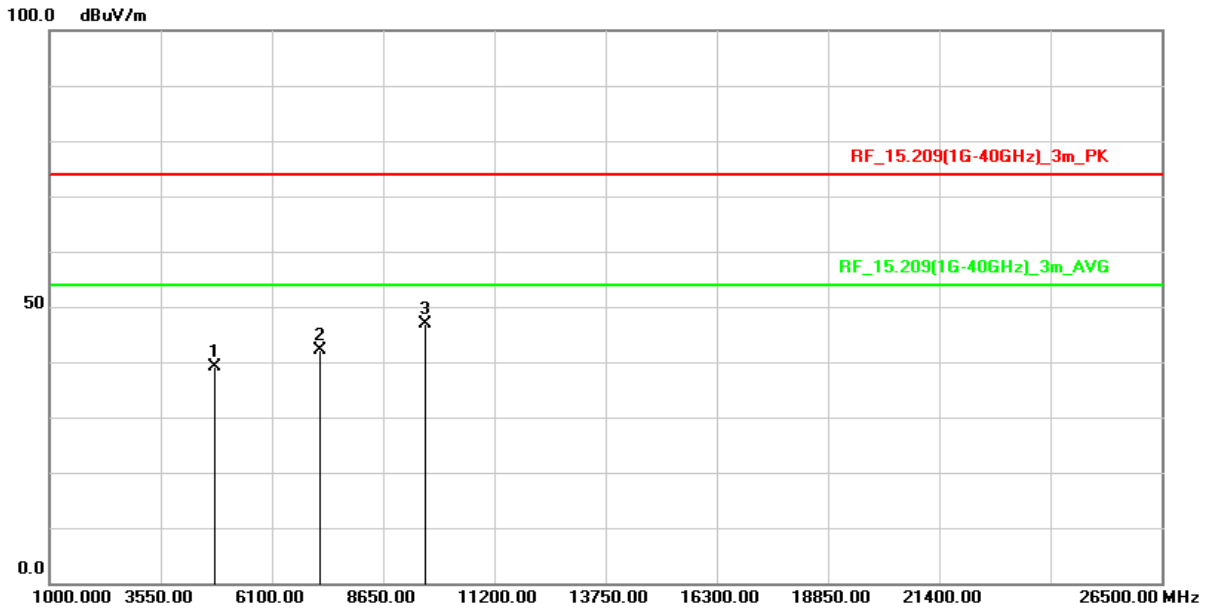

No.	Frequency (MHz)	Reading (dBuV/m)	Correct Factor (dB/m)	Result (dBuV/m)	Limit (dBuV/m)	Margin (dB)	Remark
1	4804.000	59.87	-20.63	39.24	74.00	-34.76	peak
2	7206.000	57.13	-14.88	42.25	74.00	-31.75	peak
3	9608.000	57.92	-10.94	46.98	74.00	-27.02	peak

Remark :

1. Correction Factor = Antenna factor + Cable loss – Amplifier gain
2. Result Value = Reading Level + Correct Factor
3. Margin Level = Result Value – Limit Value
4. The other emission levels were very low against the limit

Test Mode :	Transmit BLE	Test Date :	2022/08/23
Test Channel :	CH00(2402MHz)	Temperature :	25.8 °C
Polarization :	Vertical	Relative Humidity :	30 %

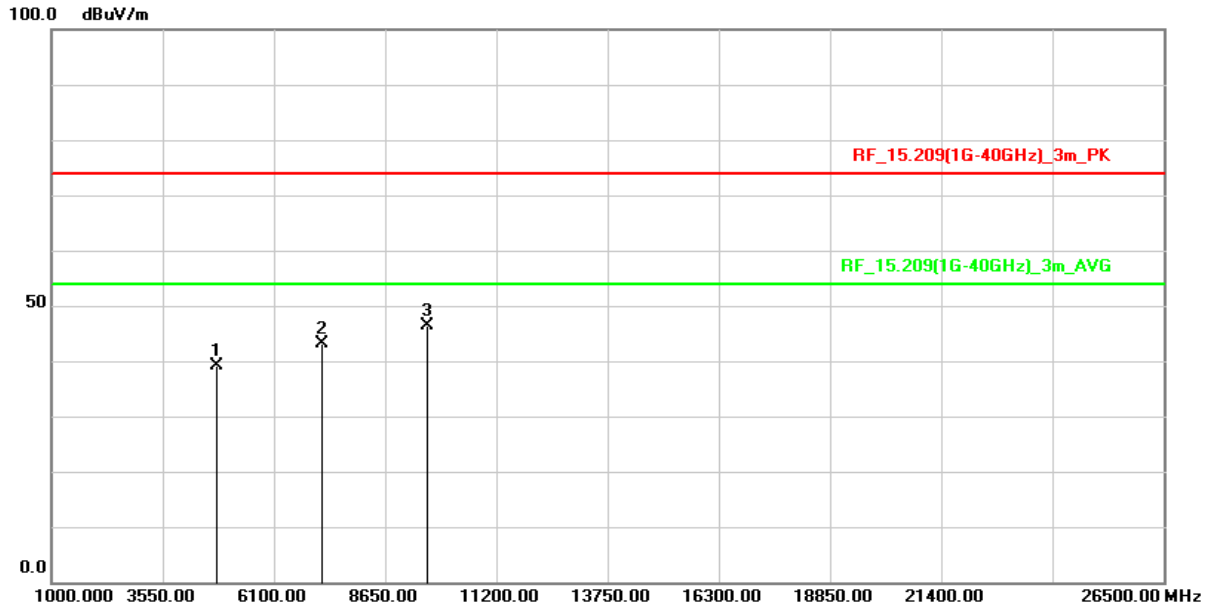

No.	Frequency (MHz)	Reading (dBuV/m)	Correct Factor (dB/m)	Result (dBuV/m)	Limit (dBuV/m)	Margin (dB)	Remark
1	4804.000	59.65	-20.63	39.02	74.00	-34.98	peak
2	7206.000	58.01	-14.88	43.13	74.00	-30.87	peak
3	9608.000	57.20	-10.94	46.26	74.00	-27.74	peak

Remark :

1. Correction Factor = Antenna factor + Cable loss – Amplifier gain
2. Result Value = Reading Level + Correct Factor
3. Margin Level = Result Value – Limit Value
4. The other emission levels were very low against the limit

Test Mode :	Transmit BLE	Test Date :	2022/08/23
Test Channel :	CH19(2440MHz)	Temperature :	25.8 °C
Polarization :	Horizontal	Relative Humidity :	30 %

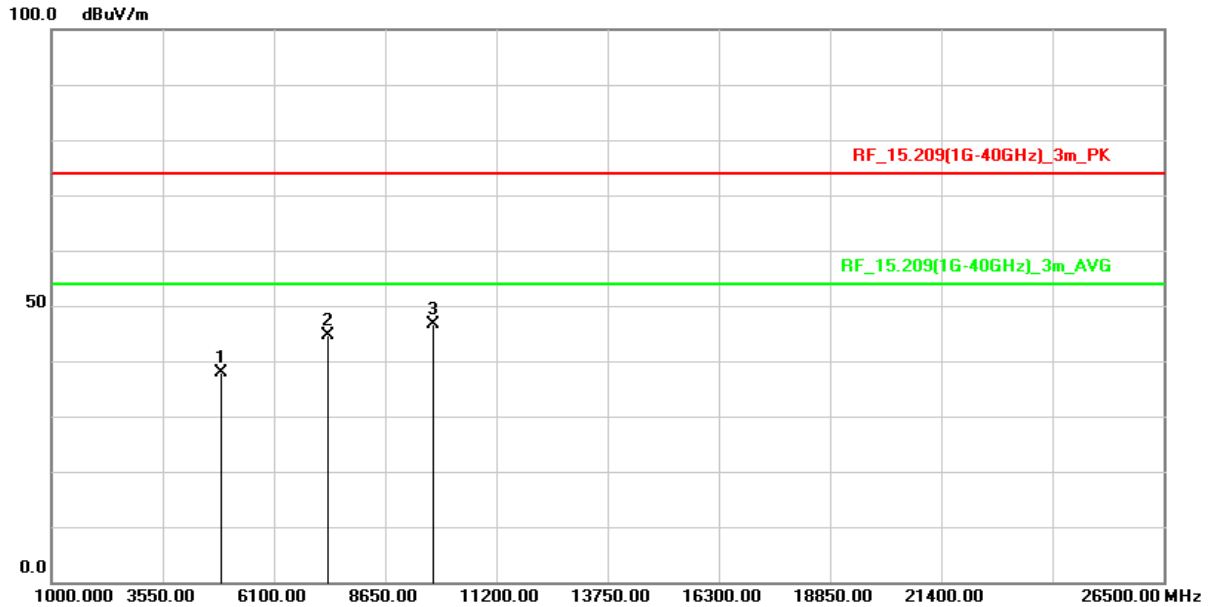

No.	Frequency (MHz)	Reading (dBuV/m)	Correct Factor (dB/m)	Result (dBuV/m)	Limit (dBuV/m)	Margin (dB)	Remark
1	4880.000	58.65	-20.73	37.92	74.00	-36.08	peak
2	7320.000	59.61	-14.95	44.66	74.00	-29.34	peak
3	9760.000	57.40	-10.69	46.71	74.00	-27.29	peak

Remark :

1. Correction Factor = Antenna factor + Cable loss – Amplifier gain
2. Result Value = Reading Level + Correct Factor
3. Margin Level = Result Value – Limit Value
4. The other emission levels were very low against the limit

Test Mode :	Transmit BLE	Test Date :	2022/08/23
Test Channel :	CH19(2440MHz)	Temperature :	25.8 °C
Polarization :	Vertical	Relative Humidity :	30 %

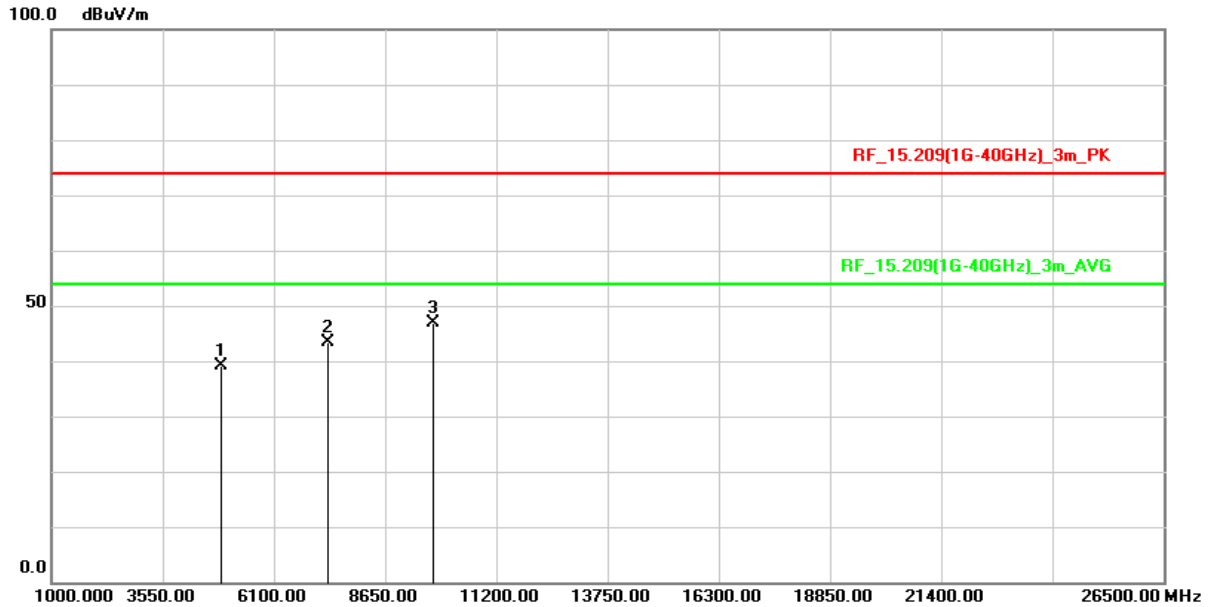

No.	Frequency (MHz)	Reading (dBuV/m)	Correct Factor (dB/m)	Result (dBuV/m)	Limit (dBuV/m)	Margin (dB)	Remark
1	4880.000	59.90	-20.73	39.17	74.00	-34.83	peak
2	7320.000	58.21	-14.95	43.26	74.00	-30.74	peak
3	9760.000	57.63	-10.69	46.94	74.00	-27.06	peak

Remark :

1. Correction Factor = Antenna factor + Cable loss – Amplifier gain
2. Result Value = Reading Level + Correct Factor
3. Margin Level = Result Value – Limit Value
4. The other emission levels were very low against the limit

Test Mode :	Transmit BLE	Test Date :	2022/08/23
Test Channel :	CH39(2480MHz)	Temperature :	25.8 °C
Polarization :	Horizontal	Relative Humidity :	30 %

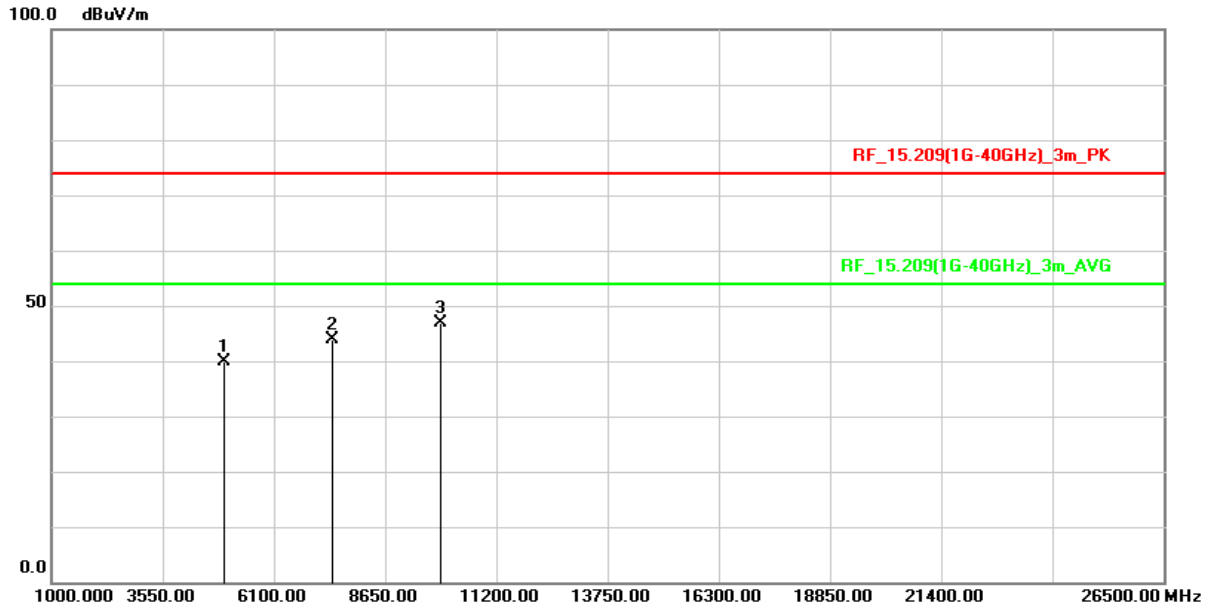

No.	Frequency (MHz)	Reading (dBuV/m)	Correct Factor (dB/m)	Result (dBuV/m)	Limit (dBuV/m)	Margin (dB)	Remark
1	4960.000	60.61	-20.68	39.93	74.00	-34.07	peak
2	7440.000	58.30	-14.50	43.80	74.00	-30.20	peak
3	9920.000	57.87	-10.88	46.99	74.00	-27.01	peak

Remark :

1. Correction Factor = Antenna factor + Cable loss – Amplifier gain
2. Result Value = Reading Level + Correct Factor
3. Margin Level = Result Value – Limit Value
4. The other emission levels were very low against the limit

Test Mode :	Transmit BLE	Test Date :	2022/08/23
Test Channel :	CH39(2480MHz)	Temperature :	25.8 °C
Polarization :	Vertical	Relative Humidity :	30 %

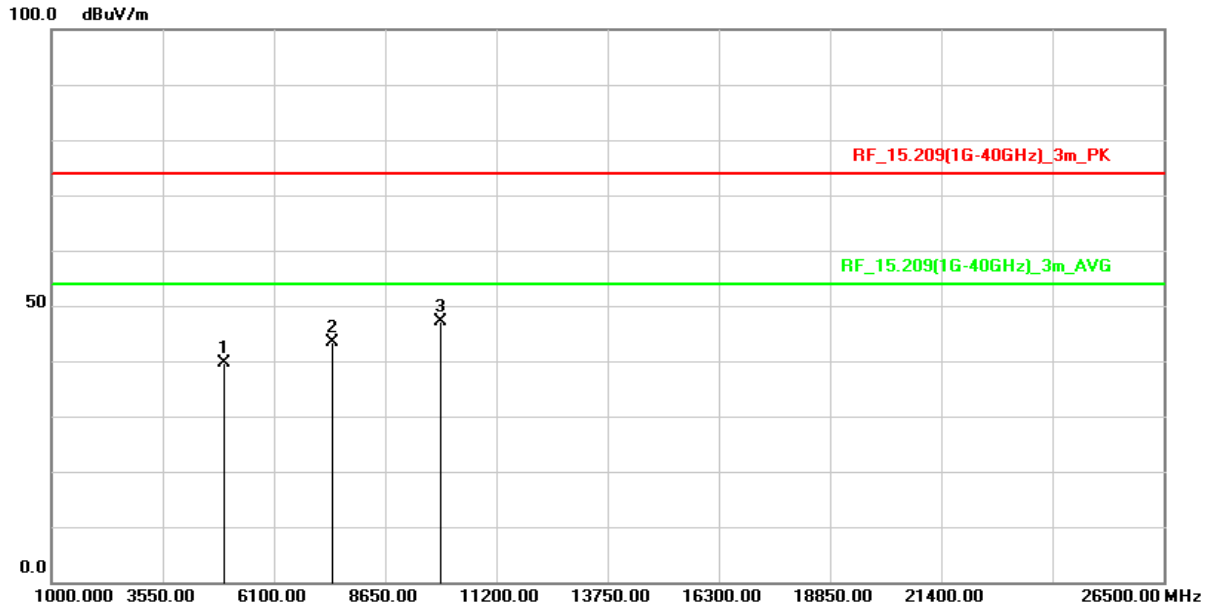

No.	Frequency (MHz)	Reading (dBuV/m)	Correct Factor (dB/m)	Result (dBuV/m)	Limit (dBuV/m)	Margin (dB)	Remark
1	4960.000	60.39	-20.68	39.71	74.00	-34.29	peak
2	7440.000	57.88	-14.50	43.38	74.00	-30.62	peak
3	9920.000	57.96	-10.88	47.08	74.00	-26.92	peak

Remark :

1. Correction Factor = Antenna factor + Cable loss – Amplifier gain
2. Result Value = Reading Level + Correct Factor
3. Margin Level = Result Value – Limit Value
4. The other emission levels were very low against the limit

Below 1GHz Data

Test Mode :	Transmit BLE	Test Date :	2022/08/23
Test Channel :	CH19(2440MHz)	Temperature :	25.8 °C
Polarization :	Horizontal	Relative Humidity :	30 %

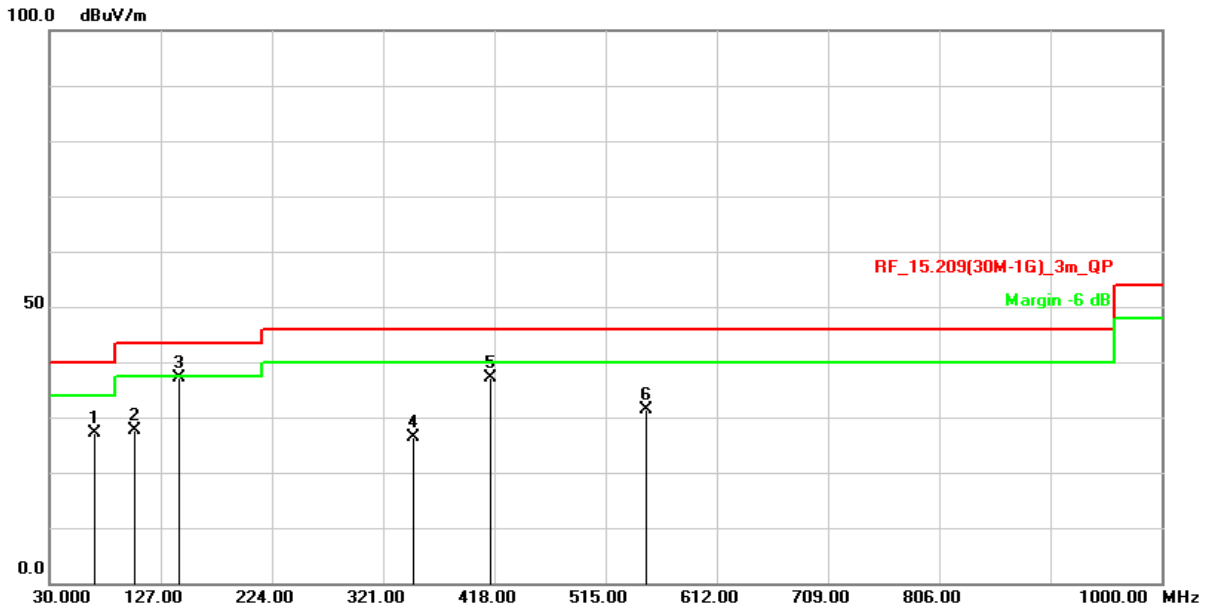

No.	Frequency (MHz)	Reading (dBuV/m)	Correct Factor (dB/m)	Result (dBuV/m)	Limit (dBuV/m)	Margin (dB)	Remark
1	69.7700	40.47	-13.43	27.04	40.00	-12.96	QP
2	104.6900	43.04	-15.32	27.72	43.50	-15.78	QP
3	143.4900	48.66	-11.51	37.15	43.50	-6.35	QP
4	347.1900	35.70	-9.28	26.42	46.00	-19.58	QP
5	415.0900	44.41	-7.38	37.03	46.00	-8.97	QP
6	549.9200	35.67	-4.23	31.44	46.00	-14.56	QP

Remark :

1. Correction Factor = Antenna factor + Cable loss – Amplifier gain
2. Result Value = Reading Level + Correct Factor
3. Margin Level = Result Value – Limit Value
4. The other emission levels were very low against the limit

Test Mode :	Transmit BLE	Test Date :	2022/08/23
Test Channel :	CH19(2440MHz)	Temperature :	25.8 °C
Polarization :	Vertical	Relative Humidity :	30 %

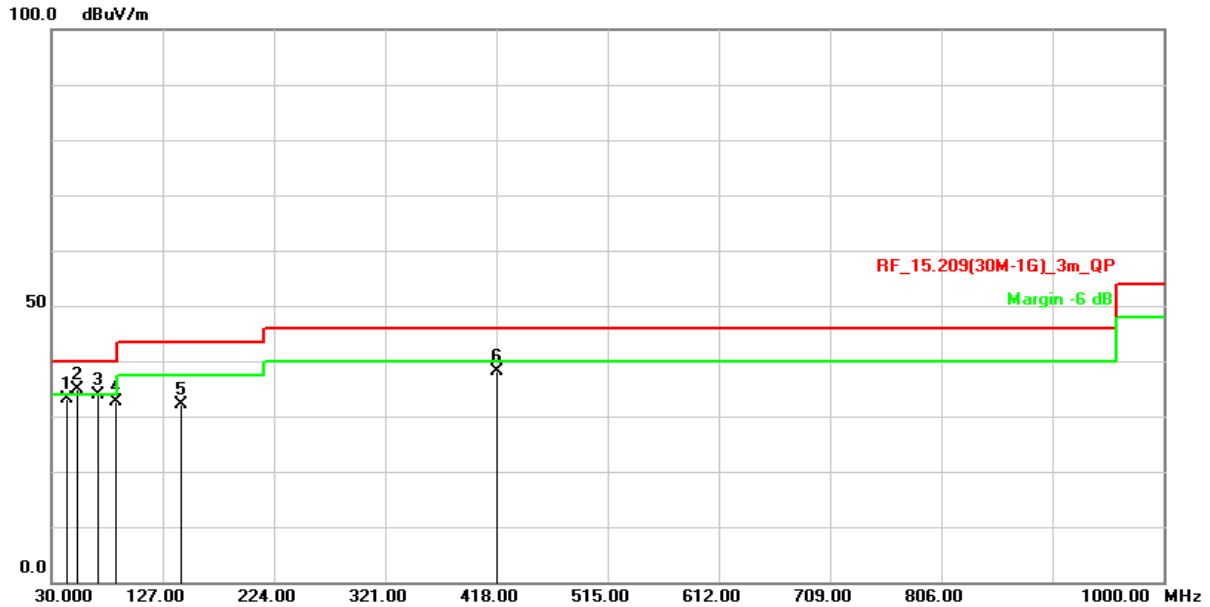

No.	Frequency (MHz)	Reading (dBuV/m)	Correct Factor (dB/m)	Result (dBuV/m)	Limit (dBuV/m)	Margin (dB)	Remark
1	43.5800	44.61	-11.39	33.22	40.00	-6.78	QP
2	52.3100	46.21	-11.45	34.76	40.00	-5.24	QP
3	70.7400	47.46	-13.48	33.98	40.00	-6.02	QP
4	86.2600	49.80	-17.06	32.74	40.00	-7.26	QP
5	143.4900	43.60	-11.51	32.09	43.50	-11.41	QP
6	418.0000	45.31	-7.24	38.07	46.00	-7.93	QP

Remark :

1. Correction Factor = Antenna factor + Cable loss – Amplifier gain
2. Result Value = Reading Level + Correct Factor
3. Margin Level = Result Value – Limit Value
4. The other emission levels were very low against the limit

2.7 AC Conducted Emissions Measurement

2.7.1 Limit

Frequency (MHz)	FCC Part 15 Subpart C Paragraph 15.207 (dB μ V) Limit	
	Quasi-peak	Average
0.15 to 0.5	66 to 56*	56 to 46*
0.50 to 5.0	56	46
5.0 to 30.0	60	50

*Decreases with the logarithm of the frequency

2.7.2 Test Setup

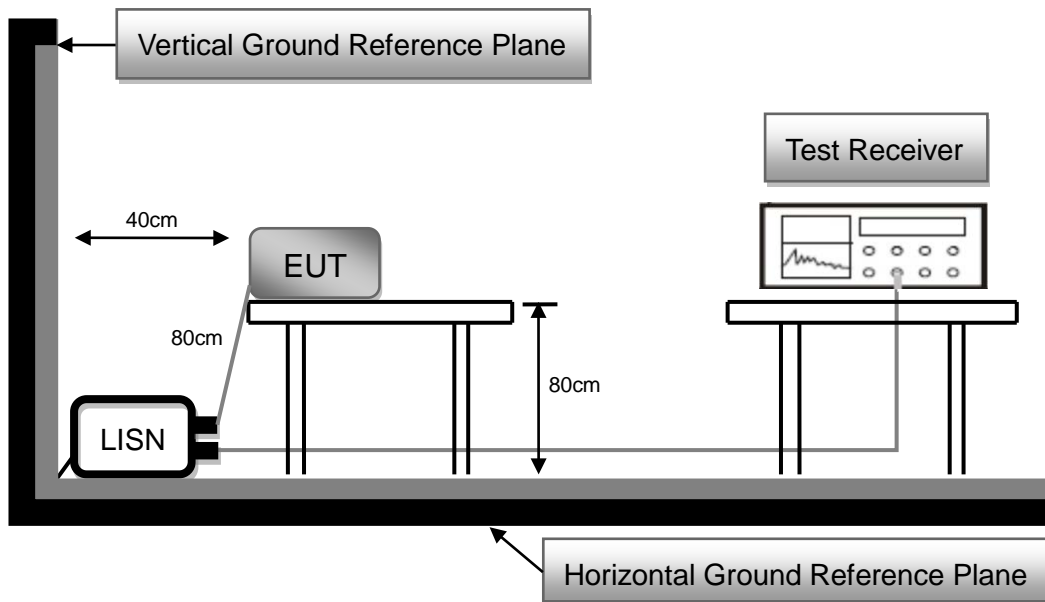

2.7.3 Test Procedure

1. Reference ANSI C63.10 : 2013 chapter 6.2
2. The EUT was placed 0.8 meter height wooden table from the horizontal ground plane with EUT being connected to power source through a line impedance stabilization network (LISN). The LISN at least be 80 cm from nearest chassis of EUT.
3. The line impedance stabilization network (LISN) provides 50 ohm/50uH of coupling impedance for the measuring instrument. All other support equipments powered from additional LISN(s).
4. Interrelating cables that hang closer than 40 cm to the ground plane shall be folded back and forth in the center forming a bundle. All I/O cables were positioned to simulate typical usage.
5. All I/O cables that are not connected to a peripheral shall be bundle in the center. The end of the cable may be terminated, if required, using the correct terminating impedance. The overall length shall not exceed 1 m.
6. The EMI test receiver connected to LISN powering the EUT. The actual test configuration, please refer to EUT test photos.
7. The receiver scanned from 150kHz to 30MHz for emissions in each of test modes. A scan was taken on both power lines, Line and Neutral, recording at least six highest emissions.
8. The EUT and cable configuration of the above highest emission levels were recorded. The Test Data of the worst case was recorded.

2.7.4 Test Result

Test Voltage :	120Vac, 60Hz	Frequency Range:	0.15-30 MHz
Test Mode :	Normal mode	6dB Bandwidth :	9 kHz
Test Date :	2022/07/27	Phase :	L
Temperature :	27°C	Humidity :	32 %

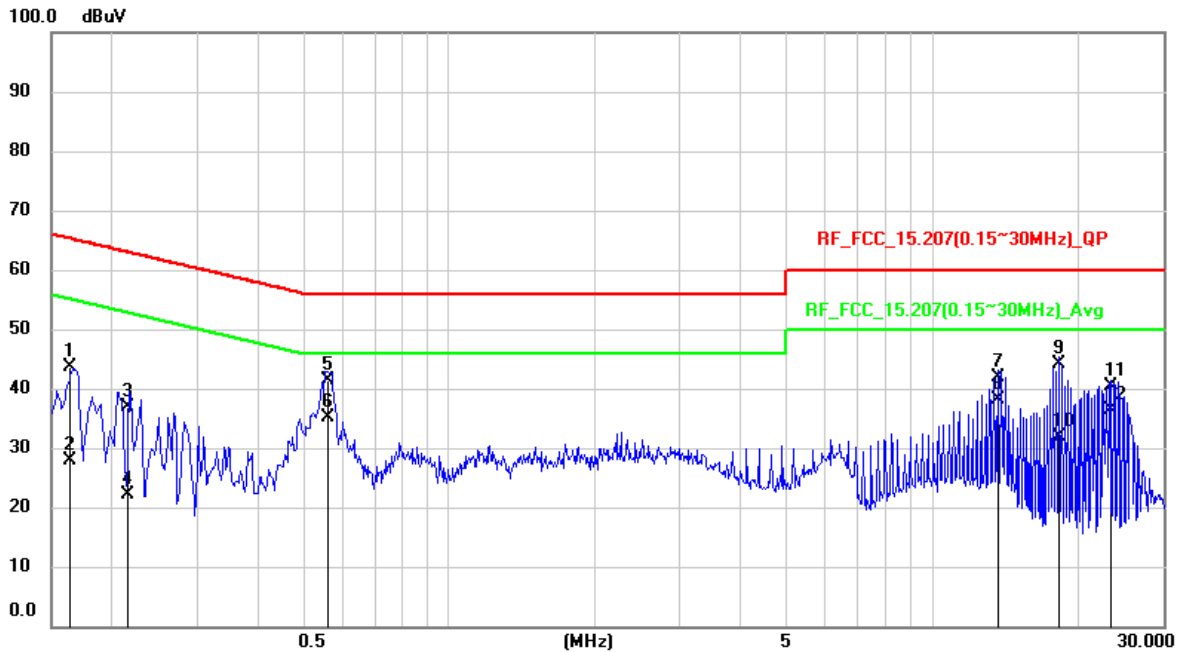

No.	Frequency (MHz)	Reading Level (dBuV)	Correct Factor (dB)	Measurement (dBuV)	Limit (dBuV)	Margin (dB)	Detector
1	0.1624	33.77	9.83	43.6	65.34	-21.74	QP
2	0.1624	18.11	9.83	27.94	55.34	-27.4	AVG
3	0.2161	27.09	9.82	36.91	62.97	-26.06	QP
4	0.2161	12.36	9.82	22.18	52.97	-30.79	AVG
5	0.5583	31.47	9.83	41.3	56	-14.7	QP
6	0.5583	25.19	9.83	35.02	46	-10.98	AVG
7	13.6376	31.68	10.12	41.8	60	-18.2	QP
8	13.6376	28.09	10.12	38.21	50	-11.79	AVG
9	18.2645	34.03	10.2	44.23	60	-15.77	QP
10	18.2645	21.64	10.2	31.84	50	-18.16	AVG
11	23.4175	30.04	10.33	40.37	60	-19.63	QP
12	23.4175	26.06	10.33	36.39	50	-13.61	AVG

Remark:

1. QP = Quasi Peak, AVG = Average
2. Correction Factor = Insertion loss of LISN + Cable loss
3. Measurement Value = Reading Level + Correct Factor
4. Margin Level = Result Value – Limit Value

Test Voltage :	120Vac, 60Hz	Frequency Range:	0.15-30 MHz
Test Mode :	Normal mode	6dB Bandwidth :	9 kHz
Test Date :	2022/07/27	Phase :	N
Temperature :	25°C	Humidity :	65 %

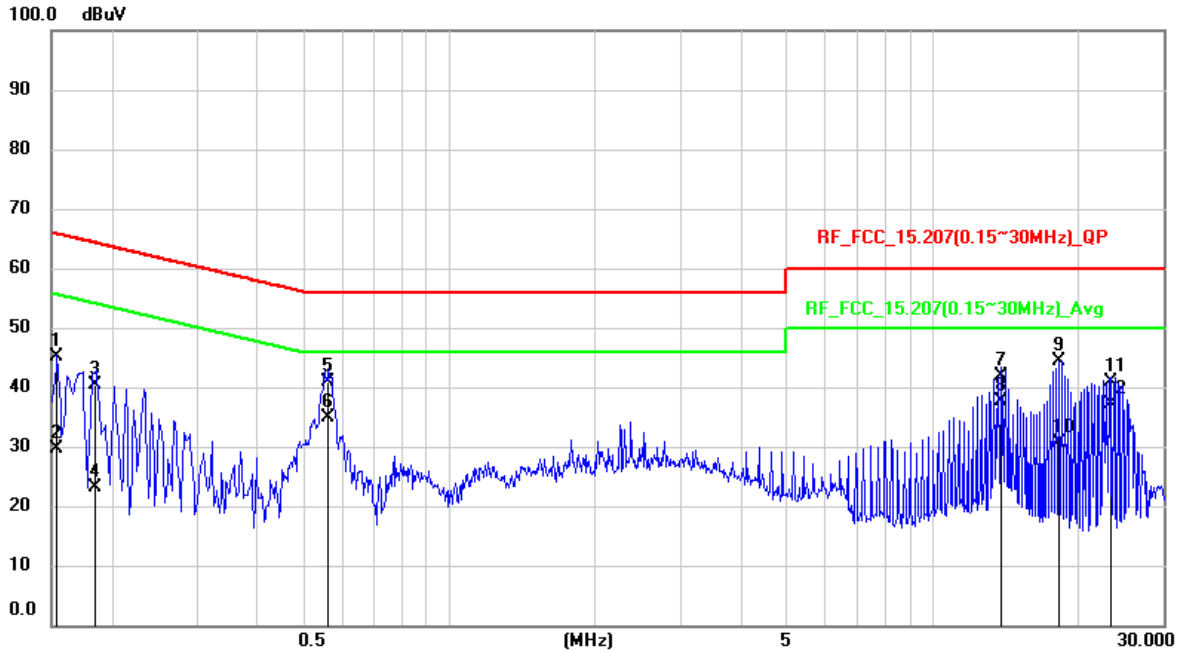

No.	Frequency (MHz)	Reading Level (dBuV)	Correct Factor (dB)	Measurement (dBuV)	Limit (dBuV)	Margin (dB)	Detector
1	0.1526	35.36	9.83	45.19	65.86	-20.67	QP
2	0.1526	19.87	9.83	29.7	55.86	-26.16	AVG
3	0.1844	30.53	9.82	40.35	64.29	-23.94	QP
4	0.1844	13.34	9.82	23.16	54.29	-31.13	AVG
5	0.559	31.14	9.83	40.97	56	-15.03	QP
6	0.559	25.06	9.83	34.89	46	-11.11	AVG
7	13.8977	31.78	10.12	41.9	60	-18.1	QP
8	13.8977	27.56	10.12	37.68	50	-12.32	AVG
9	18.2629	34.06	10.2	44.26	60	-15.74	QP
10	18.2629	20.35	10.2	30.55	50	-19.45	AVG
11	23.4178	30.44	10.33	40.77	60	-19.23	QP
12	23.4178	26.85	10.33	37.18	50	-12.82	AVG

Remark:

1. QP = Quasi Peak, AVG = Average
2. Correction Factor = Insertion loss of LISN + Cable loss
3. Measurement Value = Reading Level + Correct Factor
4. Margin Level = Result Value – Limit Value

--- END ---