FCC Test Report

Report No: WD-RF-R-230316-C0

Product Name : Doorbell
Model Name : DR40
FCC ID : 2AZ3JDR40
Applicant : Rhombus Systems, Inc.
Received Date : Sep. 01, 2023
Tested Date : Sep. 11, 2023 ~ Oct. 16, 2023
Applicable Standard : 47 CFR FCC Part 15, Subpart C (Section 15.247)
KDB 558074 D01 DTS Meas. Guidance v05
ANSI C63.10 : 2013



Wendell Industrial Co., Ltd
Wendell EMC & RF Laboratory

Caution:

This report sets forth our findings solely with respect to the test samples identified herein. The results set forth in this report are not indicative or representative of the quality or characteristics of the lot from which a test sample was taken or any similar or identical product unless specifically and expressly noted.

The test results shown in the test report are traceable to the national/international standard through the calibration report of the equipment.

Please note that the measurement uncertainty are provided for informational purpose only and are not used in determining the Pass/Fail results.

This report must not be used to claim product endorsement by TAF or any agency of the government.

The test report shall not be reproduced without the written approval of Wendell Industrial Co., Ltd..

Test Report

Issued Date: October 16, 2023

Project No.: 22Q090502

Product Name	Doorbell
Trade Name	rhombus
Brand Trademark	 rhombus
Model Name	DR40
FCC ID	2AZ3JDR40
Applicant	Rhombus Systems, Inc.
Manufacturer	Dynacolor Inc.
EUT Rated Voltage	DC 12V ~ 28V 、 POE 42.5V ~ 57V
EUT Test Voltage	AC 120V / 60Hz
EUT Supports Radios Application	WLAN 802.11a/b/g 、 WLAN 802.11n (HT20/HT40) WLAN 802.11ac (VHT20/VHT40/VHT80) Bluetooth BR/EDR/LE 、 NFC 13.56 MHz
Applicable Standard	47 CFR FCC Part 15, Subpart C (Section 15.247) KDB 558074 D01 DTS Meas. Guidance v05 ANSI C63.10 : 2013
Output Power	22.81 dBm
Test Result	Complied

Documented :



(Specialist / Emma Lu)

Technical Engineer :



(Section Manager / Jack Chang)

Approved :



(Project Manager / Gary Wu)

Table of Contents

Document Revision History	5
Summary of Test Result.....	6
1 Generation Information	7
1.1 Applicant.....	7
1.2 Manufacturer.....	7
1.3 Description of Equipment under Test.....	7
1.4 Test Mode Applicability And Tested Channel Detail	10
1.5 Configuration of Tested System	12
1.6 EUT Exercise Software	13
1.7 Tested System Details.....	13
1.8 Test Facility	14
1.9 Measurement Uncertainty	15
1.10 List of Test Equipment.....	16
2 Test Result	20
2.1 Antenna Requirement.....	20
2.1.1 Applicable Standard.....	20
2.1.2 Antenna Connected Construction	20
2.1.3 Antenna Gain	20
2.2 Peak Output Power Measurement.....	21
2.2.1 Limit	21
2.2.2 Test Setup.....	21
2.2.3 Test Procedure.....	21
2.2.4 Test Result	22
2.3 6dB Bandwidth Measurement.....	23
2.3.1 Limit	23
2.3.2 Test Setup.....	23
2.3.3 Test Procedure.....	23
2.3.4 Test Result	24
2.4 Power Spectral Density Measurement.....	27
2.4.1 Limit	27
2.4.2 Test Setup.....	27
2.4.3 Test Procedure.....	27
2.4.4 Test Result	28
2.5 Conducted Band Edges and Spurious Emission Measurement	31
2.5.1 Limit	31
2.5.2 Test Setup.....	31
2.5.3 Test Procedure.....	31
2.5.4 Test Result	32
2.6 Radiated Band Edges and Spurious Emission Measurement	41
2.6.1 Limit	41
2.6.2 Test Setup.....	42
2.6.3 Test Procedure.....	43
2.6.4 Duty Cycle	45
2.6.5 Test Result of Radiated Band Edge Measurement.....	45
2.6.6 Test Result of Radiated Spurious Emission Measurement	58
2.7 AC Conducted Emissions Measurement.....	79

2.7.1	Limit	79
2.7.2	Test Setup.....	79
2.7.3	Test Procedure.....	80
2.7.4	Test Result	81

Attachment 1: EUT Test Photographs

Attachment 2: EUT Detailed Photographs

Document Revision History

Report No.	Issue date	Description
WD-RF-R-230316-C0	October 16, 2023	Initial report

Summary of Test Result

Ref. Std. Clause	Test Items	Result
15.203 15.247(C)	Antenna Requirement	Pass
15.247(b)	Peak Output Power	Pass
15.247(a)(2)	6dB Bandwidth	Pass
15.247(e)	Power Spectral Density	Pass
15.247(d)	Conducted Band Edges and Conducted Spurious Emission	Pass
15.247(d)	Radiated Band Edges and Radiated Spurious Emission	Pass
15.207	AC Conducted Emission	Pass

1 Generation Information

1.1 Applicant

Rhombus Systems, Inc.
1920 20th St, Sacramento, CA 95811

1.2 Manufacturer

Dynacolor Inc.
NO. 116 JOU TZ STREET, NEIHU, TAIPEI 114, TAIWAN

1.3 Description of Equipment under Test

Product Name	Doorbell
Model No.	DR40
FCC ID	2AZ3JDR40
Frequency Range	802.11b/g/n-20MHz: 2412~2462MHz
Number of Channels	802.11b/g/n-20MHz: 11
Data Rate	802.11b: 1-11Mbps, 802.11g: 6-54Mbps, 802.11n: up to 72.2Mbps
Channel separation	802.11b/g/n: 5 MHz
Type of Modulation	802.11b: DSSS (DBPSK, DQPSK, CCK) 802.11g/n: OFDM (BPSK, QPSK, 16QAM, 64QAM)
Antenna Information	Refer to the table "Antenna List"
EUT Supports Radios Application	WLAN 802.11a/b/g WLAN 802.11n (HT20/HT40) WLAN 802.11ac (VHT20/VHT40/VHT80) Bluetooth BR/EDR/LE NFC 13.56 MHz
EUT Rated Voltage	DC 12V ~ 28V 、POE 42.5V ~ 57V
EUT Test Voltage	AC 120V / 60Hz

Antenna List

No.	Manufacturer	Model No.	Antenna Type	Peak Gain
1	INPAQ	RFMTA211200NNLB001	Metal Antenna	3.51 dBi for 2.4GHz

Remark: The antenna of EUT is conforming to FCC 15.203

Channel List

802.11b/g/n HT20	
Channel	Frequency(MHz)
01	2412
02	2417
03	2422
04	2427
05	2432
06	2437
07	2442
08	2447
09	2452
10	2457
11	2462

Test Frequencies in each operating band

Frequency range over which the device operates in each operating band (Note 1)	Number of test frequencies required	Location of test frequencies inside the operating frequency range (Note 1,2)
≤ 1 MHz	1	near center
> 1 MHz and ≤ 10 MHz	2	1 near high end, 1 near low end
> 10 MHz	3	1 near high end, 1 near center, and 1 near low end

Note 1: The frequency range over which the device operates in a given operating band is the difference between the highest and lowest frequencies on which the device can be tuned within that given operating band. The frequency range can be smaller than or equal to the operating band, but cannot be greater than the operating band.

Note 2: In the third column of table 1, “near” means as close as possible to or at the center / low end / high end of the frequency range over which the device operates.

Firmware / Software Version

1	Product Name	Doorbell
2	Model No.	DR40
3	Test SW Version	Putty_Ver.0.63
4	RF power setting in TEST SW	<input type="checkbox"/> RF power setting was not able to alter during testing. <input checked="" type="checkbox"/> RF power setting was able to alter during testing. (See the following table)

Parameters of test software setting

Type of Modulation	Channel	Frequency (MHz)	Set Value
802.11b	01	2412	18
	06	2437	18
	11	2462	17
802.11g	01	2412	16
	06	2437	16
	11	2462	16
802.11n HT20	01	2412	15
	06	2437	15
	11	2462	15

1.4 Test Mode Applicability And Tested Channel Detail

1. This device is a Doorbell with a built-in Wi-Fi, Bluetooth and NFC transceiver.
2. These tests were performed on a sample of equipment to demonstrate compliance with 47 CFR FCC Part 15, Subpart C (Section 15.247).
3. The EUT has been pre-tested under the following test modes, and test mode A was the worst case for final test. The EUT has the following different power supply. After laboratory evaluation, the worst mode must be found by pre-test results of radiation 30M-1GHz.

EUT Configure Mode	RE < 1G	RE ≥ 1G	ACM	ACP	Description
A	<input checked="" type="checkbox"/>	<input type="checkbox"/>	<input type="checkbox"/>	<input type="checkbox"/>	PoE Mode
B	<input checked="" type="checkbox"/>	<input type="checkbox"/>	<input type="checkbox"/>	<input type="checkbox"/>	DC Mode

4. Pre-Scan has been conducted to determine the worst-case mode from all possible combinations between available modulations, data rates, XYZ axis and antenna ports.
5. The worst case was found when positioned on X axis for radiated emission. Following test modes were selected for the final test, and the final worst case is recorded in the report:

EUT Configure Mode	RE < 1G	RE ≥ 1G	ACM	ACP	Description
--	<input checked="" type="checkbox"/>	<input checked="" type="checkbox"/>	<input checked="" type="checkbox"/>	<input checked="" type="checkbox"/>	Transmit WIFI

Note : RE<1G: Radiated Emission below 1GHz RE≥1G: Radiated Emission above 1GHz
 ACM: Antenna Port Conducted Measurement ACP: AC Power Line Conducted Emission

Following channel(s) was (were) selected for the final test as listed below:

Radiated Spurious Emission Measurement(Below 1GHz):

EUT Configure Mode	Mode	Available Channel	Tested Channel	Modulation Type	Data Rate (Mbps)
--	802.11g	1 ~ 11	06	DSSS	1

Radiated Spurious Emission Measurement(Above 1GHz):

EUT Configure Mode	Mode	Available Channel	Tested Channel	Modulation Type	Data Rate (Mbps)
--	802.11b	1 ~ 11	01, 06, 11	DSSS	1
--	802.11g	1 ~ 11	01, 06, 11	OFDM	6
--	802.11n HT20	1 ~ 11	01, 06, 11	OFDM	6.5

Radiated Band Edge Emission Measurement(Above 1GHz):

EUT Configure Mode	Mode	Available Channel	Tested Channel	Modulation Type	Data Rate (Mbps)
--	802.11b	1 ~ 11	01, 11	DSSS	1
--	802.11g	1 ~ 11	01, 11	OFDM	6
--	802.11n HT20	1 ~ 11	01, 11	OFDM	6.5

Peak Output Power, 6dB Bandwidth, Power Spectral Density, Conducted Spurious Emission:

EUT Configure Mode	Mode	Available Channel	Tested Channel	Modulation Type	Data Rate (Mbps)
--	802.11b	1 ~ 11	01, 06, 11	DSSS	1
--	802.11g	1 ~ 11	01, 06, 11	OFDM	6
--	802.11n HT20	1 ~ 11	01, 06, 11	OFDM	6.5

Conducted Band Edges:

EUT Configure Mode	Mode	Available Channel	Tested Channel	Modulation Type	Data Rate (Mbps)
--	802.11b	1 ~ 11	01, 11	DSSS	1
--	802.11g	1 ~ 11	01, 11	OFDM	6
--	802.11n HT20	1 ~ 11	01, 11	OFDM	6.5

AC Conducted Emission:

EUT Configure Mode	Mode	Available Channel	Tested Channel	Modulation Type	Data Rate (Mbps)
--	802.11b	1 ~ 11	06	DSSS	1

1.5 Configuration of Tested System

Radiation

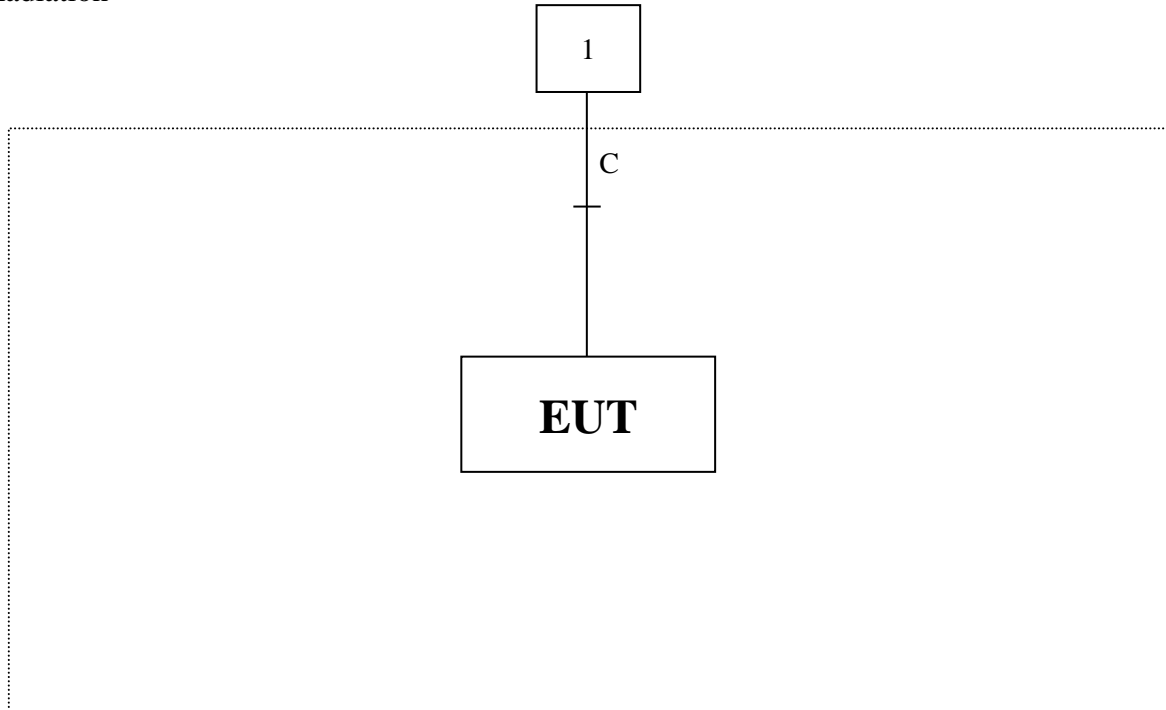

Test Table

AC Conduction

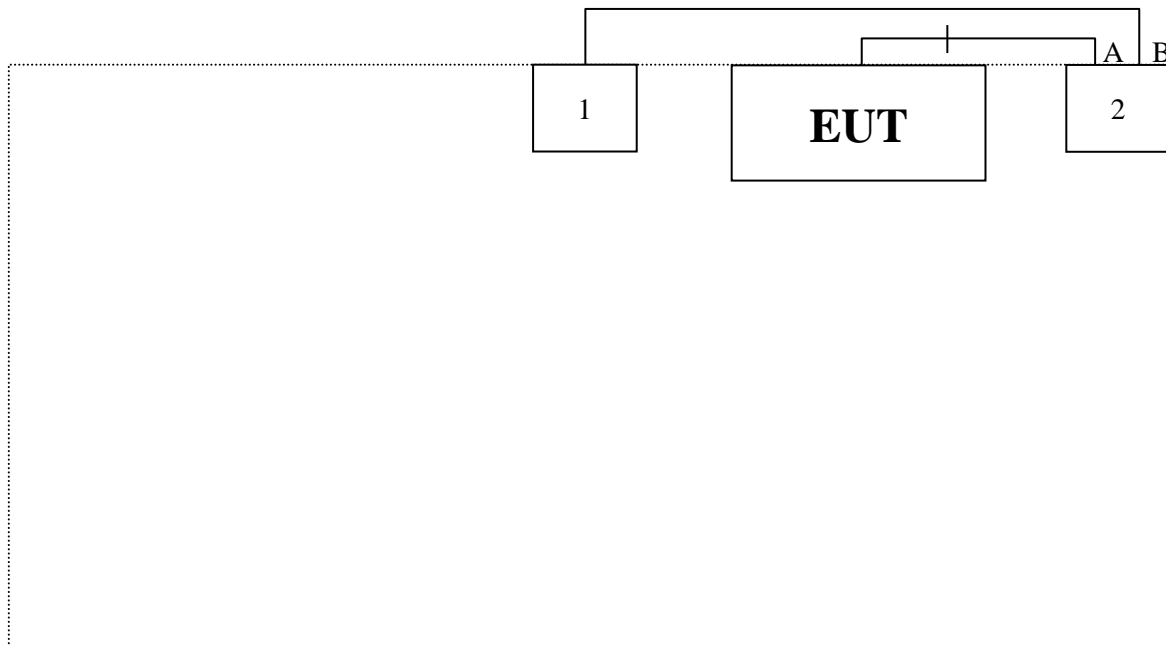

Test Table

1.6 EUT Exercise Software

1. Setup the EUT as shown in Section 1.5
2. Execute software “Putty_Ver.0.63”.
3. Configure the test mode, the test channel, and the data rate.
4. Press “OK” to start the continuous transmit.
5. Verify that the EUT works properly.

1.7 Tested System Details

The types for all equipment, plus descriptions of all cables used in the tested system (including inserted cards) are:

No.	Product	Manufacturer	Model No.	Serial No.	Power Cord
1	Notebook PC	acer	N16Q1	NXVF4TA023742254147600	N/A
2	POE	CERIO	POE-S48V2	N/A	N/A

No.	Signal Cable Type	Signal cable Description
A	LAN Cable	Non-shielded, Non-Core, 1.5m
B	LAN Cable	Non-shielded, Non-Core, 1.6m

1.8 Test Facility

Items	Required (IEC 60068-1)
Temperature (°C)	15-35
Humidity (% RH)	25-75
Barometric pressure (mbar)	860-1060

Description: Accredited by TAF
Accredited Number: 2965

Issued by: Wendell Industrial Co., Ltd

Company Address: 6F/6F-1, No.188, Baoqiao Rd., Xindian Dist.,
New Taipei City 23145, Taiwan R.O.C

Test Lab: Wendell EMC & RF Laboratory

Lab Address: 5F-1, No.188, Baoqiao Rd., Xindian Dist.,
New Taipei City 23145, Taiwan R.O.C

Test Location: No. 119, Wugong 3rd Rd., Wugu Dist.,
New Taipei City 248, Taiwan (R.O.C.)

Designation Number: TW0025

Test Firm Registration Number: 665221

1.9 Measurement Uncertainty

ISO/IEC 17025 requires that an estimate of the measurement uncertainties associated with the emissions test results be included in the report. The measurement uncertainties given below are based on a 95% confidence (level based on a coverage factor K=2)

Measurement Project	Condition	Expanded Uncertainty
AC Conducted Emission	0.150 ~ 30 MHz	± 2.64 dB
Radiated Emission	0.009 ~ 30 MHz	± 3.7 dB
	30 ~ 1000 MHz	± 3.9 dB
	1000 ~ 18000 MHz	± 4.5 dB
	18000 ~ 40000 MHz	± 4.3 dB
RF Power, Conducted	Conducted Measuring	± 0.75 dB
Occupied Bandwidth	Conducted Measuring	± 2.4 %
Power Density	Conducted Measuring	± 1.2 dB
Duty Cycle and Dwell Time	Conducted Measuring	± 0.9 %
Conducted Unwanted Emission Strength	Conducted Measuring	± 1.4 dB
DC Power Supply	--	± 2.0 %
Temperature	--	± 0.55 °C
Humidity	--	± 3.1 %

Note: Please note that the measurement uncertainty are provided for informational purpose only and are not used in determining the Pass/Fail results.

1.10 List of Test Equipment

For Conducted measurements / W08-Conducted Measurement

Equipment	Manufacturer	Model No.	Serial No.	Cal. Date	Due Date
✓ Spectrum analyzer	Keysight	N9010A	SG50420005	2023/08/08	2024/08/07
✓ Wideband Peak Power Meter	Anritsu	ML2495A	1733007	2023/09/07	2024/09/06
✓ Pulse Power Sensor + Precision Adaptor	Anritsu	MA2411B	1726022	2023/09/07	2024/09/06
Temperature Chamber	TAICHY	MHK-225LK	1061121	2023/04/24	2024/04/23
Wireless Connectivity Tester	R&S	CMW270	101307	2023/05/29	2024/05/28
✓ Attenuator	MVE	MVE2211-10	CT-9-056	2022/08/10	2024/08/09
Attenuator	MVE	MVE2211-20	CT-9-057	2022/08/10	2024/08/09
Attenuator	MVE	MVE2211-30	CT-9-058	2022/08/10	2024/08/09
Power Divider	MVE	MVE8546	170826003	2022/08/10	2024/08/09
Power Splitter	MVE	MVE8547	170302047	2022/08/11	2024/08/10
DC Power Supply	GW INSTEK	GPC-3060D	GER817636	2023/08/11	2024/08/10

Remark:

1. The equipments are calibrated every one year.
2. The Attenuator/ Divider/ Splitter are calibrated every two year.
3. The test instruments marked with “✓” are used to measure the final test results.

For AC Conduction measurements / W08-CE

	Equipment	Manufacturer	Model No.	Serial No.	Cal. Date	Due Date
✓	EMI Test Receiver	R&S	ESR3	102309	2023/06/19	2024/06/18
✓	2-Line V-Network LISN	R&S	ENV216	101185	2023/06/16	2024/06/15
✓	LISN	SCHWARZBECK	NSLK 8127RC	05028	2023/06/16	2024/06/15
✓	Transient Limiter	EM Electronics Corporation	EM-7600	857	2023/06/17	2024/06/16
✓	50ohm Cable	EMCI	EMCCFD300-BM-BM-5000	170612	2023/06/17	2024/06/16
✓	50 ohm terminal impedance	HUBER+SUHNER	50 ohm terminal impedance	CT-1-109-1	2023/06/16	2024/06/15

Remark:

1. All equipments are calibrated every one year.
2. The test instruments marked with “✓” are used to measure the final test results.
3. Test Software version: FARAD EZ-EMC Ver.EMC-CON 3A1

For Radiated measurements / W08-996-2

Equipment	Manufacturer	Model No.	Serial No.	Cal. Date	Due Date
✓ EMI Receiver	Keysight	N9038A	MY51210173	2023/08/18	2024/08/17
✓ Spectrum Analyzer	Keysight	N9010A	MY52220228	2023/08/18	2024/08/17
✓ Active Loop Antenna	Schwarzbeck	FMZB 1513-60B	00033	2023/05/08	2024/05/07
✓ TRILOG super broad Antenna	Schwarzbeck	VULB 9168	VULB 9168-700 & 20E03	2023/07/31	2024/07/30
✓ Horn Antenna	Schwarzbeck	BBHA 9120D	01767	2023/08/17	2024/08/16
✓ Horn Antenna	Schwarzbeck	BBHA 9170	703	2023/08/21	2024/08/20
✓ Pre-Amplifier	EM	EMC330	060774	2023/08/22	2024/08/21
✓ Pre-Amplifier	EMEC	EM01G18G	060648	2023/08/22	2024/08/21
✓ Pre-Amplifier	JPT	JPA0118-55-303K	1910001800055003	2023/08/22	2024/08/21
✓ Pre-Amplifier	EMCI	EMC184045SE	980515	2023/08/22	2024/08/21
✓ Cable	EMEC	EM-CB400	105060103	2023/08/22	2024/08/21
✓ Cable	EMEC	EM-CB400	105060102	2023/08/22	2024/08/21
✓ Cable	EMEC	EM-CB400	105060101	2023/08/22	2024/08/21
✓ RF Cable	HUBER+SUHNER	SF102	MY2752/2	2023/08/22	2024/08/21
✓ RF Cable	MVE	280280.LL266.1200	B60028C	2023/08/22	2024/08/21
✓ RF Cable	EMCI	EMC102-KM-KM-600	190646	2023/08/22	2024/08/21
✓ RF Cable	MVE	140140.LL404.700	B90014C	2023/08/22	2024/08/21
✓ RF Cable	MVE	140140.LL404.300	B90006C	2023/08/22	2024/08/21
✓ RF Filter	EMEC	BRF-2400-2500	002	2022/08/17	2024/08/16
RF Filter	EMEC	BRF-5150-5350	104	2022/08/17	2024/08/16
RF Filter	EMEC	BRF-5470-5725	092	2022/08/17	2024/08/16
RF Filter	EMEC	BRF-5725-5875	091	2022/08/17	2024/08/16
✓ RF Filter	EMEC	HPF-2800	002	2022/08/17	2024/08/16
RF Filter	EMEC	HPF-5850	059	2022/08/17	2024/08/16
SMA Notch Filter	MVE	MFN-902.928.S1	190604001	2022/08/17	2024/08/16

Remark:

1. The equipments are calibrated every one year.
2. The Filter calibrated every two year.
3. The test instruments marked with “✓” are used to measure the final test results.
4. Test Software version: FARAD EZ-EMC Ver.WD-03A1-1

2 Test Result

2.1 Antenna Requirement

2.1.1 Applicable Standard

An intentional radiator shall be designed to ensure that no antenna other than that furnished by the responsible party shall be used with the device. The use of a permanently attached antenna or of an antenna that uses a unique coupling to the intentional radiator shall be considered sufficient to comply with the provisions of this section. The manufacturer may design the unit so that a broken antenna can be replaced by the user, but the use of a standard antenna jack or electrical connector is prohibited.

An intentional radiator shall be designed to ensure that no antenna other than as furnished by the responsible party shall be used with the device. If transmitting antennas of directional gain greater than 6dBi are using the power shall be reduced by the amount in dB that the directional gain of the antenna exceeds 6 dBi, for compliance to FCC 47CFR 15.247 (c) requirements.

2.1.2 Antenna Connected Construction

Non-standard antenna connector is used.

2.1.3 Antenna Gain

No.	Manufacturer	Model No.	Antenna Type	Peak Gain
1	INPAQ	RFMTA211200NNLB001	Metal Antenna	3.51 dBi for 2.4GHz

2.2 Peak Output Power Measurement

2.2.1 Limit

For systems using digital modulation in the 2400-2483.5MHz, the limit for peak output power is 1W. If transmitting antenna of directional gain greater than 6dBi is used, the peak output power from the intentional radiator shall be reduced below the above stated value by the amount in dB that the directional gain of the antenna exceeds 6 dBi. In case of point-to-point operation, the limit has to be reduced by 1dB for every 3dB that the directional gain of the antenna exceeds 6dBi.

2.2.2 Test Setup

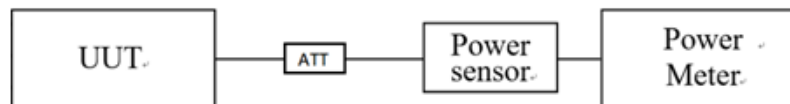

2.2.3 Test Procedure

1. Reference ANSI C63.10 : 2013 chapter 11.9.1.3
2. Enable the EUT transmit continuously.
3. Let EUT be connected to the power meter, and record the max. reading.
4. Measurement using a gated RF average power meter, since this measurement is made only during the ON time of the transmitter, no duty cycle correction is required.

2.2.4 Test Result

Mode	Frequency (MHz)	Peak power (dBm)			Limit (dBm)	Result
		Chain A	Chain B	Total		
802.11b	2412	19.21	--	--	≤ 30	Pass
	2437	19.42	--	--	≤ 30	Pass
	2462	18.44	--	--	≤ 30	Pass
802.11g	2412	22.53	--	--	≤ 30	Pass
	2437	22.81	--	--	≤ 30	Pass
	2462	22.67	--	--	≤ 30	Pass
802.11n HT20	2412	22.23	--	--	≤ 30	Pass
	2437	22.63	--	--	≤ 30	Pass
	2462	22.51	--	--	≤ 30	Pass

Remark:

1. Peak Power = Reading value on power meter + cable loss
2. $10 \text{ Log}(X/\text{mW}) = \text{dBm}$, X=1 watt (Limit)
1 watt = 30 dBm

2.3 6dB Bandwidth Measurement

2.3.1 Limit

The minimum 6 dB bandwidth shall be at least 500 kHz.

2.3.2 Test Setup



2.3.3 Test Procedure

1. Reference ANSI C63.10 : 2013 chapter 11.8.2
2. Enable the EUT transmit continuously.
3. Spectrum analyzer set:
 - a) RBW = 100 kHz
 - b) VBW \geq 3 RBW
 - c) Detector = peak
 - d) Sweep time = auto couple
 - e) Trace mode = max hold.

2.3.4 Test Result

802.11b

Frequency (MHz)	6dB BW (kHz)		Limit (kHz)	Result
	Chain A	Chain B		
2412	8549	--	≥ 500	Pass
2437	8599	--	≥ 500	Pass
2462	8565	--	≥ 500	Pass

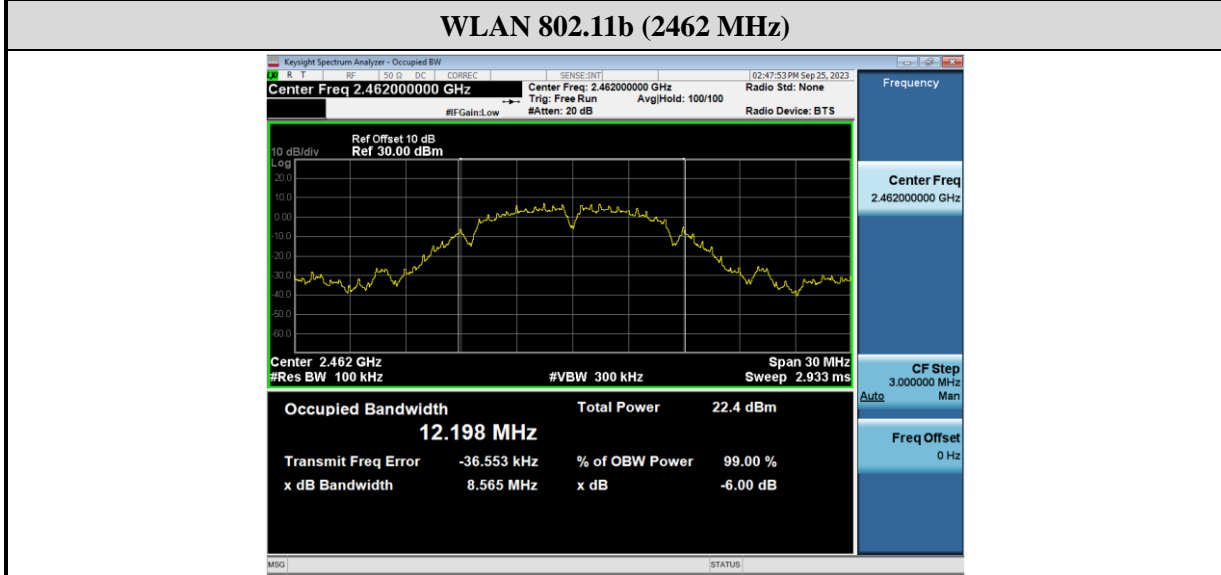
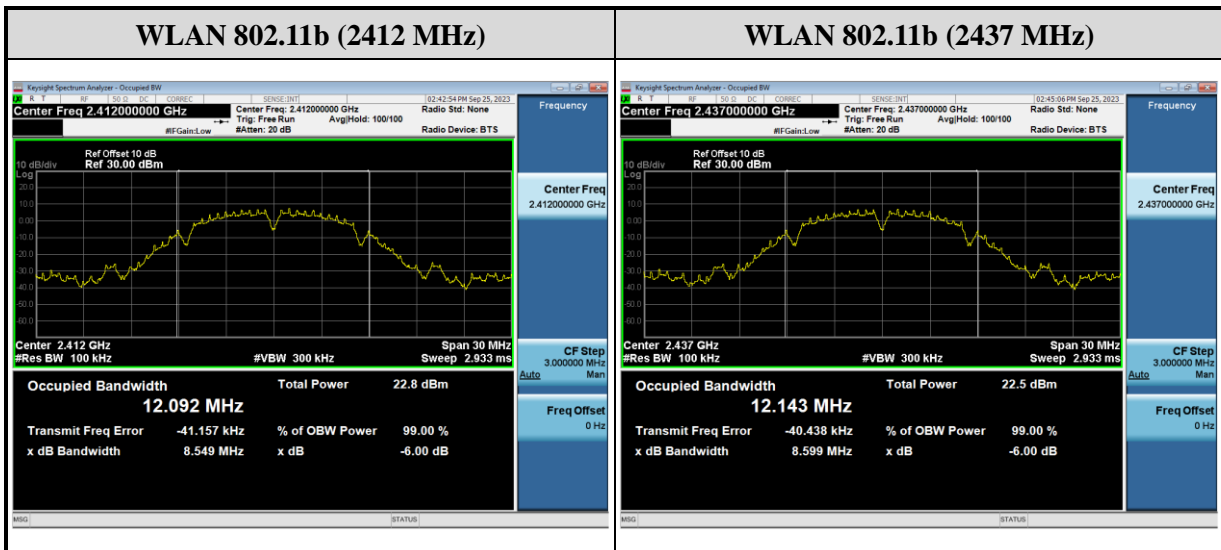

802.11g

Frequency (MHz)	6dB BW (kHz)		Limit (kHz)	Result
	Chain A	Chain B		
2412	13880	--	≥ 500	Pass
2437	14620	--	≥ 500	Pass
2462	13790	--	≥ 500	Pass

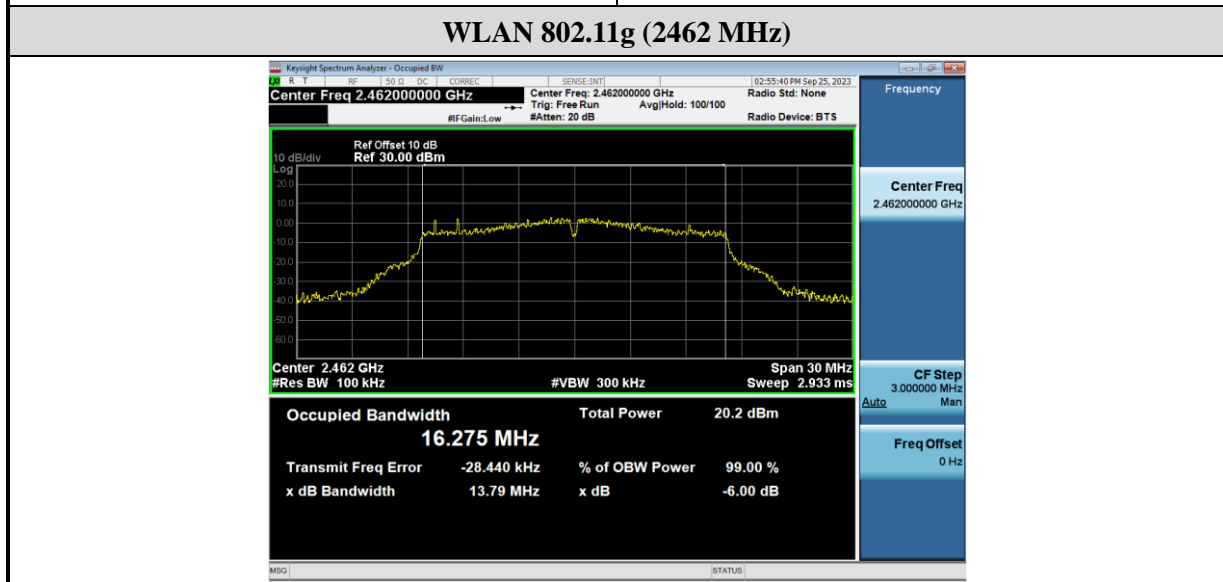
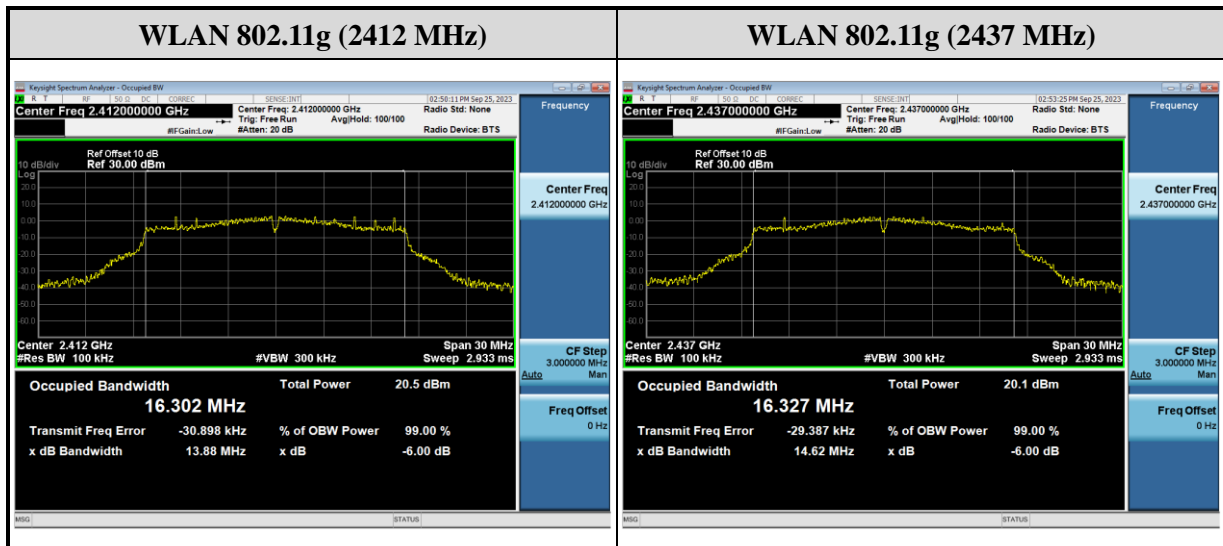

802.11n HT20

Frequency (MHz)	6dB BW (kHz)		Limit (kHz)	Result
	Chain A	Chain B		
2412	15170	--	≥ 500	Pass
2437	15060	--	≥ 500	Pass
2462	15140	--	≥ 500	Pass

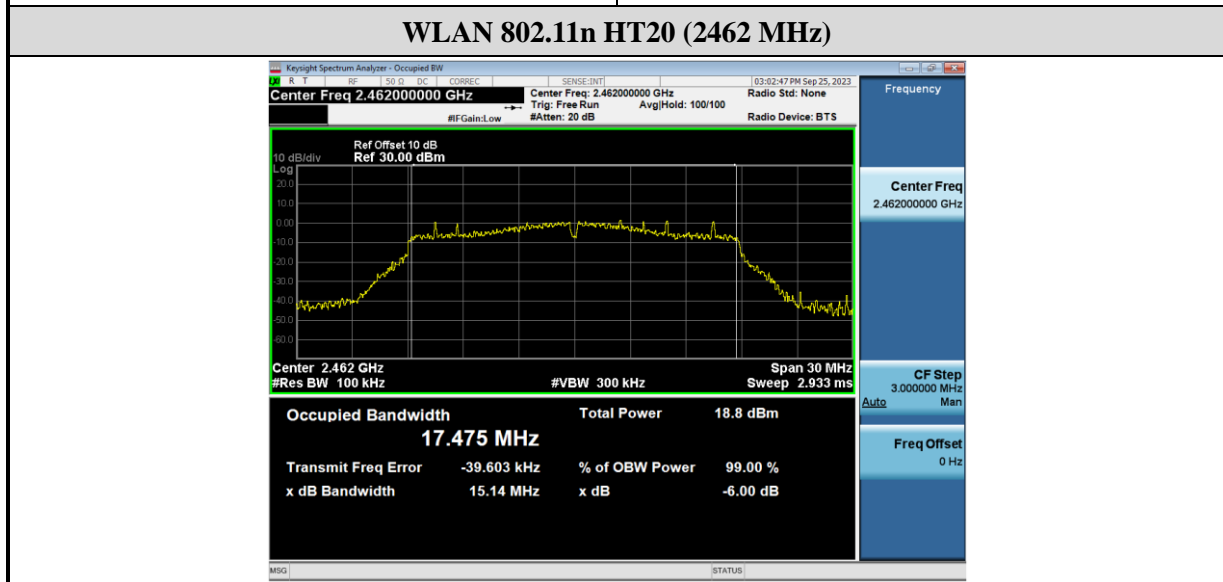
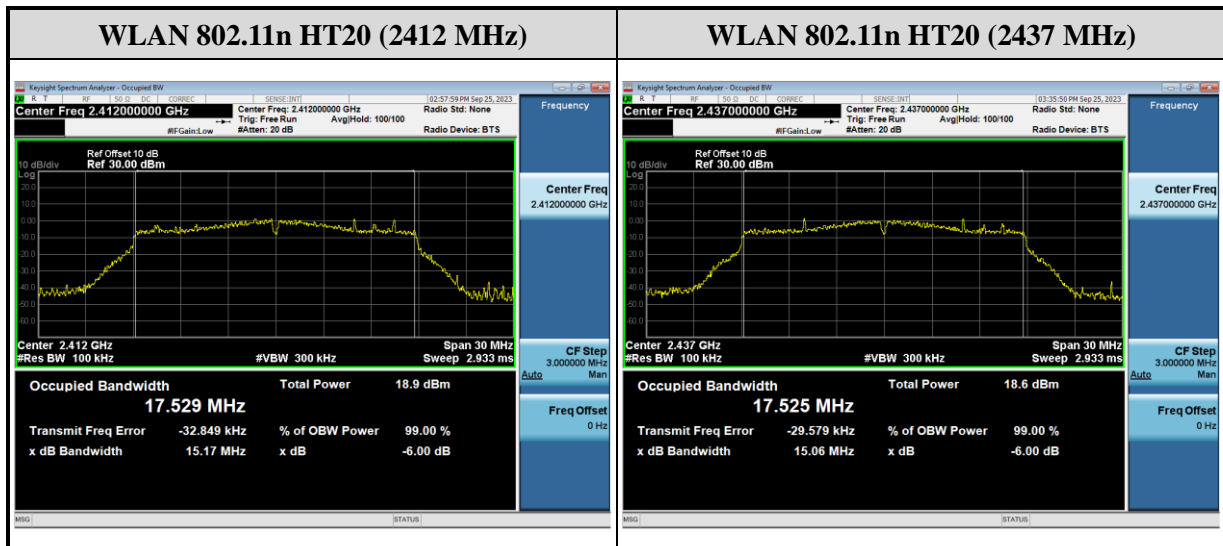

2.4 Power Spectral Density Measurement

2.4.1 Limit

The peak power spectral density shall not be greater than 8dBm in any 3kHz band at any time interval of continuous transmission.

2.4.2 Test Setup



2.4.3 Test Procedure

1. Reference ANSI C63.10 : 2013 chapter 11.10.2
2. Enable the EUT transmit continuously.
3. Spectrum analyzer set:
 - a) RBW = 3 kHz ~ 100 kHz
 - b) VBW \geq 3 RBW
 - c) Span = 1.5 times DTS Channel 6dB Bandwidth
 - d) Detector = peak
 - e) Sweep time = auto couple
 - f) Trace mode = max hold.

2.4.4 Test Result

802.11b

Frequency (MHz)	Power Spectral Density (dBm)			Limit (dBm)	Result
	Chain A	Chain B	Total		
2412	-5.680	--	--	≤ 8	Pass
2437	-4.657	--	--	≤ 8	Pass
2462	-6.142	--	--	≤ 8	Pass

Remark: PSD = Reading value on spectrum analyzer + cable loss

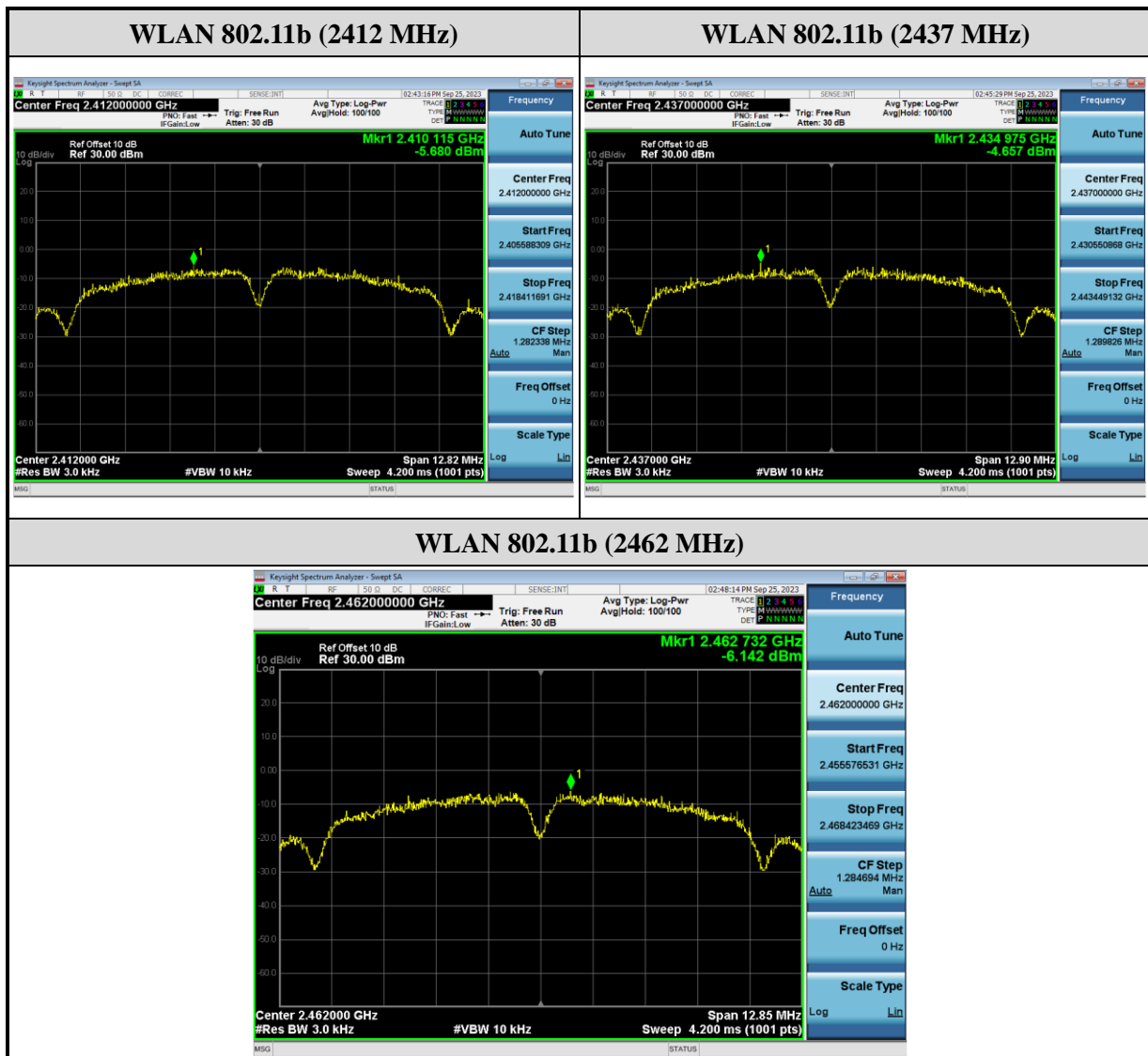

802.11g

Frequency (MHz)	Power Spectral Density (dBm)			Limit (dBm)	Result
	Chain A	Chain B	Total		
2412	-7.778	--	--	≤ 8	Pass
2437	-7.871	--	--	≤ 8	Pass
2462	-7.868	--	--	≤ 8	Pass

Remark: PSD = Reading value on spectrum analyzer + cable loss

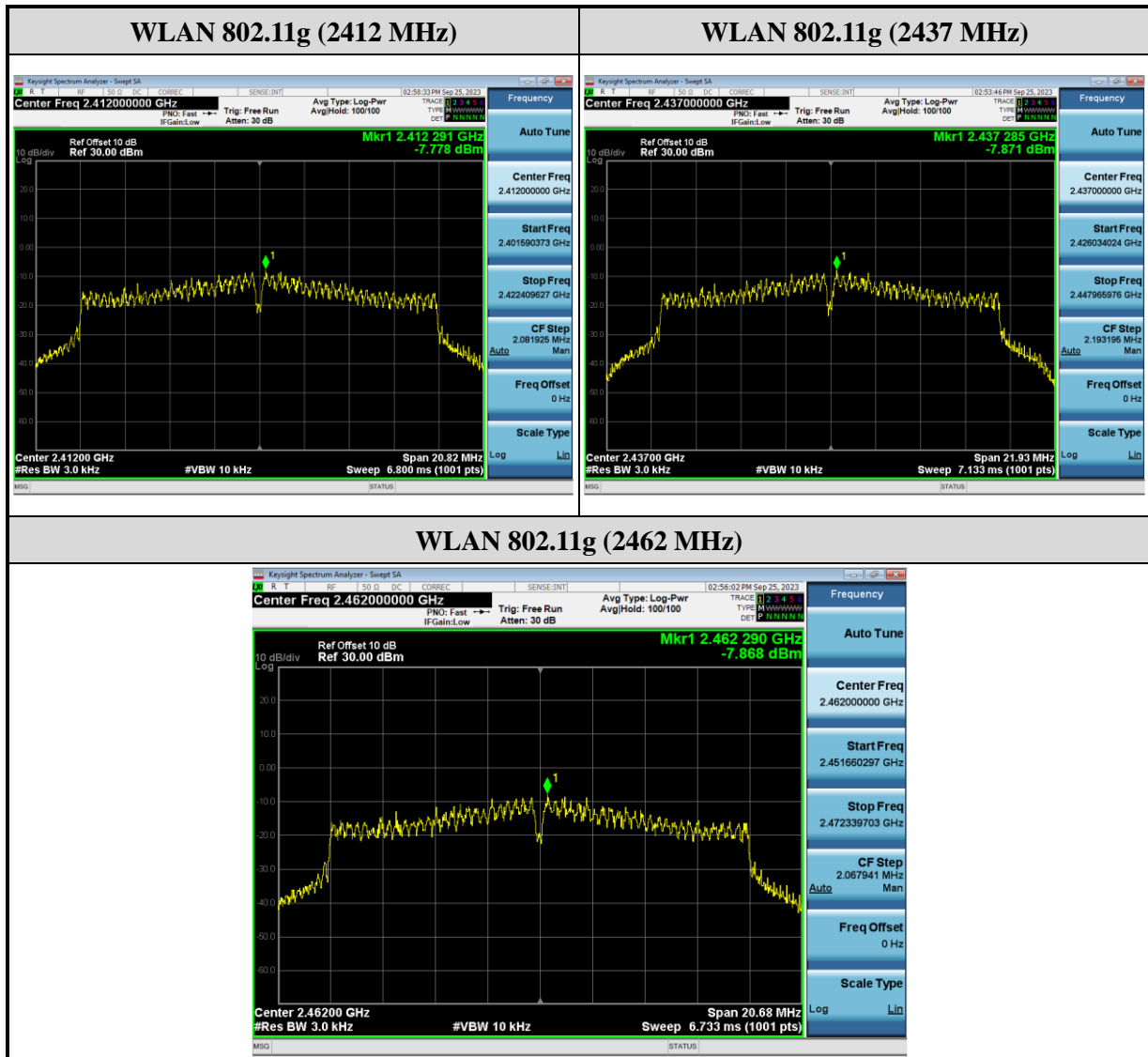

802.11n HT20

Frequency (MHz)	Power Spectral Density (dBm)			Limit (dBm)	Result
	Chain A	Chain B	Total		
2412	-9.530	--	--	≤ 8	Pass
2437	-10.017	--	--	≤ 8	Pass
2462	-8.734	--	--	≤ 8	Pass

Remark: PSD = Reading value on spectrum analyzer + cable loss

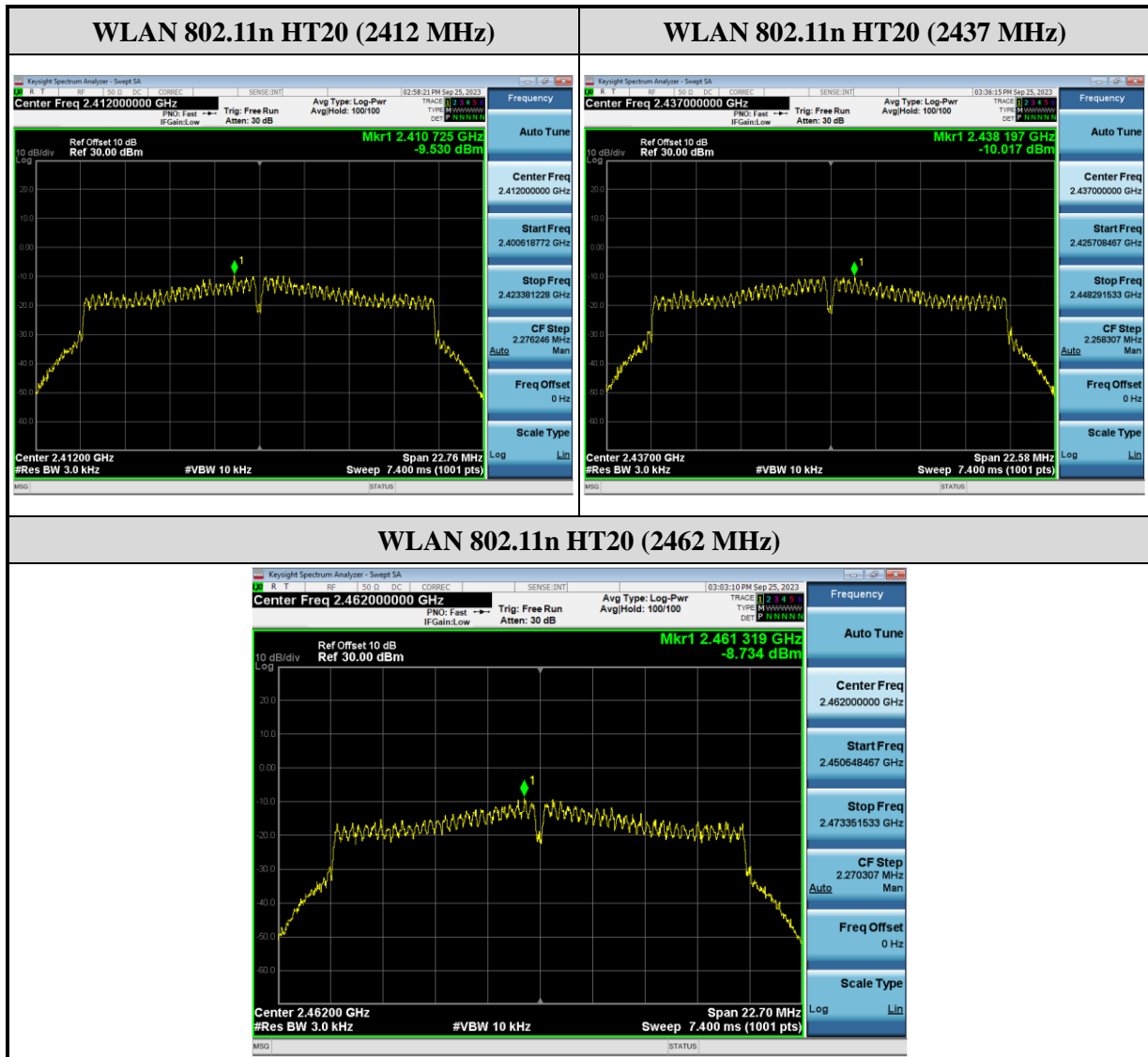

2.5 Conducted Band Edges and Spurious Emission Measurement

2.5.1 Limit

In any 100 KHz bandwidth outside the frequency bands in which the spread spectrum intentional radiator is operating, the radio frequency power that is produced by the intentional radiator shall be at least 20dB below that in the 100KHz bandwidth within the band that contains the highest level of the desired power, In addition, radiated emissions which fall in the restricted bands, as defined in must also comply with the radiated emission limits. If the transmitter complies with the conducted power limits based on the use of RMS averaging over a time interval, the attenuation required under this paragraph shall be 30 dB instead of 20 dB

2.5.2 Test Setup



2.5.3 Test Procedure

1. Reference ANSI C63.10 : 2013 chapter 6.10
2. Enable the EUT transmit continuously.
3. Spectrum analyzer set :
 - a) RBW = 100 kHz
 - b) VBW \geq 3 RBW
 - c) Detector = peak
 - d) Sweep time = auto couple
 - e) Trace mode = max hold.

2.5.4 Test Result



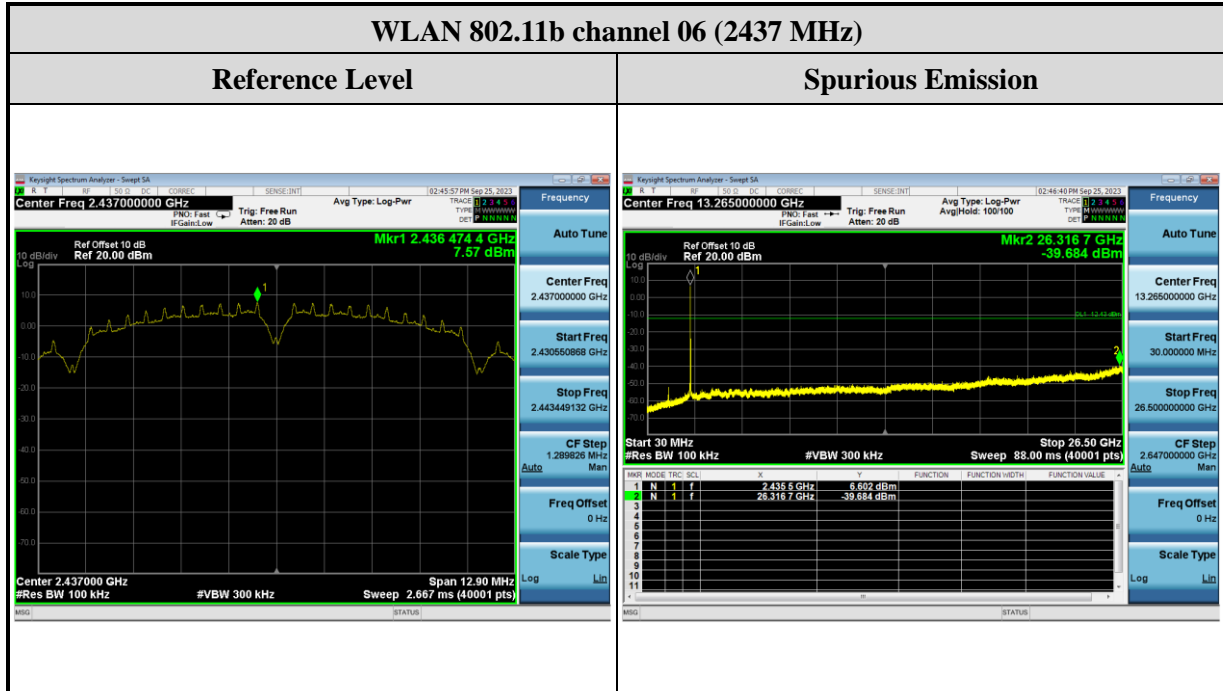

WLAN 802.11b channel 11 (2462MHz)

Reference Level

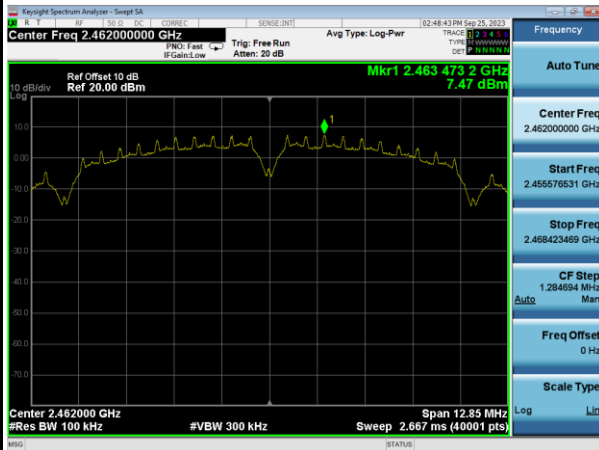

Spurious Emission

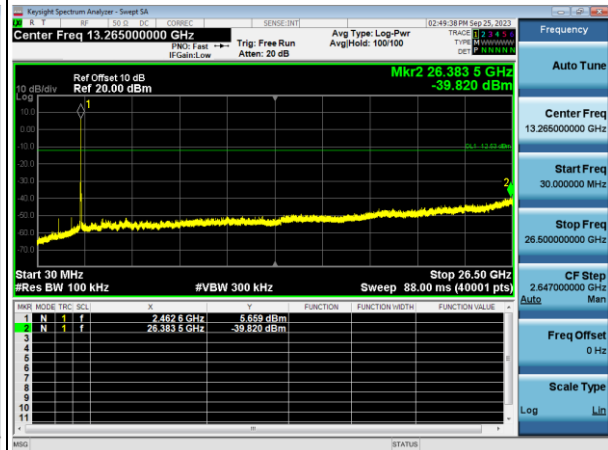

Band Edge

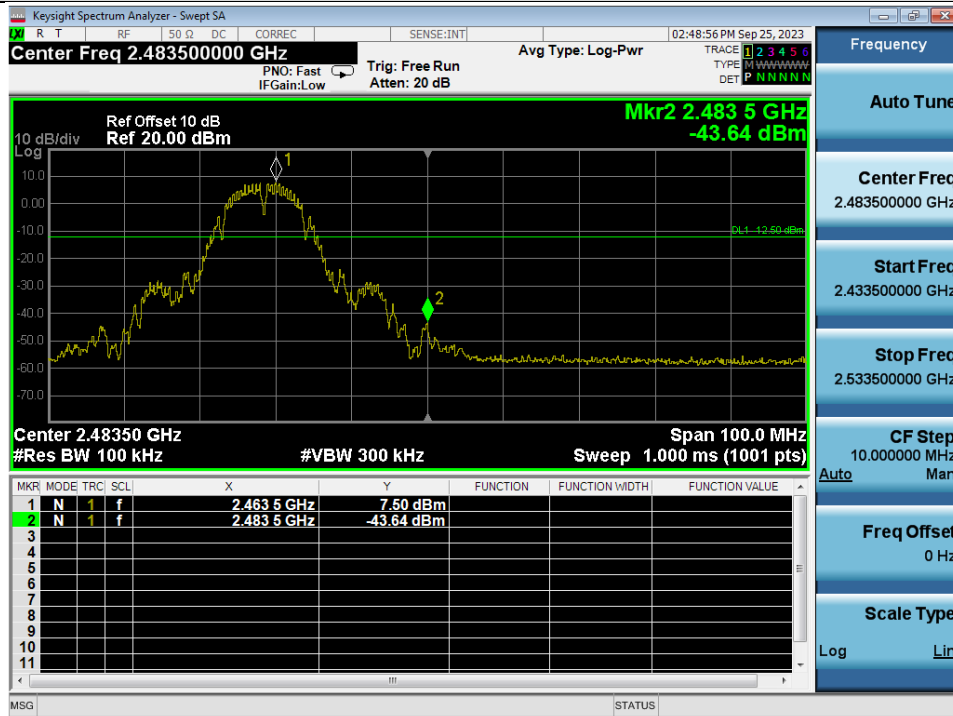

WLAN 802.11g channel 01 (2412 MHz)

Reference Level	Spurious Emission
<p>Center Freq 2.41200000 GHz Mkr1 2.411 348 9 GHz 2.94 dBm</p>	<p>Center Freq 13.26500000 GHz Mkr2 26.056 8 GHz -39.658 dBm</p>

Band Edge

Center Freq 2.40000000 GHz
Mkr2 2.400 0 GHz
-33.54 dBm

MKR	MODE	TRC	SCL	X	Y	FUNCTION	FUNCTION WIDTH	FUNCTION VALUE
1	N	1	f	2.411 0 GHz	3.02 dBm			
2	N	1	f	2.400 0 GHz	-33.54 dBm			

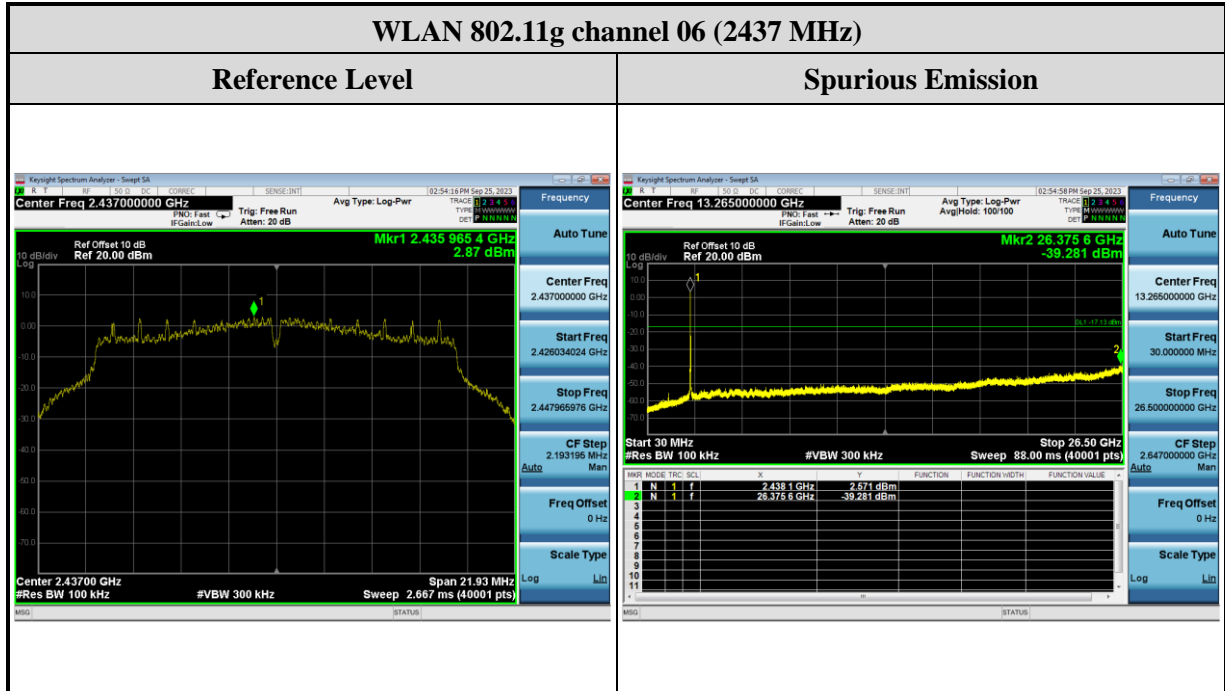

WLAN 802.11g channel 11 (2462MHz)

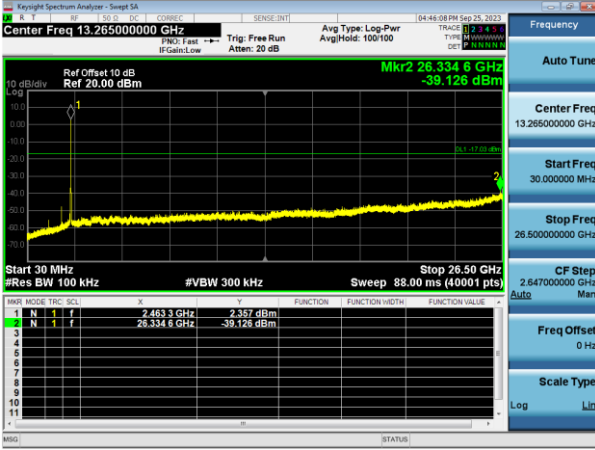
Reference Level	Spurious Emission
 <p>Center Freq 2.46200000 GHz Mkr1 2.462 598 7 GHz 2.97 dBm</p>	 <p>Center Freq 13.26500000 GHz Mkr2 26.334 8 GHz -39.126 dBm</p>

Band Edge

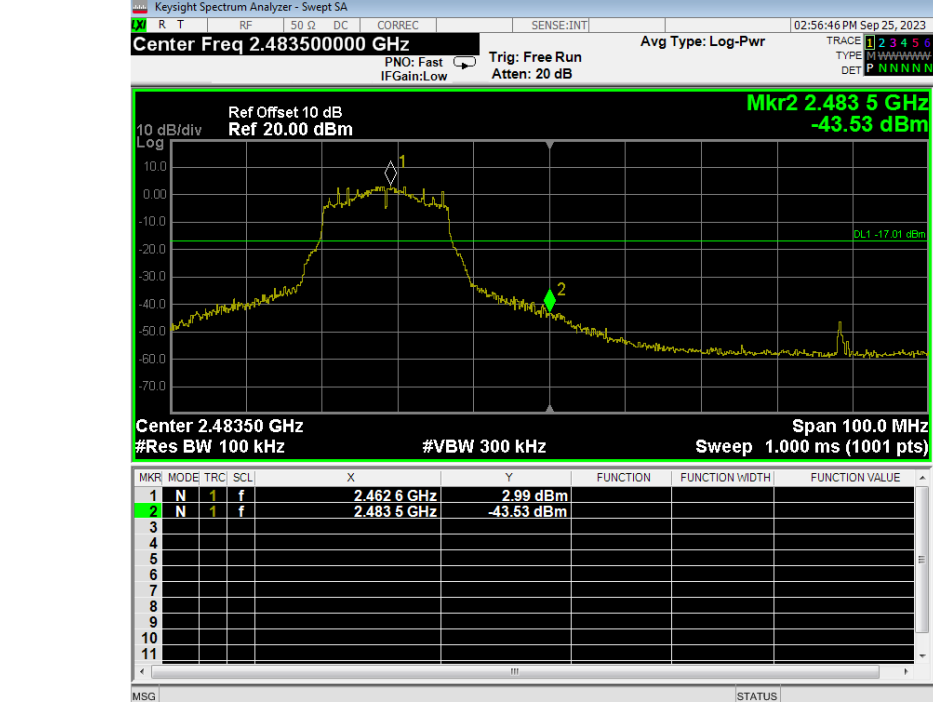

Center Freq 2.48350000 GHz
Mkr2 2.483 5 GHz
-43.53 dBm

MKR	MODE	TRC	SCL	X	Y	FUNCTION	FUNCTION WIDTH	FUNCTION VALUE
1	N	1	f	2.462 6 GHz	2.99 dBm			
2	N	1	f	2.483 5 GHz	-43.53 dBm			
3								
4								
5								
6								
7								
8								
9								
10								
11								

WLAN 802.11n HT20 channel 01 (2412 MHz)

Reference Level	Spurious Emission
<p>Center Freq 2.41200000 GHz</p> <p>Mkr1 2.414 463 5 GHz 1.59 dBm</p>	<p>Center Freq 13.26500000 GHz</p> <p>Mkr2 26.054 8 GHz -39.822 dBm</p>

Band Edge

Center Freq 2.40000000 GHz

Mkr2 2.400 0 GHz
-37.96 dBm

Mkr1 2.414 5 GHz
1.70 dBm

MKR	MODE	TRC	SCL	X	Y	FUNCTION	FUNCTION WIDTH	FUNCTION VALUE
1	N	1	f	2.414 5 GHz	1.70 dBm			
2	N	1	f	2.400 0 GHz	-37.96 dBm			
3								
4								
5								
6								
7								
8								
9								
10								
11								

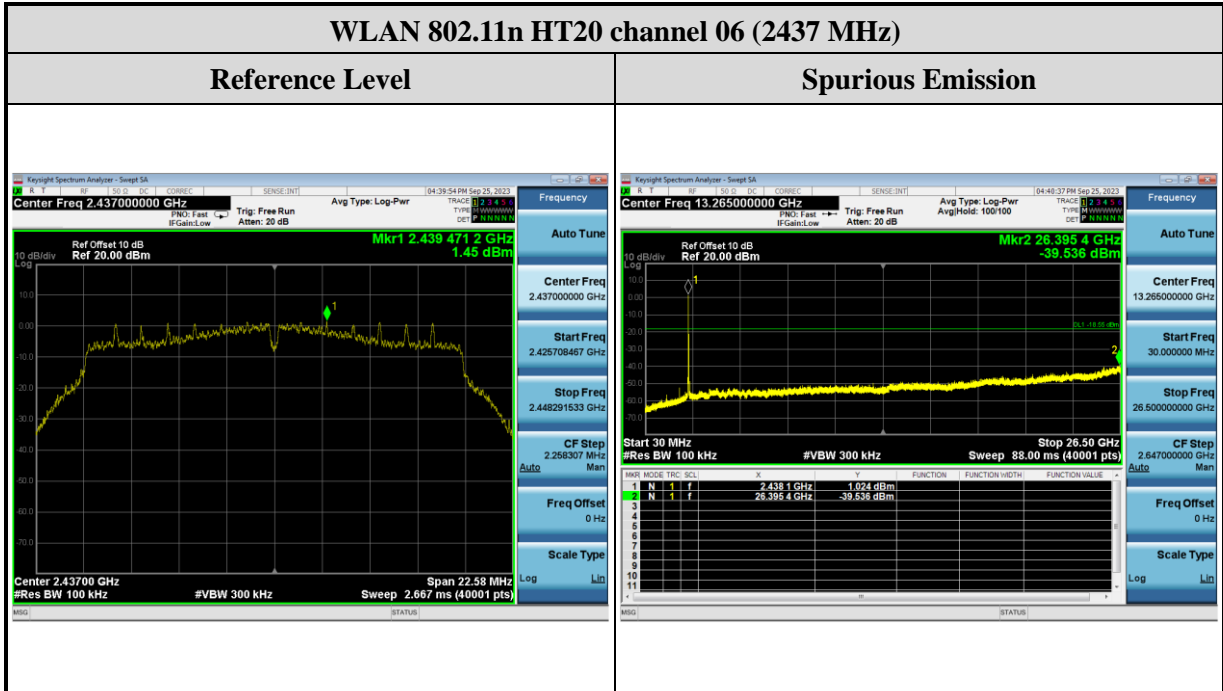

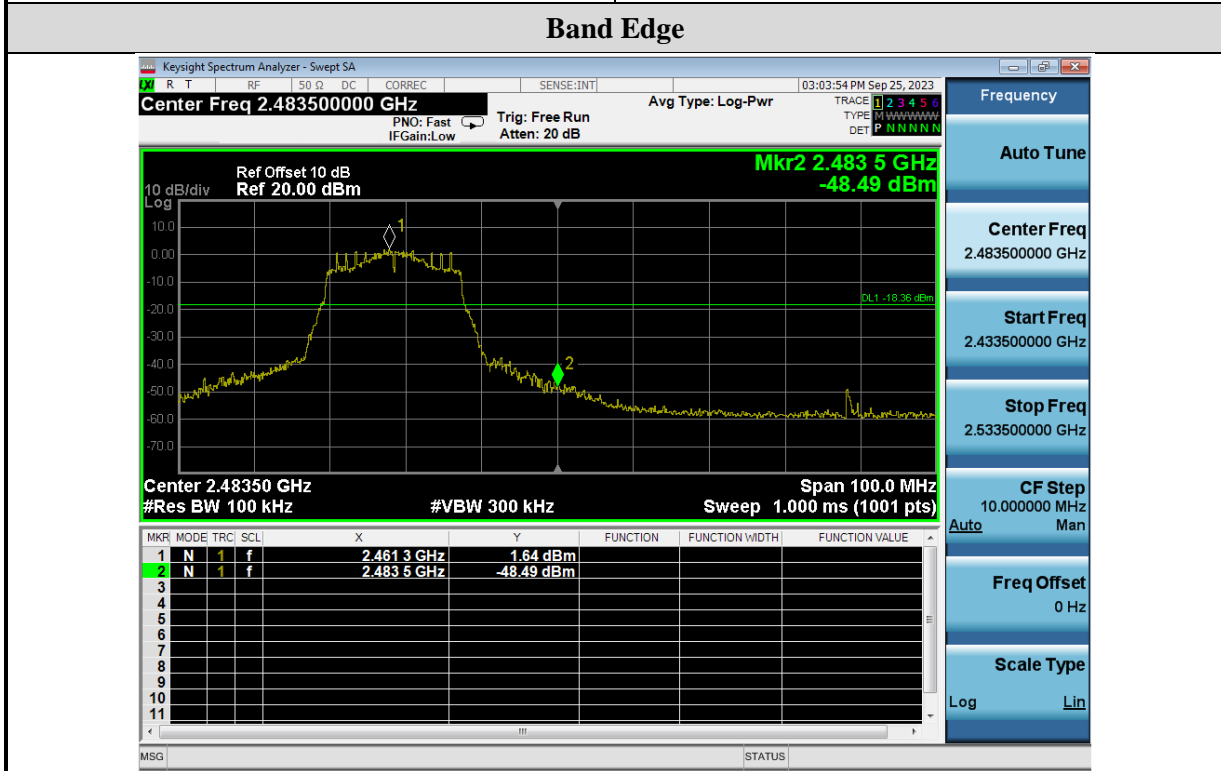
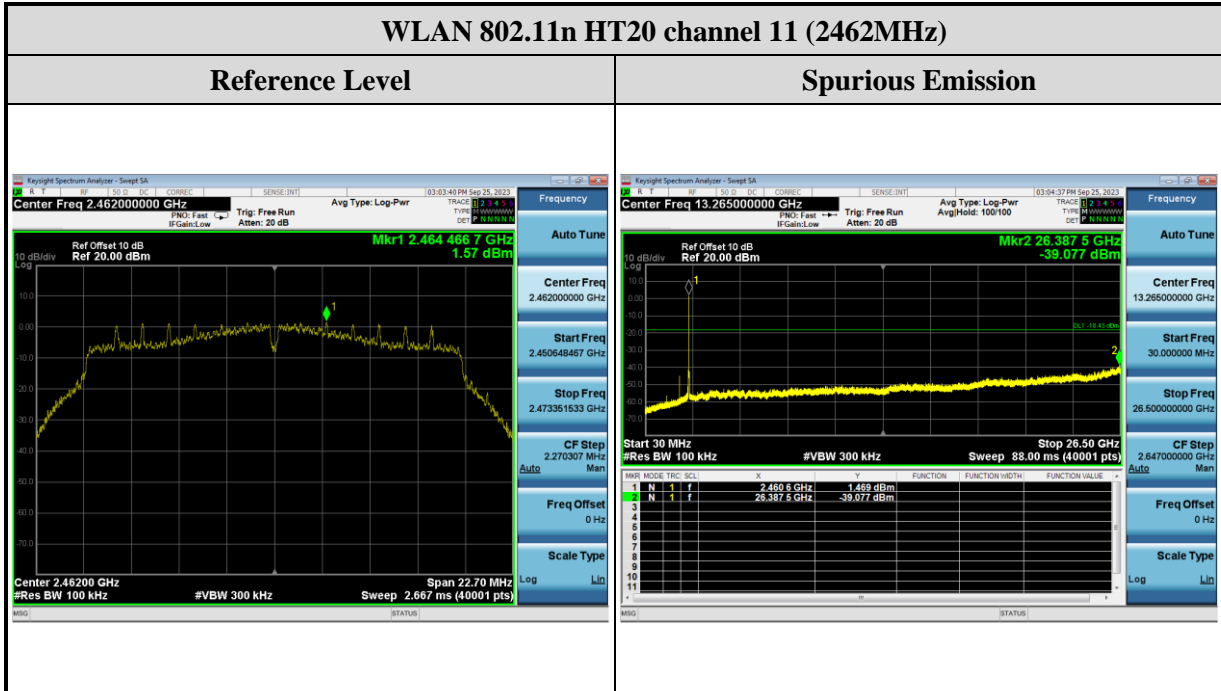

2.6 Radiated Band Edges and Spurious Emission Measurement

2.6.1 Limit

Frequency (MHz)	Field Strength ($\mu\text{V}/\text{m}$)	Measurement Distance (m)
0.009 – 0.490	$2400/F(\text{kHz})$	300
0.490 – 1.705	$24000/F(\text{kHz})$	30
1.705 – 30.0	30	30
30 – 88	100	3
88 – 216	150	3
216 - 960	200	3
Above 960	500	3

Remarks:

1. RF Voltage (dBuV) = $20 \log \text{RF Voltage}(\mu\text{V})$
2. In the Above Table, the tighter limit applies at the band edges.
3. Distance refers to the distance in meters between the measuring instrument antenna and the closed point of any part of the device or system

2.6.2 Test Setup

Below 30MHz

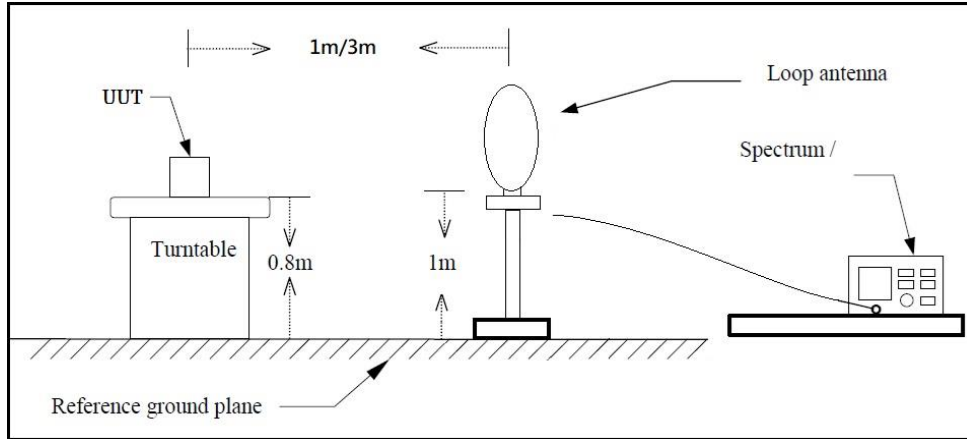

30MHz~1GHz

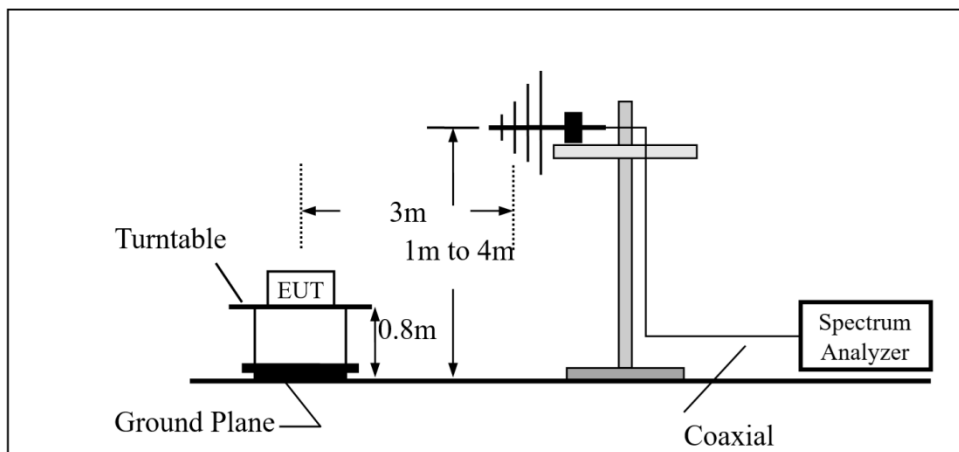

Above 1GHz

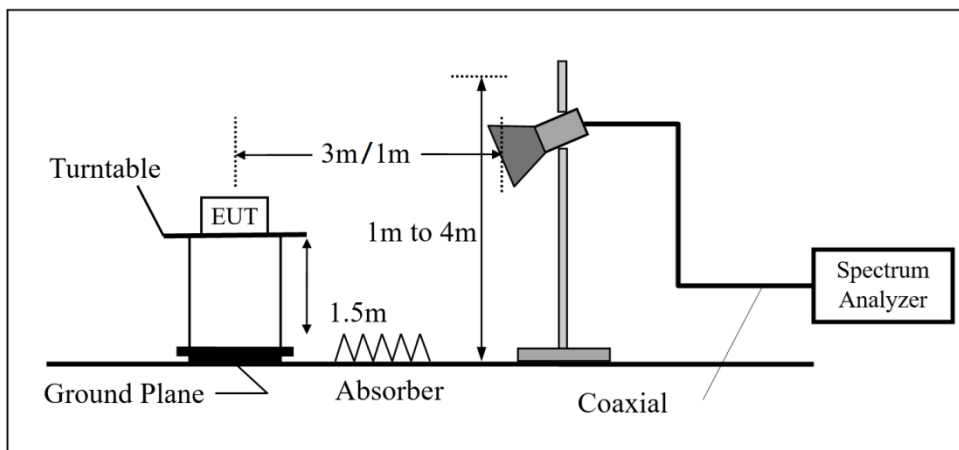

2.6.3 Test Procedure

The EUT was setup according to ANSI C63.10 : 2013 chapter 6.4, 6.5, 6.6 and tested according test procedure of KDB 558074 for compliance to FCC 47CFR 15.247 requirements.

- (1) The EUT was placed on the top of a rotating table 0.8 meters (for below 1GHz) / 1.5 meters (for above 1GHz) above the ground at 3 meters chamber room for the test. The table was rotated 360 degrees to determine the position of the highest radiation.
- (2) The EUT was set 3 meters away from the interference-receiving antenna, the height of the antenna is varied from 1 meter to 4 meters above the ground to determine the maximum value of the field strength.
- (3) Parallel, perpendicular, and ground-parallel orientations of the antenna are set to make the measurement.
- (4) For each suspected emission, the EUT was arranged to its worst case and the rotatable table was turned from 0 degrees to 360 degrees to find the maximum reading.
- (5) The test-receiver system was set to quasi-peak detect function and specified bandwidth with maximum hold mode when the test frequency is below 1 GHz.
- (6) The test-receiver system was set to peak and average detect function and specified bandwidth with maximum hold mode when the test frequency is above 1 GHz. If the peak reading value also meets the average limit, measurement with the average detector is unnecessary.

Remarks:

- (a) The resolution bandwidth and video bandwidth of test receiver/spectrum analyzer is 120kHz for Quasi-peak detection at frequency below 1GHz.
- (b) The resolution bandwidth of test receiver/spectrum analyzer is 1MHz and video bandwidth is 3MHz for Peak detection at frequency above 1GHz.
- (c) The resolution bandwidth of test receiver/spectrum analyzer is 1MHz and the video bandwidth is $\geq 1/T$ (Duty cycle < 98%) or 10Hz (Duty cycle > 98%) for Average detection (AV) at frequency above 1GHz.
- (d) All modes of operation were investigated and the worst-case emissions are reported.

For Radiated emission below 30MHz

- (1) The EUT was placed on the top of a rotating table 0.8 meters above the ground in a 3 meter chamber room. The table was rotated 360 degrees to determine the position of the highest radiation.
- (2) The EUT was set 3 meters away from the interference-receiving antenna, which was mounted on the top of a variable-height antenna tower.
- (3) Parallel, perpendicular, and ground-parallel orientations of the antenna are set to make the measurement.
- (4) For each suspected emission, the EUT was arranged to its worst case and the rotatable table was turned from 0 degrees to 360 degrees to find the maximum reading.
- (5) The test-receiver system was set to Quasi-Peak Detect Function and Specified Bandwidth with Maximum Hold Mode.

For Radiated emission Above 30MHz

- (7) The EUT was placed on the top of a rotating table 0.8 meters (for below 1GHz) / 1.5 meters (for above 1GHz) above the ground at 3 meter chamber room for the test. The table was rotated 360 degrees to determine the position of the highest radiation.
- (8) The EUT was set 3 meters away from the interference-receiving antenna, the height of the antenna is varied from 1 meter to 4 meters above the ground to determine the maximum value of the field strength.
- (9) Parallel, perpendicular, and ground-parallel orientations of the antenna are set to make the measurement.
- (10) For each suspected emission, the EUT was arranged to its worst case and the rotatable table was turned from 0 degrees to 360 degrees to find the maximum reading.
- (11) The test-receiver system was set to quasi-peak detect function and specified bandwidth with maximum hold mode when the test frequency is below 1 GHz.
- (12) The test-receiver system was set to peak and average detect function and specified bandwidth with maximum hold mode when the test frequency is above 1 GHz. If the peak reading value also meets the average limit, measurement with the average detector is unnecessary.

2.6.4 Duty Cycle

Mode	Frequency (MHz)	on time (ms)	on+off time (ms)	Duty cycle	Duty Factor (dB)	1/T Minimum VBW (kHz)
802.11b	2412	12.510	12.750	0.981	0.083	0.010
802.11g	2412	2.100	2.383	0.881	0.549	0.476
802.11n HT20	2412	1.933	2.217	0.872	0.595	0.517

2.6.5 Test Result of Radiated Band Edge Measurement

The following tables for radiated measurement, pre-scanned in three orthogonal panels, X, Y, Z. The worst cases (X axis) were recorded in this report.

Test Frequency	
RF	802.11b / 802.11g / 802.11n HT20
Tx	CH01 (2412MHz) CH11 (2462MHz)

Test Mode :	Transmit(802.11b)	Test Date :	2023/09/22
Test Channel :	CH01(2412MHz)	Temperature :	23.2 °C
Polarization :	Horizontal	Relative Humidity :	42.5 %

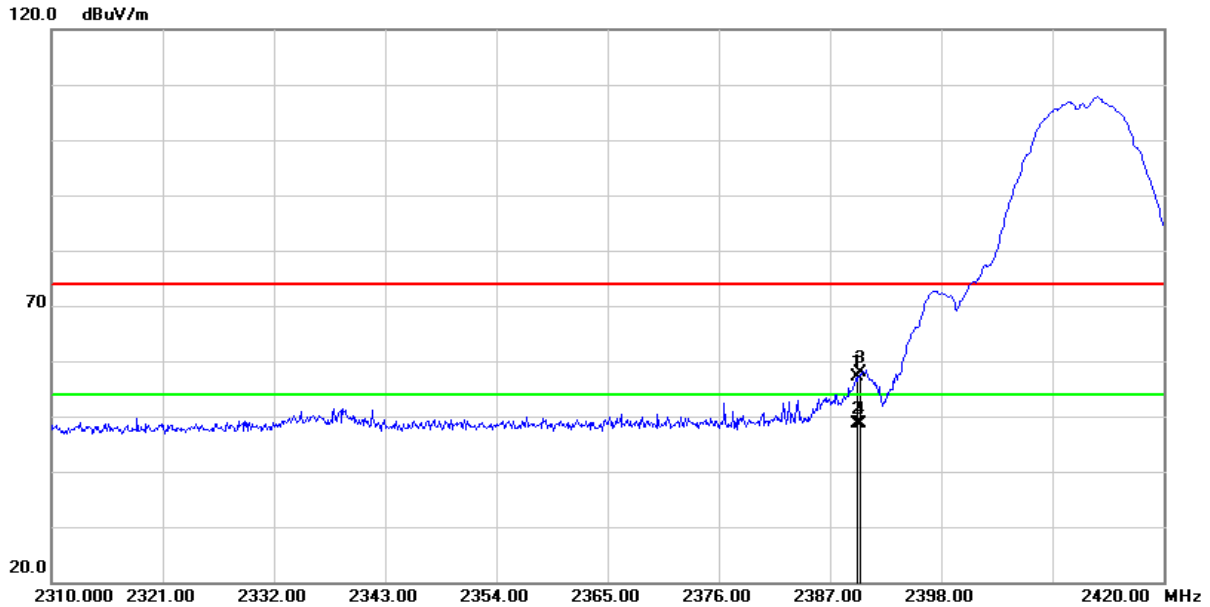

No.	Frequency (MHz)	Reading (dBuV/m)	Correct Factor (dB/m)	Result (dBuV/m)	Limit (dBuV/m)	Margin (dB)	Remark
1	2389.750	62.75	-5.69	57.06	74.00	-16.94	peak
2	2389.750	54.27	-5.69	48.58	54.00	-5.42	AVG
3	2390.000	63.54	-5.69	57.85	74.00	-16.15	peak
4	2390.000	54.33	-5.69	48.64	54.00	-5.36	AVG

Remark :

1. Correction Factor = Antenna factor + Cable loss – Amplifier gain
2. Result Value = Reading Level + Correct Factor
3. Margin Level = Result Value – Limit Value
4. The other emission levels were very low against the limit

Test Mode :	Transmit(802.11b)	Test Date :	2023/09/22
Test Channel :	CH01(2412MHz)	Temperature :	23.2 °C
Polarization :	Vertical	Relative Humidity :	42.5 %

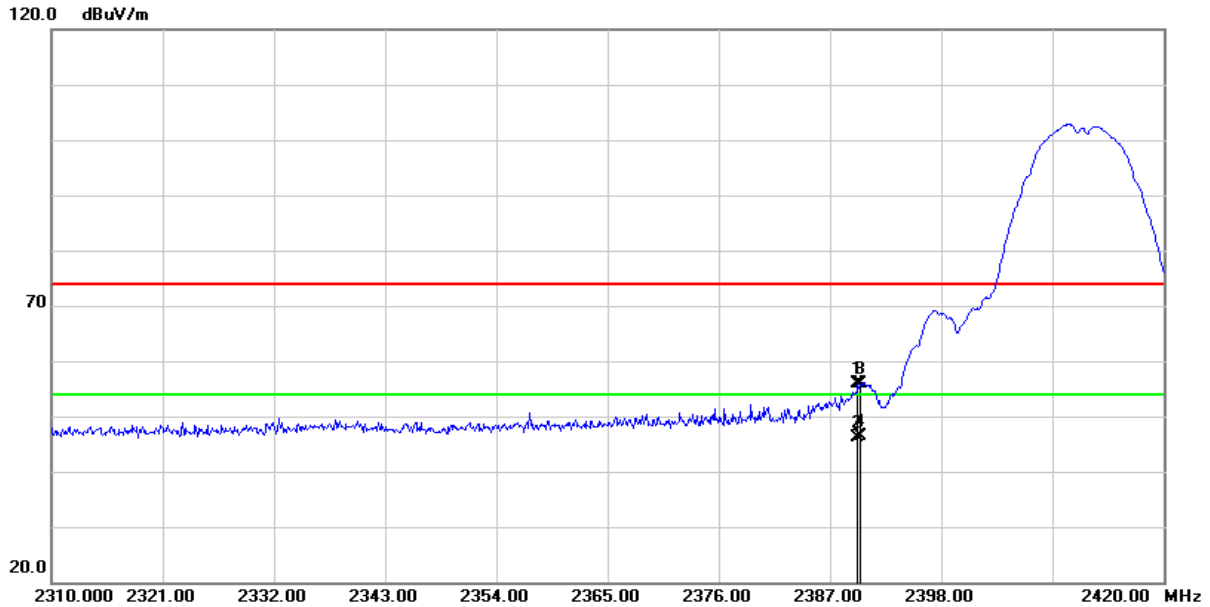

No.	Frequency (MHz)	Reading (dBuV/m)	Correct Factor (dB/m)	Result (dBuV/m)	Limit (dBuV/m)	Margin (dB)	Remark
1	2389.750	61.45	-5.69	55.76	74.00	-18.24	peak
2	2389.750	51.87	-5.69	46.18	54.00	-7.82	AVG
3	2390.000	61.62	-5.69	55.93	74.00	-18.07	peak
4	2390.000	52.19	-5.69	46.50	54.00	-7.50	AVG

Remark :

1. Correction Factor = Antenna factor + Cable loss – Amplifier gain
2. Result Value = Reading Level + Correct Factor
3. Margin Level = Result Value – Limit Value
4. The other emission levels were very low against the limit

Test Mode :	Transmit(802.11b)	Test Date :	2023/09/22
Test Channel :	CH11(2462MHz)	Temperature :	23.2 °C
Polarization :	Horizontal	Relative Humidity :	42.5 %

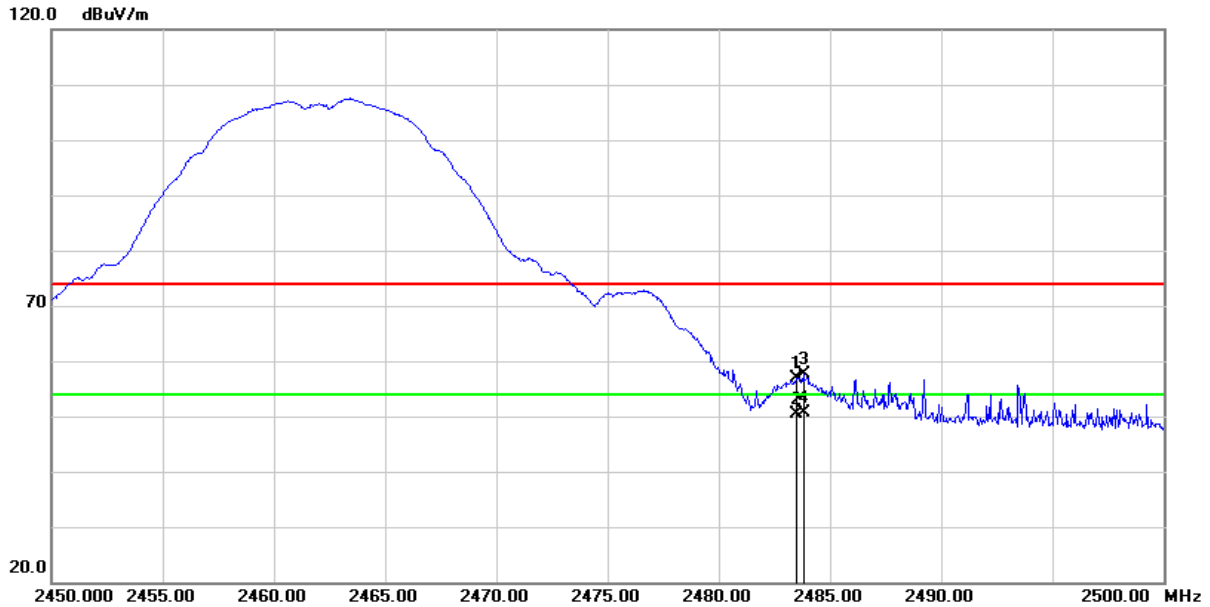

No.	Frequency (MHz)	Reading (dBuV/m)	Correct Factor (dB/m)	Result (dBuV/m)	Limit (dBuV/m)	Margin (dB)	Remark
1	2483.500	62.70	-5.81	56.89	74.00	-17.11	peak
2	2483.500	56.10	-5.81	50.29	54.00	-3.71	AVG
3	2483.800	63.43	-5.81	57.62	74.00	-16.38	peak
4	2483.800	56.42	-5.81	50.61	54.00	-3.39	AVG

Remark :

1. Correction Factor = Antenna factor + Cable loss – Amplifier gain
2. Result Value = Reading Level + Correct Factor
3. Margin Level = Result Value – Limit Value
4. The other emission levels were very low against the limit

Test Mode :	Transmit(802.11b)	Test Date :	2023/09/22
Test Channel :	CH11(2462MHz)	Temperature :	23.2 °C
Polarization :	Vertical	Relative Humidity :	42.5 %

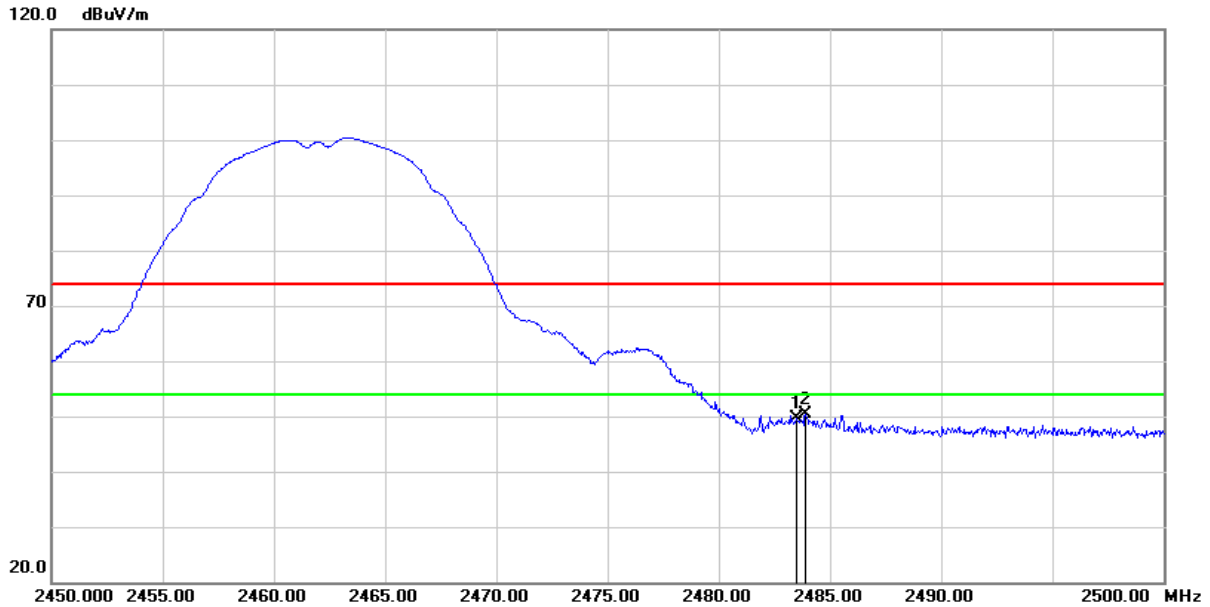

No.	Frequency (MHz)	Reading (dBuV/m)	Correct Factor (dB/m)	Result (dBuV/m)	Limit (dBuV/m)	Margin (dB)	Remark
1	2483.500	55.34	-5.81	49.53	74.00	-24.47	peak
2	2483.900	56.20	-5.81	50.39	74.00	-23.61	peak

Remark :

1. Correction Factor = Antenna factor + Cable loss – Amplifier gain
2. Result Value = Reading Level + Correct Factor
3. Margin Level = Result Value – Limit Value
4. The other emission levels were very low against the limit

Test Mode :	Transmit(802.11g)	Test Date :	2023/09/22
Test Channel :	CH01(2412MHz)	Temperature :	23.2 °C
Polarization :	Horizontal	Relative Humidity :	42.5 %

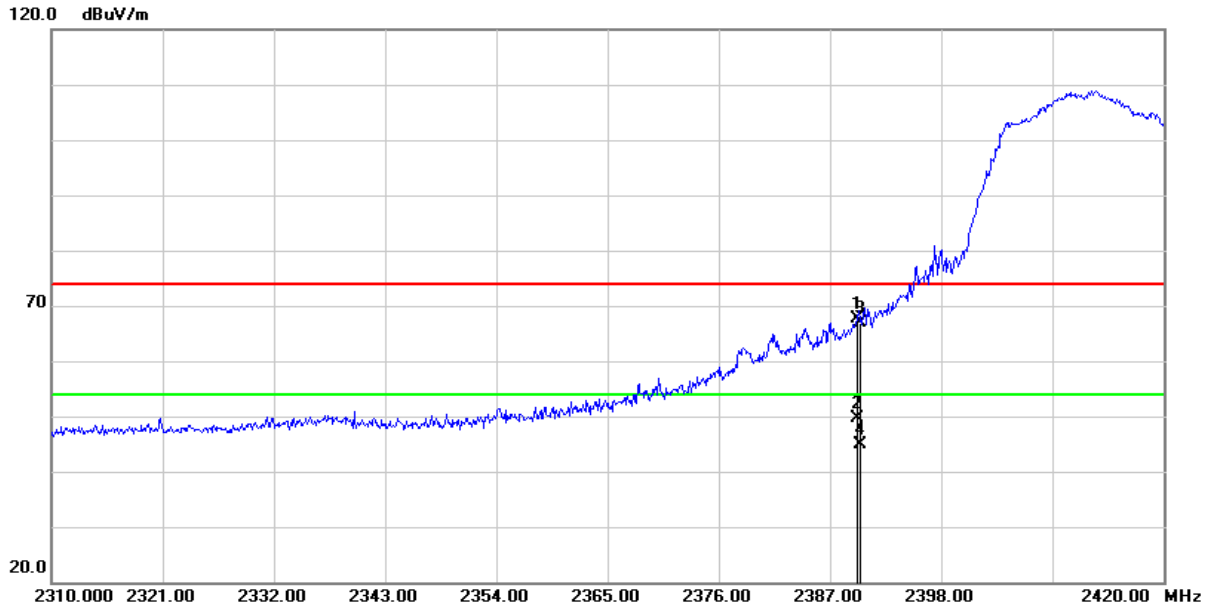

No.	Frequency (MHz)	Reading (dBuV/m)	Correct Factor (dB/m)	Result (dBuV/m)	Limit (dBuV/m)	Margin (dB)	Remark
1	2389.750	73.28	-5.69	67.59	74.00	-6.41	peak
2	2389.750	55.28	-5.69	49.59	54.00	-4.41	AVG
3	2390.000	72.66	-5.69	66.97	74.00	-7.03	peak
4	2390.000	50.62	-5.69	44.93	54.00	-9.07	AVG

Remark :

1. Correction Factor = Antenna factor + Cable loss – Amplifier gain
2. Result Value = Reading Level + Correct Factor
3. Margin Level = Result Value – Limit Value
4. The other emission levels were very low against the limit

Test Mode :	Transmit(802.11g)	Test Date :	2023/09/22
Test Channel :	CH01(2412MHz)	Temperature :	23.2 °C
Polarization :	Vertical	Relative Humidity :	42.5 %

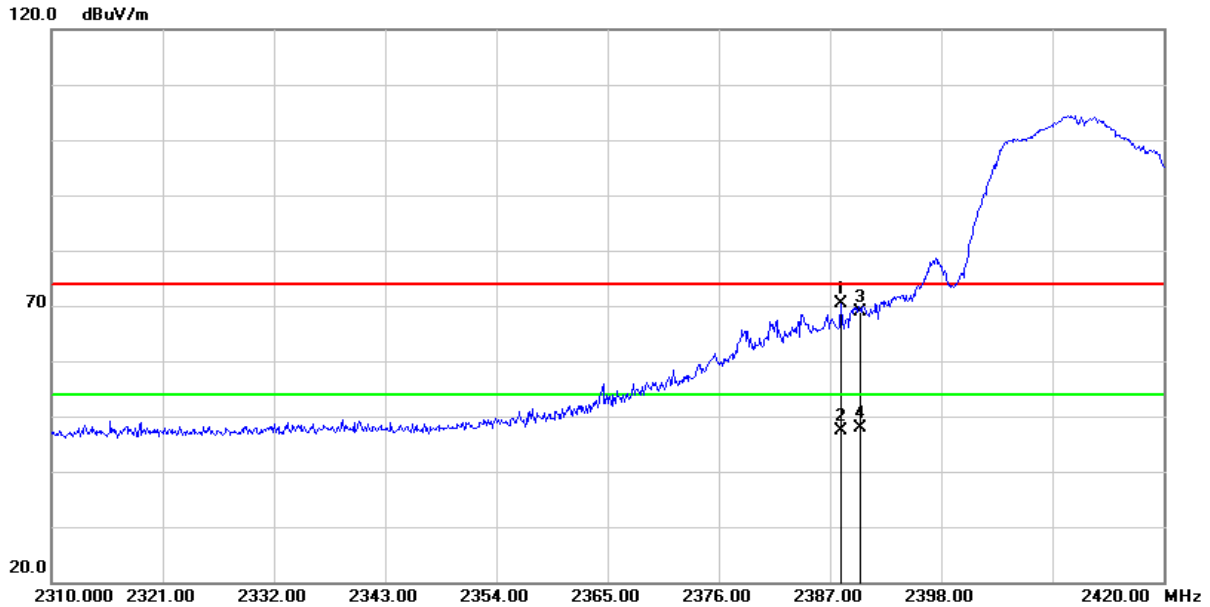

No.	Frequency (MHz)	Reading (dBuV/m)	Correct Factor (dB/m)	Result (dBuV/m)	Limit (dBuV/m)	Margin (dB)	Remark
1	2388.100	76.17	-5.71	70.46	74.00	-3.54	peak
2	2388.100	53.08	-5.71	47.37	54.00	-6.63	AVG
3	2390.000	74.52	-5.69	68.83	74.00	-5.17	peak
4	2390.000	53.54	-5.69	47.85	54.00	-6.15	AVG

Remark :

1. Correction Factor = Antenna factor + Cable loss – Amplifier gain
2. Result Value = Reading Level + Correct Factor
3. Margin Level = Result Value – Limit Value
4. The other emission levels were very low against the limit

Test Mode :	Transmit(802.11g)	Test Date :	2023/09/22
Test Channel :	CH11(2462MHz)	Temperature :	23.2 °C
Polarization :	Horizontal	Relative Humidity :	42.5 %

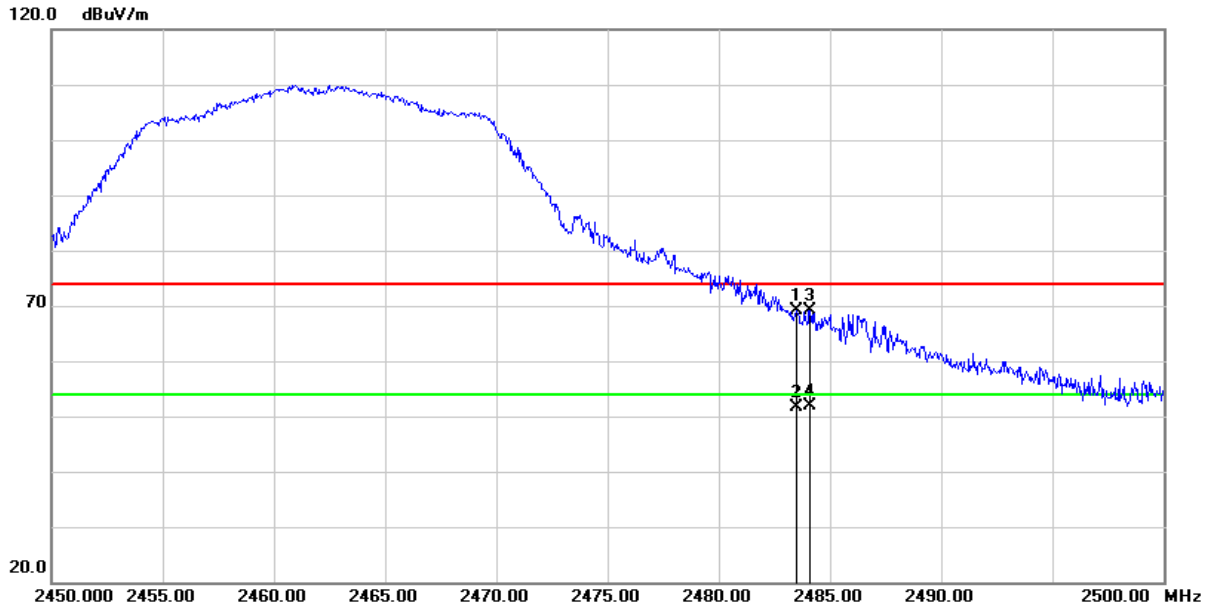

No.	Frequency (MHz)	Reading (dBuV/m)	Correct Factor (dB/m)	Result (dBuV/m)	Limit (dBuV/m)	Margin (dB)	Remark
1	2483.500	74.88	-5.81	69.07	74.00	-4.93	peak
2	2483.500	57.52	-5.81	51.71	54.00	-2.29	AVG
3	2484.100	74.97	-5.80	69.17	74.00	-4.83	peak
4	2484.100	57.60	-5.80	51.80	54.00	-2.20	AVG

Remark :

1. Correction Factor = Antenna factor + Cable loss – Amplifier gain
2. Result Value = Reading Level + Correct Factor
3. Margin Level = Result Value – Limit Value
4. The other emission levels were very low against the limit

Test Mode :	Transmit(802.11g)	Test Date :	2023/09/22
Test Channel :	CH11(2462MHz)	Temperature :	23.2 °C
Polarization :	Vertical	Relative Humidity :	42.5 %

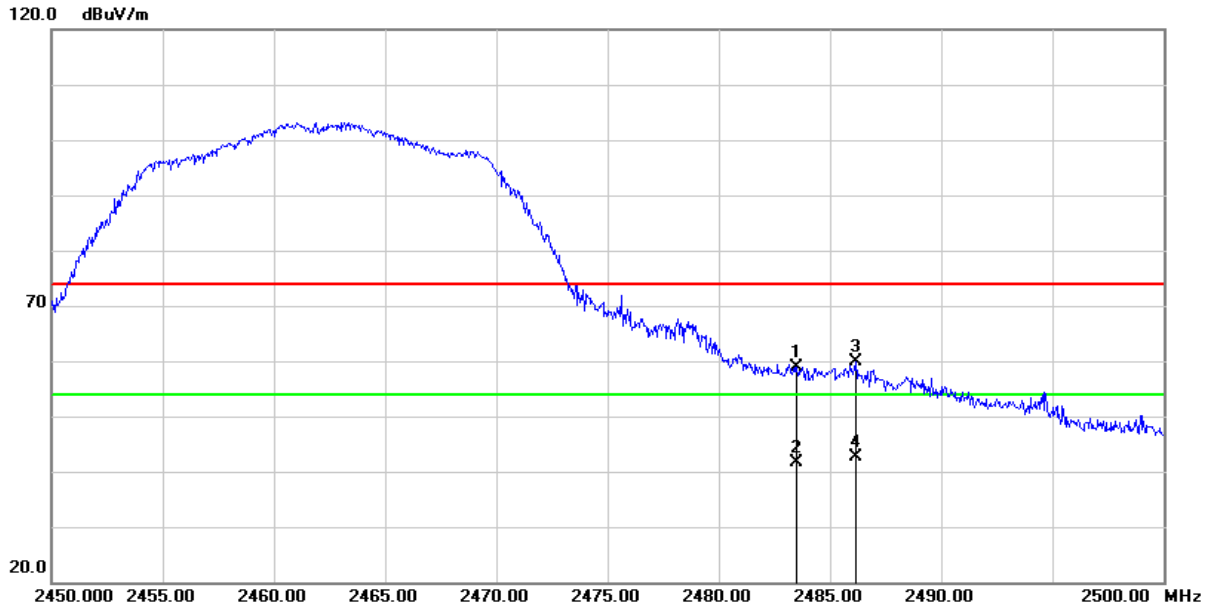

No.	Frequency (MHz)	Reading (dBuV/m)	Correct Factor (dB/m)	Result (dBuV/m)	Limit (dBuV/m)	Margin (dB)	Remark
1	2483.500	64.79	-5.81	58.98	74.00	-15.02	peak
2	2483.500	47.33	-5.81	41.52	54.00	-12.48	AVG
3	2486.150	65.70	-5.79	59.91	74.00	-14.09	peak
4	2486.150	48.52	-5.79	42.73	54.00	-11.27	AVG

Remark :

1. Correction Factor = Antenna factor + Cable loss – Amplifier gain
2. Result Value = Reading Level + Correct Factor
3. Margin Level = Result Value – Limit Value
4. The other emission levels were very low against the limit

Test Mode :	Transmit(802.11n HT20)	Test Date :	2023/09/22
Test Channel :	CH01(2412MHz)	Temperature :	23.2 °C
Polarization :	Horizontal	Relative Humidity :	42.5 %

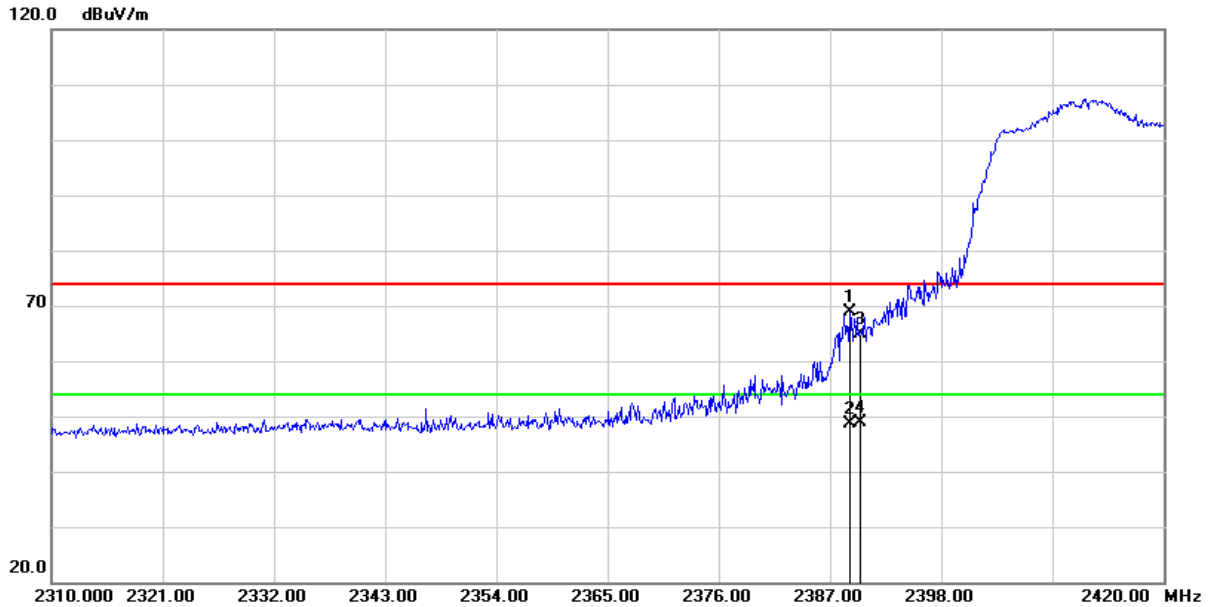

No.	Frequency (MHz)	Reading (dBuV/m)	Correct Factor (dB/m)	Result (dBuV/m)	Limit (dBuV/m)	Margin (dB)	Remark
1	2388.980	74.58	-5.70	68.88	74.00	-5.12	peak
2	2388.980	54.30	-5.70	48.60	54.00	-5.40	AVG
3	2390.000	70.67	-5.69	64.98	74.00	-9.02	peak
4	2390.000	54.52	-5.69	48.83	54.00	-5.17	AVG

Remark :

1. Correction Factor = Antenna factor + Cable loss – Amplifier gain
2. Result Value = Reading Level + Correct Factor
3. Margin Level = Result Value – Limit Value
4. The other emission levels were very low against the limit

Test Mode :	Transmit(802.11n HT20)	Test Date :	2023/09/22
Test Channel :	CH01(2412MHz)	Temperature :	23.2 °C
Polarization :	Vertical	Relative Humidity :	42.5 %

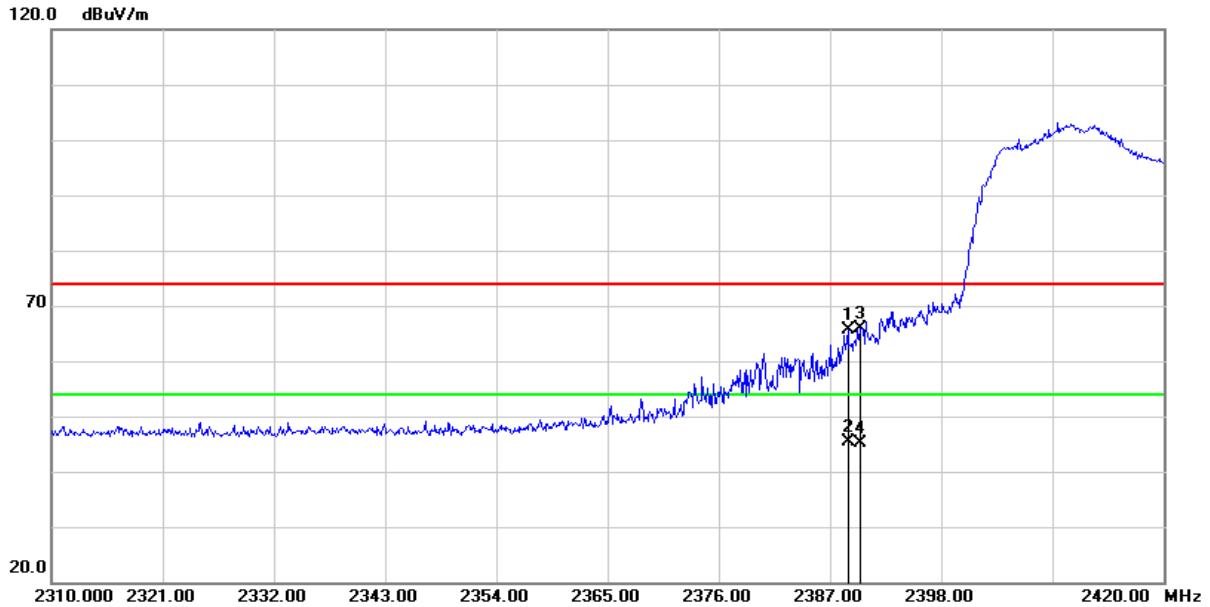

No.	Frequency (MHz)	Reading (dBuV/m)	Correct Factor (dB/m)	Result (dBuV/m)	Limit (dBuV/m)	Margin (dB)	Remark
1	2388.760	71.44	-5.70	65.74	74.00	-8.26	peak
2	2388.760	50.97	-5.70	45.27	54.00	-8.73	AVG
3	2390.000	71.59	-5.69	65.90	74.00	-8.10	peak
4	2390.000	50.94	-5.69	45.25	54.00	-8.75	AVG

Remark :

1. Correction Factor = Antenna factor + Cable loss – Amplifier gain
2. Result Value = Reading Level + Correct Factor
3. Margin Level = Result Value – Limit Value
4. The other emission levels were very low against the limit

Test Mode :	Transmit(802.11n HT20)	Test Date :	2023/09/22
Test Channel :	CH11(2462MHz)	Temperature :	23.2 °C
Polarization :	Horizontal	Relative Humidity :	42.5 %

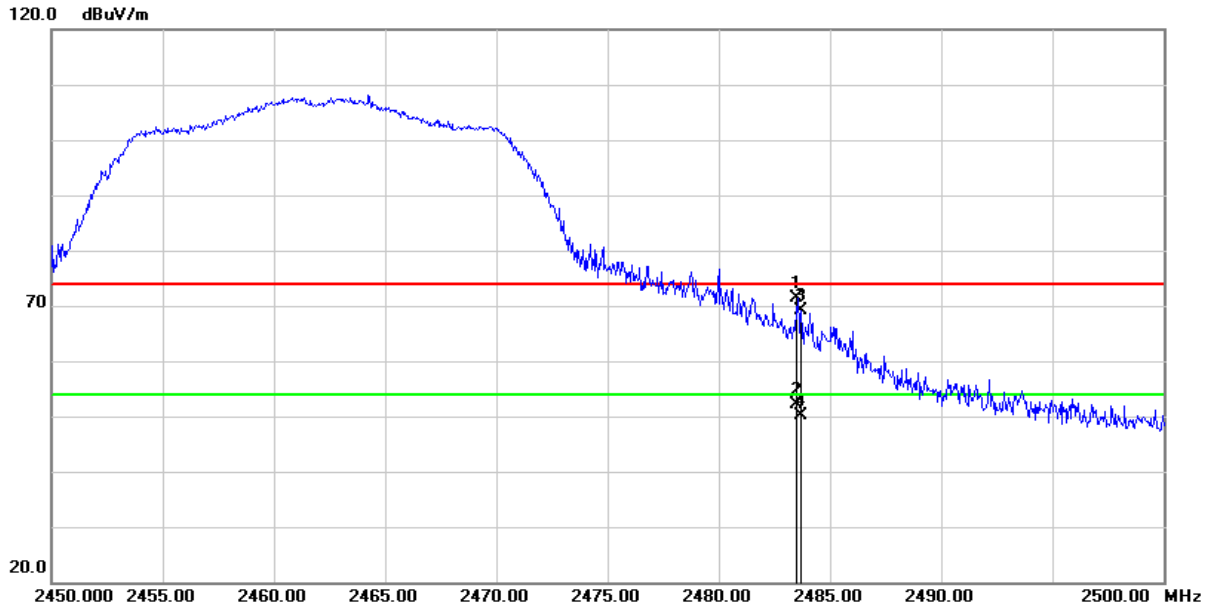

No.	Frequency (MHz)	Reading (dBuV/m)	Correct Factor (dB/m)	Result (dBuV/m)	Limit (dBuV/m)	Margin (dB)	Remark
1	2483.500	77.19	-5.81	71.38	74.00	-2.62	peak
2	2483.500	58.04	-5.81	52.23	54.00	-1.77	AVG
3	2483.700	75.02	-5.81	69.21	74.00	-4.79	peak
4	2483.700	55.94	-5.81	50.13	54.00	-3.87	AVG

Remark :

1. Correction Factor = Antenna factor + Cable loss – Amplifier gain
2. Result Value = Reading Level + Correct Factor
3. Margin Level = Result Value – Limit Value
4. The other emission levels were very low against the limit

Test Mode :	Transmit(802.11n HT20)	Test Date :	2023/09/22
Test Channel :	CH11(2462MHz)	Temperature :	23.2 °C
Polarization :	Vertical	Relative Humidity :	42.5 %

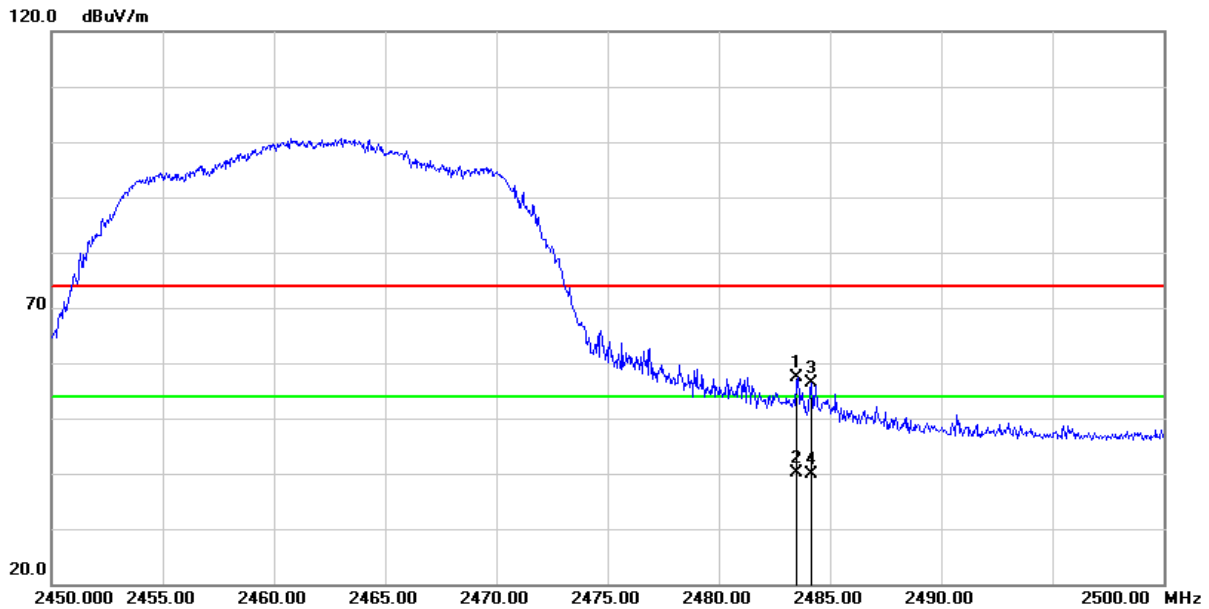

No.	Frequency (MHz)	Reading (dBuV/m)	Correct Factor (dB/m)	Result (dBuV/m)	Limit (dBuV/m)	Margin (dB)	Remark
1	2483.500	63.13	-5.81	57.32	74.00	-16.68	peak
2	2483.500	45.94	-5.81	40.13	54.00	-13.87	AVG
3	2484.150	62.08	-5.80	56.28	74.00	-17.72	peak
4	2484.150	45.61	-5.80	39.81	54.00	-14.19	AVG

Remark :

1. Correction Factor = Antenna factor + Cable loss – Amplifier gain
2. Result Value = Reading Level + Correct Factor
3. Margin Level = Result Value – Limit Value
4. The other emission levels were very low against the limit

2.6.6 Test Result of Radiated Spurious Emission Measurement

- (1) The radiation measurement frequency is 9kHz ~ 30MHz. The interference value of this frequency range is less than the limit value of 20 dB. It is considered that the background noise value is not recorded.
- (2) The following table shows the radiation measurement frequency from 30MHz to 26.5GHz, pre-scanning in the X, Y and Z axes. The worst case (X-axis) is documented in this report.

Test Frequency	
RF	802.11b / 802.11g / 802.11n HT20
Tx	CH01 (2412MHz) CH06 (2437MHz) CH11 (2462MHz)

Above 1GHz Data

Test Mode :	Transmit(802.11b)	Test Date :	2023/09/22
Test Channel :	CH01(2412MHz)	Temperature :	23.2 °C
Polarization :	Horizontal	Relative Humidity :	42.5 %

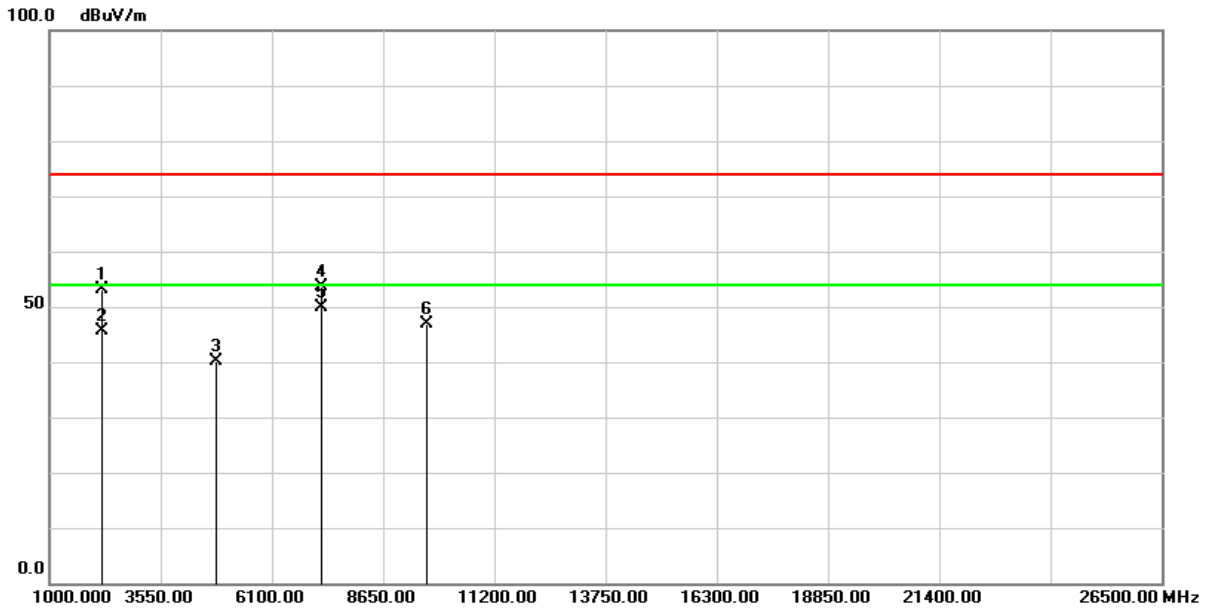

No.	Frequency (MHz)	Reading (dBuV/m)	Correct Factor (dB/m)	Result (dBuV/m)	Limit (dBuV/m)	Margin (dB)	Remark
1	2180.000	80.98	-27.78	53.20	74.00	-20.80	peak
2	2180.000	73.34	-27.78	45.56	54.00	-8.44	AVG
3	4824.000	59.23	-18.98	40.25	74.00	-33.75	peak
4	7236.000	66.65	-12.90	53.75	74.00	-20.25	peak
5	7236.000	62.74	-12.90	49.84	54.00	-4.16	AVG
6	9648.000	55.78	-8.88	46.90	74.00	-27.10	peak

Remark :

1. Correction Factor = Antenna factor + Cable loss – Amplifier gain
2. Result Value = Reading Level + Correct Factor
3. Margin Level = Result Value – Limit Value
4. The other emission levels were very low against the limit

Test Mode :	Transmit(802.11b)	Test Date :	2023/09/22
Test Channel :	CH01(2412MHz)	Temperature :	23.2 °C
Polarization :	Vertical	Relative Humidity :	42.5 %

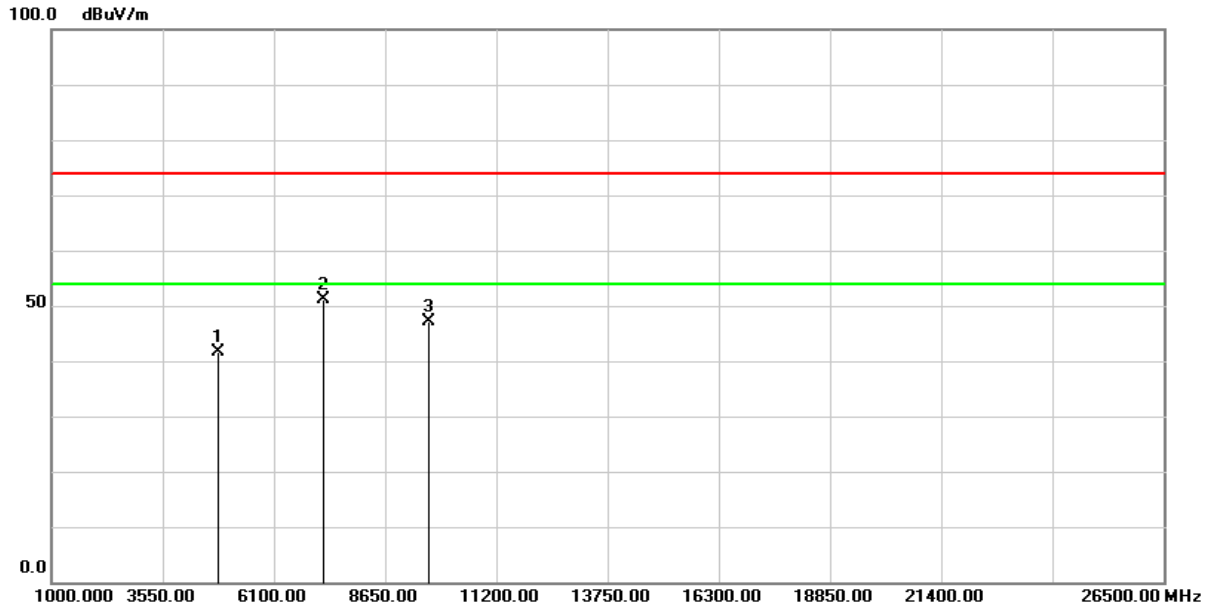

No.	Frequency (MHz)	Reading (dBuV/m)	Correct Factor (dB/m)	Result (dBuV/m)	Limit (dBuV/m)	Margin (dB)	Remark
1	4824.000	60.60	-18.98	41.62	74.00	-32.38	peak
2	7236.000	64.11	-12.90	51.21	74.00	-22.79	peak
3	9648.000	55.91	-8.88	47.03	74.00	-26.97	peak

Remark :

1. Correction Factor = Antenna factor + Cable loss – Amplifier gain
2. Result Value = Reading Level + Correct Factor
3. Margin Level = Result Value – Limit Value
4. The other emission levels were very low against the limit

Test Mode :	Transmit(802.11b)	Test Date :	2023/09/22
Test Channel :	CH06(2437MHz)	Temperature :	23.2 °C
Polarization :	Horizontal	Relative Humidity :	42.5 %

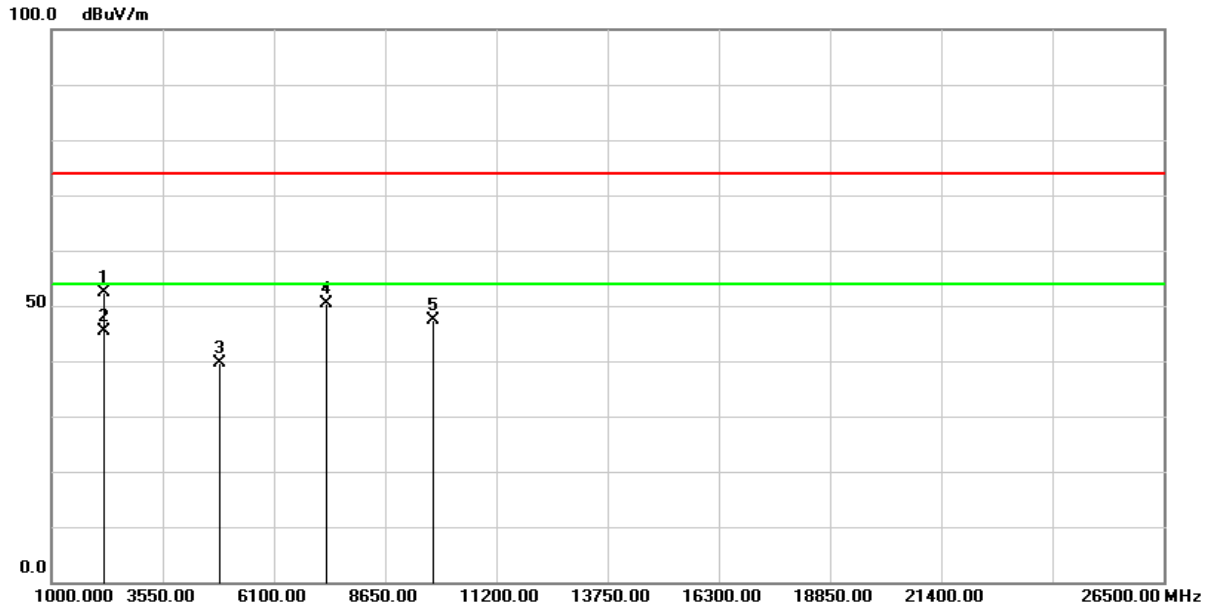

No.	Frequency (MHz)	Reading (dBuV/m)	Correct Factor (dB/m)	Result (dBuV/m)	Limit (dBuV/m)	Margin (dB)	Remark
1	2178.000	80.13	-27.81	52.32	74.00	-21.68	peak
2	2178.000	73.20	-27.81	45.39	54.00	-8.61	AVG
3	4874.000	58.54	-19.00	39.54	74.00	-34.46	peak
4	7311.000	62.96	-12.53	50.43	74.00	-23.57	peak
5	9748.000	56.03	-8.76	47.27	74.00	-26.73	peak

Remark :

1. Correction Factor = Antenna factor + Cable loss – Amplifier gain
2. Result Value = Reading Level + Correct Factor
3. Margin Level = Result Value – Limit Value
4. The other emission levels were very low against the limit

Test Mode :	Transmit(802.11b)	Test Date :	2023/09/22
Test Channel :	CH06(2437MHz)	Temperature :	23.2 °C
Polarization :	Vertical	Relative Humidity :	42.5 %

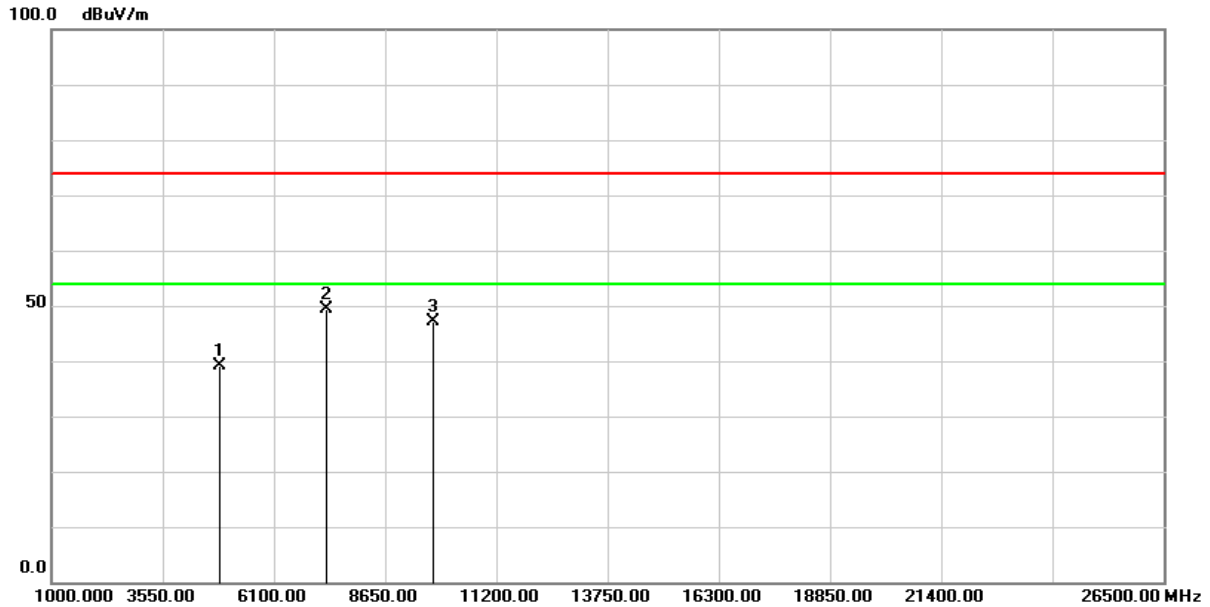

No.	Frequency (MHz)	Reading (dBuV/m)	Correct Factor (dB/m)	Result (dBuV/m)	Limit (dBuV/m)	Margin (dB)	Remark
1	4874.000	58.16	-19.00	39.16	74.00	-34.84	peak
2	7311.000	61.98	-12.53	49.45	74.00	-24.55	peak
3	9748.000	56.01	-8.76	47.25	74.00	-26.75	peak

Remark :

1. Correction Factor = Antenna factor + Cable loss – Amplifier gain
2. Result Value = Reading Level + Correct Factor
3. Margin Level = Result Value – Limit Value
4. The other emission levels were very low against the limit

Test Mode :	Transmit(802.11b)	Test Date :	2023/09/22
Test Channel :	CH11(2462MHz)	Temperature :	23.2 °C
Polarization :	Horizontal	Relative Humidity :	42.5 %

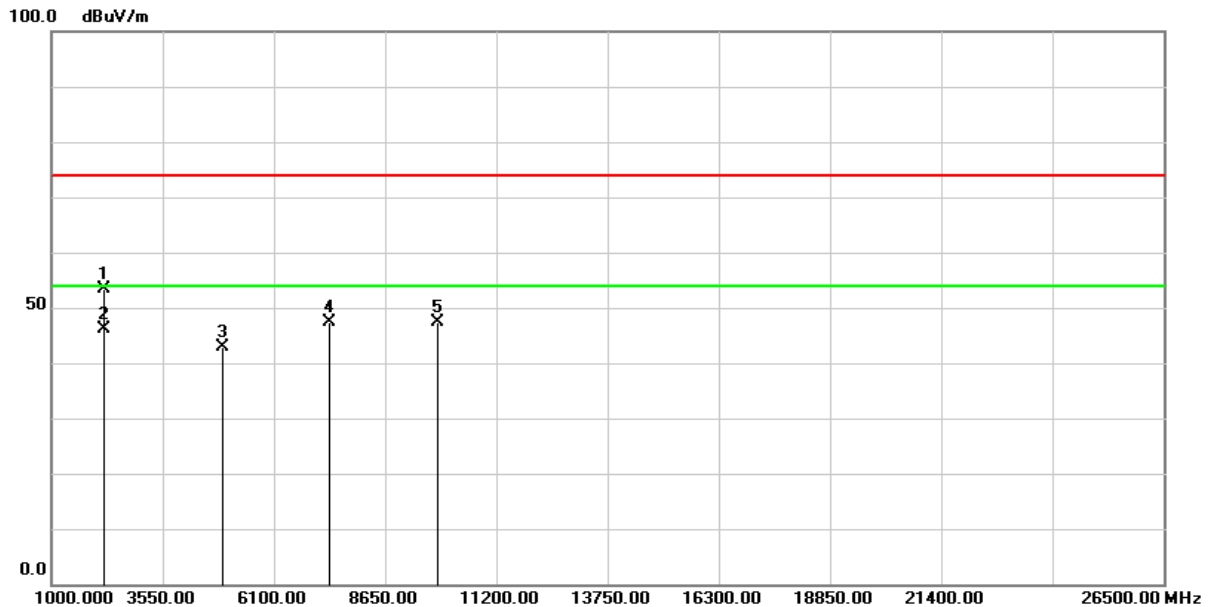

No.	Frequency (MHz)	Reading (dBuV/m)	Correct Factor (dB/m)	Result (dBuV/m)	Limit (dBuV/m)	Margin (dB)	Remark
1	2180.000	81.23	-27.78	53.45	74.00	-20.55	peak
2	2180.000	73.98	-27.78	46.20	54.00	-7.80	AVG
3	4924.000	62.00	-19.01	42.99	74.00	-31.01	peak
4	7386.000	59.89	-12.39	47.50	74.00	-26.50	peak
5	9848.000	56.06	-8.62	47.44	74.00	-26.56	peak

Remark :

1. Correction Factor = Antenna factor + Cable loss – Amplifier gain
2. Result Value = Reading Level + Correct Factor
3. Margin Level = Result Value – Limit Value
4. The other emission levels were very low against the limit

Test Mode :	Transmit(802.11b)	Test Date :	2023/09/22
Test Channel :	CH11(2462MHz)	Temperature :	23.2 °C
Polarization :	Vertical	Relative Humidity :	42.5 %

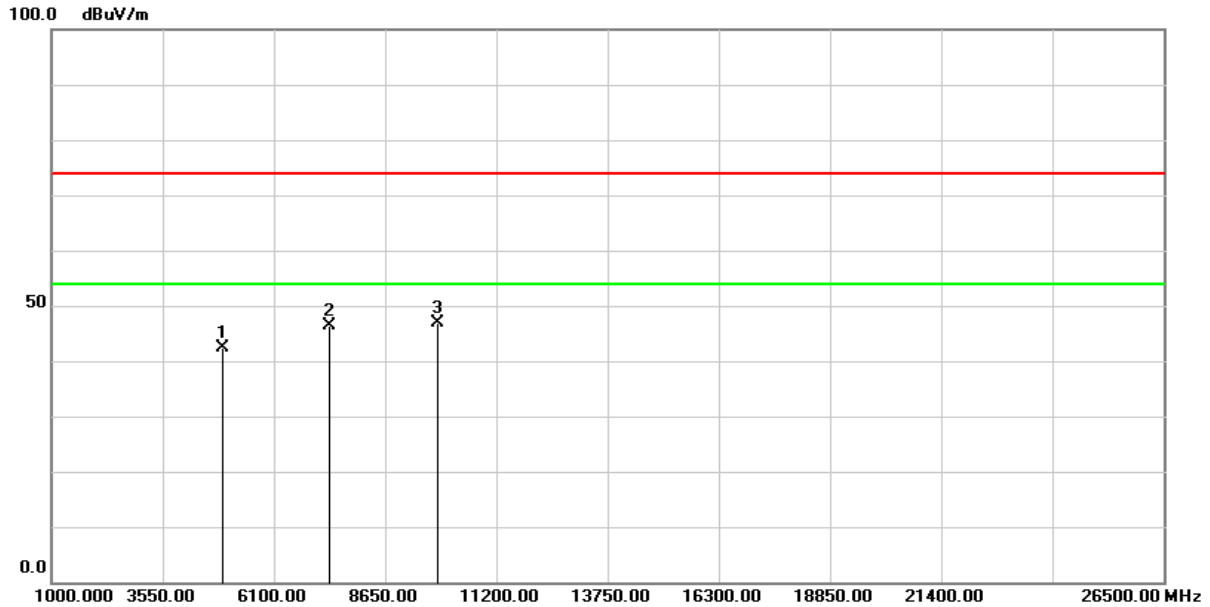

No.	Frequency (MHz)	Reading (dBuV/m)	Correct Factor (dB/m)	Result (dBuV/m)	Limit (dBuV/m)	Margin (dB)	Remark
1	4924.000	61.45	-19.01	42.44	74.00	-31.56	peak
2	7386.000	58.76	-12.39	46.37	74.00	-27.63	peak
3	9848.000	55.54	-8.62	46.92	74.00	-27.08	peak

Remark :

1. Correction Factor = Antenna factor + Cable loss – Amplifier gain
2. Result Value = Reading Level + Correct Factor
3. Margin Level = Result Value – Limit Value
4. The other emission levels were very low against the limit

Test Mode :	Transmit(802.11g)	Test Date :	2023/09/22
Test Channel :	CH01(2412MHz)	Temperature :	23.2 °C
Polarization :	Horizontal	Relative Humidity :	42.5 %

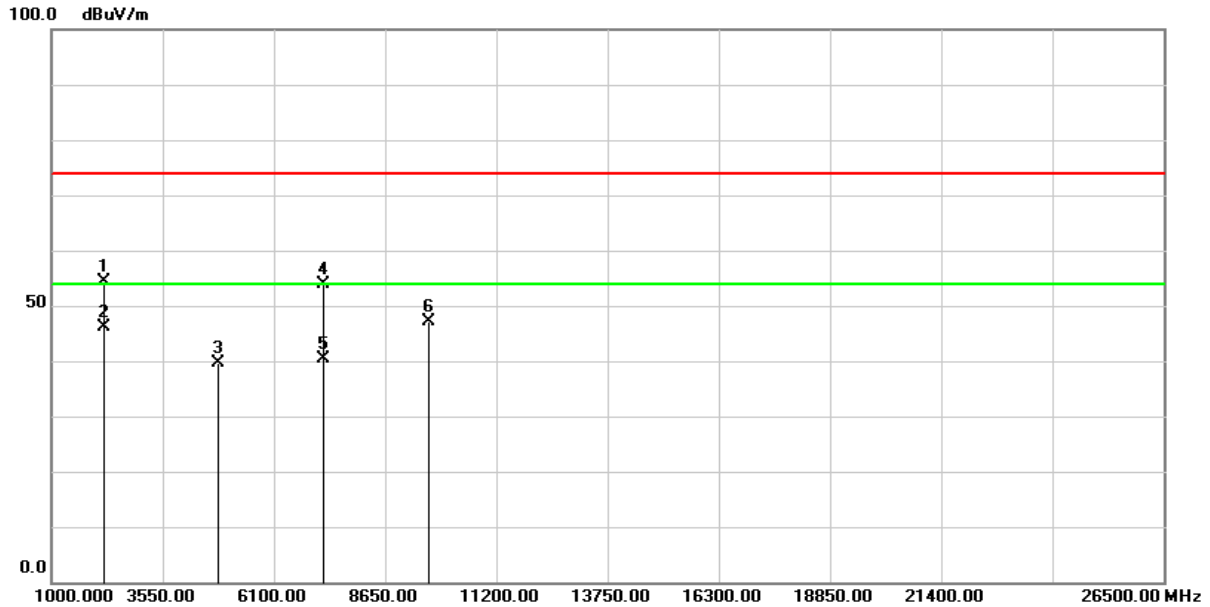

No.	Frequency (MHz)	Reading (dBuV/m)	Correct Factor (dB/m)	Result (dBuV/m)	Limit (dBuV/m)	Margin (dB)	Remark
1	2180.000	82.28	-27.78	54.50	74.00	-19.50	peak
2	2180.000	73.91	-27.78	46.13	54.00	-7.87	AVG
3	4824.000	58.66	-18.98	39.68	74.00	-34.32	peak
4	7236.000	66.72	-12.90	53.82	74.00	-20.18	peak
5	7236.000	53.28	-12.90	40.38	54.00	-13.62	AVG
6	9648.000	56.11	-8.88	47.23	74.00	-26.77	peak

Remark :

1. Correction Factor = Antenna factor + Cable loss – Amplifier gain
2. Result Value = Reading Level + Correct Factor
3. Margin Level = Result Value – Limit Value
4. The other emission levels were very low against the limit

Test Mode :	Transmit(802.11g)	Test Date :	2023/09/22
Test Channel :	CH01(2412MHz)	Temperature :	23.2 °C
Polarization :	Vertical	Relative Humidity :	42.5 %

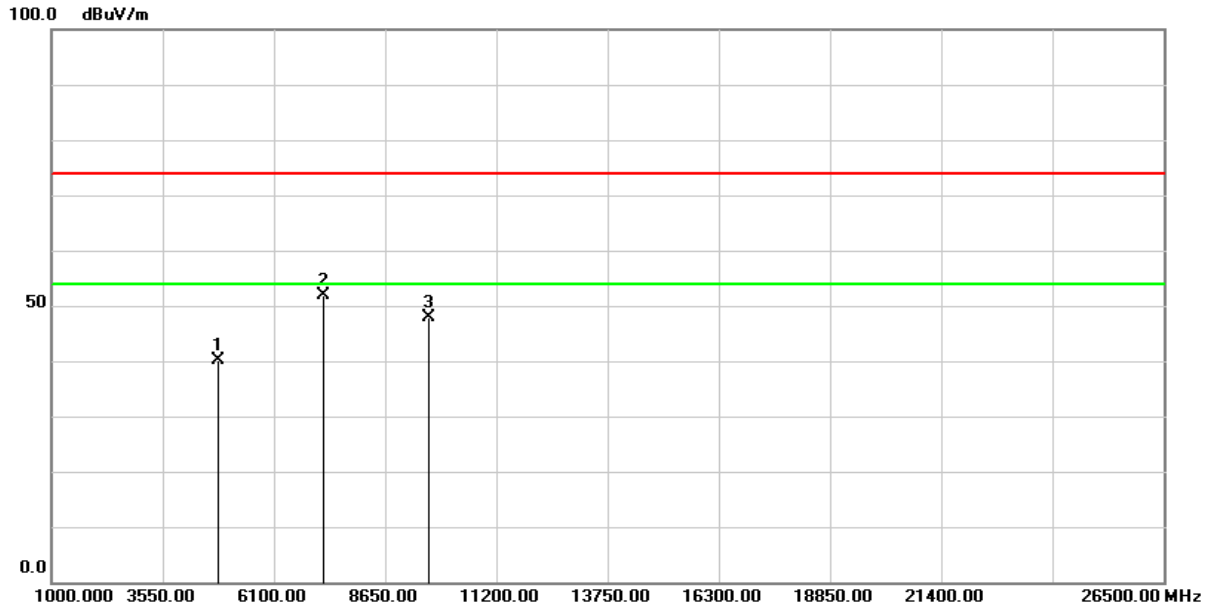

No.	Frequency (MHz)	Reading (dBuV/m)	Correct Factor (dB/m)	Result (dBuV/m)	Limit (dBuV/m)	Margin (dB)	Remark
1	4824.000	59.08	-18.98	40.10	74.00	-33.90	peak
2	7236.000	64.85	-12.90	51.95	74.00	-22.05	peak
3	9648.000	56.72	-8.88	47.84	74.00	-26.16	peak

Remark :

1. Correction Factor = Antenna factor + Cable loss – Amplifier gain
2. Result Value = Reading Level + Correct Factor
3. Margin Level = Result Value – Limit Value
4. The other emission levels were very low against the limit

Test Mode :	Transmit(802.11g)	Test Date :	2023/09/22
Test Channel :	CH06(2437MHz)	Temperature :	23.2 °C
Polarization :	Horizontal	Relative Humidity :	42.5 %

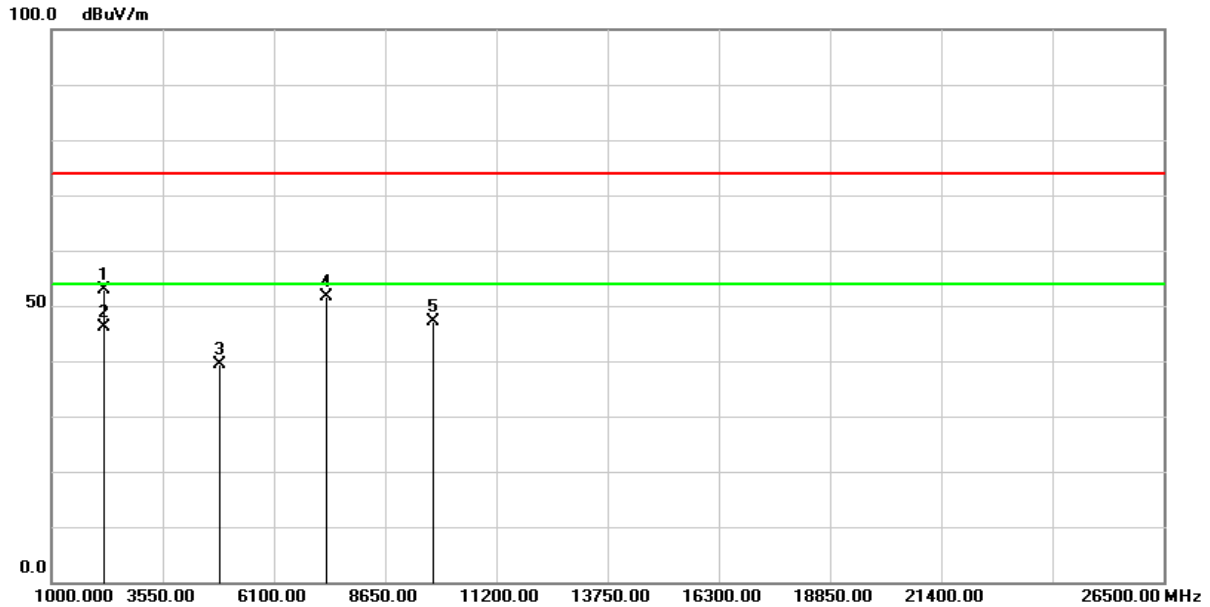

No.	Frequency (MHz)	Reading (dBuV/m)	Correct Factor (dB/m)	Result (dBuV/m)	Limit (dBuV/m)	Margin (dB)	Remark
1	2180.000	80.78	-27.78	53.00	74.00	-21.00	peak
2	2180.000	74.00	-27.78	46.22	54.00	-7.78	AVG
3	4874.000	58.49	-19.00	39.49	74.00	-34.51	peak
4	7311.000	64.17	-12.53	51.64	74.00	-22.36	peak
5	9748.000	55.77	-8.76	47.01	74.00	-26.99	peak

Remark :

1. Correction Factor = Antenna factor + Cable loss – Amplifier gain
2. Result Value = Reading Level + Correct Factor
3. Margin Level = Result Value – Limit Value
4. The other emission levels were very low against the limit

Test Mode :	Transmit(802.11g)	Test Date :	2023/09/22
Test Channel :	CH06(2437MHz)	Temperature :	23.2 °C
Polarization :	Vertical	Relative Humidity :	42.5 %

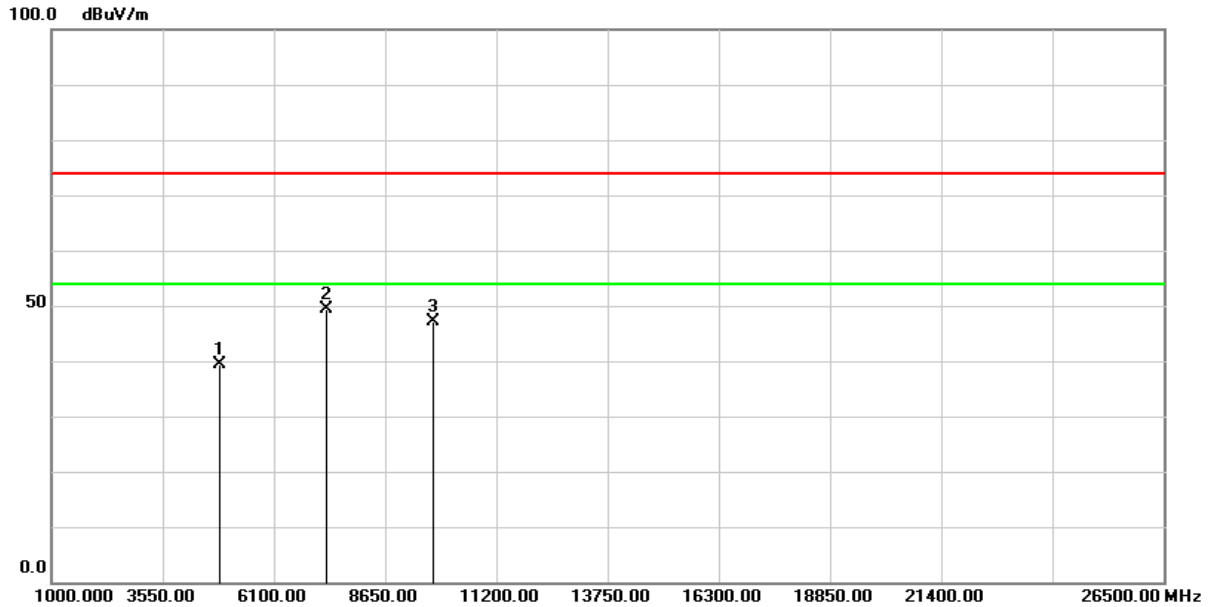

No.	Frequency (MHz)	Reading (dBuV/m)	Correct Factor (dB/m)	Result (dBuV/m)	Limit (dBuV/m)	Margin (dB)	Remark
1	4874.000	58.48	-19.00	39.48	74.00	-34.52	peak
2	7311.000	61.82	-12.53	49.29	74.00	-24.71	peak
3	9748.000	56.01	-8.76	47.25	74.00	-26.75	peak

Remark :

1. Correction Factor = Antenna factor + Cable loss – Amplifier gain
2. Result Value = Reading Level + Correct Factor
3. Margin Level = Result Value – Limit Value
4. The other emission levels were very low against the limit

Test Mode :	Transmit(802.11g)	Test Date :	2023/09/22
Test Channel :	CH11(2462MHz)	Temperature :	23.2 °C
Polarization :	Horizontal	Relative Humidity :	42.5 %

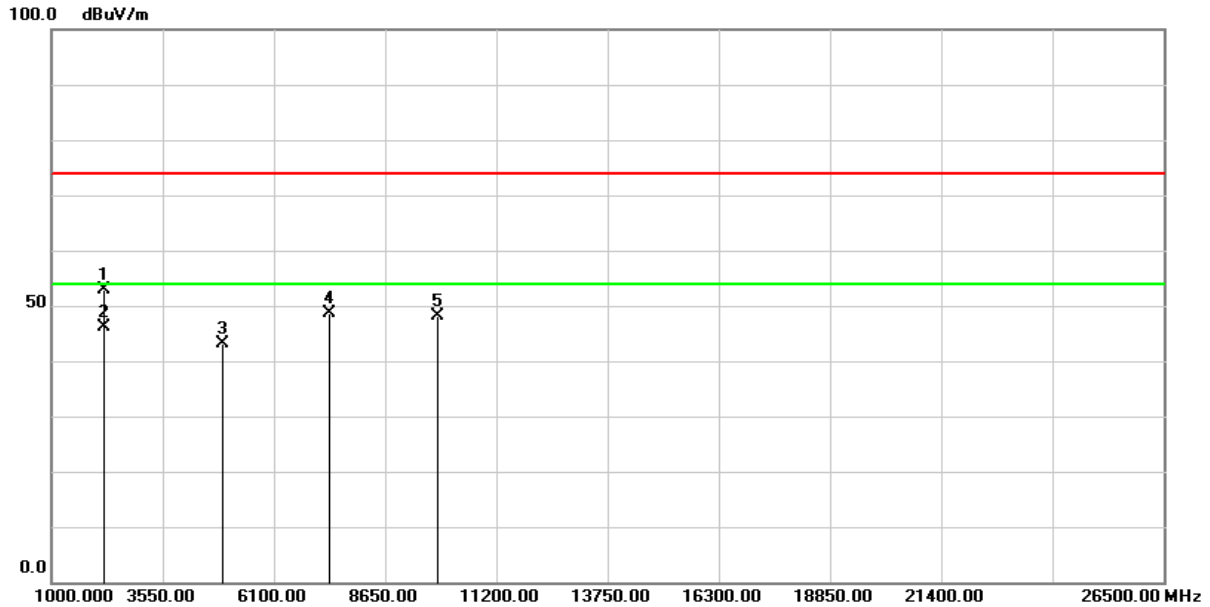

No.	Frequency (MHz)	Reading (dBuV/m)	Correct Factor (dB/m)	Result (dBuV/m)	Limit (dBuV/m)	Margin (dB)	Remark
1	2180.000	80.57	-27.78	52.79	74.00	-21.21	peak
2	2180.000	73.89	-27.78	46.11	54.00	-7.89	AVG
3	4924.000	62.02	-19.01	43.01	74.00	-30.99	peak
4	7386.000	61.11	-12.39	48.72	74.00	-25.28	peak
5	9848.000	56.66	-8.62	48.04	74.00	-25.96	peak

Remark :

1. Correction Factor = Antenna factor + Cable loss – Amplifier gain
2. Result Value = Reading Level + Correct Factor
3. Margin Level = Result Value – Limit Value
4. The other emission levels were very low against the limit

Test Mode :	Transmit(802.11g)	Test Date :	2023/09/22
Test Channel :	CH11(2462MHz)	Temperature :	23.2 °C
Polarization :	Vertical	Relative Humidity :	42.5 %

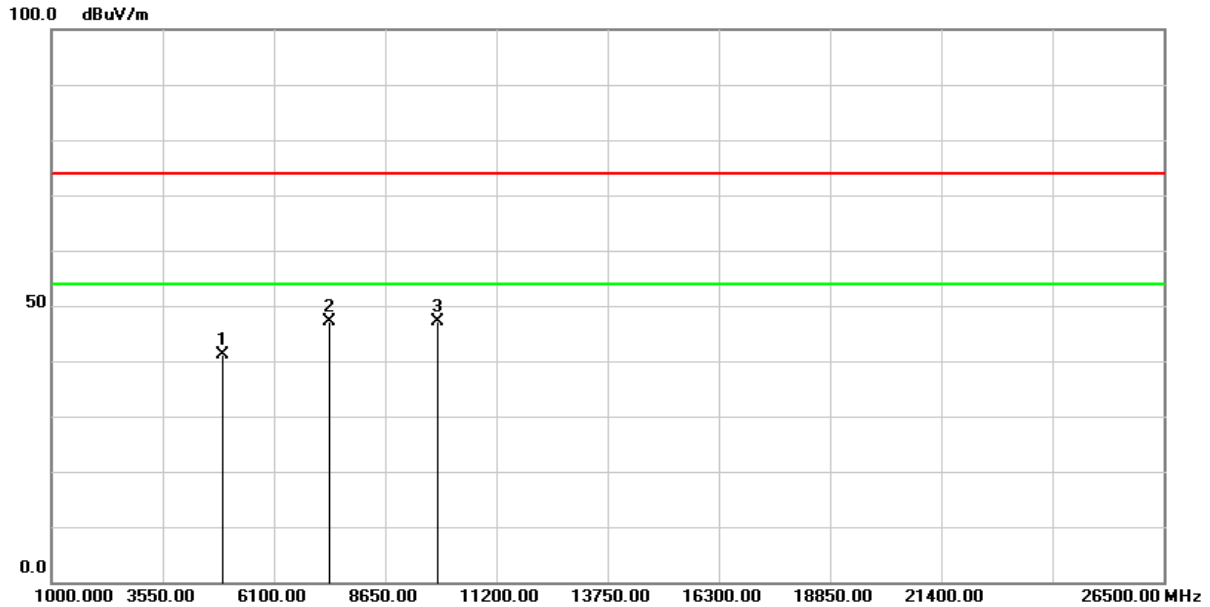

No.	Frequency (MHz)	Reading (dBuV/m)	Correct Factor (dB/m)	Result (dBuV/m)	Limit (dBuV/m)	Margin (dB)	Remark
1	4924.000	60.08	-19.01	41.07	74.00	-32.93	peak
2	7386.000	59.43	-12.39	47.04	74.00	-26.96	peak
3	9848.000	55.83	-8.62	47.21	74.00	-26.79	peak

Remark :

1. Correction Factor = Antenna factor + Cable loss – Amplifier gain
2. Result Value = Reading Level + Correct Factor
3. Margin Level = Result Value – Limit Value
4. The other emission levels were very low against the limit

Test Mode :	Transmit(802.11n HT20)	Test Date :	2023/09/22
Test Channel :	CH01(2412MHz)	Temperature :	23.2 °C
Polarization :	Horizontal	Relative Humidity :	42.5 %

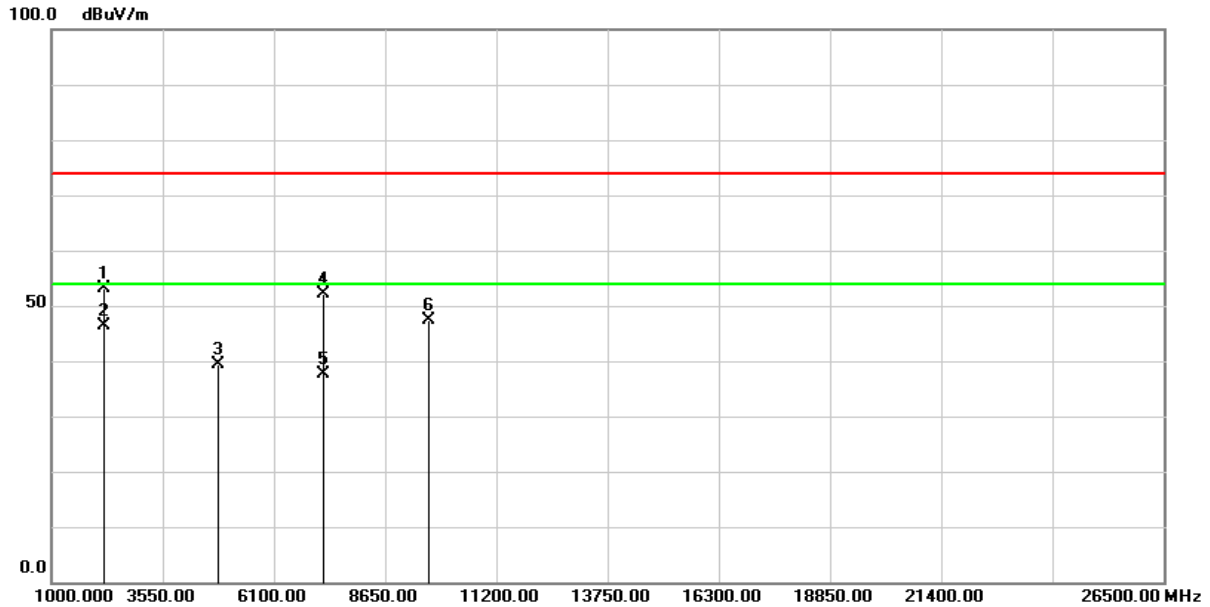

No.	Frequency (MHz)	Reading (dBuV/m)	Correct Factor (dB/m)	Result (dBuV/m)	Limit (dBuV/m)	Margin (dB)	Remark
1	2180.000	80.99	-27.78	53.21	74.00	-20.79	peak
2 *	2180.000	74.04	-27.78	46.26	54.00	-7.74	AVG
3	4824.000	58.41	-18.98	39.43	74.00	-34.57	peak
4	7236.000	65.06	-12.90	52.16	74.00	-21.84	peak
5	7236.000	50.45	-12.90	37.55	54.00	-16.45	AVG
6	9648.000	56.25	-8.88	47.37	74.00	-26.63	peak

Remark :

1. Correction Factor = Antenna factor + Cable loss – Amplifier gain
2. Result Value = Reading Level + Correct Factor
3. Margin Level = Result Value – Limit Value
4. The other emission levels were very low against the limit

Test Mode :	Transmit(802.11n HT20)	Test Date :	2023/09/22
Test Channel :	CH01(2412MHz)	Temperature :	23.2 °C
Polarization :	Vertical	Relative Humidity :	42.5 %

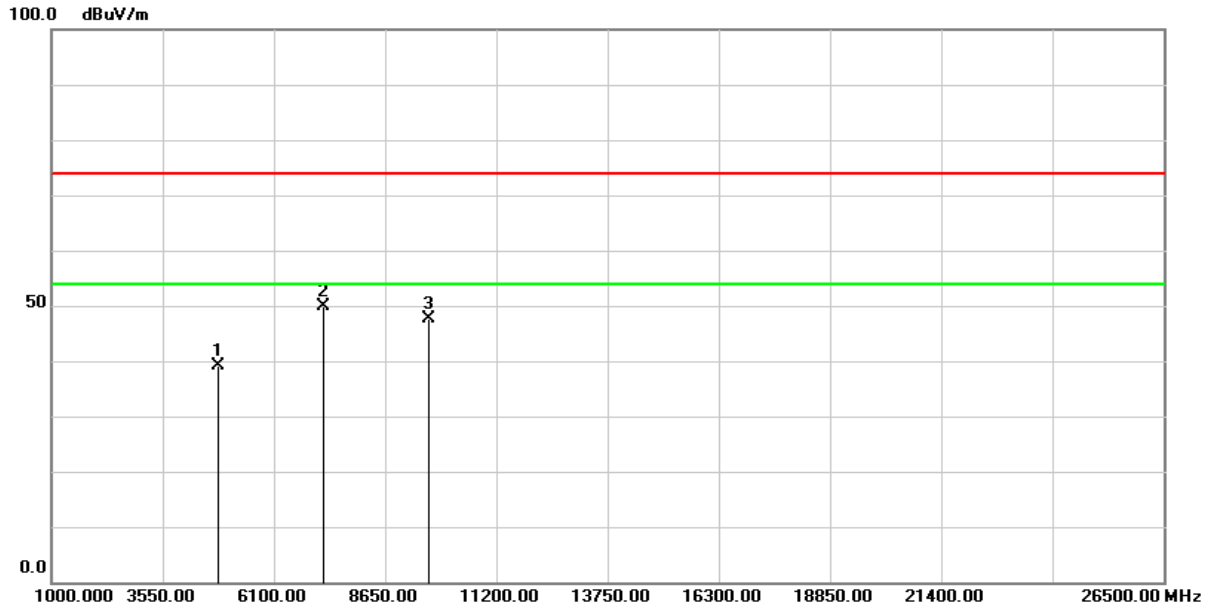

No.	Frequency (MHz)	Reading (dBuV/m)	Correct Factor (dB/m)	Result (dBuV/m)	Limit (dBuV/m)	Margin (dB)	Remark
1	4824.000	58.07	-18.98	39.09	74.00	-34.91	peak
2	7236.000	62.86	-12.90	49.96	74.00	-24.04	peak
3	9648.000	56.44	-8.88	47.56	74.00	-26.44	peak

Remark :

1. Correction Factor = Antenna factor + Cable loss – Amplifier gain
2. Result Value = Reading Level + Correct Factor
3. Margin Level = Result Value – Limit Value
4. The other emission levels were very low against the limit

Test Mode :	Transmit(802.11n HT20)	Test Date :	2023/09/22
Test Channel :	CH06(2437MHz)	Temperature :	23.2 °C
Polarization :	Horizontal	Relative Humidity :	42.5 %

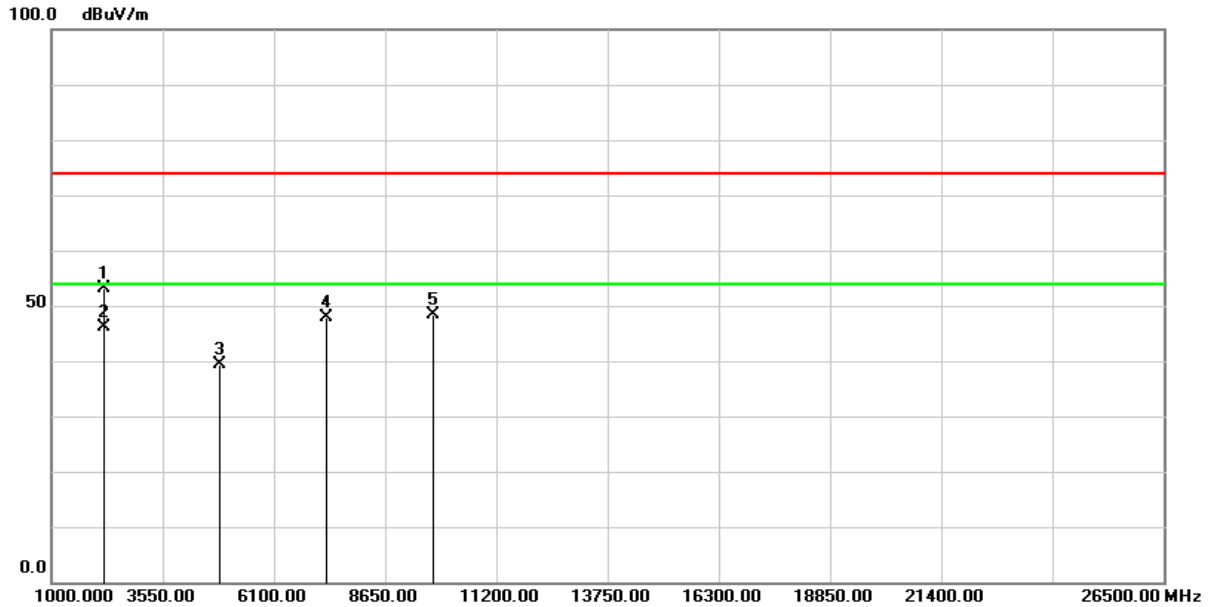

No.	Frequency (MHz)	Reading (dBuV/m)	Correct Factor (dB/m)	Result (dBuV/m)	Limit (dBuV/m)	Margin (dB)	Remark
1	2180.000	81.02	-27.78	53.24	74.00	-20.76	peak
2	2180.000	73.95	-27.78	46.17	54.00	-7.83	AVG
3	4874.000	58.30	-19.00	39.30	74.00	-34.70	peak
4	7311.000	60.50	-12.53	47.97	74.00	-26.03	peak
5	9748.000	57.16	-8.76	48.40	74.00	-25.60	peak

Remark :

1. Correction Factor = Antenna factor + Cable loss – Amplifier gain
2. Result Value = Reading Level + Correct Factor
3. Margin Level = Result Value – Limit Value
4. The other emission levels were very low against the limit

Test Mode :	Transmit(802.11n HT20)	Test Date :	2023/09/22
Test Channel :	CH06(2437MHz)	Temperature :	23.2 °C
Polarization :	Vertical	Relative Humidity :	42.5 %

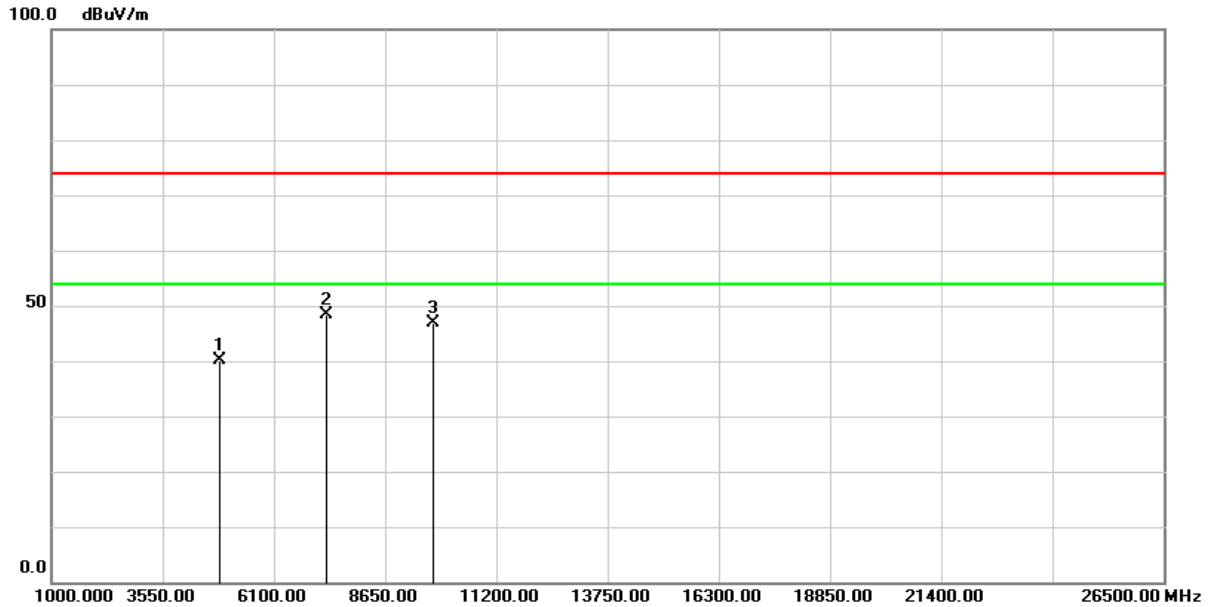

No.	Frequency (MHz)	Reading (dBuV/m)	Correct Factor (dB/m)	Result (dBuV/m)	Limit (dBuV/m)	Margin (dB)	Remark
1	4874.000	59.07	-19.00	40.07	74.00	-33.93	peak
2	7311.000	60.79	-12.53	48.26	74.00	-25.74	peak
3	9748.000	55.64	-8.76	46.88	74.00	-27.12	peak

Remark :

1. Correction Factor = Antenna factor + Cable loss – Amplifier gain
2. Result Value = Reading Level + Correct Factor
3. Margin Level = Result Value – Limit Value
4. The other emission levels were very low against the limit

Test Mode :	Transmit(802.11n HT20)	Test Date :	2023/09/22
Test Channel :	CH11(2462MHz)	Temperature :	23.2 °C
Polarization :	Horizontal	Relative Humidity :	42.5 %

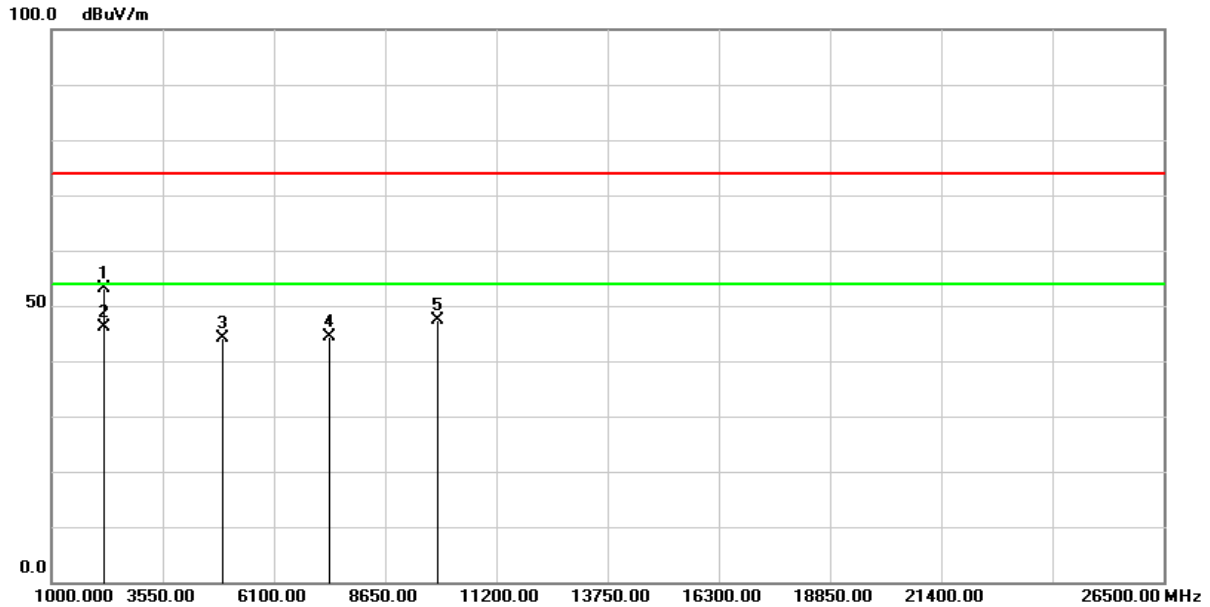

No.	Frequency (MHz)	Reading (dBuV/m)	Correct Factor (dB/m)	Result (dBuV/m)	Limit (dBuV/m)	Margin (dB)	Remark
1	2180.000	80.85	-27.78	53.07	74.00	-20.93	peak
2	2180.000	73.92	-27.78	46.14	54.00	-7.86	AVG
3	4924.000	63.22	-19.01	44.21	74.00	-29.79	peak
4	7386.000	56.76	-12.39	44.37	74.00	-29.63	peak
5	9848.000	55.92	-8.62	47.30	74.00	-26.70	peak

Remark :

1. Correction Factor = Antenna factor + Cable loss – Amplifier gain
2. Result Value = Reading Level + Correct Factor
3. Margin Level = Result Value – Limit Value
4. The other emission levels were very low against the limit

Test Mode :	Transmit(802.11n HT20)	Test Date :	2023/09/22
Test Channel :	CH11(2462MHz)	Temperature :	23.2 °C
Polarization :	Vertical	Relative Humidity :	42.5 %

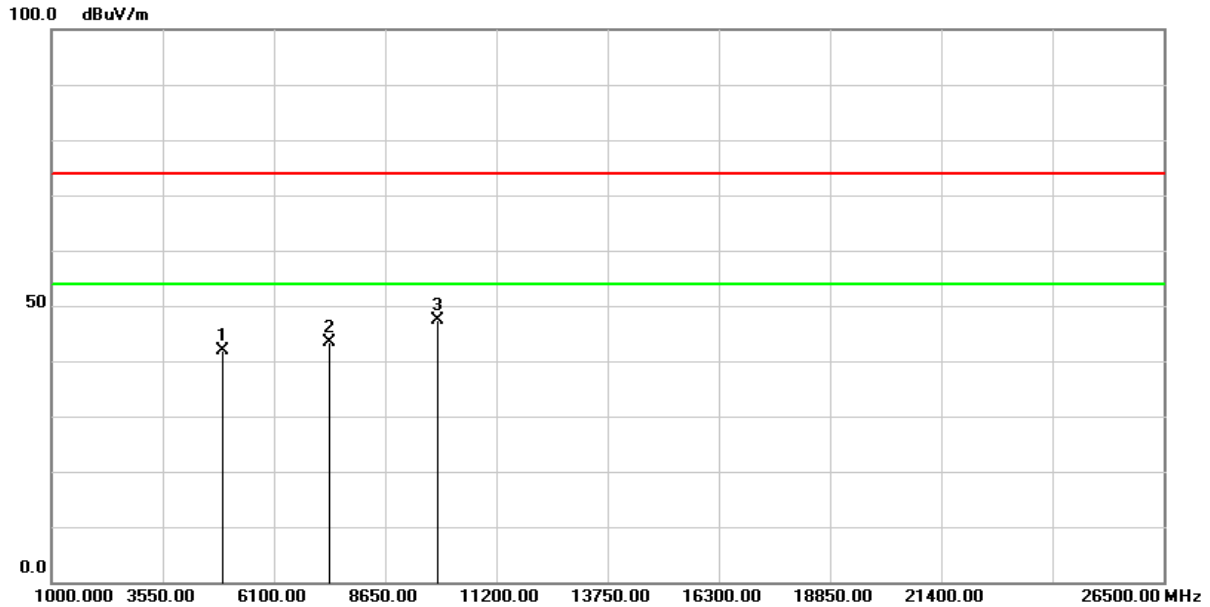

No.	Frequency (MHz)	Reading (dBuV/m)	Correct Factor (dB/m)	Result (dBuV/m)	Limit (dBuV/m)	Margin (dB)	Remark
1	4924.000	60.99	-19.01	41.98	74.00	-32.02	peak
2	7386.000	55.88	-12.39	43.49	74.00	-30.51	peak
3	9848.000	56.09	-8.62	47.47	74.00	-26.53	peak

Remark :

1. Correction Factor = Antenna factor + Cable loss – Amplifier gain
2. Result Value = Reading Level + Correct Factor
3. Margin Level = Result Value – Limit Value
4. The other emission levels were very low against the limit

Below 1GHz Data

Test Mode :	Transmit(802.11g)	Test Date :	2023/09/22
Test Channel :	CH06(2437MHz)	Temperature :	23.2°C
Polarization :	Horizontal	Relative Humidity :	42.5 %

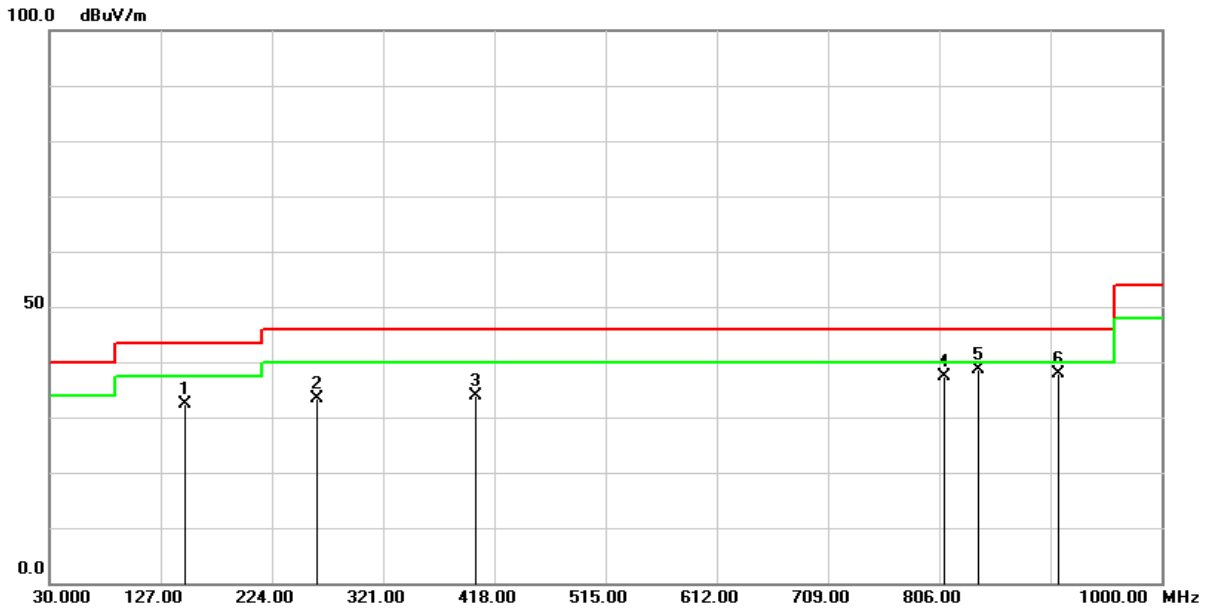

No.	Frequency (MHz)	Reading (dBuV/m)	Correct Factor (dB/m)	Result (dBuV/m)	Limit (dBuV/m)	Margin (dB)	Remark
1	148.3400	43.63	-11.19	32.44	43.50	-11.06	QP
2	263.7700	44.92	-11.49	33.43	46.00	-12.57	QP
3	401.5100	41.06	-7.17	33.89	46.00	-12.11	QP
4	810.8500	35.46	1.88	37.34	46.00	-8.66	QP
5	839.9500	36.21	2.38	38.59	46.00	-7.41	QP
6	909.7900	34.26	3.52	37.78	46.00	-8.22	QP

Remark :

1. Correction Factor = Antenna factor + Cable loss – Amplifier gain
2. Result Value = Reading Level + Correct Factor
3. Margin Level = Result Value – Limit Value
4. The other emission levels were very low against the limit

Test Mode :	Transmit(802.11g)	Test Date :	2023/09/22
Test Channel :	CH06(2437MHz)	Temperature :	23.2°C
Polarization :	Vertical	Relative Humidity :	42.5 %

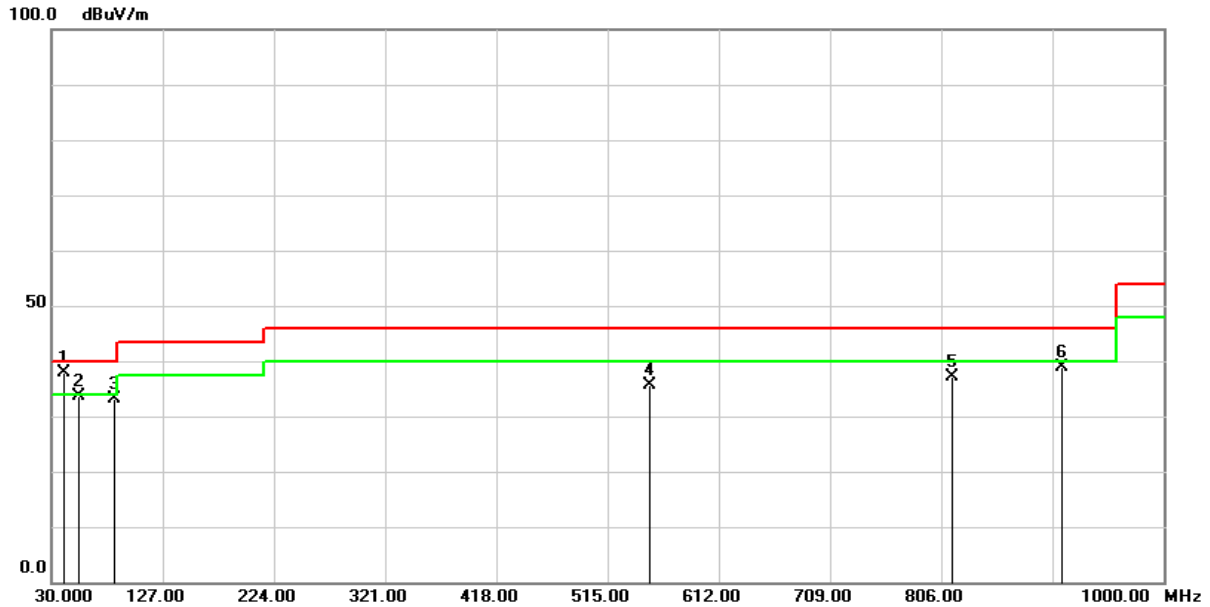

No.	Frequency (MHz)	Reading (dBuV/m)	Correct Factor (dB/m)	Result (dBuV/m)	Limit (dBuV/m)	Margin (dB)	Remark
1	41.6100	49.85	-11.91	37.94	40.00	-2.06	QP
2	54.2500	44.11	-10.53	33.58	40.00	-6.42	QP
3	85.2900	50.15	-16.99	33.16	40.00	-6.84	QP
4	551.8600	39.21	-3.65	35.56	46.00	-10.44	QP
5	815.7000	35.10	1.92	37.02	46.00	-8.98	QP
6	912.0080	35.26	3.58	38.84	46.00	-7.16	QP

Remark :

1. Correction Factor = Antenna factor + Cable loss – Amplifier gain
2. Result Value = Reading Level + Correct Factor
3. Margin Level = Result Value – Limit Value
4. The other emission levels were very low against the limit

2.7 AC Conducted Emissions Measurement

2.7.1 Limit

Frequency (MHz)	FCC Part 15 Subpart C Paragraph 15.207 (dB μ V) Limit	
	Quasi-peak	Average
0.15 to 0.5	66 to 56*	56 to 46*
0.50 to 5.0	56	46
5.0 to 30.0	60	50

*Decreases with the logarithm of the frequency

2.7.2 Test Setup

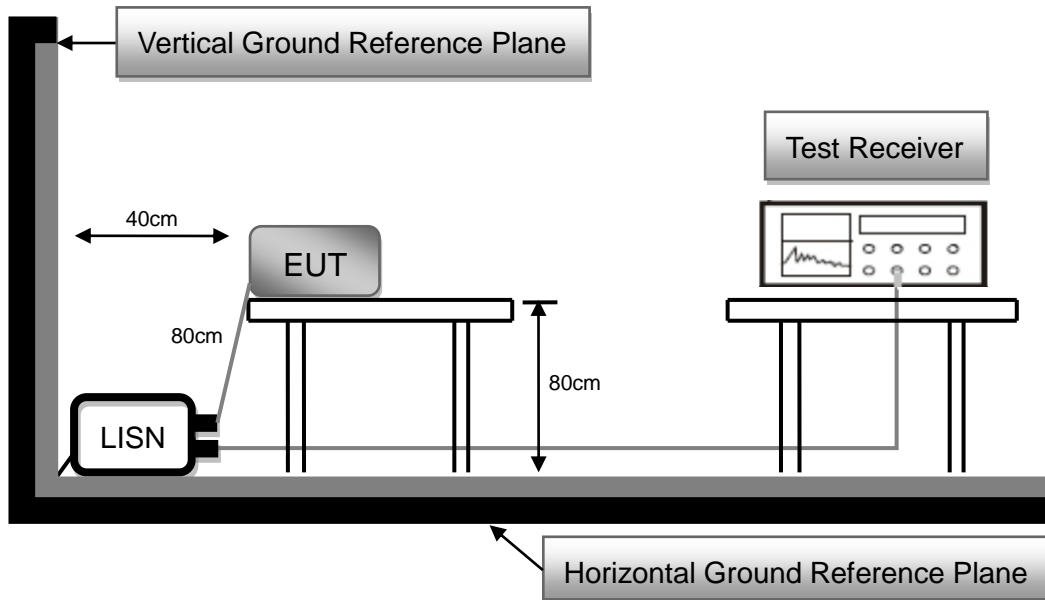

2.7.3 Test Procedure

1. Reference ANSI C63.10 : 2013 chapter 6.2
2. The EUT was placed 0.8 meter height wooden table from the horizontal ground plane with EUT being connected to power source through a line impedance stabilization network (LISN). The LISN at least be 80 cm from nearest chassis of EUT.
3. The line impedance stabilization network (LISN) provides 50 ohm/50uH of coupling impedance for the measuring instrument. All other support equipments powered from additional LISN(s).
4. Interrelating cables that hang closer than 40 cm to the ground plane shall be folded back and forth in the center forming a bundle. All I/O cables were positioned to simulate typical usage.
5. All I/O cables that are not connected to a peripheral shall be bundle in the center. The end of the cable may be terminated, if required, using the correct terminating impedance. The overall length shall not exceed 1 m.
6. The EMI test receiver connected to LISN powering the EUT. The actual test configuration, please refer to EUT test photos.
7. The receiver scanned from 150kHz to 30MHz for emissions in each of test modes. Conducted emissions were invested over the frequency range from 0.15MHz to 30MHz using a receiver bandwidth of 9kHz. A scan was taken on both power lines, Line and Neutral, recording at least six highest emissions.
8. The EUT and cable configuration of the above highest emission levels were recorded. The test data of the worst case was recorded.

2.7.4 Test Result

Test Voltage :	120Vac, 60Hz	Frequency Range:	0.15-30 MHz
Test Mode :	Transmit (802.11g 6Mbps)	6dB Bandwidth :	9 kHz
Test Date :	2023/09/11	Phase :	L
Temperature :	25.2°C	Humidity :	43 %

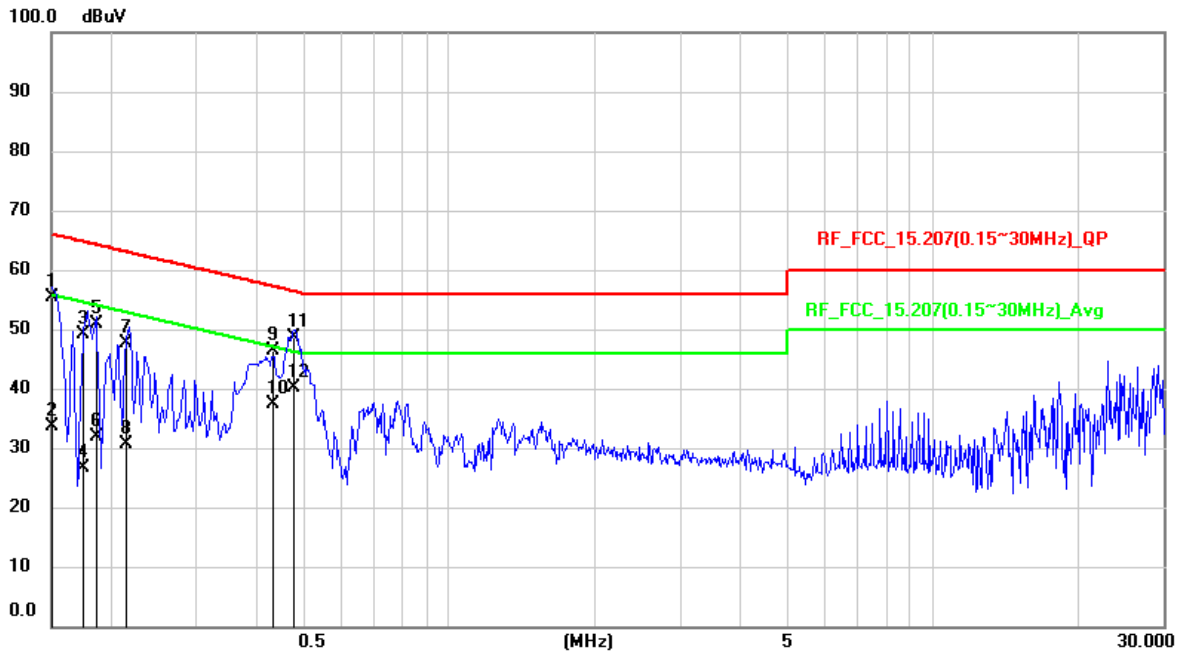

No.	Frequency (MHz)	Reading Level (dBuV)	Correct Factor (dB)	Measurement (dBuV)	Limit (dBuV)	Margin (dB)	Detector
1	0.1512	45.62	9.84	55.46	65.93	-10.47	QP
2	0.1512	23.89	9.84	33.73	55.93	-22.2	AVG
3	0.1734	39.3	9.84	49.14	64.8	-15.66	QP
4	0.1734	16.75	9.84	26.59	54.8	-28.21	AVG
5	0.185	41.03	9.82	50.85	64.26	-13.41	QP
6	0.185	22.12	9.82	31.94	54.26	-22.32	AVG
7	0.2133	37.7	9.82	47.52	63.08	-15.56	QP
8	0.2133	20.69	9.82	30.51	53.08	-22.57	AVG
9	0.4301	36.42	9.84	46.26	57.25	-10.99	QP
10	0.4301	27.51	9.84	37.35	47.25	-9.9	AVG
11	0.4779	38.8	9.84	48.64	56.38	-7.74	QP
12	0.4779	30.19	9.84	40.03	46.38	-6.35	AVG

Remark:

1. QP = Quasi Peak, AVG = Average
2. Correction Factor = Insertion loss of LISN + Cable loss
3. Measurement Value = Reading Level + Correct Factor
4. Margin Level = Measurement Value – Limit Value

Test Voltage :	120Vac, 60Hz	Frequency Range:	0.15-30 MHz
Test Mode :	Transmit (802.11g 6Mbps)	6dB Bandwidth :	9 kHz
Test Date :	2023/09/11	Phase :	N
Temperature :	25.2°C	Humidity :	43 %

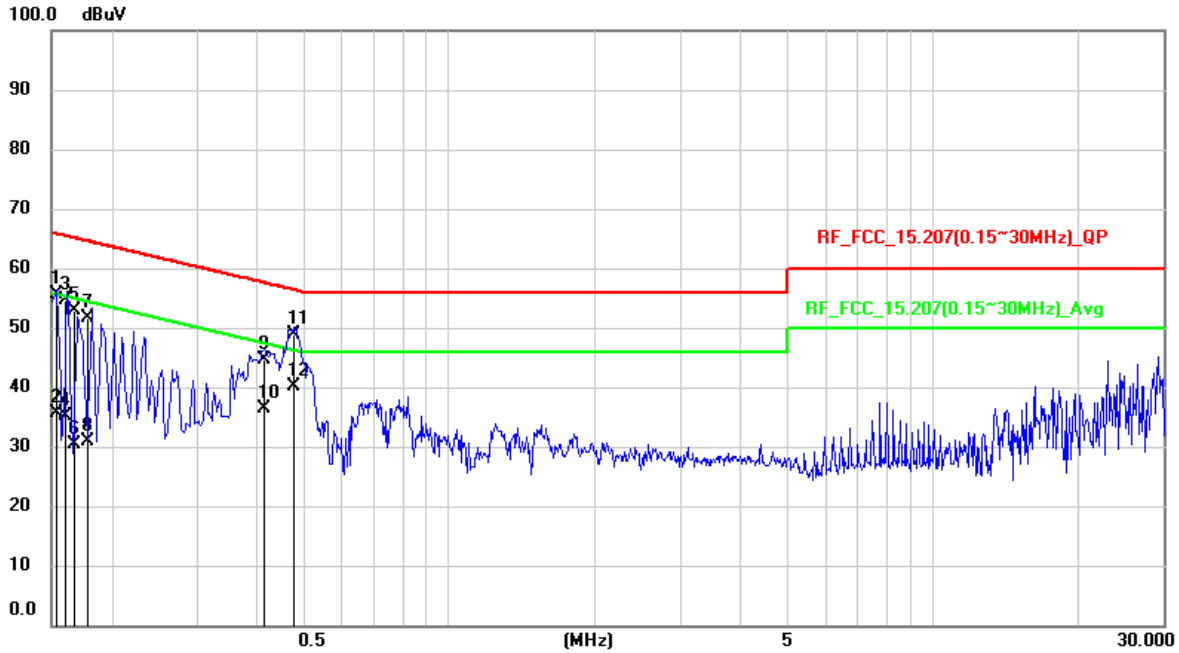

No.	Frequency (MHz)	Reading Level (dBuV)	Correct Factor (dB)	Measurement (dBuV)	Limit (dBuV)	Margin (dB)	Detector
1	0.1541	45.69	9.84	55.53	65.78	-10.25	QP
2	0.1541	25.68	9.84	35.52	55.78	-20.26	AVG
3	0.1601	44.76	9.84	54.6	65.46	-10.86	QP
4	0.1601	25.3	9.84	35.14	55.46	-20.32	AVG
5	0.1666	42.99	9.84	52.83	65.13	-12.3	QP
6	0.1666	20.45	9.84	30.29	55.13	-24.84	AVG
7	0.178	41.7	9.83	51.53	64.58	-13.05	QP
8	0.178	21.09	9.83	30.92	54.58	-23.66	AVG
9	0.4127	34.72	9.84	44.56	57.59	-13.03	QP
10	0.4127	26.53	9.84	36.37	47.59	-11.22	AVG
11	0.4764	39.04	9.84	48.88	56.4	-7.52	QP
12	0.4764	30.23	9.84	40.07	46.4	-6.33	AVG

Remark:

1. QP = Quasi Peak, AVG = Average
2. Correction Factor = Insertion loss of LISN + Cable loss
3. Measurement Value = Reading Level + Correct Factor
4. Margin Level = Measurement Value – Limit Value

--- END ---