FCC Test Report

Report No: WD-RF-R-230316-B0

Product Name : Doorbell
Model Name : DR40
FCC ID : 2AZ3JDR40
Applicant : Rhombus Systems, Inc.
Received Date : Mar. 01, 2023
Tested Date : Sep. 11, 2023 ~ Oct. 16, 2023
Applicable Standard : 47 CFR FCC Part 15, Subpart C (Section 15.247)
KDB 558074 D01 DTS Meas. Guidance v05
ANSI C63.10 : 2013



Wendell Industrial Co., Ltd
Wendell EMC & RF Laboratory

Caution:

This report sets forth our findings solely with respect to the test samples identified herein. The results set forth in this report are not indicative or representative of the quality or characteristics of the lot from which a test sample was taken or any similar or identical product unless specifically and expressly noted.

The test results shown in the test report are traceable to the national/international standard through the calibration report of the equipment.

Please note that the measurement uncertainty are provided for informational purpose only and are not used in determining the Pass/Fail results.

This report must not be used to claim product endorsement by TAF or any agency of the government.

The test report shall not be reproduced without the written approval of Wendell Industrial Co., Ltd..

Test Report

Issued Date: October 16, 2023

Project No.: 22Q090502

| | |
|--|---|
| Product Name | Doorbell |
| Trade Name | rhombus |
| Brand Trademark |  rhombus |
| Model Name | DR40 |
| FCC ID | 2AZ3JDR40 |
| Applicant | Rhombus Systems, Inc. |
| Manufacturer | Dynacolor Inc. |
| EUT Rated Voltage | DC 12V ~ 28V 、 POE 42.5V ~ 57V |
| EUT Test Voltage | AC 120V / 60Hz |
| EUT Supports Radios Application | WLAN 802.11a/b/g 、 WLAN 802.11n (HT20/HT40) WLAN 802.11ac (VHT20/VHT40/VHT80) Bluetooth BR/EDR/LE 、 NFC 13.56 MHz |
| Applicable Standard | 47 CFR FCC Part 15, Subpart C (Section 15.247) KDB 558074 D01 DTS Meas. Guidance v05 ANSI C63.10 : 2013 |
| Output Power | 3.17 dBm |
| Test Result | Complied |

Documented :

(Specialist / Emma Lu)

Technical Engineer :

(Section Manager / Jack Chang)

Approved :

(Project Manager / Gary Wu)

Table of Contents

| | |
|---|-----------|
| Document Revision History | 5 |
| Summary of Test Result | 6 |
| 1 Generation Information | 7 |
| 1.1 Applicant | 7 |
| 1.2 Manufacturer | 7 |
| 1.3 Description of Equipment under Test | 7 |
| 1.4 Test Mode Applicability And Tested Channel Detail | 10 |
| 1.5 Configuration of Tested System | 12 |
| 1.6 EUT Exercise Software | 13 |
| 1.7 Tested System Details | 13 |
| 1.8 Test Facility | 14 |
| 1.9 Measurement Uncertainty | 15 |
| 1.10 List of Test Equipment | 16 |
| 2 Test Result | 20 |
| 2.1 Antenna Requirement | 20 |
| 2.1.1 Applicable Standard | 20 |
| 2.1.2 Antenna Connected Construction | 20 |
| 2.1.3 Antenna Gain | 20 |
| 2.2 Peak Output Power Measurement | 21 |
| 2.2.1 Limit | 21 |
| 2.2.2 Test Setup | 21 |
| 2.2.3 Test Procedure | 21 |
| 2.2.4 Test Result | 21 |
| 2.3 6dB Bandwidth Measurement | 22 |
| 2.3.1 Limit | 22 |
| 2.3.2 Test Setup | 22 |
| 2.3.3 Test Procedure | 22 |
| 2.3.4 Test Result | 23 |
| 2.4 Power Spectral Density Measurement | 24 |
| 2.4.1 Limit | 24 |
| 2.4.2 Test Setup | 24 |
| 2.4.3 Test Procedure | 24 |
| 2.4.4 Test Result | 25 |
| 2.5 Conducted Band Edges and Spurious Emission Measurement | 26 |
| 2.5.1 Limit | 26 |
| 2.5.2 Test Setup | 26 |
| 2.5.3 Test Procedure | 26 |
| 2.5.4 Test Result | 27 |
| 2.6 Radiated Band Edges and Spurious Emission Measurement | 30 |
| 2.6.1 Limit | 30 |
| 2.6.2 Test Setup | 31 |
| 2.6.3 Test Procedure | 32 |
| 2.6.4 Duty Cycle | 34 |
| 2.6.5 Test Result of Radiated Band Edge Measurement | 34 |
| 2.6.6 Test Result of Radiated Spurious Emission Measurement | 39 |
| 2.7 AC Conducted Emissions Measurement | 48 |
| 2.7.1 Limit | 48 |

2.7.2 Test Setup..... 48
2.7.3 Test Procedure..... 49
2.7.4 Test Result 50

Attachment 1: EUT Test Photographs

Attachment 2: EUT Detailed Photographs

Document Revision History

| Report No. | Issue date | Description |
|-------------------|------------------|----------------|
| WD-RF-R-230316-B0 | October 16, 2023 | Initial report |

Summary of Test Result

| Ref. Std. Clause | Test Items | Result |
|---------------------|--|--------|
| 15.203 15.247(C) | Antenna Requirement | Pass |
| 15.247(b) | Peak Output Power | Pass |
| 15.247(a)(2) | 6dB Bandwidth | Pass |
| 15.247(e) | Power Spectral Density | Pass |
| 15.247(d) | Conducted Band Edges and Conducted Spurious Emission | Pass |
| 15.247(d) | Radiated Band Edges and Radiated Spurious Emission | Pass |
| 15.207 | AC Conducted Emission | Pass |

1 Generation Information

1.1 Applicant

Rhombus Systems, Inc.
1920 20th St, Sacramento, CA 95811

1.2 Manufacturer

Dynacolor Inc.
NO. 116 JOU TZ STREET, NEIHU, TAIPEI 114, TAIWAN

1.3 Description of Equipment under Test

| | |
|--|---|
| Product Name | Doorbell |
| Model No. | DR40 |
| FCC ID | 2AZ3JDR40 |
| Frequency Range | 2402 ~ 2480 MHz |
| Number of Channels | 40CH |
| Channel separation | 2 MHz |
| Type of Modulation | GFSK(1 Mbps) |
| Antenna Information | Refer to the table "Antenna List" |
| EUT Supports Radios Application | WLAN 802.11a/b/g WLAN 802.11n (HT20/HT40) WLAN 802.11ac (VHT20/VHT40/VHT80) Bluetooth BR/EDR/LE NFC 13.56 MHz |
| EUT Rated Voltage | DC 12V ~ 28V 、POE 42.5V ~ 57V |
| EUT Test Voltage | AC 120V / 60Hz |

Antenna List

| No. | Manufacturer | Model No. | Antenna Type | Peak Gain |
|-----|--------------|--------------------|---------------|---------------------|
| 1 | INPAQ | RFMTA211200NNLB001 | Metal Antenna | 3.51 dBi for 2.4GHz |

Remark: The antenna of EUT is conforming to FCC 15.203

Channel List

| Channel | Frequency (MHz) | Channel | Frequency (MHz) | Channel | Frequency (MHz) | Channel | Frequency (MHz) |
|---------|-----------------|---------|-----------------|---------|-----------------|---------|-----------------|
| 00 | 2402 | 10 | 2422 | 20 | 2442 | 30 | 2462 |
| 01 | 2404 | 11 | 2424 | 21 | 2444 | 31 | 2464 |
| 02 | 2406 | 12 | 2426 | 22 | 2446 | 32 | 2466 |
| 03 | 2408 | 13 | 2428 | 23 | 2448 | 33 | 2468 |
| 04 | 2410 | 14 | 2430 | 24 | 2450 | 34 | 2470 |
| 05 | 2412 | 15 | 2432 | 25 | 2452 | 35 | 2472 |
| 06 | 2414 | 16 | 2434 | 26 | 2454 | 36 | 2474 |
| 07 | 2416 | 17 | 2436 | 27 | 2456 | 37 | 2476 |
| 08 | 2418 | 18 | 2438 | 28 | 2458 | 38 | 2478 |
| 09 | 2420 | 19 | 2440 | 29 | 2460 | 39 | 2480 |

Test Frequencies in each operating band

| Frequency range over which the device operates in each operating band (Note 1) | Number of test frequencies required | Location of test frequencies inside the operating frequency range (Note 1,2) |
|--|-------------------------------------|--|
| ≤ 1 MHz | 1 | near center |
| > 1 MHz and ≤ 10 MHz | 2 | 1 near high end, 1 near low end |
| > 10 MHz | 3 | 1 near high end, 1 near center, and 1 near low end |

Note 1: The frequency range over which the device operates in a given operating band is the difference between the highest and lowest frequencies on which the device can be tuned within that given operating band. The frequency range can be smaller than or equal to the operating band, but cannot be greater than the operating band.

Note 2: In the third column of table 1, “near” means as close as possible to or at the center / low end / high end of the frequency range over which the device operates.

Firmware / Software Version

| | | |
|----------|------------------------------------|--|
| 1 | Product Name | Doorbell |
| 2 | Model No. | DR40 |
| 3 | Test SW Version | Putty_Ver.0.63 |
| 4 | RF power setting in TEST SW | <input checked="" type="checkbox"/> RF power setting was not able to alter during testing. <input type="checkbox"/> RF power setting was able to alter during testing. (See the following table) |

Parameters of test software setting

| Type of Modulation | Channel | Frequency (MHz) | Set Value |
|--------------------|---------|-----------------|-----------|
| GFSK(1Mbps) | 00 | 2402 | Default |
| | 19 | 2440 | Default |
| | 39 | 2480 | Default |

1.4 Test Mode Applicability And Tested Channel Detail

1. This device is a Doorbell with a built-in Wi-Fi 、Bluetooth and NFC transceiver.
2. These tests were performed on a sample of equipment to demonstrate compliance with 47 CFR FCC Part 15, Subpart C (Section 15.247).
3. The EUT has been pre-tested under the following test modes, and test mode A was the worst case for final test. The EUT has the following different power supply. After laboratory evaluation, the worst mode must be found by pre-test results of radiation 30M-1GHz.

| EUT Configure Mode | RE < 1G | RE ≥ 1G | ACM | ACP | Description |
|--------------------|-------------------------------------|--------------------------|--------------------------|--------------------------|-------------|
| A | <input checked="" type="checkbox"/> | <input type="checkbox"/> | <input type="checkbox"/> | <input type="checkbox"/> | PoE Mode |
| B | <input checked="" type="checkbox"/> | <input type="checkbox"/> | <input type="checkbox"/> | <input type="checkbox"/> | DC Mode |

4. Pre-Scan has been conducted to determine the worst-case mode from all possible combinations between available modulations, data rates, XYZ axis and antenna ports.
5. The worst case was found when positioned on X axis for radiated emission. Following test modes were selected for the final test, and the final worst case is recorded in the report:

| EUT Configure Mode | RE < 1G | RE ≥ 1G | ACM | ACP | Description |
|--------------------|-------------------------------------|-------------------------------------|-------------------------------------|-------------------------------------|---------------------|
| -- | <input checked="" type="checkbox"/> | <input checked="" type="checkbox"/> | <input checked="" type="checkbox"/> | <input checked="" type="checkbox"/> | Transmit BLE(1Mbps) |

Note : RE<1G: Radiated Emission below 1GHz RE≥1G: Radiated Emission above 1GHz
 ACM: Antenna Port Conducted Measurement ACP: AC Power Line Conducted Emission

Following channel(s) was (were) selected for the final test as listed below:

Radiated Spurious Emission Measurement(Below 1GHz):

| EUT Configure Mode | Mode | Available Channel | Tested Channel | Modulation Type | Data Rate (Mbps) |
|--------------------|------|-------------------|----------------|-----------------|------------------|
| -- | BLE | 0 ~ 39 | 19 | GFSK | 1 |

Radiated Spurious Emission Measurement(Above 1GHz):

| EUT Configure Mode | Mode | Available Channel | Tested Channel | Modulation Type | Data Rate (Mbps) |
|--------------------|------|-------------------|----------------|-----------------|------------------|
| -- | BLE | 0 ~ 39 | 0, 19, 39 | GFSK | 1 |

Radiated Band Edge Emission Measurement(Above 1GHz):

| EUT Configure Mode | Mode | Available Channel | Tested Channel | Modulation Type | Data Rate (Mbps) |
|--------------------|------|-------------------|----------------|-----------------|------------------|
| -- | BLE | 0 ~ 39 | 0, 39 | GFSK | 1 |

Peak Output Power, 6dB Bandwidth, Power Spectral Density, Conducted Spurious Emission:

| EUT Configure Mode | Mode | Available Channel | Tested Channel | Modulation Type | Data Rate (Mbps) |
|--------------------|------|-------------------|----------------|-----------------|------------------|
| -- | BLE | 0 ~ 39 | 0, 19, 39 | GFSK | 1 |

Conducted Band Edges:

| EUT Configure Mode | Mode | Available Channel | Tested Channel | Modulation Type | Data Rate (Mbps) |
|--------------------|------|-------------------|----------------|-----------------|------------------|
| -- | BLE | 0 ~ 39 | 0, 39 | GFSK | 1 |

AC Conducted Emission:

| EUT Configure Mode | Mode | Available Channel | Tested Channel | Modulation Type | Data Rate (Mbps) |
|--------------------|------|-------------------|----------------|-----------------|------------------|
| -- | BLE | 0 ~ 39 | 19 | GFSK | 1 |

1.5 Configuration of Tested System

Radiation

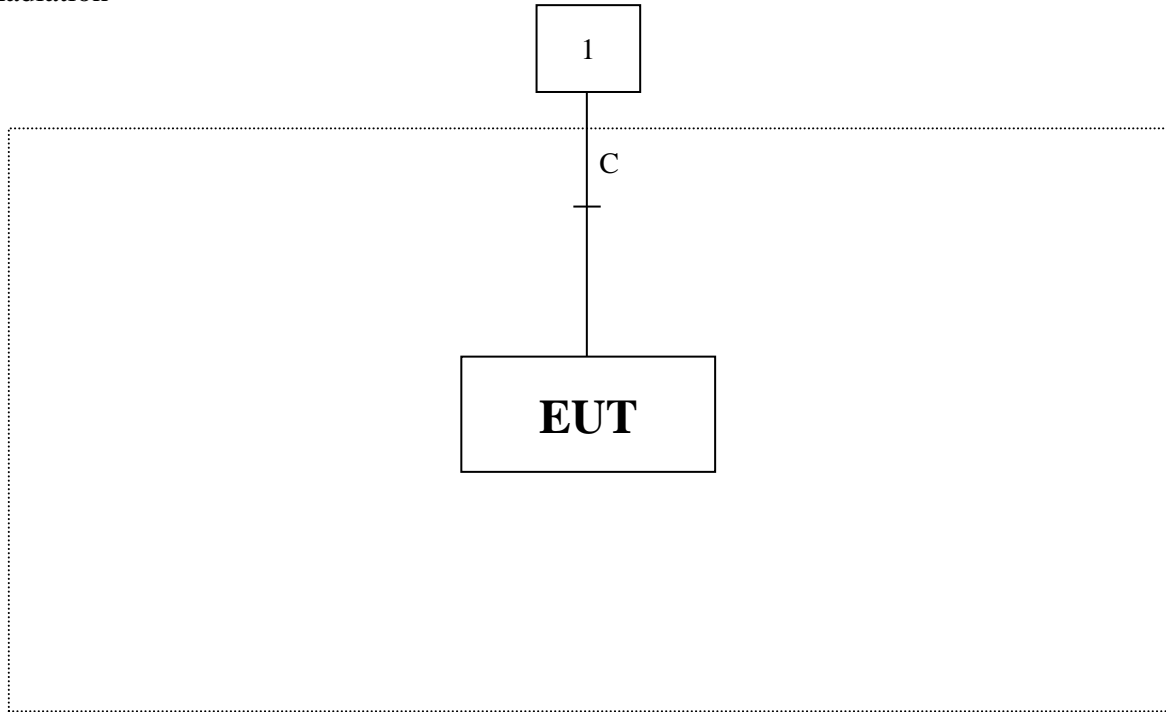

Test Table

AC Conduction

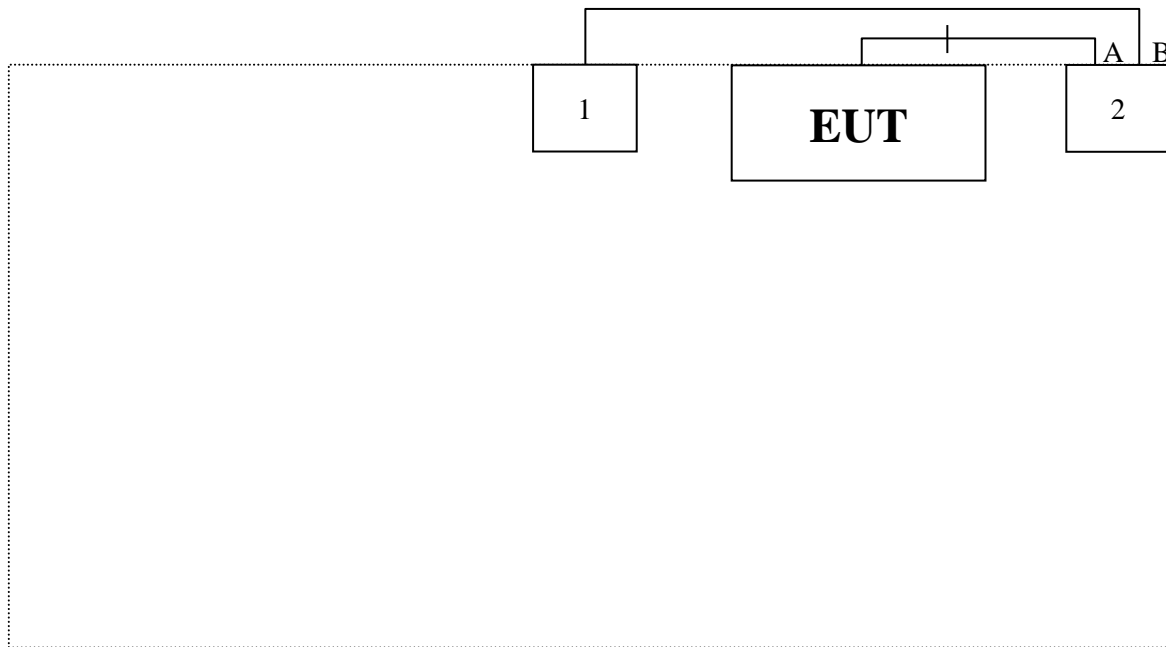

Test Table

1.6 EUT Exercise Software

1. Setup the EUT as shown in Section 1.5
2. Execute software “Putty_Ver.0.63”.
3. Configure the test mode, the test channel, and the data rate.
4. Press “OK” to start the continuous transmit.
5. Verify that the EUT works properly.

1.7 Tested System Details

The types for all equipment, plus descriptions of all cables used in the tested system (including inserted cards) are:

| No. | Product | Manufacturer | Model No. | Serial No. | Power Cord |
|-----|-------------|--------------|-----------|------------------------|------------|
| 1 | Notebook PC | acer | N16Q1 | NXVF4TA023742254147600 | N/A |
| 2 | POE | CERIO | POE-S48V2 | N/A | N/A |

| No. | Signal Cable Type | Signal cable Description |
|-----|-------------------|------------------------------|
| A | LAN Cable | Non-shielded, Non-Core, 1.5m |
| B | LAN Cable | Non-shielded, Non-Core, 1.6m |

1.8 Test Facility

| Items | Required (IEC 60068-1) |
|----------------------------|------------------------|
| Temperature (°C) | 15-35 |
| Humidity (% RH) | 25-75 |
| Barometric pressure (mbar) | 860-1060 |

Description: Accredited by TAF
Accredited Number: 2965

Issued by: Wendell Industrial Co., Ltd

Company Address: 6F/6F-1, No.188, Baoqiao Rd., Xindian Dist.,
New Taipei City 23145, Taiwan R.O.C

Test Lab: Wendell EMC & RF Laboratory

Lab Address: 5F-1, No.188, Baoqiao Rd., Xindian Dist.,
New Taipei City 23145, Taiwan R.O.C

Test Location: No. 119, Wugong 3rd Rd., Wugu Dist.,
New Taipei City 248, Taiwan (R.O.C.)

Designation Number: TW0025

Test Firm Registration Number: 665221

1.9 Measurement Uncertainty

ISO/IEC 17025 requires that an estimate of the measurement uncertainties associated with the emissions test results be included in the report. The measurement uncertainties given below are based on a 95% confidence (level based on a coverage factor K=2)

| Measurement Project | Condition | Expended Uncertainty |
|--------------------------------------|---------------------|----------------------|
| AC Conducted Emission | 0.150 ~ 30 MHz | ± 2.64 dB |
| Radiated Emission | 0.009 ~ 30 MHz | ± 3.7 dB |
| | 30 ~ 1000 MHz | ± 3.9 dB |
| | 1000 ~ 18000 MHz | ± 4.5 dB |
| | 18000 ~ 40000 MHz | ± 4.3 dB |
| RF Power, Conducted | Conducted Measuring | ± 0.75 dB |
| Occupied Bandwidth | Conducted Measuring | ± 2.4 % |
| Power Density | Conducted Measuring | ± 1.2 dB |
| Duty Cycle and Dwell Time | Conducted Measuring | ± 0.9 % |
| Conducted Unwanted Emission Strength | Conducted Measuring | ± 1.4 dB |
| DC Power Supply | -- | ± 2.0 % |
| Temperature | -- | ± 0.55 °C |
| Humidity | -- | ± 3.1 % |

Note: Please note that the measurement uncertainty are provided for informational purpose only and are not used in determining the Pass/Fail results.

1.10 List of Test Equipment

For Conducted measurements / W08-Conducted Measurement

| Equipment | Manufacturer | Model No. | Serial No. | Cal. Date | Due Date |
|--|--------------|------------|------------|------------|------------|
| ✓ Spectrum analyzer | Keysight | N9010A | SG50420005 | 2023/08/08 | 2024/08/07 |
| ✓ Wideband Peak Power Meter | Anritsu | ML2495A | 1733007 | 2023/09/07 | 2024/09/06 |
| ✓ Pulse Power Sensor + Precision Adaptor | Anritsu | MA2411B | 1726022 | 2023/09/07 | 2024/09/06 |
| Temperature Chamber | TAICHY | MHK-225LK | 1061121 | 2023/04/24 | 2024/04/23 |
| Wireless Connectivity Tester | R&S | CMW270 | 101307 | 2023/05/29 | 2024/05/28 |
| ✓ Attenuator | MVE | MVE2211-10 | CT-9-056 | 2022/08/10 | 2024/08/09 |
| Attenuator | MVE | MVE2211-20 | CT-9-057 | 2022/08/10 | 2024/08/09 |
| Attenuator | MVE | MVE2211-30 | CT-9-058 | 2022/08/10 | 2024/08/09 |
| Power Divider | MVE | MVE8546 | 170826003 | 2022/08/10 | 2024/08/09 |
| Power Splitter | MVE | MVE8547 | 170302047 | 2022/08/11 | 2024/08/10 |
| DC Power Supply | GW INSTEK | GPC-3060D | GER817636 | 2023/08/11 | 2024/08/10 |

Remark:

1. The equipments are calibrated every one year.
2. The Attenuator/ Divider/ Splitter are calibrated every two year.
3. The test instruments marked with “✓” are used to measure the final test results.

For AC Conduction measurements / W08-CE

| | Equipment | Manufacturer | Model No. | Serial No. | Cal. Date | Due Date |
|---|------------------------------|-------------------------------|------------------------------|------------|------------|------------|
| ✓ | EMI Test Receiver | R&S | ESR3 | 102309 | 2023/06/19 | 2024/06/18 |
| ✓ | 2-Line V-Network LISN | R&S | ENV216 | 101185 | 2023/06/16 | 2024/06/15 |
| ✓ | LISN | SCHWARZBECK | NSLK 8127RC | 05028 | 2023/06/16 | 2024/06/15 |
| ✓ | Transient Limiter | EM Electronics Corporation | EM-7600 | 857 | 2023/06/17 | 2024/06/16 |
| ✓ | 50ohm Cable | EMCI | EMCCFD300-BM-BM- 5000 | 170612 | 2023/06/17 | 2024/06/16 |
| ✓ | 50 ohm terminal impedance | HUBER+SUHNER | 50 ohm terminal impedance | CT-1-109-1 | 2023/06/16 | 2024/06/15 |

Remark:

1. All equipments are calibrated every one year.
2. The test instruments marked with “✓” are used to measure the final test results.
3. Test Software version: FARAD EZ-EMC Ver.EMC-CON 3A1

For Radiated measurements / W08-996-2

| | Equipment | Manufacturer | Model No. | Serial No. | Cal. Date | Due Date |
|---|----------------------------|--------------|-------------------|-----------------------|------------|------------|
| ✓ | EMI Receiver | Keysight | N9038A | MY51210173 | 2023/08/18 | 2024/08/17 |
| ✓ | Spectrum Analyzer | Keysight | N9010A | MY52220228 | 2023/08/18 | 2024/08/17 |
| ✓ | Active Loop Antenna | Schwarzbeck | FMZB 1513-60B | 00033 | 2023/05/08 | 2024/05/07 |
| ✓ | TRILOG super broad Antenna | Schwarzbeck | VULB 9168 | VULB 9168-700 & 20E03 | 2023/07/31 | 2024/07/30 |
| ✓ | Horn Antenna | Schwarzbeck | BBHA 9120D | 01767 | 2023/08/17 | 2024/08/16 |
| ✓ | Horn Antenna | Schwarzbeck | BBHA 9170 | 703 | 2023/08/21 | 2024/08/20 |
| ✓ | Pre-Amplifier | EM | EMC330 | 060774 | 2023/08/22 | 2024/08/21 |
| ✓ | Pre-Amplifier | EMEC | EM01G18G | 060648 | 2023/08/22 | 2024/08/21 |
| ✓ | Pre-Amplifier | JPT | JPA0118-55-303K | 1910001800055003 | 2023/08/22 | 2024/08/21 |
| ✓ | Pre-Amplifier | EMCI | EMC184045SE | 980515 | 2023/08/22 | 2024/08/21 |
| ✓ | Cable | EMEC | EM-CB400 | 105060103 | 2023/08/22 | 2024/08/21 |
| ✓ | Cable | EMEC | EM-CB400 | 105060102 | 2023/08/22 | 2024/08/21 |
| ✓ | Cable | EMEC | EM-CB400 | 105060101 | 2023/08/22 | 2024/08/21 |
| ✓ | RF Cable | HUBER+SUHNER | SF102 | MY2752/2 | 2023/08/22 | 2024/08/21 |
| ✓ | RF Cable | MVE | 280280.LL266.1200 | B60028C | 2023/08/22 | 2024/08/21 |
| ✓ | RF Cable | EMCI | EMC102-KM-KM-600 | 190646 | 2023/08/22 | 2024/08/21 |
| ✓ | RF Cable | MVE | 140140.LL404.700 | B90014C | 2023/08/22 | 2024/08/21 |
| ✓ | RF Cable | MVE | 140140.LL404.300 | B90006C | 2023/08/22 | 2024/08/21 |
| ✓ | RF Filter | EMEC | BRF-2400-2500 | 002 | 2022/08/17 | 2024/08/16 |
| | RF Filter | EMEC | BRF-5150-5350 | 104 | 2022/08/17 | 2024/08/16 |
| | RF Filter | EMEC | BRF-5470-5725 | 092 | 2022/08/17 | 2024/08/16 |
| | RF Filter | EMEC | BRF-5725-5875 | 091 | 2022/08/17 | 2024/08/16 |
| ✓ | RF Filter | EMEC | HPF-2800 | 002 | 2022/08/17 | 2024/08/16 |
| | RF Filter | EMEC | HPF-5850 | 059 | 2022/08/17 | 2024/08/16 |
| | SMA Notch Filter | MVE | MFN-902.928.S1 | 190604001 | 2022/08/17 | 2024/08/16 |

Remark:

1. The equipments are calibrated every one year.
2. The Filter calibrated every two year.
3. The test instruments marked with “✓” are used to measure the final test results.
4. Test Software version: FARAD EZ-EMC Ver.WD-03A1-1

2 Test Result

2.1 Antenna Requirement

2.1.1 Applicable Standard

An intentional radiator shall be designed to ensure that no antenna other than that furnished by the responsible party shall be used with the device. The use of a permanently attached antenna or of an antenna that uses a unique coupling to the intentional radiator shall be considered sufficient to comply with the provisions of this section. The manufacturer may design the unit so that a broken antenna can be replaced by the user, but the use of a standard antenna jack or electrical connector is prohibited.

An intentional radiator shall be designed to ensure that no antenna other than as furnished by the responsible party shall be used with the device. If transmitting antennas of directional gain greater than 6dBi are using the power shall be reduced by the amount in dB that the directional gain of the antenna exceeds 6 dBi, for compliance to FCC 47CFR 15.247 (c) requirements.

2.1.2 Antenna Connected Construction

Non-standard antenna connector is used.

2.1.3 Antenna Gain

| No. | Manufacturer | Model No. | Antenna Type | Peak Gain |
|-----|--------------|--------------------|---------------|---------------------|
| 1 | INPAQ | RFMTA211200NNLB001 | Metal Antenna | 3.51 dBi for 2.4GHz |

2.2 Peak Output Power Measurement

2.2.1 Limit

For systems using digital modulation in the 2400-2483.5MHz, the limit for peak output power is 1W. If transmitting antenna of directional gain greater than 6dBi is used, the peak output power from the intentional radiator shall be reduced below the above stated value by the amount in dB that the directional gain of the antenna exceeds 6 dBi. In case of point-to-point operation, the limit has to be reduced by 1dB for every 3dB that the directional gain of the antenna exceeds 6dBi.

2.2.2 Test Setup

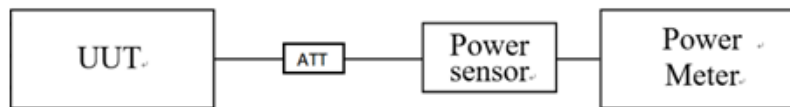

2.2.3 Test Procedure

1. Reference ANSI C63.10 : 2013 chapter 11.9.1.3
2. Enable the EUT transmit continuously.
3. Let EUT be connected to the power meter, and record the max. reading.
4. Measurement using a gated RF average power meter, since this measurement is made only during the ON time of the transmitter, no duty cycle correction is required.

2.2.4 Test Result

| Protocol | Channel | Frequency (MHz) | Peak Power (dBm) | Limit (dBm) | Result |
|------------|---------|-----------------|------------------|-------------|--------|
| BLE 1 Mbps | 00 | 2402 | 3.17 | ≤ 30 | Pass |
| | 19 | 2440 | 3.01 | ≤ 30 | Pass |
| | 39 | 2480 | 2.11 | ≤ 30 | Pass |

Remark:

1. Peak Power = Reading value on power meter + cable loss
2. $10 \text{ Log}(X/\text{mW}) = \text{dBm}$, $X=1 \text{ watt (Limit)}$
 $1 \text{ watt} = 30 \text{ dBm}$

2.3 6dB Bandwidth Measurement

2.3.1 Limit

The minimum 6 dB bandwidth shall be at least 500 kHz.

2.3.2 Test Setup



2.3.3 Test Procedure

1. Reference ANSI C63.10 : 2013 chapter 11.8.2
2. Enable the EUT transmit continuously.
3. Spectrum analyzer set:
 - a) RBW = 100 kHz
 - b) VBW \geq 3 RBW
 - c) Detector = peak
 - d) Sweep time = auto couple
 - e) Trace mode = max hold.

2.3.4 Test Result

| Protocol | Channel | Frequency (MHz) | 6dB BW (kHz) | Limit (kHz) | Result |
|----------|---------|-----------------|--------------|-------------|--------|
| BLE | 00 | 2402 | 708.200 | ≥ 500 | Pass |
| | 19 | 2440 | 705.000 | | Pass |
| | 39 | 2480 | 711.600 | | Pass |

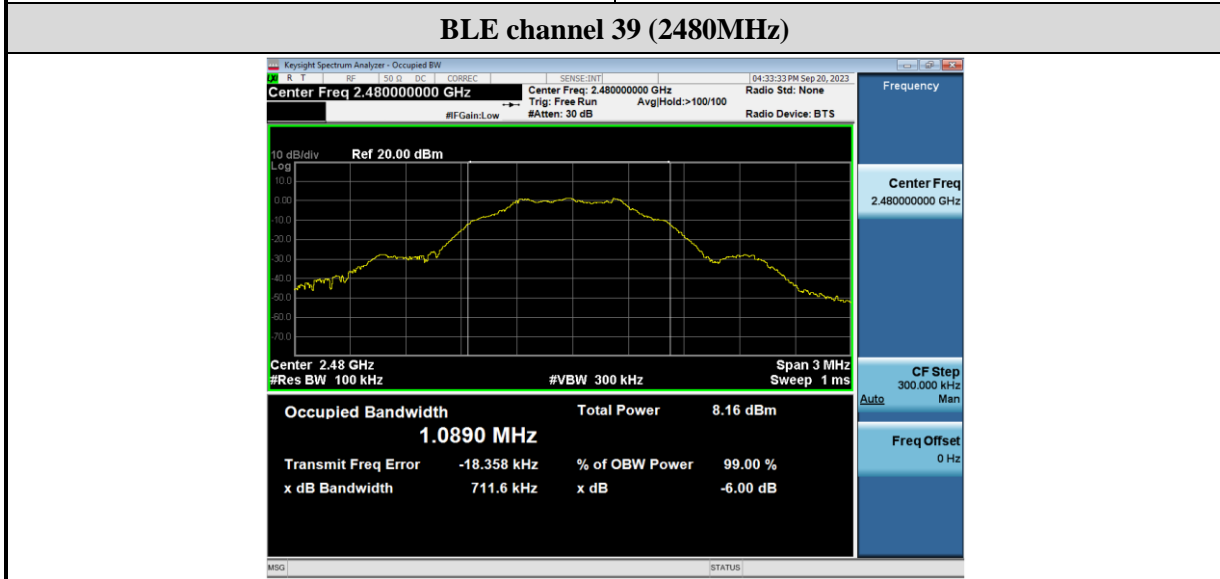
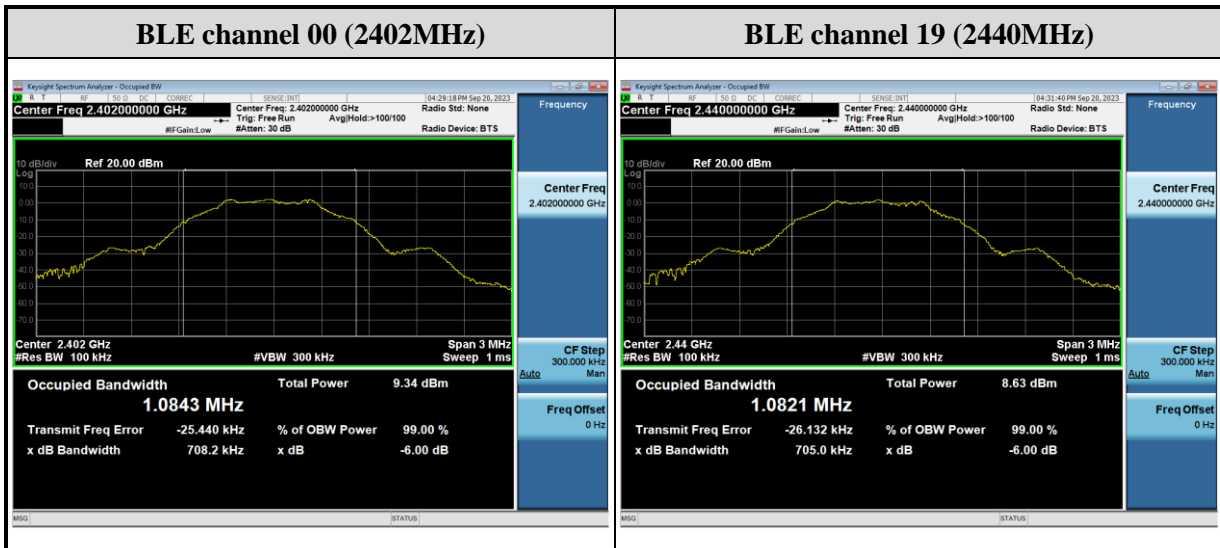

2.4 Power Spectral Density Measurement

2.4.1 Limit

The peak power spectral density shall not be greater than 8dBm in any 3kHz band at any time interval of continuous transmission.

2.4.2 Test Setup



2.4.3 Test Procedure

1. Reference ANSI C63.10 : 2013 chapter 11.10.2
2. Enable the EUT transmit continuously.
3. Spectrum analyzer set:
 - a) RBW = 3 kHz ~ 100 kHz
 - b) VBW \geq 3 RBW
 - c) Span = 1.5 times DTS Channel 6dB Bandwidth
 - d) Detector = peak
 - e) Sweep time = auto couple
 - f) Trace mode = max hold.

2.4.4 Test Result

| Protocol | Channel | Frequency (MHz) | PSD (dBm) | Limit (dBm) | Result |
|----------|---------|-----------------|-----------|-------------|--------|
| BLE | 00 | 2402 | -11.292 | ≤ 8 | Pass |
| | 19 | 2440 | -11.902 | | Pass |
| | 39 | 2480 | -12.319 | | Pass |

Remark: PSD = Reading value on spectrum analyzer + cable loss

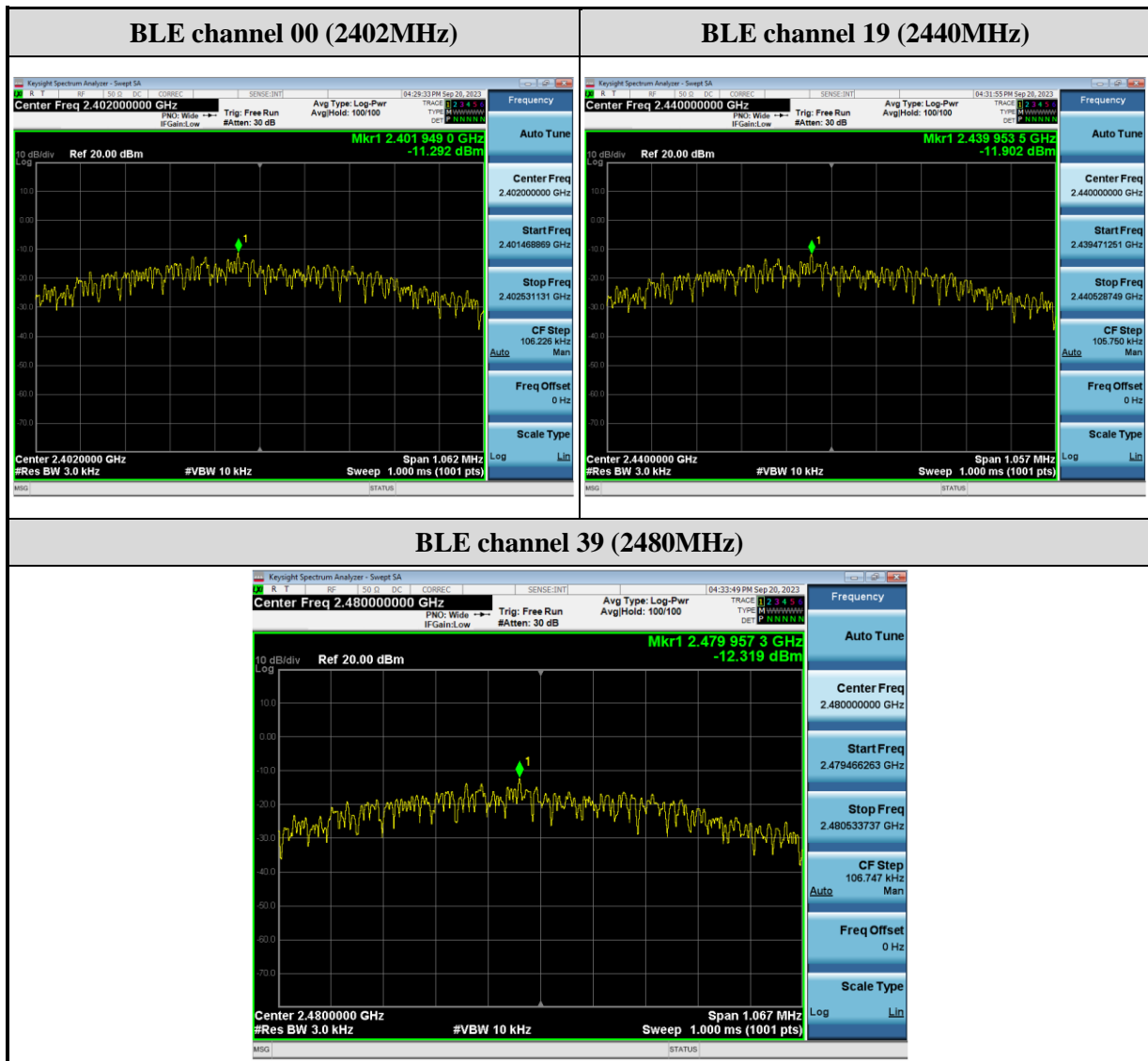

2.5 Conducted Band Edges and Spurious Emission Measurement

2.5.1 Limit

In any 100 KHz bandwidth outside the frequency bands in which the spread spectrum intentional radiator is operating, the radio frequency power that is produced by the intentional radiator shall be at least 20dB below that in the 100KHz bandwidth within the band that contains the highest level of the desired power, In addition, radiated emissions which fall in the restricted bands, as defined in must also comply with the radiated emission limits. If the transmitter complies with the conducted power limits based on the use of RMS averaging over a time interval, the attenuation required under this paragraph shall be 30 dB instead of 20 dB

2.5.2 Test Setup



2.5.3 Test Procedure

1. Reference ANSI C63.10 : 2013 chapter 6.10
2. Enable the EUT transmit continuously.
3. Spectrum analyzer set :
 - a) RBW = 100 kHz
 - b) VBW \geq 3 RBW
 - c) Detector = peak
 - d) Sweep time = auto couple
 - e) Trace mode = max hold.

2.5.4 Test Result



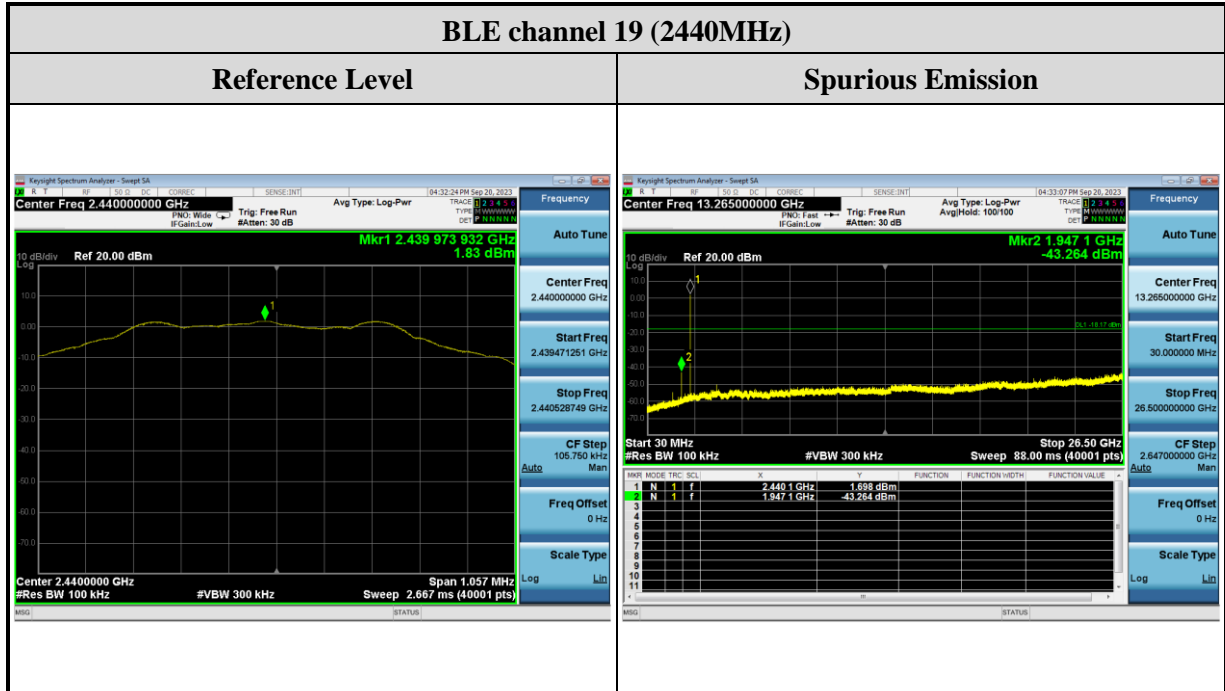

BLE channel 39 (2480MHz)

Reference Level

Spurious Emission

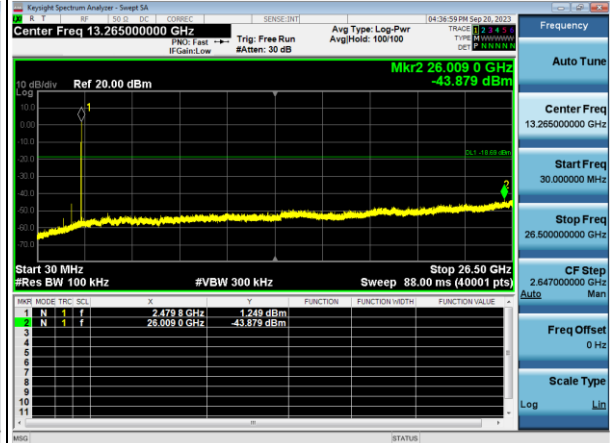

Band Edge

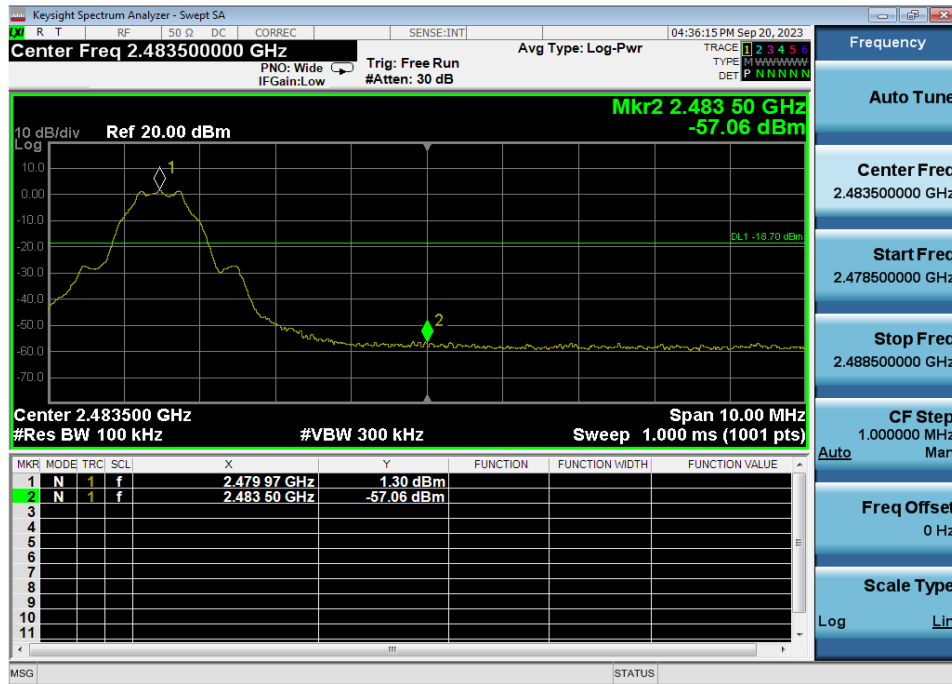

2.6 Radiated Band Edges and Spurious Emission Measurement

2.6.1 Limit

| Frequency (MHz) | Field Strength ($\mu\text{V/m}$) | Measurement Distance (m) |
|-----------------|------------------------------------|--------------------------|
| 0.009 – 0.490 | 2400/F(kHz) | 300 |
| 0.490 – 1.705 | 24000/F(kHz) | 30 |
| 1.705 – 30.0 | 30 | 30 |
| 30 – 88 | 100 | 3 |
| 88 – 216 | 150 | 3 |
| 216 - 960 | 200 | 3 |
| Above 960 | 500 | 3 |

Remarks:

1. RF Voltage (dBuV) = $20 \log$ RF Voltage(uV)
2. In the Above Table, the tighter limit applies at the band edges.
3. Distance refers to the distance in meters between the measuring instrument antenna and the closed point of any part of the device or system

2.6.2 Test Setup

Below 30MHz

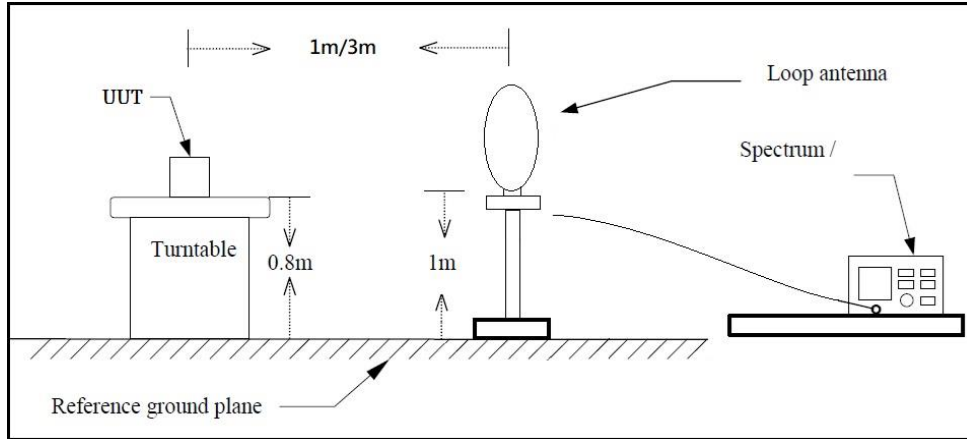

30MHz~1GHz

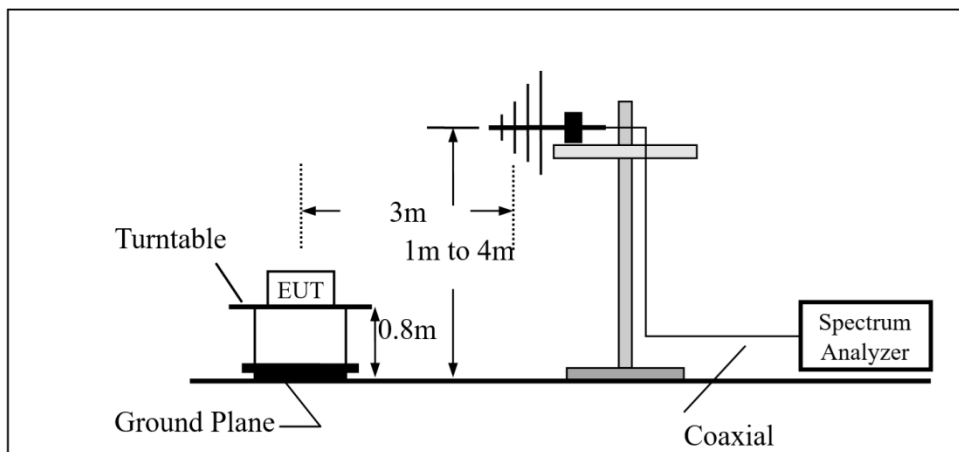

Above 1GHz

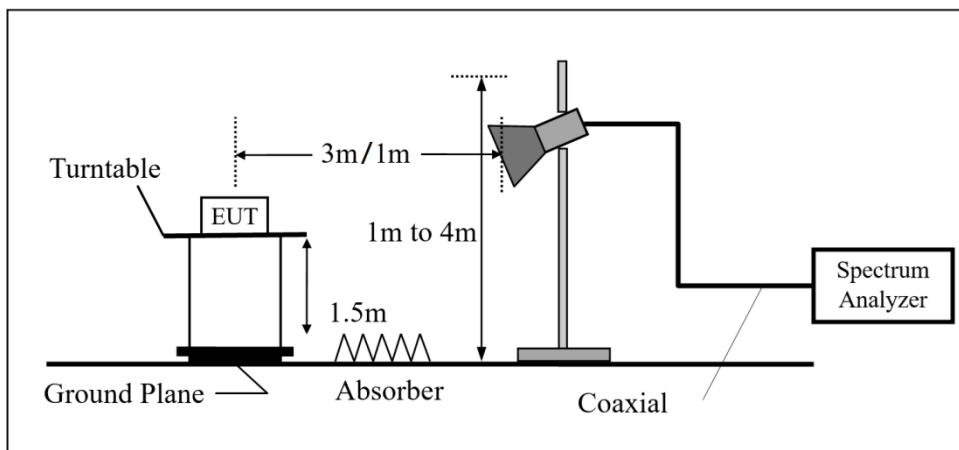

2.6.3 Test Procedure

The EUT was setup according to ANSI C63.10 : 2013 chapter 6.4, 6.5, 6.6 and tested according test procedure of KDB 558074 for compliance to FCC 47CFR 15.247 requirements.

- (1) The EUT was placed on the top of a rotating table 0.8 meters (for below 1GHz) / 1.5 meters (for above 1GHz) above the ground at 3 meters chamber room for the test. The table was rotated 360 degrees to determine the position of the highest radiation.
- (2) The EUT was set 3 meters away from the interference-receiving antenna, the height of the antenna is varied from 1 meter to 4 meters above the ground to determine the maximum value of the field strength.
- (3) Parallel, perpendicular, and ground-parallel orientations of the antenna are set to make the measurement.
- (4) For each suspected emission, the EUT was arranged to its worst case and the rotatable table was turned from 0 degrees to 360 degrees to find the maximum reading.
- (5) The test-receiver system was set to quasi-peak detect function and specified bandwidth with maximum hold mode when the test frequency is below 1 GHz.
- (6) The test-receiver system was set to peak and average detect function and specified bandwidth with maximum hold mode when the test frequency is above 1 GHz. If the peak reading value also meets the average limit, measurement with the average detector is unnecessary.

Remarks:

- (a) The resolution bandwidth and video bandwidth of test receiver/spectrum analyzer is 120kHz for Quasi-peak detection at frequency below 1GHz.
- (b) The resolution bandwidth of test receiver/spectrum analyzer is 1MHz and video bandwidth is 3MHz for Peak detection at frequency above 1GHz.
- (c) The resolution bandwidth of test receiver/spectrum analyzer is 1MHz and the video bandwidth is $\geq 1/T$ (Duty cycle < 98%) or 10Hz(Duty cycle > 98%) for Average detection (AV) at frequency above 1GHz.
- (d) All modes of operation were investigated and the worst-case emissions are reported.

For Radiated emission below 30MHz

- (1) The EUT was placed on the top of a rotating table 0.8 meters above the ground in a 3 meter chamber room. The table was rotated 360 degrees to determine the position of the highest radiation.
- (2) The EUT was set 3 meters away from the interference-receiving antenna, which was mounted on the top of a variable-height antenna tower.
- (3) Parallel, perpendicular, and ground-parallel orientations of the antenna are set to make the measurement.
- (4) For each suspected emission, the EUT was arranged to its worst case and the rotatable table was turned from 0 degrees to 360 degrees to find the maximum reading.
- (5) The test-receiver system was set to Quasi-Peak Detect Function and Specified Bandwidth with Maximum Hold Mode.

For Radiated emission Above 30MHz

- (7) The EUT was placed on the top of a rotating table 0.8 meters (for below 1GHz) / 1.5 meters (for above 1GHz) above the ground at 3 meter chamber room for the test. The table was rotated 360 degrees to determine the position of the highest radiation.
- (8) The EUT was set 3 meters away from the interference-receiving antenna, the height of the antenna is varied from 1 meter to 4 meters above the ground to determine the maximum value of the field strength.
- (9) Parallel, perpendicular, and ground-parallel orientations of the antenna are set to make the measurement.
- (10) For each suspected emission, the EUT was arranged to its worst case and the rotatable table was turned from 0 degrees to 360 degrees to find the maximum reading.
- (11) The test-receiver system was set to quasi-peak detect function and specified bandwidth with maximum hold mode when the test frequency is below 1 GHz.
- (12) The test-receiver system was set to peak and average detect function and specified bandwidth with maximum hold mode when the test frequency is above 1 GHz. If the peak reading value also meets the average limit, measurement with the average detector is unnecessary.

2.6.4 Duty Cycle

| Protocol | Frequency (MHz) | on time (ms) | on+off time (ms) | Duty cycle | Duty Factor (dB) | 1/T Minimum VBW (kHz) |
|----------|-----------------|--------------|------------------|------------|------------------|-----------------------|
| BLE | 2402 | 0.412 | 0.632 | 0.652 | 1.858 | 2.427 |

2.6.5 Test Result of Radiated Band Edge Measurement

The following tables for radiated measurement, pre-scanned in three orthogonal panels, X, Y, Z. The worst cases (X axis) were recorded in this report.

| Test Frequency | |
|----------------|----------------|
| RF | BLE |
| Tx | CH00 (2402MHz) |
| | CH39 (2480MHz) |

| | | | |
|-----------------------|---------------------|----------------------------|------------|
| Test Mode : | Transmit BLE(1Mbps) | Test Date : | 2023/09/19 |
| Test Channel : | CH00(2402MHz) | Temperature : | 22.3 °C |
| Polarization : | Horizontal | Relative Humidity : | 41.5 % |

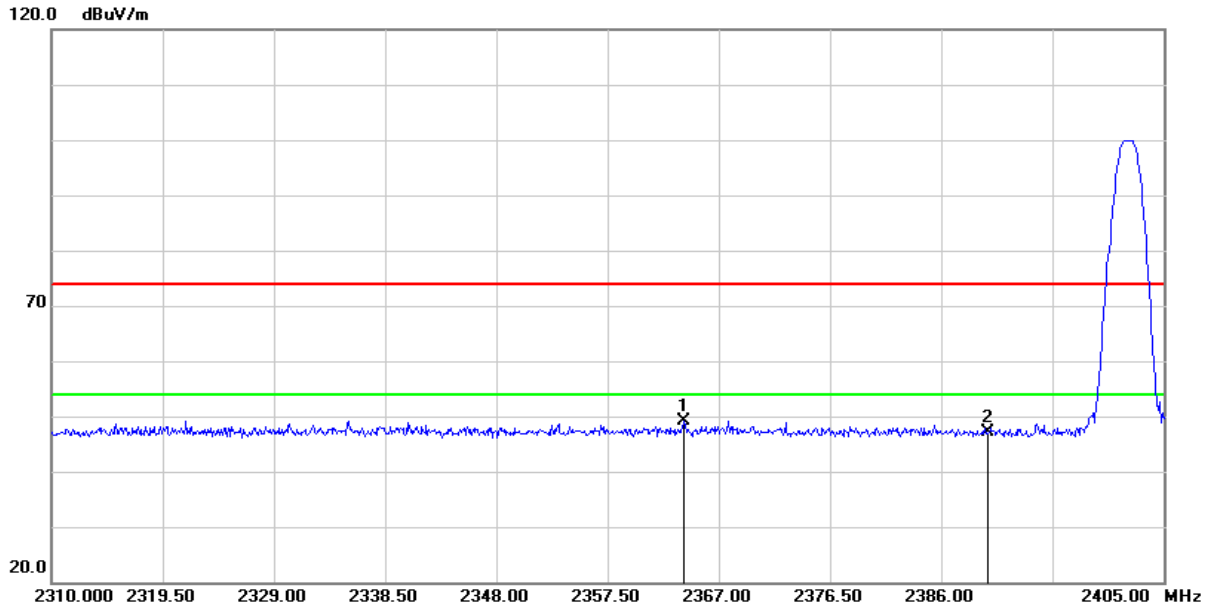

| No. | Frequency (MHz) | Reading (dBuV/m) | Correct Factor (dB/m) | Result (dBuV/m) | Limit (dBuV/m) | Margin (dB) | Remark |
|-----|-----------------|------------------|-----------------------|-----------------|----------------|-------------|--------|
| 1 | 2364.055 | 54.85 | -5.70 | 49.15 | 74.00 | -24.85 | peak |
| 2 | 2390.000 | 52.82 | -5.69 | 47.13 | 74.00 | -26.87 | peak |

Remark :

1. Correction Factor = Antenna factor + Cable loss – Amplifier gain
2. Result Value = Reading Level + Correct Factor
3. Margin Level = Result Value – Limit Value
4. The other emission levels were very low against the limit

| | | | |
|-----------------------|---------------------|----------------------------|------------|
| Test Mode : | Transmit BLE(1Mbps) | Test Date : | 2023/09/19 |
| Test Channel : | CH00(2402MHz) | Temperature : | 22.3 °C |
| Polarization : | Vertical | Relative Humidity : | 41.5 % |

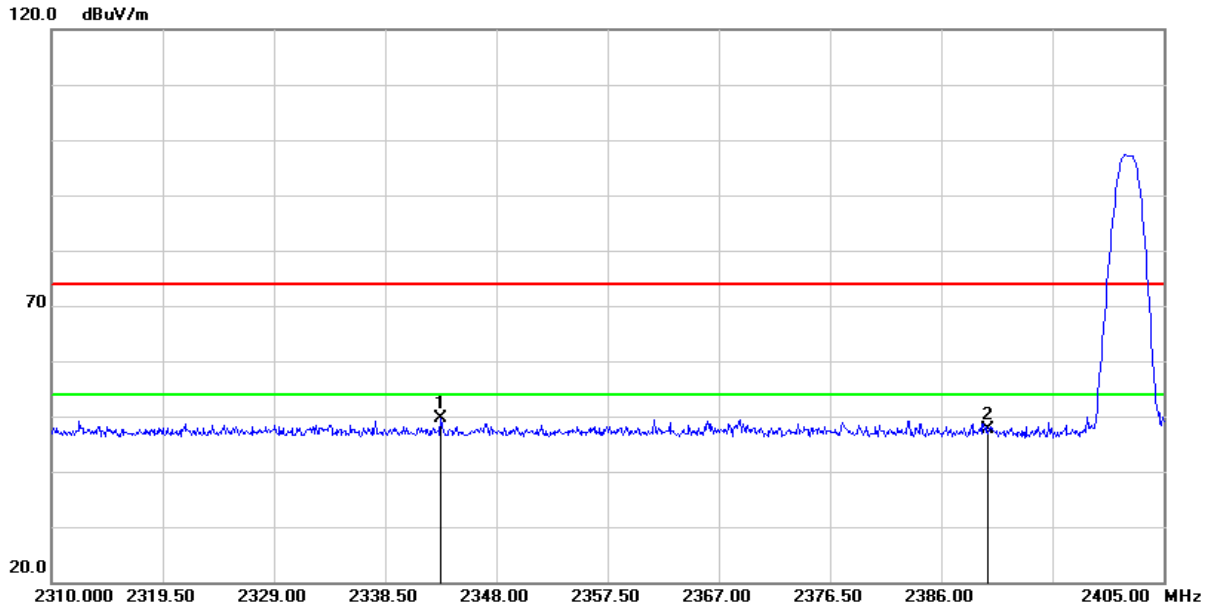

| No. | Frequency (MHz) | Reading (dBuV/m) | Correct Factor (dB/m) | Result (dBuV/m) | Limit (dBuV/m) | Margin (dB) | Remark |
|-----|-----------------|------------------|-----------------------|-----------------|----------------|-------------|--------|
| 1 | 2343.250 | 55.37 | -5.71 | 49.66 | 74.00 | -24.34 | peak |
| 2 | 2390.000 | 53.21 | -5.69 | 47.52 | 74.00 | -26.48 | peak |

Remark :

1. Correction Factor = Antenna factor + Cable loss – Amplifier gain
2. Result Value = Reading Level + Correct Factor
3. Margin Level = Result Value – Limit Value
4. The other emission levels were very low against the limit

| | | | |
|-----------------------|---------------------|----------------------------|------------|
| Test Mode : | Transmit BLE(1Mbps) | Test Date : | 2023/09/19 |
| Test Channel : | CH39(2480MHz) | Temperature : | 22.3 °C |
| Polarization : | Horizontal | Relative Humidity : | 41.5 % |

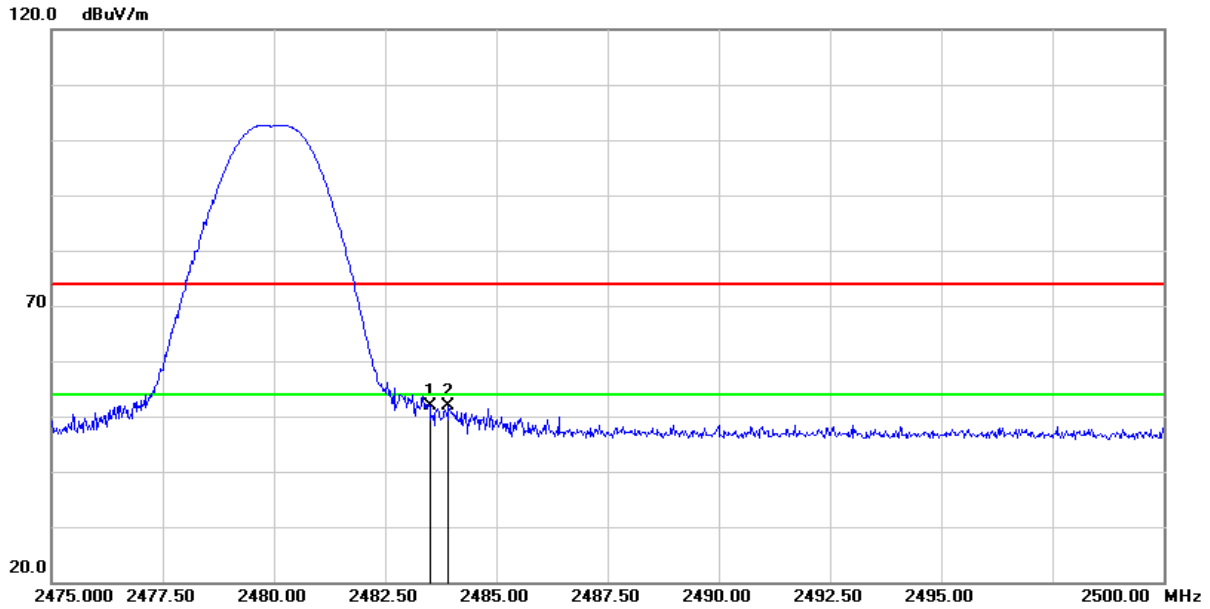

| No. | Frequency (MHz) | Reading (dBuV/m) | Correct Factor (dB/m) | Result (dBuV/m) | Limit (dBuV/m) | Margin (dB) | Remark |
|-----|-----------------|------------------|-----------------------|-----------------|----------------|-------------|--------|
| 1 | 2483.500 | 57.66 | -5.81 | 51.85 | 74.00 | -22.15 | peak |
| 2 | 2483.925 | 57.68 | -5.81 | 51.87 | 74.00 | -22.13 | peak |

Remark :

1. Correction Factor = Antenna factor + Cable loss – Amplifier gain
2. Result Value = Reading Level + Correct Factor
3. Margin Level = Result Value – Limit Value
4. The other emission levels were very low against the limit

| | | | |
|-----------------------|---------------------|----------------------------|------------|
| Test Mode : | Transmit BLE(1Mbps) | Test Date : | 2023/09/19 |
| Test Channel : | CH39(2480MHz) | Temperature : | 22.3 °C |
| Polarization : | Vertical | Relative Humidity : | 41.5 % |

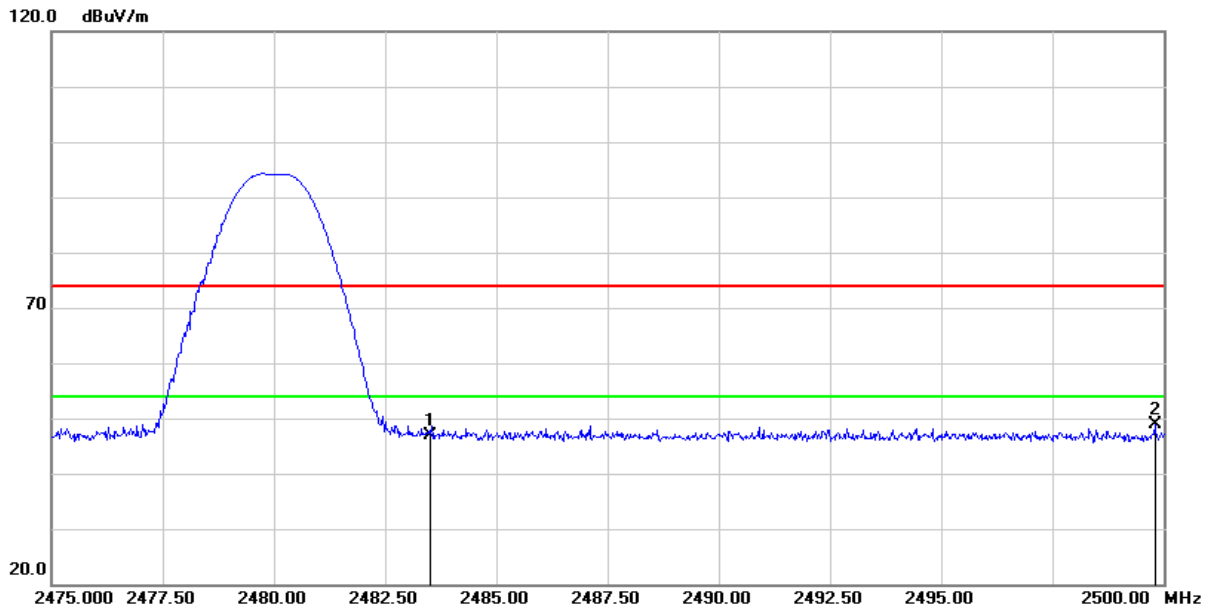

| No. | Frequency (MHz) | Reading (dBuV/m) | Correct Factor (dB/m) | Result (dBuV/m) | Limit (dBuV/m) | Margin (dB) | Remark |
|-----|-----------------|------------------|-----------------------|-----------------|----------------|-------------|--------|
| 1 | 2483.500 | 52.71 | -5.81 | 46.90 | 74.00 | -27.10 | peak |
| 2 | 2499.800 | 54.64 | -5.80 | 48.84 | 74.00 | -25.16 | peak |

Remark :

1. Correction Factor = Antenna factor + Cable loss – Amplifier gain
2. Result Value = Reading Level + Correct Factor
3. Margin Level = Result Value – Limit Value
4. The other emission levels were very low against the limit

2.6.6 Test Result of Radiated Spurious Emission Measurement

- (1) The radiation measurement frequency is 9kHz ~ 30MHz. The interference value of this frequency range is less than the limit value of 20 dB. It is considered that the background noise value is not recorded.
- (2) The following table shows the radiation measurement frequency from 30MHz to 26.5GHz, pre-scanning in the X, Y and Z axes. The worst case (**X**-axis) is documented in this report.

| Test Frequency | |
|----------------|----------------|
| RF | BLE |
| Tx | CH00 (2402MHz) |
| | CH19 (2440MHz) |
| | CH39 (2480MHz) |

Above 1GHz Data

| | | | |
|-----------------------|---------------------|----------------------------|------------|
| Test Mode : | Transmit BLE(1Mbps) | Test Date : | 2023/09/19 |
| Test Channel : | CH00(2402MHz) | Temperature : | 22.3 °C |
| Polarization : | Horizontal | Relative Humidity : | 41.5 % |

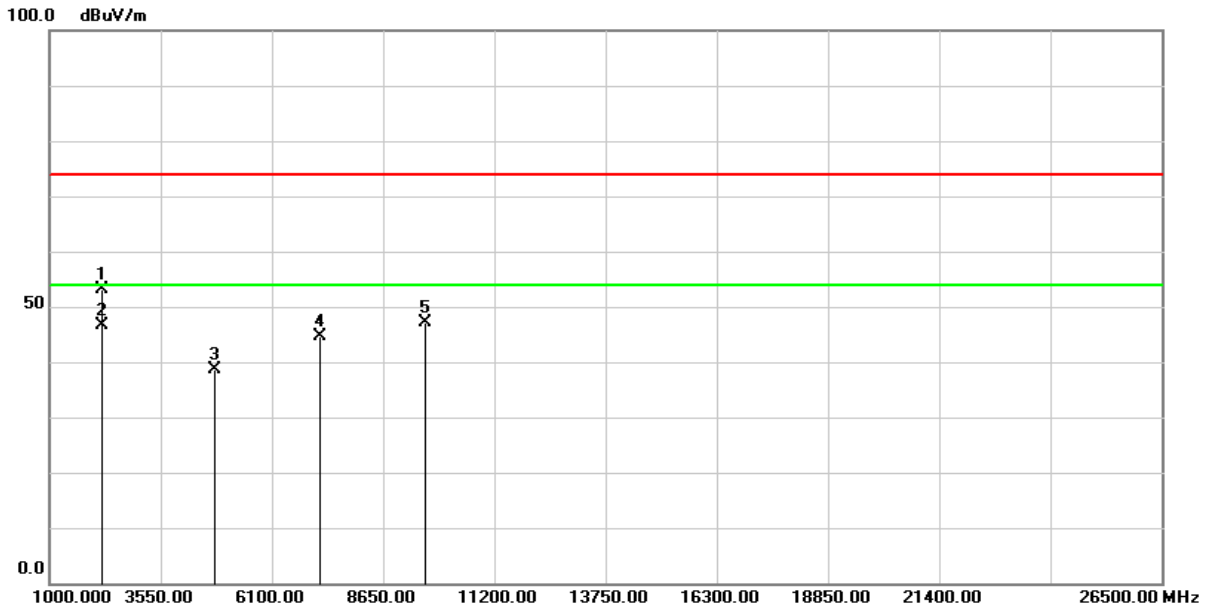

| No. | Frequency (MHz) | Reading (dBuV/m) | Correct Factor (dB/m) | Result (dBuV/m) | Limit (dBuV/m) | Margin (dB) | Remark |
|-----|-----------------|------------------|-----------------------|-----------------|----------------|-------------|--------|
| 1 | 2180.000 | 80.85 | -27.78 | 53.07 | 74.00 | -20.93 | peak |
| 2 | 2180.000 | 74.30 | -27.78 | 46.52 | 54.00 | -7.48 | AVG |
| 3 | 4804.000 | 57.66 | -19.02 | 38.64 | 74.00 | -35.36 | peak |
| 4 | 7206.000 | 57.70 | -13.10 | 44.60 | 74.00 | -29.40 | peak |
| 5 | 9608.000 | 56.06 | -8.93 | 47.13 | 74.00 | -26.87 | peak |

Remark :

1. Correction Factor = Antenna factor + Cable loss – Amplifier gain
2. Result Value = Reading Level + Correct Factor
3. Margin Level = Result Value – Limit Value
4. The other emission levels were very low against the limit

| | | | |
|-----------------------|---------------------|----------------------------|------------|
| Test Mode : | Transmit BLE(1Mbps) | Test Date : | 2023/09/19 |
| Test Channel : | CH00(2402MHz) | Temperature : | 22.3 °C |
| Polarization : | Vertical | Relative Humidity : | 41.5 % |

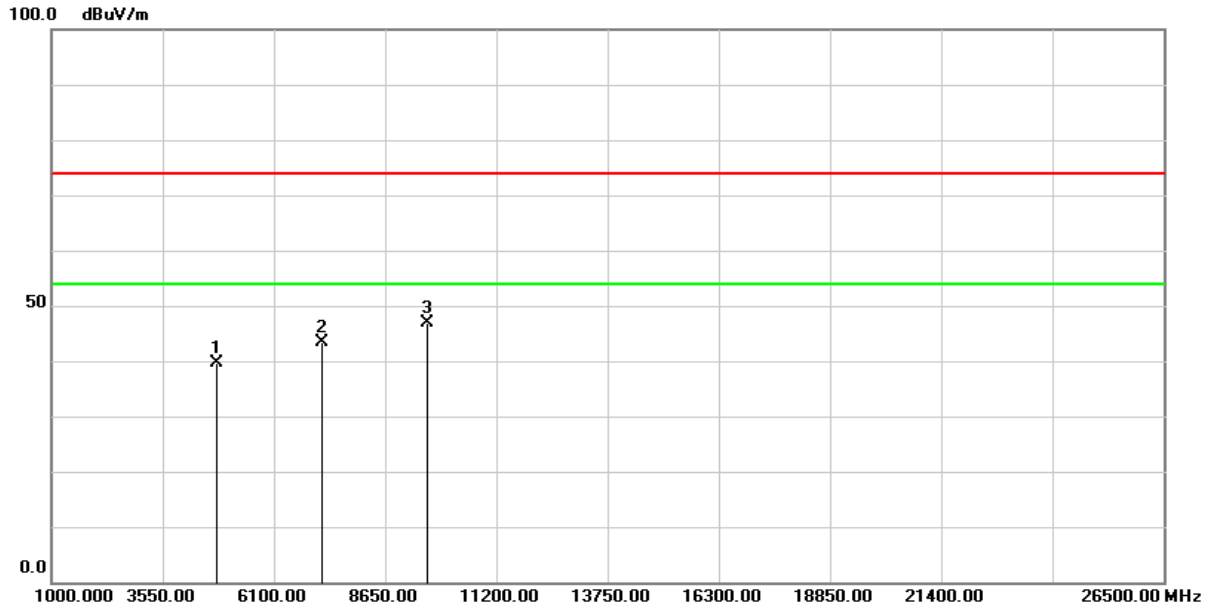

| No. | Frequency (MHz) | Reading (dBuV/m) | Correct Factor (dB/m) | Result (dBuV/m) | Limit (dBuV/m) | Margin (dB) | Remark |
|-----|-----------------|------------------|-----------------------|-----------------|----------------|-------------|--------|
| 1 | 4804.000 | 58.75 | -19.02 | 39.73 | 74.00 | -34.27 | peak |
| 2 | 7206.000 | 56.56 | -13.10 | 43.46 | 74.00 | -30.54 | peak |
| 3 | 9608.000 | 55.78 | -8.93 | 46.85 | 74.00 | -27.15 | peak |

Remark :

1. Correction Factor = Antenna factor + Cable loss – Amplifier gain
2. Result Value = Reading Level + Correct Factor
3. Margin Level = Result Value – Limit Value
4. The other emission levels were very low against the limit

| | | | |
|-----------------------|---------------------|----------------------------|------------|
| Test Mode : | Transmit BLE(1Mbps) | Test Date : | 2023/09/19 |
| Test Channel : | CH19(2440MHz) | Temperature : | 22.3 °C |
| Polarization : | Horizontal | Relative Humidity : | 41.5 % |

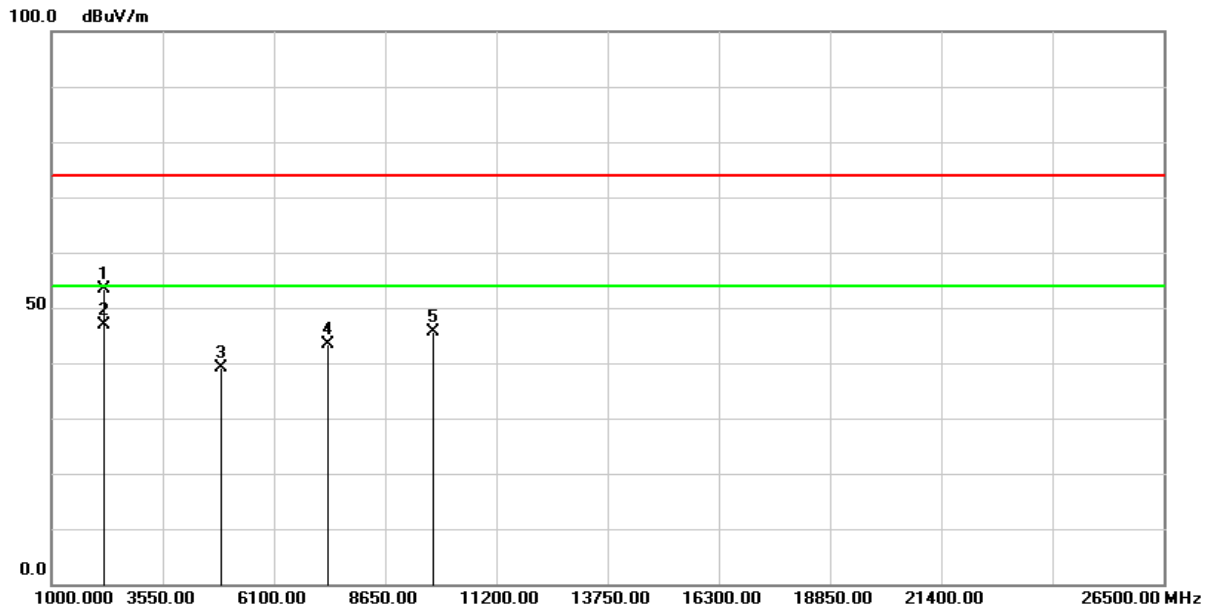

| No. | Frequency (MHz) | Reading (dBuV/m) | Correct Factor (dB/m) | Result (dBuV/m) | Limit (dBuV/m) | Margin (dB) | Remark |
|-----|-----------------|------------------|-----------------------|-----------------|----------------|-------------|--------|
| 1 | 2184.000 | 81.24 | -27.74 | 53.50 | 74.00 | -20.50 | peak |
| 2 | 2184.000 | 74.51 | -27.74 | 46.77 | 54.00 | -7.23 | AVG |
| 3 | 4880.000 | 58.21 | -19.01 | 39.20 | 74.00 | -34.80 | peak |
| 4 | 7320.000 | 55.82 | -12.50 | 43.32 | 74.00 | -30.68 | peak |
| 5 | 9760.000 | 54.49 | -8.74 | 45.75 | 74.00 | -28.25 | peak |

Remark :

1. Correction Factor = Antenna factor + Cable loss – Amplifier gain
2. Result Value = Reading Level + Correct Factor
3. Margin Level = Result Value – Limit Value
4. The other emission levels were very low against the limit

| | | | |
|-----------------------|---------------------|----------------------------|------------|
| Test Mode : | Transmit BLE(1Mbps) | Test Date : | 2023/09/19 |
| Test Channel : | CH19(2440MHz) | Temperature : | 22.3 °C |
| Polarization : | Vertical | Relative Humidity : | 41.5 % |

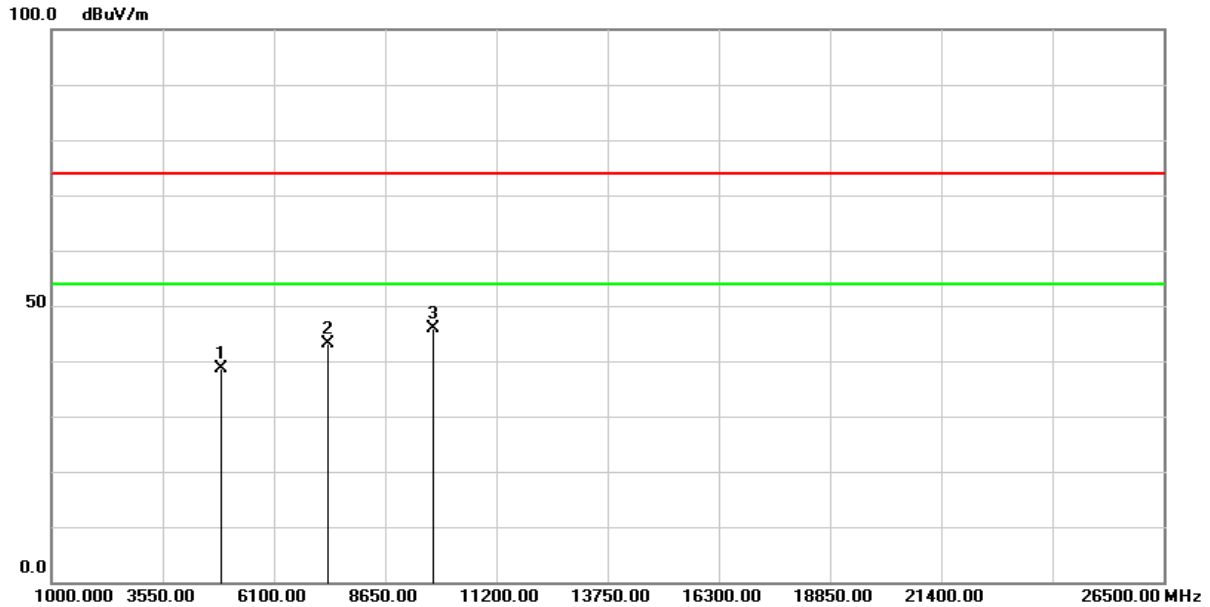

| No. | Frequency (MHz) | Reading (dBuV/m) | Correct Factor (dB/m) | Result (dBuV/m) | Limit (dBuV/m) | Margin (dB) | Remark |
|-----|-----------------|------------------|-----------------------|-----------------|----------------|-------------|--------|
| 1 | 4880.000 | 57.74 | -19.01 | 38.73 | 74.00 | -35.27 | peak |
| 2 | 7320.000 | 55.75 | -12.50 | 43.25 | 74.00 | -30.75 | peak |
| 3 | 9760.000 | 54.58 | -8.74 | 45.84 | 74.00 | -28.16 | peak |

Remark :

1. Correction Factor = Antenna factor + Cable loss – Amplifier gain
2. Result Value = Reading Level + Correct Factor
3. Margin Level = Result Value – Limit Value
4. The other emission levels were very low against the limit

| | | | |
|-----------------------|---------------------|----------------------------|------------|
| Test Mode : | Transmit BLE(1Mbps) | Test Date : | 2023/09/19 |
| Test Channel : | CH39(2480MHz) | Temperature : | 22.3 °C |
| Polarization : | Horizontal | Relative Humidity : | 41.5 % |

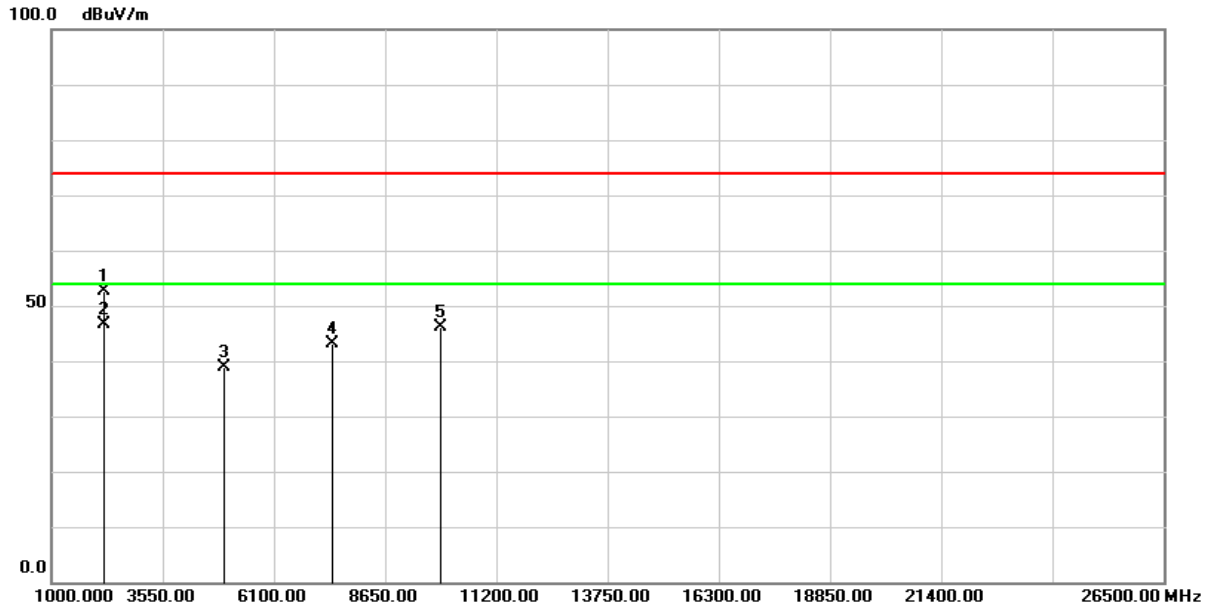

| No. | Frequency (MHz) | Reading (dBuV/m) | Correct Factor (dB/m) | Result (dBuV/m) | Limit (dBuV/m) | Margin (dB) | Remark |
|-----|-----------------|------------------|-----------------------|-----------------|----------------|-------------|--------|
| 1 | 2184.000 | 80.37 | -27.74 | 52.63 | 74.00 | -21.37 | peak |
| 2 | 2184.000 | 74.26 | -27.74 | 46.52 | 54.00 | -7.48 | AVG |
| 3 | 4960.000 | 57.86 | -18.93 | 38.93 | 74.00 | -35.07 | peak |
| 4 | 7440.000 | 55.40 | -12.27 | 43.13 | 74.00 | -30.87 | peak |
| 5 | 9920.000 | 54.85 | -8.71 | 46.14 | 74.00 | -27.86 | peak |

Remark :

1. Correction Factor = Antenna factor + Cable loss – Amplifier gain
2. Result Value = Reading Level + Correct Factor
3. Margin Level = Result Value – Limit Value
4. The other emission levels were very low against the limit

| | | | |
|-----------------------|---------------------|----------------------------|------------|
| Test Mode : | Transmit BLE(1Mbps) | Test Date : | 2023/09/19 |
| Test Channel : | CH39(2480MHz) | Temperature : | 22.3 °C |
| Polarization : | Vertical | Relative Humidity : | 41.5 % |

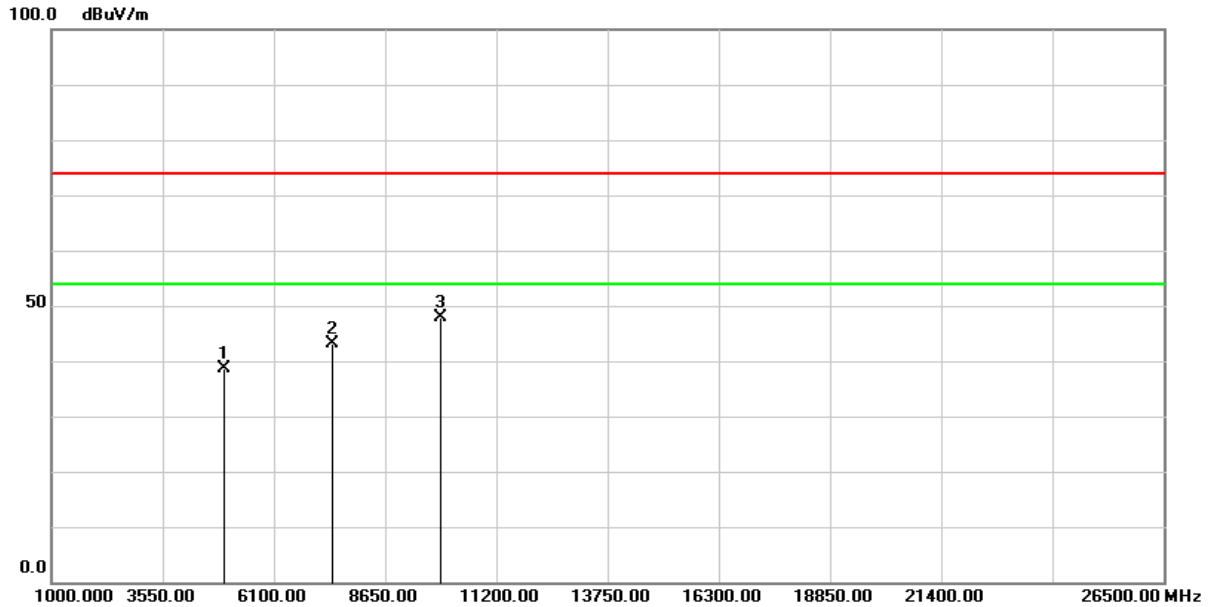

| No. | Frequency (MHz) | Reading (dBuV/m) | Correct Factor (dB/m) | Result (dBuV/m) | Limit (dBuV/m) | Margin (dB) | Remark |
|-----|-----------------|------------------|-----------------------|-----------------|----------------|-------------|--------|
| 1 | 4960.000 | 57.66 | -18.93 | 38.73 | 74.00 | -35.27 | peak |
| 2 | 7440.000 | 55.35 | -12.27 | 43.08 | 74.00 | -30.92 | peak |
| 3 | 9920.000 | 56.50 | -8.71 | 47.79 | 74.00 | -26.21 | peak |

Remark :

1. Correction Factor = Antenna factor + Cable loss – Amplifier gain
2. Result Value = Reading Level + Correct Factor
3. Margin Level = Result Value – Limit Value
4. The other emission levels were very low against the limit

Below 1GHz Data

| | | | |
|-----------------------|---------------------|----------------------------|------------|
| Test Mode : | Transmit BLE(1Mbps) | Test Date : | 2023/09/19 |
| Test Channel : | CH19(2440MHz) | Temperature : | 22.3 °C |
| Polarization : | Horizontal | Relative Humidity : | 41.5 % |

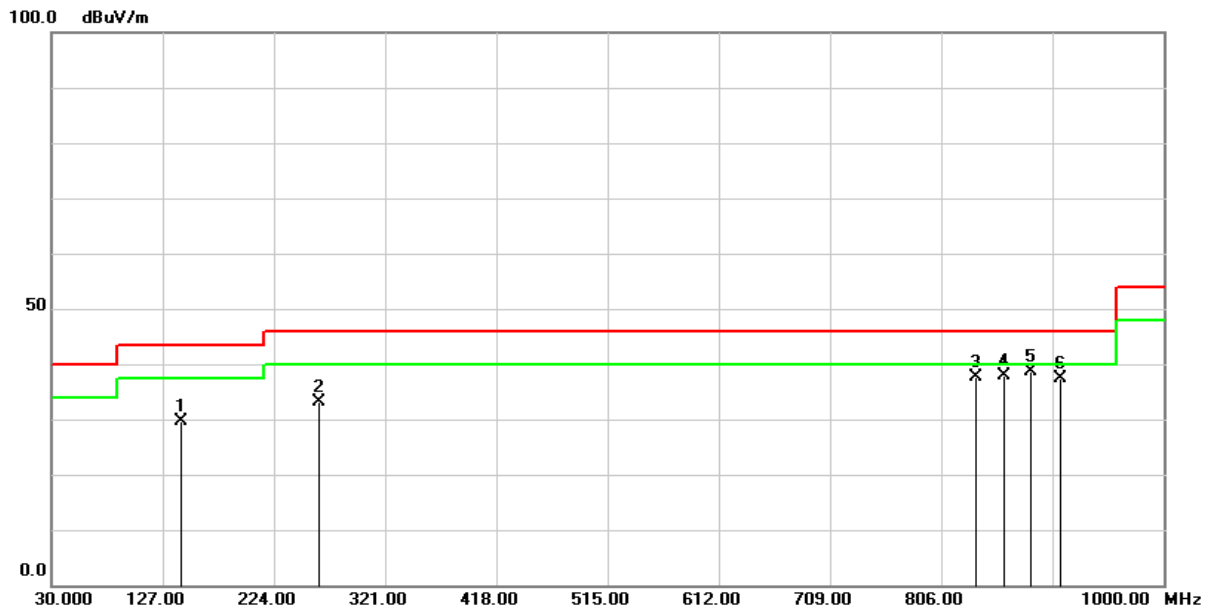

| No. | Frequency (MHz) | Reading (dBuV/m) | Correct Factor (dB/m) | Result (dBuV/m) | Limit (dBuV/m) | Margin (dB) | Remark |
|-----|-----------------|------------------|-----------------------|-----------------|----------------|-------------|--------|
| 1 | 143.4900 | 41.17 | -11.48 | 29.69 | 43.50 | -13.81 | QP |
| 2 | 263.7700 | 44.53 | -11.49 | 33.04 | 46.00 | -12.96 | QP |
| 3 | 836.0700 | 35.29 | 2.27 | 37.56 | 46.00 | -8.44 | QP |
| 4 | 860.3200 | 35.23 | 2.61 | 37.84 | 46.00 | -8.16 | QP |
| 5 | 884.5700 | 35.88 | 2.81 | 38.69 | 46.00 | -7.31 | QP |
| 6 | 909.7900 | 33.87 | 3.52 | 37.39 | 46.00 | -8.61 | QP |

Remark :

1. Correction Factor = Antenna factor + Cable loss – Amplifier gain
2. Result Value = Reading Level + Correct Factor
3. Margin Level = Result Value – Limit Value
4. The other emission levels were very low against the limit

| | | | |
|-----------------------|---------------------|----------------------------|------------|
| Test Mode : | Transmit BLE(1Mbps) | Test Date : | 2023/09/19 |
| Test Channel : | CH19(2440MHz) | Temperature : | 22.3 °C |
| Polarization : | Vertical | Relative Humidity : | 41.5 % |

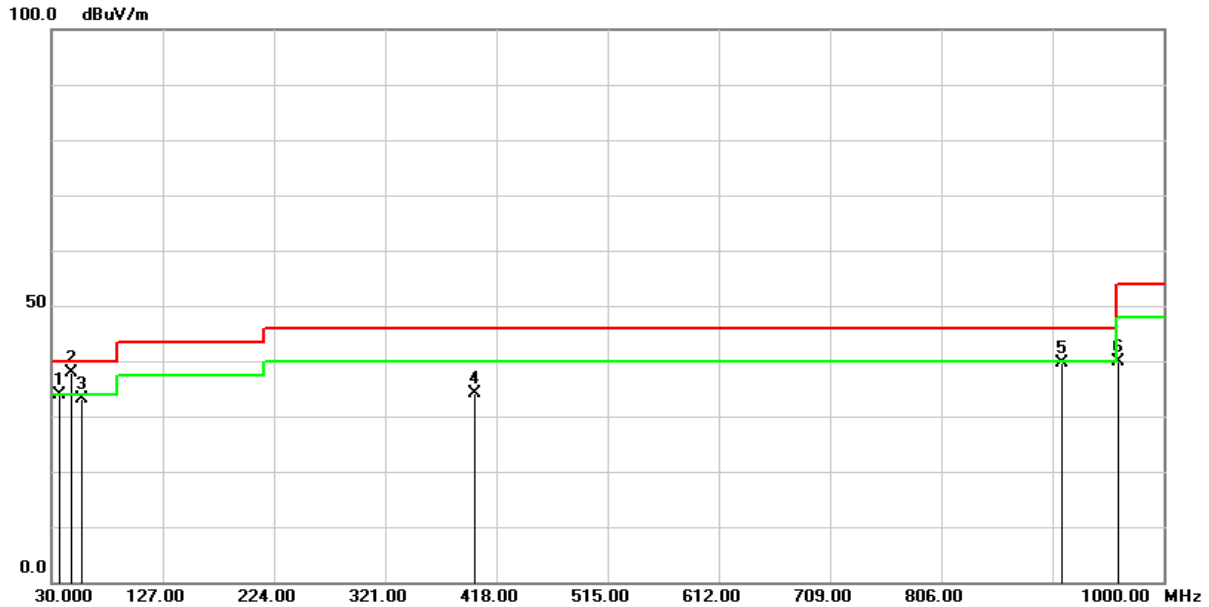

| No. | Frequency (MHz) | Reading (dBuV/m) | Correct Factor (dB/m) | Result (dBuV/m) | Limit (dBuV/m) | Margin (dB) | Remark |
|-----|-----------------|------------------|-----------------------|-----------------|----------------|-------------|--------|
| 1 | 37.3650 | 46.50 | -12.50 | 34.00 | 40.00 | -6.00 | QP |
| 2 | 47.7980 | 48.69 | -10.76 | 37.93 | 40.00 | -2.07 | QP |
| 3 | 56.0140 | 43.84 | -10.64 | 33.20 | 40.00 | -6.80 | QP |
| 4 | 398.6000 | 41.52 | -7.28 | 34.24 | 46.00 | -11.76 | QP |
| 5 | 911.7300 | 36.09 | 3.57 | 39.66 | 46.00 | -6.34 | QP |
| 6 | 960.2300 | 35.20 | 4.58 | 39.78 | 53.90 | -14.12 | QP |

Remark :

1. Correction Factor = Antenna factor + Cable loss – Amplifier gain
2. Result Value = Reading Level + Correct Factor
3. Margin Level = Result Value – Limit Value
4. The other emission levels were very low against the limit

2.7 AC Conducted Emissions Measurement

2.7.1 Limit

| Frequency (MHz) | FCC Part 15 Subpart C Paragraph 15.207 (dB μ V) Limit | |
|-----------------|---|-----------|
| | Quasi-peak | Average |
| 0.15 to 0.5 | 66 to 56* | 56 to 46* |
| 0.50 to 5.0 | 56 | 46 |
| 5.0 to 30.0 | 60 | 50 |

*Decreases with the logarithm of the frequency

2.7.2 Test Setup

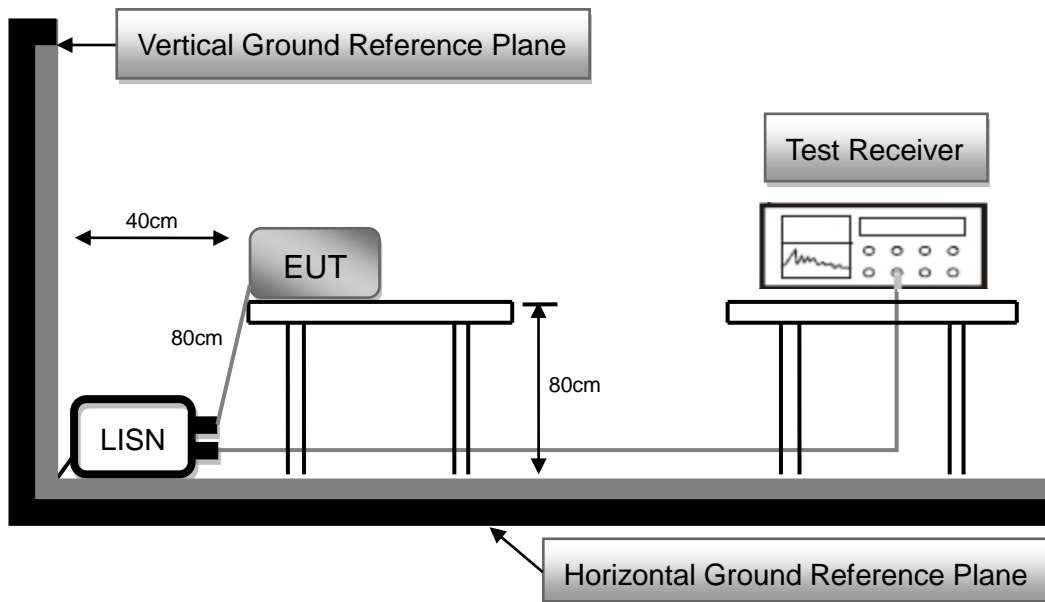

2.7.3 Test Procedure

1. Reference ANSI C63.10 : 2013 chapter 6.2
2. The EUT was placed 0.8 meter height wooden table from the horizontal ground plane with EUT being connected to power source through a line impedance stabilization network (LISN). The LISN at least be 80 cm from nearest chassis of EUT.
3. The line impedance stabilization network (LISN) provides 50 ohm/50uH of coupling impedance for the measuring instrument. All other support equipments powered from additional LISN(s).
4. Interrelating cables that hang closer than 40 cm to the ground plane shall be folded back and forth in the center forming a bundle. All I/O cables were positioned to simulate typical usage.
5. All I/O cables that are not connected to a peripheral shall be bundle in the center. The end of the cable may be terminated, if required, using the correct terminating impedance. The overall length shall not exceed 1 m.
6. The EMI test receiver connected to LISN powering the EUT. The actual test configuration, please refer to EUT test photos.
7. The receiver scanned from 150kHz to 30MHz for emissions in each of test modes. Conducted emissions were invested over the frequency range from 0.15MHz to 30MHz using a receiver bandwidth of 9kHz. A scan was taken on both power lines, Line and Neutral, recording at least six highest emissions.
8. The EUT and cable configuration of the above highest emission levels were recorded. The Test Data of the worst case was recorded.

2.7.4 Test Result

| | | | |
|-----------------------|---------------------|-------------------------|-------------|
| Test Voltage : | 120Vac, 60Hz | Frequency Range: | 0.15-30 MHz |
| Test Mode : | Transmit BLE(1Mbps) | 6dB Bandwidth : | 9 kHz |
| Test Date : | 2023/09/11 | Phase : | L |
| Temperature : | 25.2°C | Humidity : | 43 % |

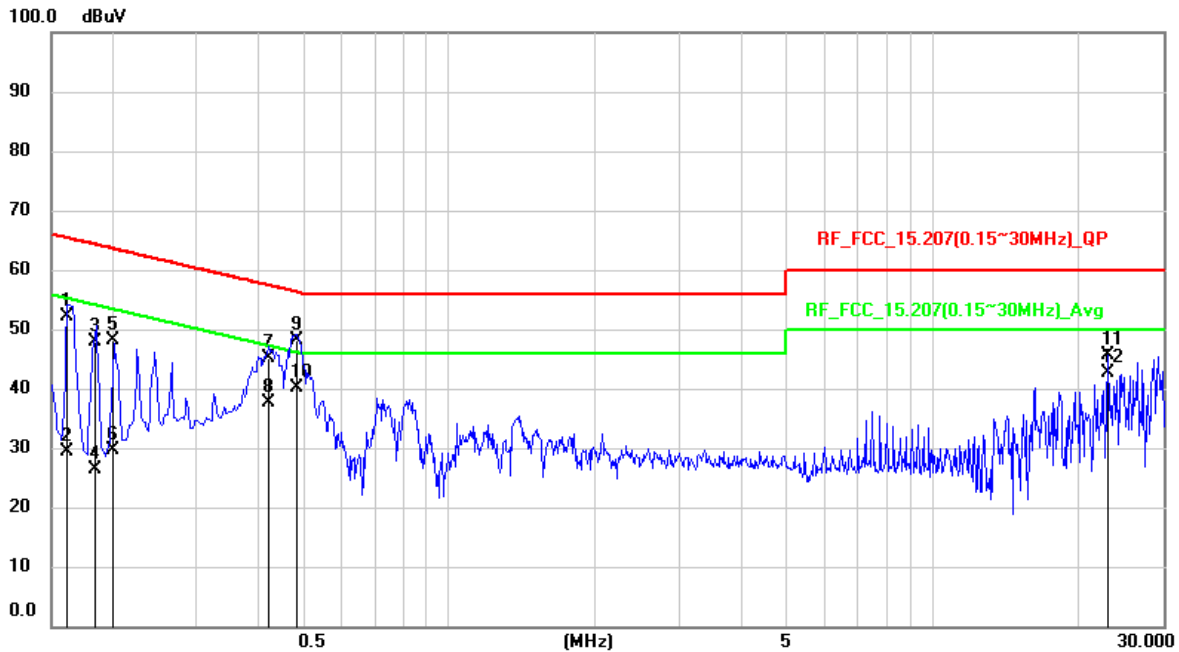

| No. | Frequency (MHz) | Reading Level (dBuV) | Correct Factor (dB) | Measurement (dBuV) | Limit (dBuV) | Margin (dB) | Detector |
|-----|-----------------|----------------------|---------------------|--------------------|--------------|-------------|----------|
| 1 | 0.162 | 42.24 | 9.84 | 52.08 | 65.36 | -13.28 | QP |
| 2 | 0.162 | 19.48 | 9.84 | 29.32 | 55.36 | -26.04 | AVG |
| 3 | 0.1841 | 37.94 | 9.82 | 47.76 | 64.3 | -16.54 | QP |
| 4 | 0.1841 | 16.49 | 9.82 | 26.31 | 54.3 | -27.99 | AVG |
| 5 | 0.1997 | 38.23 | 9.82 | 48.05 | 63.62 | -15.57 | QP |
| 6 | 0.1997 | 19.92 | 9.82 | 29.74 | 53.62 | -23.88 | AVG |
| 7 | 0.4215 | 35.32 | 9.84 | 45.16 | 57.42 | -12.26 | QP |
| 8 | 0.4215 | 27.87 | 9.84 | 37.71 | 47.42 | -9.71 | AVG |
| 9 | 0.4789 | 38.4 | 9.84 | 48.24 | 56.36 | -8.12 | QP |
| 10 | 0.4789 | 30.29 | 9.84 | 40.13 | 46.36 | -6.23 | AVG |
| 11 | 23.1279 | 35.33 | 10.38 | 45.71 | 60 | -14.29 | QP |
| 12 | 23.1279 | 32.36 | 10.38 | 42.74 | 50 | -7.26 | AVG |

Remark:

1. QP = Quasi Peak, AVG = Average
2. Correction Factor = Insertion loss of LISN + Cable loss
3. Measurement Value = Reading Level + Correct Factor
4. Margin Level = Result Value – Limit Value

| | | | |
|-----------------------|---------------------|-------------------------|-------------|
| Test Voltage : | 120Vac, 60Hz | Frequency Range: | 0.15-30 MHz |
| Test Mode : | Transmit BLE(1Mbps) | 6dB Bandwidth : | 9 kHz |
| Test Date : | 2023/09/11 | Phase : | N |
| Temperature : | 25.2°C | Humidity : | 43 % |

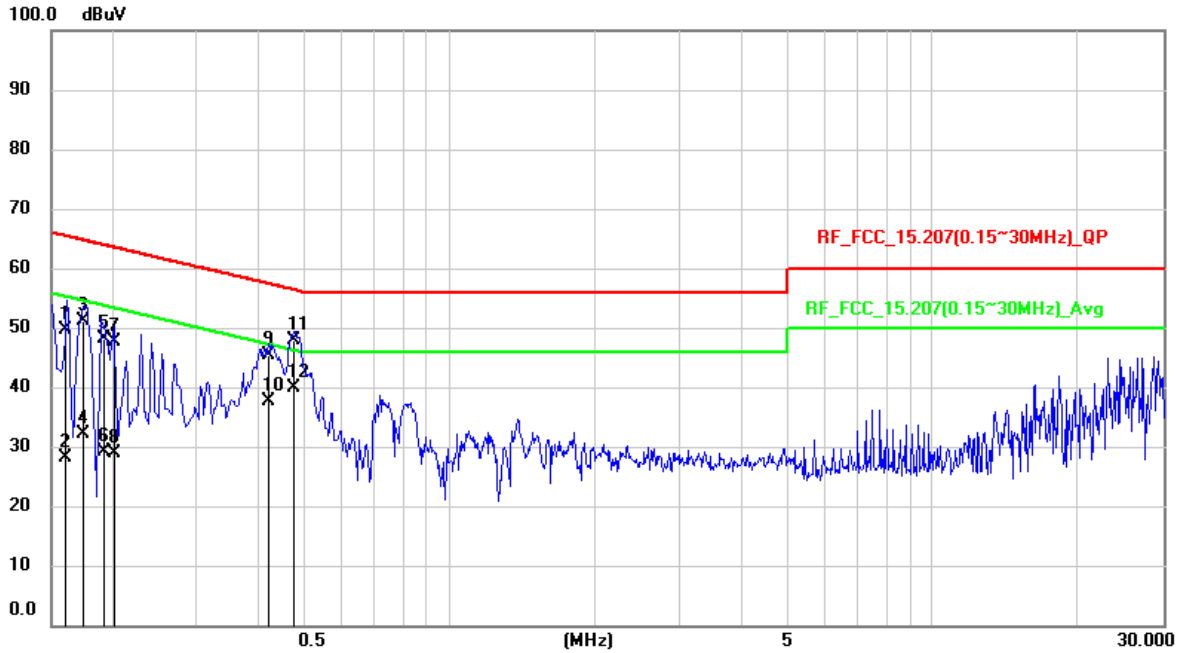

| No. | Frequency (MHz) | Reading Level (dBuV) | Correct Factor (dB) | Measurement (dBuV) | Limit (dBuV) | Margin (dB) | Detector |
|-----|-----------------|----------------------|---------------------|--------------------|--------------|-------------|----------|
| 1 | 0.1603 | 39.91 | 9.84 | 49.75 | 65.45 | -15.7 | QP |
| 2 | 0.1603 | 18.37 | 9.84 | 28.21 | 55.45 | -27.24 | AVG |
| 3 | 0.1733 | 41.35 | 9.84 | 51.19 | 64.8 | -13.61 | QP |
| 4 | 0.1733 | 22.39 | 9.84 | 32.23 | 54.8 | -22.57 | AVG |
| 5 | 0.1923 | 38.28 | 9.83 | 48.11 | 63.94 | -15.83 | QP |
| 6 | 0.1923 | 19.28 | 9.83 | 29.11 | 53.94 | -24.83 | AVG |
| 7 | 0.2022 | 37.74 | 9.83 | 47.57 | 63.52 | -15.95 | QP |
| 8 | 0.2022 | 19 | 9.83 | 28.83 | 53.52 | -24.69 | AVG |
| 9 | 0.4215 | 35.42 | 9.84 | 45.26 | 57.42 | -12.16 | QP |
| 10 | 0.4215 | 27.82 | 9.84 | 37.66 | 47.42 | -9.76 | AVG |
| 11 | 0.4741 | 38.03 | 9.84 | 47.87 | 56.44 | -8.57 | QP |
| 12 | 0.4741 | 30.13 | 9.84 | 39.97 | 46.44 | -6.47 | AVG |

Remark:

1. QP = Quasi Peak, AVG = Average
2. Correction Factor = Insertion loss of LISN + Cable loss
3. Measurement Value = Reading Level + Correct Factor
4. Margin Level = Result Value – Limit Value

--- END ---