

# FCC CERTIFICATION TEST REPORT

## FOR

<b>Applicant</b>	:	Lorenz High Definition LLC
<b>Address</b>	:	230 Rt 206 STE 401, Flanders, New Jersey, United States
<b>Equipment under Test</b>	:	800LR Z-Wave GPIO module
<b>Model No.</b>	:	ZAC93 LR
<b>Trade Mark</b>	:	<b>ZOOZ</b> <sup>TM</sup>
<b>FCC ID</b>	:	2AZ2V-101222-ZAC93
<b>Manufacturer</b>	:	Shenzhen ZVIDAR Technologies CO.,Ltd.
<b>Address</b>	:	Room 468, Building F1, TCL Technologies Park, 1001, Zhongshanyuan Road, Shuguang Community, Xili Street Office, Nanshan District, Shenzhen City

**Issued By: Dongguan Dongdian Testing Service Co., Ltd.**

**Add.:** No. 17, Zongbu Road 2, Songshan Lake Sci&Tech, Industry Park,  
Dongguan City, Guangdong Province, China, 523808

**Tel.:** +86-0769-38826678, **E-mail:** ddt@dgddt.com, <http://www.dgddt.com>

# REPORT

## Table of Contents

	Test report declares.....	4
1.	Summary of Test Results.....	6
2.	General Test Information .....	7
2.1.	Description of EUT .....	7
2.2.	Accessories of EUT.....	7
2.3.	Assistant equipment used for test.....	7
2.4.	Block diagram of EUT configuration for test .....	7
2.5.	Test environment conditions .....	8
2.6.	Deviations of test standard.....	8
2.7.	Test laboratory .....	8
2.8.	Measurement uncertainty.....	9
3.	Equipment Used During Test.....	10
4.	6 dB Bandwidth .....	11
4.1.	Block diagram of test setup.....	11
4.2.	Limits .....	11
4.3.	Test procedure .....	11
4.4.	Test result.....	12
4.5.	Original test data .....	12
5.	Maximum Peak Output Power .....	13
5.1.	Block diagram of test setup.....	13
5.2.	Limits .....	13
5.3.	Test procedure .....	13
5.4.	Test result.....	14
5.5.	Original test data .....	14
6.	Power Spectral Density.....	15
6.1.	Block diagram of test setup.....	15
6.2.	Limits .....	15
6.3.	Test procedure .....	15
6.4.	Test result.....	16
6.5.	Test graphs .....	16
7.	Band Edge Compliance (Conducted Method) .....	17
7.1.	Block diagram of test setup.....	17
7.2.	Limits .....	17
7.3.	Test procedure .....	17
7.4.	Test result.....	18
7.5.	Test graphs .....	18
8.	Duty cycle.....	19

8.1.	Block diagram of test setup.....	19
8.2.	Limit.....	19
8.3.	Test procedure.....	19
8.4.	Test result.....	20
9.	Radiated Emission.....	21
9.1.	Block diagram of test setup.....	21
9.2.	Limit.....	22
9.3.	Test Procedure.....	24
9.4.	Test result.....	25
10.	RF Conducted Spurious Emissions.....	38
10.1.	Block diagram of test setup.....	38
10.2.	Limits.....	38
10.3.	Test procedure.....	38
10.4.	Test result.....	38
10.5.	Test graphs.....	39
11.	Power Line Conducted Emission.....	41
11.1.	Block diagram of test setup.....	41
11.2.	Power line conducted emission limits.....	41
11.3.	Test procedure.....	41
11.4.	Test result.....	42
12.	Antenna Requirements.....	43
12.1.	Limit.....	43
12.2.	Result.....	43
13.	Test Setup Photograph.....	44
14.	Photos of the EUT.....	46

## Test Report Declare

<b>Applicant</b>	:	Lorenz High Definition LLC
<b>Address</b>	:	230 Rt 206 STE 401, Flanders, New Jersey, United States
<b>Equipment under Test</b>	:	800LR Z-Wave GPIO module
<b>Model No.</b>	:	ZAC93 LR
<b>Trade Mark</b>	:	<b>ZOOZ</b> <sup>TM</sup>
<b>Manufacturer</b>	:	Shenzhen ZVIDAR Technologies CO.,Ltd.
<b>Address</b>	:	Room 468, Building F1, TCL Technologies Park, 1001, Zhongshanyuan Road, Shuguang Community, Xili Street Office, Nanshan District, Shenzhen City

### Test Standard Used:

FCC Rules and Regulations Part 15 Subpart C

### Test Procedure Used:

ANSI C63.10:2013

### We Declare:

The equipment described above is tested by Dongguan Dongdian Testing Service Co., Ltd. and in the configuration tested the equipment complied with the standards specified above. The test results are contained in this test report and Dongguan Dongdian Testing Service Co., Ltd. is assumed of full responsibility for the accuracy and completeness of these tests.

**After test and evaluation, our opinion is that the equipment provided for test compliance with the requirement of the above FCC standards.**

<b>Report No.:</b>	DDT-RE23060515-1E02		
<b>Date of Receipt:</b>	Jun. 05, 2023	<b>Date of Test:</b>	Jun. 07, 2023~ Jul. 11, 2023

**Prepared By:**

*Jacky Huang*

**Jacky Huang/Engineer**

**Approved By:**



**Damon Hu/EMC Manager**

Note: This report applies to above tested sample only. This report shall not be reproduced in parts without written approval of Dongguan Dongdian Testing Service Co., Ltd.

### Revision History

Rev.	Revisions	Issue Date	Revised By
---	Initial issue	Jul. 12, 2023	

## 1. Summary of Test Results

Description of Test Item	Standard	Results
6 dB Bandwidth	FCC Part 15: 15.247 ANSI C63.10:2013	Pass
Peak Output Power	FCC Part 15: 15.247 ANSI C63.10:2013	Pass
Power Spectral Density	FCC Part 15:15.247 ANSI C63.10:2013	Pass
Band Edge Compliance (Conducted Method)	FCC Part 15: 15.205 FCC Part 15: 15.247 ANSI C63.10: 2013	Pass
Radiation Emission	FCC Part 15: 15.205 FCC Part 15: 15.209 FCC Part 15: 15.247 ANSI C63.10:2013	Pass
RF Conducted Spurious Emissions	FCC Part 15: 15.247 ANSI C63.10: 2013	Pass
Power Line Conducted Emission	FCC Part 15: 15.207 ANSI C63.10: 2013	NA
Antenna Requirement	FCC Part 15: 15.203	Pass
NA: Indicates that this test item is not applicable.		



## 2. General Test Information

### 2.1. Description of EUT

EUT Name	: 800LR Z-Wave GPIO module
Model Number	: ZAC93 LR
EUT Function Description	: Please reference user manual of this device
Power Supply	: DC 3.3V
Operation Frequency	: 912 MHz, 920 MHz
Modulation	: OQPSK
Data Rate	: 100 kbps
Antenna Gain	: -2.75 dBi
Sample Number	: S23060515-01 for radiated, S23060515-02 for conducted

Note: EUT is the abbreviation of equipment under test.

Data rate (kbps)	Frequency (MHz)
100	912
100	920

### 2.2. Accessories of EUT

Description of Accessories	Manufacturer	Model number	Serial No.	Other
N/A	N/A	N/A	N/A	N/A

### 2.3. Assistant equipment used for test

Assistant equipment	Manufacturer	Model number	Serial No.	Other
Laptop	HP	NPVSDA3	N/A	N/A
Laptop	Lenovo	X201	N/A	N/A

### 2.4. Block diagram of EUT configuration for test

Tx Mode:



Test software: xshell.exe

The test software was used to control EUT work in Continuous Tx mode, and select test channel, wireless mode as below table.

The pathloss of external cable: 0.3dB (According to the manufacturer's claims).

Tested mode, channel, information			
Mode	Setting Tx Power	Data rate (kbps)	Frequency (MHz)
OQPSK Tx mode	120	100	912
	120	100	920

## 2.5. Test environment conditions

During the measurement the environmental conditions were within the listed ranges:

Temperature range:	+15 °C to +35 °C
Humidity range:	20% to 75%
Pressure range:	86 kPa to 106 kPa

## 2.6. Deviations of test standard

No deviation.

## 2.7. Test laboratory

Dongguan Dongdian Testing Service Co., Ltd.

Add.: No. 17, Zongbu Road 2, Songshan Lake Sci&Tech, Industry Park, Dongguan City, Guangdong Province, China, 523808.

Tel.: +86-0769-38826678, <http://www.dgddt.com>, Email: [ddt@dgddt.com](mailto:ddt@dgddt.com).

CNAS Accreditation No. L6451; A2LA Accreditation Number: 3870.01

FCC Designation Number: CN1182, Test Firm Registration Number: 540522

Innovation, Science and Economic Development Canada Site Registration Number: 10288A

Conformity Assessment Body identifier: CN0048

VCCI facility registration number: C-20087, T-20088, R-20123, R-20155, G-20118



## 2.8. Measurement uncertainty

Test Item	Uncertainty
Bandwidth	1.1%
Peak Output Power (Conducted) (Spectrum Analyzer)	0.86 dB (10 MHz ≤ f < 3.6 GHz);
	1.38 dB (3.6 GHz ≤ f < 8 GHz)
Peak Output Power (Conducted) (Power Sensor)	0.74 dB
Power Spectral Density	0.74 dB (10 MHz ≤ f < 3.6 GHz);
	1.38 dB (3.6 GHz ≤ f < 8 GHz)
Frequencies Stability	6.7 x 10 <sup>-8</sup> (Antenna couple method)
	5.5 x 10 <sup>-8</sup> (Conducted method)
Conducted Spurious Emissions	0.86 dB (10 MHz ≤ f < 3.6 GHz);
	1.40 dB (3.6 GHz ≤ f < 8 GHz)
	1.66 dB (8 GHz ≤ f < 26.5 GHz)
Uncertainty for Radio Frequency (RBW<20 KHz)	3×10 <sup>-8</sup>
Temperature	0.4 °C
Humidity	2 %
Uncertainty for Radiation Emission Test (9kHz -30 Mhz)	3.44 dB
Uncertainty for Radiation Emission Test (30 Mhz-1 Ghz)	4.70 dB (Antenna Polarize: V)
	4.84 dB (Antenna Polarize: H)
Uncertainty for Radiation Emission Test (1 Ghz-40 Ghz)	4.10 dB (1-6 GHz)
	4.40 dB (6 GHz-18 GHz)
	3.54 dB (18 GHz-26 GHz)
	4.30 dB (26 GHz-40 GHz)
Uncertainty for Power Line Conduction Emission Test	3.32 dB (150 kHz-30 MHz)

Note: This uncertainty represents an expanded uncertainty expressed at approximately the 95% confidence level using a coverage factor of k=2.

### 3. Equipment Used During Test

Equipment	Manufacturer	Model No.	Serial No.	Last Cal.	Cal. Interval
<b>☑RF Connected Test (Tonscend RF Measurement System 4#)</b>					
Signal & Spectrum analyzer	R&S	FSV3044	101173	Apr. 23, 2023	1 Year
Signal & Spectrum analyzer	R&S	FSV40	101407	Jul. 21, 2022	1 Year
Wideband Radio Communication tester	R&S	CMW500	168801	Apr. 27, 2023	1 Year
Vector Signal Generator	Agilent	N5182A	MY48180737	Apr. 27, 2023	1 Year
Vector Signal Generator	Agilent	E8267D	US49060192	Sep. 28, 2022	1 Year
RF Control Unit	Tonsend	JS0806-2	21I8060485	Apr. 27, 2023	1 Year
Test Software	JS Tonscend	JS1120-3	Ver.3.2.22	N/A	N/A
<b>☑Radiation 3#chamber</b>					
EMI Test Receiver	R&S	ESU26	100472	Apr. 23, 2023	1 Year
Spectrum analyzer	Agilent	E4447A	MY50180031	Apr. 23, 2023	1 Year
Active Loop antenna	Schwarzbeck	FMZB-1519	1519-038	Sep. 29, 2022	1 Year
Trilog Broadband Antenna	Schwarzbeck	VULB 9163	01429	Jul. 22, 2022	1 Year
Double Ridged Horn Antenna	Schwarzbeck	BBHA9120 D	02468	Sep. 29, 2022	1 Year
Broad Band Horn Antenna	Schwarzbeck	BBHA 9170	790	Apr. 26, 2023	1 Year
Pre-amplifier	COM-POWER	PAM-118A	18040084	Aug.17, 2022	1 Year
Pre-amplifier	COM-POWER	PAM-840A	461369	Apr. 27, 2023	1 Year
RE Cable	N/A	W23.02 CP1-X2 + W23.09 AP1-X8+ JCT26S-NJ-NJ- 1.5M	4.5M+8M+1.5M	Apr. 21, 2023	1 Year
RF Cable	Yuhu Technology	JCTB810-NJ-NJ -9M+ ZT26S-SMAJ-S MAJ-1M	21123964	Apr. 23, 2023	1 Year
Micro-Tronics filters	REBES	BRM50702	G555	N/A	N/A
Micro-Tronics filters	REBES	BRM50716	G392	N/A	N/A
High Pass filter	XB	XBLBQ-GTA67	210820-2-3	N/A	N/A
Test software	Tonscend	JS32-RE	V 5.0.0.1	N/A	N/A

## 4. 6 dB Bandwidth

### 4.1. Block diagram of test setup

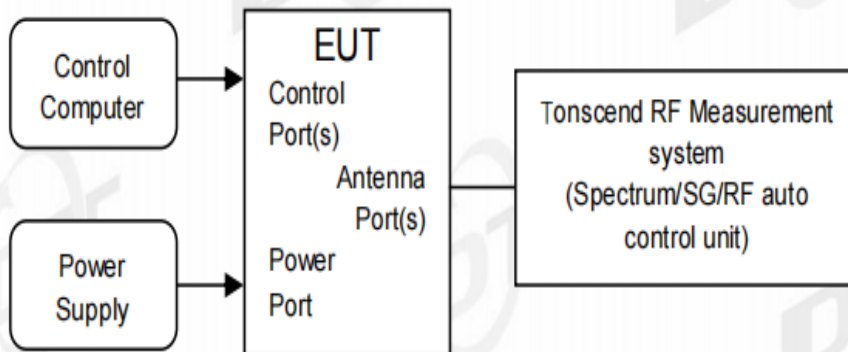

### 4.2. Limits

For direct sequence systems, the minimum 6 dB bandwidth shall be at least 500 kHz

### 4.3. Test procedure

- (1) The test according to ANSI C63.10-2013 clause 11.8.
- (2) Connect EUT's antenna output to spectrum analyzer by RF cable, the path loss was compensated to the results
- (3) Set the EUT as maximum power setting and enable the EUT transmit continuously
- (4) Use the following spectrum analyzer settings for 6 dB Bandwidth:

RBW:	100 kHz
VBW:	$\geq [3 \times \text{RBW}]$
Detector Mode:	Peak
Sweep time:	auto
Trace mode	Max hold
- (5) Allow the trace to stabilize, measure the 6 dB bandwidth of signal, and record the results in the report.

### 4.4. Test result

Test Mode	Antenna	Frequency [MHz]	DTS BW [MHz]	FL [MHz]	FH [MHz]	Limit [MHz]	Verdict
OQPSK	Ant1	912	0.61	911.69	912.30	0.5	PASS
		920	0.62	919.68	920.30	0.5	PASS

### 4.5. Original test data



## 5. Maximum Peak Output Power

### 5.1. Block diagram of test setup

Same as 4.1.

### 5.2. Limits

For systems using digital modulation in the 902-928 MHz, 2400-2483.5 MHz, and 5725-5850 MHz bands: 1 Watt. If transmitting antennas of directional gain greater than 6dBi are used, the conducted output power from the intentional radiator shall be reduced below the stated values as appropriate, by the amount in dB that the directional gain of the antenna exceeds 6 dBi, the e.i.r.p shall not exceed 4W.

### 5.3. Test procedure

- (1) The test according to ANSI C63.10-2013 clause 11.9.1.1.
- (2) Connect EUT's antenna output to spectrum analyzer by RF cable, the path loss was compensated to the results.
- (3) Set the EUT as maximum power setting and enable the EUT transmit continuously.
- (4) Use the following spectrum analyzer settings for the maximum peak output power measurement:

RBW:	≥DTS bandwidth
VBW:	≥3 x RBW
Span	≥3 x RBW
Detector Mode:	Peak
Sweep time:	Auto
Trace mode	Max hold

- (5) Allow the trace to stabilize, use peak marker function to determine the peak amplitude level.



### 5.4. Test result

Test Mode	Antenna	Frequency [MHz]	Conducted Peak Power [dBm]	Conducted Limit [dBm]	EIRP [dBm]	EIRP Limit [dBm]	Verdict
OQPSK	Ant1	912	7.96	≤30	5.16	≤36	PASS
		920	7.72	≤30	4.92	≤36	PASS

### 5.5. Original test data

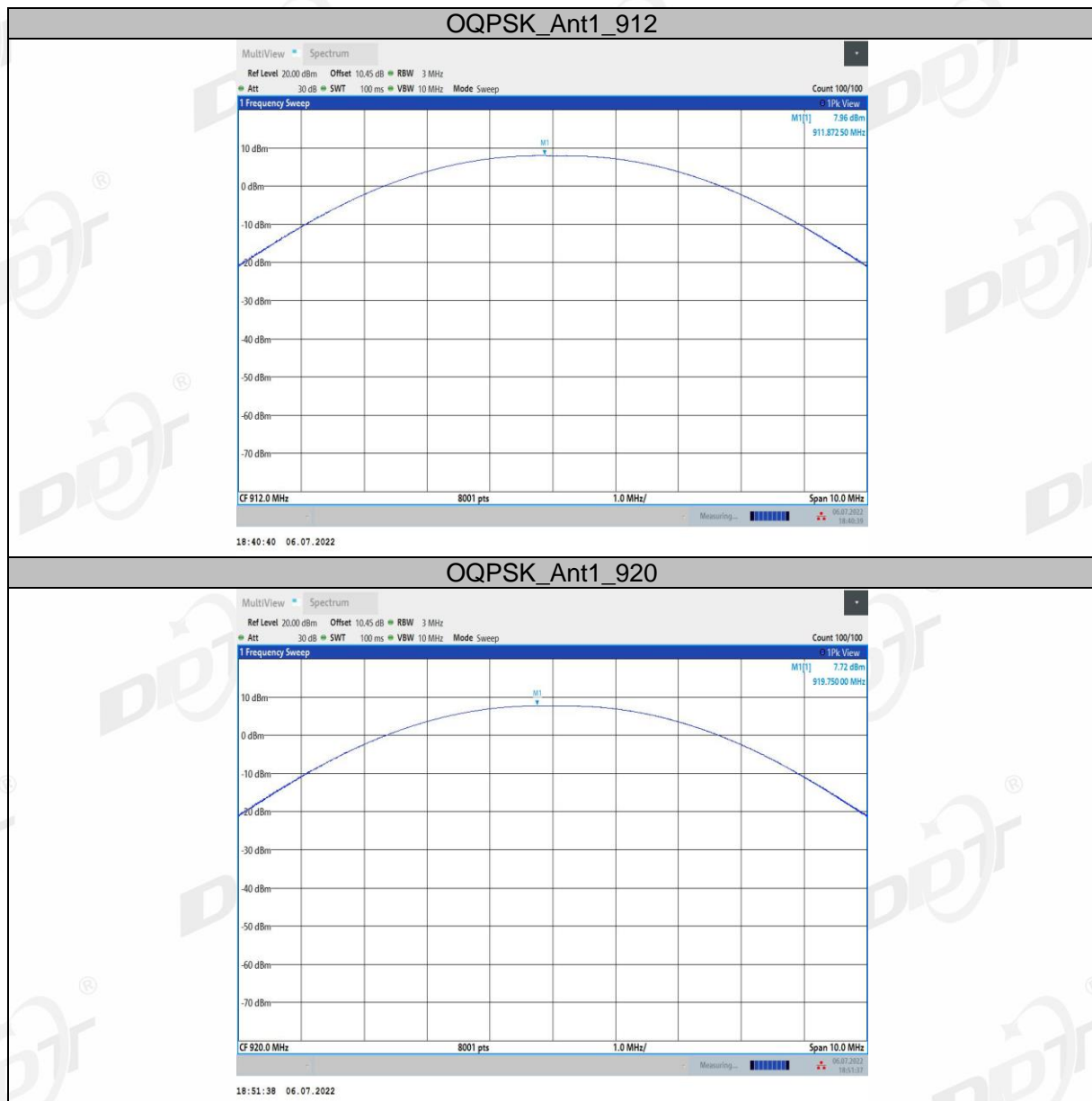



## 6. Power Spectral Density

### 6.1. Block diagram of test setup

Same as 4.1.

### 6.2. Limits

For digitally modulated systems, the power spectral density conducted from the intentional radiator to the antenna shall not be greater than 8 dBm in any 3 kHz band during any time interval of continuous transmission.

### 6.3. Test procedure

- (1) The test according to ANSI C63.10-2013 clause 11.10.2.
- (2) Connect EUT's antenna output to spectrum analyzer by RF cable, the path loss was compensated to the results.
- (3) Set the EUT as maximum power setting and enable the EUT transmit continuously.
- (4) Use the following spectrum analyzer settings for Power Spectral Density measurement:

Center frequency	DTS Channel center frequency
RBW:	$3 \text{ kHz} \leq \text{RBW} \leq 100 \text{ kHz}$
VBW:	$\geq 3\text{RBW}$
Span	1.5 times the DTS bandwidth
Detector Mode:	Peak
Sweep time:	Auto
Trace mode	Max hold

- (5) Allow the trace to stabilize, use the peak marker function to determine the maximum amplitude level within the RBW.

Note: If measured value exceeds limit, reduce RBW (no less than 3 kHz) and repeat.

### 6.4. Test result

Test Mode	Antenna	Frequency [MHz]	Result [dBm/3kHz]	Limit [dBm/3kHz]	Verdict
OQPSK	Ant1	912	-4.86	≤8	PASS
		920	-4.65	≤8	PASS

### 6.5. Test graphs

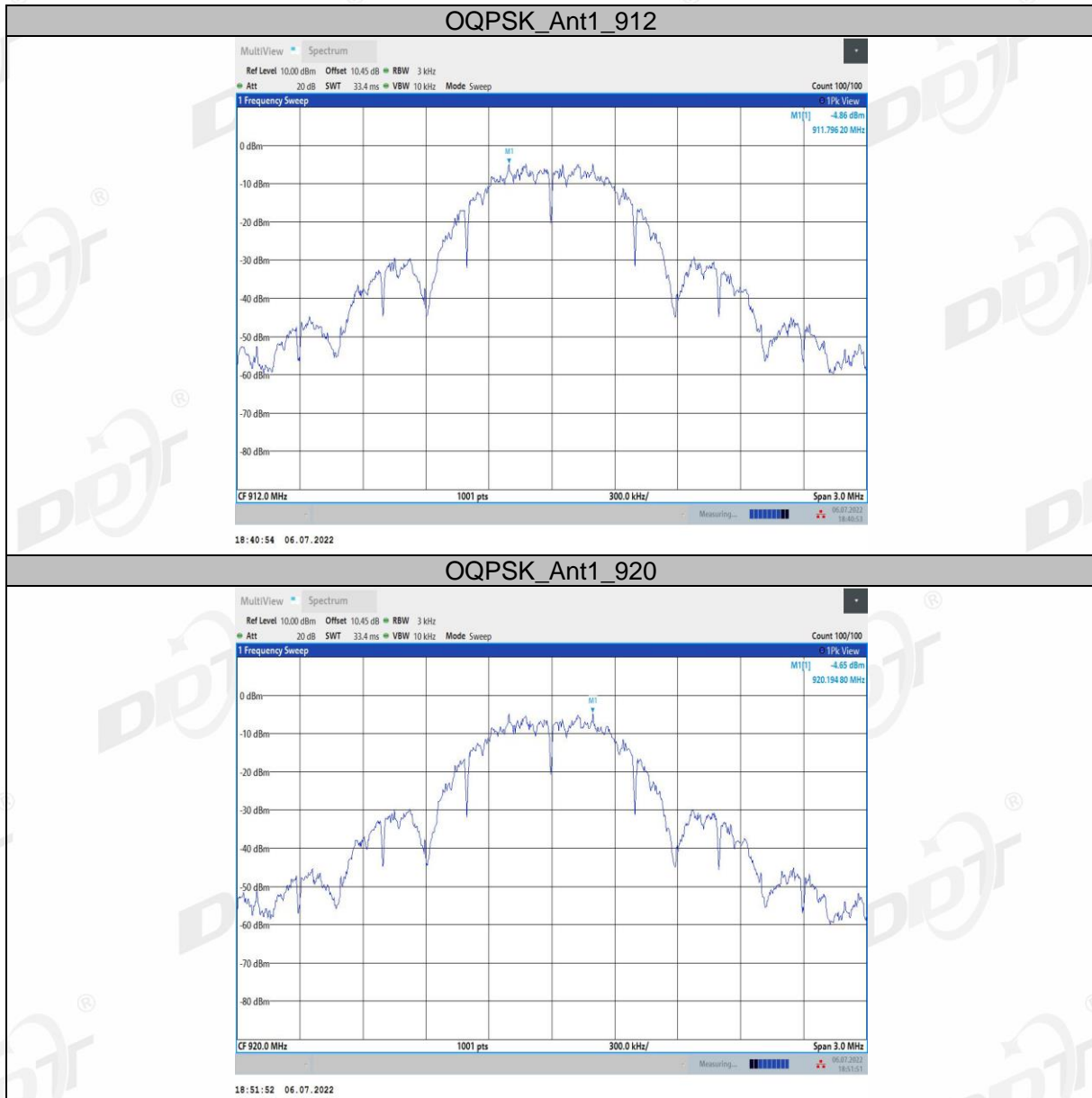

## 7. Band Edge Compliance (Conducted Method)

### 7.1. Block diagram of test setup

Same as 4.1.

### 7.2. Limits

In any 100 kHz bandwidth outside the frequency bands in which the spread spectrum intentional radiator is operating, the radio frequency power that is produced by the intentional radiator shall be at least 20 dB below that in the 100 kHz bandwidth within the band that contains the highest level of the desired power.

### 7.3. Test procedure

(1) Connect EUT's antenna output to spectrum analyzer by RF cable.

(2) Establish a reference level by using the following procedure:

Center frequency	DTS Channel center frequency
RBW:	100 kHz
VBW:	300 kHz
Span	1.5 times the DTS bandwidth
Detector Mode:	Peak
Sweep time:	Auto
Trace mode	Max hold

(3) Allow the trace to stabilize, use the peak marker function to determine the maximum peak power level to establish the reference level.

(4) Set the spectrum analyzer as follows:

RBW:	100 kHz
VBW:	300 kHz
Span	Encompass frequency range to be measured
Number of measurement points	$\geq \text{span/RBW}$
Detector Mode:	Peak
Sweep time:	Auto
Trace mode	Max hold

(5) Allow the trace to stabilize, use the peak marker function to determine the maximum amplitude of all unwanted emissions outside of the authorized frequency band.

### 7.4. Test result

EUT Set Mode	Channel or Frequency	Measured Range	Result (dBm)	Result (dBc)	Limit (dBc)	Verdict
OQPSK	912 MHz	900 MHz - 930 MHz	-50.45	-57.84	-20	Pass
			-51.62	-59.01	-20	Pass
OQPSK	920 MHz	900 MHz - 930 MHz	-50.74	-58.40	-20	Pass
			-50.71	-58.37	-20	Pass

### 7.5. Test graphs

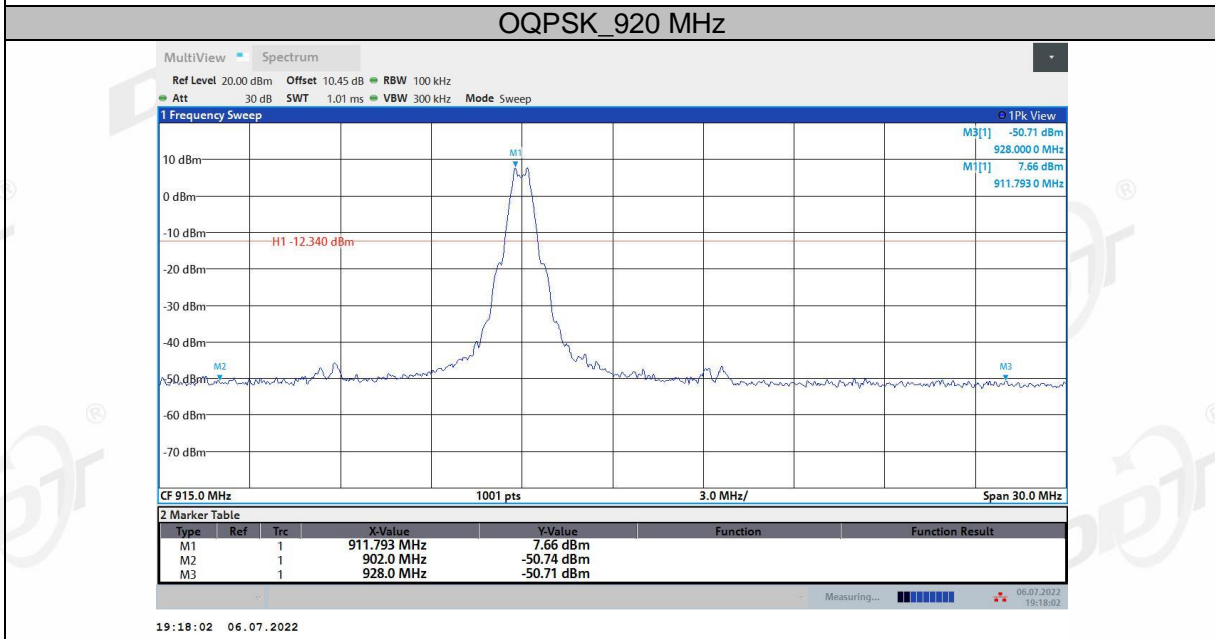
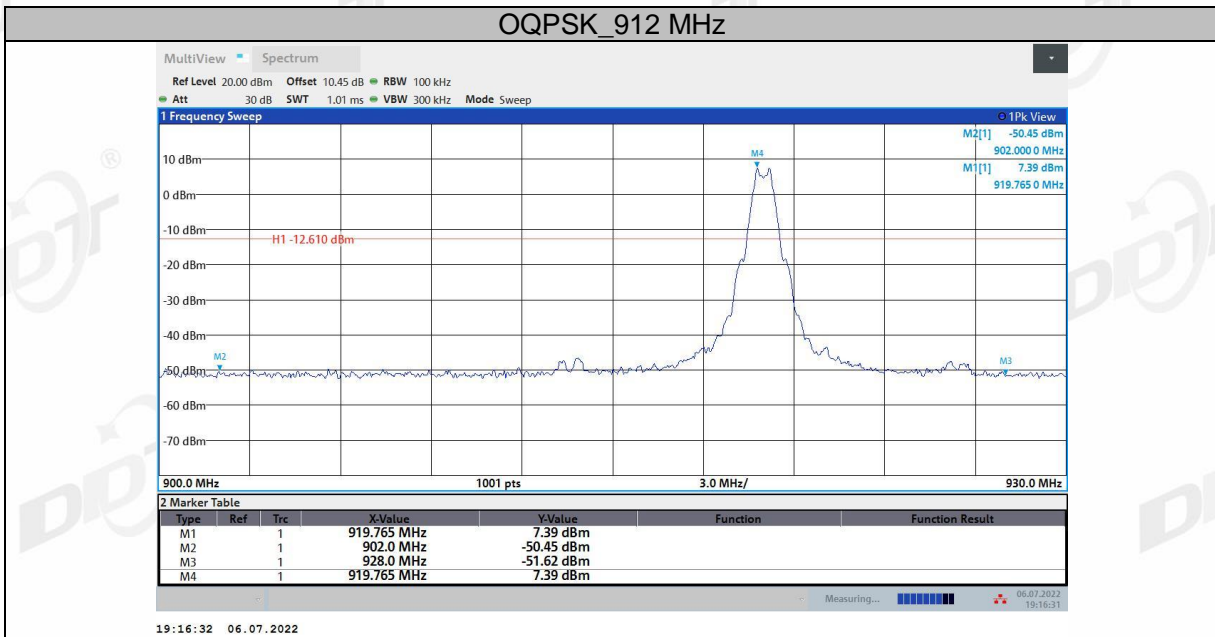

## 8. Duty cycle

### 8.1. Block diagram of test setup

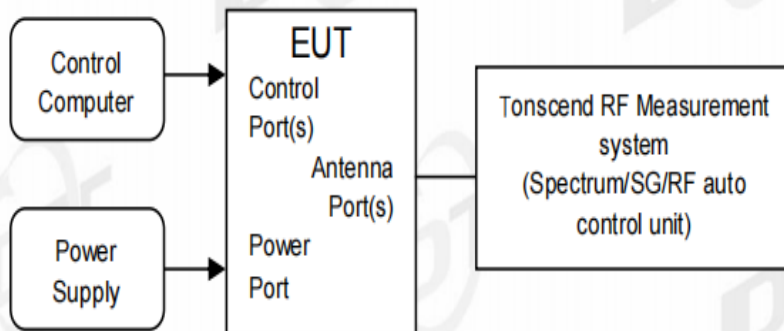

### 8.2. Limit

Just for Report and determining the average value of pulsed emissions.

### 8.3. Test procedure

(1) Connected the EUT's antenna port to the Spectrum Analyzer by suitable attenuator, The cable loss and attenuator loss have been put into spectrum analyzer as amplitude offset.

set the Spectrum Analyzer as below:

Centre Frequency: The centre frequency of the middle hopping channel.

Resolution BW: 3 MHz.

Video BW: 3 MHz.

Span: Zero span.

Detector: Peak.

Trace Mode: Max Hold.

Sweep: Video Trigger

Sweep time: 100 ms

(2) When the trace is complete, measure the sending time of 1 burst and the duty cycle of 1 burst cycle.

(3) Calculate dwell time follow below formula:

Duty cycle= Pulse's on time / Burst cycle



### 8.4. Test result

Test Mode	Antenna	Frequency [MHz]	ON Time [ms]	Period [ms]	Duty Cycle [%]	Duty Cycle Factor [dB]
OQPSK	Ant1	912	25.653	100	25.653	-11.82

Note 1: Different frequencies have the same duty cycle.

Note 2: On time= $(21.594-15.507)*2+(50.145-45.652)*2=25.653\text{ms}$

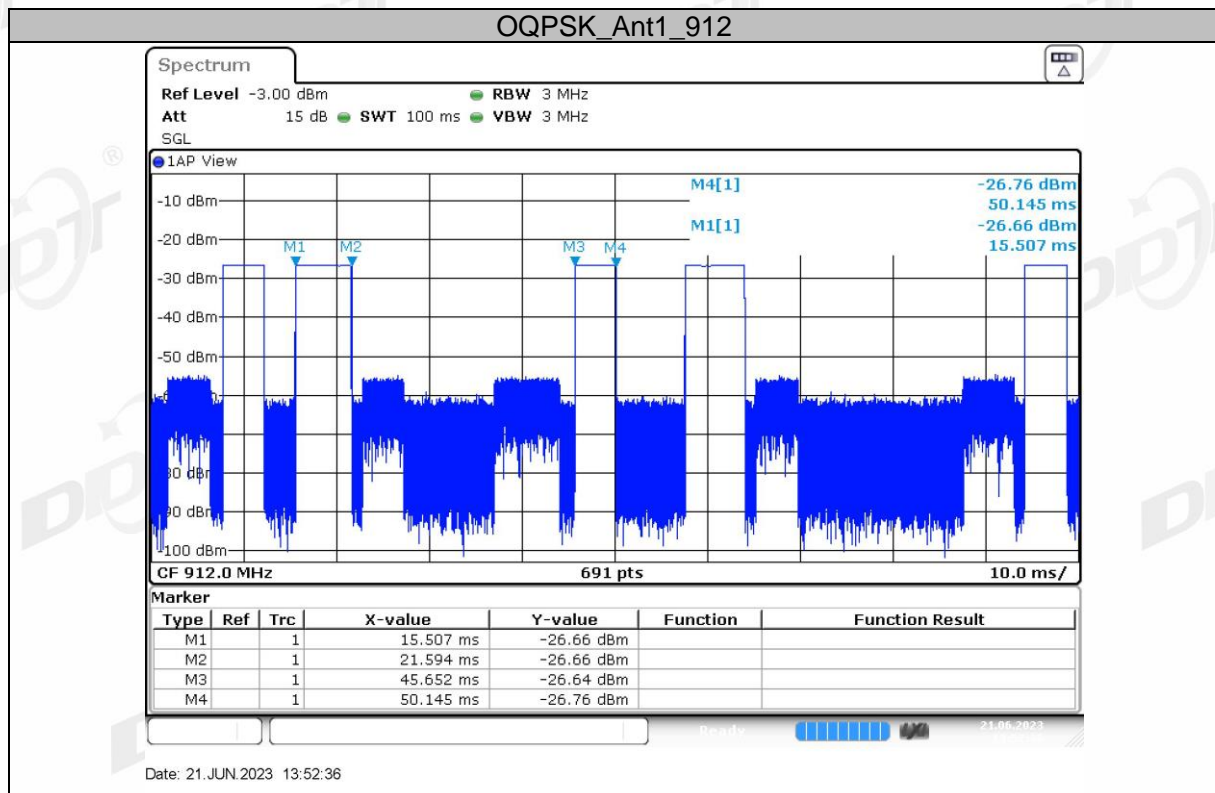



## 9. Radiated Emission

### 9.1. Block diagram of test setup

In 3 m Anechoic Chamber, test setup diagram for 9 kHz - 30 MHz:

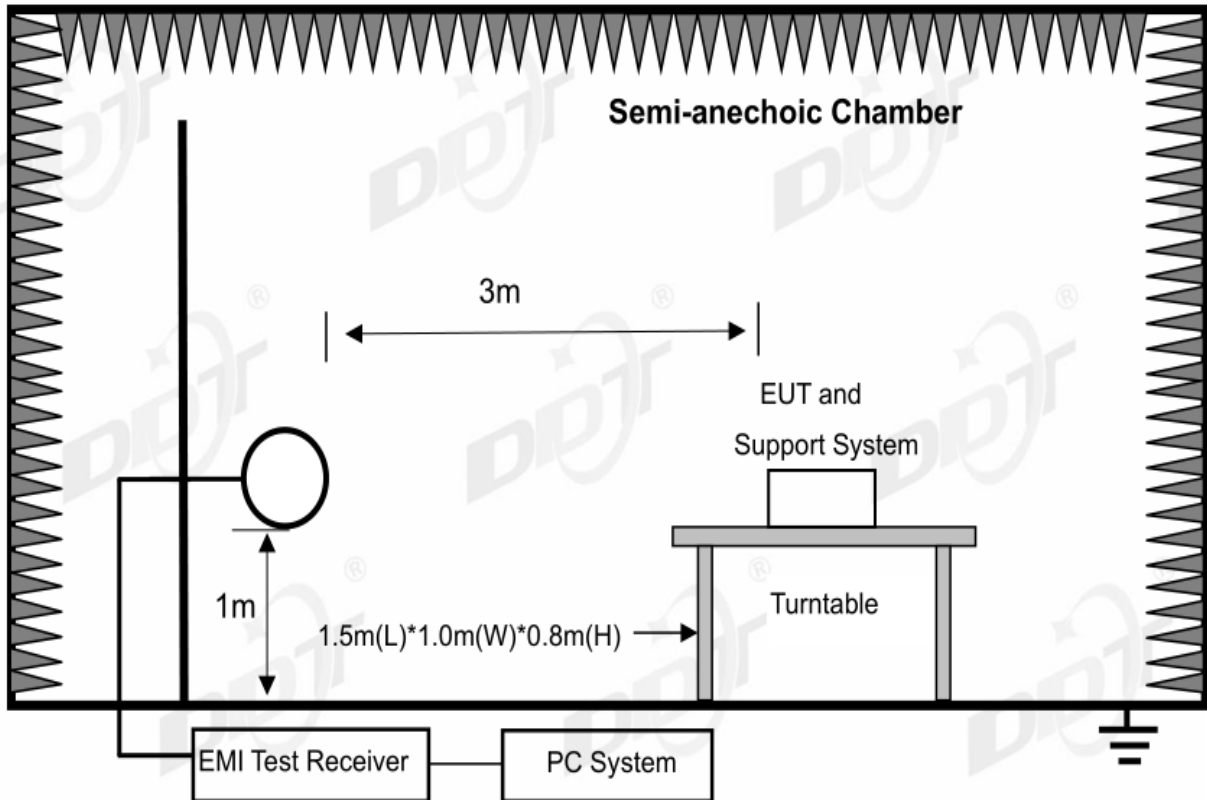

In 3 m Anechoic Chamber, test setup diagram for 30 MHz - 1 GHz:

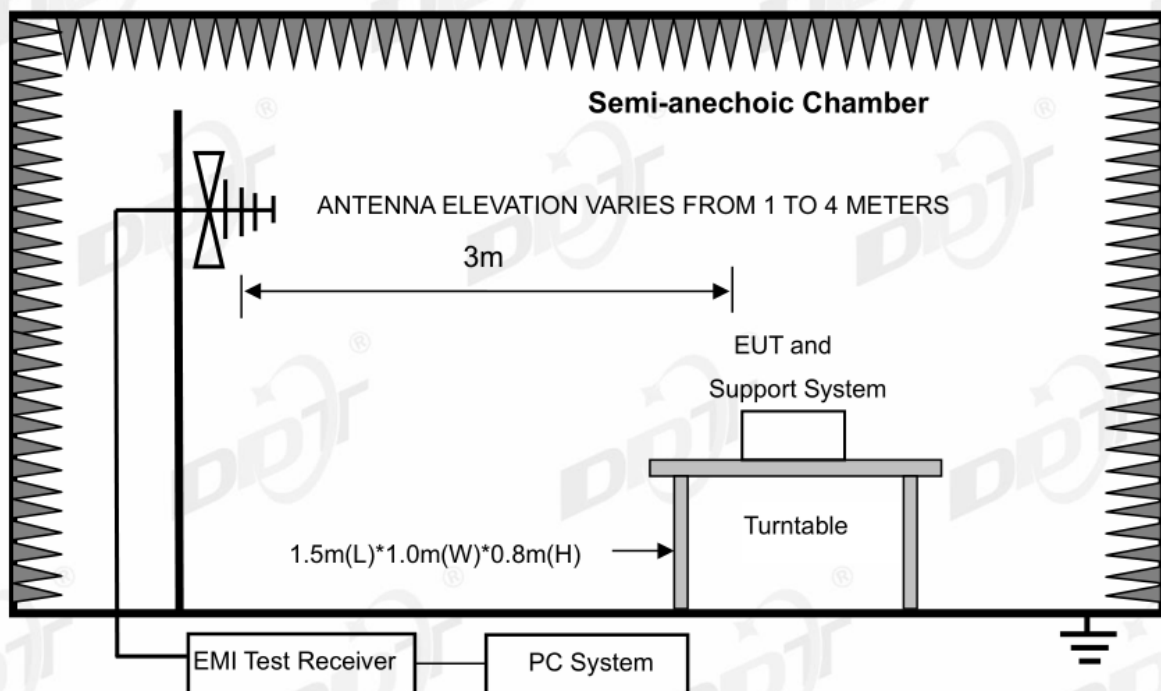

In 3 m Anechoic Chamber, test setup diagram for frequency above 1 GHz:

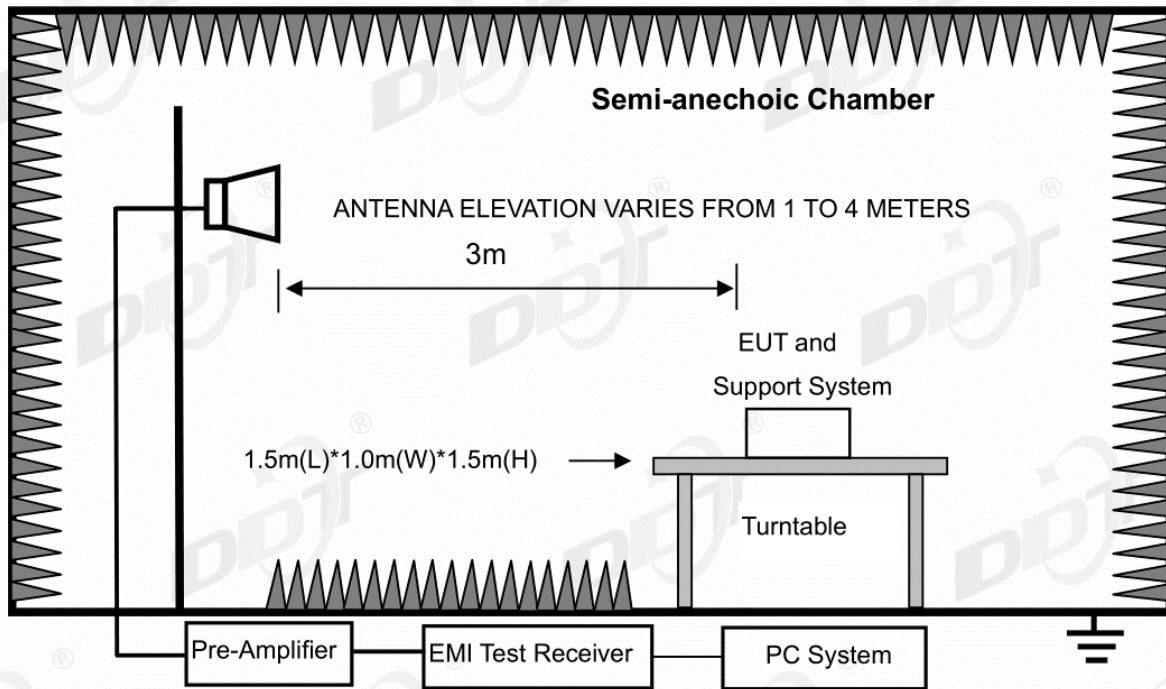

Note: For harmonic emissions test an appropriate high pass filter was inserted in the input port of AMP.

## 9.2. Limit

(1) FCC 15.205 Restricted frequency band

MHz	MHz	MHz	GHz
0.090-0.110	16.42-16.423	399.9-410	4.5-5.15
<sup>1</sup> 0.495-0.505	16.69475-16.69525	608-614	5.35-5.46
2.1735-2.1905	16.80425-16.80475	960-1240	7.25-7.75
4.125-4.128	25.5-25.67	1300-1427	8.025-8.5
4.1772&4.17775	37.5-38.25	1435-1626.5	9.0-9.2
4.2072&4.20775	73-74.6	1645.5-1646.5	9.3-9.5
6.215-6.218	74.8-75.2	1660-1710	10.6-12.7
6.26775-6.26825	108-121.94	1718.8-1722.2	13.25-13.4
6.31175-6.31225	123-138	2200-2300	14.47-14.5
8.291-8.294	149.9-150.05	2310-2390	15.35-16.2
8.362-8.366	156.52475-156.52525	2483.5-2500	17.7-21.4
8.37625-8.38675	156.7-156.9	2690-2900	22.01-23.12
8.41425-8.41475	162.0125-167.17	3260-3267	23.6-24.0
12.29-12.293	167.72-173.2	3332-3339	31.2-31.8
12.51975-12.52025	240-285	3345.8-3358	36.43-36.5
12.57675-12.57725	322-335.4	3600-4400	( <sup>2</sup> )
13.36-13.41			

<sup>1</sup>Until February 1, 1999, this restricted band shall be 0.490-0.510 MHz.

<sup>2</sup>Above 38.6

## RSS-Gen section 8.10 Restricted frequency bands\*

MHz	MHz	MHz	GHz
0.090-0.110	12.51975-12.52025	240-285	3.5-4.4
0.495-0.505	12.57675-12.57725	322-335.4	4.5-5.15
2.1735-2.1905	13.36-13.41	399.9-410	5.35-5.46
3.020-3.026	16.42-16.423	608-614	7.25-7.75
4.125-4.128	16.69475-16.69525	960-1427	8.025-8.5
4.1772&4.17775	16.80425-16.80475	1435-1626.5	9.0-9.2
4.2072&4.20775	25.5-25.67	1645.5-1646.5	9.3-9.5
5.677-5.683	37.5-38.25	1660-1710	10.6-12.7
6.215-6.218	73-74.6	1718.8-1722.2	13.25-13.4
6.26775-6.26825	74.8-75.2	2200-2300	14.47-14.5
6.31175-6.31225	108-138	2310-2390	15.35-16.2
8.291-8.294	149.9-150.05	2483.5-2500	17.7-21.4
8.362-8.366	156.52475-156.52525	2655-2900	22.01-23.12
8.37625-8.38675	156.7-156.9	3260-3267	23.6-24.0
8.41425-8.41475	162.0125-167.17	3332-3339	31.2-31.8
12.29-12.293	167.72-173.2	3345.8-3358	36.43-36.5
			Above 38.6

\* Certain frequency bands listed in table and in bands above 38.6 GHz are designated for licence-exempt applications. These frequency bands and the requirements that apply to related devices are set out in the 200 and 300 series of RSSs.

## (2) FCC 15.209 Limit &amp; RSS-Gen section 8.9 Limit

FREQUENCY (MHz)	DISTANCE Meters	FIELD STRENGTHS LIMIT	
		$\mu\text{V}/\text{m}$	$\text{dB}(\mu\text{V})/\text{m}$
0.009 ~ 0.490	300	2400/F(kHz)	67.6-20log(F)
0.490 ~ 1.705	30	24000/F(kHz)	87.6-20log(F)
1.705 ~ 30.0	30	30	29.54
30 ~ 88	3	100	40.0
88 ~ 216	3	150	43.5
216 ~ 960	3	200	46.0
960 ~ 1000	3	500	54.0
Above 1000	3	74.0 $\text{dB}(\mu\text{V})/\text{m}$ (Peak) 54.0 $\text{dB}(\mu\text{V})/\text{m}$ (Average)	

Note: (1) The emission limits shown in the above table are based on measurements employing a CISPR QP detector except for the frequency bands 9 - 90 kHz, 110 - 490 kHz and above 1000 MHz. Radiated emissions limits in these three bands are based on measurements employing an average detector.

(2) At frequencies below 30 MHz, measurement may be performed at a distance closer than that specified, and the limit at closer measurement distance can be extrapolated by below formula:

$$\text{Limit}_{3\text{m}}(\text{dB}\mu\text{V}/\text{m}) = \text{Limit}_{30\text{m}}(\text{dB}\mu\text{V}/\text{m}) + 40\text{Log}(30\text{m}/3\text{m})$$



**(3) Limit for this EUT**

The emissions appearing within 15.205 restricted frequency bands shall not exceed the limits shown in 15.209, and the emissions appearing within RSS-Gen section 8.10 Restricted frequency bands shall not exceed the limits shown in RSS-Gen section 8.9, all the other emissions shall be at least 20 dB below the fundamental emissions or comply with 15.209 limits and RSS-Gen section 8.9 limits.

**9.3. Test Procedure**

- (1) EUT was placed on a non-metallic table, 80 cm above the ground plane inside a semi-anechoic chamber for below 1 G and 150 cm above the ground plane inside a semi-anechoic chamber for above 1 G.
- (2) Test antenna was located 3 m from the EUT on an adjustable mast, and the antenna used as below table.

Test frequency range	Test antenna used	Test antenna distance
9 kHz - 30 MHz	Active Loop antenna	3 m
30 MHz - 1 GHz	Trilog Broadband Antenna	3 m
1 GHz - 18 GHz	Double Ridged Horn Antenna (1 GHz - 18 GHz)	3 m
18 GHz - 40 GHz	Horn Antenna (18 GHz - 40 GHz)	1 m

According ANSI C63.10:2013 clause 6.4.4.2 and 6.5.3, for measurements below 30 MHz, the loop antenna was positioned with its plane vertical from the EUT and rotated about its vertical axis for maximum response at each azimuth position around the EUT. And the loop antenna also is positioned with its plane horizontal at the specified distance from the EUT. The center of the loop is 1 m above the ground. For measurement above 30 MHz, the Trilog Broadband Antenna or Horn Antenna was located 3 m from EUT, Measurements were made with the antenna positioned in both the horizontal and vertical planes of Polarization, and the measurement antenna was varied from 1 m to 4 m. in height above the reference ground plane to obtain the maximum signal strength.

- (3) Below pre-scan procedure was first performed in order to find prominent frequency spectrum radiated emissions from 9 kHz to 25 GHz:
- Scanning the peak frequency spectrum with the antenna specified in step (3), and the EUT was rotated 360 degree, the antenna height was varied from 1 m to 4 m (Except loop antenna, it's fixed 1 m above ground.)
  - Change work frequency or channel of device if practicable.
  - Change modulation type of device if practicable.
  - Change power supply range from 85% to 115% of the rated supply voltage
  - Rotated EUT though three orthogonal axes to determine the attitude of EUT arrangement produces highest emissions.

Spectrum frequency from 9 kHz to 25 GHz (tenth harmonic of fundamental frequency) was investigated, and no any obvious emission were detected from 9 kHz to 30 MHz and 18 GHz to 25 GHz, so below final test was performed with frequency range from 30 MHz to 18 GHz.

- (4) For final emissions measurements at each frequency of interest, the EUT was rotated and the antenna height was varied between 1 m and 4 m in order to maximize the emission. Measurements in both horizontal and vertical polarities were made and the data was recorded. In order to find the maximum emission, the relative positions of equipments and all of the interface cables were changed according to ANSI C63.10:2013 on Radiated Emission test.
- (5) The emissions from 9 kHz to 1 GHz were measured based on CISPR QP detector except for the frequency bands 9 - 90 kHz, 110 - 490 kHz, for emissions from 9 kHz - 90 kHz, 110 kHz - 490 kHz and above 1 GHz were measured based on average detector, for emissions above 1 GHz, peak emissions also be measured and need comply with Peak limit.
- (6) The emissions from 9 kHz to 1 GHz, QP or average values were measured with EMI receiver with below RBW

Frequency band	RBW
9 kHz - 150 kHz	200 Hz
150 kHz - 30 MHz	9 kHz
30 MHz - 1 GHz	120 kHz

- (7) For emissions above 1 GHz, both Peak and Average level were measured with Spectrum Analyzer, and the RBW is set at 1 MHz, VBW is set at 3 MHz for Peak measure; According ANSI C63.10:2013 clause 4.1.4.2.2 procedure for average measure.

#### 9.4. Test result

Pass. (See below detailed test result)

All the emissions except fundamental emission from 9 kHz to 25 GHz were comply with 15.209 limits and RSS-Gen section 8.9 limits.

Note1: According exploratory test, the emission levels are 20 dB below the limit detected from 9 kHz to 30 MHz and 18 GHz to 25 GHz, so the final test was performed with frequency range from 30 MHz to 18 GHz and recorded in below.

Note2: For emissions above 1 GHz. If peak results comply with AV limit, AV Result is deemed to comply with AV limit.

# Radiated Emission test (below 1 GHz)

## TR-4-E-009 Radiated Emission Test Result

**Test Date:** 2023-07-06      **Tested By:** Bairong  
**EUT:** 800LR Z-Wave GPIO module      **Model:** ZAC93 LR  
**Test Mode:** TX Mode      **Number:** ZAC93 LR  
**Condition:** Temp:20.4°C;Humi:63.5%      **Power Supply:** DC 3.3V  
**File Path:** d:\ts\2023 report data\Q23060515-1E ZAC93 LR\FCC BELOW 1G\20230706-012528\_H  
**Memo:** 912MHz POWER120

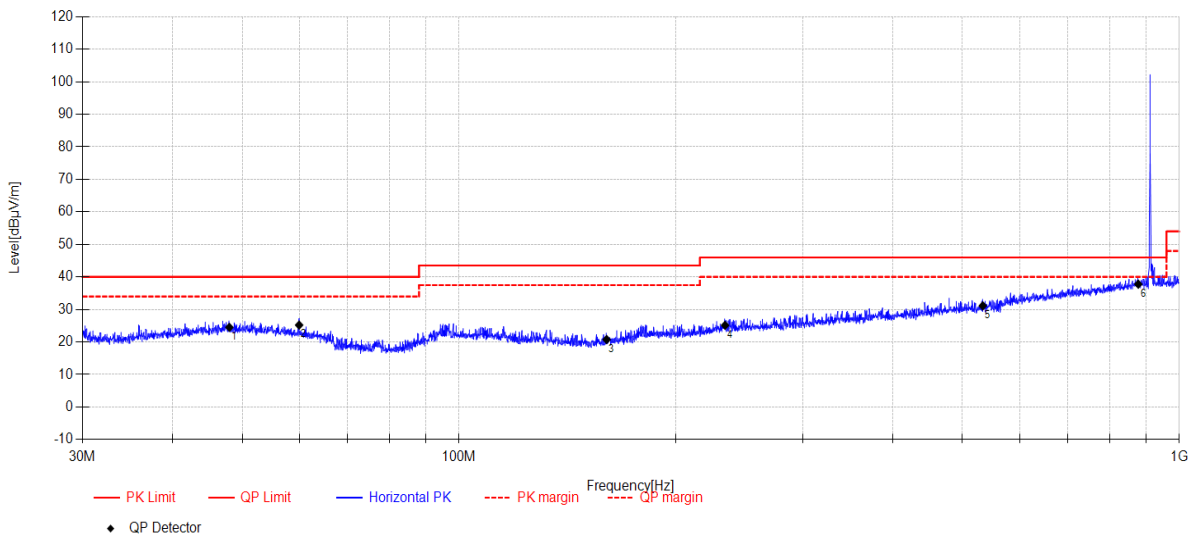

Final Data List										
NO.	Freq. [MHz]	Reading [dBµV/m]	Antenna Factor [dB]	Cable Loss [dB]	AMP [dB]	Result [dBµV/m]	Limit [dBµV/m]	Margin [dB]	Detector	Polarity
1	47.99	6.61	13.20	4.70	0.00	24.51	40.00	15.49	QP	Horizontal
2	59.98	8.55	11.90	4.76	0.00	25.21	40.00	14.79	QP	Horizontal
3	160.29	7.36	8.00	5.40	0.00	20.76	43.50	22.74	QP	Horizontal
4	234.07	7.4	11.86	5.87	0.00	25.13	46.00	20.87	QP	Horizontal
5	533.52	6.6	17.47	7.06	0.00	31.13	46.00	14.87	QP	Horizontal
6	877.11	7.22	22.30	8.26	0.00	37.78	46.00	8.22	QP	Horizontal

**Note:**

1. Result Level = Reading + Cable loss + Antenna Factor + AMP
2. If Peak Result complies with QP limit, QP Result is deemed to comply with QP limit.
3. Test setup: RBW: 120 kHz, VBW: 300 kHz, Sweep time: auto.



# TR-4-E-009 Radiated Emission Test Result

**Test Date:** 2023-07-06 **Tested By:** Bairong  
**EUT:** 800LR Z-Wave GPIO module **Model:** ZAC93 LR  
**Test Mode:** TX Mode **Number:** ZAC93 LR  
**Condition:** Temp:20.4°C;Humi:63.5% **Power Supply:** DC 3.3V  
**File Path:** d:\ts\2023 report data\Q23060515-1E ZAC93 LR\FCC BELOW 1G\20230706-012618\_V  
**Memo:** 912MHz POWER120

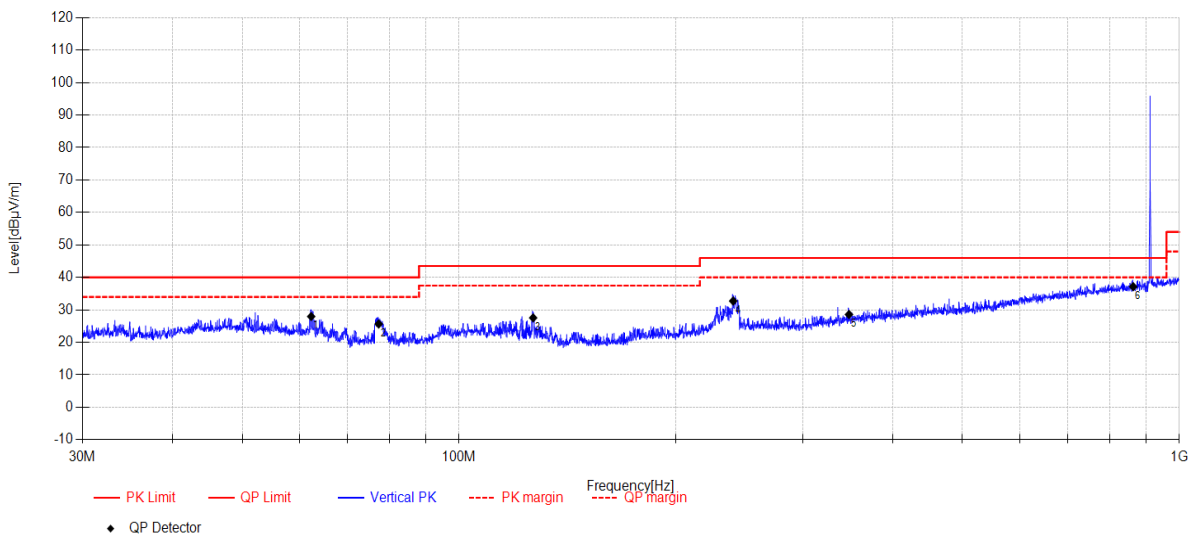

Final Data List										
NO.	Freq. [MHz]	Reading [dBµV/m]	Antenna Factor [dB]	Cable Loss [dB]	AMP [dB]	Result [dBµV/m]	Limit [dBµV/m]	Margin [dB]	Detector	Polarity
1	62.33	11.9	11.30	4.77	0.00	27.97	40.00	12.03	QP	Vertical
2	77.36	13.86	7.00	4.81	0.00	25.67	40.00	14.33	QP	Vertical
3	126.74	14.32	8.03	5.20	0.00	27.55	43.50	15.95	QP	Vertical
4	240.22	14.83	12.01	5.90	0.00	32.74	46.00	13.26	QP	Vertical
5	347.86	7.63	14.56	6.41	0.00	28.60	46.00	17.40	QP	Vertical
6	863.08	6.84	22.10	8.21	0.00	37.15	46.00	8.85	QP	Vertical

**Note:**

1. Result Level = Reading + Cable loss + Antenna Factor + AMP
2. If Peak Result complies with QP limit, QP Result is deemed to comply with QP limit.
3. Test setup: RBW: 120 kHz, VBW: 300 kHz, Sweep time: auto.

# TR-4-E-009 Radiated Emission Test Result

**Test Date:** 2023-07-06      **Tested By:** Bairong  
**EUT:** 800LR Z-Wave GPIO module      **Model:** ZAC93 LR  
**Test Mode:** TX Mode      **Number:**  
**Condition:** Temp:20.4°C;Humi:63.5%      **Power Supply:** DC 3.3V  
**File Path:** d:\ts\2023 report data\Q23060515-1E ZAC93 LR\FCC BELOW 1G\20230706-012927\_H  
**Memo:** 920MHz POWER120

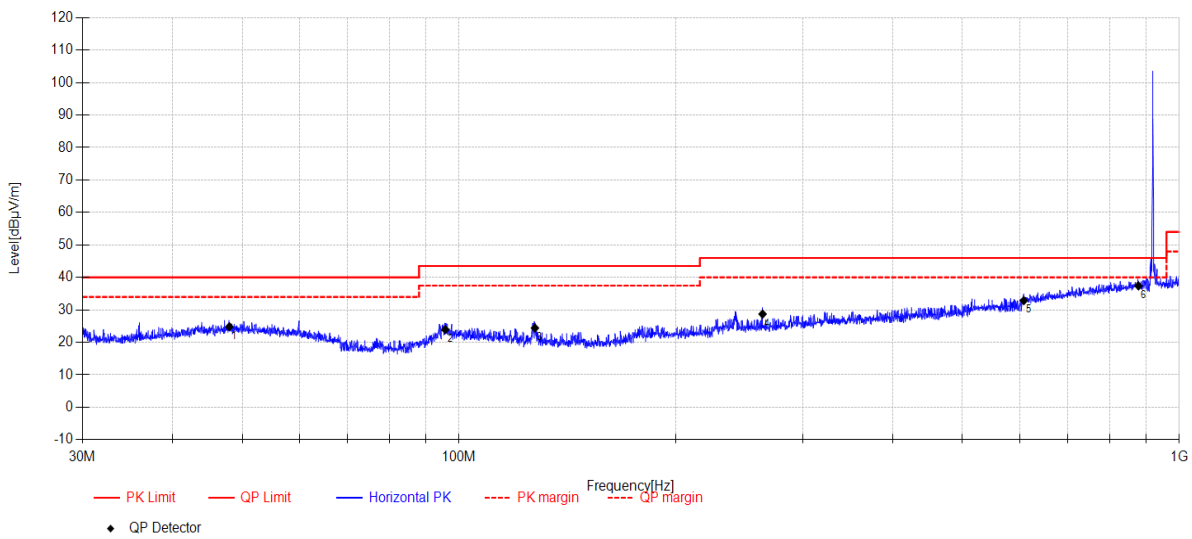

Final Data List										
NO.	Freq. [MHz]	Reading [dBµV/m]	Antenna Factor [dB]	Cable Loss [dB]	AMP [dB]	Result [dBµV/m]	Limit [dBµV/m]	Margin [dB]	Detector	Polarity
1	47.99	6.91	13.20	4.70	0.00	24.81	40.00	15.19	QP	Horizontal
2	95.67	8.49	10.43	5.02	0.00	23.94	43.50	19.56	QP	Horizontal
3	127.45	11.24	7.96	5.21	0.00	24.41	43.50	19.09	QP	Horizontal
4	263.89	10.15	12.58	6.00	0.00	28.73	46.00	17.27	QP	Horizontal
5	608.27	6.72	18.77	7.37	0.00	32.86	46.00	13.14	QP	Horizontal
6	877.73	6.83	22.30	8.26	0.00	37.39	46.00	8.61	QP	Horizontal

**Note:**

1. Result Level = Reading + Cable loss + Antenna Factor + AMP
2. If Peak Result complies with QP limit, QP Result is deemed to comply with QP limit.
3. Test setup: RBW: 120 kHz, VBW: 300 kHz, Sweep time: auto.

# TR-4-E-009 Radiated Emission Test Result

**Test Date:** 2023-07-06      **Tested By:** Bairong  
**EUT:** 800LR Z-Wave GPIO module      **Model:** ZAC93 LR  
**Test Mode:** TX Mode      **Number:**  
**Condition:** Temp:20.4°C;Humi:63.5%      **Power Supply:** DC 3.3V  
**File Path:** d:\ts\2023 report data\Q23060515-1E ZAC93 LR\FCC BELOW 1G\20230706-013017\_V  
**Memo:** 920MHz POWER120

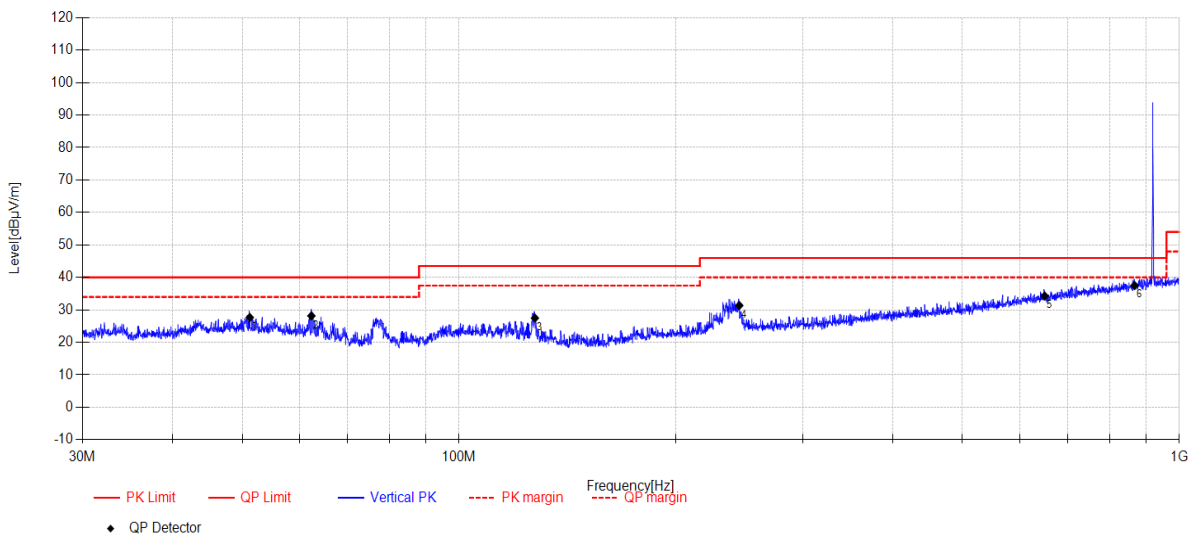

Final Data List										
NO.	Freq. [MHz]	Reading [dBµV/m]	Antenna Factor [dB]	Cable Loss [dB]	AMP [dB]	Result [dBµV/m]	Limit [dBµV/m]	Margin [dB]	Detector	Polarity
1	51.22	9.85	13.08	4.73	0.00	27.66	40.00	12.34	QP	Vertical
2	62.38	12.09	11.29	4.77	0.00	28.15	40.00	11.85	QP	Vertical
3	127.45	14.32	7.96	5.21	0.00	27.49	43.50	16.01	QP	Vertical
4	244.99	13.24	12.20	5.92	0.00	31.36	46.00	14.64	QP	Vertical
5	650.17	7.54	19.20	7.55	0.00	34.29	46.00	11.71	QP	Vertical
6	866.72	7.18	22.13	8.22	0.00	37.53	46.00	8.47	QP	Vertical

**Note:**

1. Result Level = Reading + Cable loss + Antenna Factor + AMP
2. If Peak Result complies with QP limit, QP Result is deemed to comply with QP limit.
3. Test setup: RBW: 120 kHz, VBW: 300 kHz, Sweep time: auto.

## TR-4-E-009 Radiated Emission Test Result

**Test Date:** 2023-07-06  
**EUT:** 800LR Z-Wave GPIO module  
**Test Mode:** TX Mode  
**Condition:** Temp:20.4°C;Humi:63.5%  
**File Path:** d:\ts\2023 report data\Q23060515-1E ZAC93 LR\FCC BELOW 1G\20230706-012210\_H  
**Memo:** 912MHz POWER120

**Tested By:** Bairong  
**Model Number:** ZAC93 LR  
**Power Supply:** DC 3.3V  
**Test Site:** DDT 3# Chamber

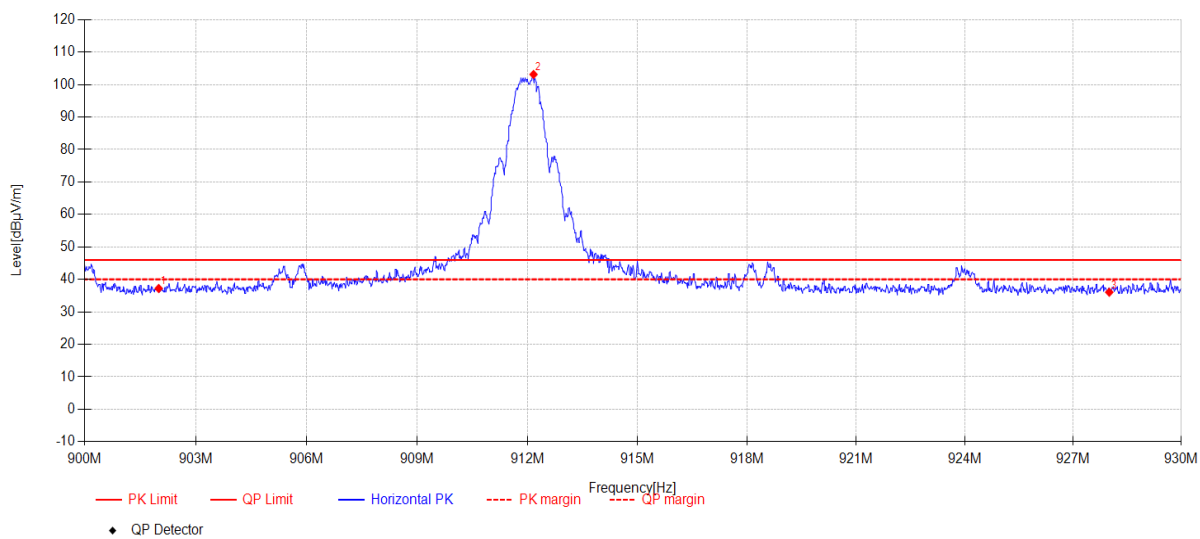

NO.	Freq. [MHz]	Reading [dBµV/m]	Antenna Factor [dB]	Cable loss [dB]	Level [dBµV/m]	Limit [dBµV/m]	Margin [dB]	Detector	Polarity
1	902.00	6.46	22.40	8.35	37.21	46.00	8.79	PK	Horizontal
2	912.17	72.25	22.50	8.38	103.13	46.00	-57.13	PK	Horizontal
3	928.00	5.13	22.50	8.44	36.07	46.00	9.93	PK	Horizontal

### Note:

1. Result Level = Reading + Cable loss + Antenna Factor + AMP
2. If Peak Result complies with QP limit, QP Result is deemed to comply with QP limit.
3. Test setup: RBW: 120 kHz, VBW: 300 kHz, Sweep time: auto.

# TR-4-E-009 Radiated Emission Test Result

**Test Date:** 2023-07-06 **Tested By:** Bairong  
**EUT:** 800LR Z-Wave GPIO module **Model:** ZAC93 LR  
**Test Mode:** TX Mode **Number:** ZAC93 LR  
**Condition:** Temp:20.4°C;Humi:63.5% **Power Supply:** DC 3.3V  
**File Path:** d:\ts\2023 report data\Q23060515-1E ZAC93 LR\FCC BELOW 1G\20230706-012259\_V  
**Memo:** 912MHz POWER120

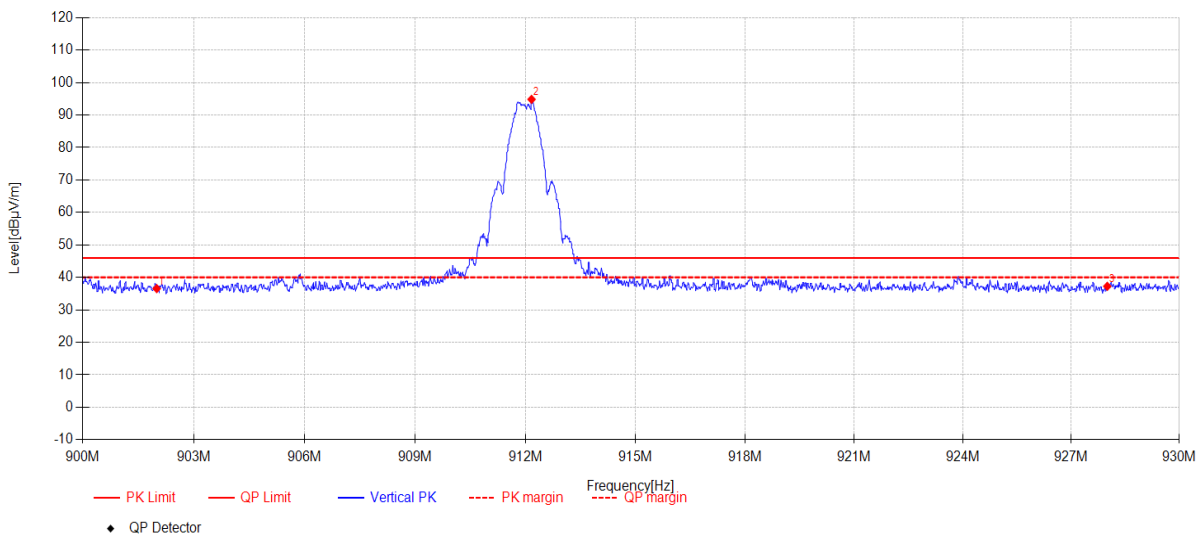

NO.	Freq. [MHz]	Reading [dBµV/m]	Antenna Factor [dB]	Cable loss [dB]	Level [dBµV/m]	Limit [dBµV/m]	Margin [dB]	Detector	Polarity
1	902.00	5.81	22.40	8.35	36.56	46.00	9.44	PK	Vertical
2	912.17	63.96	22.50	8.38	94.84	46.00	-48.84	PK	Vertical
3	928.00	6.33	22.50	8.44	37.27	46.00	8.73	PK	Vertical

**Note:**

1. Result Level = Reading + Cable loss + Antenna Factor + AMP
2. If Peak Result complies with QP limit, QP Result is deemed to comply with QP limit.
3. Test setup: RBW: 120 kHz, VBW: 300 kHz, Sweep time: auto.

# TR-4-E-009 Radiated Emission Test Result

**Test Date:** 2023-07-06      **Tested By:** Bairong  
**EUT:** 800LR Z-Wave GPIO module      **Model Number:** ZAC93 LR  
**Test Mode:** TX Mode      **Power Supply:** DC 3.3V  
**Condition:** Temp:20.4°C;Humi:63.5%      **Test Site:** DDT 3# Chamber  
**File Path:** d:\ts\2023 report data\Q23060515-1E ZAC93 LR\FCC BELOW 1G\85  
**Memo:** 920MHz POWER120

## Test Graph

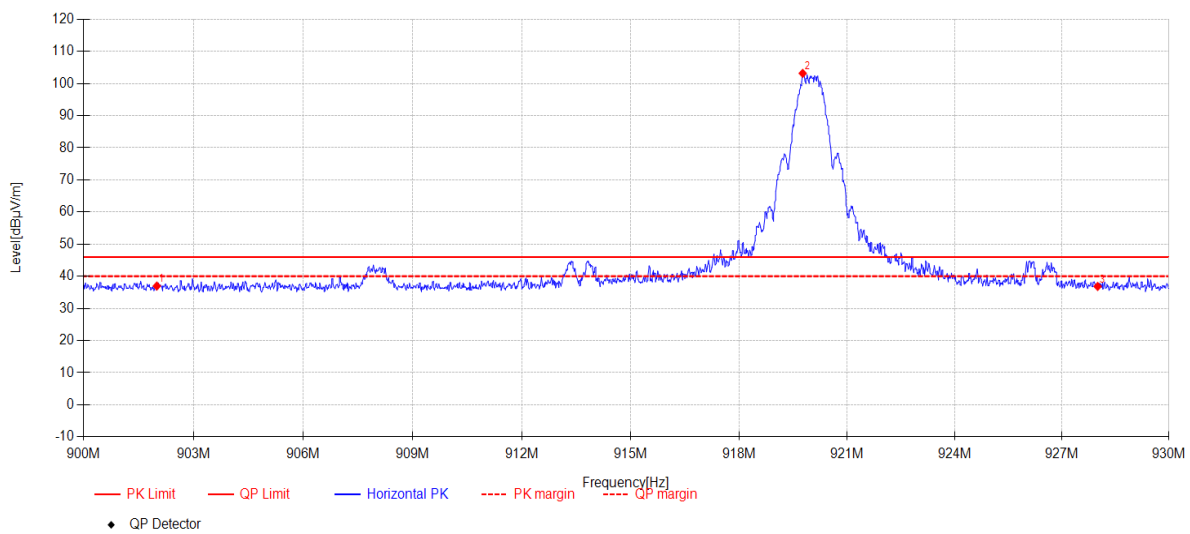

NO.	Freq. [MHz]	Reading [dBµV/m]	Cable loss [dB]	Antenna Factor [dB]	Level [dBµV/m]	Limit [dBµV/m]	Margin [dB]	Detector	Polarity
1	902.00	6.22	8.35	22.40	36.97	46.00	9.03	PK	Horizontal
2	919.77	72.26	8.41	22.50	103.17	46.00	-57.17	PK	Horizontal
3	928.00	5.92	8.44	22.50	36.86	46.00	9.14	PK	Horizontal

### Note:

1. Level = Reading + Cable loss + Antenna Factor + AMP
2. If Peak Result complies with AV limit, AV Result is deemed to comply with AV limit.
3. Test setup: RBW: 1 MHz, VBW: 3 MHz, Sweep time: auto.





## Radiated Emission test (above 1 GHz)

## TR-4-E-009 Radiated Emission Test Result

**Test Date:** 2023-07-06 **Tested By:** Bairong  
**EUT:** 800LR Z-Wave GPIO module **Model Number:** ZAC93 LR  
**Test Mode:** TX Mode **Power Supply:** DC 3.3V  
**Condition:** Temp:20.4°C;Humi:63.5% **Test Site:** DDT 3# Chamber  
**File Path:** d:\ts\2023 report data\Q23060515-1E ZAC93 LR\FCC ABOVE 1G\31  
**Memo:** 920MHz POWER120

## Test Graph

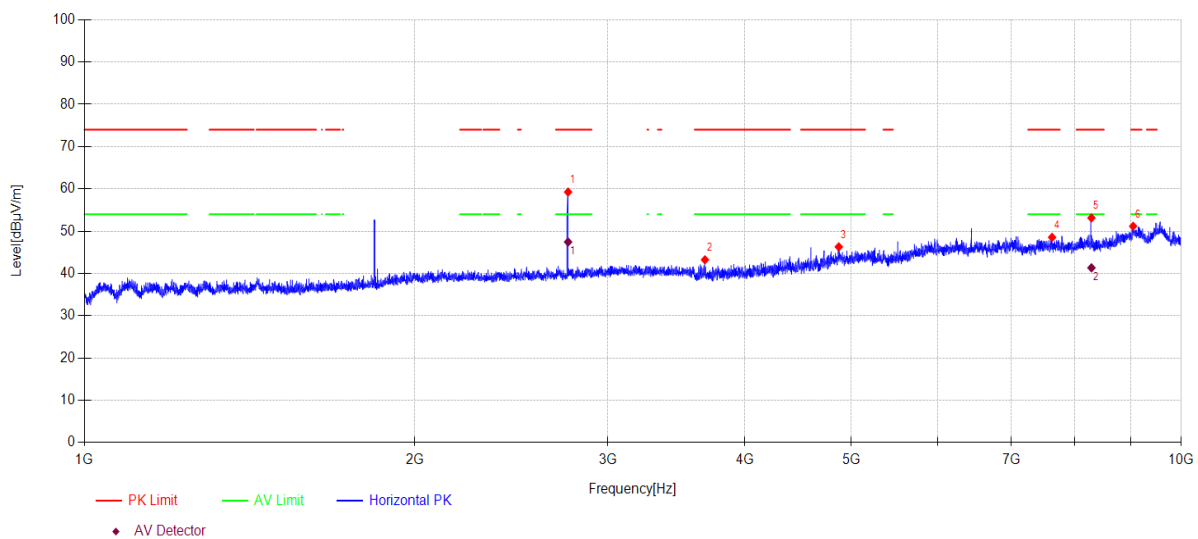

## Suspected Data List

NO	Freq. [MHz]	Reading [dBµV/m]	Cable loss [dB]	Antenna Factor [dB]	AMP [dB]	Level [dBµV/m]	Limit [dBµV/m]	Margin [dB]	Detector	Polarity
1	2760.30	65.63	5.74	28.42	-40.54	59.25	74.00	14.75	PK	Horizontal
2	3679.12	48.74	5.78	29.92	-41.21	43.23	74.00	30.77	PK	Horizontal
3	4872.27	47.29	7.61	32.54	-41.14	46.30	74.00	27.70	PK	Horizontal
4	7624.51	45.45	7.65	36.45	-41.00	48.55	74.00	25.45	PK	Horizontal
5	8281.48	48.55	7.98	37.16	-40.55	53.14	74.00	20.86	PK	Horizontal
6	9038.67	43.67	8.74	38.20	-39.45	51.16	74.00	22.84	PK	Horizontal

## Final Data List

NO	Freq. [MHz]	Reading [dBµV/m]	Cable loss [dB]	Antenna Factor [dB]	AMP [dB]	Level [dBµV/m]	Limit [dBµV/m]	Margin [dB]	Detector	Polarity
1	2760.30	\	\	\	\	47.43	54.00	6.57	AV	Horizontal
2	8281.48	\	\	\	\	41.32	54.00	12.68	AV	Horizontal

## Note:

- Level = Reading + Cable loss + Antenna Factor + AMP
- If Peak Result complies with AV limit, AV Result is deemed to comply with AV limit.
- Test setup: RBW: 1 MHz, VBW: 3 MHz, Sweep time: auto.
- The duty cycle of test signal is 25.653%, duty cycle factor is -11.82, refer to section 8.4.

## TR-4-E-009 Radiated Emission Test Result

**Test Date:** 2023-07-06 **Tested By:** Bairong  
**EUT:** 800LR Z-Wave GPIO module **Model Number:** ZAC93 LR  
**Test Mode:** TX Mode **Power Supply:** DC 3.3V  
**Condition:** Temp:20.4°C;Humi:63.5% **Test Site:** DDT 3# Chamber  
**File Path:** d:\ts\2023 report data\Q23060515-1E ZAC93 LR\FCC ABOVE 1G\32  
**Memo:** 920MHz POWER120

### Test Graph

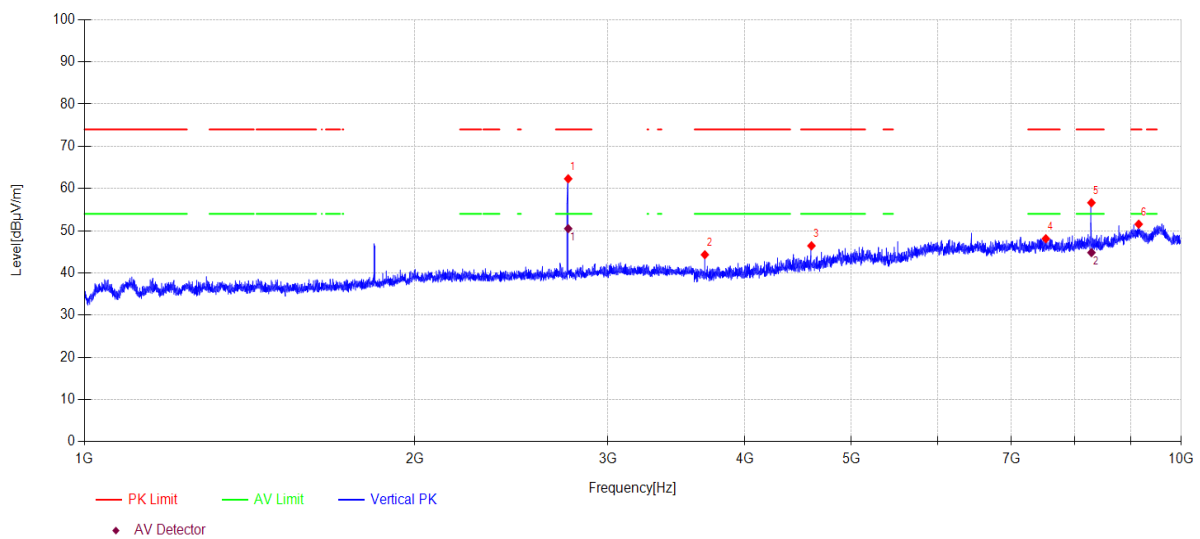

### Suspected Data List

NO	Freq. [MHz]	Reading [dBμV/m]	Cable loss [dB]	Antenna Factor [dB]	AMP [dB]	Level [dBμV/m]	Limit [dBμV/m]	Margin [dB]	Detector	Polarity
1	2760.93	68.68	5.74	28.42	-40.54	62.30	74.00	11.70	PK	Vertical
2	3678.27	49.84	5.78	29.91	-41.21	44.32	74.00	29.68	PK	Vertical
3	4600.80	48.89	7.06	31.70	-41.22	46.43	74.00	27.57	PK	Vertical
4	7525.10	45.06	7.65	36.40	-41.00	48.11	74.00	25.89	PK	Vertical
5	8281.48	52.04	7.98	37.16	-40.55	56.63	74.00	17.37	PK	Vertical
6	9145.42	44.07	8.76	38.29	-39.57	51.55	74.00	22.45	PK	Vertical

### Final Data List

NO	Freq. [MHz]	Reading [dBμV/m]	Cable loss [dB]	Antenna Factor [dB]	AMP [dB]	Level [dBμV/m]	Limit [dBμV/m]	Margin [dB]	Detector	Polarity
1	2760.93	\	\	\	\	50.48	54.00	3.52	AV	Vertical
2	8281.48	\	\	\	\	44.81	54.00	9.19	AV	Vertical

### Note:

- Level = Reading + Cable loss + Antenna Factor + AMP
- If Peak Result complies with AV limit, AV Result is deemed to comply with AV limit.
- Test setup: RBW: 1 MHz, VBW: 3 MHz, Sweep time: auto.
- The duty cycle of test signal is 25.653%, duty cycle factor is -11.82, refer to section 8.4.

# TR-4-E-009 Radiated Emission Test Result

**Test Date:** 2023-07-06      **Tested By:** Bairong  
**EUT:** 800LR Z-Wave GPIO module      **Model Number:** ZAC93 LR  
**Test Mode:** TX Mode      **Power Supply:** DC 3.3V  
**Condition:** Temp:20.4°C;Humi:63.5%      **Test Site:** DDT 3# Chamber  
**File Path:** d:\ts\2023 report data\Q23060515-1E ZAC93 LR\FCC ABOVE 1G\33  
**Memo:** 912MHz POWER120

## Test Graph

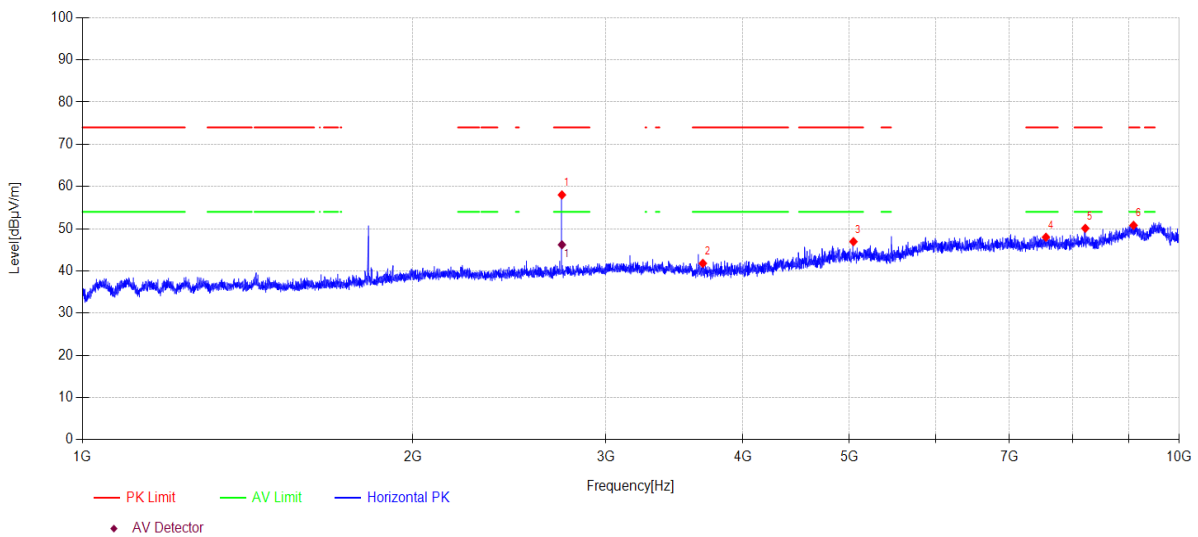

Suspected Data List										
NO	Freq. [MHz]	Reading [dBµV/m]	Cable loss [dB]	Antenna Factor [dB]	AMP [dB]	Level [dBµV/m]	Limit [dBµV/m]	Margin [dB]	Detector	Polarity
1	2736.25	64.40	5.75	28.37	-40.51	58.01	74.00	15.99	PK	Horizontal
2	3678.27	47.32	5.78	29.91	-41.21	41.80	74.00	32.20	PK	Horizontal
3	5045.80	47.19	7.94	32.89	-41.08	46.94	74.00	27.06	PK	Horizontal
4	7558.09	44.94	7.65	36.40	-41.00	47.99	74.00	26.01	PK	Horizontal
5	8209.35	45.77	7.90	37.10	-40.67	50.10	74.00	23.90	PK	Horizontal
6	9084.57	43.35	8.75	38.20	-39.50	50.80	74.00	23.20	PK	Horizontal

Final Data List										
NO	Freq. [MHz]	Reading [dBµV/m]	Cable loss [dB]	Antenna Factor [dB]	AMP [dB]	Level [dBµV/m]	Limit [dBµV/m]	Margin [dB]	Detector	Polarity
1	2736.25	\	\	\	\	46.19	54.00	7.81	AV	Horizontal

**Note:**

1. Level = Reading + Cable loss + Antenna Factor + AMP
2. If Peak Result complies with AV limit, AV Result is deemed to comply with AV limit.
3. Test setup: RBW: 1 MHz, VBW: 3 MHz, Sweep time: auto.
4. The duty cycle of test signal is 25.653%, duty cycle factor is -11.82, refer to section 8.4.

# TR-4-E-009 Radiated Emission Test Result

**Test Date:** 2023-07-06      **Tested By:** Bairong  
**EUT:** 800LR Z-Wave GPIO module      **Model Number:** ZAC93 LR  
**Test Mode:** TX Mode      **Power Supply:** DC 3.3V  
**Condition:** Temp:20.4°C;Humi:63.5%      **Test Site:** DDT 3# Chamber  
**File Path:** d:\ts\2023 report data\Q23060515-1E ZAC93 LR\FCC ABOVE 1G\34  
**Memo:** 912MHz POWER120

## Test Graph

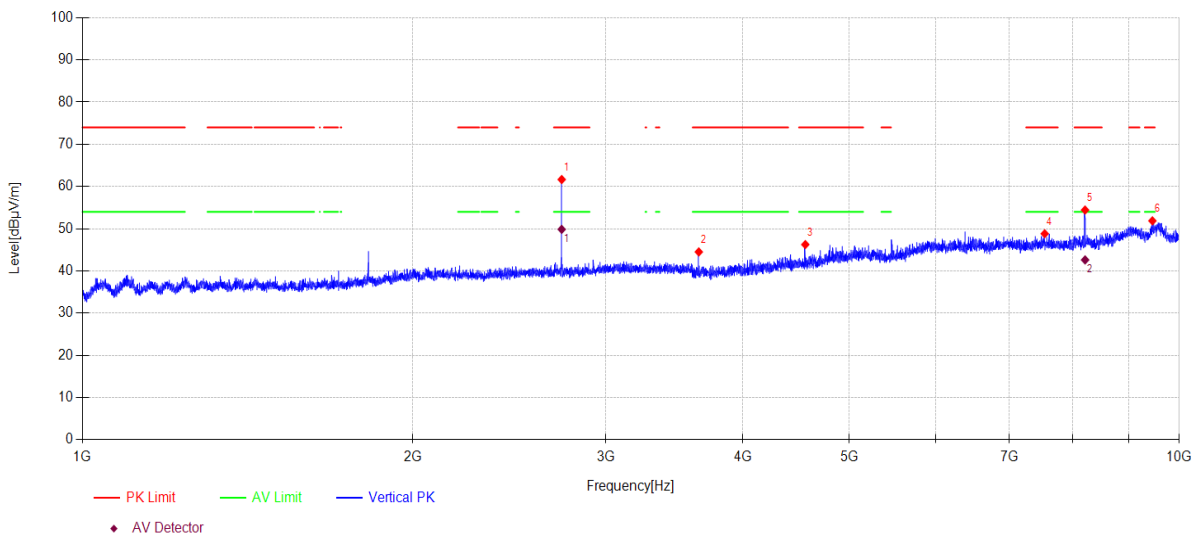

Suspected Data List										
NO	Freq. [MHz]	Reading [dBµV/m]	Cable loss [dB]	Antenna Factor [dB]	AMP [dB]	Level [dBµV/m]	Limit [dBµV/m]	Margin [dB]	Detector	Polarity
1	2734.99	68.05	5.75	28.37	-40.51	61.66	74.00	12.34	PK	Vertical
2	3647.07	50.14	5.77	29.79	-41.19	44.51	74.00	29.49	PK	Vertical
3	4560.73	48.80	6.98	31.70	-41.23	46.25	74.00	27.75	PK	Vertical
4	7538.97	45.77	7.65	36.40	-41.00	48.82	74.00	25.18	PK	Vertical
5	8205.57	50.10	7.90	37.10	-40.67	54.43	74.00	19.57	PK	Vertical
6	9451.54	44.59	8.82	38.40	-39.94	51.87	74.00	22.13	PK	Vertical

Final Data List										
NO	Freq. [MHz]	Reading [dBµV/m]	Cable loss [dB]	Antenna Factor [dB]	AMP [dB]	Level [dBµV/m]	Limit [dBµV/m]	Margin [dB]	Detector	Polarity
1	2734.99	\	\	\	\	49.84	54.00	4.16	AV	Vertical
2	8205.57	\	\	\	\	42.61	54.00	11.39	AV	Vertical

Note:

1. Level = Reading + Cable loss + Antenna Factor + AMP
2. If Peak Result complies with AV limit, AV Result is deemed to comply with AV limit.
3. Test setup: RBW: 1 MHz, VBW: 3 MHz, Sweep time: auto.
4. The duty cycle of test signal is 25.653%, duty cycle factor is -11.82, refer to section 8.4.

## 10. RF Conducted Spurious Emissions

### 10.1. Block diagram of test setup

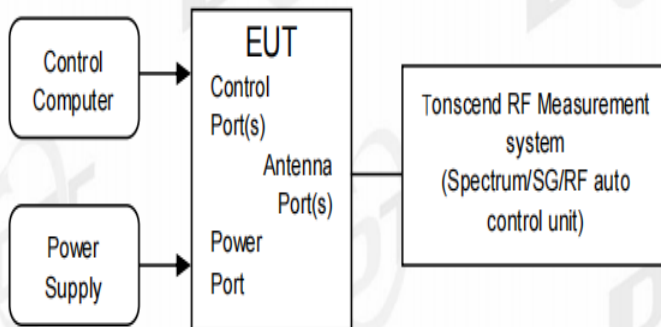

### 10.2. Limits

In any 100 kHz bandwidth outside the frequency bands in which the spread spectrum intentional radiator is operating, the radio frequency power that is produced by the intentional radiator shall be at least 20 dB below that in the 100 kHz bandwidth within the band that contains the highest level of the desired power.

### 10.3. Test procedure

- (1) Connect EUT's antenna output to spectrum analyzer by RF cable.
- (2) Establish a reference level by using the following procedure:
 

RBW:	100 kHz
VBW:	300 kHz
Span	Encompass frequency range to be measured
Detector Mode:	Peak
Sweep time:	Auto
Trace mode	Max hold
- (3) Allow the trace to stabilize, use the peak marker function to determine the maximum peak power level to establish the reference level.
- (4) Then mark the maximum amplitude of all unwanted emissions outside of the authorized frequency band.

### 10.4. Test result

Mode	Frequency (MHz)	Verdict
OQPSK	912	Pass
	920	Pass



### 10.5. Test graphs

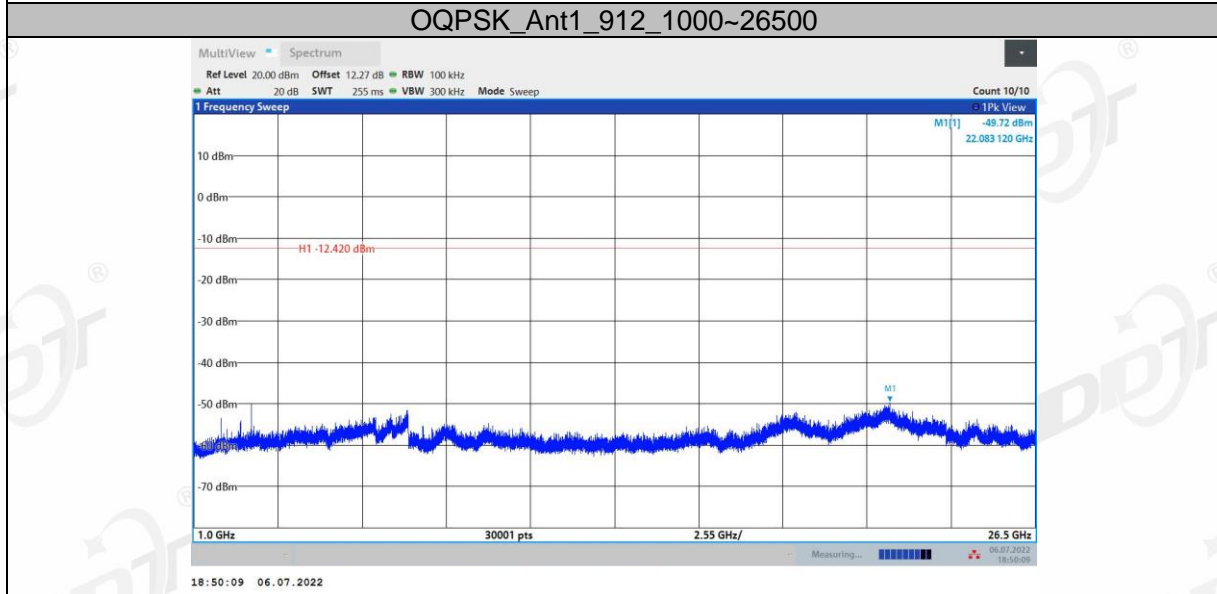
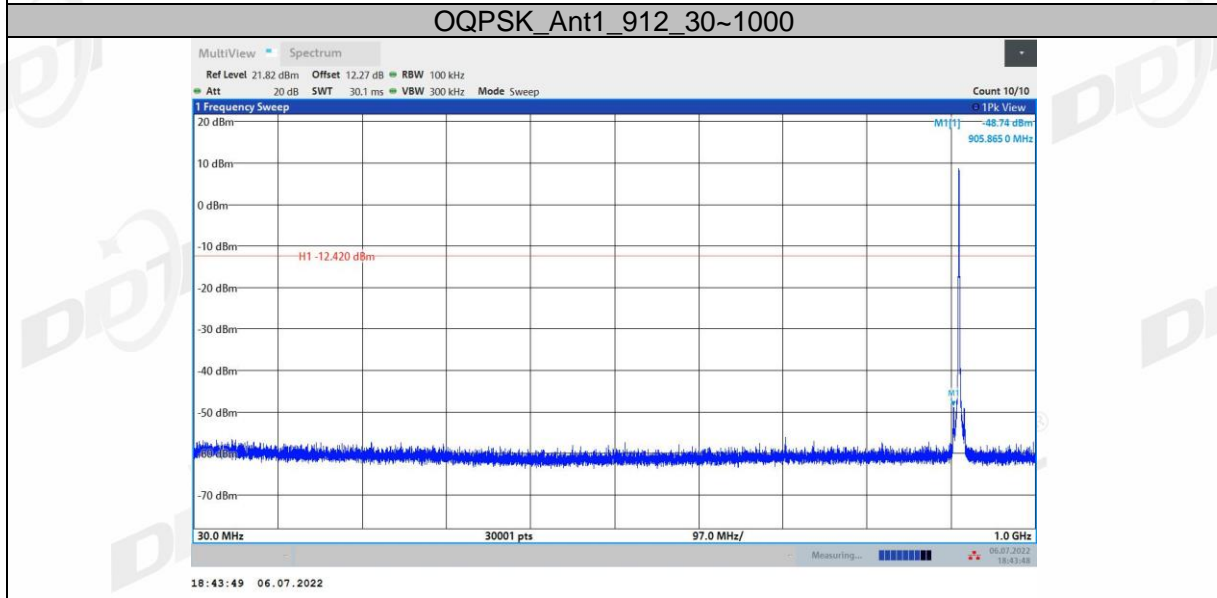
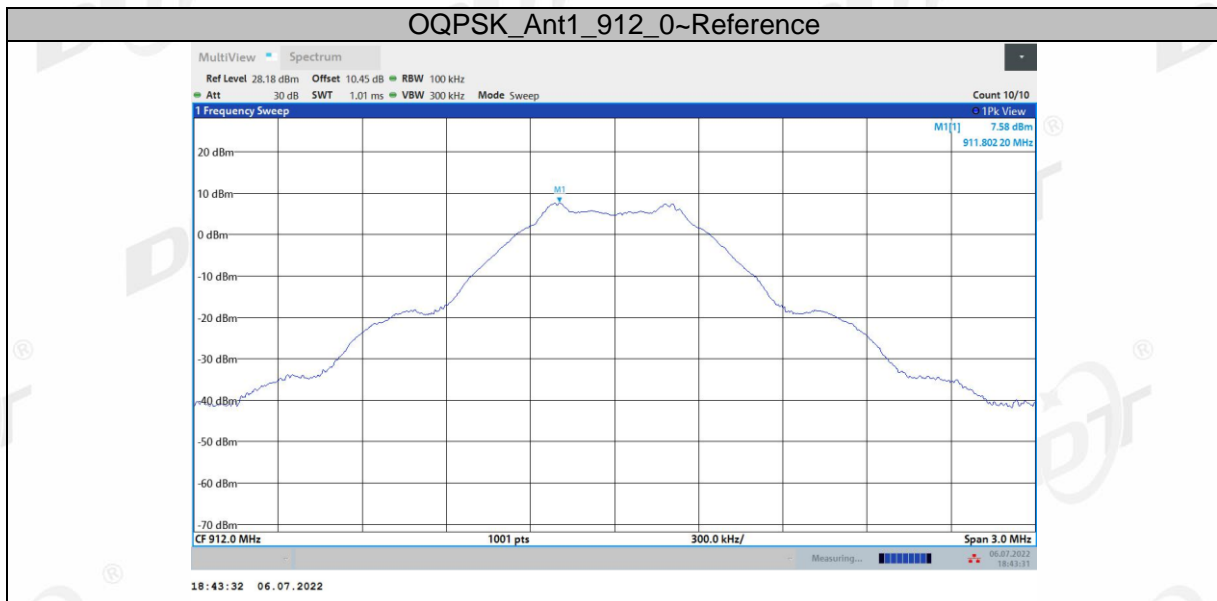

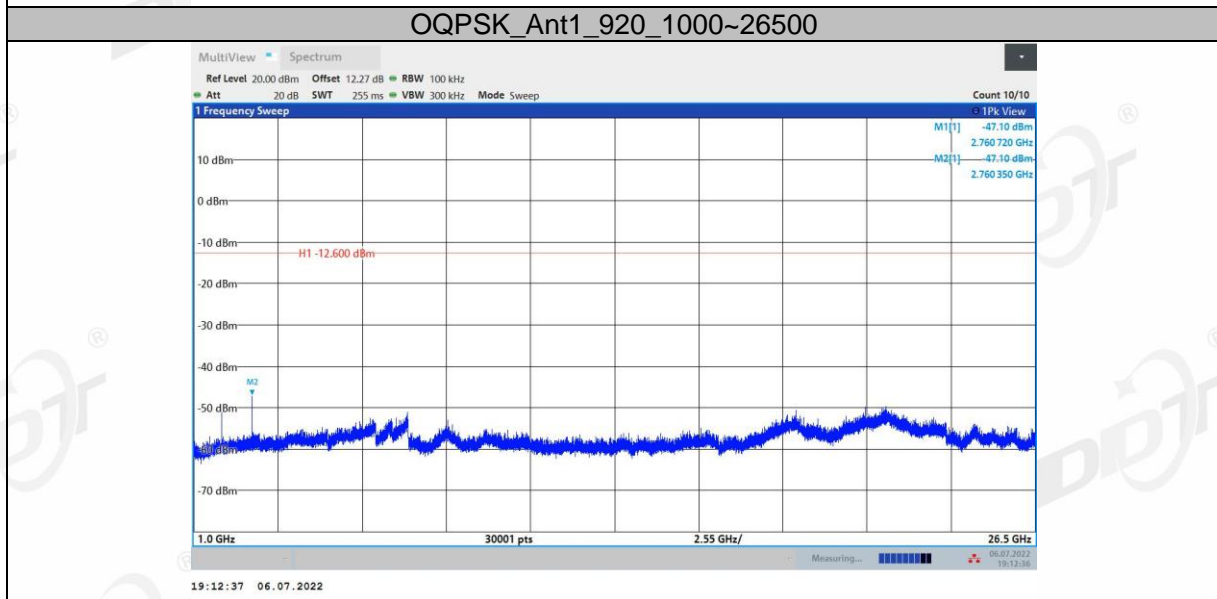
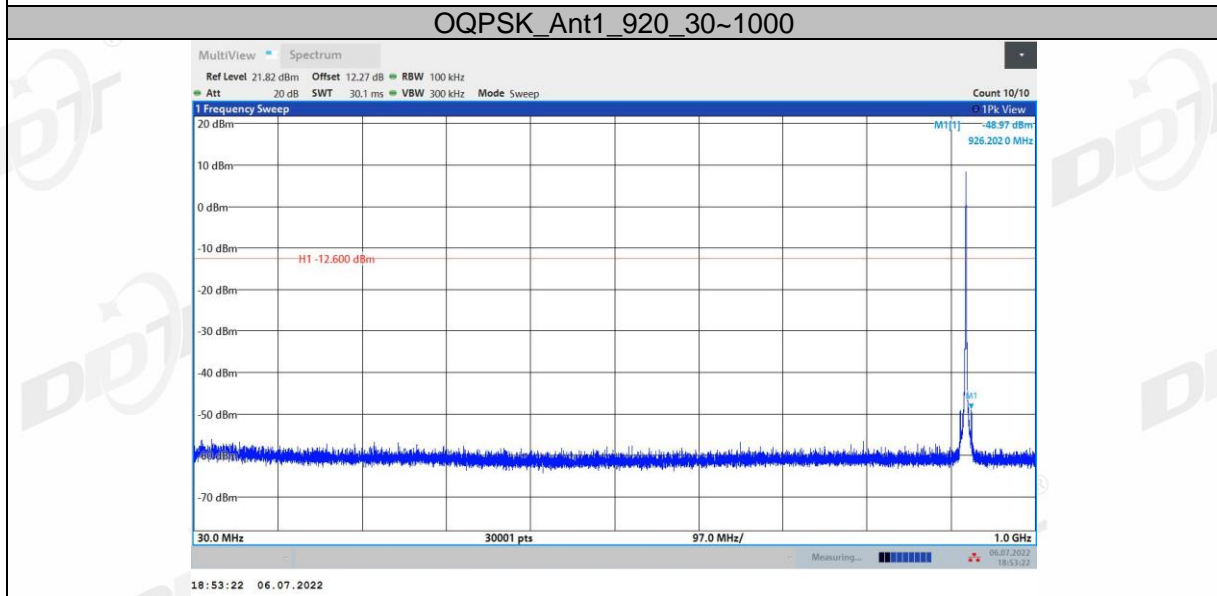
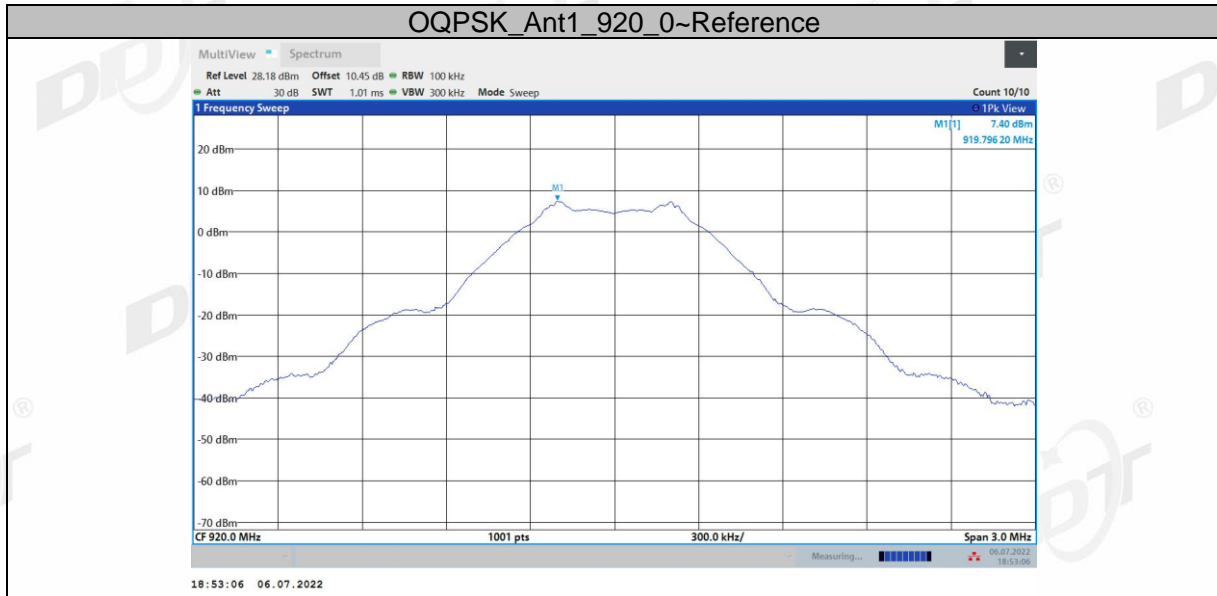

## 11. Power Line Conducted Emission

### 11.1. Block diagram of test setup

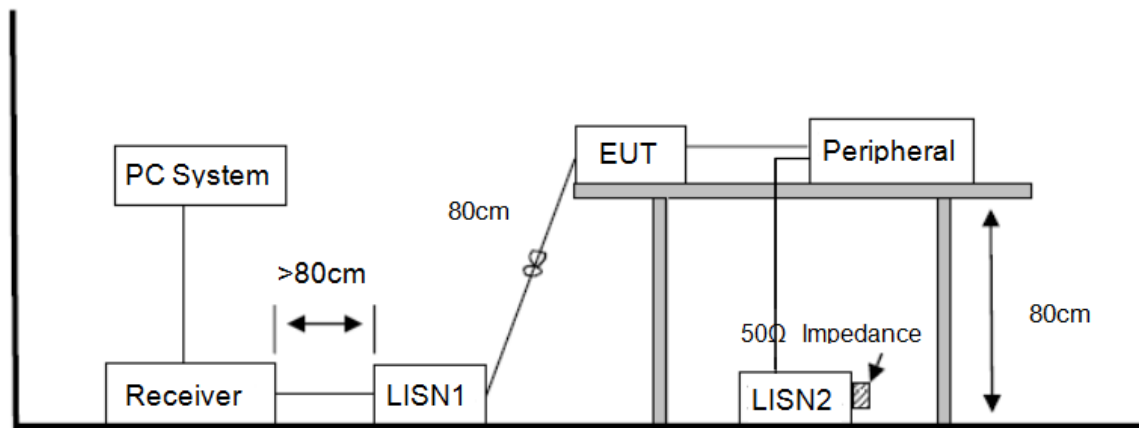

### 11.2. Power line conducted emission limits

Frequency	Quasi-Peak Level dB( $\mu$ V)	Average Level dB( $\mu$ V)
150 kHz ~ 500 kHz	66 ~ 56*	56 ~ 46*
500 kHz ~ 5 MHz	56	46
5 MHz ~ 30 MHz	60	50

Note 1: \* Decreasing linearly with logarithm of frequency.

Note 2: The lower limit shall apply at the transition frequencies.

### 11.3. Test procedure

The EUT and Support equipment, if needed, were put placed on a non-metallic table, 80 cm above the ground plane.

Configuration EUT to simulate typical usage as described in clause 2.4 and test equipment setup as described in clause 13.1 of this report.

All I/O cables were positioned to simulate typical actual usage as per ANSI C63.10.

All support equipment power received from a second LISN.

Emissions were measured on each current carrying line of the EUT using an EMI Test Receiver connected to the LISN powering the EUT.

The Receiver scanned from 150 kHz to 30 MHz for emissions in each of the test modes.

During the above scans, the emissions were maximized by cable manipulation.

The test mode(s) described in clause 2.4 were scanned during the preliminary test.

After the preliminary scan, we found the test mode producing the highest emission level.

The EUT configuration and worse cable configuration of the above highest emission levels were

recorded for reference of the final test.

EUT and support equipment were set up on the test bench as per the configuration with highest emission level in the preliminary test.

A scan was taken on both power lines, Neutral and Line, recording at least the six highest emissions.

Emission frequency and amplitude were recorded into a computer in which correction factors were used to calculate the emission level and compare reading to the applicable limit.

The test data of the worst-case condition(s) was recorded.

The bandwidth of test receiver is set at 9 kHz.

#### **11.4. Test result**

Not applicable, EUT is powered by DC power.

## 12. Antenna Requirements

### 12.1. Limit

For intentional device, according to FCC 47 CFR Section 15.203, an intentional radiator shall be designed to ensure that no antenna other than that furnished by the responsible party shall be used with the device. And according to FCC 47 CFR Section 15.247 (b), if transmitting antennas of directional gain greater than 6 dBi are used, the power shall be reduced by the amount in dB that the directional gain of the antenna exceeds 6 dBi.

### 12.2. Result

The antenna used for this product and that no antenna other than that furnished by the responsible party shall be used with the device, the maximum peak gain is -2.75 dBi.



#### 14. Photos of the EUT

Please refer to Appendix I: Photos of the EUT.

**END OF REPORT**