

# Shenzhen Jiexuntong Wireless Technology Co. LTD

## Antenna acknowledgment

**Customer name: Baoneng Daktron**

**Project model: DPXTH**

**Our company's material number: 20016000005**

**Antenna specification: On-board antenna**

**Date of issue: 2023-1-10**

### Manufacturer acknowledgment column:

Project preparation	RF	structure	approve	Date

### Customer acknowledgement column:

confirm	audit	approve	Date



## Acknowledgement of change of resume

version	Date	Change description	remarks
R/A	2023-1-10	First edition	

## catalogue

1、 COVER.....	PAGE 1
2、 CHANGE OF RESUME.....	PAGE 2
3、 DIRECTORY.....	PAGE 3
4、 ANTENNA PICTURE AND SIZE.....	PAGE 4
5、 TEST THE ENVIRONMENT.....	PAGE 4
6、 ANTENNA MATCHING .....	PAGE 4
7、 ELECTRICAL PERFORMANCE REPORT.....	PAGE 5-14
8、 RELIABILITY TEST REPORT.....	PAGE 15
9、 ENGINEERING DRAWING.....	PAGE 16

Address: 409, 423, 425-426, Building A, No. 30, Sanwei Hanghang Road,  
Sanwei Community, Hangcheng Street, Baoan District, Shenzhen

**Contact number: 0755-23731203**

**website: <http://www.jxtant.com>**





## 一、Antenna picture and size

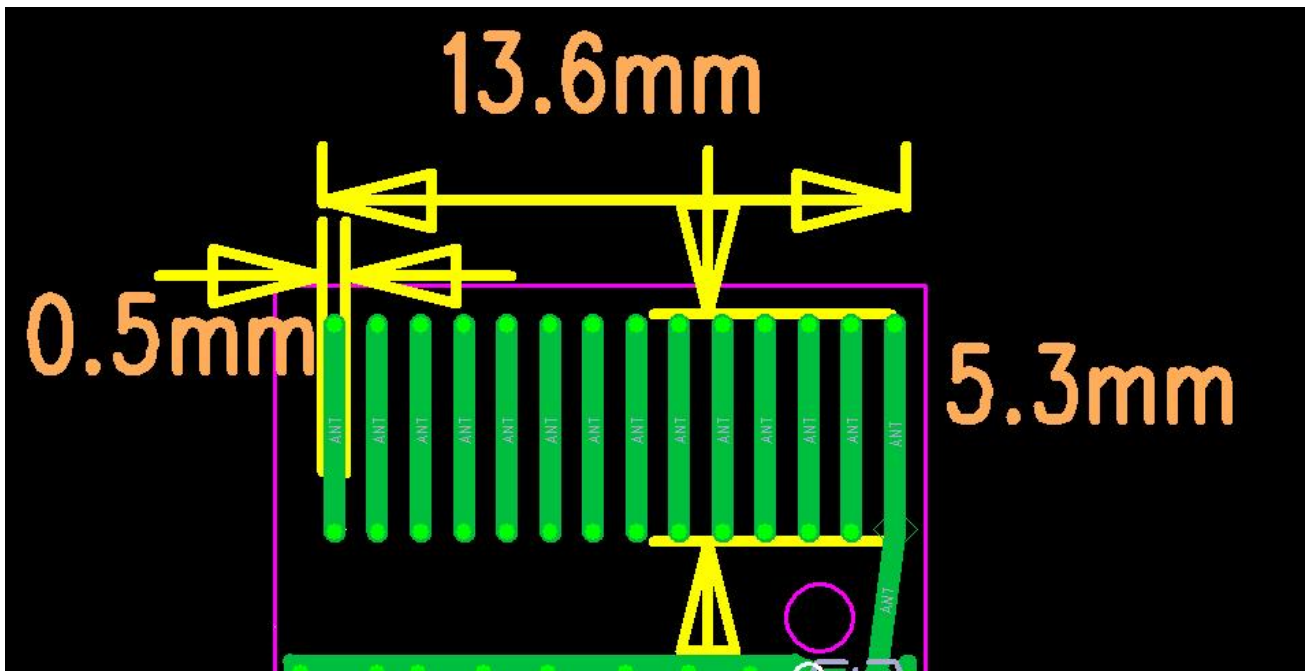

## 二、Test the environment

### 2.1.Environmental treatment

There is no

## 三、Antenna matching

### 3.1.Antenna

This specification belongs to Shenzhen Jiexuntong Wireless Technology Co., Ltd. and relevant customer confidential archives, please keep properly, without our company and relevant customer permission, anyone shall not disclose.。

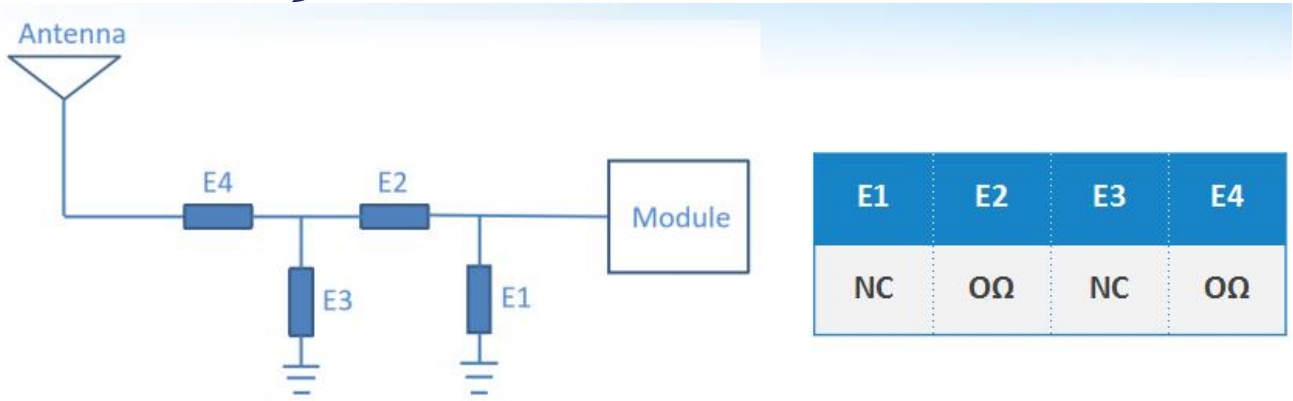

Our company has not changed the original antenna front-end matching

#### 四、Electrical performance report

##### VSWR

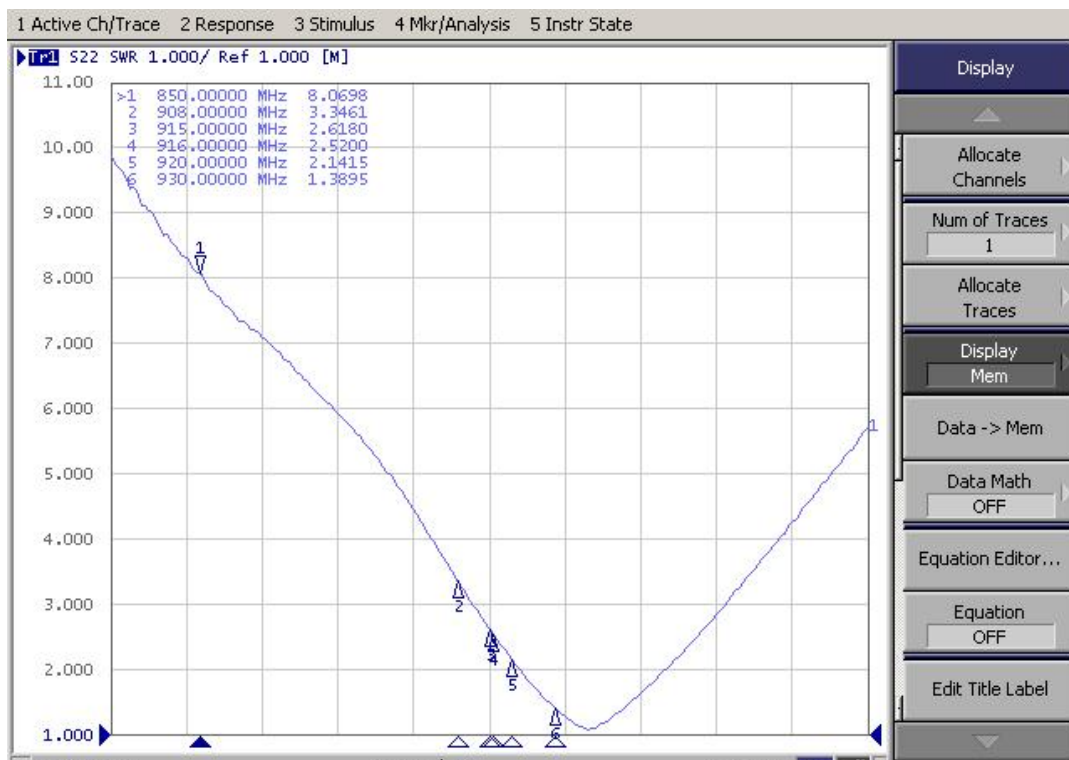

This specification belongs to Shenzhen Jiexuntong Wireless Technology Co., Ltd. and relevant customer confidential archives, please keep properly, without our company and relevant customer permission, anyone shall not disclose.



Frequency (MHz)	850	908	915	916	920	930
VSWR	8.06	3.34	2.61	2.52	2.14	1.38

**Passive test data:**

Freq (MHz)	Gain (dBi)	Efficiency (dB)	Efficiency (%)
850	-7.55	-10.52	9.61
851	-7.49	-10.43	10.07
852	-7.45	-10.33	10.19
853	-7.41	-10.24	10.30
854	-7.35	-10.07	10.59
855	-7.30	-9.91	10.74
856	-7.22	-9.84	10.92
857	-7.11	-9.59	11.25
858	-7.01	-9.43	11.31
859	-6.94	-9.35	11.49
860	-6.85	-9.24	11.57
Freq (MHz)	Gain (dBi)	Efficiency (dB)	Efficiency (%)
861	-6.71	-9.23	11.63
862	-6.62	-9.14	12.15
863	-6.53	-9.11	12.25
864	-6.44	-9.03	12.36
865	-6.32	-8.98	12.54
866	-6.26	-8.93	12.73
867	-6.19	-8.87	12.91
868	-6.11	-8.84	13.17
869	-6.04	-8.80	13.21
870	-5.94	-8.75	13.35
871	-5.93	-8.66	13.46
872	-5.92	-8.64	13.57
873	-5.90	-8.57	13.68
874	-5.88	-8.52	13.83
875	-5.87	-8.51	13.99
876	-5.86	-8.46	14.11
877	-5.84	-8.44	14.23
878	-5.82	-8.42	14.34
879	-5.80	-8.39	14.41
880	-5.79	-8.37	14.50
881	-5.77	-8.35	14.59
882	-5.76	-8.33	14.68
883	-5.74	-8.33	14.70
884	-5.72	-8.33	14.67

This specification belongs to Shenzhen Jiexuntong Wireless Technology Co., Ltd. and relevant customer confidential archives, please keep properly, without our company and relevant customer permission, anyone shall not disclose.



## Shenzhen Jiexuntong Wireless Technology Co. LTD

885	-5.71	-8.34	14.65
886	-5.69	-8.34	14.64
887	-5.67	-8.34	14.61
888	-5.66	-8.36	14.56
889	-5.64	-8.36	14.64
890	-5.63	-8.37	14.61
891	-5.61	-8.33	14.62
892	-5.59	-8.31	14.75
893	-5.57	-8.28	14.84
894	-5.55	-8.25	14.93
895	-5.53	-8.23	14.99
896	-5.52	-8.24	15.01
897	-5.50	-8.23	15.05
898	-5.49	-8.23	15.08
899	-5.47	-8.22	15.05
900	-5.46	-8.21	15.06
901	-5.45	-8.21	15.09
902	-5.44	-8.18	15.20
Freq(MHz)	Gain(dBi)	Efficiency(dB)	Efficiency(%)
903	-5.43	-8.17	15.15
904	-5.41	-8.14	15.23
905	-5.39	-8.10	15.35
906	-5.38	-8.08	15.45
907	-5.36	-8.03	15.56
908	-5.35	-7.97	15.68
909	-5.04	-7.86	15.75
910	-5.01	-7.81	15.84
911	-4.99	-7.71	15.91
912	-4.96	-7.61	16.13
913	-4.95	-7.55	16.26
914	-4.93	-7.43	16.33
915	-4.92	-7.36	17.57
916	-4.89	-7.27	17.77
917	-4.82	-7.16	18.22
918	-4.71	-7.06	19.16
919	-4.66	-6.97	20.08
920	-3.80	-6.88	20.30
921	-3.60	-6.78	20.69
922	-3.49	-6.69	21.05
923	-3.40	-6.60	21.38
924	-3.30	-6.51	22.13
925	-3.19	-6.41	22.56
926	-3.12	-6.33	22.89

This specification belongs to Shenzhen Jiexuntong Wireless Technology Co., Ltd. and relevant customer confidential archives, please keep properly, without our company and relevant customer permission, anyone shall not disclose. .



**Shenzhen Jiexuntong Wireless Technology Co. LTD**

927	-3.00	-6.23	23.30
928	-2.93	-6.15	23.88
929	-2.84	-6.06	24.05
930	-2.75	-5.99	24.19



**Efficiency line graph:**

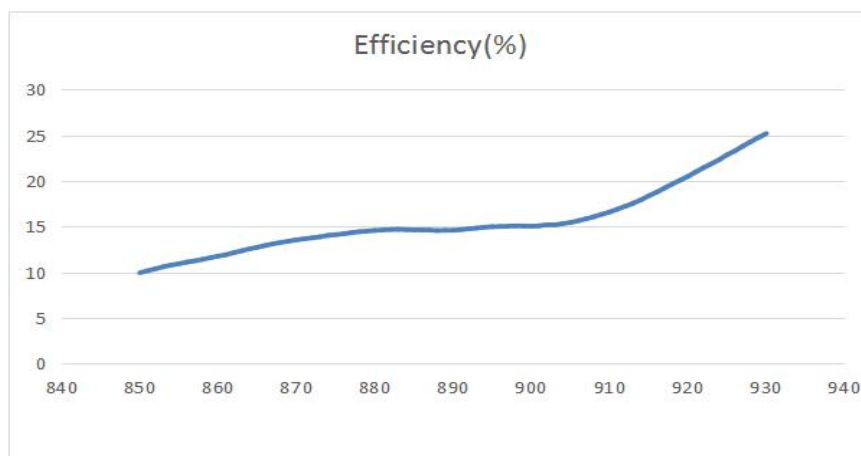

Frequency (MHz)	850	908	915	916	920	930
Efficiency	9.61	15.68	17.57	17.77	20.3	24.19

**Gain line graph:**

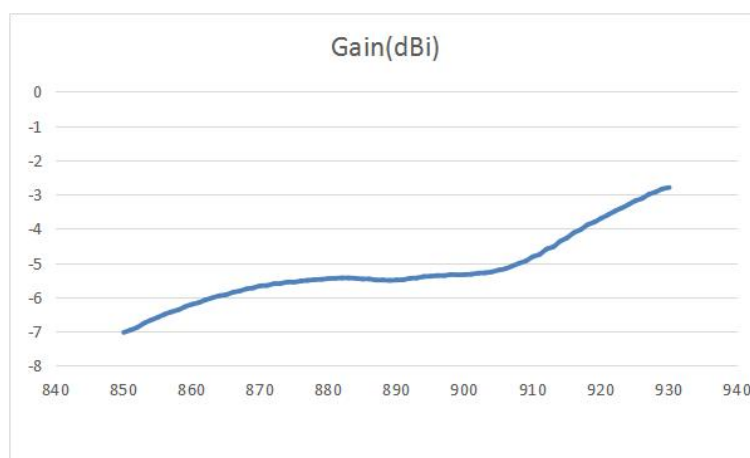

Frequency (MHz)	850	908	915	916	920	930
Gain(dbi)	-7.55	-5.35	-4.92	-4.89	-3.80	-2.75

This specification belongs to Shenzhen Jiexuntong Wireless Technology Co., Ltd. and relevant customer confidential archives, please keep properly, without our company and relevant customer permission, anyone shall not disclose.。

## Field pattern diagram:

850MHZ

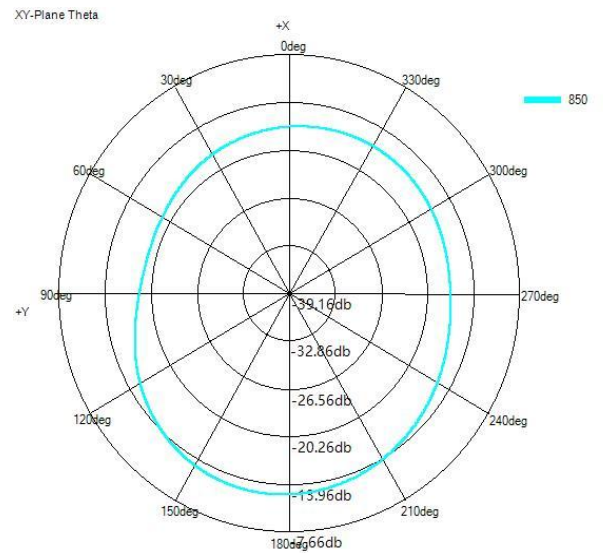
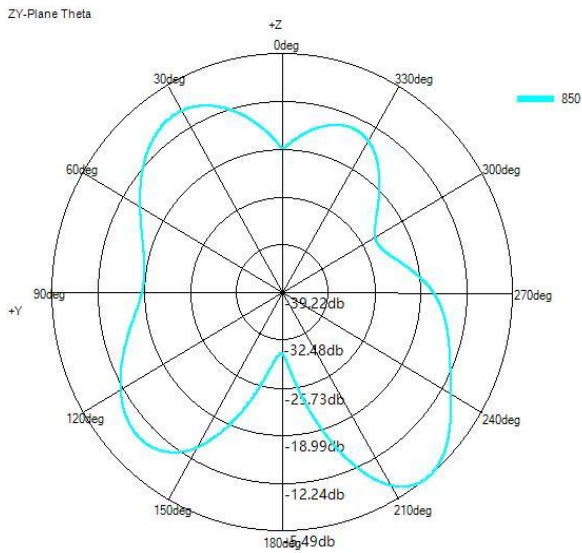
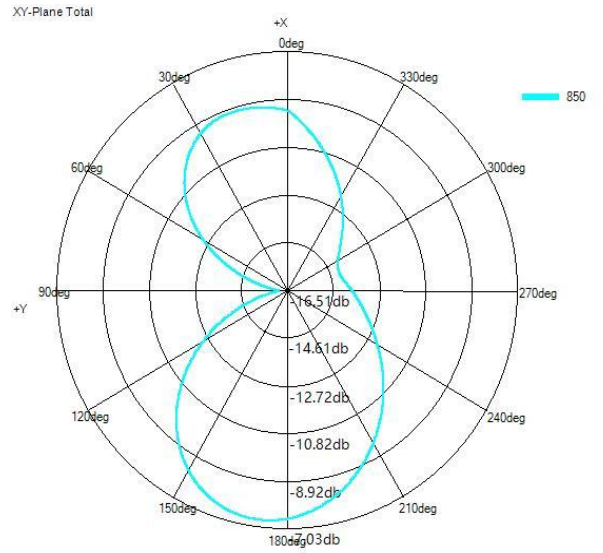
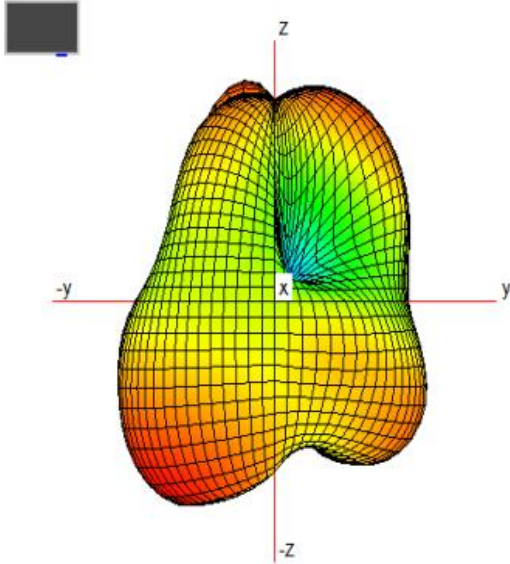

This specification belongs to Shenzhen Jiexuntong Wireless Technology Co., Ltd. and relevant customer confidential archives, please keep properly, without our company and relevant customer permission, anyone shall not disclose.

**908MHZ**

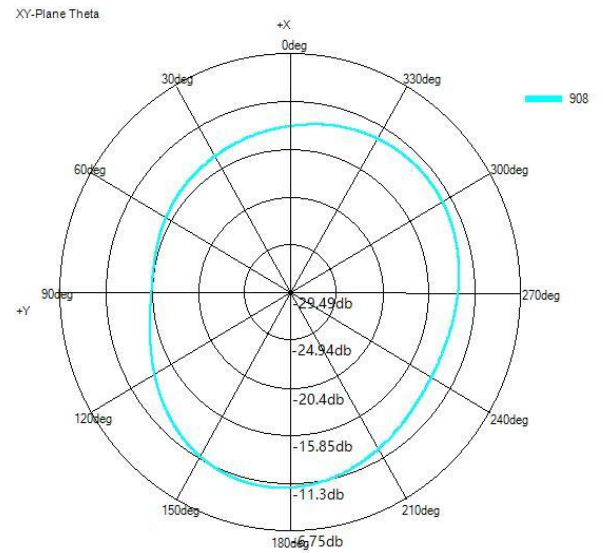
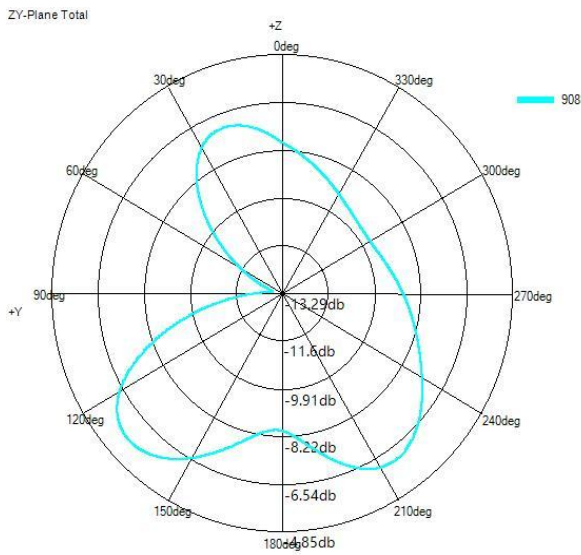
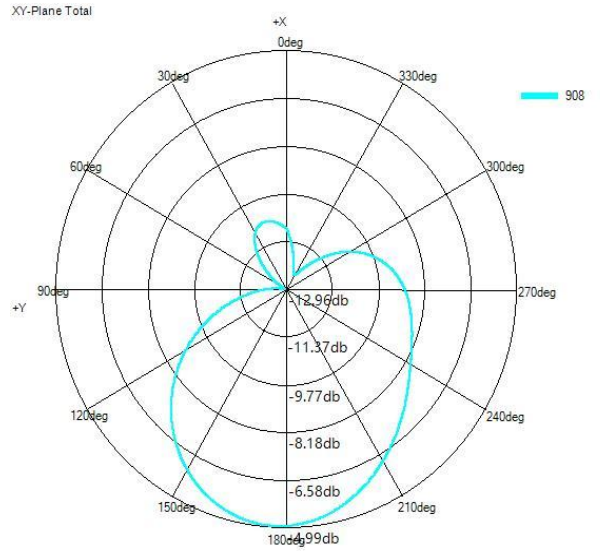
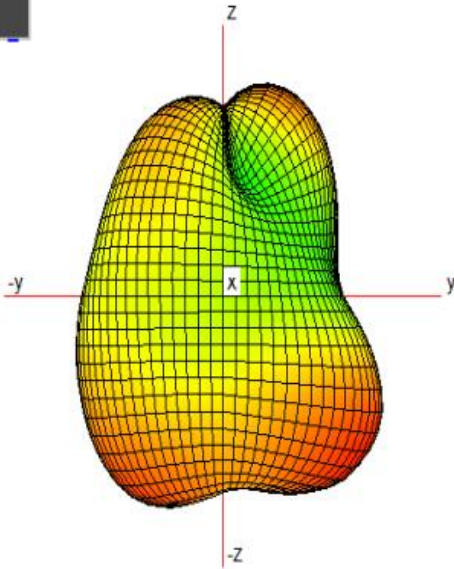

This specification belongs to Shenzhen Jiexuntong Wireless Technology Co., Ltd. and relevant customer confidential archives, please keep properly, without our company and relevant customer permission, anyone shall not disclose.

**915MHZ**

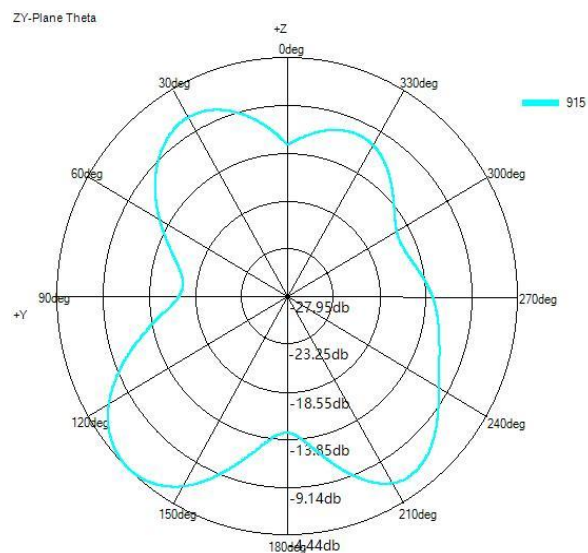
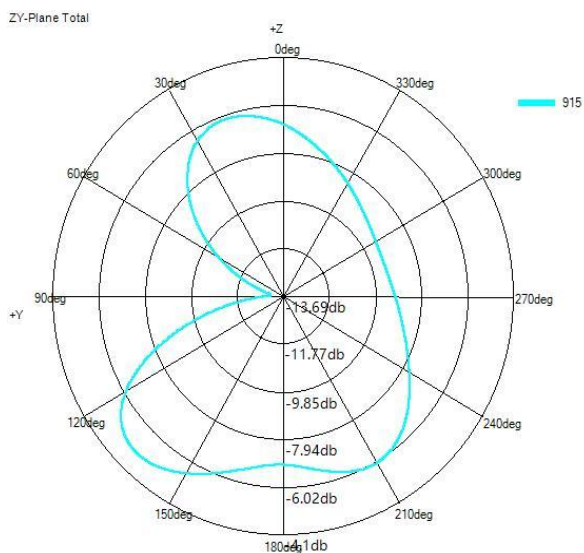
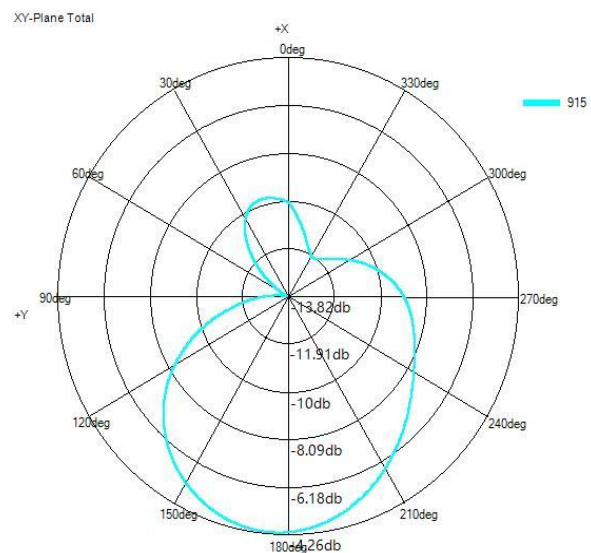
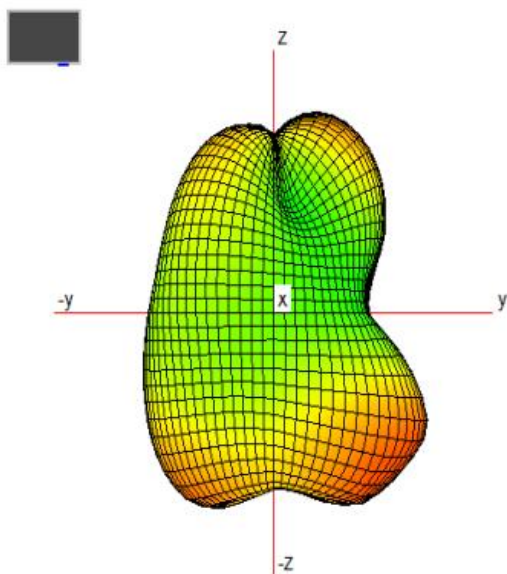

This specification belongs to Shenzhen Jiexuntong Wireless Technology Co., Ltd. and relevant customer confidential archives, please keep properly, without our company and relevant customer permission, anyone shall not disclose.

**916MHZ**

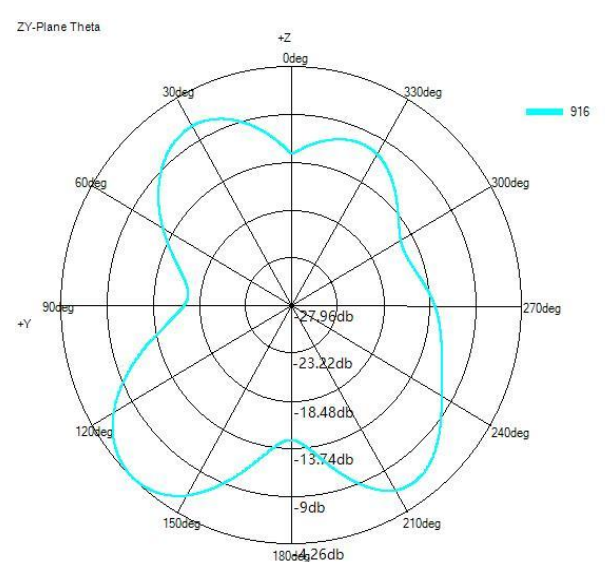
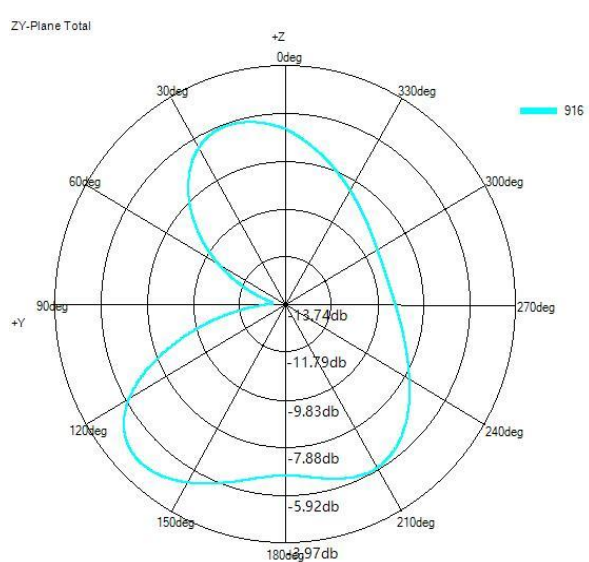
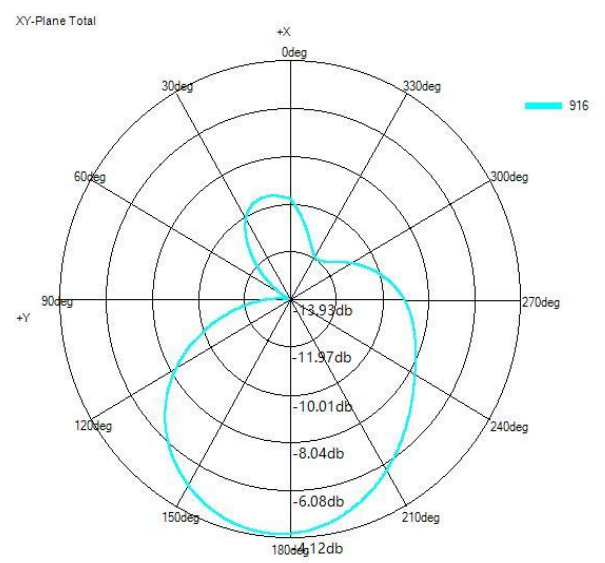
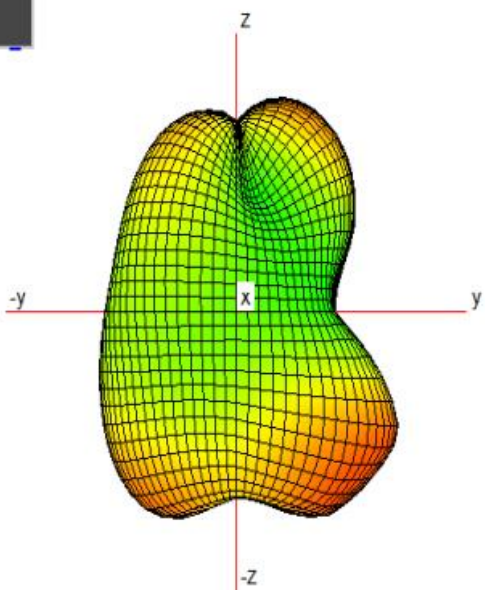

This specification belongs to Shenzhen Jiexuntong Wireless Technology Co., Ltd. and relevant customer confidential archives, please keep properly, without our company and relevant customer permission, anyone shall not disclose.

**920MHZ**

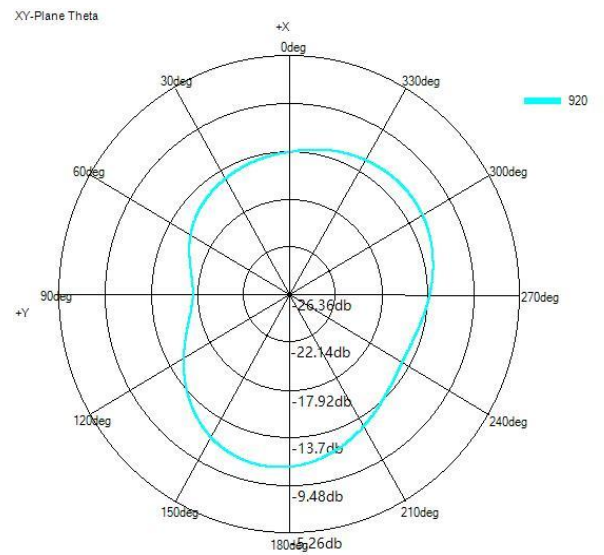
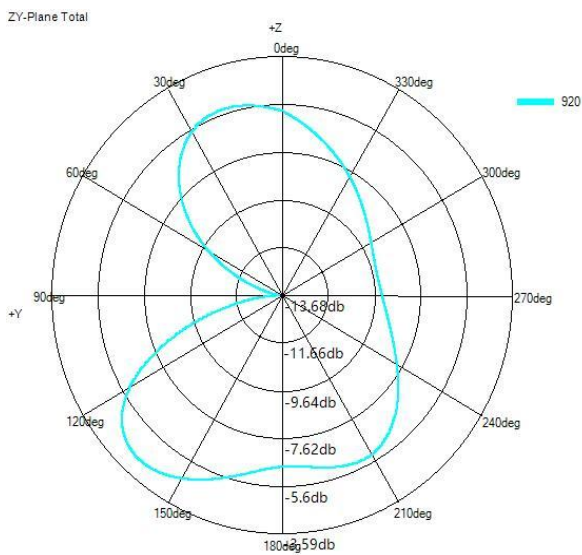
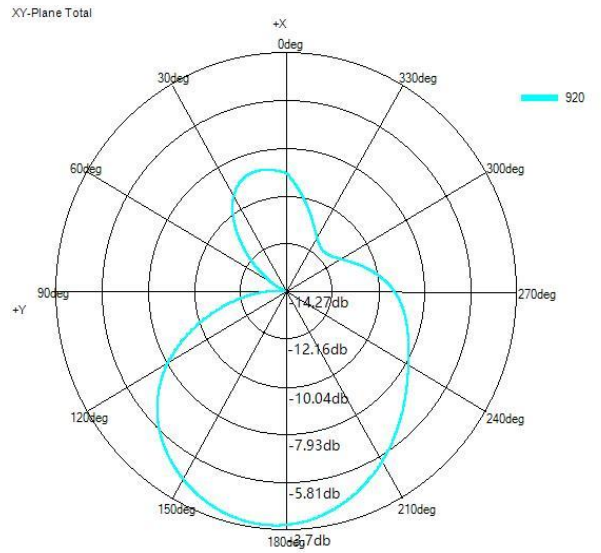
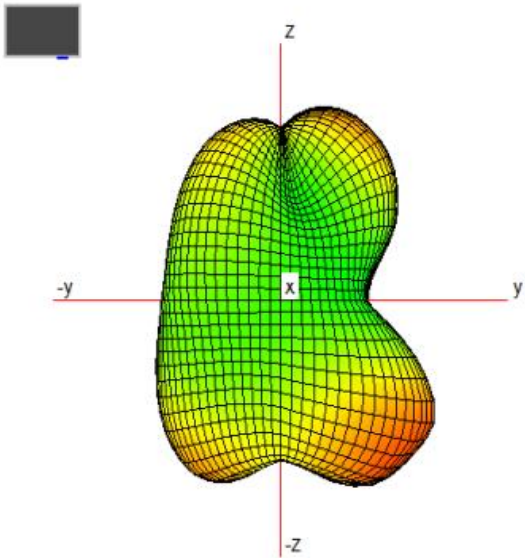

This specification belongs to Shenzhen Jiexuntong Wireless Technology Co., Ltd. and relevant customer confidential archives, please keep properly, without our company and relevant customer permission, anyone shall not disclose.

**930MHZ**

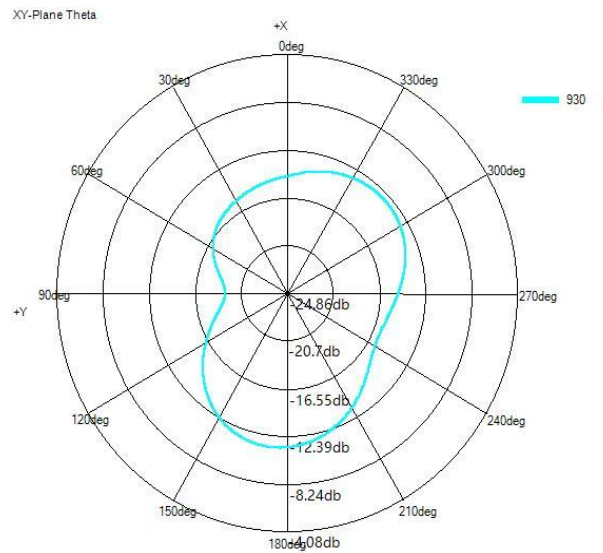
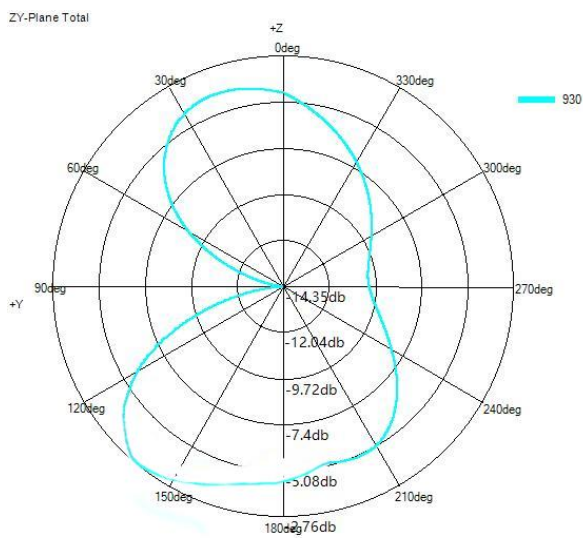
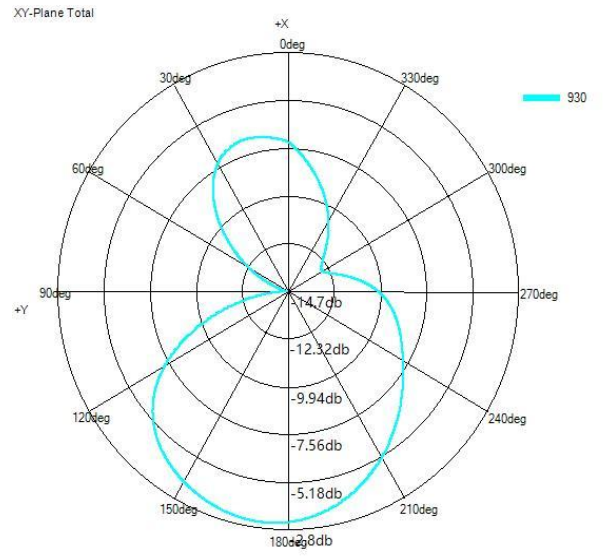
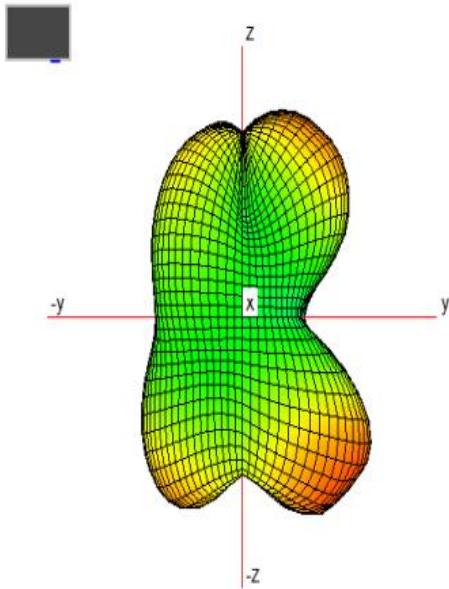

This specification belongs to Shenzhen Jiexuntong Wireless Technology Co., Ltd. and relevant customer confidential archives, please keep properly, without our company and relevant customer permission, anyone shall not disclose.

## 五、Reliability test report

### 5.1.Salt spray test report

Guest house	Baoneng Daktron	Part name	<b>DPXTH</b>	Date of completion	2022.12.27
Test item	Test requirement			Measured result	evaluation
Neutral salt spray test	<p>Experimental process: Neutral salt spray test was carried out on the hardware on the antenna. In the closed environment of <math>35\text{ }^{\circ}\text{C} \pm 2\text{ }^{\circ}\text{C}</math>, humidity <math>&gt; 85\%</math>, PH value within the range of 6.5-7.2, <math>5\% \pm 1\%</math> NaCl solution was used. After continuous 24h brine spray, the surface of the product should be free from corrosion, discoloration, and coating peeling.</p>			<p>After the end of the experiment, the surface of the product has no rust, no discoloration, and the coating has no peeling.</p>	PASS
Experiment: Wang Ming			Approved by: Wang Ming		



Antenna testing instrument

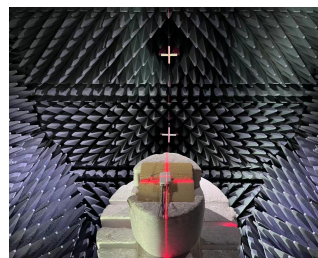

Darkroom test environment