

TEST REPORT

Report No..... : KD2407S2683E03
FCC ID..... : 2AZ2R-PF
Applicant..... : Shenzhen USEER Robotics Co.,Ltd.
Address..... : Building 2, Fashion Brand Industrial Park, E'Bu Town, Shenzhen-Shanwei Special Cooperation Zone, Shenzhen, Guangdong, China.
Manufacturer..... : Shenzhen USEER Robotics Co.,Ltd.
Address..... : Building 2, Fashion Brand Industrial Park, E'Bu Town, Shenzhen-Shanwei Special Cooperation Zone, Shenzhen, Guangdong, China.
Product Name..... : Intelligent Pet Feeder
Model/Type reference..... : PF2, PF2S, PF*, PF**, PF*** (*=0-9 or A-Z, represent different color)
Standard..... : 47 CFR Part 15E
Date of Receipt..... : July 04, 2024
Date of Test Date..... : July 04, 2024 to August 20, 2024
Date of issue..... : August 21, 2024
Test result..... : Pass

Conclusion..... : The submitted sample was found to COMPLY with the standards above.

Prepared by:
(Printed name + Signature) Chad Lin

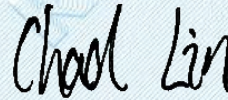

Approved by:
(Printed name + Signature) Sky Dong

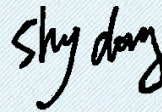

Testing Laboratory Name...: KSIGN(Guangdong) Testing Co., Ltd.

Address..... : West Side of 1/F., Building C, Zone A, Fuyuan New Factory, Jiujiu Industrial Park, Minzhu, Shatou, Shajing, Bao'an District, Shenzhen, Guangdong, China

TABLE OF CONTENTS**Page**

1. TEST SUMMARY	3
1.1. Test Standards	3
1.2. Report Version	3
1.3. Test Description	4
1.4. Test Facility	5
1.5. Measurement Uncertainty	5
2. GENERAL INFORMATION	6
2.1. General Description Of EUT	6
2.2. Accessory Equipment Information	6
2.3. Description of Test Modes	6
2.4. Operation channel list	7
2.5. Measurement Instruments List	9
3. Radio Spectrum Matter Test Results (RF)	11
3.1. Conducted Emission at AC power line	11
3.2. Duty Cycle	14
3.3. Emission bandwidth and occupied bandwidth	15
3.4. Maximum conducted output power	17
3.5. Power spectral density	19
3.6. Channel Move Time, Channel Closing Transmission Time	21
3.7. Non-Occupancy Period Test	23
3.8. DFS Detection Thresholds	25
3.9. Band edge emissions (Radiated)	27
3.10. Undesirable emission limits (below 1GHz)	46
3.11. Undesirable emission limits (above 1GHz)	51
4. EUT TEST PHOTOS	78
5. PHOTOGRAPHS OF EUT CONSTRUCTIONAL	80

1. TEST SUMMARY

1.1. Test Standards

The tests were performed according to following standards:

47 CFR Part 15E: Unlicensed National Information Infrastructure Devices

ANSI C63.10-2013: American National Standard of Procedures for Compliance Testing of Unlicensed Wireless Devices.

KDB 789033 D02 General U-NII Test Procedures New Rules v02r01: Guidelines for compliance testing of unlicensed national information infrastructure (U-NII) devices part 15, subpart E.

1.2. Report Version

Revised No.	Date of issue	Description
01	August 21, 2024	Original

1.3. Test Description

Test Item	Standard	Requirement	Result
Conducted Emission at AC power line	47 CFR Part 15E	47 CFR Part 15.207(a)	Pass
Duty Cycle	47 CFR Part 15E	ANSI C63.10-2013 section 12.2 (b)	Pass
Emission bandwidth and occupied bandwidth	47 CFR Part 15E	U-NII 1, U-NII 2A, U-NII 2C: No limits, only for report use. 47 CFR Part 15.407(e)	Pass
Maximum conducted output power	47 CFR Part 15E	47 CFR Part 15.407(a)(1)(iv) 47 CFR Part 15.407(a)(2) 47 CFR Part 15.407(a)(3)(i)	Pass
Power spectral density	47 CFR Part 15E	47 CFR Part 15.407(a)(1)(iv) 47 CFR Part 15.407(a)(2) 47 CFR Part 15.407(a)(3)(i)	Pass
Channel Move Time, Channel Closing Transmission Time	47 CFR Part 15E	47 CFR Part 15.407(h)(2)(iii)	Pass
Non-Occupancy Period Test	47 CFR Part 15E	47 CFR Part 15.407(h)(2)(iv)	Pass
DFS Detection Thresholds	47 CFR Part 15E	KDB 905462 D02, Clause 5.2 Table 3	Pass
Band edge emissions (Radiated)	47 CFR Part 15E	47 CFR Part 15.407(b)(1) 47 CFR Part 15.407(b)(2) 47 CFR Part 15.407(b)(3) 47 CFR Part 15.407(b)(4) 47 CFR Part 15.407(b)(10)	Pass
Undesirable emission limits (below 1GHz)	47 CFR Part 15E	47 CFR Part 15.407(b)(9)	Pass
Undesirable emission limits (above 1GHz)	47 CFR Part 15E	47 CFR Part 15.407(b)(1) 47 CFR Part 15.407(b)(2) 47 CFR Part 15.407(b)(3) 47 CFR Part 15.407(b)(4) 47 CFR Part 15.407(b)(10)	Pass

Note:

-The EUT is a client device and does not having TPC faction.

-Master device

Product name: Wireless-AC3100 Dual Band Gigabit Router

Model: RT-AC88U

FCC ID: MSQ-RTGW00

1.4. Test Facility

KSIGN(Guangdong) Testing Co., Ltd .

West Side of 1/F., Building C, Zone A, Fuyuan New Factory, Jiujiu Industrial Park, Minzhu, Shatou, Shajing, Bao'an District, Shenzhen, Guangdong, China

The test facility is recognized, certified, or accredited by the following organizations:

CNAS-Lab Code: L 13261

KSIGN(Guangdong) Testing Co., Ltd. has been assessed and proved to be in Compliance with CNAS-CL01 Accreditation Criteria for Testing and Calibration Laboratories (identical to ISO/IEC17025: 2017 General Requirements) for the Competence of Testing and Calibration Laboratories.

A2LA-Lab Cert. No.: 5457.01

KSIGN(Guangdong) Testing Co., Ltd. EMC Laboratory has been accredited by A2LA for technical competence in the field of electrical testing, and proved to be in compliance with ISO/IEC 17025:2017 General Requirements for the Competence of Testing and Calibration Laboratories and any additional program requirements in the identified field of testing.

ISED# : 25693 CAB identifier.: CN0096

KSIGN(Guangdong) Testing Co., Ltd. has been listed by Innovation, Science and Economic Development Canada to perform electromagnetic emission measurement.

FCC-Registration No.: 294912 Designation Number: CN1328

KSIGN(Guangdong) Testing Co., Ltd. EMC Laboratory has been listed on the US Federal Communications Commission list of test facilities recognized to perform electromagnetic emissions measurements.

1.5. Measurement Uncertainty

Test Items	Measurement Uncertainty
Conducted Emission (150k-30MHz)	± 3.34dB
Output Power, Conducted	± 1.4dB
PSD, Conducted	± 1.0dB
RSE (1-18GHz)	± 4.68dB
RSE (30-1000MHz)	± 5.7dB
RSE (18-40GHz)	± 5.18dB

The reported uncertainty of measurement $y \pm U$, where expended uncertainty U is based on a standard uncertainty multiplied by a coverage factor of $k=2$, providing a level of confidence of approximately 95 %. Otherwise required by the applicant or Product Regulations. Decision Rule in this report did not consider the uncertainty.

2. GENERAL INFORMATION

2.1. General Description Of EUT

Test Sample Number:	1-1(Normal Sample), 1-2(Engineering Sample)
Product Name:	Intelligent Pet Feeder
Model / Type reference:	PF2, PF2S, PF*, PF**, PF*** (*=0-9 or A-Z, represent different color)
Model Difference:	The only difference product models is color of appearance. Different model names are available to meet market demands. Other power supply methods, appearance, internal structures, circuits and key components are the same, and do not affect safety and electromagnetic compatibility performance. According to the above information, all tests were performed on PF2.
Power Supply:	DC 19V from adapter
Operation Frequency:	802.11a/n(HT20): U-NII Band 1: 5180MHz to 5240MHz; U-NII Band 2A: 5260MHz to 5320MHz; U-NII Band 2C: 5500MHz to 5700MHz; U-NII Band 3: 5745MHz to 5825MHz;
Number of Channels:	802.11a/n(HT20): U-NII Band 1: 4; U-NII Band 2A: 4; U-NII Band 2C: 11; U-NII Band 3: 5;
Modulation Type:	802.11a: OFDM(BPSK, QPSK, 16QAM, 64QAM); 802.11n: OFDM (BPSK, QPSK, 16QAM, 64QAM);
Antenna Type:	FPC
Antenna Gain:	Band 1:2.64; Band 2A:2.64; Band 2C:2.72; Band 3:2.72
Max TX Power:	Band 1:8.70dbm; Band 2A:10.51dBm; Band 2C:10.03dBm ;Band 3:11.90dBm
Hardware Version:	T31_V1.3
Software Version:	V1.2

Note:Antenna gain provided by the applicant Can affect the validity of results

2.2. Accessory Equipment Information

Title	Manufacturer	Model No.	Technical Parameters	Provided by
Computer	HP	15-cd028AX	/	Laboratory

2.3. Description of Test Modes

No.	Title	Description of Mode
Test Mode1	802.11a mode	Keep the EUT connect to AC power line and works in continuously transmitting mode with 802.11a modulation type at lowest, middle and highest channel. All data rates has been tested and found the data rate @ 6Mbps is the worst case. Only the data of worst case is recorded in the report.
Test Mode2	802.11n mode	Keep the EUT connect to AC power line and works in continuously transmitting mode with 802.11n modulation type at lowest, middle and highest channel. All bandwidth and data rates has been tested and found the data rate @ MCS0 is the worst case. Only the data of worst case is recorded in the report.
Test Mode3	Normal Operating	Keep the EUT works in normal operating mode and connect to companion device

TRF No. RF_R1

Add: West Side of 1/F., Building C, Zone A, Fuyuan New Factory, Jiujiu Industrial Park, Minzhu, Shatou, Shajing, Bao'an District, Shenzhen, Guangdong, China

Tel: +(86) 0755-2985 2678 Fax: +(86) 0755-2985 2397 E-mail: info@gdkesign.cn Web: www.gdkesign.com

2.4. Operation channel list

U-NII Band 1

Bandwidth:	20MHz	Bandwidth:	40MHz	Bandwidth:	80MHz
Channel	Frequency (MHz)	Channel	Frequency (MHz)	Channel	Frequency (MHz)
36	5180	/	/	/	/
40	5200	/	/	/	/
44	5220	/	/	/	/
48	5240	/	/	/	/

U-NII Band 2A

Bandwidth:	20MHz	Bandwidth:	40MHz	Bandwidth:	80MHz
Channel	Frequency (MHz)	Channel	Frequency (MHz)	Channel	Frequency (MHz)
52	5260	/	/	/	/
56	5280	/	/	/	/
60	5300	/	/	/	/
64	5320	/	/	/	/

U-NII Band 2C

Bandwidth:	20MHz	Bandwidth:	40MHz	Bandwidth:	80MHz
Channel	Frequency (MHz)	Channel	Frequency (MHz)	Channel	Frequency (MHz)
100	5500	/	/	/	/
104	5520	/	/	/	/
108	5540	/	/	/	/
112	5560	/	/	/	/
116	5580	/	/	/	/
120	5600	/	/	/	/
124	5620	/	/	/	/
128	5640	/	/	/	/
132	5660	/	/	/	/
136	5680	/	/	/	/
140	5700	/	/	/	/

U-NII Band 3

Bandwidth:	20MHz	Bandwidth:	40MHz	Bandwidth:	80MHz
Channel	Frequency (MHz)	Channel	Frequency (MHz)	Channel	Frequency (MHz)
149	5745	/	/	/	/
153	5765	/	/	/	/
157	5785	/	/	/	/
161	5805	/	/	/	/
165	5825	/	/	/	/

2.5. Measurement Instruments List

Conducted Emission at AC power line				
Test Equipment	Manufacturer	Model No.	Serial No.	Cal. Until
LISN	R&S	ENV432	1326.6105.02	2025-01-19
EMI Test Receiver	R&S	ESR	102524	2025-01-19
Manual RF Switch	JS TOYO	/	MSW-01/002	2025-01-19
ISN CAT6	Schwarzbeck	CAT5 8158	227	2025-01-19
Color Signal Generator	Philips	PM5418	672926	2025-01-19
Power Absorbing Clamp	R&S	MDS-21	100925	2025-01-21
TV Tuner	SUNLIGHT	ST5075	/	2024-12-12
LISN	EVERFINE	LS-5	G657431CD14311 12	2025-01-19
Current Sensor Probe	Beijin ZHINAN	ZN23101	23013	2024-12-12
PV Artificial power network	Beijing KeHuan	KH8301	830120007	2025-07-23

Power spectral density Channel Move Time, Channel Closing Transmission Time Non-Occupancy Period Test DFS Detection Thresholds Duty Cycle Emission bandwidth and occupied bandwidth Maximum conducted output power				
Test Equipment	Manufacturer	Model No.	Serial No.	Cal. Until
Wideband Radio Communication Tester	R&S	CMU200	115297	2025-01-19
Audio Analyzer	R&S	UPL16	100001	2025-01-19
Shielding box	Gxiong	GX-5915A	2201113	2025-01-19
High Pass Filter	COM-MW Technology Co., Ltd	ZHPF-M1.2-9G-1 87	09203403	2025-01-19
Band Stop Filter	COM-MW Technology Co., Ltd	ZBSF6-C820-920 -188	09203401	2025-01-19
Splitter	COM-MW Technology Co., Ltd	ZPD-M1-8-2103	09203407	2025-01-19
Coaxial Cable	BEBES	A40-2.92M2.92F- 4.5M	1907021	2025-01-19
Hygrothermograph	Anymetre	JB913	/	2025-01-19
Climate Chamber	Angul	AGNH80L	1903042120	2025-01-19
Spectrum Analyzer	HP	8593E	3831U02087	2025-01-19
Dual Output DC Power Supply	Agilent	E3646A	MY40009992	2025-01-19
RF Control Unit	Tonscend	JS0806-2	/	2025-01-19
Analog Signal Generator	HP	83752A	3344A00337	2025-01-19
Vector Signal Generator	Agilent	N5182A	MY50142520	2025-01-19
Wideband Radio Communication Tester	R&S	CMW500	157282	2025-01-19
Spectrum Analyzer	R&S	FSV40-N	101798	2025-01-19

TRF No. RF_R1

Add: West Side of 1/F., Building C, Zone A, Fuyuan New Factory, Jiujiu Industrial Park, Minzhu, Shatou, Shajing, Bao'an District, Shenzhen, Guangdong, China

Tel: +(86) 0755-2985 2678 Fax: +(86) 0755-2985 2397 E-mail: info@gdkesign.cn Web: www.gdkesign.com

Band edge emissions (Radiated) Undesirable emission limits (below 1GHz) Undesirable emission limits (above 1GHz)				
Test Equipment	Manufacturer	Model No.	Serial No.	Cal. Until
Color Signal Generator	Philips	PM5418	672926	2025-01-19
Log Periodic Antenna	Schwarzbeck	VULB 9163	1230	2025-01-29
Pre-Amplifier	Schwarzbeck	BBV 9745	9745#129	2025-01-19
Broadcast Television Signal Generator	R&S	SFE100	141038	2025-01-19
Analog Signal Generator	Agilent	8648A	3847M00445	2025-01-19
EMI Test Receiver	R&S	ESR	102525	2025-01-19
Loop Antenna	Beijin ZHINAN	ZN30900C	18050	2025-01-29
Horn Antenna	Schwarzbeck	BBHA 9120 D	2023	2025-01-21
Pre-Amplifier	EMCI	EMC051835SE	980662	2025-01-19
Spectrum Analyzer	Keysight	N9020A	MY46471971	2025-01-19

TRF No. RF_R1

Add: West Side of 1/F., Building C, Zone A, Fuyuan New Factory, Jiujiu Industrial Park, Minzhu, Shatou, Shajing, Bao'an District, Shenzhen, Guangdong, China

Tel: +(86) 0755-2985 2678 Fax: +(86) 0755-2985 2397 E-mail: info@gdksign.cn Web: www.gdksign.com

3. Radio Spectrum Matter Test Results (RF)

3.1. Conducted Emission at AC power line

Test Requirement:	47 CFR Part 15.207(a)		
Test Limit:	Frequency of emission (MHz)	Conducted limit (dB μ V)	
		Quasi-peak	Average
	0.15-0.5	66 to 56*	56 to 46*
	0.5-5	56	46
	5-30	60	50
	*Decreases with the logarithm of the frequency.		
Test Method:	ANSI C63.10-2013 section 6.2		

3.1.1. E.U.T. Operation:

Operating Environment:	
Temperature:	23.3 °C
Humidity:	44.4 %
Atmospheric Pressure:	101 kPa
Final test mode:	Test Mode1

3.1.2. Test Setup Diagram:

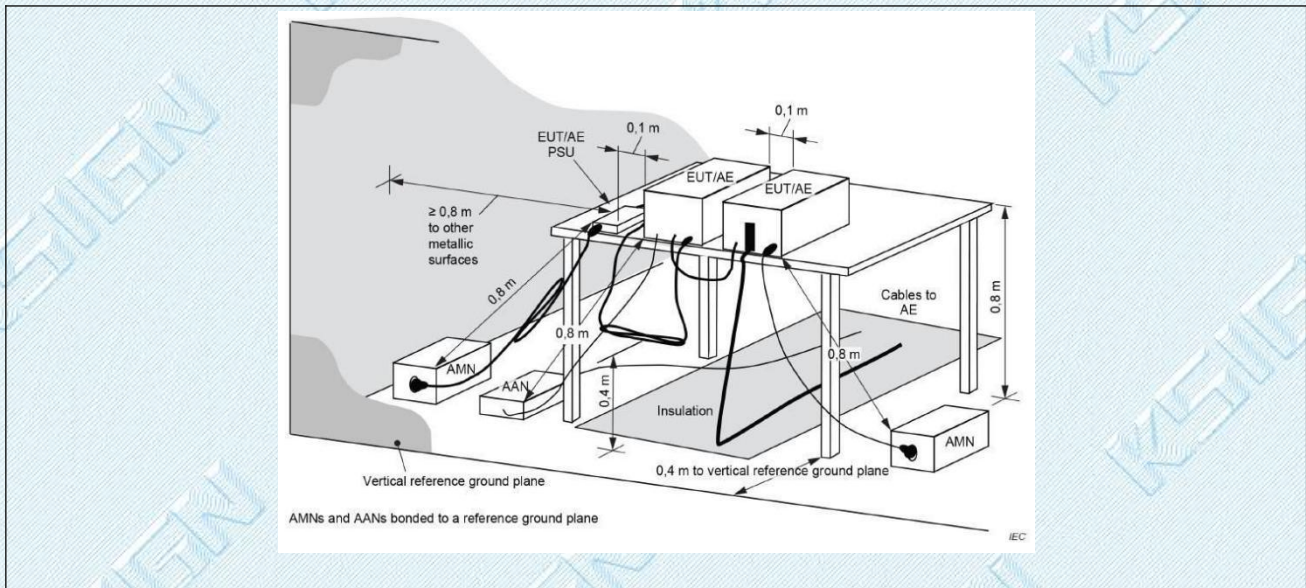

3.1.3. Test Data:

Test Mode1 / Line: Line / Band: 5150-5250 MHz / BW: 20 / CH: L

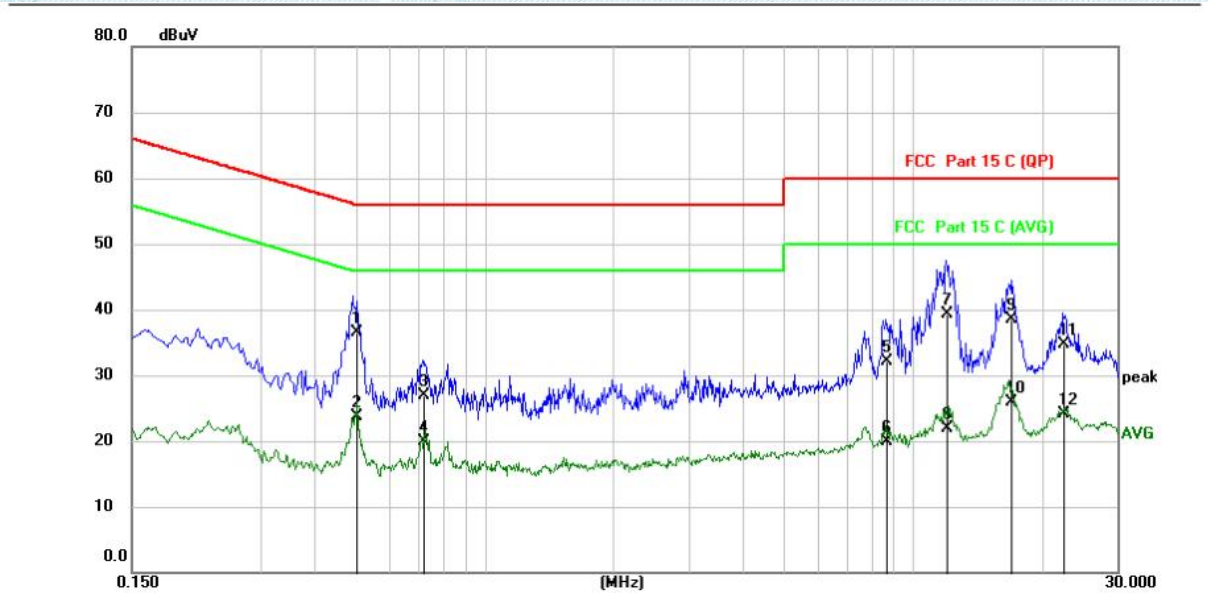

No. Mk.	Freq. MHz	Reading Level dBuV	Correct Factor dB	Measurement dBuV	Limit dBuV	Over dB	Detector	Comment
1 *	0.4994	15.23	21.31	36.54	56.01	-19.47	QP	
2	0.4994	2.37	21.31	23.68	46.01	-22.33	AVG	
3	0.7221	5.49	21.37	26.86	56.00	-29.14	QP	
4	0.7221	-1.51	21.37	19.86	46.00	-26.14	AVG	
5	8.6398	9.58	22.57	32.15	60.00	-27.85	QP	
6	8.6398	-2.57	22.57	20.00	50.00	-30.00	AVG	
7	11.9614	15.65	23.66	39.31	60.00	-20.69	QP	
8	11.9614	-1.70	23.66	21.96	50.00	-28.04	AVG	
9	16.9404	13.11	25.37	38.48	60.00	-21.52	QP	
10	16.9404	0.47	25.37	25.84	50.00	-24.16	AVG	
11	22.5241	8.55	26.06	34.61	60.00	-25.39	QP	
12	22.5241	-2.00	26.06	24.06	50.00	-25.94	AVG	

TRF No. RF_R1

Add: West Side of 1/F., Building C, Zone A, Fuyuan New Factory, Jiujiu Industrial Park, Minzhu, Shatou, Shajing, Bao'an District, Shenzhen, Guangdong, China

Tel: +(86) 0755-2985 2678 Fax: +(86) 0755-2985 2397 E-mail: info@gdkesign.cn Web: www.gdkesign.com

Test Mode1 / Line: Neutral / Band: 5150-5250 MHz / BW: 20 / CH: L

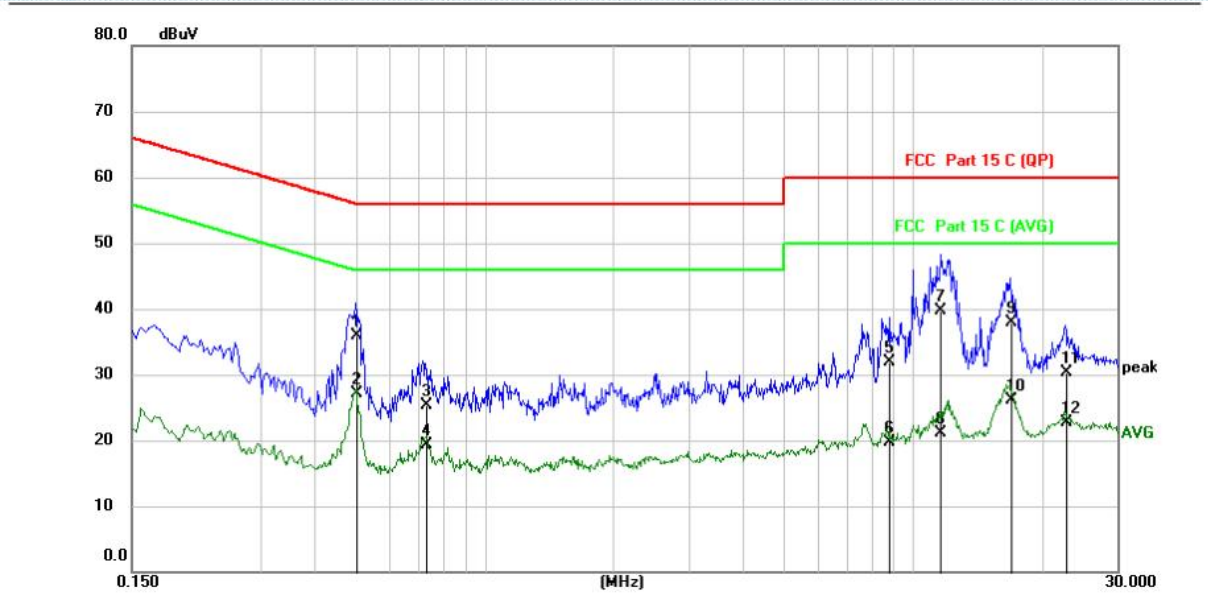

No.	Mk.	Freq. MHz	Reading Level dBuV	Correct Factor dB	Measure- ment dBuV	Limit dBuV	Over dB	Detector	Comment
1		0.5044	14.68	21.30	35.98	56.00	-20.02	QP	
2	*	0.5044	5.71	21.30	27.01	46.00	-18.99	AVG	
3		0.7299	3.85	21.39	25.24	56.00	-30.76	QP	
4		0.7299	-2.00	21.39	19.39	46.00	-26.61	AVG	
5		8.7860	9.23	22.61	31.84	60.00	-28.16	QP	
6		8.7860	-2.96	22.61	19.65	50.00	-30.35	AVG	
7		11.6023	16.35	23.38	39.73	60.00	-20.27	QP	
8		11.6023	-2.21	23.38	21.17	50.00	-28.83	AVG	
9		16.8639	12.72	25.10	37.82	60.00	-22.18	QP	
10		16.8639	0.97	25.10	26.07	50.00	-23.93	AVG	
11		22.7384	4.36	25.92	30.28	60.00	-29.72	QP	
12		22.7384	-3.25	25.92	22.67	50.00	-27.33	AVG	

Note:

1.Measurement = Reading level + Correct Factor

2.Correct Factor=Antenna Factor + Cable Loss -Preamplifier Factor

3.2. Duty Cycle

Test Requirement:	All measurements are to be performed with the EUT transmitting at 100% duty cycle at its maximum power control level; however, if 100% duty cycle cannot be achieved, measurements of duty cycle, x, and maximum-power transmission duration, T, are required for each tested mode of operation.
Test Limit:	No limits, only for report use.
Test Method:	ANSI C63.10-2013 section 12.2 (b)
Procedure:	<ul style="list-style-type: none"> i) Set the center frequency of the instrument to the center frequency of the transmission. ii) Set RBW \geq EBW if possible; otherwise, set RBW to the largest available value. iii) Set VBW \geq RBW. iv) Set detector = peak. v) The zero-span measurement method shall not be used unless both RBW and VBW are $> 50/T$, where T is defined in item a1) of 12.2, and the number of sweep points across duration T exceeds 100.

3.2.1. E.U.T. Operation:

Operating Environment:	
Temperature:	23.3 °C
Humidity:	44.4 %
Atmospheric Pressure:	101 kPa
Final test mode:	Test Mode1, Test Mode2

3.2.2. Test Setup Diagram:

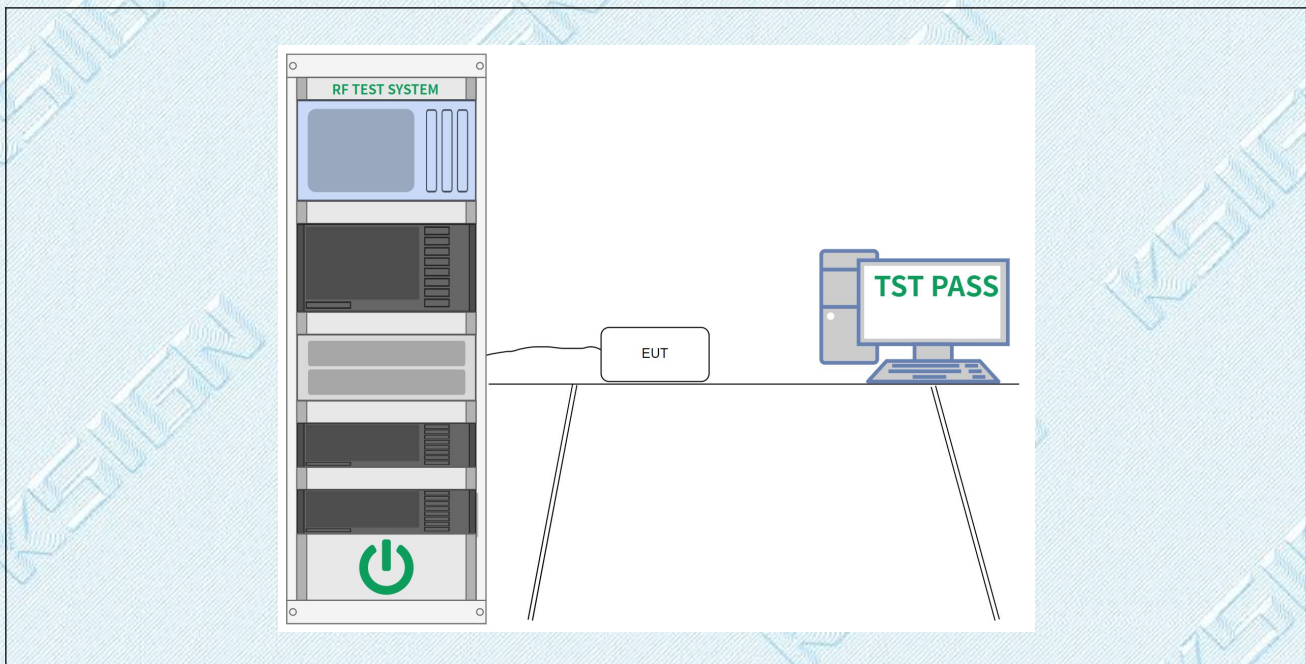

3.2.3. Test Data:

Please Refer to Appendix for Details.

3.3. Emission bandwidth and occupied bandwidth

Test Requirement:	U-NII 1, U-NII 2A, U-NII 2C: No limits, only for report use. U-NII 3, U-NII 4: 47 CFR Part 15.407(e)
Test Limit:	U-NII 1, U-NII 2A, U-NII 2C: No limits, only for report use. U-NII 3, U-NII 4: Within the 5.725-5.850 GHz and 5.850-5.895 GHz bands, the minimum 6 dB bandwidth of U-NII devices shall be at least 500 kHz.
Test Method:	ANSI C63.10-2013, section 6.9 & 12.4 KDB 789033 D02, Clause C.2
Procedure:	<p>Emission bandwidth:</p> <ol style="list-style-type: none"> Set RBW = approximately 1% of the emission bandwidth. Set the VBW > RBW. Detector = peak. Trace mode = max hold. Measure the maximum width of the emission that is 26 dB down from the peak of the emission. <p>Compare this with the RBW setting of the instrument. Readjust RBW and repeat measurement as needed until the RBW/EBW ratio is approximately 1%.</p> <p>Occupied bandwidth:</p> <ol style="list-style-type: none"> The instrument center frequency is set to the nominal EUT channel center frequency. The frequency span for the spectrum analyzer shall be between 1.5 times and 5.0 times the OBW. The nominal IF filter bandwidth (3 dB RBW) shall be in the range of 1% to 5% of the OBW, and VBW shall be approximately three times the RBW, unless otherwise specified by the applicable requirement. Set the reference level of the instrument as required, keeping the signal from exceeding the maximum input mixer level for linear operation. In general, the peak of the spectral envelope shall be more than $[10 \log (OBW/RBW)]$ below the reference level. Specific guidance is given in 4.1.5.2. Step a) through step c) might require iteration to adjust within the specified range. Video averaging is not permitted. Where practical, a sample detection and single sweep mode shall be used. Otherwise, peak detection and max hold mode (until the trace stabilizes) shall be used. Use the 99% power bandwidth function of the instrument (if available) and report the measured bandwidth. If the instrument does not have a 99% power bandwidth function, then the trace data points are recovered and directly summed in linear power terms. The recovered amplitude data points, beginning at the lowest frequency, are placed in a running sum until 0.5% of the total is reached; that frequency is recorded as the lower frequency. The process is repeated until

	<p>99.5% of the total is reached; that frequency is recorded as the upper frequency. The 99% power bandwidth is the difference between these two frequencies.</p> <p>h) The occupied bandwidth shall be reported by providing plot(s) of the measuring instrument display; the plot axes and the scale units per division shall be clearly labeled. Tabular data may be reported in addition to the plot(s).</p> <p>6 dB emission bandwidth:</p> <p>a) Set RBW = 100 kHz.</p> <p>b) Set the video bandwidth (VBW) $\geq 3 \times$ RBW.</p> <p>c) Detector = Peak.</p> <p>d) Trace mode = max hold.</p> <p>e) Sweep = auto couple.</p> <p>f) Allow the trace to stabilize.</p> <p>g) Measure the maximum width of the emission that is constrained by the frequencies associated with the two outermost amplitude points (upper and lower frequencies) that are attenuated by 6 dB relative to the maximum level measured in the fundamental emission.</p>
--	--

3.3.1. E.U.T. Operation:

Operating Environment:	
Temperature:	23.3 °C
Humidity:	44.4 %
Atmospheric Pressure:	101 kPa
Final test mode:	Test Mode1, Test Mode2

3.3.2. Test Setup Diagram:

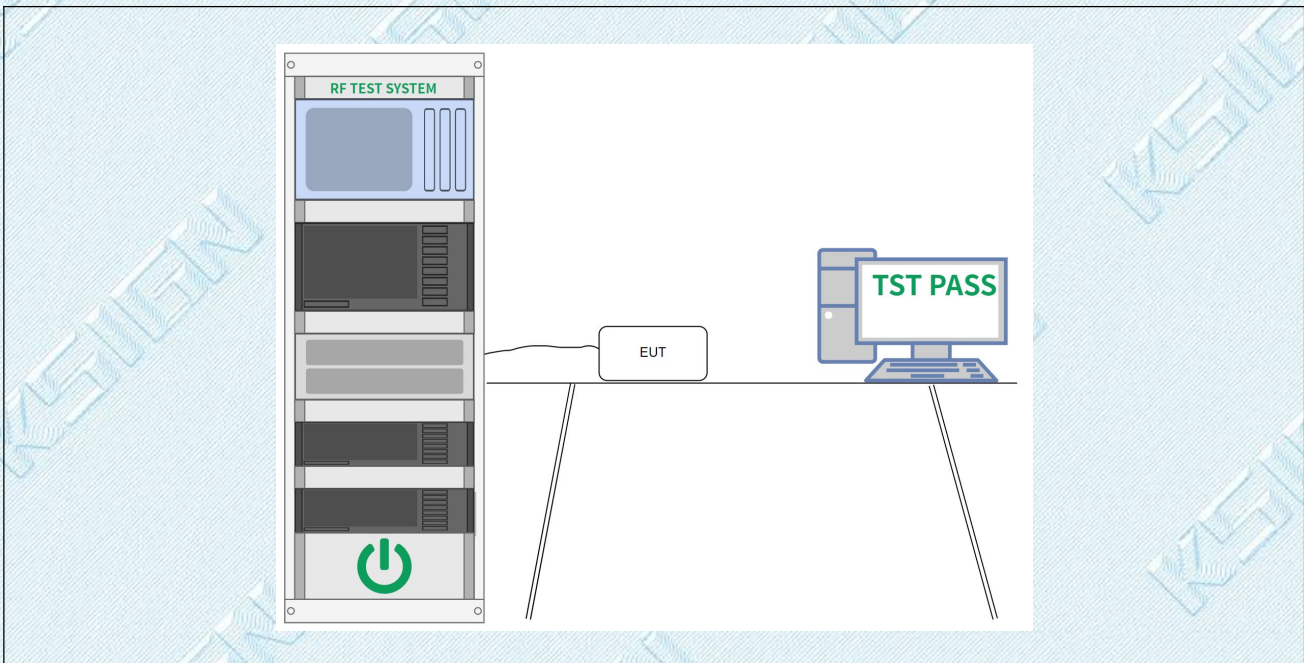

3.3.3. Test Data:

Please Refer to Appendix for Details.

3.4. Maximum conducted output power

Test Requirement:	<p>47 CFR Part 15.407(a)(1)(iv) 47 CFR Part 15.407(a)(2) 47 CFR Part 15.407(a)(3)(i)</p>
Test Limit:	<p>47 CFR Part 15.407(a)(1)(iv) For client devices in the 5.15-5.25 GHz band, the maximum conducted output power over the frequency band of operation shall not exceed 250 mW provided the maximum antenna gain does not exceed 6 dBi. If transmitting antennas of directional gain greater than 6 dBi are used, the maximum conducted output power shall be reduced by the amount in dB that the directional gain of the antenna exceeds 6 dBi.</p> <p>47 CFR Part 15.407(a)(2) For the 5.25-5.35 GHz and 5.47-5.725 GHz bands, the maximum conducted output power over the frequency bands of operation shall not exceed the lesser of 250 mW or 11 dBm + 10 log B, where B is the 26 dB emission bandwidth in megahertz. If transmitting antennas of directional gain greater than 6 dBi are used, the maximum conducted output power shall be reduced by the amount in dB that the directional gain of the antenna exceeds 6 dBi.</p> <p>47 CFR Part 15.407(a)(3)(i) For the band 5.725-5.850 GHz, the maximum conducted output power over the frequency band of operation shall not exceed 1 W. If transmitting antennas of directional gain greater than 6 dBi are used, the maximum conducted output power shall be reduced by the amount in dB that the directional gain of the antenna exceeds 6 dBi. However, fixed point-to-point U-NII devices operating in this band may employ transmitting antennas with directional gain greater than 6 dBi without any corresponding reduction in transmitter conducted power. Fixed, point-to-point operations exclude the use of point-to-multipoint systems, omnidirectional applications, and multiple collocated transmitters transmitting the same information. The operator of the U-NII device, or if the equipment is professionally installed, the installer, is responsible for ensuring that systems employing high gain directional antennas are used exclusively for fixed, point-to-point operations.</p>
Test Method:	ANSI C63.10-2013, section 12.3
Procedure:	Refer to ANSI C63.10-2013 section 12.3

3.4.1. E.U.T. Operation:

Operating Environment:	
Temperature:	23.3 °C
Humidity:	44.4 %
Atmospheric Pressure:	101 kPa
Final test mode:	Test Mode1, Test Mode2

3.4.2. Test Setup Diagram:

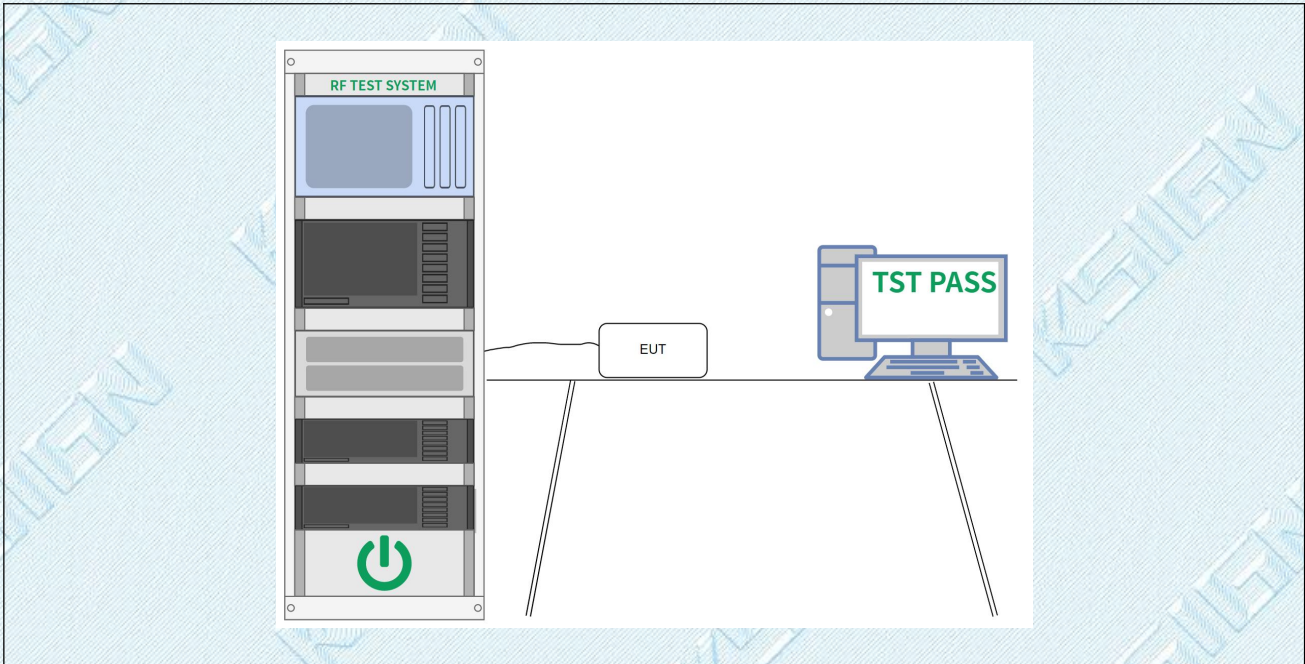

3.4.3. Test Data:

Please Refer to Appendix for Details.

3.5. Power spectral density

Test Requirement:	<p>47 CFR Part 15.407(a)(1)(iv) 47 CFR Part 15.407(a)(2) 47 CFR Part 15.407(a)(3)(i)</p>
Test Limit:	<p>47 CFR Part 15.407(a)(1)(iv) For client devices in the 5.15-5.25 GHz band, the maximum power spectral density shall not exceed 11 dBm in any 1 megahertz band. If transmitting antennas of directional gain greater than 6 dBi are used, the maximum power spectral density shall be reduced by the amount in dB that the directional gain of the antenna exceeds 6 dBi.</p> <p>47 CFR Part 15.407(a)(2) For the 5.25-5.35 GHz and 5.47-5.725 GHz bands, the maximum power spectral density shall not exceed 11 dBm in any 1 megahertz band. If transmitting antennas of directional gain greater than 6 dBi are used, the maximum power spectral density shall be reduced by the amount in dB that the directional gain of the antenna exceeds 6 dBi.</p> <p>47 CFR Part 15.407(a)(3)(i) For the band 5.725-5.850 GHz, the maximum power spectral density shall not exceed 30 dBm in any 500-kHz band. If transmitting antennas of directional gain greater than 6 dBi are used, the maximum power spectral density shall be reduced by the amount in dB that the directional gain of the antenna exceeds 6 dBi. However, fixed point-to-point U-NII devices operating in this band may employ transmitting antennas with directional gain greater than 6 dBi without any corresponding reduction in transmitter conducted power. Fixed, point-to-point operations exclude the use of point-to-multipoint systems, omnidirectional applications, and multiple collocated transmitters transmitting the same information. The operator of the U-NII device, or if the equipment is professionally installed, the installer, is responsible for ensuring that systems employing high gain directional antennas are used exclusively for fixed, point-to-point operations.</p>
Test Method:	ANSI C63.10-2013, section 12.5
Procedure:	Refer to ANSI C63.10-2013, section 12.5

3.5.1. E.U.T. Operation:

Operating Environment:	
Temperature:	23.3 °C
Humidity:	44.4 %
Atmospheric Pressure:	101 kPa
Final test mode:	Test Mode1, Test Mode2

3.5.2. Test Setup Diagram:

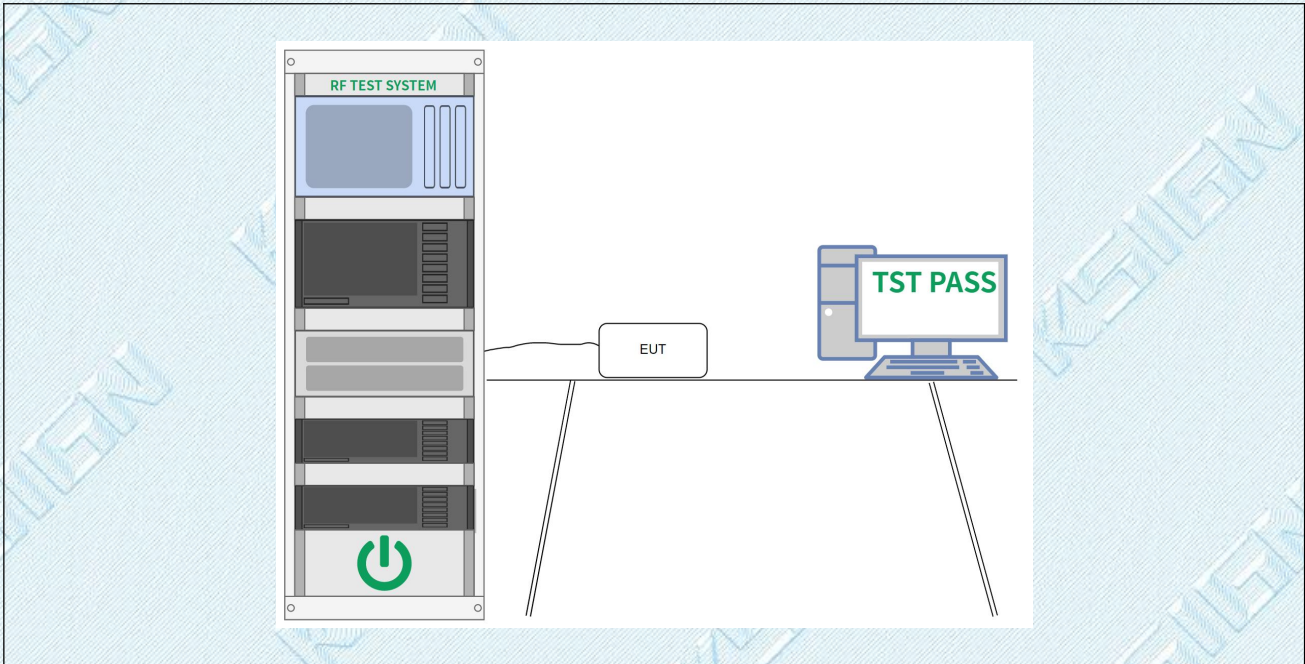

3.5.3. Test Data:

Please Refer to Appendix for Details.

3.6. Channel Move Time, Channel Closing Transmission Time

Test Requirement:	47 CFR Part 15.407(h)(2)(iii)
Test Limit:	Channel Move Time: within 10 seconds Channel Closing Transmission Time: 200 milliseconds + an aggregate of 60 milliseconds over remaining 10 second period. (The Channel Closing Transmission Time is comprised of 200 milliseconds starting at the beginning of the Channel Move Time plus any additional intermittent control signals required to facilitate a Channel move (an aggregate of 60 milliseconds) during the remainder of the 10 second period. The aggregate duration of control signals will not count quiet periods in between transmissions.)
Test Method:	KDB 905462 D02, Clause 7.8.3
Procedure:	<p>The steps below define the procedure to determine the above-mentioned parameters when a radar <i>Burst</i> with a level equal to the <i>DFS Detection Threshold</i> + 1dB is generated on the <i>Operating Channel</i> of the U-NII device (<i>In-Service Monitoring</i>).</p> <ol style="list-style-type: none"> One frequency will be chosen from the <i>Operating Channels</i> of the UUT within the 5250-5350 MHz or 5470-5725 MHz bands. For 802.11 devices, the test frequency must contain control signals. This can be verified by disabling channel loading and monitoring the spectrum analyzer. If no control signals are detected, another frequency must be selected within the emission bandwidth where control signals are detected. In case the UUT is a U-NII device operating as a <i>Client Device</i> (with or without DFS), a U-NII device operating as a <i>Master Device</i> will be used to allow the UUT (Client device) to <i>Associate</i> with the <i>Master Device</i>. In case the UUT is a <i>Master Device</i>, a U-NII device operating as a <i>Client Device</i> will be used and it is assumed that the Client will <i>Associate</i> with the UUT (Master). In both cases for conducted tests, the <i>Radar Waveform</i> generator will be connected to the <i>Master Device</i>. For radiated tests, the emissions of the <i>Radar Waveform</i> generator will be directed towards the <i>Master Device</i>. If the <i>Master Device</i> has antenna gain, the main beam of the antenna will be directed toward the radar emitter. Vertical polarization is used for testing. Stream the channel loading test file from the <i>Master Device</i> to the <i>Client Device</i> on the test <i>Channel</i> for the entire period of the test. At time T0 the <i>Radar Waveform</i> generator sends a <i>Burst</i> of pulses for one of the Radar Type 0 in Table 5 at levels defined in Table 3, on the <i>Operating Channel</i>. An additional 1 dB is added to the radar test signal to ensure it is at or above the <i>DFS Detection Threshold</i>, accounting for equipment variations/errors. Observe the transmissions of the UUT at the end of the radar <i>Burst</i> on the <i>Operating Channel</i> for duration greater than 10 seconds. Measure and record the transmissions from the UUT during the observation time (<i>Channel Move Time</i>). Measure and record the <i>Channel Move Time</i> and <i>Channel Closing Transmission Time</i> if radar detection occurs. Figure 17 illustrates <i>Channel Closing Transmission Time</i>. When operating as a <i>Master Device</i>, monitor the UUT for more than 30 minutes following instant T2 to verify that the UUT does not resume any transmissions on this <i>Channel</i>. Perform this test once and record the measurement result. In case the UUT is a U-NII device operating as a <i>Client Device</i> with <i>In-Service Monitoring</i>, perform steps 1 to 6.

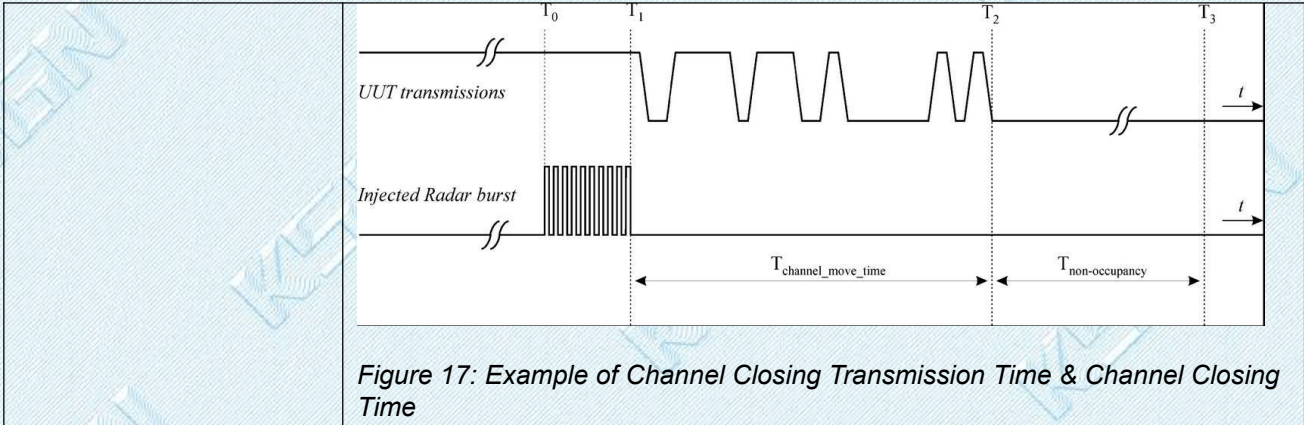

3.6.1. E.U.T. Operation:

Operating Environment:	
Temperature:	23.3 °C
Humidity:	44.4 %
Atmospheric Pressure:	101 kPa
Final test mode:	Test Mode3

3.6.2. Test Setup Diagram:

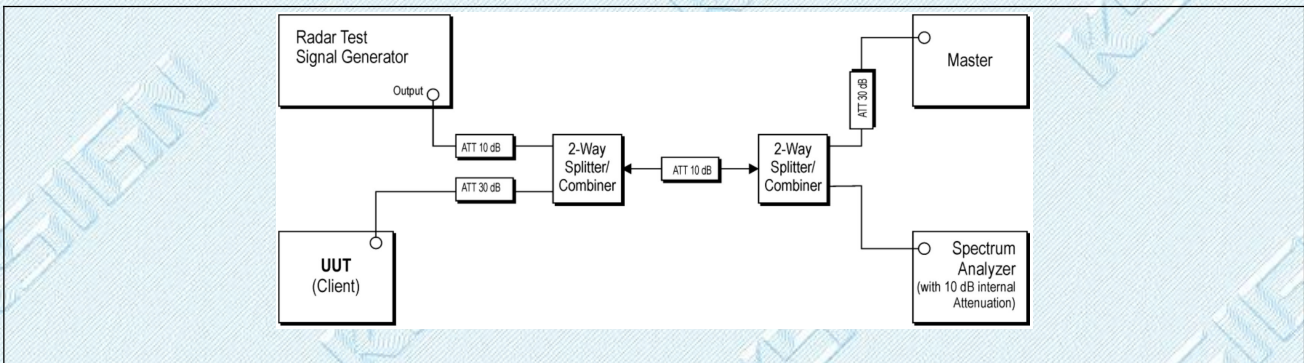

3.6.3. Test Data:

Please Refer to Appendix for Details.

3.7. Non-Occupancy Period Test

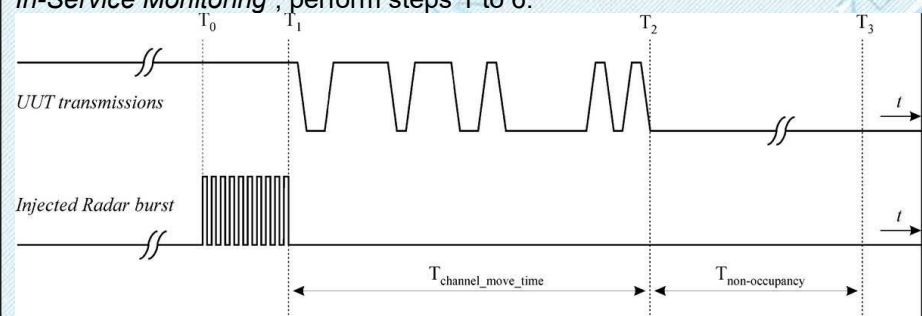
Test Requirement:	47 CFR Part 15.407(h)(2)(iv)
Test Limit:	A channel that has been flagged as containing a radar system, either by a channel availability check or in-service monitoring, is subject to a non-occupancy period of at least 30 minutes. The non-occupancy period starts at the time when the radar system is detected.
Test Method:	KDB 905462 D02, Clause 7.8.3
Procedure:	<p>The steps below define the procedure to determine the above-mentioned parameters when a radar <i>Burst</i> with a level equal to the <i>DFS Detection Threshold</i> + 1dB is generated on the <i>Operating Channel</i> of the U-NII device (<i>In-Service Monitoring</i>).</p> <ol style="list-style-type: none"> One frequency will be chosen from the <i>Operating Channels</i> of the UUT within the 5250-5350 MHz or 5470-5725 MHz bands. For 802.11 devices, the test frequency must contain control signals. This can be verified by disabling channel loading and monitoring the spectrum analyzer. If no control signals are detected, another frequency must be selected within the emission bandwidth where control signals are detected. In case the UUT is a U-NII device operating as a <i>Client Device</i> (with or without DFS), a U-NII device operating as a <i>Master Device</i> will be used to allow the UUT (Client device) to <i>Associate</i> with the <i>Master Device</i>. In case the UUT is a <i>Master Device</i>, a U-NII device operating as a <i>Client Device</i> will be used and it is assumed that the Client will <i>Associate</i> with the UUT (Master). In both cases for conducted tests, the <i>Radar Waveform</i> generator will be connected to the <i>Master Device</i>. For radiated tests, the emissions of the <i>Radar Waveform</i> generator will be directed towards the <i>Master Device</i>. If the <i>Master Device</i> has antenna gain, the main beam of the antenna will be directed toward the radar emitter. Vertical polarization is used for testing. Stream the channel loading test file from the <i>Master Device</i> to the <i>Client Device</i> on the test <i>Channel</i> for the entire period of the test. At time T_0 the <i>Radar Waveform</i> generator sends a <i>Burst</i> of pulses for one of the Radar Type 0 in Table 5 at levels defined in Table 3, on the <i>Operating Channel</i>. An additional 1 dB is added to the radar test signal to ensure it is at or above the <i>DFS Detection Threshold</i>, accounting for equipment variations/errors. Observe the transmissions of the UUT at the end of the radar <i>Burst</i> on the <i>Operating Channel</i> for duration greater than 10 seconds. Measure and record the transmissions from the UUT during the observation time (<i>Channel Move Time</i>). Measure and record the <i>Channel Move Time</i> and <i>Channel Closing Transmission Time</i> if radar detection occurs. Figure 17 illustrates <i>Channel Closing Transmission Time</i>. When operating as a <i>Master Device</i>, monitor the UUT for more than 30 minutes following instant T_2 to verify that the UUT does not resume any transmissions on this <i>Channel</i>. Perform this test once and record the measurement result. In case the UUT is a U-NII device operating as a <i>Client Device</i> with <i>In-Service Monitoring</i>, perform steps 1 to 6. 

TRF No. RF_R1

Add: West Side of 1/F., Building C, Zone A, Fuyuan New Factory, Jiujiu Industrial Park, Minzhu, Shatou, Shajing, Bao'an District, Shenzhen, Guangdong, China

Tel: +(86) 0755-2985 2678 Fax: +(86) 0755-2985 2397 E-mail: info@gdksign.cn Web: www.gdksign.com

Figure 17: Example of Channel Closing Transmission Time & Channel Closing Time

3.7.1. E.U.T. Operation:

Operating Environment:	
Temperature:	23.3 °C
Humidity:	44.4 %
Atmospheric Pressure:	101 kPa
Final test mode:	Test Mode3

3.7.2. Test Setup Diagram:

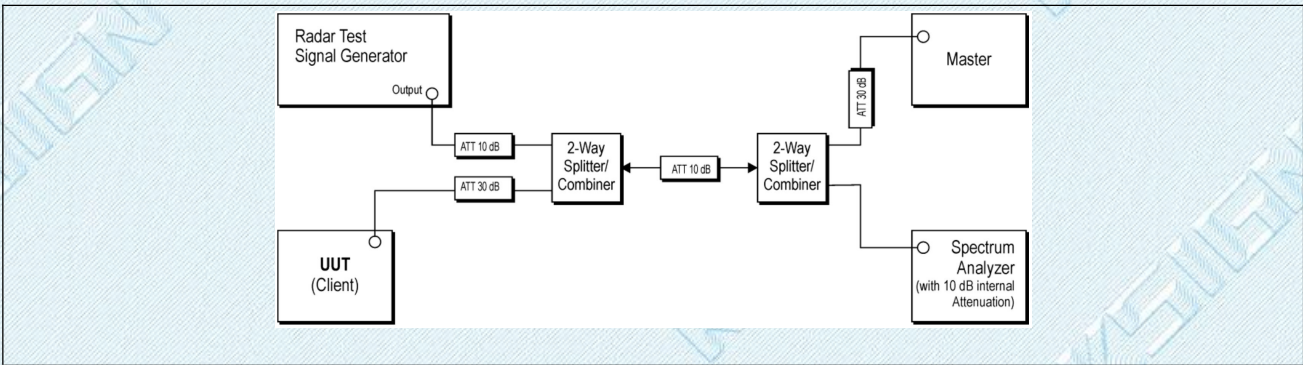

3.7.3. Test Data:

Please Refer to Appendix for Details.

3.8. DFS Detection Thresholds

Test Requirement:	KDB 905462 D02, Clause 5.2 Table 3										
Test Limit:	<p>Table 3: DFS Detection Thresholds for Master Devices and Client Devices with Radar Detection</p> <table border="1" style="margin-left: 20px;"> <thead> <tr> <th colspan="2">Table 3: DFS Detection Thresholds for Master Devices and Client Devices with Radar Detection</th> </tr> <tr> <th>Maximum Transmit Power</th> <th>Value (See Notes 1, 2, and 3)</th> </tr> </thead> <tbody> <tr> <td>EIRP ≥ 200 milliwatt</td> <td>-64 dBm</td> </tr> <tr> <td>EIRP < 200 milliwatt and power spectral density < 10 dBm/MHz</td> <td>-62 dBm</td> </tr> <tr> <td>EIRP < 200 milliwatt that do not meet the power spectral density requirement</td> <td>-64 dBm</td> </tr> </tbody> </table> <p>Note 1: This is the level at the input of the receiver assuming a 0 dBi receive antenna. Note 2: Throughout these test procedures an additional 1 dB has been added to the amplitude of the test transmission waveforms to account for variations in measurement equipment. This will ensure that the test signal is at or above the detection threshold level to trigger a DFS response. Note 3: EIRP is based on the highest antenna gain. For MIMO devices refer to KDB Publication 662911 D01.</p>	Table 3: DFS Detection Thresholds for Master Devices and Client Devices with Radar Detection		Maximum Transmit Power	Value (See Notes 1, 2, and 3)	EIRP ≥ 200 milliwatt	-64 dBm	EIRP < 200 milliwatt and power spectral density < 10 dBm/MHz	-62 dBm	EIRP < 200 milliwatt that do not meet the power spectral density requirement	-64 dBm
Table 3: DFS Detection Thresholds for Master Devices and Client Devices with Radar Detection											
Maximum Transmit Power	Value (See Notes 1, 2, and 3)										
EIRP ≥ 200 milliwatt	-64 dBm										
EIRP < 200 milliwatt and power spectral density < 10 dBm/MHz	-62 dBm										
EIRP < 200 milliwatt that do not meet the power spectral density requirement	-64 dBm										
Test Method:	KDB 905462 D02, Clause 7.4.1.1										
Procedure:	<p>1) A 50 ohm load is connected in place of the spectrum analyzer, and the spectrum analyzer is connected to place of the master</p> <p>2) The interference Radar Detection Threshold Level is TH+ 0dBi +1dB that had been taken into account the output power range and antenna gain.</p> <p>3) The following equipment setup was used to calibrate the conducted radar waveform. A vector signal generator was utilized to establish the test signal level for radar type 0. During this process, there were no transmissions by either the master or client device. The spectrum analyzer was switched to the zero spans (time domain) at the frequency of the radar waveform generator. Peak detection was used. The spectrum analyzer resolution bandwidth (RBW) and video bandwidth (VBW) were set to 3 MHz. The spectrum analyzer had offset -1.0dB to compensate RF cable loss 1.0dB.</p> <p>4) The vector signal generator amplitude was set so that the power level measured at the spectrum analyzer was TH + 0dBi +1dB = -63dBm. Capture the spectrum analyzer plots on short pulse radar waveform.</p> <p>Note: TH=-64 dBm or -62 dBm</p>										

3.8.1. E.U.T. Operation:

Operating Environment:	
Temperature:	23.3 °C
Humidity:	44.4 %
Atmospheric Pressure:	101 kPa
Final test mode:	Test Mode3

3.8.2. Test Setup Diagram:

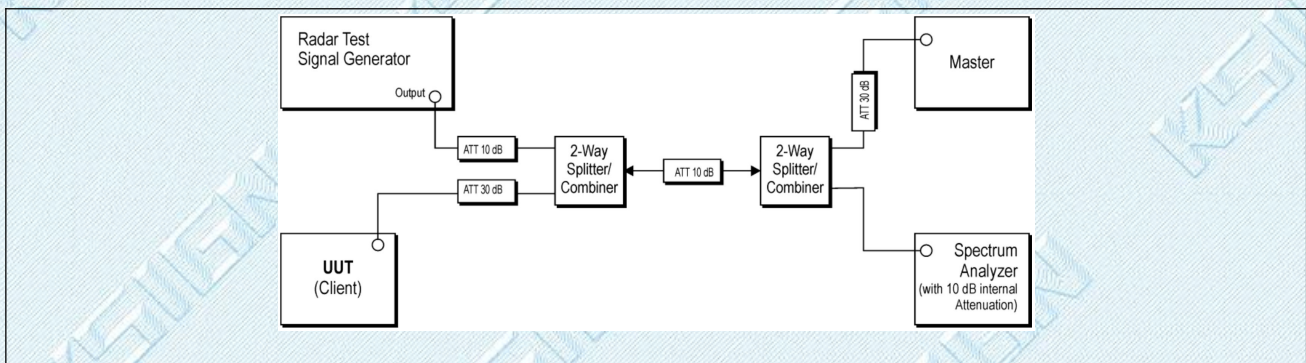

3.8.3. Test Data:

Please Refer to Appendix for Details.

3.9. Band edge emissions (Radiated)

<p>Test Requirement:</p>	<p>47 CFR Part 15.407(b)(1) 47 CFR Part 15.407(b)(2) 47 CFR Part 15.407(b)(3) 47 CFR Part 15.407(b)(4) 47 CFR Part 15.407(b)(10)</p>																																																																								
<p>Test Limit:</p>	<p>For transmitters operating in the 5.15-5.25 GHz band: All emissions outside of the 5.15-5.35 GHz band shall not exceed an e.i.r.p. of -27 dBm/MHz.</p> <p>For transmitters operating in the 5.25-5.35 GHz band: All emissions outside of the 5.15-5.35 GHz band shall not exceed an e.i.r.p. of -27 dBm/MHz.</p> <p>For transmitters operating in the 5.47-5.725 GHz band: All emissions outside of the 5.47-5.725 GHz band shall not exceed an e.i.r.p. of -27 dBm/MHz.</p> <p>For transmitters operating solely in the 5.725-5.850 GHz band: All emissions shall be limited to a level of -27 dBm/MHz at 75 MHz or more above or below the band edge increasing linearly to 10 dBm/MHz at 25 MHz above or below the band edge, and from 25 MHz above or below the band edge increasing linearly to a level of 15.6 dBm/MHz at 5 MHz above or below the band edge, and from 5 MHz above or below the band edge increasing linearly to a level of 27 dBm/MHz at the band edge.</p> <table border="1" data-bbox="491 958 1433 1653"> <thead> <tr> <th>MHz</th> <th>MHz</th> <th>MHz</th> <th>GHz</th> </tr> </thead> <tbody> <tr> <td>0.090-0.110</td> <td>16.42-16.423</td> <td>399.9-410</td> <td>4.5-5.15</td> </tr> <tr> <td>¹ 0.495-0.505</td> <td>16.69475-16.69525</td> <td>608-614</td> <td>5.35-5.46</td> </tr> <tr> <td>2.1735-2.1905</td> <td>16.80425-16.80475</td> <td>960-1240</td> <td>7.25-7.75</td> </tr> <tr> <td>4.125-4.128</td> <td>25.5-25.67</td> <td>1300-1427</td> <td>8.025-8.5</td> </tr> <tr> <td>4.17725-4.17775</td> <td>37.5-38.25</td> <td>1435-1626.5</td> <td>9.0-9.2</td> </tr> <tr> <td>4.20725-4.20775</td> <td>73-74.6</td> <td>1645.5-1646.5</td> <td>9.3-9.5</td> </tr> <tr> <td>6.215-6.218</td> <td>74.8-75.2</td> <td>1660-1710</td> <td>10.6-12.7</td> </tr> <tr> <td>6.26775-6.26825</td> <td>108-121.94</td> <td>1718.8-1722.2</td> <td>13.25-13.4</td> </tr> <tr> <td>6.31175-6.31225</td> <td>123-138</td> <td>2200-2300</td> <td>14.47-14.5</td> </tr> <tr> <td>8.291-8.294</td> <td>149.9-150.05</td> <td>2310-2390</td> <td>15.35-16.2</td> </tr> <tr> <td>8.362-8.366</td> <td>156.52475-156.52525</td> <td>2483.5-2500</td> <td>17.7-21.4</td> </tr> <tr> <td>8.37625-8.38675</td> <td>156.7-156.9</td> <td>2690-2900</td> <td>22.01-23.12</td> </tr> <tr> <td>8.41425-8.41475</td> <td>162.0125-167.17</td> <td>3260-3267</td> <td>23.6-24.0</td> </tr> <tr> <td>12.29-12.293</td> <td>167.72-173.2</td> <td>3332-3339</td> <td>31.2-31.8</td> </tr> <tr> <td>12.51975-12.52025</td> <td>240-285</td> <td>3345.8-3358</td> <td>36.43-36.5</td> </tr> <tr> <td>12.57675-12.57725</td> <td>322-335.4</td> <td>3600-4400</td> <td>(²)</td> </tr> <tr> <td>13.36-13.41</td> <td></td> <td></td> <td></td> </tr> </tbody> </table> <p>¹ Until February 1, 1999, this restricted band shall be 0.490-0.510 MHz.</p> <p>² Above 38.6</p> <p>The field strength of emissions appearing within these frequency bands shall not exceed the limits shown in § 15.209. At frequencies equal to or less than 1000 MHz, compliance with the limits in § 15.209 shall be demonstrated using measurement instrumentation employing a CISPR quasi-peak detector. Above 1000 MHz, compliance with the emission limits in § 15.209 shall be demonstrated based on the average value of the measured emissions. The provisions in § 15.35 apply to these measurements.</p>	MHz	MHz	MHz	GHz	0.090-0.110	16.42-16.423	399.9-410	4.5-5.15	¹ 0.495-0.505	16.69475-16.69525	608-614	5.35-5.46	2.1735-2.1905	16.80425-16.80475	960-1240	7.25-7.75	4.125-4.128	25.5-25.67	1300-1427	8.025-8.5	4.17725-4.17775	37.5-38.25	1435-1626.5	9.0-9.2	4.20725-4.20775	73-74.6	1645.5-1646.5	9.3-9.5	6.215-6.218	74.8-75.2	1660-1710	10.6-12.7	6.26775-6.26825	108-121.94	1718.8-1722.2	13.25-13.4	6.31175-6.31225	123-138	2200-2300	14.47-14.5	8.291-8.294	149.9-150.05	2310-2390	15.35-16.2	8.362-8.366	156.52475-156.52525	2483.5-2500	17.7-21.4	8.37625-8.38675	156.7-156.9	2690-2900	22.01-23.12	8.41425-8.41475	162.0125-167.17	3260-3267	23.6-24.0	12.29-12.293	167.72-173.2	3332-3339	31.2-31.8	12.51975-12.52025	240-285	3345.8-3358	36.43-36.5	12.57675-12.57725	322-335.4	3600-4400	(²)	13.36-13.41			
MHz	MHz	MHz	GHz																																																																						
0.090-0.110	16.42-16.423	399.9-410	4.5-5.15																																																																						
¹ 0.495-0.505	16.69475-16.69525	608-614	5.35-5.46																																																																						
2.1735-2.1905	16.80425-16.80475	960-1240	7.25-7.75																																																																						
4.125-4.128	25.5-25.67	1300-1427	8.025-8.5																																																																						
4.17725-4.17775	37.5-38.25	1435-1626.5	9.0-9.2																																																																						
4.20725-4.20775	73-74.6	1645.5-1646.5	9.3-9.5																																																																						
6.215-6.218	74.8-75.2	1660-1710	10.6-12.7																																																																						
6.26775-6.26825	108-121.94	1718.8-1722.2	13.25-13.4																																																																						
6.31175-6.31225	123-138	2200-2300	14.47-14.5																																																																						
8.291-8.294	149.9-150.05	2310-2390	15.35-16.2																																																																						
8.362-8.366	156.52475-156.52525	2483.5-2500	17.7-21.4																																																																						
8.37625-8.38675	156.7-156.9	2690-2900	22.01-23.12																																																																						
8.41425-8.41475	162.0125-167.17	3260-3267	23.6-24.0																																																																						
12.29-12.293	167.72-173.2	3332-3339	31.2-31.8																																																																						
12.51975-12.52025	240-285	3345.8-3358	36.43-36.5																																																																						
12.57675-12.57725	322-335.4	3600-4400	(²)																																																																						
13.36-13.41																																																																									

	<p>Except as provided elsewhere in this subpart, the emissions from an intentional radiator shall not exceed the field strength levels specified in the following table:</p> <table border="1" data-bbox="491 320 1433 651"> <thead> <tr> <th>Frequency (MHz)</th> <th>Field strength (microvolts/meter)</th> <th>Measurement distance (meters)</th> </tr> </thead> <tbody> <tr> <td>0.009-0.490</td> <td>2400/F(kHz)</td> <td>300</td> </tr> <tr> <td>0.490-1.705</td> <td>24000/F(kHz)</td> <td>30</td> </tr> <tr> <td>1.705-30.0</td> <td>30</td> <td>30</td> </tr> <tr> <td>30-88</td> <td>100 **</td> <td>3</td> </tr> <tr> <td>88-216</td> <td>150 **</td> <td>3</td> </tr> <tr> <td>216-960</td> <td>200 **</td> <td>3</td> </tr> <tr> <td>Above 960</td> <td>500</td> <td>3</td> </tr> </tbody> </table> <p>** Except as provided in paragraph (g), fundamental emissions from intentional radiators operating under this section shall not be located in the frequency bands 54-72 MHz, 76-88 MHz, 174-216 MHz or 470-806 MHz. However, operation within these frequency bands is permitted under other sections of this part, e.g., §§ 15.231 and 15.241.</p> <p>In the emission table above, the tighter limit applies at the band edges.</p> <p>The emission limits shown in the above table are based on measurements employing a CISPR quasi-peak detector except for the frequency bands 9–90 kHz, 110–490 kHz and above 1000 MHz. Radiated emission limits in these three bands are based on measurements employing an average detector.</p>	Frequency (MHz)	Field strength (microvolts/meter)	Measurement distance (meters)	0.009-0.490	2400/F(kHz)	300	0.490-1.705	24000/F(kHz)	30	1.705-30.0	30	30	30-88	100 **	3	88-216	150 **	3	216-960	200 **	3	Above 960	500	3
Frequency (MHz)	Field strength (microvolts/meter)	Measurement distance (meters)																							
0.009-0.490	2400/F(kHz)	300																							
0.490-1.705	24000/F(kHz)	30																							
1.705-30.0	30	30																							
30-88	100 **	3																							
88-216	150 **	3																							
216-960	200 **	3																							
Above 960	500	3																							
<p>Test Method:</p>	<p>ANSI C63.10-2013, section 12.7.4, 12.7.6, 12.7.7</p>																								
<p>Procedure:</p>	<p>Above 1GHz:</p> <ol style="list-style-type: none"> For above 1GHz, the EUT was placed on the top of a rotating table 1.5 meters above the ground at a 3 meter fully-anechoic chamber. The table was rotated 360 degrees to determine the position of the highest radiation. The EUT was set 3 meters away from the interference-receiving antenna, which was mounted on the top of a variable-height antenna tower. The antenna height is varied from one meter to four meters above the ground to determine the maximum value of the field strength. Both horizontal and vertical polarizations of the antenna are set to make the measurement. For each suspected emission, the EUT was arranged to its worst case and then the antenna was tuned to heights from 1 meter to 4 meters (for the test frequency of below 30MHz, the antenna was tuned to heights 1 meter) and the rotatable table was turned from 0 degrees to 360 degrees to find the maximum reading. The test-receiver system was set to Peak Detect Function and Specified Bandwidth with Maximum Hold Mode. If the emission level of the EUT in peak mode was 10dB lower than the limit specified, then testing could be stopped and the peak values of the EUT would be reported. Otherwise the emissions that did not have 10dB margin would be re-tested one by one using peak or average method as specified and then reported in a data sheet. Test the EUT in the lowest channel, the middle channel, the Highest channel. The radiation measurements are performed in X, Y, Z axis positioning for Transmitting mode, and found the X axis positioning which it is the worst case. Repeat above procedures until all frequencies measured was complete. <p>Remark:</p> <ol style="list-style-type: none"> Level= Read Level+ Cable Loss+ Antenna Factor- Preamp Factor Scan from 18GHz to 40GHz, the disturbance above 18GHz was very low. The points marked on above plots are the highest emissions could be found when testing, so only above points had been displayed. The amplitude of spurious emissions from the radiator which are attenuated more than 20dB below the limit need not be reported. 																								

3. As shown in this section, for frequencies above 1GHz, the field strength limits are based on average limits. However, the peak field strength of any emission shall not exceed the maximum permitted average limits specified above by more than 20 dB under any condition of modulation. For the emissions whose peak level is lower than the average limit, only the peak measurement is shown in the report.

4. The disturbance above 18GHz were very low and the harmonics were the highest point could be found when testing, so only the above harmonics had been displayed.

3.9.1. E.U.T. Operation:

Operating Environment:	
Temperature:	23.3 °C
Humidity:	44.4 %
Atmospheric Pressure:	101 kPa
Final test mode:	Test Mode1, Test Mode2

3.9.2. Test Setup Diagram:

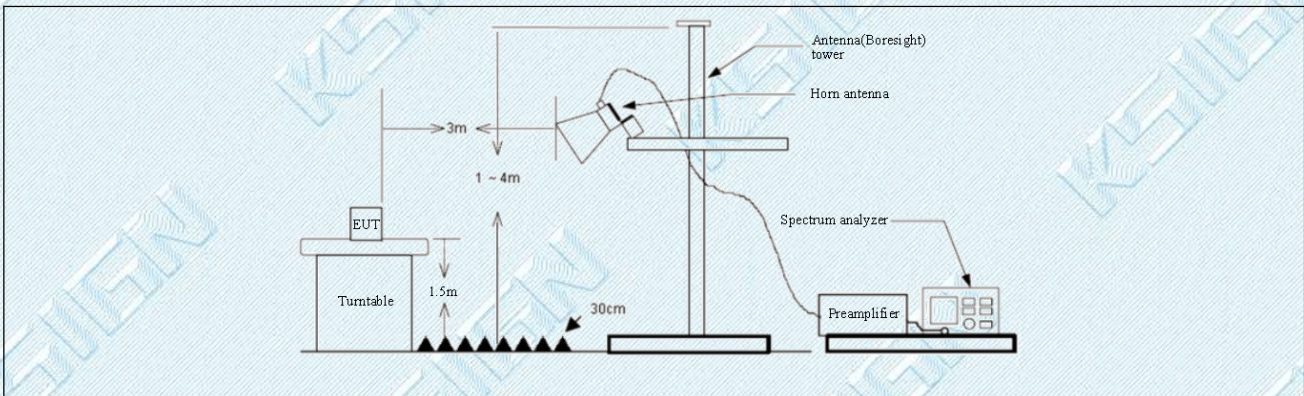

3.9.3. Test Data:

Test Mode1 / Polarization: Horizontal / Band: 5150-5250 MHz / BW: 20 / CH: L

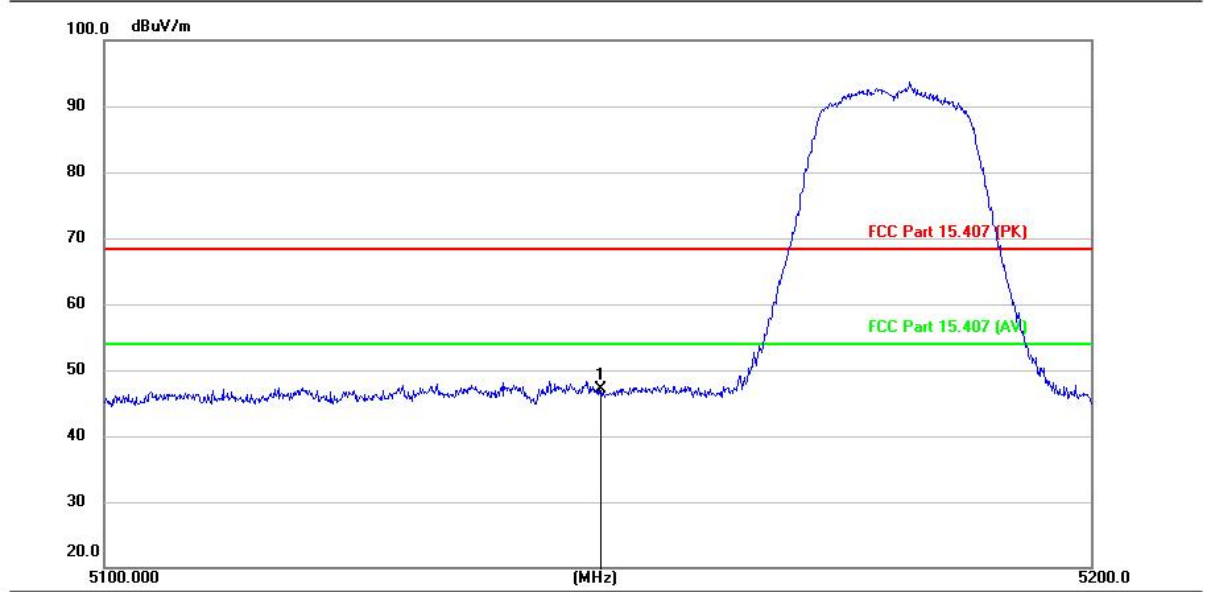

No.	Mk.	Freq.	Reading Level	Correct Factor	Measurement	Limit	Over	Detector
		MHz	(dBuV)	(dB/m)	(dBuV/m)	(dBuV/m)	(dB)	
1	*	5150.000	42.78	4.37	47.15	68.20	-21.05	peak

TRF No. RF_R1

Add: West Side of 1/F., Building C, Zone A, Fuyuan New Factory, Jiujiu Industrial Park, Minzhu, Shatou, Shajing, Bao'an District, Shenzhen, Guangdong, China

Tel: +(86) 0755-2985 2678 Fax: +(86) 0755-2985 2397 E-mail: info@gdksign.cn Web: www.gdksign.com

Test Mode1 / Polarization: Vertical / Band: 5150-5250 MHz / BW: 20 / CH: L

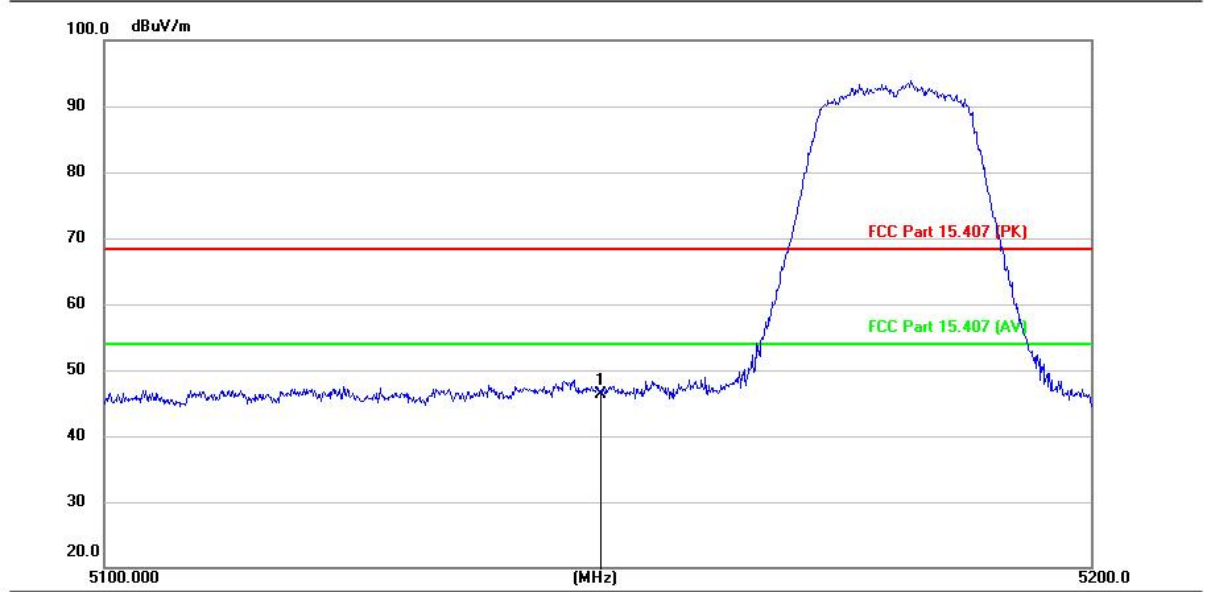

No.	Mk.	Freq. MHz	Reading Level (dBuV)	Correct Factor (dB/m)	Measurement (dBuV/m)	Limit (dBuV/m)	Over (dB)	Detector
1	*	5150.000	41.96	4.37	46.33	68.20	-21.87	peak

TRF No. RF_R1

Add: West Side of 1/F., Building C, Zone A, Fuyuan New Factory, Jiujiu Industrial Park, Minzhu, Shatou, Shajing, Bao'an District, Shenzhen, Guangdong, China

Tel: +(86) 0755-2985 2678 Fax: +(86) 0755-2985 2397 E-mail: info@gdkesign.cn Web: www.gdkesign.com

Test Mode1 / Polarization: Horizontal / Band: 5150-5250 MHz / BW: 20 / CH: H

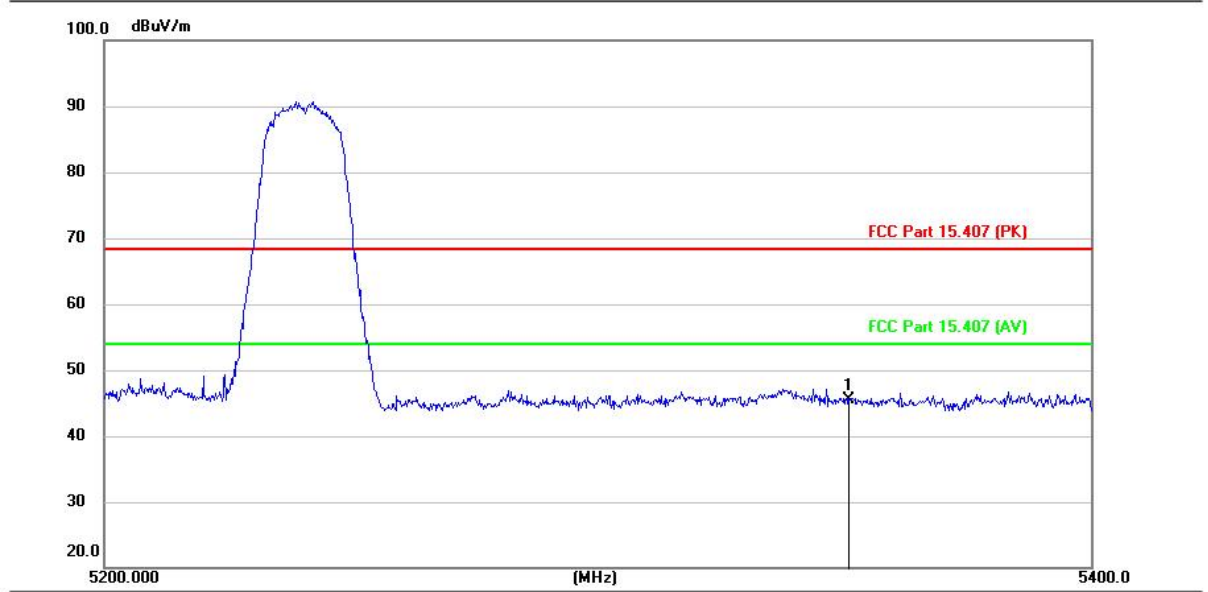

No.	Mk.	Freq. MHz	Reading Level (dBuV)	Correct Factor (dB/m)	Measurement (dBuV/m)	Limit (dBuV/m)	Over (dB)	Detector
1	*	5350.000	41.59	3.90	45.49	68.20	-22.71	peak

TRF No. RF_R1

Add: West Side of 1/F., Building C, Zone A, Fuyuan New Factory, Jiujiu Industrial Park, Minzhu, Shatou, Shajing, Bao'an District, Shenzhen, Guangdong, China

Tel: +(86) 0755-2985 2678 Fax: +(86) 0755-2985 2397 E-mail: info@gdkesign.cn Web: www.gdkesign.com

Test Mode1 / Polarization: Vertical / Band: 5150-5250 MHz / BW: 20 / CH: H

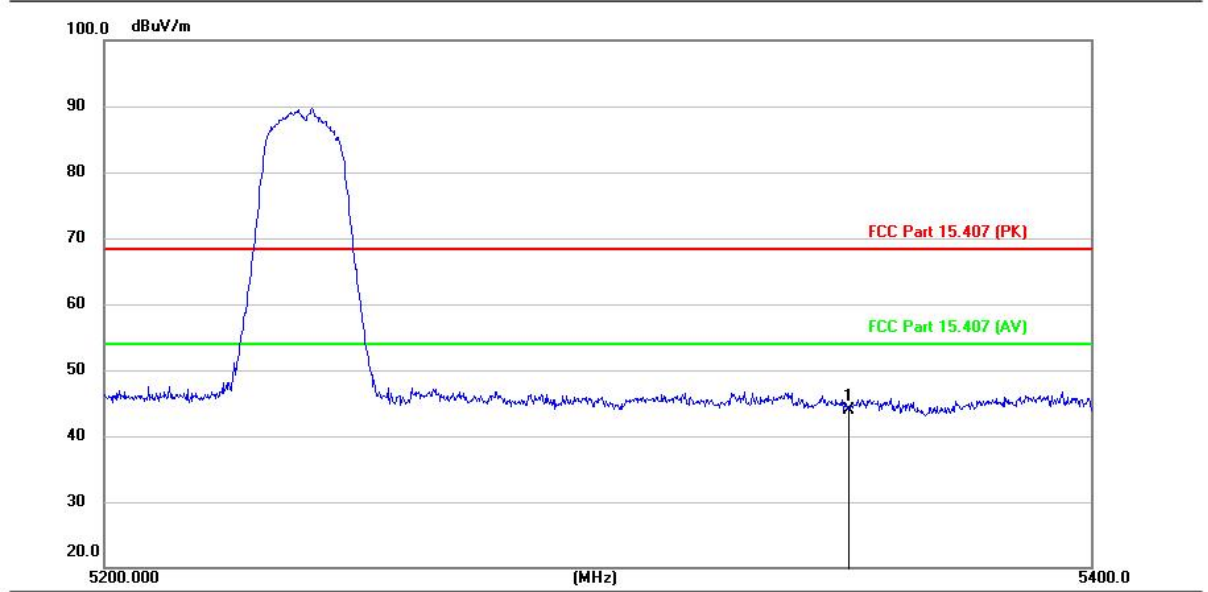

No.	Mk.	Freq. MHz	Reading Level (dBuV)	Correct Factor (dB/m)	Measurement (dBuV/m)	Limit (dBuV/m)	Over (dB)	Detector
1	*	5350.000	40.01	3.90	43.91	68.20	-24.29	peak

TRF No. RF_R1

Add: West Side of 1/F., Building C, Zone A, Fuyuan New Factory, Jiujiu Industrial Park, Minzhu, Shatou, Shajing, Bao'an District, Shenzhen, Guangdong, China

Tel: +(86) 0755-2985 2678 Fax: +(86) 0755-2985 2397 E-mail: info@gdkesign.cn Web: www.gdkesign.com

Test Mode1 / Polarization: Horizontal / Band: 5250-5350 MHz / BW: 20 / CH: L

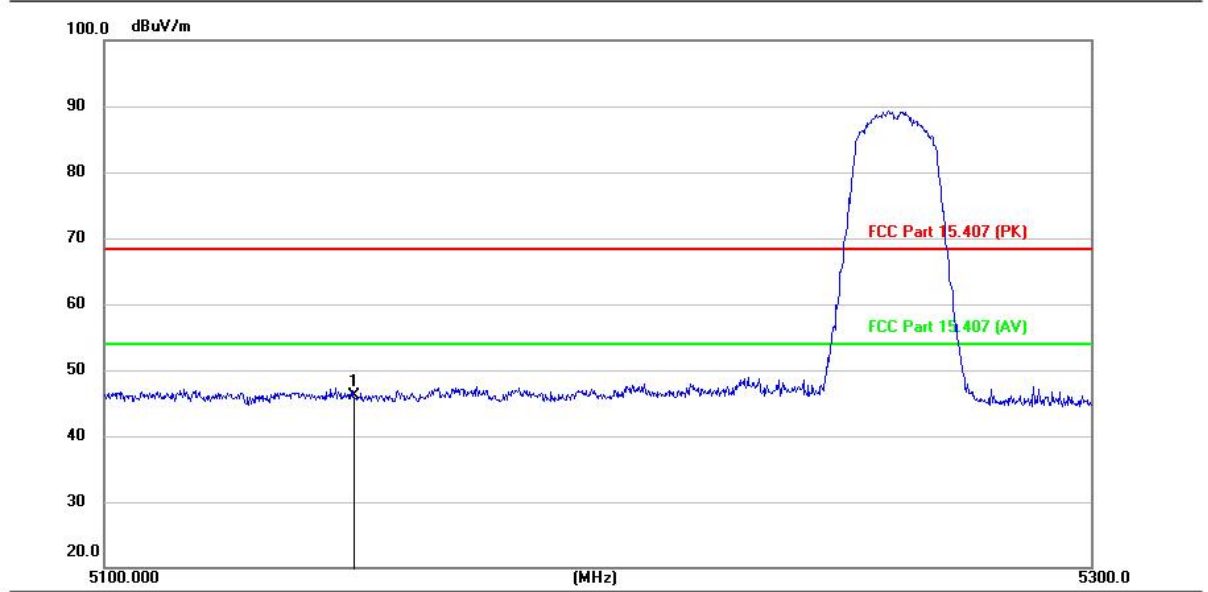

No.	Mk.	Freq. MHz	Reading Level (dBuV)	Correct Factor (dB/m)	Measurement (dBuV/m)	Limit (dBuV/m)	Over (dB)	Detector
1	*	5150.000	41.82	4.37	46.19	68.20	-22.01	peak

TRF No. RF_R1

Add: West Side of 1/F., Building C, Zone A, Fuyuan New Factory, Jiujiu Industrial Park, Minzhu, Shatou, Shajing, Bao'an District, Shenzhen, Guangdong, China

Tel: +(86) 0755-2985 2678 Fax: +(86) 0755-2985 2397 E-mail: info@gdkesign.cn Web: www.gdkesign.com

Test Mode1 / Polarization: Vertical / Band: 5250-5350 MHz / BW: 20 / CH: L

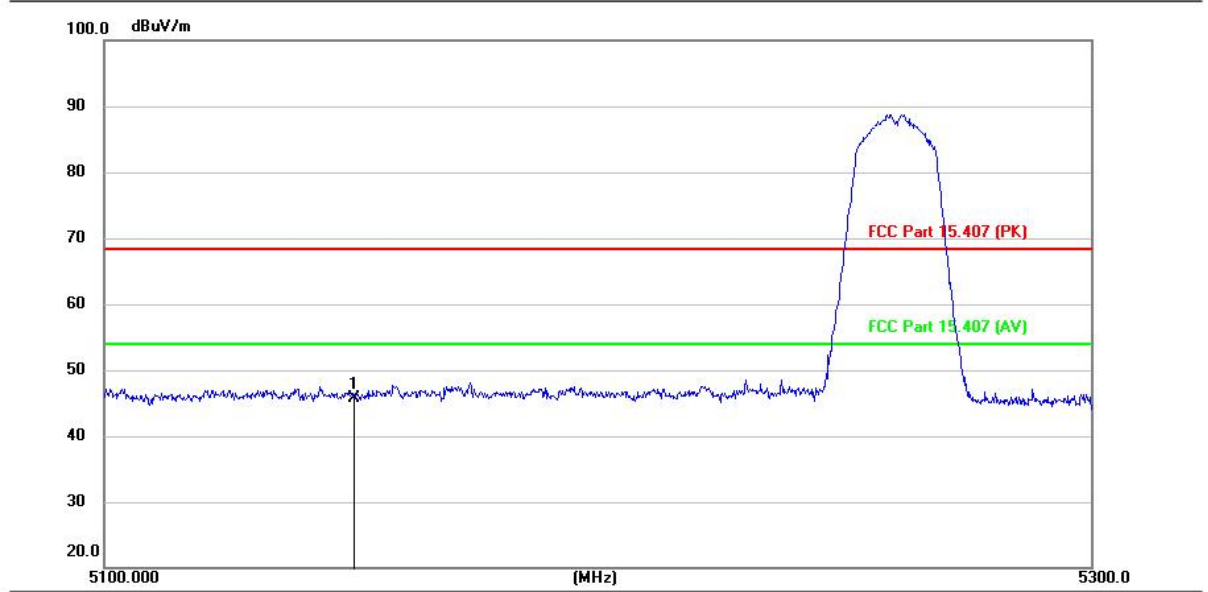

No.	Mk.	Freq. MHz	Reading Level (dBuV)	Correct Factor (dB/m)	Measurement (dBuV/m)	Limit (dBuV/m)	Over (dB)	Detector
1	*	5150.000	41.40	4.37	45.77	68.20	-22.43	peak

TRF No. RF_R1

Add: West Side of 1/F., Building C, Zone A, Fuyuan New Factory, Jiujiu Industrial Park, Minzhu, Shatou, Shajing, Bao'an District, Shenzhen, Guangdong, China

Tel: +(86) 0755-2985 2678 Fax: +(86) 0755-2985 2397 E-mail: info@gdkesign.cn Web: www.gdkesign.com

Test Mode1 / Polarization: Horizontal / Band: 5250-5350 MHz / BW: 20 / CH: H

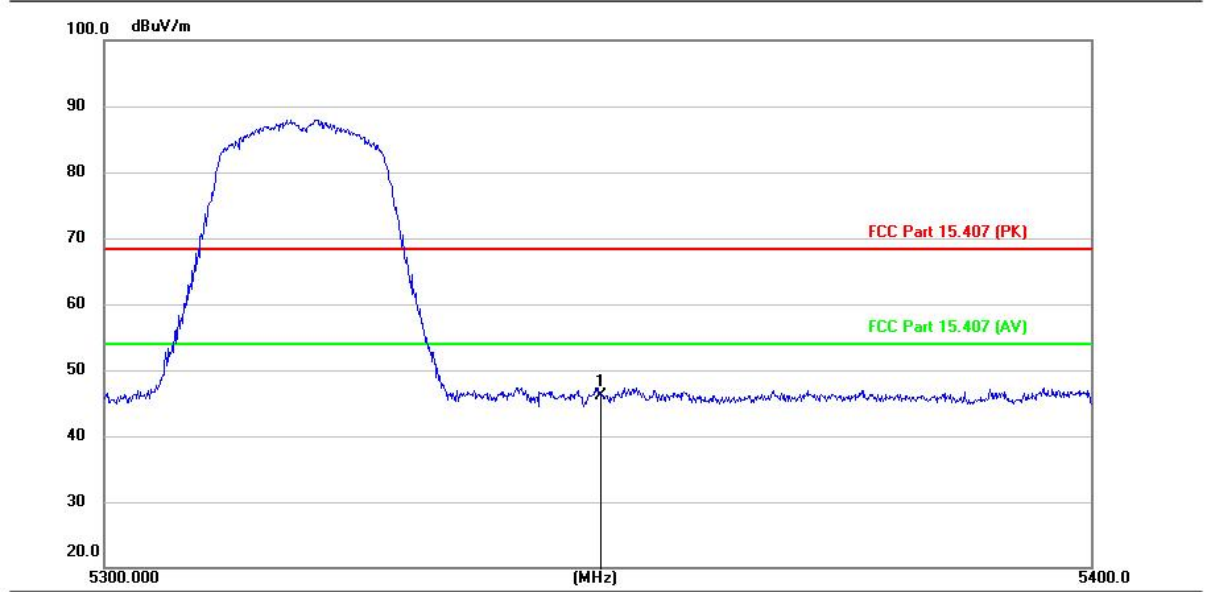

No.	Mk.	Freq. MHz	Reading Level (dBuV)	Correct Factor (dB/m)	Measurement (dBuV/m)	Limit (dBuV/m)	Over (dB)	Detector
1	*	5350.000	42.15	3.90	46.05	68.20	-22.15	peak

TRF No. RF_R1

Add: West Side of 1/F., Building C, Zone A, Fuyuan New Factory, Jiujiu Industrial Park, Minzhu, Shatou, Shajing, Bao'an District, Shenzhen, Guangdong, China

Tel: +(86) 0755-2985 2678 Fax: +(86) 0755-2985 2397 E-mail: info@gdkesign.cn Web: www.gdkesign.com

Test Mode1 / Polarization: Vertical / Band: 5250-5350 MHz / BW: 20 / CH: H

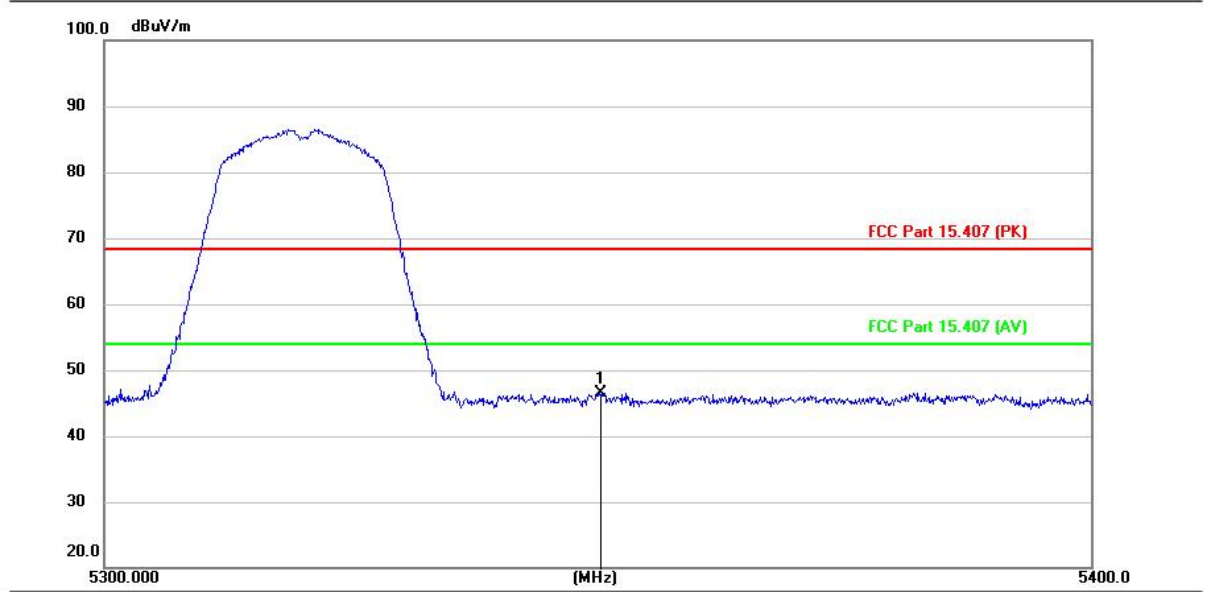

No.	Mk.	Freq. MHz	Reading Level (dBuV)	Correct Factor (dB/m)	Measurement (dBuV/m)	Limit (dBuV/m)	Over (dB)	Detector
1	*	5350.000	42.58	3.90	46.48	68.20	-21.72	peak

TRF No. RF_R1

Add: West Side of 1/F., Building C, Zone A, Fuyuan New Factory, Jiujiu Industrial Park, Minzhu, Shatou, Shajing, Bao'an District, Shenzhen, Guangdong, China

Tel: +(86) 0755-2985 2678 Fax: +(86) 0755-2985 2397 E-mail: info@gdkesign.cn Web: www.gdkesign.com

Test Mode1 / Polarization: Horizontal / Band: 5470-5725 MHz / BW: 20 / CH: L

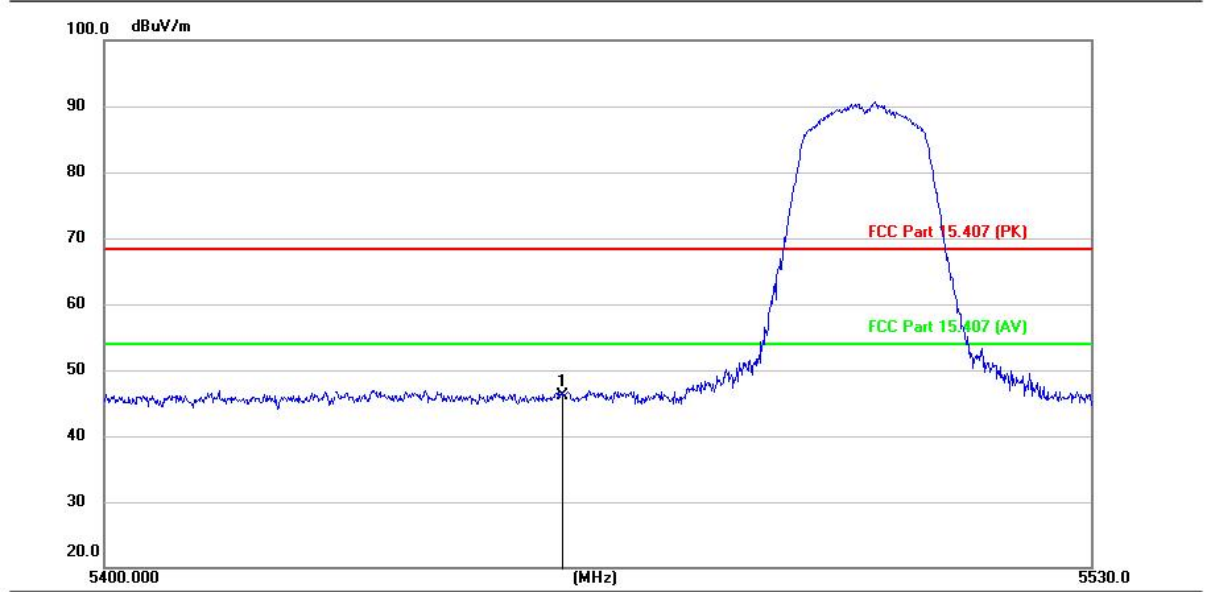

No.	Mk.	Freq. MHz	Reading Level (dBuV)	Correct Factor (dB/m)	Measurement (dBuV/m)	Limit (dBuV/m)	Over (dB)	Detector
1	*	5460.000	41.59	4.43	46.02	68.20	-22.18	peak

TRF No. RF_R1

Add: West Side of 1/F., Building C, Zone A, Fuyuan New Factory, Jiujiu Industrial Park, Minzhu, Shatou, Shajing, Bao'an District, Shenzhen, Guangdong, China

Tel: +(86) 0755-2985 2678 Fax: +(86) 0755-2985 2397 E-mail: info@gdkesign.cn Web: www.gdkesign.com

Test Mode1 / Polarization: Vertical / Band: 5470-5725 MHz / BW: 20 / CH: L

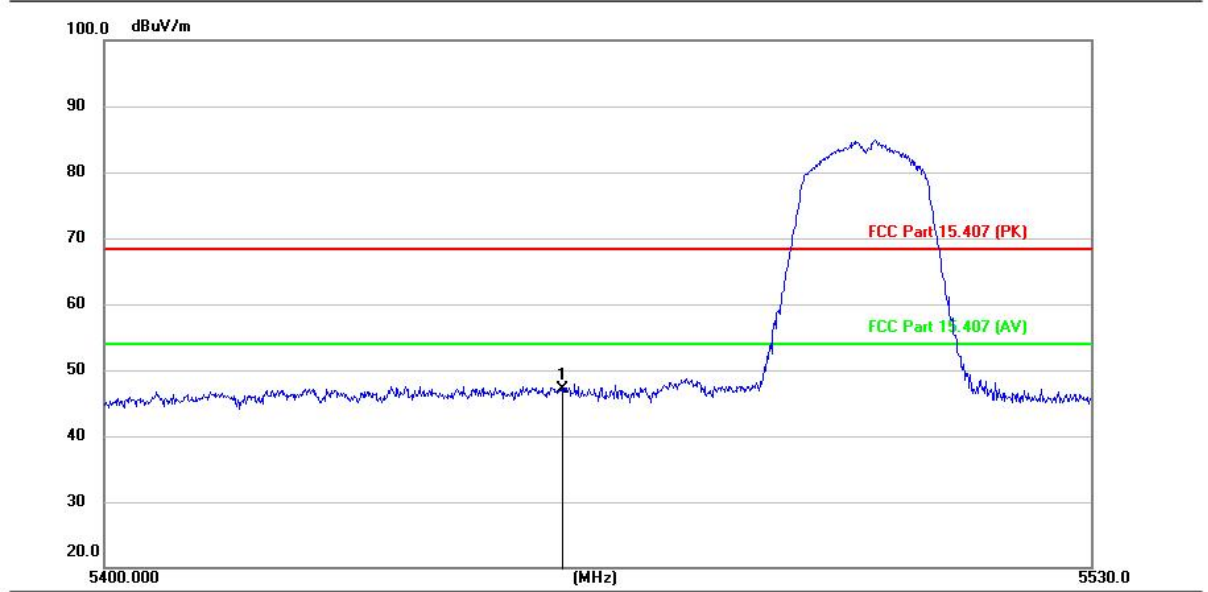

No.	Mk.	Freq. MHz	Reading Level (dBuV)	Correct Factor (dB/m)	Measurement (dBuV/m)	Limit (dBuV/m)	Over (dB)	Detector
1	*	5460.000	42.70	4.43	47.13	68.20	-21.07	peak

TRF No. RF_R1

Add: West Side of 1/F., Building C, Zone A, Fuyuan New Factory, Jiujiu Industrial Park, Minzhu, Shatou, Shajing, Bao'an District, Shenzhen, Guangdong, China

Tel: +(86) 0755-2985 2678 Fax: +(86) 0755-2985 2397 E-mail: info@gdkesign.cn Web: www.gdkesign.com

Test Mode1 / Polarization: Horizontal / Band: 5470-5725 MHz / BW: 20 / CH: H

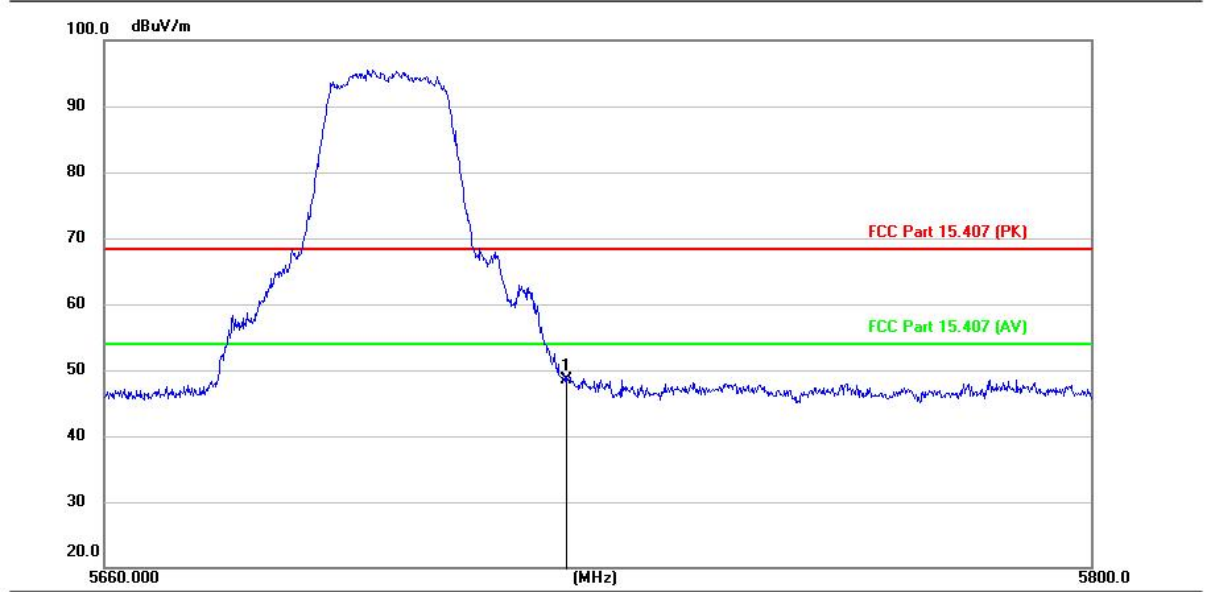

No.	Mk.	Freq. MHz	Reading Level (dBuV)	Correct Factor (dB/m)	Measurement (dBuV/m)	Limit (dBuV/m)	Over (dB)	Detector
1	*	5725.000	43.57	4.86	48.43	68.20	-19.77	peak

TRF No. RF_R1

Add: West Side of 1/F., Building C, Zone A, Fuyuan New Factory, Jiujiu Industrial Park, Minzhu, Shatou, Shajing, Bao'an District, Shenzhen, Guangdong, China

Tel: +(86) 0755-2985 2678 Fax: +(86) 0755-2985 2397 E-mail: info@gdkesign.cn Web: www.gdkesign.com

Test Mode1 / Polarization: Vertical / Band: 5470-5725 MHz / BW: 20 / CH: H

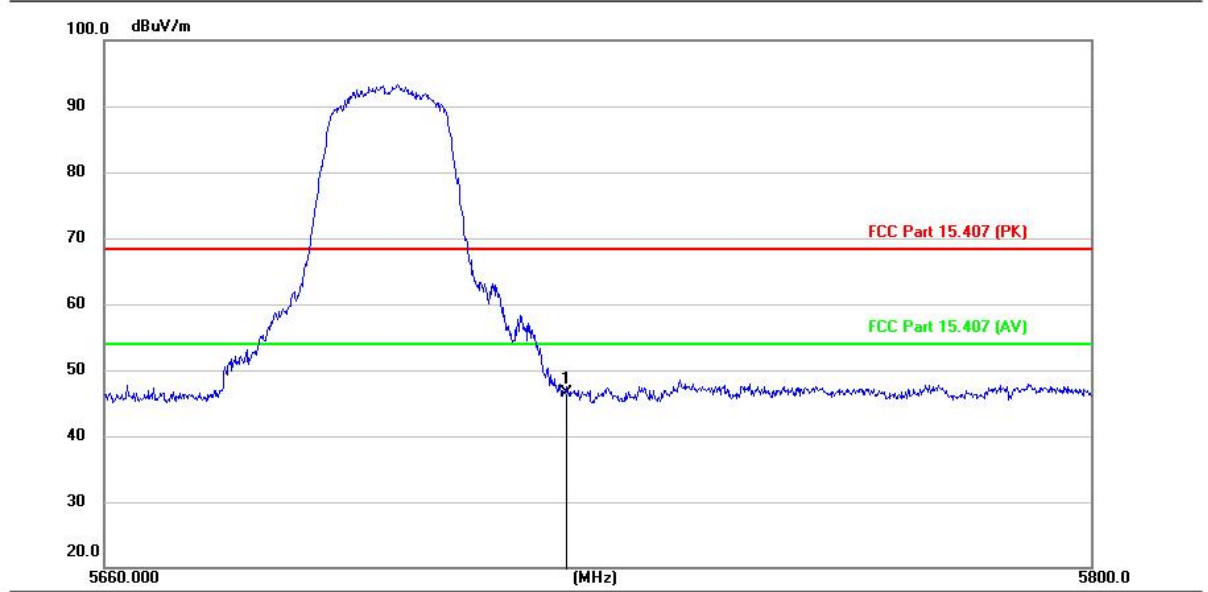

No.	Mk.	Freq. MHz	Reading Level (dBuV)	Correct Factor (dB/m)	Measurement (dBuV/m)	Limit (dBuV/m)	Over (dB)	Detector
1	*	5725.000	41.67	4.86	46.53	68.20	-21.67	peak

TRF No. RF_R1

Add: West Side of 1/F., Building C, Zone A, Fuyuan New Factory, Jiujiu Industrial Park, Minzhu, Shatou, Shajing, Bao'an District, Shenzhen, Guangdong, China

Tel: +(86) 0755-2985 2678 Fax: +(86) 0755-2985 2397 E-mail: info@gdkesign.cn Web: www.gdkesign.com

Test Mode1 / Polarization: Horizontal / Band: 5725-5850 MHz / BW: 20 / CH: L

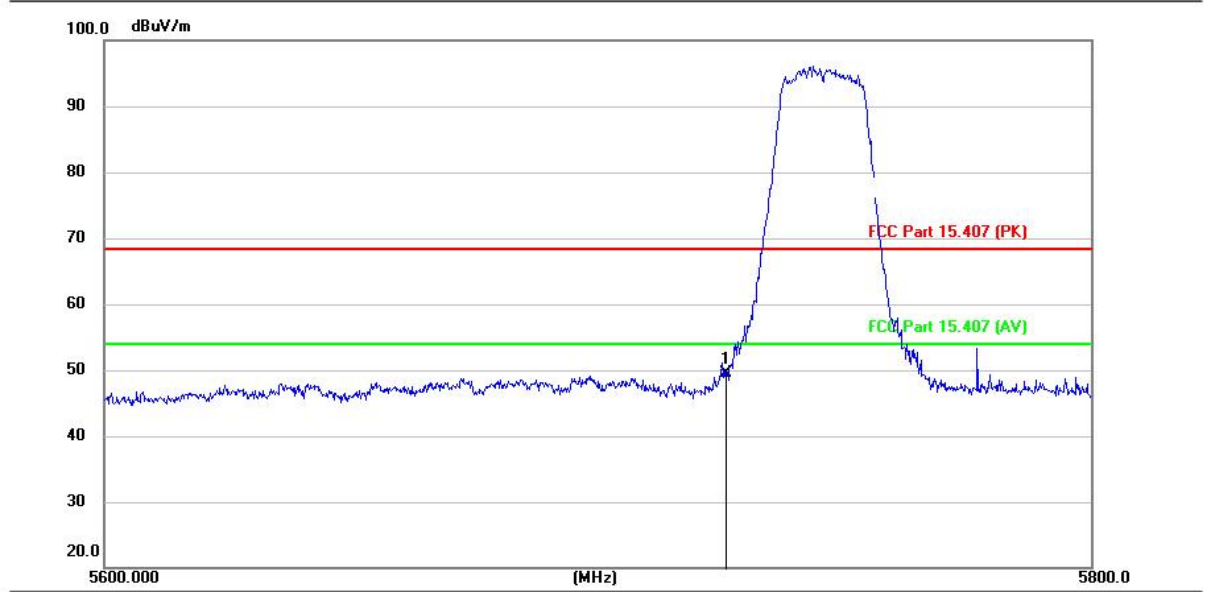

No.	Mk.	Freq. MHz	Reading Level (dBuV)	Correct Factor (dB/m)	Measurement (dBuV/m)	Limit (dBuV/m)	Over (dB)	Detector
1	*	5725.000	44.65	4.86	49.51	68.20	-18.69	peak

TRF No. RF_R1

Add: West Side of 1/F., Building C, Zone A, Fuyuan New Factory, Jiujiu Industrial Park, Minzhu, Shatou, Shajing, Bao'an District, Shenzhen, Guangdong, China

Tel: +(86) 0755-2985 2678 Fax: +(86) 0755-2985 2397 E-mail: info@gdkesign.cn Web: www.gdkesign.com

Test Mode1 / Polarization: Vertical / Band: 5725-5850 MHz / BW: 20 / CH: L

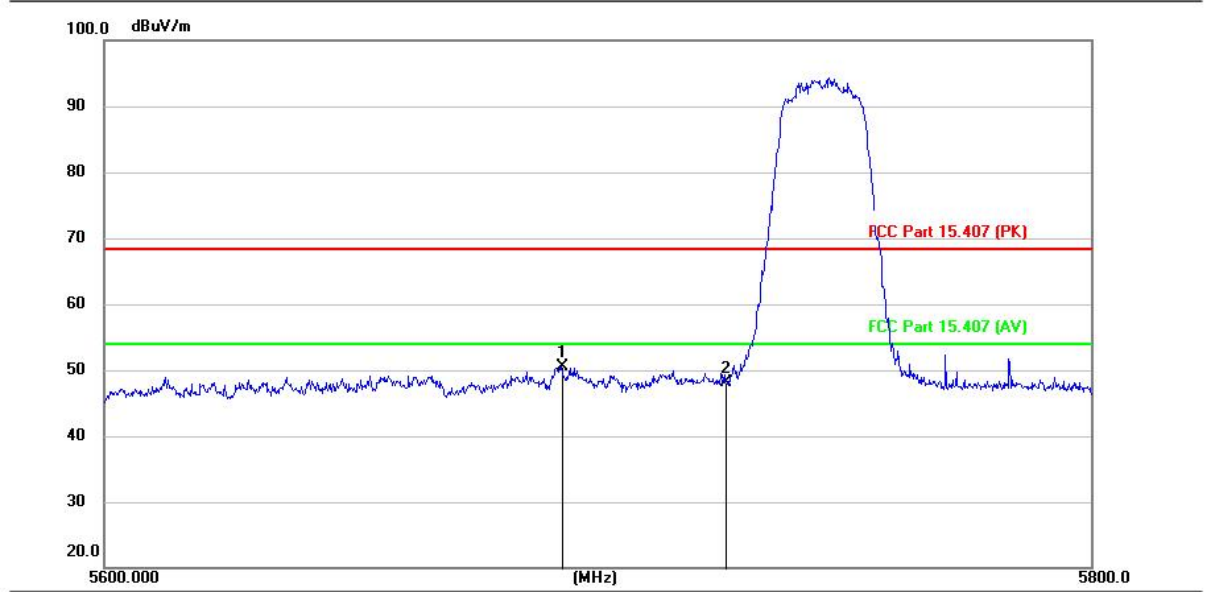

No.	Mk.	Freq. MHz	Reading Level (dBuV)	Correct Factor (dB/m)	Measurement (dBuV/m)	Limit (dBuV/m)	Over (dB)	Detector
1	*	5691.880	45.69	4.72	50.41	68.20	-17.79	peak
2		5725.000	43.15	4.86	48.01	68.20	-20.19	peak

TRF No. RF_R1

Add: West Side of 1/F., Building C, Zone A, Fuyuan New Factory, Jiujiu Industrial Park, Minzhu, Shatou, Shajing, Bao'an District, Shenzhen, Guangdong, China

Tel: +(86) 0755-2985 2678 Fax: +(86) 0755-2985 2397 E-mail: info@gdkesign.cn Web: www.gdkesign.com

Test Mode1 / Polarization: Horizontal / Band: 5725-5850 MHz / BW: 20 / CH: H

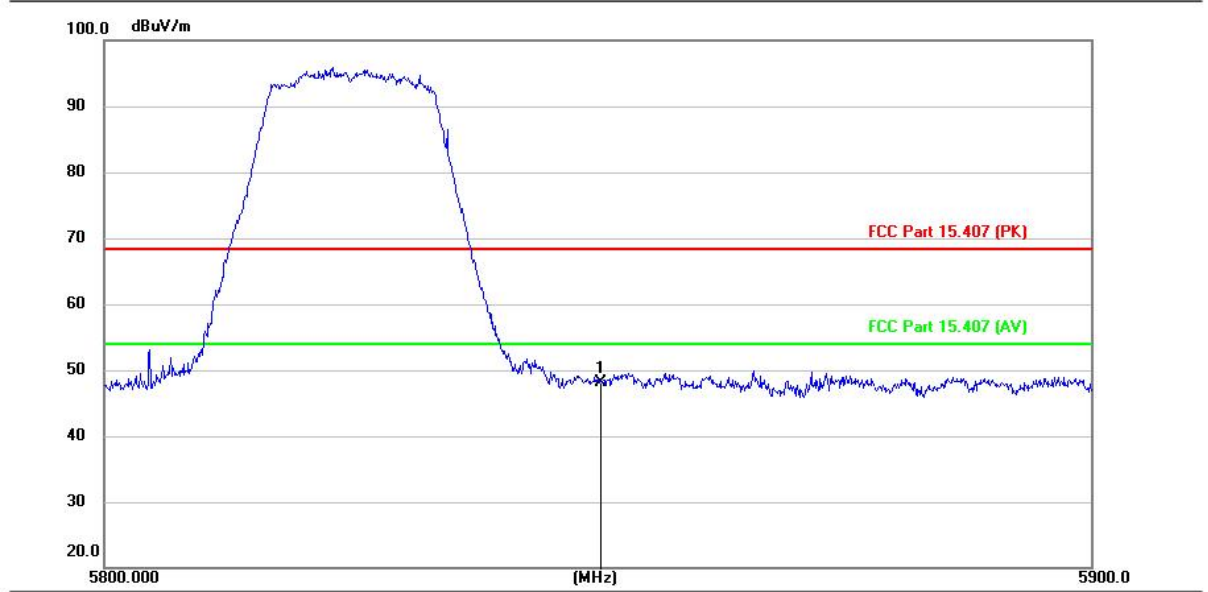

No.	Mk.	Freq. MHz	Reading Level (dBuV)	Correct Factor (dB/m)	Measurement (dBuV/m)	Limit (dBuV/m)	Over (dB)	Detector
1	*	5850.000	42.97	5.14	48.11	68.20	-20.09	peak

TRF No. RF_R1

Add: West Side of 1/F., Building C, Zone A, Fuyuan New Factory, Jiujiu Industrial Park, Minzhu, Shatou, Shajing, Bao'an District, Shenzhen, Guangdong, China

Tel: +(86) 0755-2985 2678 Fax: +(86) 0755-2985 2397 E-mail: info@gdkesign.cn Web: www.gdkesign.com

Test Mode1 / Polarization: Vertical / Band: 5725-5850 MHz / BW: 20 / CH: H

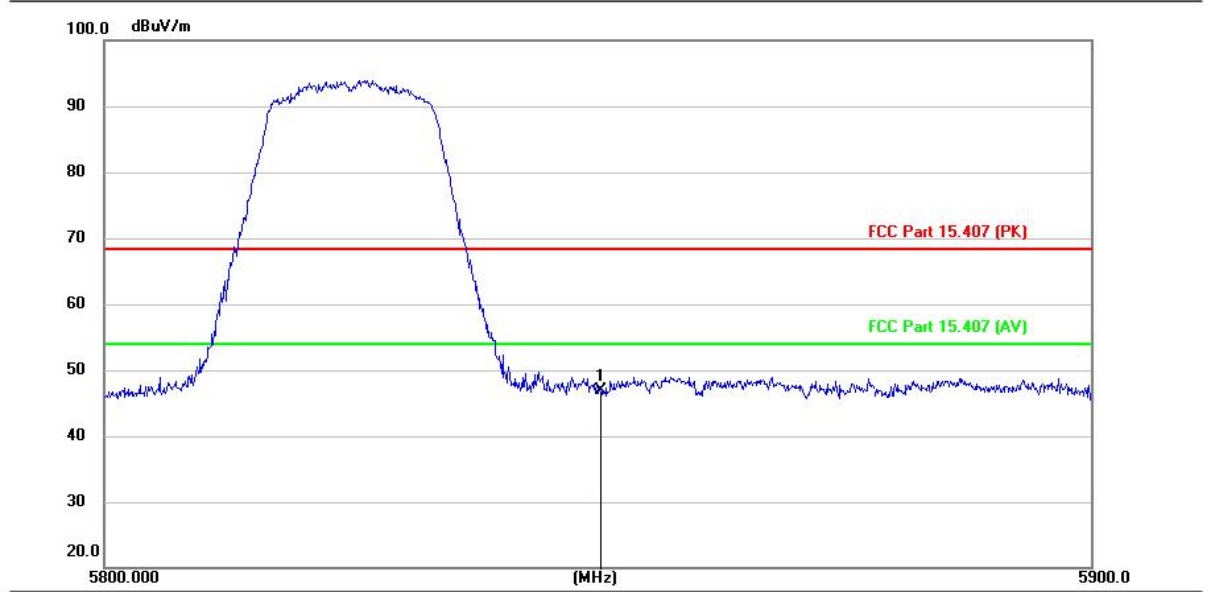

No.	Mk.	Freq. MHz	Reading Level (dBuV)	Correct Factor (dB/m)	Measurement (dBuV/m)	Limit (dBuV/m)	Over (dB)	Detector
1	*	5850.000	41.68	5.14	46.82	68.20	-21.38	peak

Note:

- 1.Measurement = Reading level + Correct Factor
- 2.Correct Factor=Antenna Factor + Cable Loss -Preamplifier Factor
- 3.Since the peak value is less than the limit of the AVG value, there is no AVG data
- 4.Pre-scan all mode, and found the A mode which it is worse case, so only show the test data for worse case.

TRF No. RF_R1

Add: West Side of 1/F., Building C, Zone A, Fuyuan New Factory, Jiujiu Industrial Park, Minzhu, Shatou, Shajing, Bao'an District, Shenzhen, Guangdong, China

Tel: +(86) 0755-2985 2678 Fax: +(86) 0755-2985 2397 E-mail: info@gdkesign.cn Web: www.gdkesign.com

3.10. Undesirable emission limits (below 1GHz)

Test Requirement:	47 CFR Part 15.407(b)(9)																								
Test Limit:	<p>Unwanted emissions below 1 GHz must comply with the general field strength limits set forth in § 15.209.</p> <p>Except as provided elsewhere in this subpart, the emissions from an intentional radiator shall not exceed the field strength levels specified in the following table:</p> <table border="1" data-bbox="491 477 1433 808"> <thead> <tr> <th>Frequency (MHz)</th> <th>Field strength (microvolts/meter)</th> <th>Measurement distance (meters)</th> </tr> </thead> <tbody> <tr> <td>0.009-0.490</td> <td>2400/F(kHz)</td> <td>300</td> </tr> <tr> <td>0.490-1.705</td> <td>24000/F(kHz)</td> <td>30</td> </tr> <tr> <td>1.705-30.0</td> <td>30</td> <td>30</td> </tr> <tr> <td>30-88</td> <td>100 **</td> <td>3</td> </tr> <tr> <td>88-216</td> <td>150 **</td> <td>3</td> </tr> <tr> <td>216-960</td> <td>200 **</td> <td>3</td> </tr> <tr> <td>Above 960</td> <td>500</td> <td>3</td> </tr> </tbody> </table> <p>** Except as provided in paragraph (g), fundamental emissions from intentional radiators operating under this section shall not be located in the frequency bands 54-72 MHz, 76-88 MHz, 174-216 MHz or 470-806 MHz. However, operation within these frequency bands is permitted under other sections of this part, e.g., §§ 15.231 and 15.241.</p> <p>In the emission table above, the tighter limit applies at the band edges.</p> <p>The emission limits shown in the above table are based on measurements employing a CISPR quasi-peak detector except for the frequency bands 9–90 kHz, 110–490 kHz and above 1000 MHz. Radiated emission limits in these three bands are based on measurements employing an average detector.</p>	Frequency (MHz)	Field strength (microvolts/meter)	Measurement distance (meters)	0.009-0.490	2400/F(kHz)	300	0.490-1.705	24000/F(kHz)	30	1.705-30.0	30	30	30-88	100 **	3	88-216	150 **	3	216-960	200 **	3	Above 960	500	3
Frequency (MHz)	Field strength (microvolts/meter)	Measurement distance (meters)																							
0.009-0.490	2400/F(kHz)	300																							
0.490-1.705	24000/F(kHz)	30																							
1.705-30.0	30	30																							
30-88	100 **	3																							
88-216	150 **	3																							
216-960	200 **	3																							
Above 960	500	3																							
Test Method:	ANSI C63.10-2013, section 12.7.4, 12.7.5																								
Procedure:	<p>Below 1GHz:</p> <ol style="list-style-type: none"> For below 1GHz, the EUT was placed on the top of a rotating table 0.8 meters above the ground at a 3 meter semi-anechoic chamber. The table was rotated 360 degrees to determine the position of the highest radiation. The EUT was set 3 or 10 meters away from the interference-receiving antenna, which was mounted on the top of a variable-height antenna tower. The antenna height is varied from one meter to four meters above the ground to determine the maximum value of the field strength. Both horizontal and vertical polarizations of the antenna are set to make the measurement. For each suspected emission, the EUT was arranged to its worst case and then the antenna was tuned to heights from 1 meter to 4 meters (for the test frequency of below 30MHz, the antenna was tuned to heights 1 meter) and the rotatable table was turned from 0 degrees to 360 degrees to find the maximum reading. The test-receiver system was set to Peak Detect Function and Specified Bandwidth with Maximum Hold Mode. If the emission level of the EUT in peak mode was 10dB lower than the limit specified, then testing could be stopped and the peak values of the EUT would be reported. Otherwise the emissions that did not have 10dB margin would be re-tested one by one using quasi-peak method as specified and then reported in a data sheet. Test the EUT in the lowest channel, the middle channel, the Highest channel. The radiation measurements are performed in X, Y, Z axis positioning for Transmitting mode, and found the X axis positioning which it is the worst case. Repeat above procedures until all frequencies measured was complete. <p>Remark:</p> <ol style="list-style-type: none"> Level= Read Level+ Cable Loss+ Antenna Factor- Preamp Factor 																								

TRF No. RF_R1

Add: West Side of 1/F., Building C, Zone A, Fuyuan New Factory, Jiujiu Industrial Park, Minzhu, Shatou, Shajing, Bao'an District, Shenzhen, Guangdong, China

Tel: +(86) 0755-2985 2678 Fax: +(86) 0755-2985 2397 E-mail: info@gdkesign.cn Web: www.gdkesign.com

	<p>2. Scan from 9kHz to 30MHz, the disturbance below 30MHz was very low. The points marked on above plots are the highest emissions could be found when testing, so only above points had been displayed. The amplitude of spurious emissions from the radiator which are attenuated more than 20dB below the limit need not be reported.</p> <p>3. The disturbance below 1GHz was very low and the harmonics were the highest point could be found when testing, so only the above harmonics had been displayed.</p> <p>Above 1GHz:</p> <p>a. For above 1GHz, the EUT was placed on the top of a rotating table 1.5 meters above the ground at a 3 meter fully-anechoic chamber. The table was rotated 360 degrees to determine the position of the highest radiation.</p> <p>b. The EUT was set 3 meters away from the interference-receiving antenna, which was mounted on the top of a variable-height antenna tower.</p> <p>c. The antenna height is varied from one meter to four meters above the ground to determine the maximum value of the field strength. Both horizontal and vertical polarizations of the antenna are set to make the measurement.</p> <p>d. For each suspected emission, the EUT was arranged to its worst case and then the antenna was tuned to heights from 1 meter to 4 meters (for the test frequency of below 30MHz, the antenna was tuned to heights 1 meter) and the rotatable table was turned from 0 degrees to 360 degrees to find the maximum reading.</p> <p>e. The test-receiver system was set to Peak Detect Function and Specified Bandwidth with Maximum Hold Mode.</p> <p>f. If the emission level of the EUT in peak mode was 10dB lower than the limit specified, then testing could be stopped and the peak values of the EUT would be reported. Otherwise the emissions that did not have 10dB margin would be re-tested one by one using peak or average method as specified and then reported in a data sheet.</p> <p>g. Test the EUT in the lowest channel, the middle channel, the Highest channel.</p> <p>h. The radiation measurements are performed in X, Y, Z axis positioning for Transmitting mode, and found the X axis positioning which it is the worst case.</p> <p>i. Repeat above procedures until all frequencies measured was complete.</p> <p>Remark:</p> <p>1. Level= Read Level+ Cable Loss+ Antenna Factor- Preamp Factor</p> <p>2. Scan from 18GHz to 40GHz, the disturbance above 18GHz was very low. The points marked on above plots are the highest emissions could be found when testing, so only above points had been displayed. The amplitude of spurious emissions from the radiator which are attenuated more than 20dB below the limit need not be reported.</p> <p>3. As shown in this section, for frequencies above 1GHz, the field strength limits are based on average limits. However, the peak field strength of any emission shall not exceed the maximum permitted average limits specified above by more than 20 dB under any condition of modulation. For the emissions whose peak level is lower than the average limit, only the peak measurement is shown in the report.</p> <p>4. The disturbance above 18GHz were very low and the harmonics were the highest point could be found when testing, so only the above harmonics had been displayed.</p>
--	--

3.10.1. E.U.T. Operation:

Operating Environment:	
Temperature:	23.3 °C
Humidity:	44.4 %
Atmospheric Pressure:	101 kPa

TRF No. RF_R1

Add: West Side of 1/F., Building C, Zone A, Fuyuan New Factory, Jiujiu Industrial Park, Minzhu, Shatou, Shajing, Bao'an District, Shenzhen, Guangdong, China

Tel: +(86) 0755-2985 2678 Fax: +(86) 0755-2985 2397 E-mail: info@gdkesign.cn Web: www.gdkesign.com

Final test mode:	Test Mode1, Test Mode2
------------------	------------------------

3.10.2. Test Setup Diagram:

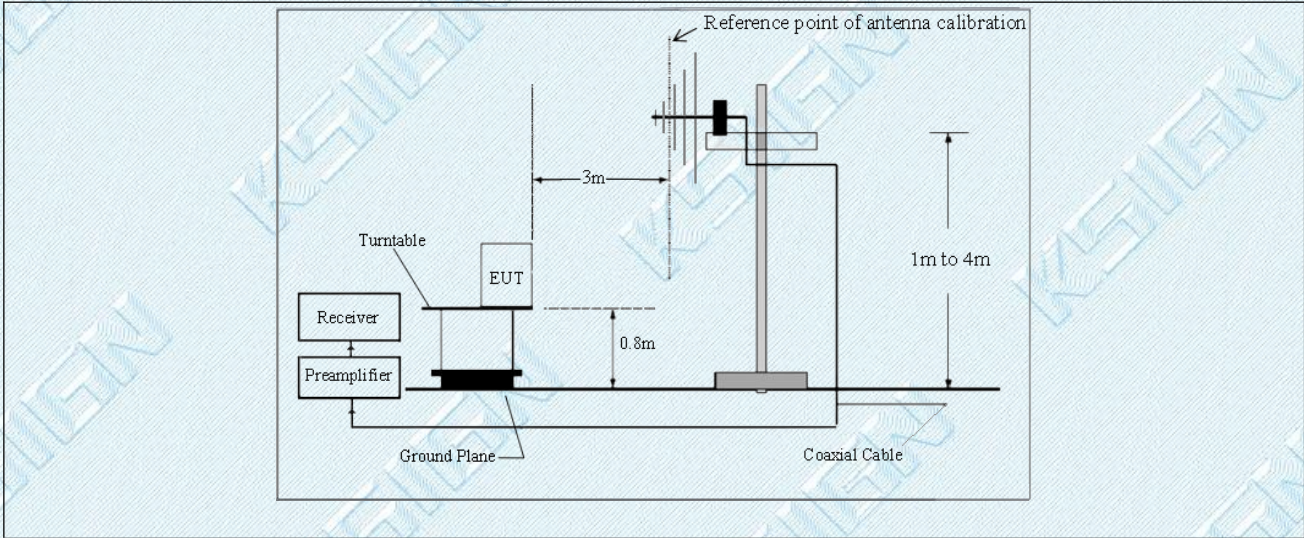

3.10.3. Test Data:

Test Mode1 / Polarization: Horizontal / Band: 5150-5250 MHz / BW: 20 / CH: L

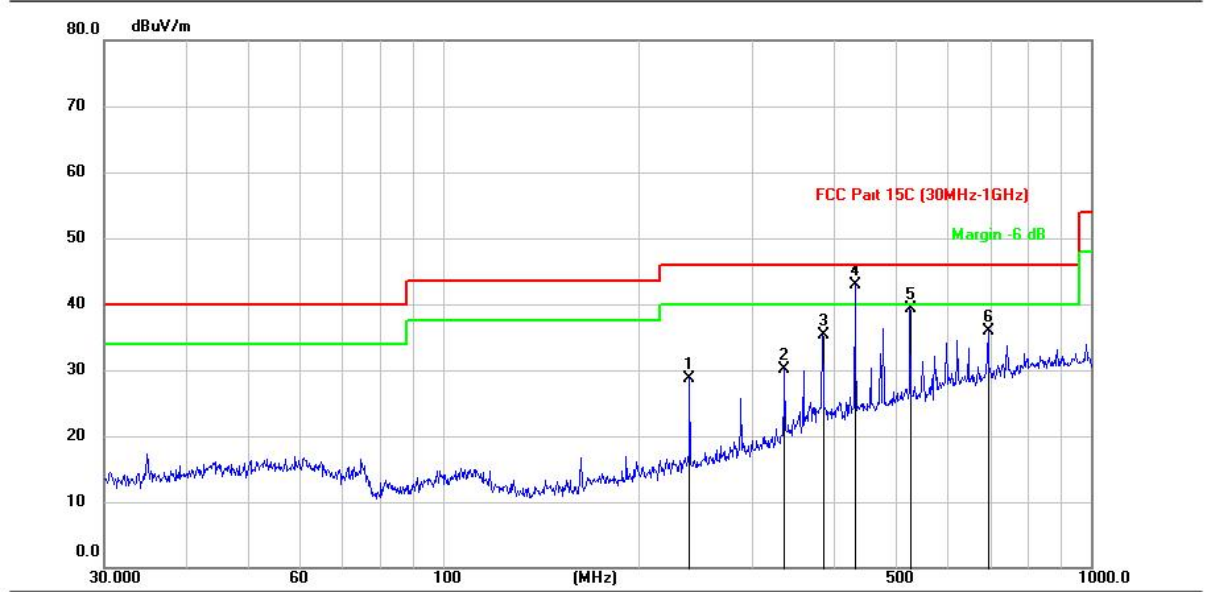

No.	Mk.	Freq. MHz	Reading Level (dBuV)	Correct Factor (dB/m)	Measurement (dBuV/m)	Limit (dBuV/m)	Over (dB)	Detector
1		239.9873	39.22	-10.55	28.67	46.00	-17.33	peak
2		336.0350	36.46	-6.35	30.11	46.00	-15.89	peak
3		384.0663	39.13	-3.86	35.27	46.00	-10.73	peak
4	*	432.0908	45.81	-3.00	42.81	46.00	-3.19	peak
5		528.0606	40.49	-1.21	39.28	46.00	-6.72	peak
6		696.1240	33.82	2.02	35.84	46.00	-10.16	peak

Test Mode1 / Polarization: Vertical / Band: 5150-5250 MHz / BW: 20 / CH: L

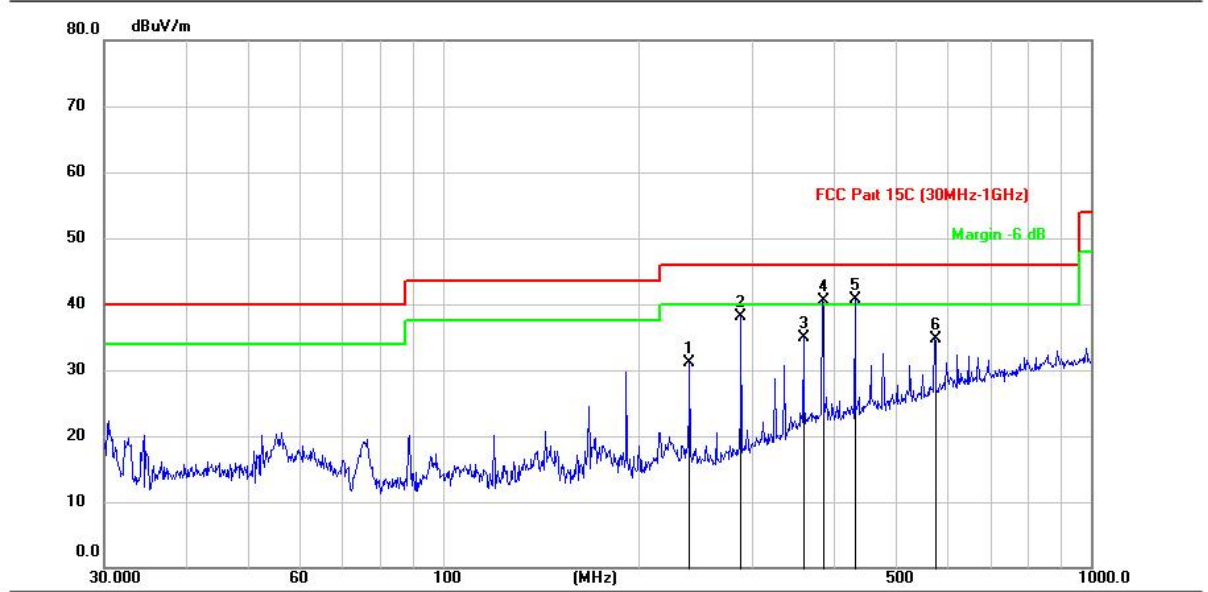

No.	Mk.	Freq. MHz	Reading Level (dBuV)	Correct Factor (dB/m)	Measurement (dBuV/m)	Limit (dBuV/m)	Over (dB)	Detector
1		239.9873	41.68	-10.55	31.13	46.00	-14.87	peak
2		287.9904	46.91	-8.83	38.08	46.00	-7.92	peak
3		360.0686	40.08	-5.26	34.82	46.00	-11.18	peak
4	!	384.0663	44.40	-3.86	40.54	46.00	-5.46	peak
5	*	432.0908	43.80	-3.00	40.80	46.00	-5.20	peak
6		576.0380	34.70	-0.01	34.69	46.00	-11.31	peak

Note:

- 1.Measurement = Reading level + Correct Factor
- 2.Correct Factor=Antenna Factor + Cable Loss - Preamplifier Factor
- 3.Over = Measurement -Limit
- 4.Pre-scan all mode, and found the low channel of Mode 1 which it is worse case, so only show the test data for worse case.

3.11. Undesirable emission limits (above 1GHz)

<p>Test Requirement:</p>	<p>47 CFR Part 15.407(b)(1) 47 CFR Part 15.407(b)(2) 47 CFR Part 15.407(b)(3) 47 CFR Part 15.407(b)(4) 47 CFR Part 15.407(b)(10)</p>																																																																											
<p>Test Limit:</p>	<p>For transmitters operating in the 5.15-5.25 GHz band: All emissions outside of the 5.15-5.35 GHz band shall not exceed an e.i.r.p. of -27 dBm/MHz.</p> <p>For transmitters operating in the 5.25-5.35 GHz band: All emissions outside of the 5.15-5.35 GHz band shall not exceed an e.i.r.p. of -27 dBm/MHz.</p> <p>For transmitters operating in the 5.47-5.725 GHz band: All emissions outside of the 5.47-5.725 GHz band shall not exceed an e.i.r.p. of -27 dBm/MHz.</p> <p>For transmitters operating solely in the 5.725-5.850 GHz band: All emissions shall be limited to a level of -27 dBm/MHz at 75 MHz or more above or below the band edge increasing linearly to 10 dBm/MHz at 25 MHz above or below the band edge, and from 25 MHz above or below the band edge increasing linearly to a level of 15.6 dBm/MHz at 5 MHz above or below the band edge, and from 5 MHz above or below the band edge increasing linearly to a level of 27 dBm/MHz at the band edge.</p> <table border="1" data-bbox="491 958 1433 1653"> <thead> <tr> <th>MHz</th> <th>MHz</th> <th>MHz</th> <th>GHz</th> </tr> </thead> <tbody> <tr> <td>0.090-0.110</td> <td>16.42-16.423</td> <td>399.9-410</td> <td>4.5-5.15</td> </tr> <tr> <td>¹ 0.495-0.505</td> <td>16.69475-16.69525</td> <td>608-614</td> <td>5.35-5.46</td> </tr> <tr> <td>2.1735-2.1905</td> <td>16.80425-16.80475</td> <td>960-1240</td> <td>7.25-7.75</td> </tr> <tr> <td>4.125-4.128</td> <td>25.5-25.67</td> <td>1300-1427</td> <td>8.025-8.5</td> </tr> <tr> <td>4.17725-4.17775</td> <td>37.5-38.25</td> <td>1435-1626.5</td> <td>9.0-9.2</td> </tr> <tr> <td>4.20725-4.20775</td> <td>73-74.6</td> <td>1645.5-1646.5</td> <td>9.3-9.5</td> </tr> <tr> <td>6.215-6.218</td> <td>74.8-75.2</td> <td>1660-1710</td> <td>10.6-12.7</td> </tr> <tr> <td>6.26775-6.26825</td> <td>108-121.94</td> <td>1718.8-1722.2</td> <td>13.25-13.4</td> </tr> <tr> <td>6.31175-6.31225</td> <td>123-138</td> <td>2200-2300</td> <td>14.47-14.5</td> </tr> <tr> <td>8.291-8.294</td> <td>149.9-150.05</td> <td>2310-2390</td> <td>15.35-16.2</td> </tr> <tr> <td>8.362-8.366</td> <td>156.52475-156.52525</td> <td>2483.5-2500</td> <td>17.7-21.4</td> </tr> <tr> <td>8.37625-8.38675</td> <td>156.7-156.9</td> <td>2690-2900</td> <td>22.01-23.12</td> </tr> <tr> <td>8.41425-8.41475</td> <td>162.0125-167.17</td> <td>3260-3267</td> <td>23.6-24.0</td> </tr> <tr> <td>12.29-12.293</td> <td>167.72-173.2</td> <td>3332-3339</td> <td>31.2-31.8</td> </tr> <tr> <td>12.51975-12.52025</td> <td>240-285</td> <td>3345.8-3358</td> <td>36.43-36.5</td> </tr> <tr> <td>12.57675-12.57725</td> <td>322-335.4</td> <td>3600-4400</td> <td>(²)</td> </tr> <tr> <td>13.36-13.41</td> <td></td> <td></td> <td></td> </tr> </tbody> </table> <p>¹ Until February 1, 1999, this restricted band shall be 0.490-0.510 MHz.</p> <p>² Above 38.6</p> <p>The field strength of emissions appearing within these frequency bands shall not exceed the limits shown in § 15.209. At frequencies equal to or less than 1000 MHz, compliance with the limits in § 15.209 shall be demonstrated using measurement instrumentation employing a CISPR quasi-peak detector. Above 1000 MHz, compliance with the emission limits in § 15.209 shall be demonstrated based on the average value of the measured emissions. The provisions in § 15.35 apply to these measurements.</p>				MHz	MHz	MHz	GHz	0.090-0.110	16.42-16.423	399.9-410	4.5-5.15	¹ 0.495-0.505	16.69475-16.69525	608-614	5.35-5.46	2.1735-2.1905	16.80425-16.80475	960-1240	7.25-7.75	4.125-4.128	25.5-25.67	1300-1427	8.025-8.5	4.17725-4.17775	37.5-38.25	1435-1626.5	9.0-9.2	4.20725-4.20775	73-74.6	1645.5-1646.5	9.3-9.5	6.215-6.218	74.8-75.2	1660-1710	10.6-12.7	6.26775-6.26825	108-121.94	1718.8-1722.2	13.25-13.4	6.31175-6.31225	123-138	2200-2300	14.47-14.5	8.291-8.294	149.9-150.05	2310-2390	15.35-16.2	8.362-8.366	156.52475-156.52525	2483.5-2500	17.7-21.4	8.37625-8.38675	156.7-156.9	2690-2900	22.01-23.12	8.41425-8.41475	162.0125-167.17	3260-3267	23.6-24.0	12.29-12.293	167.72-173.2	3332-3339	31.2-31.8	12.51975-12.52025	240-285	3345.8-3358	36.43-36.5	12.57675-12.57725	322-335.4	3600-4400	(²)	13.36-13.41			
MHz	MHz	MHz	GHz																																																																									
0.090-0.110	16.42-16.423	399.9-410	4.5-5.15																																																																									
¹ 0.495-0.505	16.69475-16.69525	608-614	5.35-5.46																																																																									
2.1735-2.1905	16.80425-16.80475	960-1240	7.25-7.75																																																																									
4.125-4.128	25.5-25.67	1300-1427	8.025-8.5																																																																									
4.17725-4.17775	37.5-38.25	1435-1626.5	9.0-9.2																																																																									
4.20725-4.20775	73-74.6	1645.5-1646.5	9.3-9.5																																																																									
6.215-6.218	74.8-75.2	1660-1710	10.6-12.7																																																																									
6.26775-6.26825	108-121.94	1718.8-1722.2	13.25-13.4																																																																									
6.31175-6.31225	123-138	2200-2300	14.47-14.5																																																																									
8.291-8.294	149.9-150.05	2310-2390	15.35-16.2																																																																									
8.362-8.366	156.52475-156.52525	2483.5-2500	17.7-21.4																																																																									
8.37625-8.38675	156.7-156.9	2690-2900	22.01-23.12																																																																									
8.41425-8.41475	162.0125-167.17	3260-3267	23.6-24.0																																																																									
12.29-12.293	167.72-173.2	3332-3339	31.2-31.8																																																																									
12.51975-12.52025	240-285	3345.8-3358	36.43-36.5																																																																									
12.57675-12.57725	322-335.4	3600-4400	(²)																																																																									
13.36-13.41																																																																												

	<p>Except as provided elsewhere in this subpart, the emissions from an intentional radiator shall not exceed the field strength levels specified in the following table:</p> <table border="1" data-bbox="491 320 1433 651"> <thead> <tr> <th>Frequency (MHz)</th> <th>Field strength (microvolts/meter)</th> <th>Measurement distance (meters)</th> </tr> </thead> <tbody> <tr> <td>0.009-0.490</td> <td>2400/F(kHz)</td> <td>300</td> </tr> <tr> <td>0.490-1.705</td> <td>24000/F(kHz)</td> <td>30</td> </tr> <tr> <td>1.705-30.0</td> <td>30</td> <td>30</td> </tr> <tr> <td>30-88</td> <td>100 **</td> <td>3</td> </tr> <tr> <td>88-216</td> <td>150 **</td> <td>3</td> </tr> <tr> <td>216-960</td> <td>200 **</td> <td>3</td> </tr> <tr> <td>Above 960</td> <td>500</td> <td>3</td> </tr> </tbody> </table> <p>** Except as provided in paragraph (g), fundamental emissions from intentional radiators operating under this section shall not be located in the frequency bands 54-72 MHz, 76-88 MHz, 174-216 MHz or 470-806 MHz. However, operation within these frequency bands is permitted under other sections of this part, e.g., §§ 15.231 and 15.241.</p> <p>In the emission table above, the tighter limit applies at the band edges.</p> <p>The emission limits shown in the above table are based on measurements employing a CISPR quasi-peak detector except for the frequency bands 9–90 kHz, 110–490 kHz and above 1000 MHz. Radiated emission limits in these three bands are based on measurements employing an average detector.</p>	Frequency (MHz)	Field strength (microvolts/meter)	Measurement distance (meters)	0.009-0.490	2400/F(kHz)	300	0.490-1.705	24000/F(kHz)	30	1.705-30.0	30	30	30-88	100 **	3	88-216	150 **	3	216-960	200 **	3	Above 960	500	3
Frequency (MHz)	Field strength (microvolts/meter)	Measurement distance (meters)																							
0.009-0.490	2400/F(kHz)	300																							
0.490-1.705	24000/F(kHz)	30																							
1.705-30.0	30	30																							
30-88	100 **	3																							
88-216	150 **	3																							
216-960	200 **	3																							
Above 960	500	3																							
<p>Test Method:</p>	<p>ANSI C63.10-2013, section 12.7.4, 12.7.6, 12.7.7</p>																								
<p>Procedure:</p>	<p>Above 1GHz:</p> <ol style="list-style-type: none"> For above 1GHz, the EUT was placed on the top of a rotating table 1.5 meters above the ground at a 3 meter fully-anechoic chamber. The table was rotated 360 degrees to determine the position of the highest radiation. The EUT was set 3 meters away from the interference-receiving antenna, which was mounted on the top of a variable-height antenna tower. The antenna height is varied from one meter to four meters above the ground to determine the maximum value of the field strength. Both horizontal and vertical polarizations of the antenna are set to make the measurement. For each suspected emission, the EUT was arranged to its worst case and then the antenna was tuned to heights from 1 meter to 4 meters (for the test frequency of below 30MHz, the antenna was tuned to heights 1 meter) and the rotatable table was turned from 0 degrees to 360 degrees to find the maximum reading. The test-receiver system was set to Peak Detect Function and Specified Bandwidth with Maximum Hold Mode. If the emission level of the EUT in peak mode was 10dB lower than the limit specified, then testing could be stopped and the peak values of the EUT would be reported. Otherwise the emissions that did not have 10dB margin would be re-tested one by one using peak or average method as specified and then reported in a data sheet. Test the EUT in the lowest channel, the middle channel, the Highest channel. The radiation measurements are performed in X, Y, Z axis positioning for Transmitting mode, and found the X axis positioning which it is the worst case. Repeat above procedures until all frequencies measured was complete. <p>Remark:</p> <ol style="list-style-type: none"> Level= Read Level+ Cable Loss+ Antenna Factor- Preamp Factor Scan from 18GHz to 40GHz, the disturbance above 18GHz was very low. The points marked on above plots are the highest emissions could be found when testing, so only above points had been displayed. The amplitude of spurious emissions from the radiator which are attenuated more than 20dB below the limit need not be reported. 																								

3. As shown in this section, for frequencies above 1GHz, the field strength limits are based on average limits. However, the peak field strength of any emission shall not exceed the maximum permitted average limits specified above by more than 20 dB under any condition of modulation. For the emissions whose peak level is lower than the average limit, only the peak measurement is shown in the report.

4. The disturbance above 18GHz were very low and the harmonics were the highest point could be found when testing, so only the above harmonics had been displayed.

3.11.1. E.U.T. Operation:

Operating Environment:	
Temperature:	23.3 °C
Humidity:	44.4 %
Atmospheric Pressure:	101 kPa
Final test mode:	Test Mode1, Test Mode2

3.11.2. Test Setup Diagram:

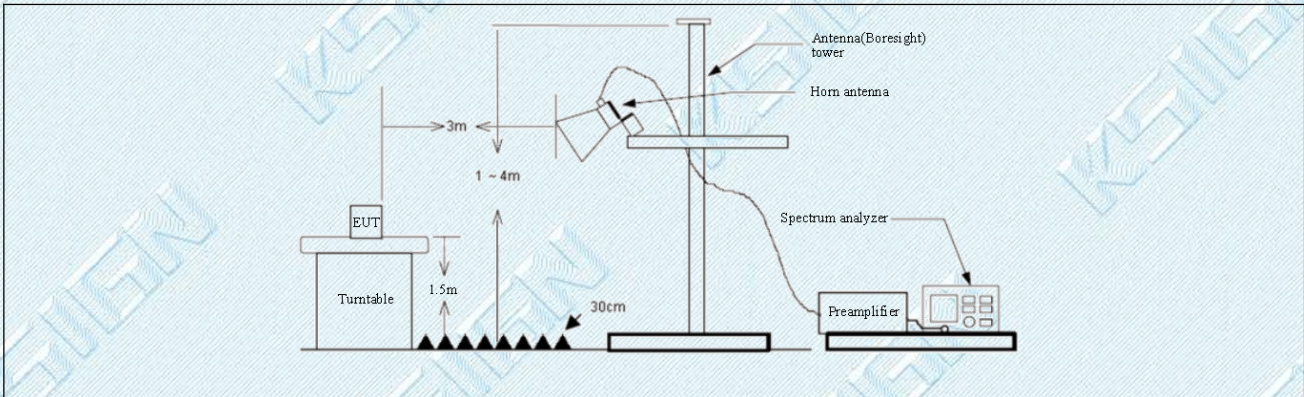

3.11.3. Test Data:

Test Mode1 / Polarization: Horizontal / Band: 5150-5250 MHz / BW: 20 / CH: L

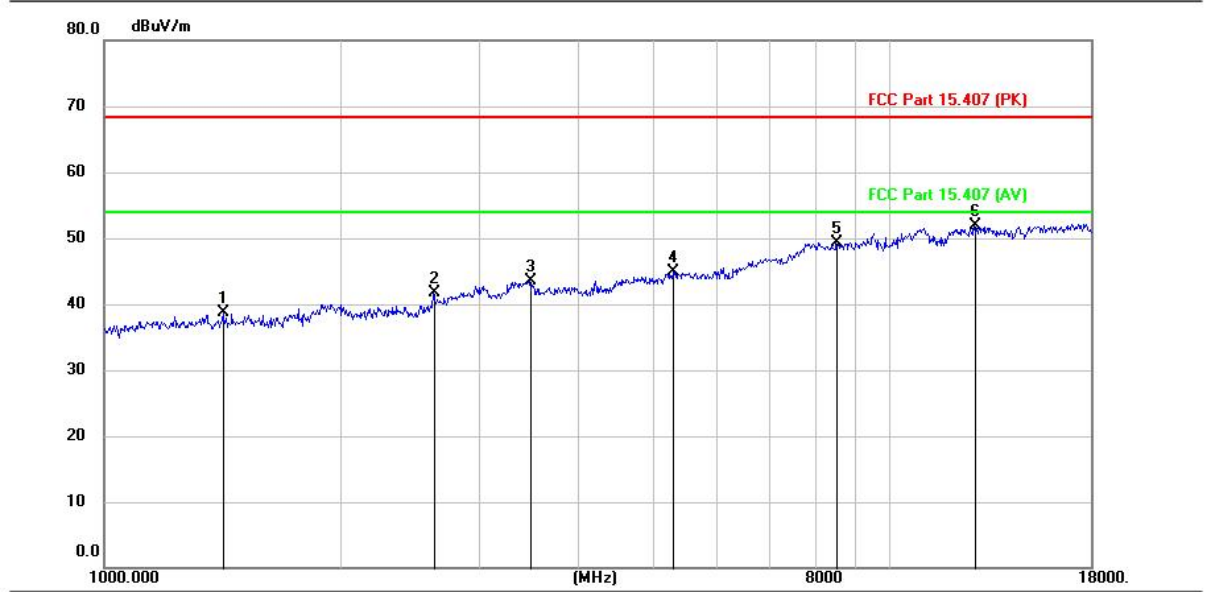

No.	Mk.	Freq. MHz	Reading Level (dBuV)	Correct Factor (dB/m)	Measurement (dBuV/m)	Limit (dBuV/m)	Over (dB)	Detector
1		1416.500	40.13	-1.39	38.74	68.20	-29.46	peak
2		2630.300	40.75	0.93	41.68	68.20	-26.52	peak
3		3480.300	41.95	1.49	43.44	68.20	-24.76	peak
4		5297.600	40.81	4.12	44.93	68.20	-23.27	peak
5		8520.800	39.06	10.19	49.25	68.20	-18.95	peak
6	*	12821.800	37.21	14.62	51.83	68.20	-16.37	peak

Test Mode1 / Polarization: Vertical / Band: 5150-5250 MHz / BW: 20 / CH: L

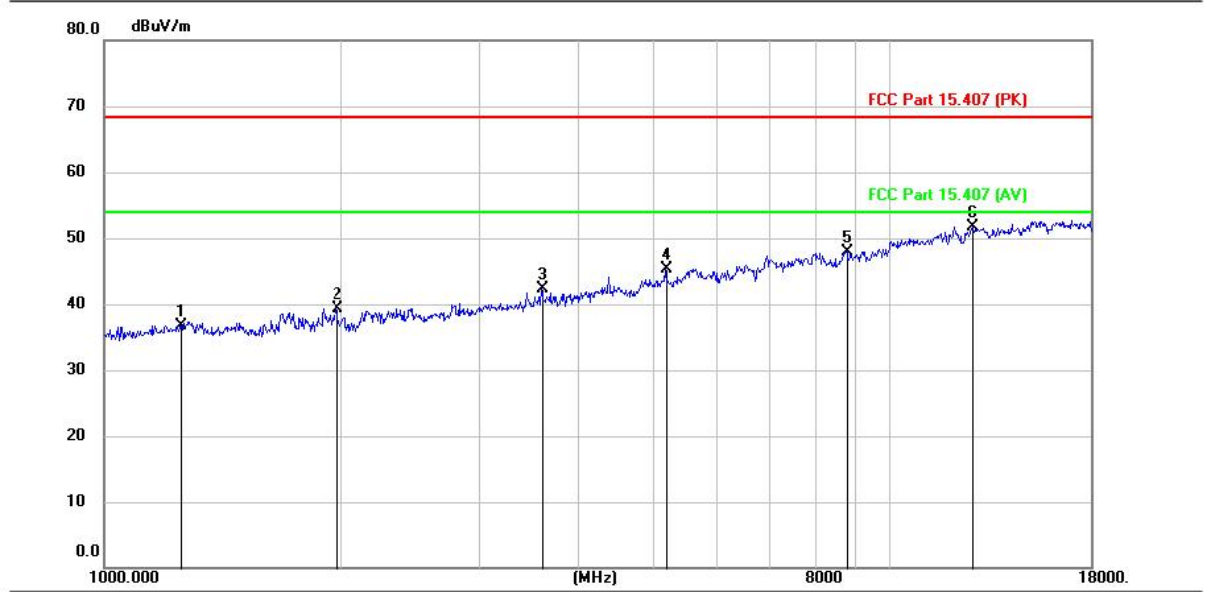

No.	Mk.	Freq. MHz	Reading Level (dBuV)	Correct Factor (dB/m)	Measurement (dBuV/m)	Limit (dBuV/m)	Over (dB)	Detector
1		1251.600	38.22	-1.48	36.74	68.20	-31.46	peak
2		1977.500	39.84	-0.45	39.39	68.20	-28.81	peak
3		3606.100	40.39	1.85	42.24	68.20	-25.96	peak
4		5180.300	41.08	4.30	45.38	68.20	-22.82	peak
5		8797.900	37.61	10.35	47.96	68.20	-20.24	peak
6	*	12735.100	37.46	14.30	51.76	68.20	-16.44	peak

TRF No. RF_R1

Add: West Side of 1/F., Building C, Zone A, Fuyuan New Factory, Jiujiu Industrial Park, Minzhu, Shatou, Shajing, Bao'an District, Shenzhen, Guangdong, China

Tel: +(86) 0755-2985 2678 Fax: +(86) 0755-2985 2397 E-mail: info@gdkesign.cn Web: www.gdkesign.com

Test Mode1 / Polarization: Horizontal / Band: 5150-5250 MHz / BW: 20 / CH: M

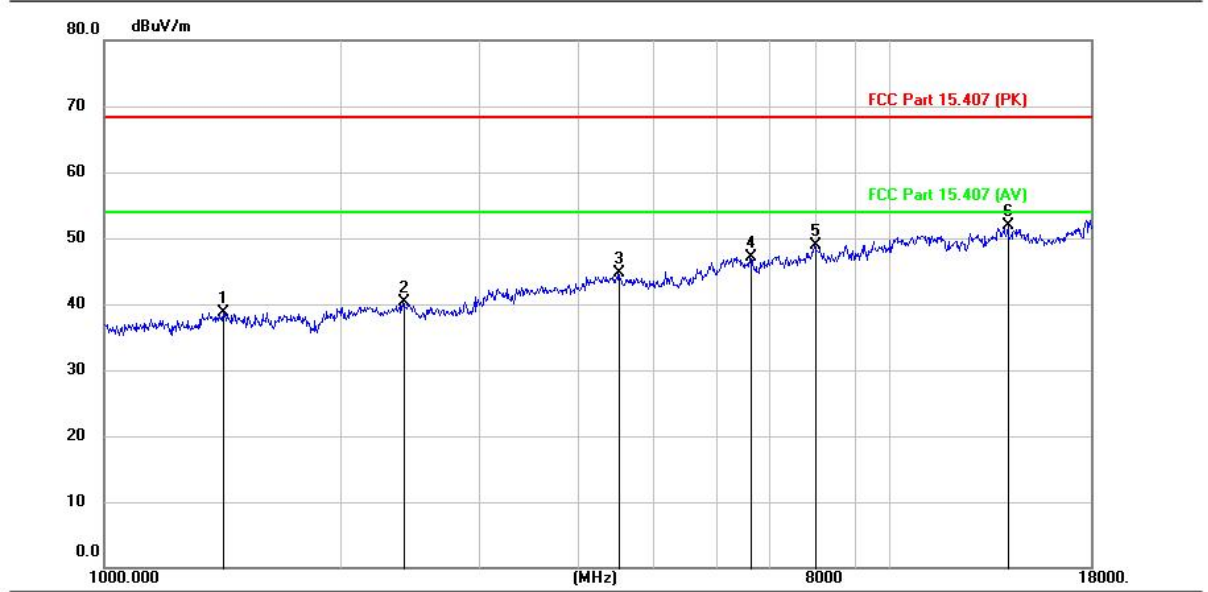

No.	Mk.	Freq. MHz	Reading Level (dBuV)	Correct Factor (dB/m)	Measurement (dBuV/m)	Limit (dBuV/m)	Over (dB)	Detector
1		1418.200	40.08	-1.37	38.71	68.20	-29.49	peak
2		2400.800	39.51	0.89	40.40	68.20	-27.80	peak
3		4512.200	41.29	3.33	44.62	68.20	-23.58	peak
4		6623.600	39.41	7.77	47.18	68.20	-21.02	peak
5		8004.000	37.88	11.09	48.97	68.20	-19.23	peak
6	*	14144.400	34.91	16.96	51.87	68.20	-16.33	peak

TRF No. RF_R1

Add: West Side of 1/F., Building C, Zone A, Fuyuan New Factory, Jiujiu Industrial Park, Minzhu, Shatou, Shajing, Bao'an District, Shenzhen, Guangdong, China

Tel: +(86) 0755-2985 2678 Fax: +(86) 0755-2985 2397 E-mail: info@gdkesign.cn Web: www.gdkesign.com

Test Mode1 / Polarization: Vertical / Band: 5150-5250 MHz / BW: 20 / CH: M

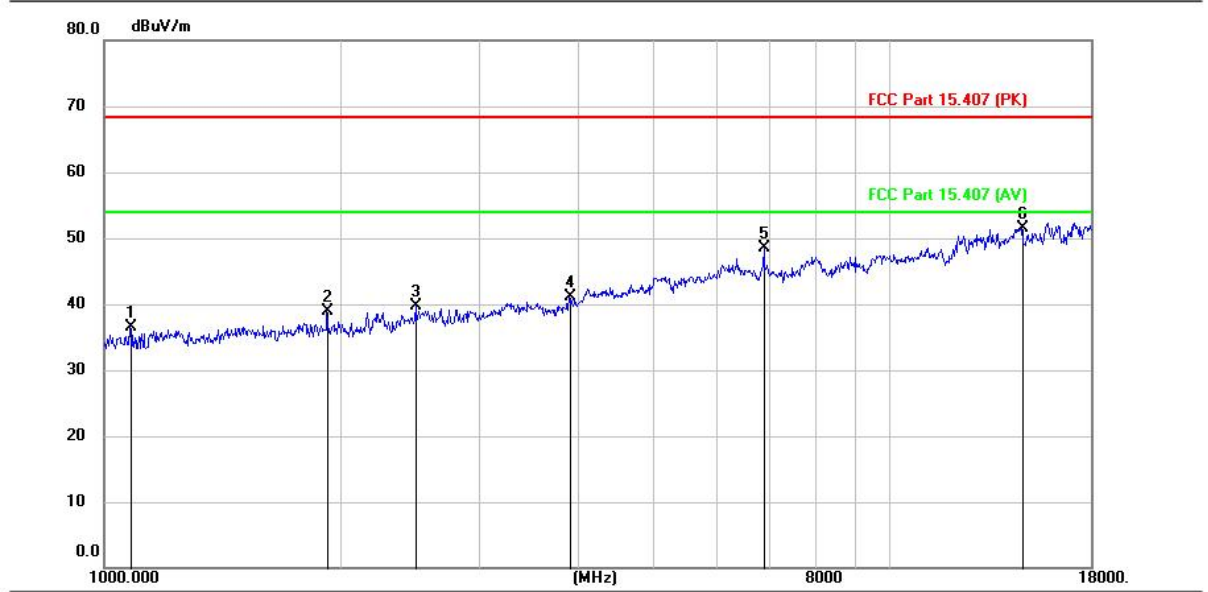

No. Mk.	Freq. MHz	Reading Level (dBuV)	Correct Factor (dB/m)	Measurement (dBuV/m)	Limit (dBuV/m)	Over (dB)	Detector
1	1079.900	39.10	-2.62	36.48	68.20	-31.72	peak
2	1916.300	39.53	-0.71	38.82	68.20	-29.38	peak
3	2496.000	39.18	0.62	39.80	68.20	-28.40	peak
4	3901.900	38.75	2.32	41.07	68.20	-27.13	peak
5	6905.800	39.59	8.98	48.57	68.20	-19.63	peak
6 *	14730.900	34.23	17.35	51.58	68.20	-16.62	peak

TRF No. RF_R1

Add: West Side of 1/F., Building C, Zone A, Fuyuan New Factory, Jiujiu Industrial Park, Minzhu, Shatou, Shajing, Bao'an District, Shenzhen, Guangdong, China

Tel: +(86) 0755-2985 2678 Fax: +(86) 0755-2985 2397 E-mail: info@gdkesign.cn Web: www.gdkesign.com

Test Mode1 / Polarization: Horizontal / Band: 5150-5250 MHz / BW: 20 / CH: H

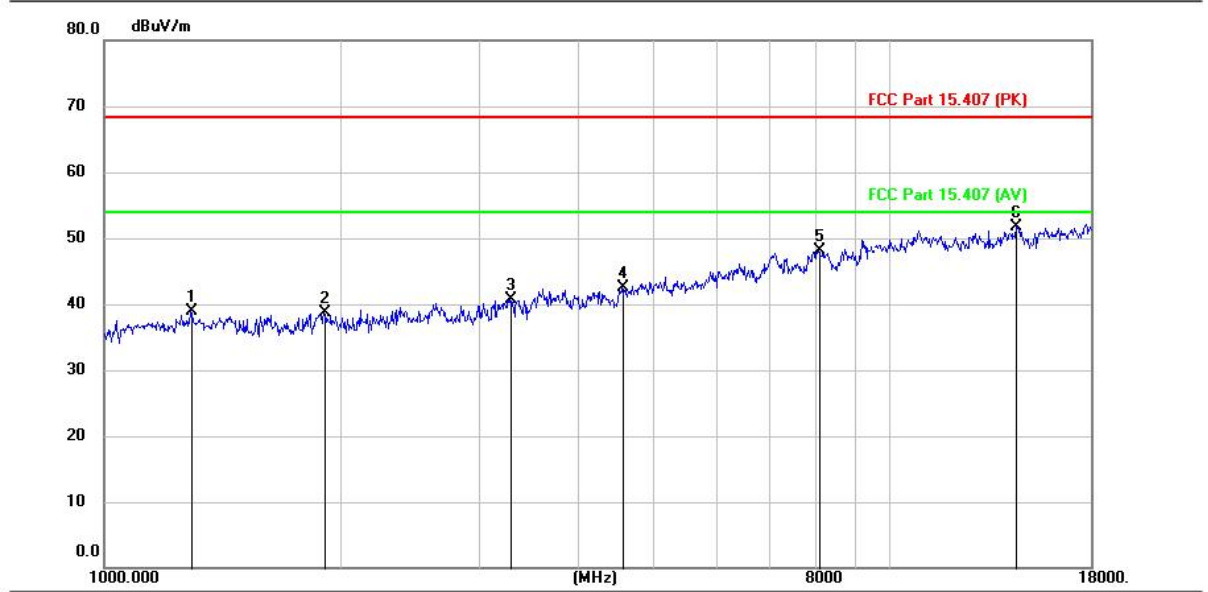

No. Mk.	Freq. MHz	Reading Level (dBuV)	Correct Factor (dB/m)	Measurement (dBuV/m)	Limit (dBuV/m)	Over (dB)	Detector
1	1289.000	40.21	-1.37	38.84	68.20	-29.36	peak
2	1904.400	39.39	-0.71	38.68	68.20	-29.52	peak
3	3283.100	39.62	1.07	40.69	68.20	-27.51	peak
4	4568.300	39.08	3.35	42.43	68.20	-25.77	peak
5	8106.000	37.24	10.89	48.13	68.20	-20.07	peak
6 *	14487.800	34.26	17.48	51.74	68.20	-16.46	peak

TRF No. RF_R1

Add: West Side of 1/F., Building C, Zone A, Fuyuan New Factory, Jiujiu Industrial Park, Minzhu, Shatou, Shajing, Bao'an District, Shenzhen, Guangdong, China

Tel: +(86) 0755-2985 2678 Fax: +(86) 0755-2985 2397 E-mail: info@gdkesign.cn Web: www.gdkesign.com

Test Mode1 / Polarization: Vertical / Band: 5150-5250 MHz / BW: 20 / CH: H

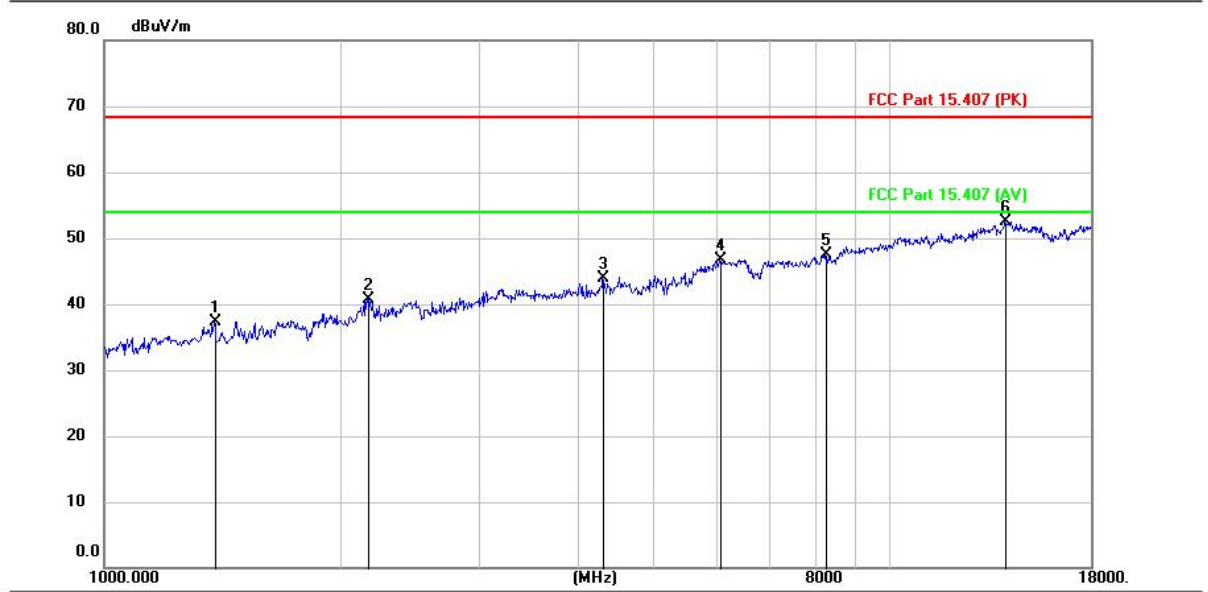

No.	Mk.	Freq. MHz	Reading Level (dBuV)	Correct Factor (dB/m)	Measurement (dBuV/m)	Limit (dBuV/m)	Over (dB)	Detector
1		1379.100	38.57	-1.23	37.34	68.20	-30.86	peak
2		2167.900	39.75	1.03	40.78	68.20	-27.42	peak
3		4304.800	40.95	3.00	43.95	68.20	-24.25	peak
4		6071.100	40.60	6.13	46.73	68.20	-21.47	peak
5		8257.300	37.17	10.35	47.52	68.20	-20.68	peak
6	*	14020.300	36.09	16.47	52.56	68.20	-15.64	peak

TRF No. RF_R1

Add: West Side of 1/F., Building C, Zone A, Fuyuan New Factory, Jiujiu Industrial Park, Minzhu, Shatou, Shajing, Bao'an District, Shenzhen, Guangdong, China

Tel: +(86) 0755-2985 2678 Fax: +(86) 0755-2985 2397 E-mail: info@gdkesign.cn Web: www.gdkesign.com

Test Mode1 / Polarization: Horizontal / Band: 5250-5350 MHz / BW: 20 / CH: L

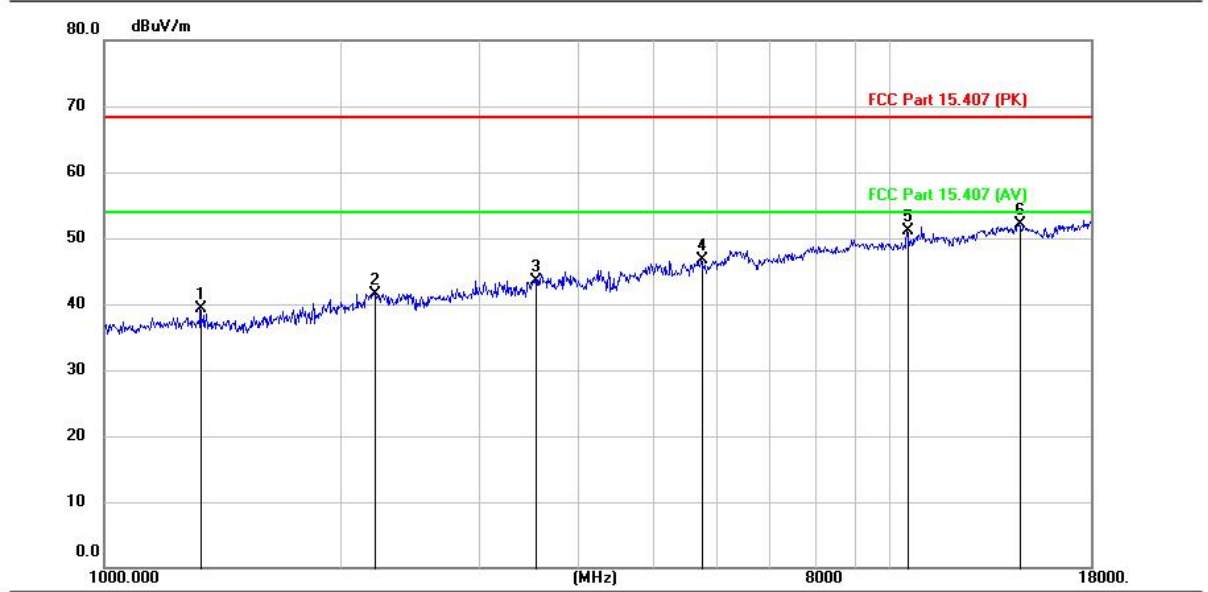

No.	Mk.	Freq. MHz	Reading Level (dBuV)	Correct Factor (dB/m)	Measurement (dBuV/m)	Limit (dBuV/m)	Over (dB)	Detector
1		1326.400	40.44	-1.14	39.30	68.20	-28.90	peak
2		2208.700	40.13	1.45	41.58	68.20	-26.62	peak
3		3541.500	41.97	1.60	43.57	68.20	-24.63	peak
4		5749.800	41.74	4.96	46.70	68.20	-21.50	peak
5		10520.000	38.07	12.98	51.05	68.20	-17.15	peak
6	*	14583.000	34.61	17.44	52.05	68.20	-16.15	peak

TRF No. RF_R1

Add: West Side of 1/F., Building C, Zone A, Fuyuan New Factory, Jiujiu Industrial Park, Minzhu, Shatou, Shajing, Bao'an District, Shenzhen, Guangdong, China

Tel: +(86) 0755-2985 2678 Fax: +(86) 0755-2985 2397 E-mail: info@gdkesign.cn Web: www.gdkesign.com

Test Mode1 / Polarization: Vertical / Band: 5250-5350 MHz / BW: 20 / CH: L

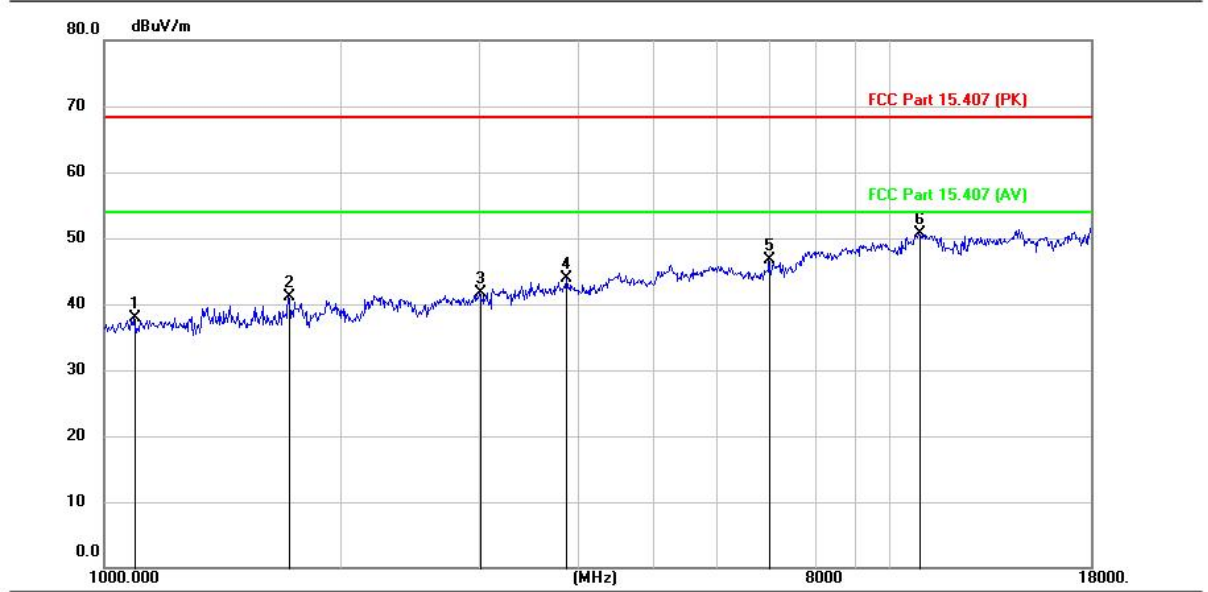

No. Mk.	Freq. MHz	Reading Level (dBuV)	Correct Factor (dB/m)	Measurement (dBuV/m)	Limit (dBuV/m)	Over (dB)	Detector
1	1091.800	40.47	-2.58	37.89	68.20	-30.31	peak
2	1715.700	42.79	-1.60	41.19	68.20	-27.01	peak
3	3012.800	40.19	1.42	41.61	68.20	-26.59	peak
4	3878.100	41.70	2.30	44.00	68.20	-24.20	peak
5	7012.900	37.23	9.48	46.71	68.20	-21.49	peak
6 *	10895.700	36.96	13.67	50.63	68.20	-17.57	peak

TRF No. RF_R1

Add: West Side of 1/F., Building C, Zone A, Fuyuan New Factory, Jiujiu Industrial Park, Minzhu, Shatou, Shajing, Bao'an District, Shenzhen, Guangdong, China

Tel: +(86) 0755-2985 2678 Fax: +(86) 0755-2985 2397 E-mail: info@gdkesign.cn Web: www.gdkesign.com

Test Mode1 / Polarization: Horizontal / Band: 5250-5350 MHz / BW: 20 / CH: M

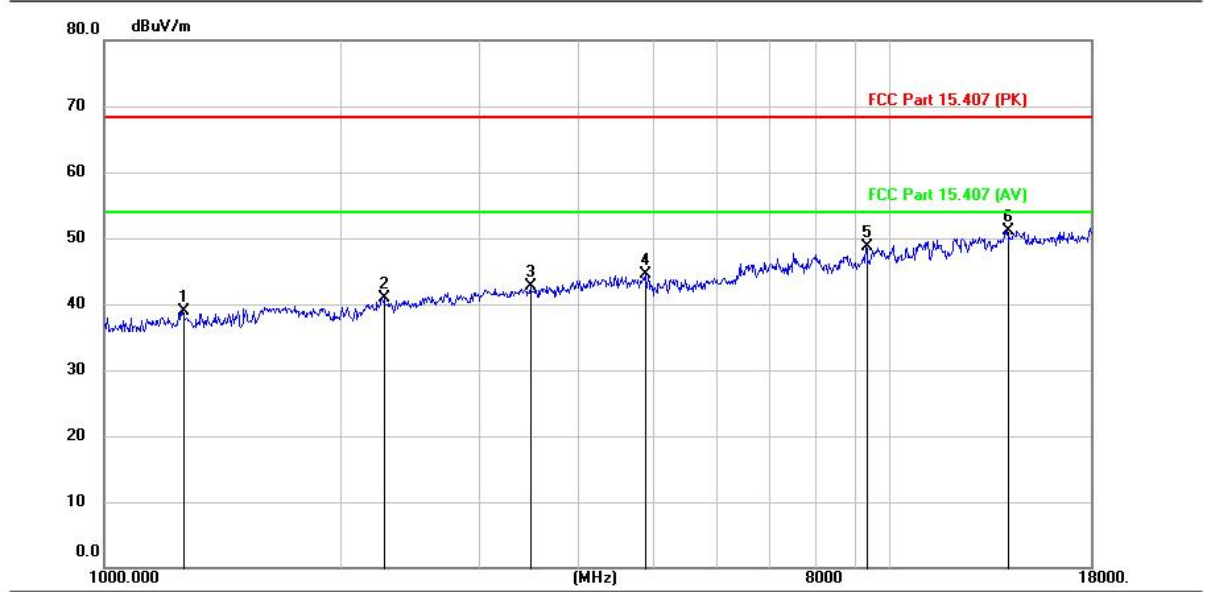

No.	Mk.	Freq. MHz	Reading Level (dBuV)	Correct Factor (dB/m)	Measurement (dBuV/m)	Limit (dBuV/m)	Over (dB)	Detector
1		1258.400	40.29	-1.46	38.83	68.20	-29.37	peak
2		2275.000	39.69	1.24	40.93	68.20	-27.27	peak
3		3493.900	41.08	1.54	42.62	68.20	-25.58	peak
4		4874.300	40.43	4.00	44.43	68.20	-23.77	peak
5		9292.600	37.37	11.30	48.67	68.20	-19.53	peak
6	*	14079.800	34.44	16.70	51.14	68.20	-17.06	peak

TRF No. RF_R1

Add: West Side of 1/F., Building C, Zone A, Fuyuan New Factory, Jiujiu Industrial Park, Minzhu, Shatou, Shajing, Bao'an District, Shenzhen, Guangdong, China

Tel: +(86) 0755-2985 2678 Fax: +(86) 0755-2985 2397 E-mail: info@gdkesign.cn Web: www.gdkesign.com

Test Mode1 / Polarization: Vertical / Band: 5250-5350 MHz / BW: 20 / CH: M

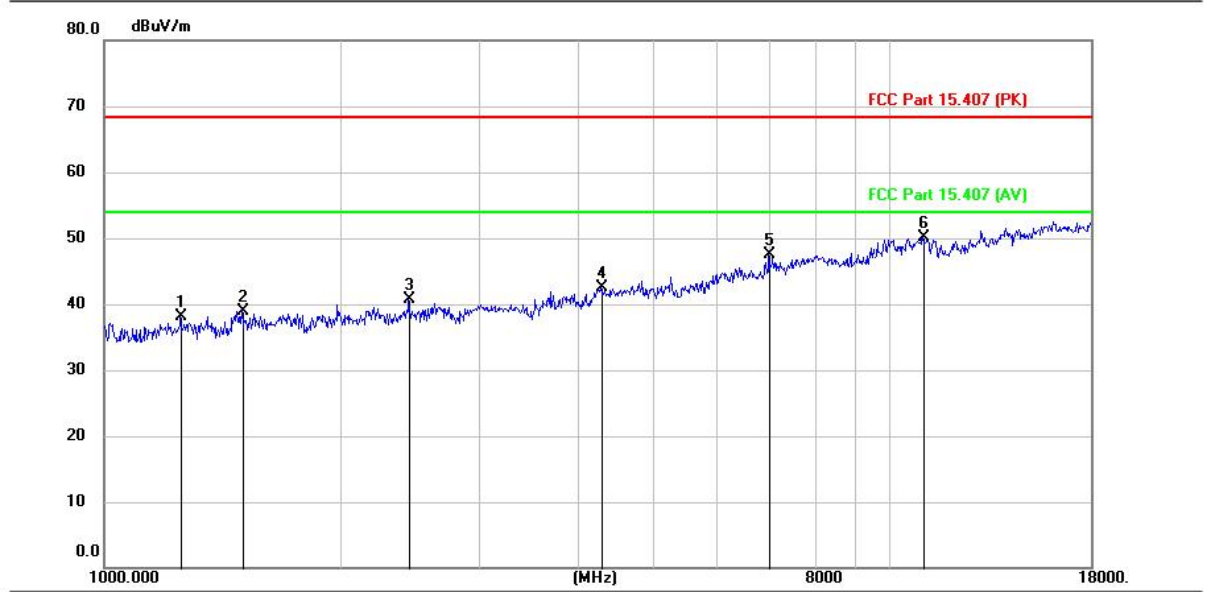

No. Mk.	Freq. MHz	Reading Level (dBuV)	Correct Factor (dB/m)	Measurement (dBuV/m)	Limit (dBuV/m)	Over (dB)	Detector
1	1251.600	39.66	-1.48	38.18	68.20	-30.02	peak
2	1498.100	40.38	-1.38	39.00	68.20	-29.20	peak
3	2448.400	39.93	0.85	40.78	68.20	-27.42	peak
4	4282.700	39.61	2.97	42.58	68.20	-25.62	peak
5	7012.900	38.01	9.48	47.49	68.20	-20.71	peak
6 *	11028.300	36.20	13.84	50.04	68.20	-18.16	peak

TRF No. RF_R1

Add: West Side of 1/F., Building C, Zone A, Fuyuan New Factory, Jiujiu Industrial Park, Minzhu, Shatou, Shajing, Bao'an District, Shenzhen, Guangdong, China

Tel: +(86) 0755-2985 2678 Fax: +(86) 0755-2985 2397 E-mail: info@gdkesign.cn Web: www.gdkesign.com

Test Mode1 / Polarization: Horizontal / Band: 5250-5350 MHz / BW: 20 / CH: H

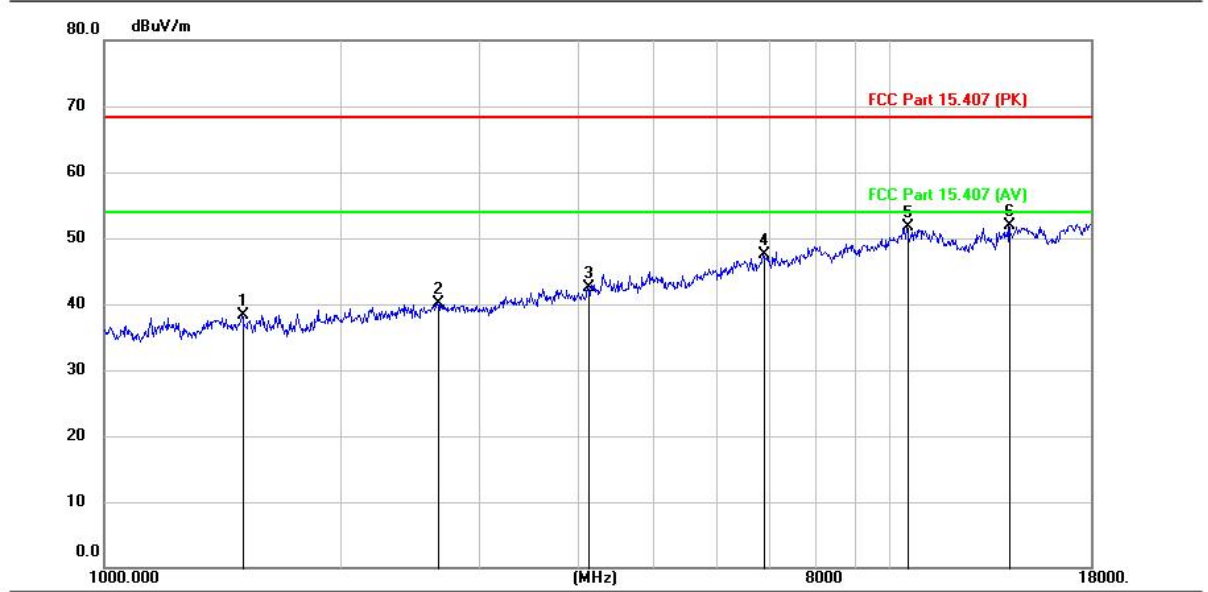

No.	Mk.	Freq. MHz	Reading Level (dBuV)	Correct Factor (dB/m)	Measurement (dBuV/m)	Limit (dBuV/m)	Over (dB)	Detector
1		1496.400	39.64	-1.37	38.27	68.20	-29.93	peak
2		2662.600	39.13	1.04	40.17	68.20	-28.03	peak
3		4133.100	39.80	2.62	42.42	68.20	-25.78	peak
4		6883.700	38.53	8.88	47.41	68.20	-20.79	peak
5		10520.000	38.67	12.98	51.65	68.20	-16.55	peak
6	*	14173.300	34.87	17.08	51.95	68.20	-16.25	peak

TRF No. RF_R1

Add: West Side of 1/F., Building C, Zone A, Fuyuan New Factory, Jiujiu Industrial Park, Minzhu, Shatou, Shajing, Bao'an District, Shenzhen, Guangdong, China

Tel: +(86) 0755-2985 2678 Fax: +(86) 0755-2985 2397 E-mail: info@gdkesign.cn Web: www.gdkesign.com

Test Mode1 / Polarization: Vertical / Band: 5250-5350 MHz / BW: 20 / CH: H

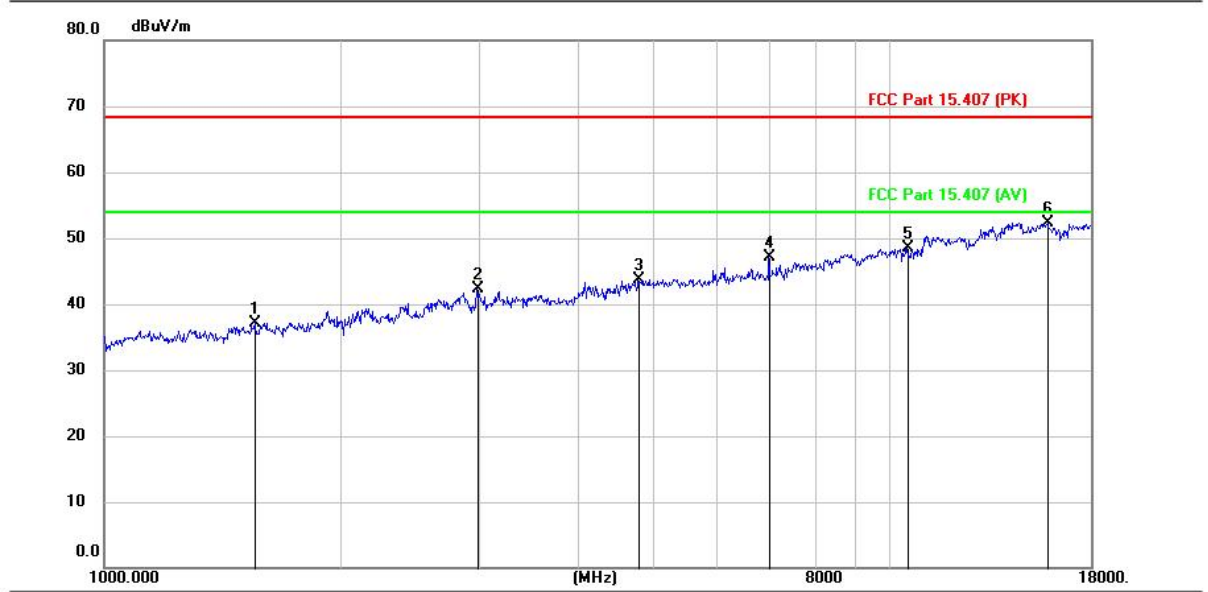

No.	Mk.	Freq. MHz	Reading Level (dBuV)	Correct Factor (dB/m)	Measurement (dBuV/m)	Limit (dBuV/m)	Over (dB)	Detector
1		1554.200	38.65	-1.47	37.18	68.20	-31.02	peak
2		2989.000	40.88	1.41	42.29	68.20	-25.91	peak
3		4785.900	39.76	3.92	43.68	68.20	-24.52	peak
4		7012.900	37.68	9.48	47.16	68.20	-21.04	peak
5		10516.600	35.55	12.98	48.53	68.20	-19.67	peak
6	*	15873.300	38.57	13.73	52.30	68.20	-15.90	peak

TRF No. RF_R1

Add: West Side of 1/F., Building C, Zone A, Fuyuan New Factory, Jiujiu Industrial Park, Minzhu, Shatou, Shajing, Bao'an District, Shenzhen, Guangdong, China

Tel: +(86) 0755-2985 2678 Fax: +(86) 0755-2985 2397 E-mail: info@gdkesign.cn Web: www.gdkesign.com

Test Mode1 / Polarization: Horizontal / Band: 5470-5725 MHz / BW: 20 / CH: L

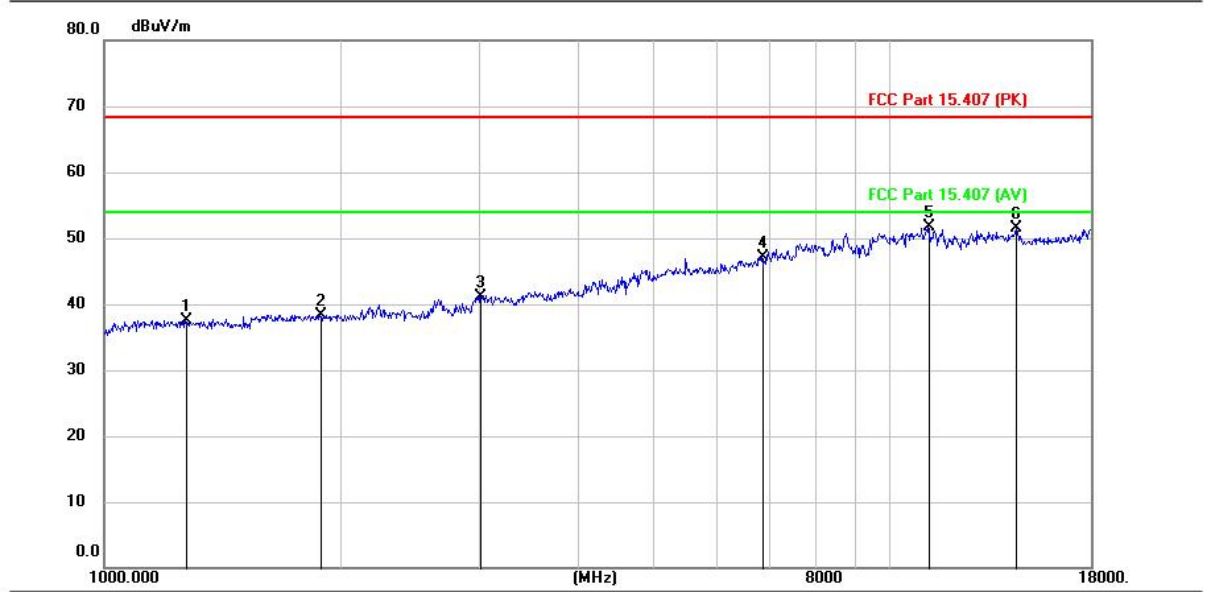

No.	Mk.	Freq. MHz	Reading Level (dBuV)	Correct Factor (dB/m)	Measurement (dBuV/m)	Limit (dBuV/m)	Over (dB)	Detector
1		1268.600	38.99	-1.43	37.56	68.20	-30.64	peak
2		1882.300	39.24	-0.86	38.38	68.20	-29.82	peak
3		3009.400	39.73	1.43	41.16	68.20	-27.04	peak
4		6868.400	38.35	8.82	47.17	68.20	-21.03	peak
5	*	11183.000	38.09	13.54	51.63	68.20	-16.57	peak
6		14481.000	33.95	17.49	51.44	68.20	-16.76	peak

TRF No. RF_R1

Add: West Side of 1/F., Building C, Zone A, Fuyuan New Factory, Jiujiu Industrial Park, Minzhu, Shatou, Shajing, Bao'an District, Shenzhen, Guangdong, China

Tel: +(86) 0755-2985 2678 Fax: +(86) 0755-2985 2397 E-mail: info@gdkesign.cn Web: www.gdkesign.com

Test Mode1 / Polarization: Vertical / Band: 5470-5725 MHz / BW: 20 / CH: L

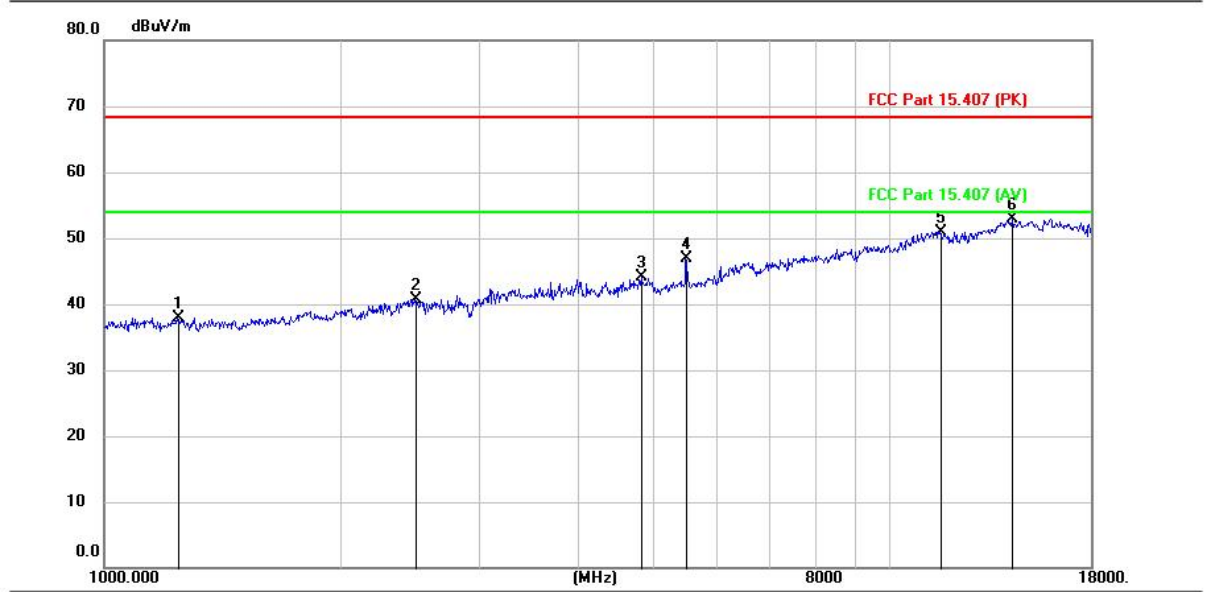

No.	Mk.	Freq. MHz	Reading Level (dBuV)	Correct Factor (dB/m)	Measurement (dBuV/m)	Limit (dBuV/m)	Over (dB)	Detector
1		1241.400	39.48	-1.59	37.89	68.20	-30.31	peak
2		2492.600	40.02	0.64	40.66	68.20	-27.54	peak
3		4821.600	40.12	4.06	44.18	68.20	-24.02	peak
4		5501.600	42.44	4.40	46.84	68.20	-21.36	peak
5		11580.800	37.12	13.84	50.96	68.20	-17.24	peak
6	*	14299.100	35.71	17.28	52.99	68.20	-15.21	peak

Test Mode1 / Polarization: Horizontal / Band: 5470-5725 MHz / BW: 20 / CH: M

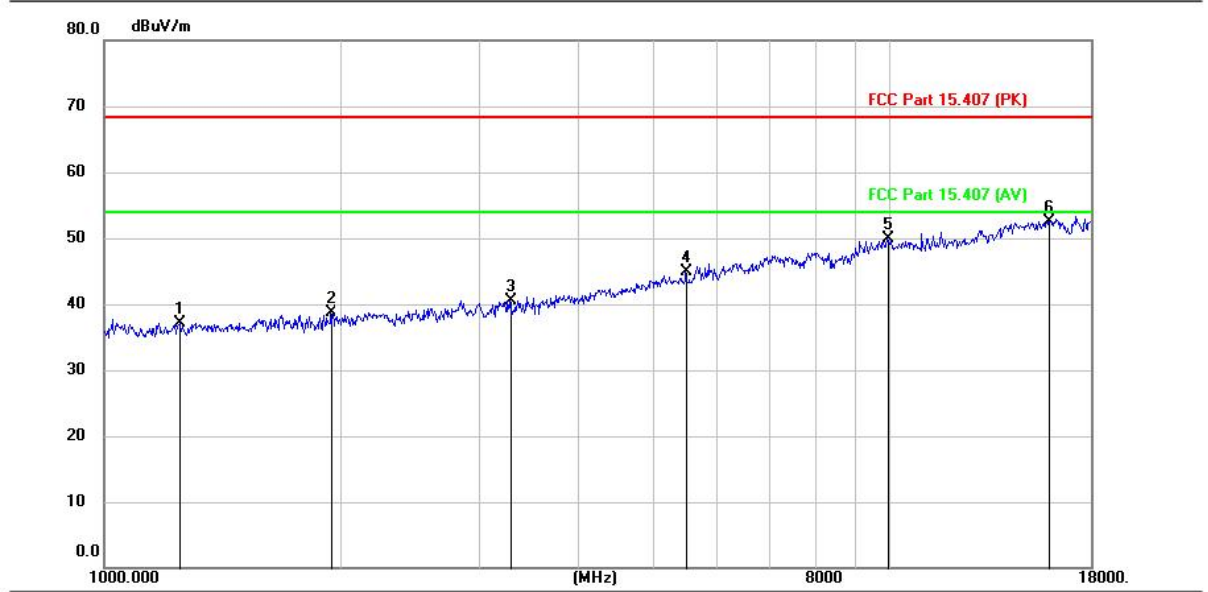

No.	Mk.	Freq. MHz	Reading Level (dBuV)	Correct Factor (dB/m)	Measurement (dBuV/m)	Limit (dBuV/m)	Over (dB)	Detector
1		1246.500	38.61	-1.53	37.08	68.20	-31.12	peak
2		1943.500	39.40	-0.69	38.71	68.20	-29.49	peak
3		3281.400	39.51	1.09	40.60	68.20	-27.60	peak
4		5501.600	40.41	4.40	44.81	68.20	-23.39	peak
5		9931.800	37.87	11.99	49.86	68.20	-18.34	peak
6	*	15915.800	38.78	13.80	52.58	68.20	-15.62	peak

TRF No. RF_R1

Add: West Side of 1/F., Building C, Zone A, Fuyuan New Factory, Jiujiu Industrial Park, Minzhu, Shatou, Shajing, Bao'an District, Shenzhen, Guangdong, China

Tel: +(86) 0755-2985 2678 Fax: +(86) 0755-2985 2397 E-mail: info@gdkesign.cn Web: www.gdkesign.com

Test Mode1 / Polarization: Vertical / Band: 5470-5725 MHz / BW: 20 / CH: M

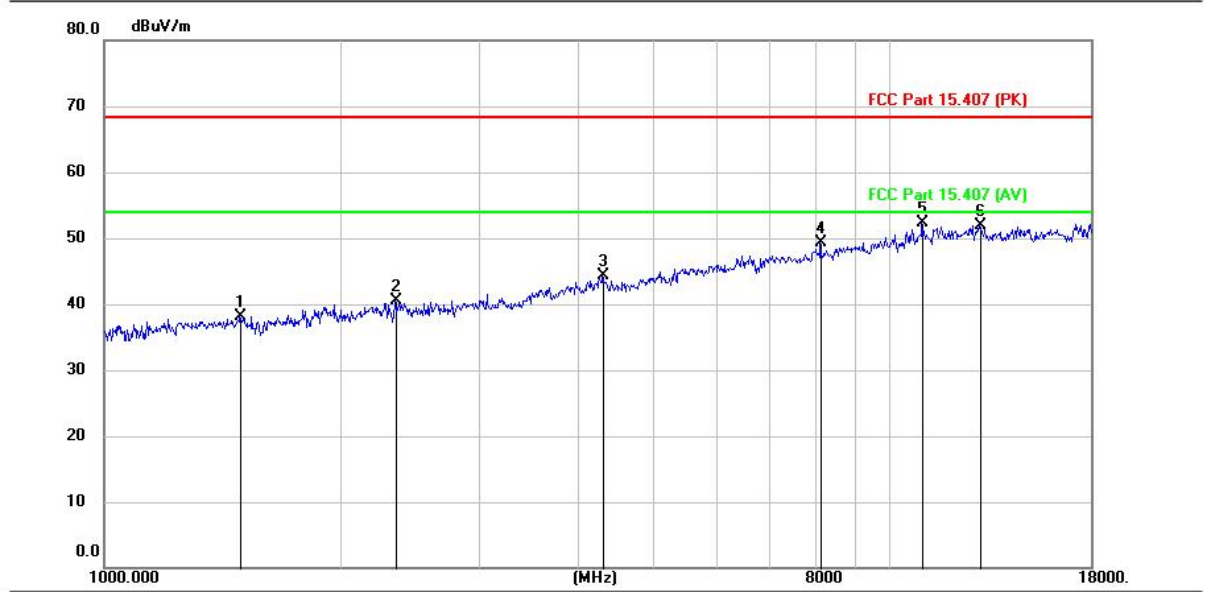

No.	Mk.	Freq. MHz	Reading Level (dBuV)	Correct Factor (dB/m)	Measurement (dBuV/m)	Limit (dBuV/m)	Over (dB)	Detector
1		1489.600	39.38	-1.36	38.02	68.20	-30.18	peak
2		2351.500	39.53	0.91	40.44	68.20	-27.76	peak
3		4304.800	41.21	3.00	44.21	68.20	-23.99	peak
4		8129.800	38.46	10.92	49.38	68.20	-18.82	peak
5	*	11004.500	38.37	13.92	52.29	68.20	-15.91	peak
6		13002.000	36.22	15.67	51.89	68.20	-16.31	peak

TRF No. RF_R1

Add: West Side of 1/F., Building C, Zone A, Fuyuan New Factory, Jiujiu Industrial Park, Minzhu, Shatou, Shajing, Bao'an District, Shenzhen, Guangdong, China

Tel: +(86) 0755-2985 2678 Fax: +(86) 0755-2985 2397 E-mail: info@gdkesign.cn Web: www.gdkesign.com

Test Mode1 / Polarization: Horizontal / Band: 5470-5725 MHz / BW: 20 / CH: H

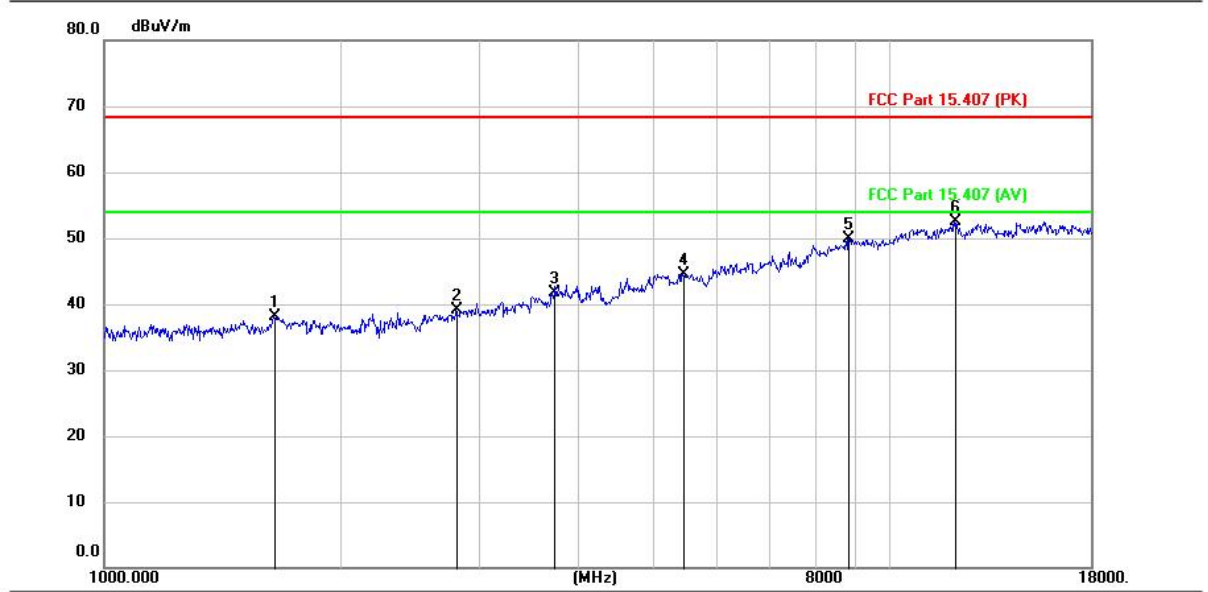

No.	Mk.	Freq. MHz	Reading Level (dBuV)	Correct Factor (dB/m)	Measurement (dBuV/m)	Limit (dBuV/m)	Over (dB)	Detector
1		1640.900	39.75	-1.71	38.04	68.20	-30.16	peak
2		2810.500	37.80	1.36	39.16	68.20	-29.04	peak
3		3740.400	39.81	1.87	41.68	68.20	-26.52	peak
4		5454.000	40.05	4.43	44.48	68.20	-23.72	peak
5		8821.700	39.44	10.38	49.82	68.20	-18.38	peak
6	*	12104.400	39.18	13.35	52.53	68.20	-15.67	peak

TRF No. RF_R1

Add: West Side of 1/F., Building C, Zone A, Fuyuan New Factory, Jiujiu Industrial Park, Minzhu, Shatou, Shajing, Bao'an District, Shenzhen, Guangdong, China

Tel: +(86) 0755-2985 2678 Fax: +(86) 0755-2985 2397 E-mail: info@gdkesign.cn Web: www.gdkesign.com

Test Mode1 / Polarization: Vertical / Band: 5470-5725 MHz / BW: 20 / CH: H

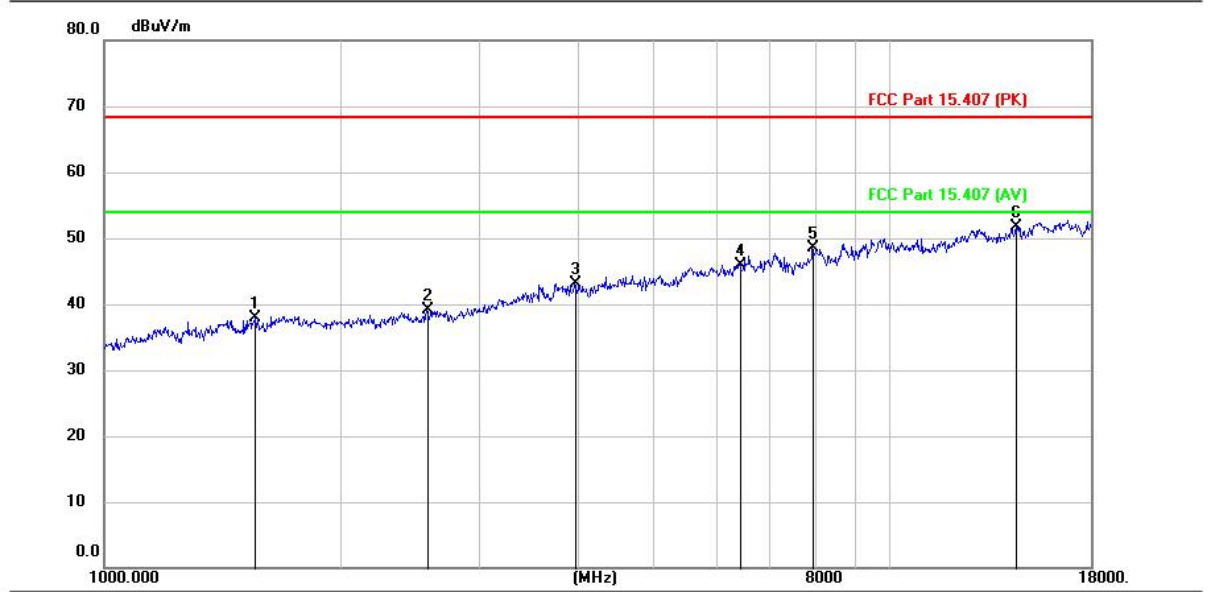

No.	Mk.	Freq. MHz	Reading Level (dBuV)	Correct Factor (dB/m)	Measurement (dBuV/m)	Limit (dBuV/m)	Over (dB)	Detector
1		1554.200	39.37	-1.47	37.90	68.20	-30.30	peak
2		2579.300	38.28	0.86	39.14	68.20	-29.06	peak
3		3973.300	40.60	2.50	43.10	68.20	-25.10	peak
4		6448.500	38.77	7.20	45.97	68.20	-22.23	peak
5		7963.200	37.32	11.16	48.48	68.20	-19.72	peak
6	*	14475.900	34.18	17.50	51.68	68.20	-16.52	peak

TRF No. RF_R1

Add: West Side of 1/F., Building C, Zone A, Fuyuan New Factory, Jiujiu Industrial Park, Minzhu, Shatou, Shajing, Bao'an District, Shenzhen, Guangdong, China

Tel: +(86) 0755-2985 2678 Fax: +(86) 0755-2985 2397 E-mail: info@gdkesign.cn Web: www.gdkesign.com

Test Mode1 / Polarization: Horizontal / Band: 5725-5850 MHz / BW: 20 / CH: L

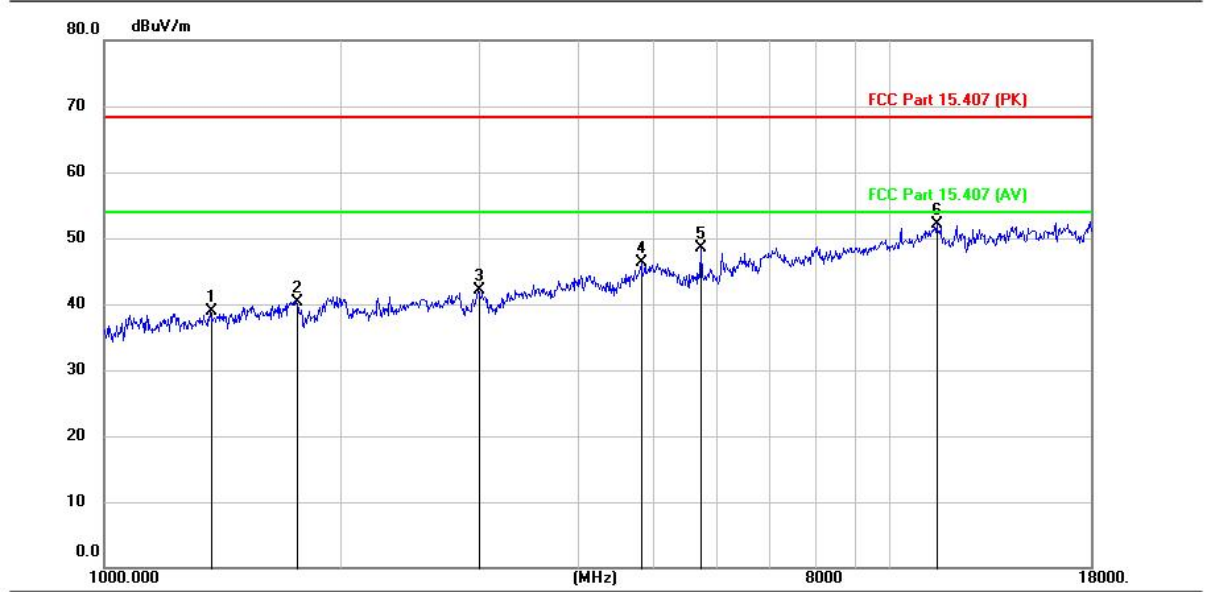

No.	Mk.	Freq. MHz	Reading Level (dBuV)	Correct Factor (dB/m)	Measurement (dBuV/m)	Limit (dBuV/m)	Over (dB)	Detector
1		1363.800	40.01	-1.10	38.91	68.20	-29.29	peak
2		1753.100	41.87	-1.47	40.40	68.20	-27.80	peak
3		2994.100	40.77	1.43	42.20	68.20	-26.00	peak
4		4826.700	42.30	4.08	46.38	68.20	-21.82	peak
5		5744.700	43.59	4.94	48.53	68.20	-19.67	peak
6	*	11489.000	38.53	13.62	52.15	68.20	-16.05	peak

TRF No. RF_R1

Add: West Side of 1/F., Building C, Zone A, Fuyuan New Factory, Jiujiu Industrial Park, Minzhu, Shatou, Shajing, Bao'an District, Shenzhen, Guangdong, China

Tel: +(86) 0755-2985 2678 Fax: +(86) 0755-2985 2397 E-mail: info@gdkesign.cn Web: www.gdkesign.com

Test Mode1 / Polarization: Vertical / Band: 5725-5850 MHz / BW: 20 / CH: L

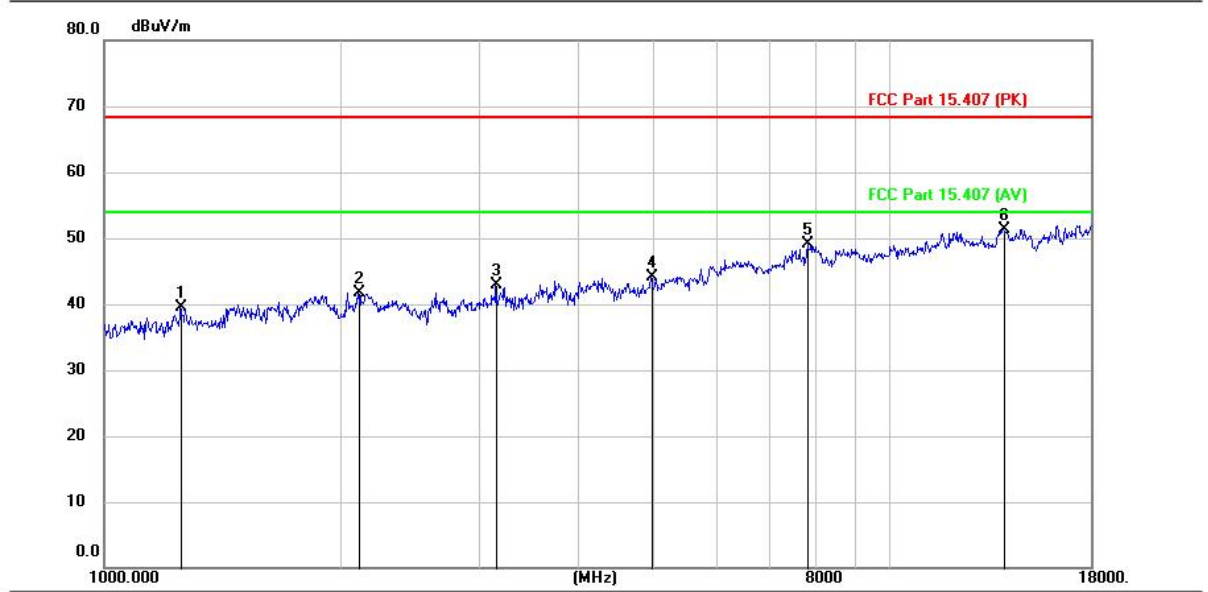

No.	Mk.	Freq. MHz	Reading Level (dBuV)	Correct Factor (dB/m)	Measurement (dBuV/m)	Limit (dBuV/m)	Over (dB)	Detector
1		1249.900	40.92	-1.48	39.44	68.20	-28.76	peak
2		2111.800	41.16	0.56	41.72	68.20	-26.48	peak
3		3153.900	41.33	1.50	42.83	68.20	-25.37	peak
4		4969.500	39.82	4.28	44.10	68.20	-24.10	peak
5		7845.900	38.53	10.67	49.20	68.20	-19.00	peak
6	*	13935.300	35.34	16.05	51.39	68.20	-16.81	peak

TRF No. RF_R1

Add: West Side of 1/F., Building C, Zone A, Fuyuan New Factory, Jiujiu Industrial Park, Minzhu, Shatou, Shajing, Bao'an District, Shenzhen, Guangdong, China

Tel: +(86) 0755-2985 2678 Fax: +(86) 0755-2985 2397 E-mail: info@gdkesign.cn Web: www.gdkesign.com

Test Mode1 / Polarization: Horizontal / Band: 5725-5850 MHz / BW: 20 / CH: M

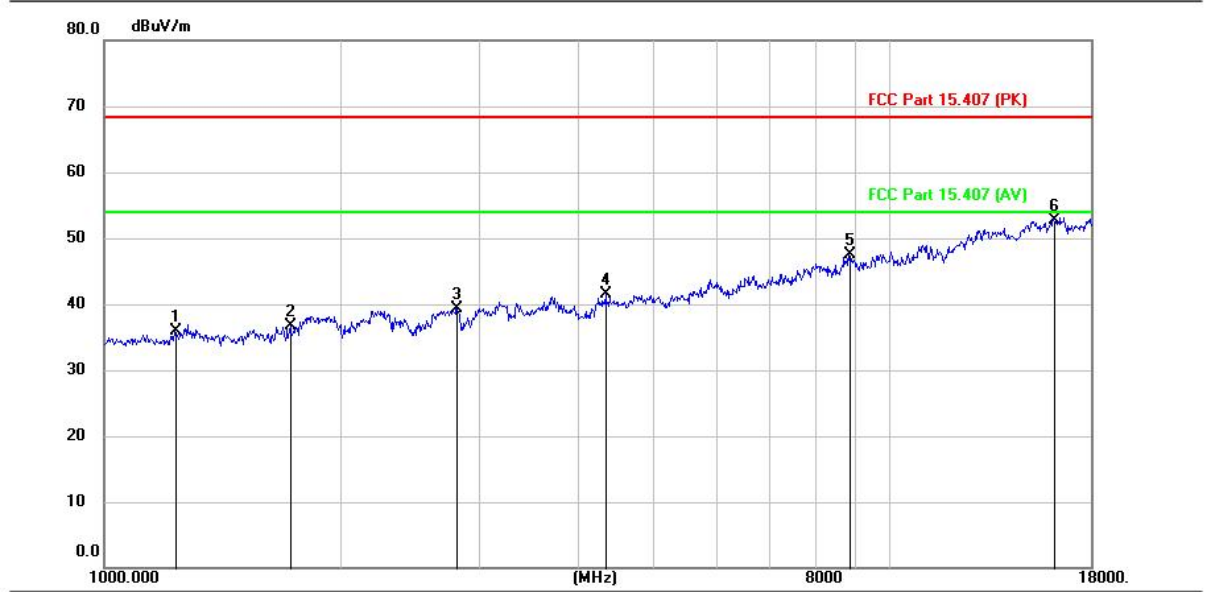

No.	Mk.	Freq. MHz	Reading Level (dBuV)	Correct Factor (dB/m)	Measurement (dBuV/m)	Limit (dBuV/m)	Over (dB)	Detector
1		1229.500	37.54	-1.72	35.82	68.20	-32.38	peak
2		1724.200	38.26	-1.56	36.70	68.20	-31.50	peak
3		2808.800	37.86	1.38	39.24	68.20	-28.96	peak
4		4350.700	38.87	2.69	41.56	68.20	-26.64	peak
5		8843.800	37.13	10.42	47.55	68.20	-20.65	peak
6	*	16136.800	38.54	14.26	52.80	68.20	-15.40	peak

TRF No. RF_R1

Add: West Side of 1/F., Building C, Zone A, Fuyuan New Factory, Jiujiu Industrial Park, Minzhu, Shatou, Shajing, Bao'an District, Shenzhen, Guangdong, China

Tel: +(86) 0755-2985 2678 Fax: +(86) 0755-2985 2397 E-mail: info@gdkesign.cn Web: www.gdkesign.com

Test Mode1 / Polarization: Vertical / Band: 5725-5850 MHz / BW: 20 / CH: M

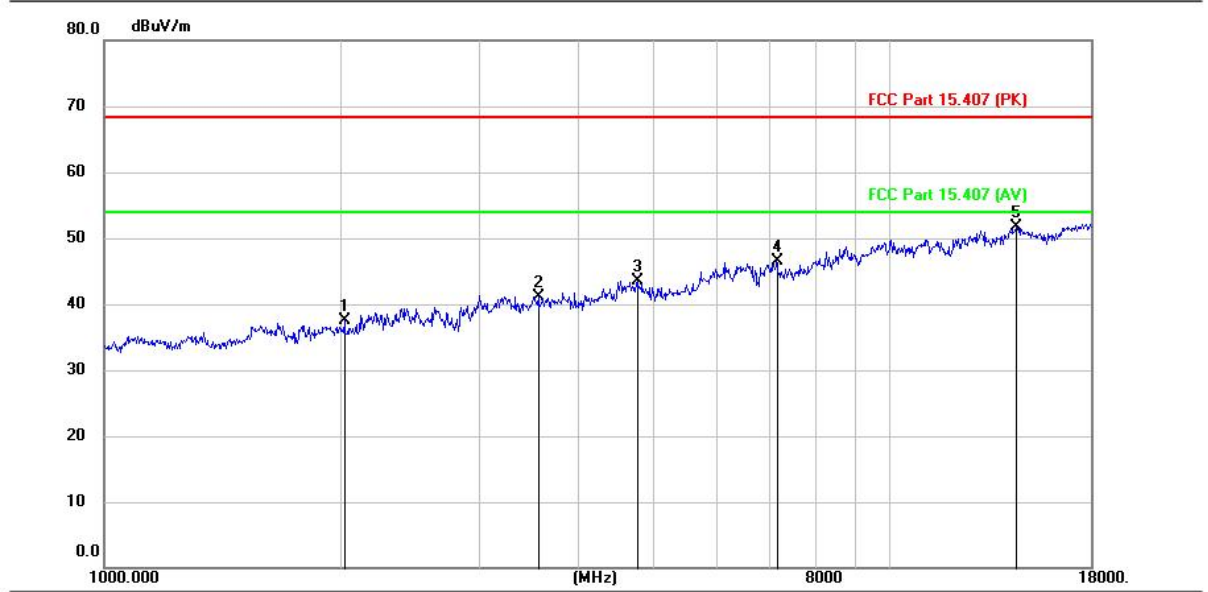

No.	Mk.	Freq. MHz	Reading Level (dBuV)	Correct Factor (dB/m)	Measurement (dBuV/m)	Limit (dBuV/m)	Over (dB)	Detector
1		2026.800	37.75	-0.27	37.48	68.20	-30.72	peak
2		3573.800	39.44	1.74	41.18	68.20	-27.02	peak
3		4775.700	39.61	3.87	43.48	68.20	-24.72	peak
4		7160.800	36.41	10.02	46.43	68.20	-21.77	peak
5	*	14472.500	34.23	17.50	51.73	68.20	-16.47	peak

TRF No. RF_R1

Add: West Side of 1/F., Building C, Zone A, Fuyuan New Factory, Jiujiu Industrial Park, Minzhu, Shatou, Shajing, Bao'an District, Shenzhen, Guangdong, China

Tel: +(86) 0755-2985 2678 Fax: +(86) 0755-2985 2397 E-mail: info@gdkesign.cn Web: www.gdkesign.com

Test Mode1 / Polarization: Horizontal / Band: 5725-5850 MHz / BW: 20 / CH: H

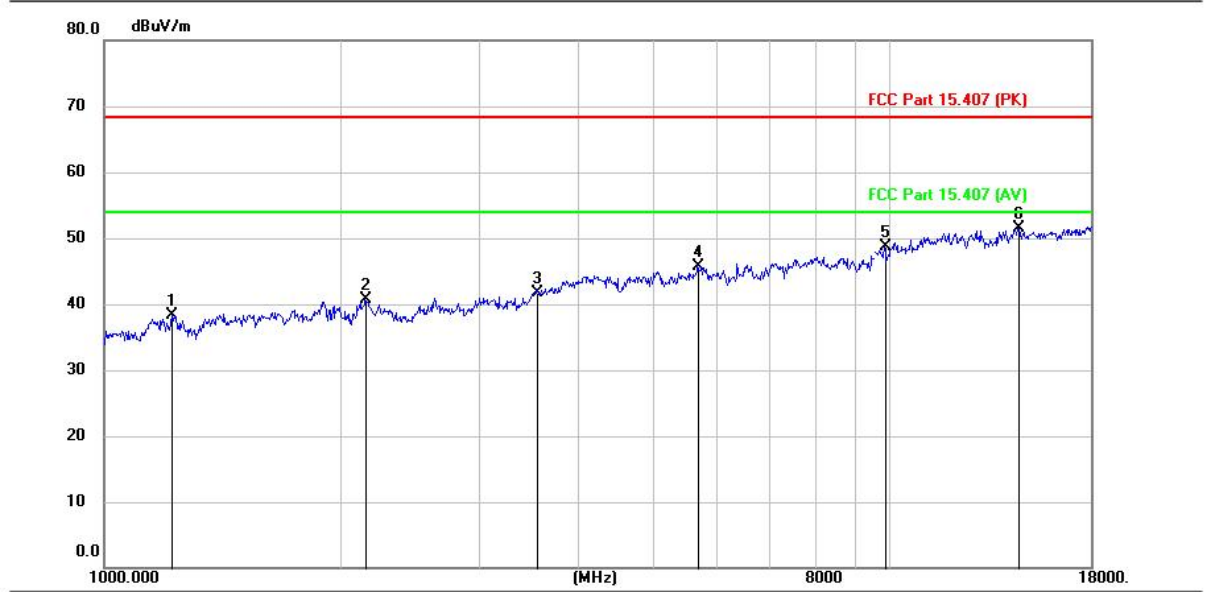

No.	Mk.	Freq. MHz	Reading Level (dBuV)	Correct Factor (dB/m)	Measurement (dBuV/m)	Limit (dBuV/m)	Over (dB)	Detector
1		1217.600	40.14	-1.84	38.30	68.20	-29.90	peak
2		2152.600	39.91	0.82	40.73	68.20	-27.47	peak
3		3555.100	40.17	1.63	41.80	68.20	-26.40	peak
4		5695.400	41.06	4.74	45.80	68.20	-22.40	peak
5		9858.700	36.47	12.15	48.62	68.20	-19.58	peak
6	*	14542.200	34.03	17.46	51.49	68.20	-16.71	peak

TRF No. RF_R1

Add: West Side of 1/F., Building C, Zone A, Fuyuan New Factory, Jiujiu Industrial Park, Minzhu, Shatou, Shajing, Bao'an District, Shenzhen, Guangdong, China

Tel: +(86) 0755-2985 2678 Fax: +(86) 0755-2985 2397 E-mail: info@gdkesign.cn Web: www.gdkesign.com

Test Mode1 / Polarization: Vertical / Band: 5725-5850 MHz / BW: 20 / CH: H



No.	Mk.	Freq. MHz	Reading Level (dBuV)	Correct Factor (dB/m)	Measurement (dBuV/m)	Limit (dBuV/m)	Over (dB)	Detector
1		1421.600	39.60	-1.37	38.23	68.20	-29.97	peak
2		1921.400	38.95	-0.70	38.25	68.20	-29.95	peak
3		2747.600	38.58	1.31	39.89	68.20	-28.31	peak
4		4134.800	40.46	2.61	43.07	68.20	-25.13	peak
5		9617.300	37.71	11.44	49.15	68.20	-19.05	peak
6	*	13100.600	36.78	15.60	52.38	68.20	-15.82	peak

Note:

- 1.Measurement = Reading level + Correct Factor
Correct Factor=Antenna Factor + Cable Loss - Preamplifier Factor
Over = Measurement -Limit
- 2.Pre-scan all mode, and found the A mode which it is worse case, so only show the test data for worse case.
3. Since the peak value is less than the limit of the AVG value, there is no AVG data.
- 4.From 18GHz to 40GHz,the amplitude of spurious emissions which are attenuated by more than 20dB below the permissible value has no need to be reported.

TRF No. RF_R1

Add: West Side of 1/F., Building C, Zone A, Fuyuan New Factory, Jiujiu Industrial Park, Minzhu, Shatou, Shajing, Bao'an District, Shenzhen, Guangdong, China

Tel: +(86) 0755-2985 2678 Fax: +(86) 0755-2985 2397 E-mail: info@gdkesign.cn Web: www.gdkesign.com

4. EUT TEST PHOTOS

Conducted Emission at AC power line



Undesirable emission limits (below 1GHz)



Undesirable emission limits (above 1GHz)



RF



5. PHOTOGRAPHS OF EUT CONSTRUCTIONAL

Refer to Appendix - EUT Photos for KD2407S2683E.

--THE END--

Important Notice

1. The results are valid only for the samples submitted.
2. The report is invalid without the "APPROVED Seal" and the "Riding Seam Seal".
3. This report is invalid without the signature of the main inspector, reviewer, or approver.
4. The testing report cannot be partially copied without the written consent of our laboratory.
5. If the report is not stamped with the "CMA" logo, it indicates that the report does not have any social certification effect in China.
6. Product information, customer information, and sample sources are all provided by the client, and we are not responsible for their authenticity.
7. The inspection basis or inspection items marked with "★" are not within the scope of CNAS, CMA and A2LA accreditation in this laboratory.
8. Reports that are transferred, copied, stolen, impersonated, altered, or tampered with in any media form without authorization are invalid.
9. If you have any objections to this report, you can appeal to our unit within 15 days after receiving the report. Failure to do so will not be accepted.
10. For situations where compliance decision needs to be made based on test result, such as when there are no relevant decision rules required by the regulations, standards, or technical specifications used, or when there are no relevant customer requirements, the report issued by our laboratory refer to ILAC-G8:09-2019 and CNAS-GL015:2022 using simple acceptance decision rules.

Laboratory: KSIGN(Guangdong) Testing Co., Ltd.

Address: First Floor West Side, Building C, Zone A, Fuyuan New Factory, Jiujiu Industrial Park, Minzhu Village, Shatou Community, Shajing Street, Bao'an District, Shenzhen City, Guangdong Province, P. R. China. 518104

Tel.: +(86) 0755-29852678

Fax.: +(86) 0755-29852397

E-mail: info@gdksign.cn

Web: www.gdksign.com