

TEST REPORT

Report No. : KD2303S1652E01
FCC ID : 2AZ2R-P
Applicant : Shenzhen USEER Robotics Co.,Ltd.
Address : Building 2, Fashion Brand Industrial Park, E'Bu Town, Shenzhen-Shanwei
Special Cooperation Zone, Shenzhen, Guangdong, China
Manufacturer : Shenzhen USEER Robotics Co.,Ltd.
Address : Building 2, Fashion Brand Industrial Park, E'Bu Town, Shenzhen-Shanwei
Special Cooperation Zone, Shenzhen, Guangdong, China
Product Name : Robotic Vacuum Cleaner
Trademark : USEER, OKP, Lefant, PETGUGU
Model/Type reference : P1S, P*, P**, P***, C5S, C*, C**, C***(*=9-0 or A-Z)
Standard : 47 CFR Part 15.247
Date of Receipt : March 23, 2023
Date of Test Date : March 23, 2023 to April 6, 2023
Date of issue : April 6, 2023
Test result : **Pass**

Prepared by:
(Printed name + Signature) Pai Zheng



Approved by:
(Printed name + Signature) Sky Dong



Testing Laboratory Name .. : **KSIGN(Guangdong) Testing Co., Ltd.**

Address : West Side of 1/F., Building C, Zone A, Fuyuan New Factory, Jiujiu Industrial
Park, Minzhu, Shatou, Shajing, Bao'an District, Shenzhen, Guangdong,
China

This test report may be duplicated completely for legal use with the approval of the applicant. It should not be reproduced except in full, without the written approval of our laboratory. The client should not use it to claim product endorsement by KSIGN. The test results in the report only apply to the tested sample. The test report shall be invalid without all the signatures of testing engineers, reviewer and approver. Any objections must be raised to KSIGN within 15 days since the date when the report is received. It will not be taken into consideration beyond this limit. The test report merely corresponds to the test sample. The report is invalid if it is not stamped with the "Testing Special Stamp" and the "Riding Seam Stamp".

TABLE OF CONTENTS

Page

1. TEST SUMMARY	3
1.1. Test Standards	3
1.2. Report Version	3
1.3. Test Description.....	4
1.4. Test Facility	5
1.5. Measurement Uncertainty	5
2. GENERAL INFORMATION	6
2.1. General Description Of EUT	6
2.2. Accessory Equipment Information	6
2.3. Description of Test Modes.....	6
2.4. Measurement Instruments List.....	7
3. Evaluation Results (Evaluation)	11
3.1. Antenna requirement.....	11
4. Radio Spectrum Matter Test Results (RF)	11
4.1. Conducted Emission at AC power line.....	11
4.2. Occupied Bandwidth	14
4.3. Maximum Conducted Output Power	15
4.4. Power Spectral Density.....	17
4.5. Emissions in non-restricted frequency bands	18
4.6. Band edge emissions (Radiated).....	20
4.7. Emissions in restricted frequency bands (below 1GHz)	25
4.8. Emissions in restricted frequency bands (above 1GHz).....	28
5. EUT TEST PHOTOS.....	35
6. PHOTOGRAPHS OF EUT CONSTRUCTIONAL.....	37
Appendix	38
6.1. Appendix A: DTS Bandwidth	39
6.2. Appendix B: Occupied Channel Bandwidth	45
6.3. Appendix C: Maximum conducted output power	51
6.4. Appendix D: Maximum power spectral density	57
6.5. Appendix E: Reference level measurement.....	63
6.6. Appendix F: Band edge measurements.....	69
6.7. Appendix G: Conducted Spurious Emission	73
6.8. Appendix H: Duty Cycle	83

1. TEST SUMMARY

1.1. Test Standards

The tests were performed according to following standards:

47 CFR Part 15.247: Operation within the bands 902-928 MHz, 2400-2483.5 MHz, and 5725-5850 MHz

1.2. Report Version

Revised No.	Date of issue	Description
01	April 6, 2023	Original

1.3. Test Description

Test Item	Standard	Requirement	Result
Antenna requirement	47 CFR Part 15.247	Part 15.203	Pass
Conducted Emission at AC power line	47 CFR Part 15.247	47 CFR 15.207(a)	Pass
Occupied Bandwidth	47 CFR Part 15.247	47 CFR 15.247(a)(2)	Pass
Maximum Conducted Output Power	47 CFR Part 15.247	47 CFR 15.247(b)(3)	Pass
Power Spectral Density	47 CFR Part 15.247	47 CFR 15.247(e)	Pass
Emissions in non-restricted frequency bands	47 CFR Part 15.247	47 CFR 15.247(d)	Pass
Band edge emissions (Radiated)	47 CFR Part 15.247	47 CFR 15.247(d)	Pass
Emissions in restricted frequency bands (below 1GHz)	47 CFR Part 15.247	47 CFR 15.247(d)	Pass
Emissions in restricted frequency bands (above 1GHz)	47 CFR Part 15.247	47 CFR 15.247(d)	Pass

TRF RF_R1

Add: West Side of 1/F., Building C, Zone A, Fuyuan New Factory, Jiujiu Industrial Park, Minzhu, Shatou, Shajing, Bao'an District, Shenzhen, Guangdong, China

Tel: +(86) 0755-2985 2678 Fax: +(86) 0755-2985 2397 E-mail: info@gdksign.cn Web: www.gdksign.com

1.4. Test Facility

KSIGN(Guangdong) Testing Co., Ltd.

West Side of 1/F., Building C, Zone A, Fuyuan New Factory, Jiujiu Industrial Park, Minzhu, Shatou, Shajing, Bao'an District, Shenzhen, Guangdong, China

The test facility is recognized, certified, or accredited by the following organizations:

CNAS-Lab Code: L13261

KSIGN(Guangdong) Testing Co., Ltd. has been assessed and proved to be in Compliance with CNAS-CL01 Accreditation Criteria for Testing and Calibration Laboratories (identical to ISO/IEC17025: 2017 General Requirements) for the Competence of Testing and Calibration Laboratories.

A2LA-Lab Cert. No.: 5457.01

KSIGN(Guangdong) Testing Co., Ltd. EMC Laboratory has been accredited by A2LA for technical competence in the field of electrical testing, and proved to be in compliance with ISO/IEC 17025:2017 General Requirements for the Competence of Testing and Calibration Laboratories and any additional program requirements in the identified field of testing

ISED#: 25693 CAB identifier.: CN0096

KSIGN(Guangdong) Testing Co., Ltd. has been listed by Innovation, Science and Economic Development Canada to perform electromagnetic emission measurement.

FCC-Registration No.: 294912 Designation Number: CN1328

KSIGN(Guangdong) Testing Co., Ltd. EMC Laboratory has been listed on the US Federal Communications Commission list of test facilities recognized to perform electromagnetic emissions measurements.

1.5. Measurement Uncertainty

Test Items	Measurement Uncertainty
Conducted Emission (150k-30MHz)	± 3.34dB
Output Power, Conducted	± 1.4dB
PSD, Conducted	± 1.0dB
Spurious Emissions, Conducted	± 3.3dB
RSE (1-18GHz)	± 4.68dB
RSE (30-1000MHz)	± 5.7dB
RSE (18-40GHz)	± 5.18dB

The reported uncertainty of measurement $y \pm U$, where expended uncertainty U is based on a standard uncertainty multiplied by a coverage factor of $k=2$, providing a level of confidence of approximately 95 %.

2. GENERAL INFORMATION

2.1. General Description Of EUT

Test Sample Number:	1-1(Normal Sample), 1-2(Engineering Sample)
Product Name:	Robotic Vacuum Cleaner
Trademark:	USEER, OKP, Lefant, PETGUGU
Model / Type reference:	P1S, P1S, P*, P**, P***, C5S, C*, C**, C***(*=9-0 or A-Z)
Model Difference:	The only difference between product models is the color and appearance. Different model names are available to meet market demands. Other power supply methods, internal structures, circuits and key components are the same, and do not affect safety and electromagnetic compatibility performance.
Power Supply:	DC 14.4V from battery
Operation Frequency:	802.11b/g/n(HT20): 2412MHz to 2462MHz; 802.11n(HT40): 2422MHz to 2452MHz
Number of Channels:	802.11b/g/n(HT20): 11 Channels; 802.11n(HT40): 7 Channels
Test Channel:	CH01:2412MHz, CH06:2437MHz, CH11:2462MHz CH03:2422MHz, CH09:2452MHz
Modulation Type:	802.11b: DSSS(CCK, DQPSK, DBPSK); 802.11g: OFDM(BPSK, QPSK, 16QAM, 64QAM); 802.11n(HT20 and HT40): OFDM (BPSK, QPSK, 16QAM, 64QAM)
Antenna Type:	PCB
Antenna Gain:	1.79 dBi
Max TX Power:	21.61dBm

2.2. Accessory Equipment Information

The EUT was tested as an independent device.

2.3. Description of Test Modes

No.	Title	Description of Mode
Test Mode1	802.11b mode	Keep the EUT in 802.11b transmitting mode.
Test Mode2	802.11g mode	Keep the EUT in 802.11g transmitting mode.
Test Mode3	802.11n(HT20) mode	Keep the EUT in 802.11n(HT20) transmitting mode.
Test Mode4	802.11n(HT40) mode	Keep the EUT in 802.11n(HT40) transmitting mode.

2.4. Measurement Instruments List

Conducted Emission at AC power line				
Test Equipment	Manufacturer	Model No.	Serial No.	Cal. Until
LISN	R&S	ENV432	1326.6105.02	2024-02-17
EMI Test Receiver	R&S	ESR	102524	2024-02-17
Manual RF Switch	JS TOYO	/	MSW-01/002	2024-02-17
ISN CAT6	Schwarzbeck	CAT5 8158	227	2024-02-17
Color Signal Generator	Philips	PM5418	672926	2024-02-17
Power Absorbing Clamp	R&S	MDS-21	100925	2024-02-19

Occupied Bandwidth				
Test Equipment	Manufacturer	Model No.	Serial No.	Cal. Until
Wideband Radio Communication Tester	R&S	CMU200	115297	2024-02-17
Audio Analyzer	R&S	UPL16	100001	2024-02-17
Shielding box	Gxiong	GX-5915A	2201113	2024-02-17
High Pass Filter	COM-MW Technology Co., Ltd	ZHPF-M1.2-9G-187	09203403	2024-02-17
Band Stop Filter	COM-MW Technology Co., Ltd	ZBSF6-C820-920-188	09203401	2024-02-17
Splitter	COM-MW Technology Co., Ltd	ZPD-M1-8-2103	09203407	2024-02-17
Coaxial Cable	BEBES	A40-2.92M2.92F-4.5M	1907021	2024-02-17
Hygrothermograph	Anymetre	JB913	/	2024-02-17
Climate Chamber	Angul	AGNH80L	1903042120	2024-02-17
Spectrum Analyzer	HP	8593E	3831U02087	2024-02-17
Dual Output DC Power Supply	Agilent	E3646A	MY40009992	2024-02-17
RF Control Unit	Tonscend	JS0806-2	/	2024-02-17
Analog Signal Generator	HP	83752A	3344A00337	2024-02-17
Vector Signal Generator	Agilent	N5182A	MY50142520	2024-02-17
Wideband Radio Communication Tester	R&S	CMW500	157282	2024-02-17
Spectrum Analyzer	R&S	FSV40-N	101798	2024-02-17

Maximum Conducted Output Power				
Test Equipment	Manufacturer	Model No.	Serial No.	Cal. Until
Wideband Radio Communication Tester	R&S	CMU200	115297	2024-02-17
Audio Analyzer	R&S	UPL16	100001	2024-02-17
Shielding box	Gxiong	GX-5915A	2201113	2024-02-17
High Pass Filter	COM-MW Technology Co., Ltd	ZHPF-M1.2-9G-187	09203403	2024-02-17
Band Stop Filter	COM-MW Technology Co., Ltd	ZBSF6-C820-920-188	09203401	2024-02-17
Splitter	COM-MW Technology Co., Ltd	ZPD-M1-8-2103	09203407	2024-02-17
Coaxial Cable	BEBES	A40-2.92M2.92F-4.5M	1907021	2024-02-17

TRF RF_R1

Add: West Side of 1/F., Building C, Zone A, Fuyuan New Factory, Jiujiu Industrial Park, Minzhu, Shatou, Shajing, Bao'an District, Shenzhen, Guangdong, China

Tel: +(86) 0755-2985 2678 Fax: +(86) 0755-2985 2397 E-mail: info@gdkesign.cn Web: www.gdkesign.com

Hygrothermograph	Anymetre	JB913	/	2024-02-17
Climate Chamber	Angul	AGNH80L	1903042120	2024-02-17
Spectrum Analyzer	HP	8593E	3831U02087	2024-02-17
Dual Output DC Power Supply	Agilent	E3646A	MY40009992	2024-02-17
RF Control Unit	Tonscend	JS0806-2	/	2024-02-17
Analog Signal Generator	HP	83752A	3344A00337	2024-02-17
Vector Signal Generator	Agilent	N5182A	MY50142520	2024-02-17
Wideband Radio Communication Tester	R&S	CMW500	157282	2024-02-17
Spectrum Analyzer	R&S	FSV40-N	101798	2024-02-17

Power Spectral Density				
Test Equipment	Manufacturer	Model No.	Serial No.	Cal. Until
Wideband Radio Communication Tester	R&S	CMU200	115297	2024-02-17
Audio Analyzer	R&S	UPL16	100001	2024-02-17
Shielding box	Gxiong	GX-5915A	2201113	2024-02-17
High Pass Filter	COM-MW Technology Co., Ltd	ZHPF-M1.2-9G-187	09203403	2024-02-17
Band Stop Filter	COM-MW Technology Co., Ltd	ZBSF6-C820-920-188	09203401	2024-02-17
Splitter	COM-MW Technology Co., Ltd	ZPD-M1-8-2103	09203407	2024-02-17
Coaxial Cable	BEBES	A40-2.92M2.92F-4.5M	1907021	2024-02-17
Hygrothermograph	Anymetre	JB913	/	2024-02-17
Climate Chamber	Angul	AGNH80L	1903042120	2024-02-17
Spectrum Analyzer	HP	8593E	3831U02087	2024-02-17
Dual Output DC Power Supply	Agilent	E3646A	MY40009992	2024-02-17
RF Control Unit	Tonscend	JS0806-2	/	2024-02-17
Analog Signal Generator	HP	83752A	3344A00337	2024-02-17
Vector Signal Generator	Agilent	N5182A	MY50142520	2024-02-17
Wideband Radio Communication Tester	R&S	CMW500	157282	2024-02-17
Spectrum Analyzer	R&S	FSV40-N	101798	2024-02-17

Emissions in non-restricted frequency bands				
Test Equipment	Manufacturer	Model No.	Serial No.	Cal. Until
Wideband Radio Communication Tester	R&S	CMU200	115297	2024-02-17
Audio Analyzer	R&S	UPL16	100001	2024-02-17
Shielding box	Gxiong	GX-5915A	2201113	2024-02-17
High Pass Filter	COM-MW Technology Co., Ltd	ZHPF-M1.2-9G-187	09203403	2024-02-17
Band Stop Filter	COM-MW Technology Co., Ltd	ZBSF6-C820-920-188	09203401	2024-02-17
Splitter	COM-MW Technology Co., Ltd	ZPD-M1-8-2103	09203407	2024-02-17

TRF RF_R1

Add: West Side of 1/F., Building C, Zone A, Fuyuan New Factory, Jiujiu Industrial Park, Minzhu, Shatou, Shajing, Bao'an District, Shenzhen, Guangdong, China

Tel: +(86) 0755-2985 2678 Fax: +(86) 0755-2985 2397 E-mail: info@gdkesign.cn Web: www.gdkesign.com

Coaxial Cable	BEBES	A40-2.92M2.92F-4.5M	1907021	2024-02-17
Hygrothermograph	Anymetre	JB913	/	2024-02-17
Climate Chamber	Angul	AGNH80L	1903042120	2024-02-17
Spectrum Analyzer	HP	8593E	3831U02087	2024-02-17
Dual Output DC Power Supply	Agilent	E3646A	MY40009992	2024-02-17
RF Control Unit	Tonscend	JS0806-2	/	2024-02-17
Analog Signal Generator	HP	83752A	3344A00337	2024-02-17
Vector Signal Generator	Agilent	N5182A	MY50142520	2024-02-17
Wideband Radio Communication Tester	R&S	CMW500	157282	2024-02-17
Spectrum Analyzer	R&S	FSV40-N	101798	2024-02-17

Band edge emissions (Radiated)				
Test Equipment	Manufacturer	Model No.	Serial No.	Cal. Until
Color Signal Generator	Philips	PM5418	672926	2024-02-17
Ultra-Broadband logarithmic period Antenna	Schwarzbeck	VULB 9163	1230	2025-02-18
Pre-Amplifier	Schwarzbeck	BBV 9745	9745#129	2024-02-17
Broadcast Television Signal Generator	R&S	SFE100	141038	2024-02-17
Analog Signal Generator	Agilent	8648A	3847M00445	2024-02-17
EMI Test Receiver	R&S	ESR	102525	2024-02-17
Loop Antenna	Beijin ZHINAN	ZN30900C	18050	2024-02-19
Horn Antenna	Schwarzbeck	BBHA 9120 D	2023	2026-02-19
Pre-Amplifier	EMCI	EMC051835SE	980662	2024-02-17
Spectrum Analyzer	Keysight	N9020A	MY46471971	2024-02-17

Emissions in restricted frequency bands (below 1GHz)				
Test Equipment	Manufacturer	Model No.	Serial No.	Cal. Until
Color Signal Generator	Philips	PM5418	672926	2024-02-17
Ultra-Broadband logarithmic period Antenna	Schwarzbeck	VULB 9163	1230	2025-02-18
Pre-Amplifier	Schwarzbeck	BBV 9745	9745#129	2024-02-17
Broadcast Television Signal Generator	R&S	SFE100	141038	2024-02-17
Analog Signal Generator	Agilent	8648A	3847M00445	2024-02-17
EMI Test Receiver	R&S	ESR	102525	2024-02-17
Loop Antenna	Beijin ZHINAN	ZN30900C	18050	2024-02-19
Horn Antenna	Schwarzbeck	BBHA 9120 D	2023	2026-02-19
Pre-Amplifier	EMCI	EMC051835SE	980662	2024-02-17
Spectrum Analyzer	Keysight	N9020A	MY46471971	2024-02-17

Emissions in restricted frequency bands (above 1GHz)				
Test Equipment	Manufacturer	Model No.	Serial No.	Cal. Until

TRF RF_R1

Add: West Side of 1/F., Building C, Zone A, Fuyuan New Factory, Jiujiu Industrial Park, Minzhu, Shatou, Shajing, Bao'an District, Shenzhen, Guangdong, China

Tel: +(86) 0755-2985 2678 Fax: +(86) 0755-2985 2397 E-mail: info@gdkesign.cn Web: www.gdkesign.com

Color Signal Generator	Philips	PM5418	672926	2024-02-17
Ultra-Broadband logarithmic period Antenna	Schwarzbeck	VULB 9163	1230	2025-02-18
Pre-Amplifier	Schwarzbeck	BBV 9745	9745#129	2024-02-17
Broadcast Television Signal Generator	R&S	SFE100	141038	2024-02-17
Analog Signal Generator	Agilent	8648A	3847M00445	2024-02-17
EMI Test Receiver	R&S	ESR	102525	2024-02-17
Loop Antenna	Beijin ZHINAN	ZN30900C	18050	2024-02-19
Horn Antenna	Schwarzbeck	BBHA 9120 D	2023	2026-02-19
Pre-Amplifier	EMCI	EMC051835SE	980662	2024-02-17
Spectrum Analyzer	Keysight	N9020A	MY46471971	2024-02-17

TRF RF_R1

Add: West Side of 1/F., Building C, Zone A, Fuyuan New Factory, Jiujiu Industrial Park, Minzhu, Shatou, Shajing, Bao'an District, Shenzhen, Guangdong, China

Tel: +(86) 0755-2985 2678 Fax: +(86) 0755-2985 2397 E-mail: info@gdksign.cn Web: www.gdksign.com

3. Evaluation Results (Evaluation)

3.1. Antenna requirement

Test Requirement:	An intentional radiator shall be designed to ensure that no antenna other than that furnished by the responsible party shall be used with the device. The use of a permanently attached antenna or of an antenna that uses a unique coupling to the intentional radiator shall be considered sufficient to comply with the provisions of this section.
Conclusion:	The directional gain of the antenna less than 6dBi, please refer to the EUT internal photographs antenna photo.

4. Radio Spectrum Matter Test Results (RF)

4.1. Conducted Emission at AC power line

Test Requirement:	Except as shown in paragraphs (b) and (c) of this section, for an intentional radiator that is designed to be connected to the public utility (AC) power line, the radio frequency voltage that is conducted back onto the AC power line on any frequency or frequencies, within the band 150 kHz to 30 MHz, shall not exceed the limits in the following table, as measured using a 50 μ H/50 ohms line impedance stabilization network (LISN).		
Test Limit:	Frequency of emission (MHz)	Conducted limit (dB μ V)	
		Quasi-peak	Average
	0.15-0.5	66 to 56*	56 to 46*
	0.5-5	56	46
	5-30	60	50
	*Decreases with the logarithm of the frequency.		
Test Method:	Refer to ANSI C63.10-2013 section 6.2, standard test method for ac power-line conducted emissions from unlicensed wireless devices		

4.1.1. E.U.T. Operation:

Operating Environment:	
Temperature:	23.3 °C
Humidity:	48.3 %
Atmospheric Pressure:	102 kPa
Final test mode:	Test Mode1

4.1.2. Test Setup Diagram:

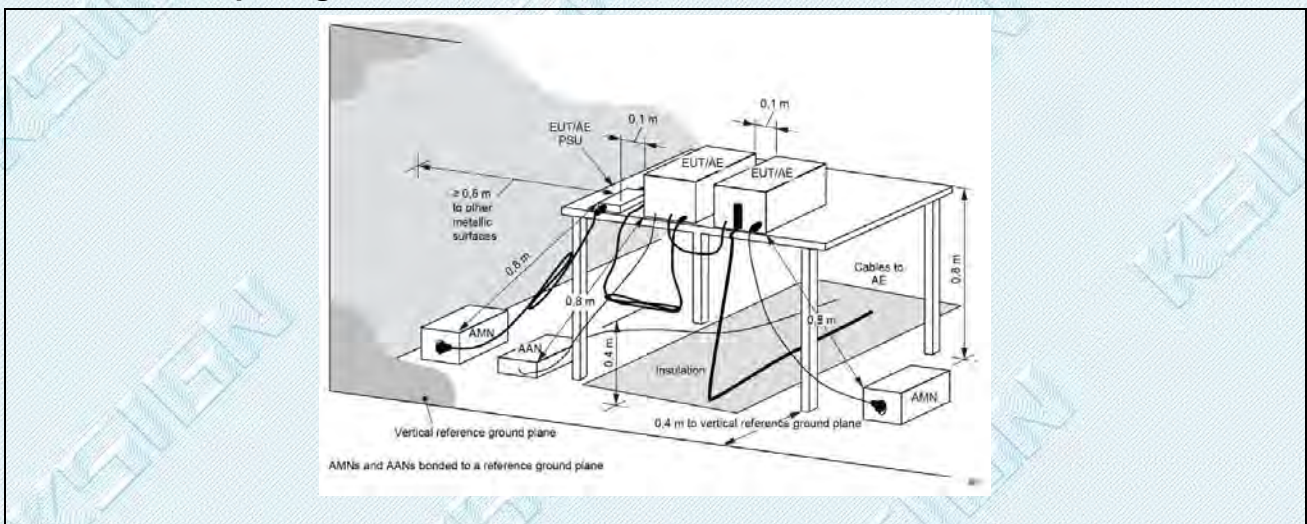

TRF_RF_R1

Add: West Side of 1/F., Building C, Zone A, Fuyuan New Factory, Jiujiu Industrial Park, Minzhu, Shatou, Shajing, Bao'an District, Shenzhen, Guangdong, China

Tel: +(86) 0755-2985 2678 Fax: +(86) 0755-2985 2397 E-mail: info@gdkesign.cn Web: www.gdkesign.com

4.1.3. Test Data:

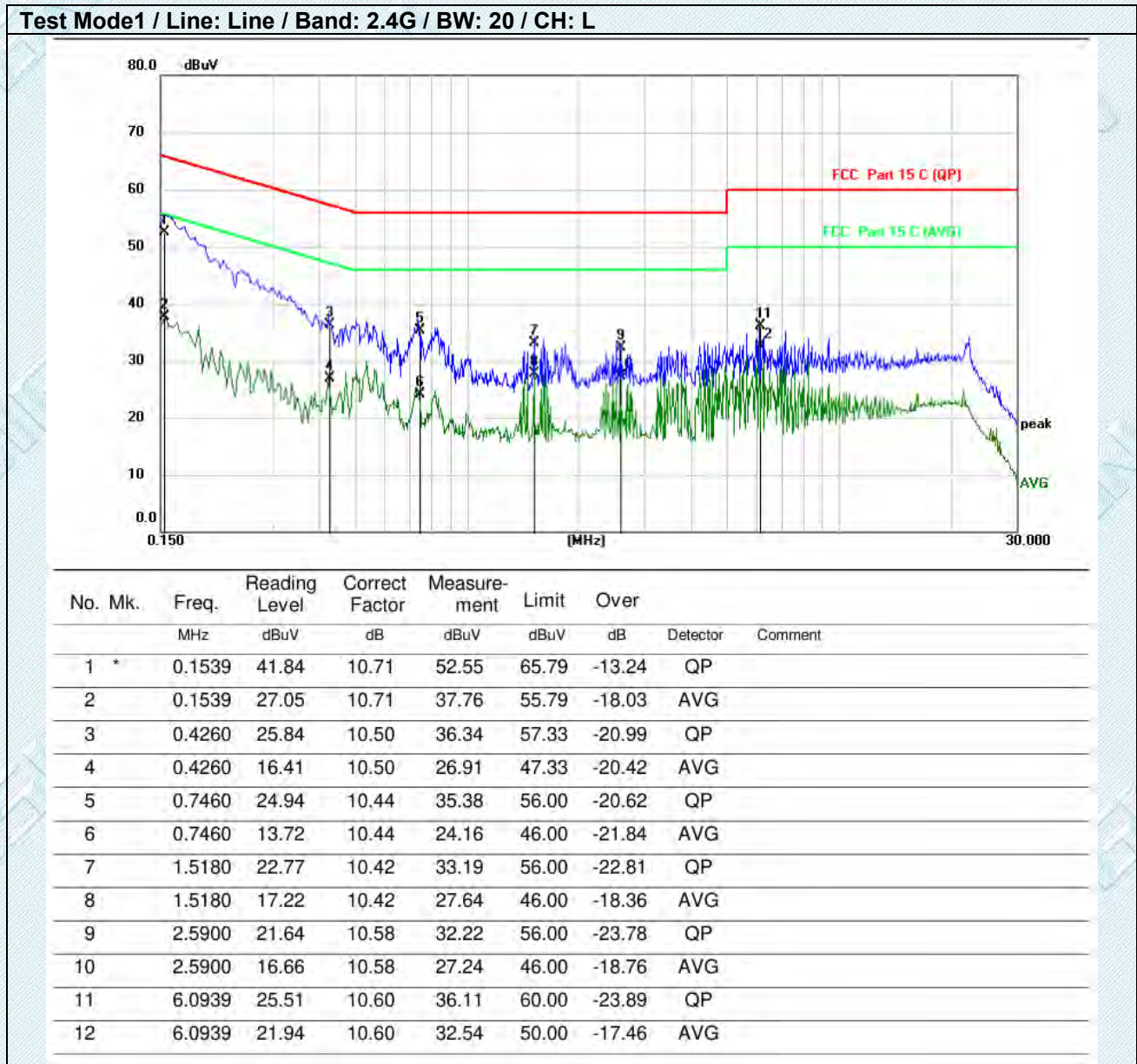

TRF RF_R1

Add: West Side of 1/F., Building C, Zone A, Fuyuan New Factory, Jiujiu Industrial Park, Minzhu, Shatou, Shajing, Bao'an District, Shenzhen, Guangdong, China

Tel: +(86) 0755-2985 2678 Fax: +(86) 0755-2985 2397 E-mail: info@gdksign.cn Web: www.gdksign.com

Test Mode1 / Line: Neutral / Band: 2.4G / BW: 20 / CH: L

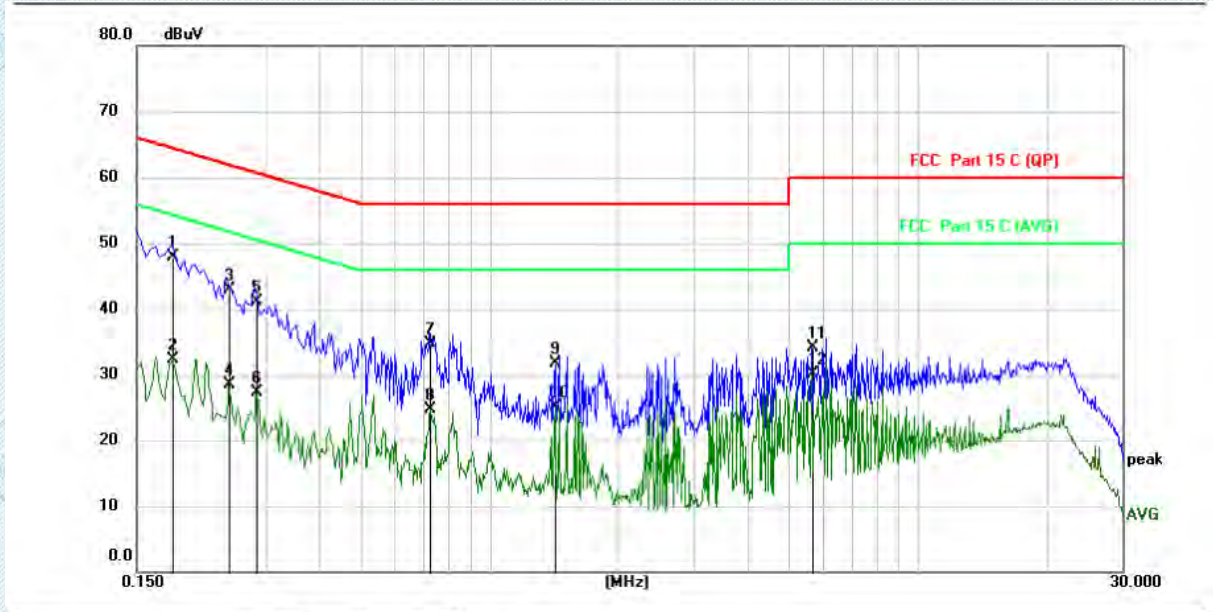

No.	Mk.	Freq. MHz	Reading Level dBuV	Correct Factor dB	Measure- ment dBuV	Limit dBuV	Over dB	Detector	Comment
1	*	0.1819	37.12	10.74	47.86	64.40	-16.54	QP	
2		0.1819	21.53	10.74	32.27	54.40	-22.13	AVG	
3		0.2460	32.25	10.71	42.96	61.89	-18.93	QP	
4		0.2460	17.80	10.71	28.51	51.89	-23.38	AVG	
5		0.2860	30.62	10.56	41.18	60.64	-19.46	QP	
6		0.2860	16.79	10.56	27.35	50.64	-23.29	AVG	
7		0.7260	24.34	10.43	34.77	56.00	-21.23	QP	
8		0.7260	14.32	10.43	24.75	46.00	-21.25	AVG	
9		1.4220	21.26	10.49	31.75	56.00	-24.25	QP	
10		1.4220	14.59	10.49	25.08	46.00	-20.92	AVG	
11		5.6539	23.50	10.60	34.10	60.00	-25.90	QP	
12		5.6539	19.47	10.60	30.07	50.00	-19.93	AVG	

Remark:

1. Both 120 VAC, 50/60 Hz power supply have been tested, only the worst result of 120 VAC, 60 Hz was reported as below.

2. Measurement = Reading Level+ Correct Factor

3. Over = Measurement -Limit

TRF RF_R1

Add: West Side of 1/F., Building C, Zone A, Fuyuan New Factory, Jiujiu Industrial Park, Minzhu, Shatou, Shajing, Bao'an District, Shenzhen, Guangdong, China

Tel: +(86) 0755-2985 2678 Fax: +(86) 0755-2985 2397 E-mail: info@gdksign.cn Web: www.gdksign.com

4.2. Occupied Bandwidth

Test Requirement:	Systems using digital modulation techniques may operate in the 902-928 MHz, and 2400-2483.5 MHz bands. The minimum 6 dB bandwidth shall be at least 500 kHz.
Test Limit:	Section (a)(2), Systems using digital modulation techniques may operate in the 902-928 MHz, and 2400-2483.5 MHz bands. The minimum 6 dB bandwidth shall be at least 500 kHz.
Test Method:	DTS bandwidth
Procedure:	<ul style="list-style-type: none"> a) Set RBW = 100 kHz. b) Set the VBW \geq [3 × RBW]. c) Detector = peak. d) Trace mode = max hold. e) Sweep = auto couple. f) Allow the trace to stabilize. g) Measure the maximum width of the emission that is constrained by the frequencies associated with the two outermost amplitude points (upper and lower frequencies) that are attenuated by 6 dB relative to the maximum level measured in the fundamental emission.

4.2.1. E.U.T. Operation:

Operating Environment:	
Temperature:	23.3 °C
Humidity:	48.3 %
Atmospheric Pressure:	102 kPa
Final test mode:	Test Mode1, Test Mode2, Test Mode3, Test Mode4

4.2.2. Test Setup Diagram:

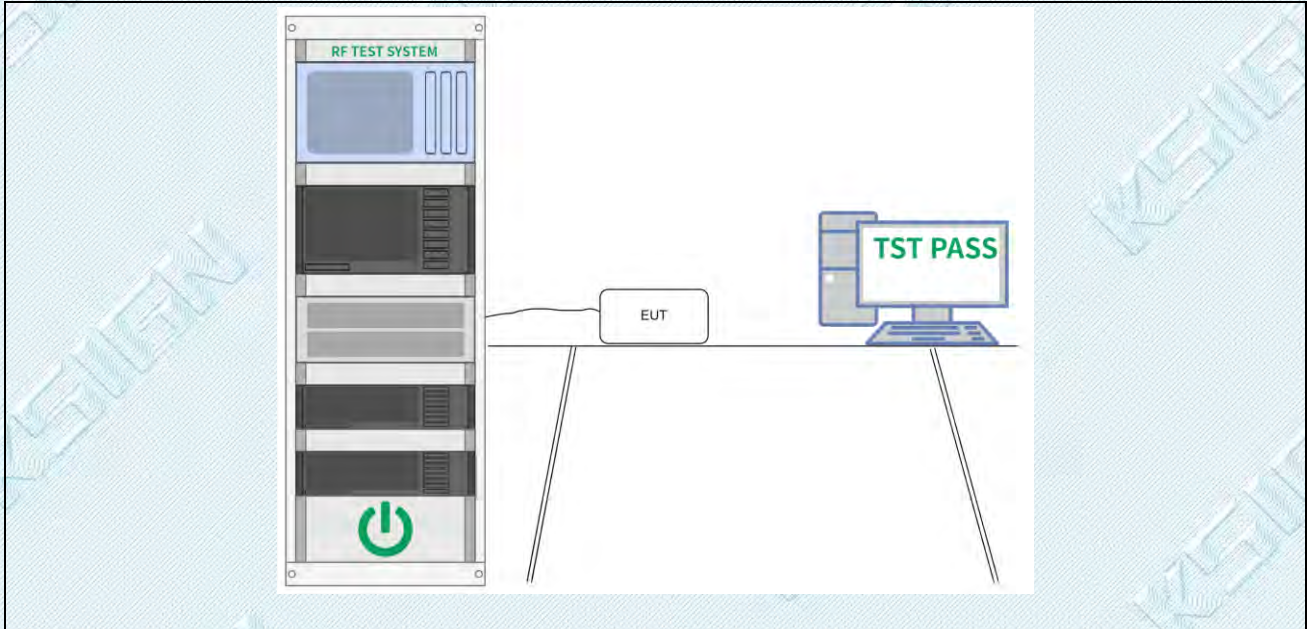

4.2.3. Test Data:

Please Refer to Appendix for Details.

4.3. Maximum Conducted Output Power

Test Requirement:	For systems using digital modulation in the 902-928 MHz, 2400-2483.5 MHz, and 5725-5850 MHz bands: 1 Watt. As an alternative to a peak power measurement, compliance with the one Watt limit can be based on a measurement of the maximum conducted output power. Maximum Conducted Output Power is defined as the total transmit power delivered to all antennas and antenna elements averaged across all symbols in the signaling alphabet when the transmitter is operating at its maximum power control level. Power must be summed across all antennas and antenna elements. The average must not include any time intervals during which the transmitter is off or is transmitting at a reduced power level. If multiple modes of operation are possible (e.g., alternative modulation methods), the maximum conducted output power is the highest total transmit power occurring in any mode.
Test Limit:	For systems using digital modulation in the 902-928 MHz, 2400-2483.5 MHz, and 5725-5850 MHz bands: 1 Watt. As an alternative to a peak power measurement, compliance with the one Watt limit can be based on a measurement of the maximum conducted output power. Maximum Conducted Output Power is defined as the total transmit power delivered to all antennas and antenna elements averaged across all symbols in the signaling alphabet when the transmitter is operating at its maximum power control level. Power must be summed across all antennas and antenna elements. The average must not include any time intervals during which the transmitter is off or is transmitting at a reduced power level. If multiple modes of operation are possible (e.g., alternative modulation methods), the maximum conducted output power is the highest total transmit power occurring in any mode.
Test Method:	Maximum conducted (average) output power
Procedure:	ANSI C63.10-2013, section 11.9.2 Maximum conducted (average) output power

4.3.1. E.U.T. Operation:

Operating Environment:	
Temperature:	23.3 °C
Humidity:	48.3 %
Atmospheric Pressure:	102 kPa
Final test mode:	Test Mode1, Test Mode2, Test Mode3, Test Mode4

4.3.2. Test Setup Diagram:

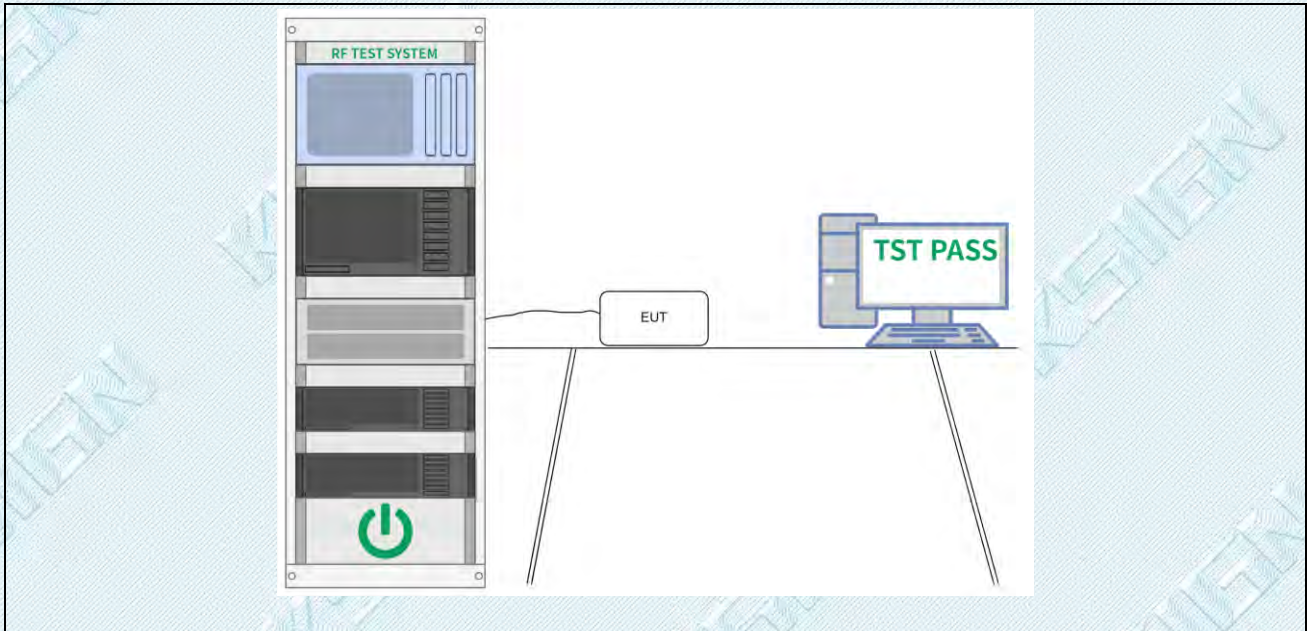

4.3.3. Test Data:

Please Refer to Appendix for Details.

4.4. Power Spectral Density

Test Requirement:	For digitally modulated systems, the power spectral density conducted from the intentional radiator to the antenna shall not be greater than 8 dBm in any 3 kHz band during any time interval of continuous transmission. This power spectral density shall be determined in accordance with the provisions of paragraph (b) of this section. The same method of determining the conducted output power shall be used to determine the power spectral density.
Test Limit:	For digitally modulated systems, the power spectral density conducted from the intentional radiator to the antenna shall not be greater than 8 dBm in any 3 kHz band during any time interval of continuous transmission. This power spectral density shall be determined in accordance with the provisions of paragraph (b) of this section. The same method of determining the conducted output power shall be used to determine the power spectral density.
Test Method:	Maximum power spectral density level in the fundamental emission

4.4.1. E.U.T. Operation:

Operating Environment:	
Temperature:	23.3 °C
Humidity:	48.3 %
Atmospheric Pressure:	102 kPa
Final test mode:	Test Mode1, Test Mode2, Test Mode3, Test Mode4

4.4.2. Test Setup Diagram:

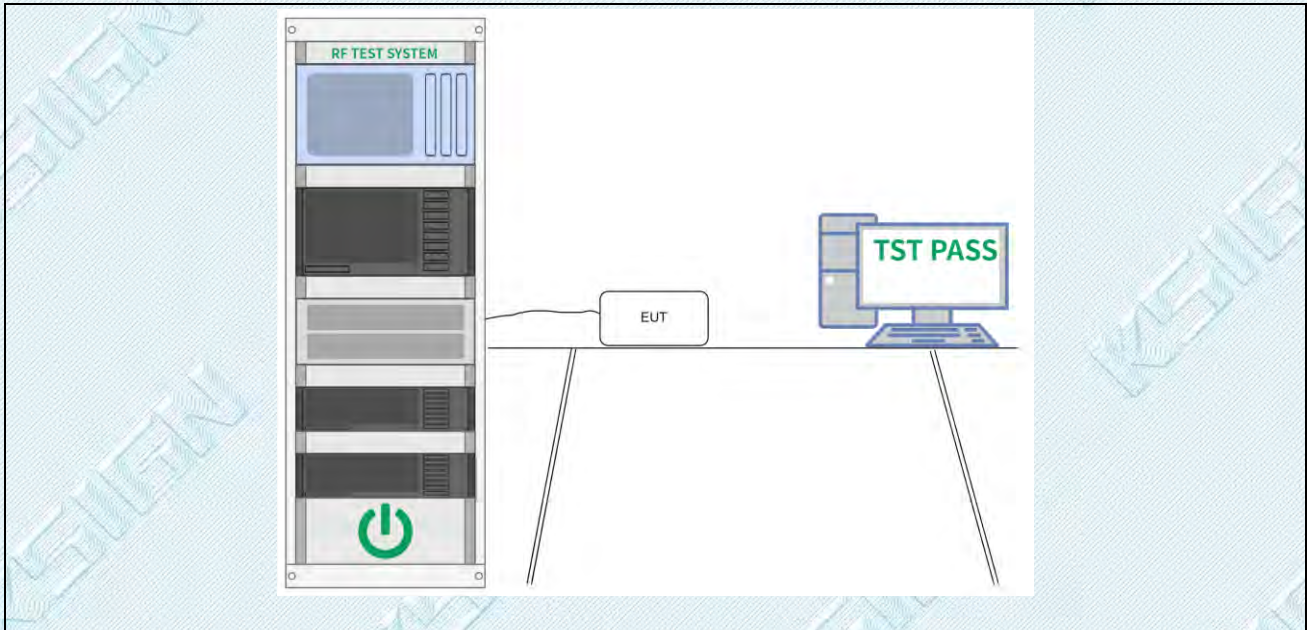

4.4.3. Test Data:

Please Refer to Appendix for Details.

4.5. Emissions in non-restricted frequency bands

Test Requirement:	In any 100 kHz bandwidth outside the frequency band in which the spread spectrum or digitally modulated intentional radiator is operating, the radio frequency power that is produced by the intentional radiator shall be at least 20 dB below that in the 100 kHz bandwidth within the band that contains the highest level of the desired power, based on either an RF conducted or a radiated measurement, provided the transmitter demonstrates compliance with the peak conducted power limits. If the transmitter complies with the conducted power limits based on the use of RMS averaging over a time interval, as permitted under paragraph (b)(3) of this section, the attenuation required under this paragraph shall be 30 dB instead of 20 dB. Attenuation below the general limits specified in § 15.209(a) is not required.
Test Limit:	In any 100 kHz bandwidth outside the frequency band in which the spread spectrum or digitally modulated intentional radiator is operating, the radio frequency power that is produced by the intentional radiator shall be at least 20 dB below that in the 100 kHz bandwidth within the band that contains the highest level of the desired power, based on either an RF conducted or a radiated measurement, provided the transmitter demonstrates compliance with the peak conducted power limits. If the transmitter complies with the conducted power limits based on the use of RMS averaging over a time interval, as permitted under paragraph (b)(3) of this section, the attenuation required under this paragraph shall be 30 dB instead of 20 dB. Attenuation below the general limits specified in § 15.209(a) is not required.
Test Method:	Emissions in nonrestricted frequency bands
Procedure:	ANSI C63.10-2013 Section 11.11.1, Section 11.11.2, Section 11.11.3

4.5.1. E.U.T. Operation:

Operating Environment:	
Temperature:	23.3 °C
Humidity:	48.3 %
Atmospheric Pressure:	102 kPa
Final test mode:	Test Mode1, Test Mode2, Test Mode3, Test Mode4

4.5.2. Test Setup Diagram:

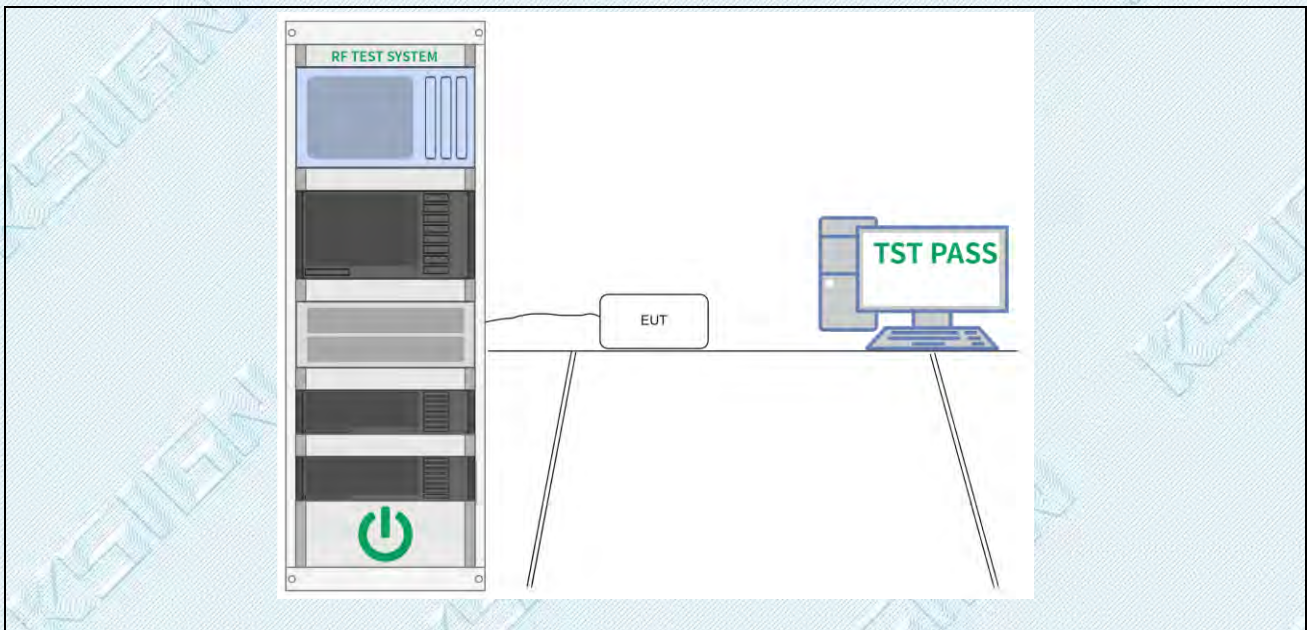

TRF_RF_R1

Add: West Side of 1/F., Building C, Zone A, Fuyuan New Factory, Jiujiu Industrial Park, Minzhu, Shatou, Shajing, Bao'an District, Shenzhen, Guangdong, China

Tel: +(86) 0755-2985 2678 Fax: +(86) 0755-2985 2397 E-mail: info@gdksign.cn Web: www.gdksign.com

4.5.3. Test Data:

Please Refer to Appendix for Details.

4.6. Band edge emissions (Radiated)

Test Requirement:	In addition, radiated emissions which fall in the restricted bands, as defined in § 15.205(a), must also comply with the radiated emission limits specified in § 15.209(a)(see § 15.205(c)).		
Test Limit:	Frequency (MHz)	Field strength (microvolts/meter)	Measurement distance (meters)
	0.009-0.490	2400/F(kHz)	300
	0.490-1.705	24000/F(kHz)	30
	1.705-30.0	30	30
	30-88	100 **	3
	88-216	150 **	3
	216-960	200 **	3
	Above 960	500	3
	** Except as provided in paragraph (g), fundamental emissions from intentional radiators operating under this section shall not be located in the frequency bands 54-72 MHz, 76-88 MHz, 174-216 MHz or 470-806 MHz. However, operation within these frequency bands is permitted under other sections of this part, e.g., §§ 15.231 and 15.241.		
Test Method:	Radiated emissions tests		
Procedure:	ANSI C63.10-2013 section 6.6.4		

4.6.1. E.U.T. Operation:

Operating Environment:	
Temperature:	23.3 °C
Humidity:	48.3 %
Atmospheric Pressure:	102 kPa
Final test mode:	Test Mode1, Test Mode2, Test Mode3, Test Mode4

Note:

1.Measurement = Reading level + Correct Factor

Correct Factor=Antenna Factor + Cable Loss - Preamplifier Factor

2.Pre-scan 802.11b, 802.11g, 802.11n(HT20) and 802.11n (HT40) mode, and found the 802.11b mode which it is worse case, so only show the test data for worse case.

4.6.2. Test Data:

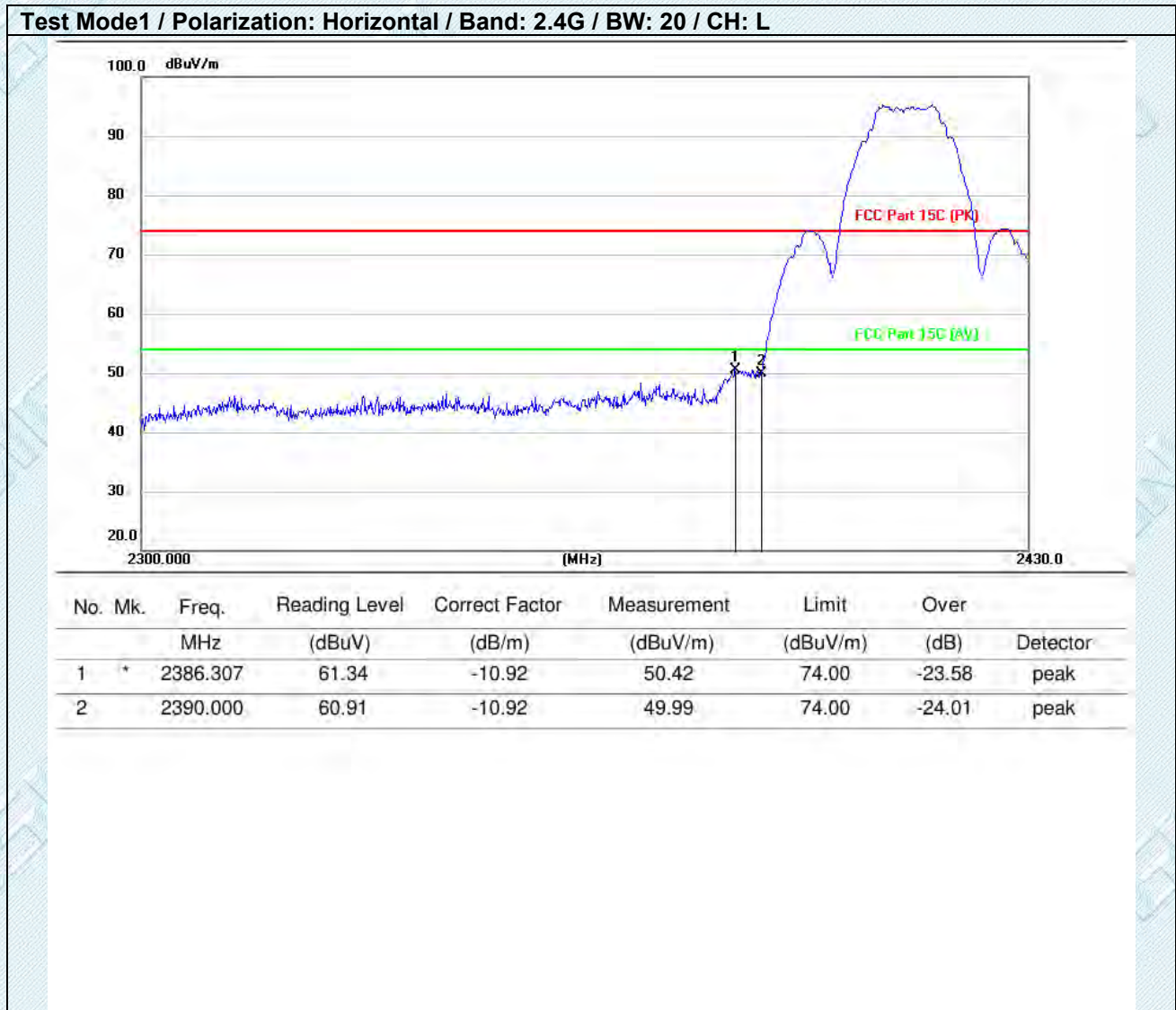

TRF RF_R1

Add: West Side of 1/F., Building C, Zone A, Fuyuan New Factory, Jiujiu Industrial Park, Minzhu, Shatou, Shajing, Bao'an District, Shenzhen, Guangdong, China

Tel: +(86) 0755-2985 2678 Fax: +(86) 0755-2985 2397 E-mail: info@gdksign.cn Web: www.gdksign.com

Test Mode1 / Polarization: Vertical / Band: 2.4G / BW: 20 / CH: L

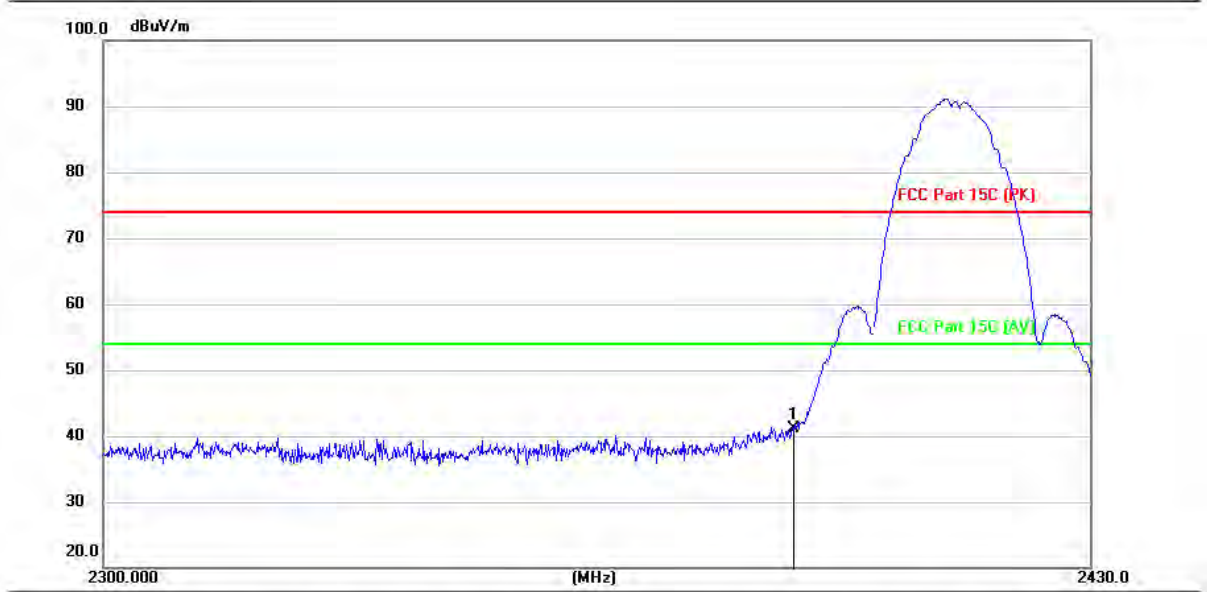

No.	Mk.	Freq. MHz	Reading Level (dBuV)	Correct Factor (dB/m)	Measurement (dBuV/m)	Limit (dBuV/m)	Over (dB)	Detector
1	*	2390.000	51.98	-10.92	41.06	74.00	-32.94	peak

TRF RF_R1

Add: West Side of 1/F., Building C, Zone A, Fuyuan New Factory, Jiujiu Industrial Park, Minzhu, Shatou, Shajing, Bao'an District, Shenzhen, Guangdong, China

Tel: +(86) 0755-2985 2678 Fax: +(86) 0755-2985 2397 E-mail: info@gdksign.cn Web: www.gdksign.com

Test Mode1 / Polarization: Horizontal / Band: 2.4G / BW: 20 / CH: H

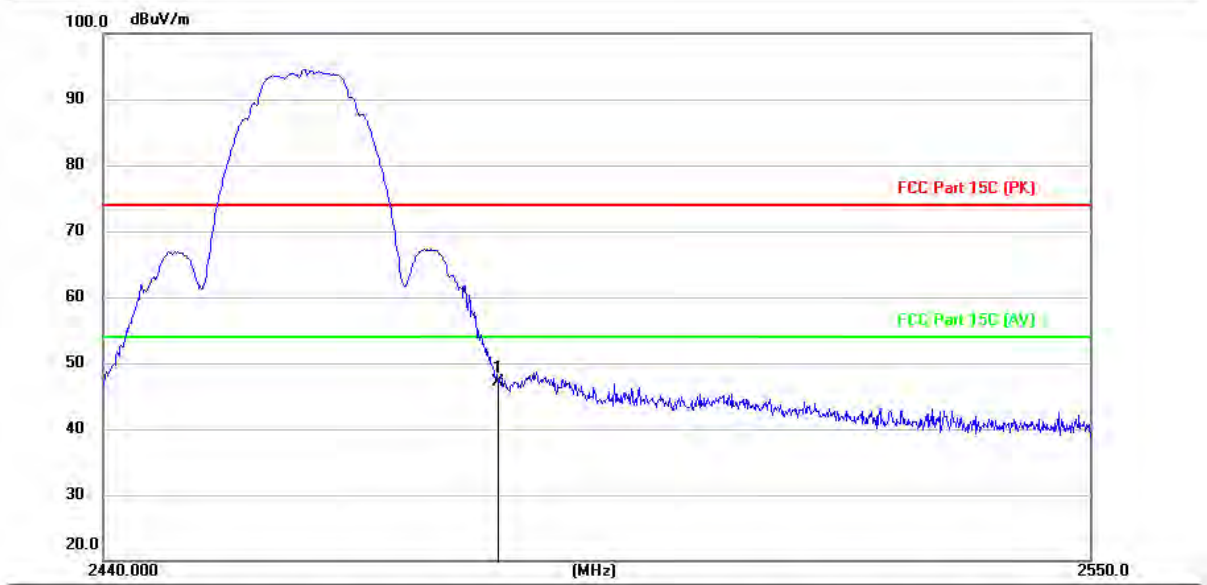

No.	Mk.	Freq. MHz	Reading Level (dBuV)	Correct Factor (dB/m)	Measurement (dBuV/m)	Limit (dBuV/m)	Over (dB)	Detector
1	*	2483.500	58.06	-10.88	47.18	74.00	-26.82	peak

TRF RF_R1

Add: West Side of 1/F., Building C, Zone A, Fuyuan New Factory, Jiujiu Industrial Park, Minzhu, Shatou, Shajing, Bao'an District, Shenzhen, Guangdong, China

Tel: +(86) 0755-2985 2678 Fax: +(86) 0755-2985 2397 E-mail: info@gdksign.cn Web: www.gdksign.com

Test Mode1 / Polarization: Vertical / Band: 2.4G / BW: 20 / CH: H

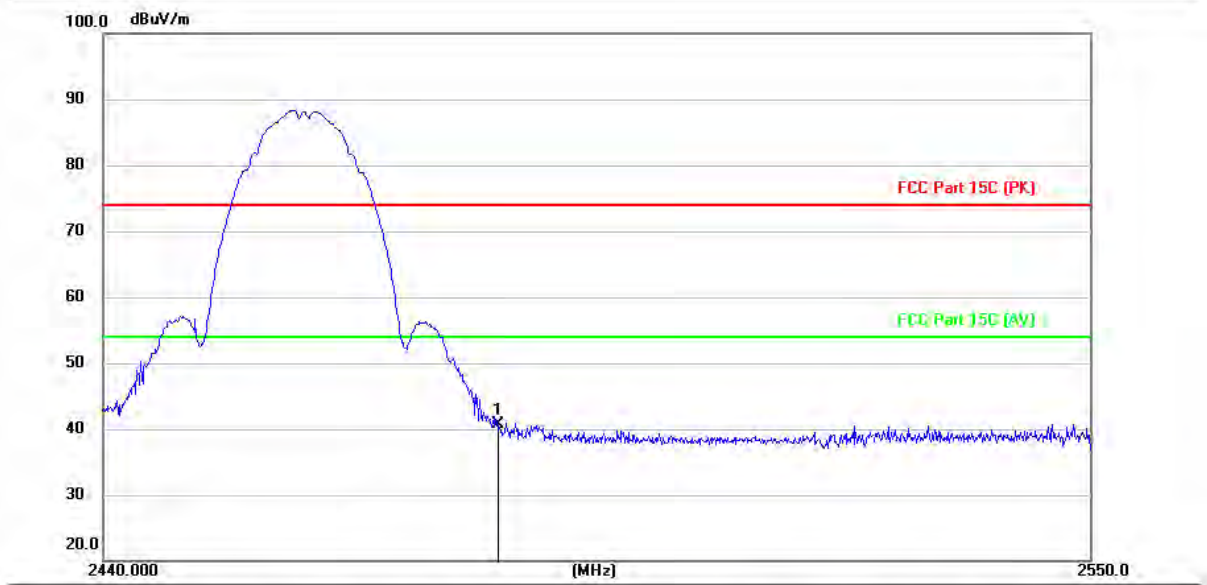

No.	Mk.	Freq. MHz	Reading Level (dBuV)	Correct Factor (dB/m)	Measurement (dBuV/m)	Limit (dBuV/m)	Over (dB)	Detector
1	*	2483.500	51.57	-10.88	40.69	74.00	-33.31	peak

Note:

Since the peak value is less than the limit of the AVG value, there is no AVG data.

4.7. Emissions in restricted frequency bands (below 1GHz)

Test Requirement:	In addition, radiated emissions which fall in the restricted bands, as defined in § 15.205(a), must also comply with the radiated emission limits specified in § 15.209(a)(see § 15.205(c)).		
Test Limit:	Frequency (MHz)	Field strength (microvolts/meter)	Measurement distance (meters)
	0.009-0.490	2400/F(kHz)	300
	0.490-1.705	24000/F(kHz)	30
	1.705-30.0	30	30
	30-88	100 **	3
	88-216	150 **	3
	216-960	200 **	3
	Above 960	500	3
	** Except as provided in paragraph (g), fundamental emissions from intentional radiators operating under this section shall not be located in the frequency bands 54-72 MHz, 76-88 MHz, 174-216 MHz or 470-806 MHz. However, operation within these frequency bands is permitted under other sections of this part, e.g., §§ 15.231 and 15.241.		
Test Method:	Radiated emissions tests		
Procedure:	ANSI C63.10-2013 section 6.6.4		

4.7.1. E.U.T. Operation:

Operating Environment:	
Temperature:	23.3 °C
Humidity:	48.3 %
Atmospheric Pressure:	102 kPa
Final test mode:	Test Mode1, Test Mode2, Test Mode3, Test Mode4

Note:

- 1.Pre-scan 802.11b/g/n(HT20,HT40) modulation, and found the 802.11b modulation which it is 2412MHz channel which it is worse case for below 1GHz, so only show the test data for worse case.
2. Measurement = Reading level + Correct Factor
Correct Factor=Antenna Factor + Cable Loss - Pre-amplifier Factor

4.7.2. Test Data:

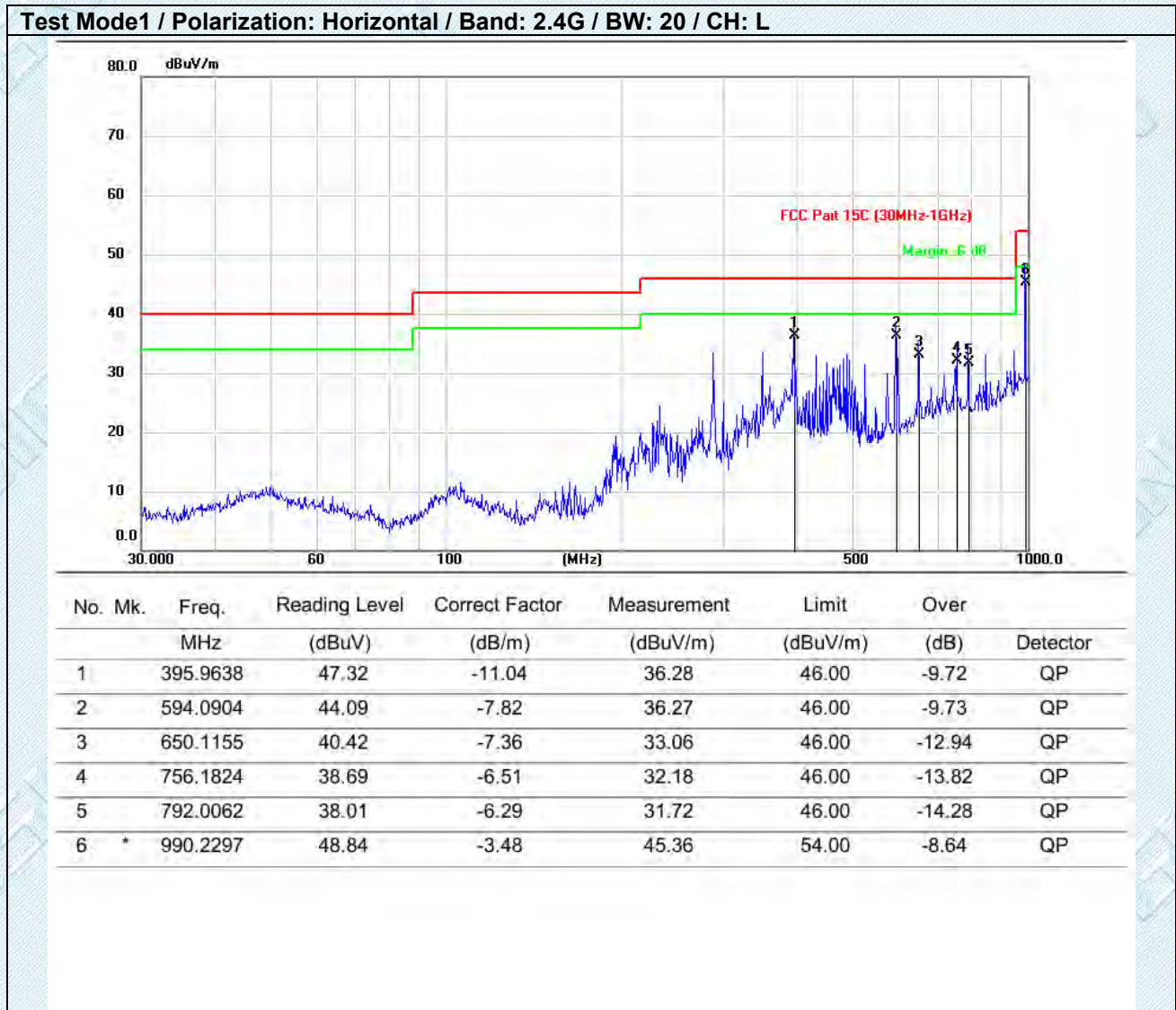

TRF_RF_R1

Add: West Side of 1/F., Building C, Zone A, Fuyuan New Factory, Jiujiu Industrial Park, Minzhu, Shatou, Shajing, Bao'an District, Shenzhen, Guangdong, China

Tel: +(86) 0755-2985 2678 Fax: +(86) 0755-2985 2397 E-mail: info@gdksign.cn Web: www.gdksign.com

Test Mode1 / Polarization: Vertical / Band: 2.4G / BW: 20 / CH: L



No. Mk.	Freq. MHz	Reading Level (dBuV)	Correct Factor (dB/m)	Measurement (dBuV/m)	Limit (dBuV/m)	Over (dB)	Detector
1	349.9854	45.81	-12.54	33.27	46.00	-12.73	QP
2	395.9638	44.17	-11.04	33.13	46.00	-12.87	QP
3	489.5416	42.98	-10.02	32.96	46.00	-13.04	QP
4	528.0606	44.82	-9.36	35.46	46.00	-10.54	QP
5 *	594.0904	45.91	-7.82	38.09	46.00	-7.91	QP
6	792.0062	42.54	-6.29	36.25	46.00	-9.75	QP

TRF RF_R1

Add: West Side of 1/F., Building C, Zone A, Fuyuan New Factory, Jiujiu Industrial Park, Minzhu, Shatou, Shajing, Bao'an District, Shenzhen, Guangdong, China

Tel: +(86) 0755-2985 2678 Fax: +(86) 0755-2985 2397 E-mail: info@gdksign.cn Web: www.gdksign.com

4.8. Emissions in restricted frequency bands (above 1GHz)

Test Requirement:	In addition, radiated emissions which fall in the restricted bands, as defined in § 15.205(a), must also comply with the radiated emission limits specified in § 15.209(a)(see § 15.205(c)).		
Test Limit:	Frequency (MHz)	Field strength (microvolts/meter)	Measurement distance (meters)
	0.009-0.490	2400/F(kHz)	300
	0.490-1.705	24000/F(kHz)	30
	1.705-30.0	30	30
	30-88	100 **	3
	88-216	150 **	3
	216-960	200 **	3
	Above 960	500	3
	** Except as provided in paragraph (g), fundamental emissions from intentional radiators operating under this section shall not be located in the frequency bands 54-72 MHz, 76-88 MHz, 174-216 MHz or 470-806 MHz. However, operation within these frequency bands is permitted under other sections of this part, e.g., §§ 15.231 and 15.241.		
Test Method:	Radiated emissions tests		
Procedure:	ANSI C63.10-2013 section 6.6.4		

4.8.1. E.U.T. Operation:

Operating Environment:	
Temperature:	23.3 °C
Humidity:	48.3 %
Atmospheric Pressure:	102 kPa
Final test mode:	Test Mode1, Test Mode2, Test Mode3, Test Mode4

Note:

- 1.Pre-scan 802.11b/g/n(HT20,HT40) modulation, and found the 802.11b modulation which it is worse case for above 1GHz , so only show the test data for worse case.
- 2.Measurement = Reading level + Correct Factor
Correct Factor=Antenna Factor + Cable Loss - Preamplifier Factor

4.8.2. Test Data:

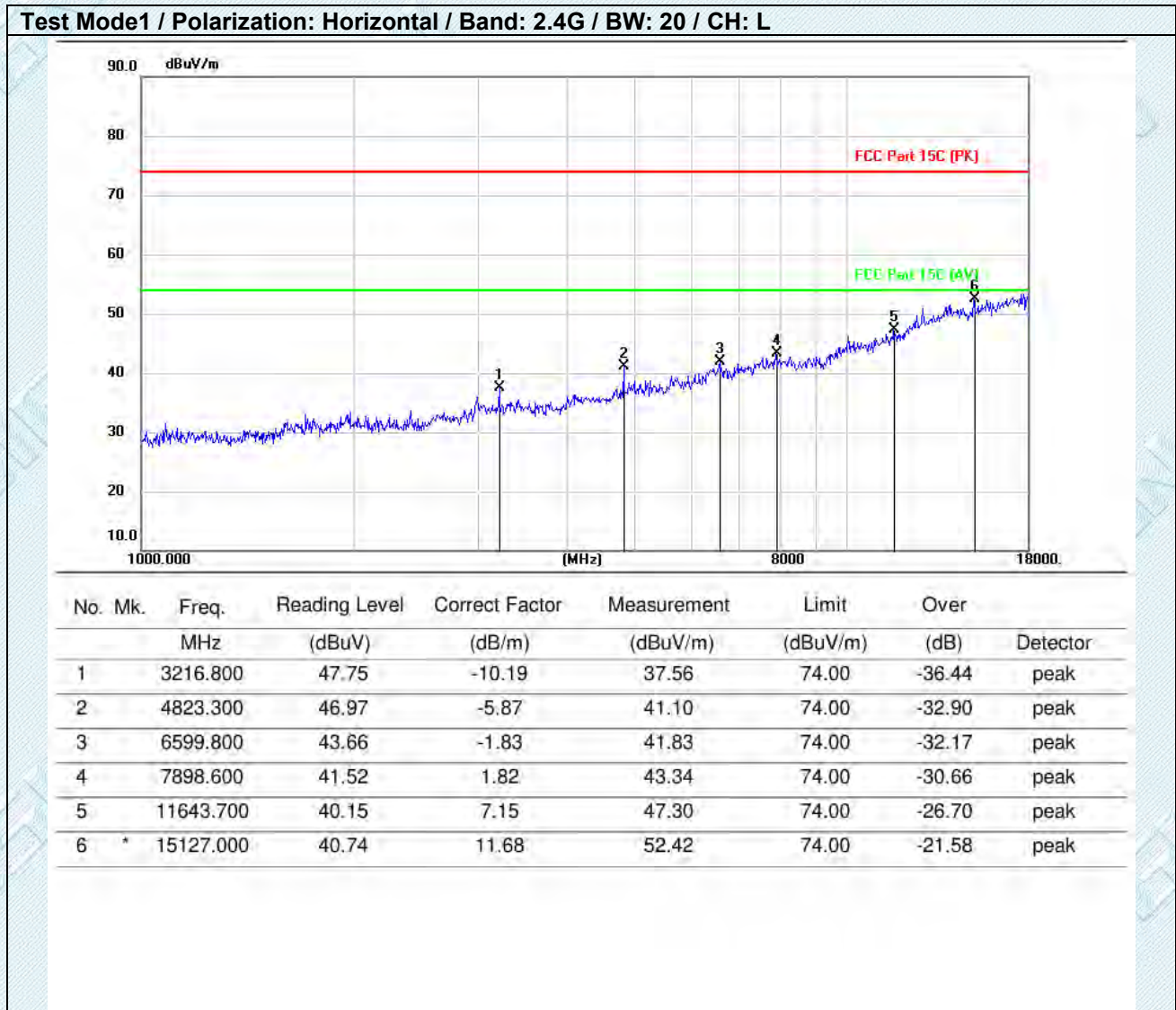

TRF RF_R1

Add: West Side of 1/F., Building C, Zone A, Fuyuan New Factory, Jiujiu Industrial Park, Minzhu, Shatou, Shajing, Bao'an District, Shenzhen, Guangdong, China

Tel: +(86) 0755-2985 2678 Fax: +(86) 0755-2985 2397 E-mail: info@gdksign.cn Web: www.gdksign.com

Test Mode1 / Polarization: Vertical / Band: 2.4G / BW: 20 / CH: L

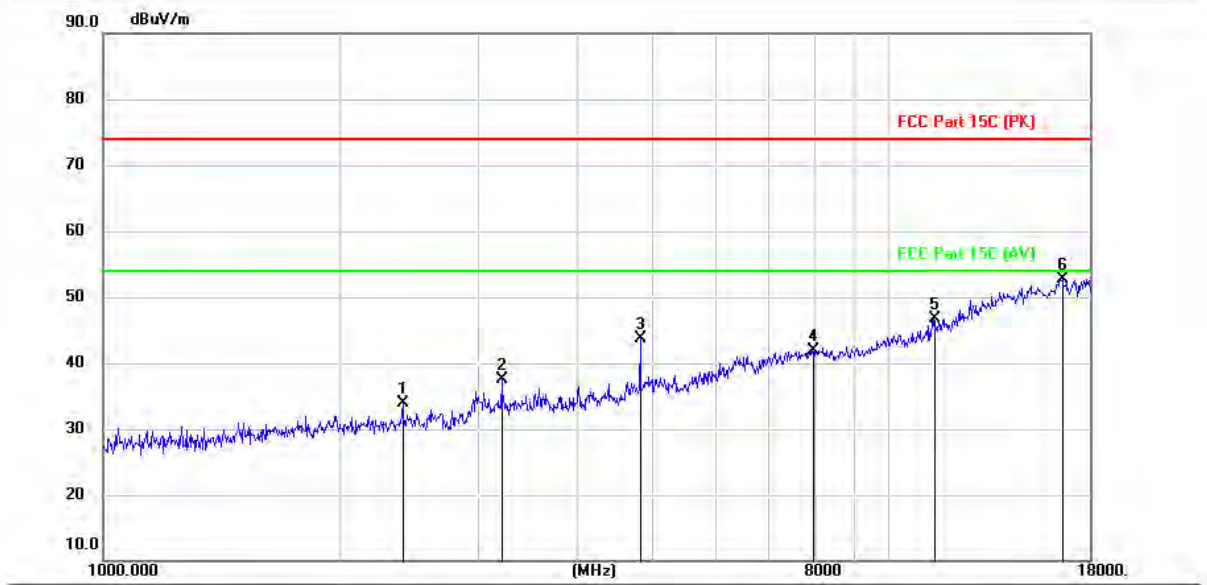

No. Mk.	Freq. MHz	Reading Level (dBuV)	Correct Factor (dB/m)	Measurement (dBuV/m)	Limit (dBuV/m)	Over (dB)	Detector
1	2412.700	44.79	-10.92	33.87	74.00	-40.13	peak
2	3215.100	47.61	-10.20	37.41	74.00	-36.59	peak
3	4825.000	49.62	-5.87	43.75	74.00	-30.25	peak
4	7978.500	39.88	2.02	41.90	74.00	-32.10	peak
5	11417.600	40.08	6.68	46.76	74.00	-27.24	peak
6 *	16626.400	39.00	13.61	52.61	74.00	-21.39	peak

TRF RF_R1

Add: West Side of 1/F., Building C, Zone A, Fuyuan New Factory, Jiujiu Industrial Park, Minzhu, Shatou, Shajing, Bao'an District, Shenzhen, Guangdong, China

Tel: +(86) 0755-2985 2678 Fax: +(86) 0755-2985 2397 E-mail: info@gdksign.cn Web: www.gdksign.com

Test Mode1 / Polarization: Horizontal / Band: 2.4G / BW: 20 / CH: M

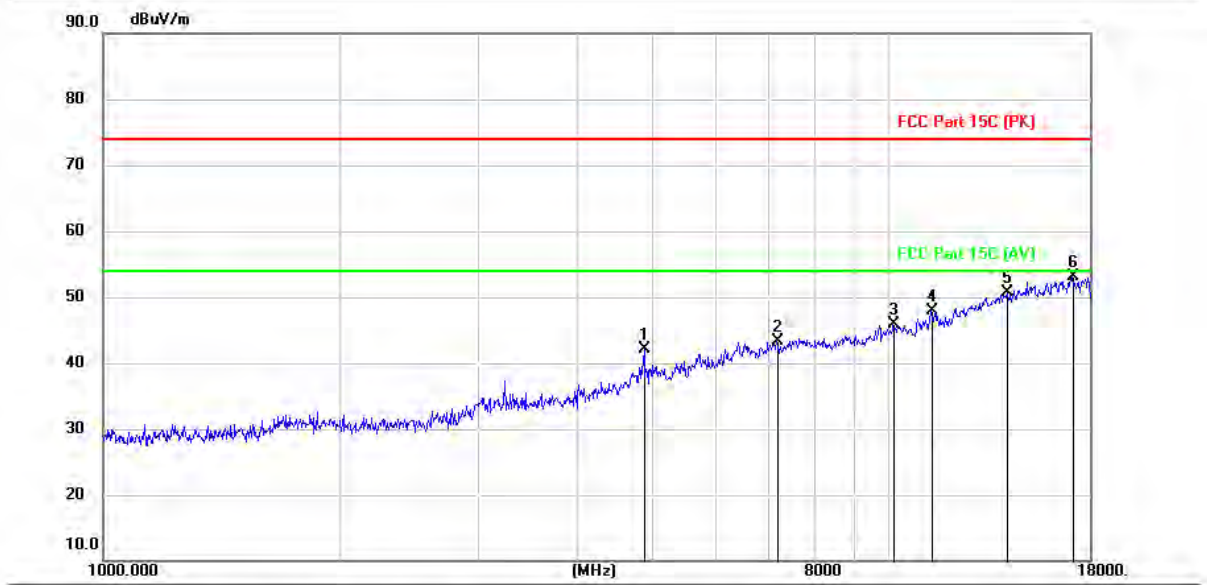

No. Mk.	Freq. MHz	Reading Level (dBuV)	Correct Factor (dB/m)	Measurement (dBuV/m)	Limit (dBuV/m)	Over (dB)	Detector
1	4874.300	47.78	-5.74	42.04	74.00	-31.96	peak
2	7186.300	43.37	-0.14	43.23	74.00	-30.77	peak
3	10135.800	41.65	4.30	45.95	74.00	-28.05	peak
4	11330.900	41.36	6.47	47.83	74.00	-26.17	peak
5	14139.300	39.73	11.04	50.77	74.00	-23.23	peak
6 *	17088.800	40.06	13.09	53.15	74.00	-20.85	peak

TRF RF_R1

Add: West Side of 1/F., Building C, Zone A, Fuyuan New Factory, Jiujiu Industrial Park, Minzhu, Shatou, Shajing, Bao'an District, Shenzhen, Guangdong, China

Tel: +(86) 0755-2985 2678 Fax: +(86) 0755-2985 2397 E-mail: info@gdksign.cn Web: www.gdksign.com

Test Mode1 / Polarization: Vertical / Band: 2.4G / BW: 20 / CH: M

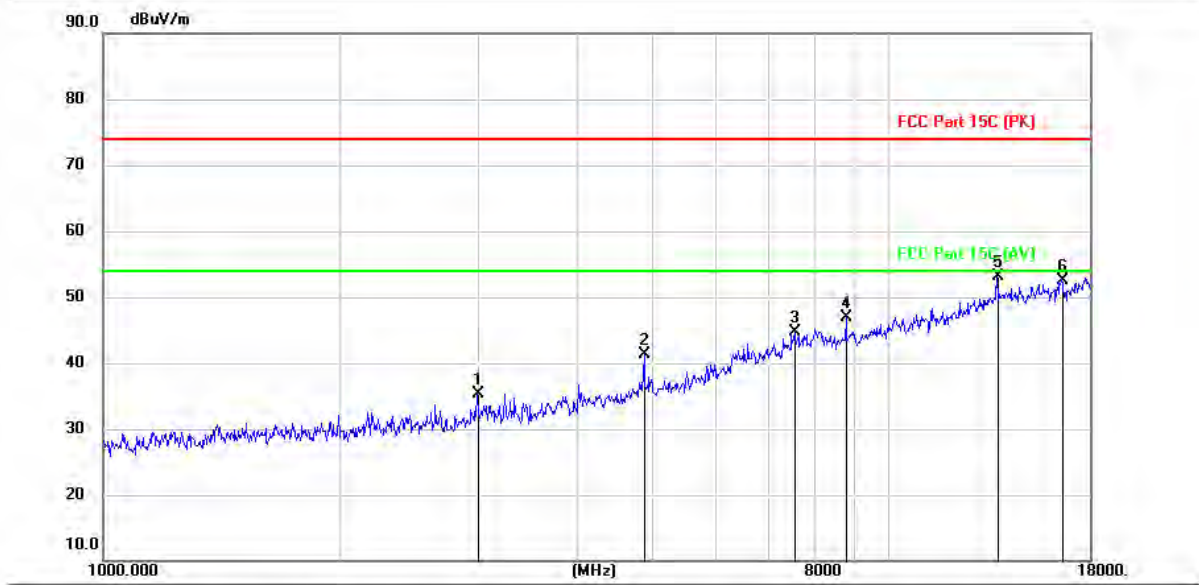

No. Mk.	Freq. MHz	Reading Level (dBuV)	Correct Factor (dB/m)	Measurement (dBuV/m)	Limit (dBuV/m)	Over (dB)	Detector
1	2990.700	45.85	-10.60	35.25	74.00	-38.75	peak
2	4874.300	47.08	-5.74	41.34	74.00	-32.66	peak
3	7563.700	43.79	0.98	44.77	74.00	-29.23	peak
4	8797.900	44.94	1.87	46.81	74.00	-27.19	peak
5 *	13734.700	42.16	10.91	53.07	74.00	-20.93	peak
6	16580.500	38.85	13.68	52.53	74.00	-21.47	peak

TRF RF_R1

Add: West Side of 1/F., Building C, Zone A, Fuyuan New Factory, Jiujiu Industrial Park, Minzhu, Shatou, Shajing, Bao'an District, Shenzhen, Guangdong, China

Tel: +(86) 0755-2985 2678 Fax: +(86) 0755-2985 2397 E-mail: info@gdksign.cn Web: www.gdksign.com

Test Mode1 / Polarization: Horizontal / Band: 2.4G / BW: 20 / CH: H

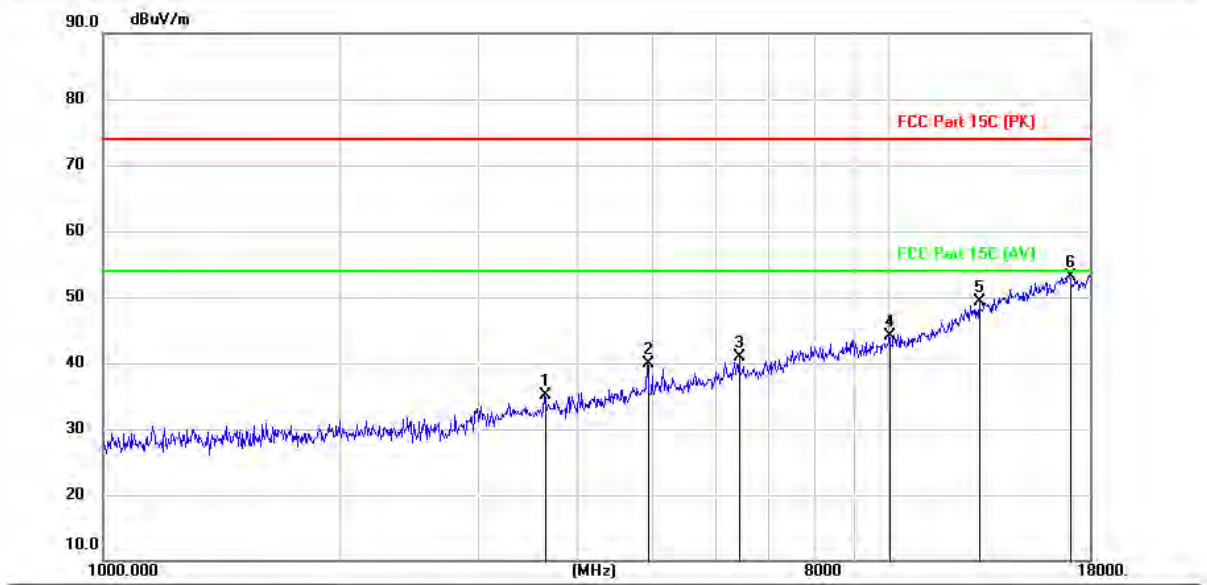

No. Mk.	Freq. MHz	Reading Level (dBuV)	Correct Factor (dB/m)	Measurement (dBuV/m)	Limit (dBuV/m)	Over (dB)	Detector
1	3646.900	44.47	-9.31	35.16	74.00	-38.84	peak
2	4923.600	45.41	-5.60	39.81	74.00	-34.19	peak
3	6434.900	43.25	-2.33	40.92	74.00	-33.08	peak
4	10032.100	40.06	4.12	44.18	74.00	-29.82	peak
5	13034.300	39.40	9.98	49.38	74.00	-24.62	peak
6 *	16978.300	40.07	13.06	53.13	74.00	-20.87	peak

TRF RF_R1

Add: West Side of 1/F., Building C, Zone A, Fuyuan New Factory, Jiujiu Industrial Park, Minzhu, Shatou, Shajing, Bao'an District, Shenzhen, Guangdong, China

Tel: +(86) 0755-2985 2678 Fax: +(86) 0755-2985 2397 E-mail: info@gdksign.cn Web: www.gdksign.com

Test Mode1 / Polarization: Vertical / Band: 2.4G / BW: 20 / CH: H

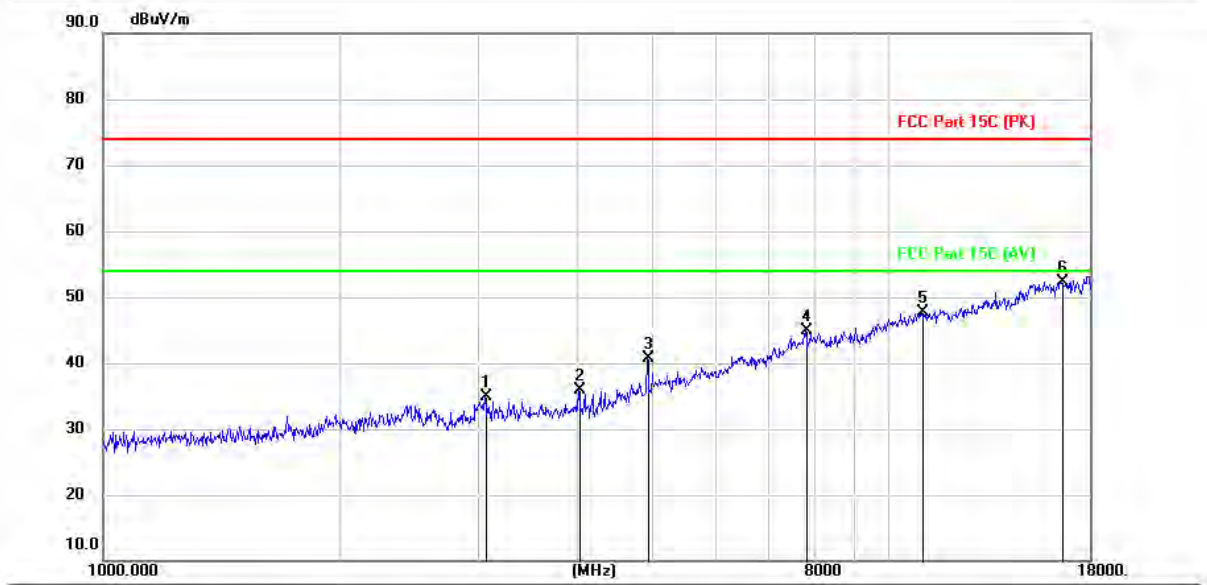

No.	Mk.	Freq. MHz	Reading Level (dBuV)	Correct Factor (dB/m)	Measurement (dBuV/m)	Limit (dBuV/m)	Over (dB)	Detector
1		3063.800	45.41	-10.47	34.94	74.00	-39.06	peak
2		4029.400	44.26	-8.33	35.93	74.00	-38.07	peak
3		4923.600	46.25	-5.60	40.65	74.00	-33.35	peak
4		7820.400	43.28	1.62	44.90	74.00	-29.10	peak
5		11016.400	41.93	5.74	47.67	74.00	-26.33	peak
6	*	16594.100	38.65	13.66	52.31	74.00	-21.69	peak

Note:

1. From 18GHz to 26.5GHz, the amplitude of spurious emissions which are attenuated by more than 20dB below the permissible value has no need to be reported.
2. Since the peak value is less than the limit of the AVG value, there is no AVG data.

TRF_RF_R1

Add: West Side of 1/F., Building C, Zone A, Fuyuan New Factory, Jiujiu Industrial Park, Minzhu, Shatou, Shajing, Bao'an District, Shenzhen, Guangdong, China

Tel: +(86) 0755-2985 2678 Fax: +(86) 0755-2985 2397 E-mail: info@gdksign.cn Web: www.gdksign.com

5. EUT TEST PHOTOS

Conducted Emission at AC power line

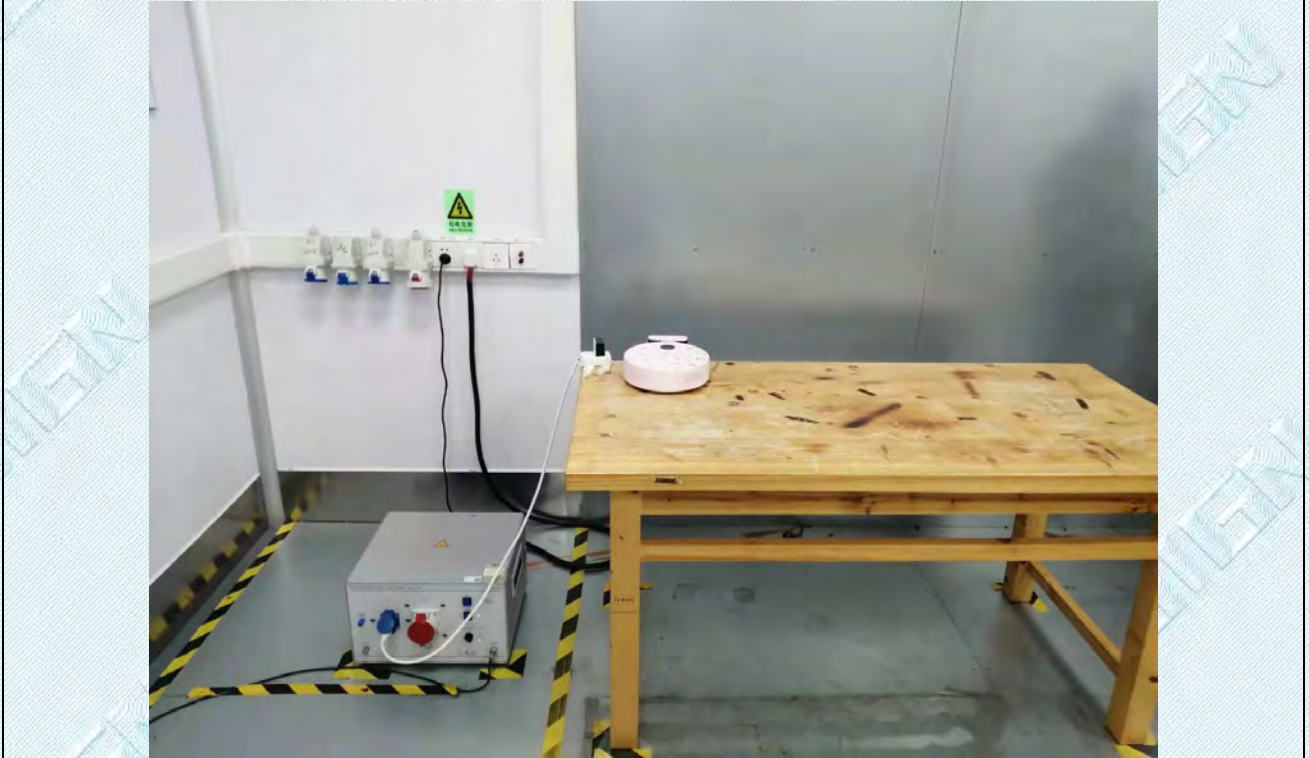

Emissions in restricted frequency bands (below 1GHz)



TRF RF_R1

Add: West Side of 1/F., Building C, Zone A, Fuyuan New Factory, Jiujiu Industrial Park, Minzhu, Shatou, Shajing, Bao'an District, Shenzhen, Guangdong, China

Tel: +(86) 0755-2985 2678 Fax: +(86) 0755-2985 2397 E-mail: info@gdksign.cn Web: www.gdksign.com

Emissions in restricted frequency bands (above 1GHz)

TRF RF_R1

Add: West Side of 1/F., Building C, Zone A, Fuyuan New Factory, Jiujiu Industrial Park, Minzhu, Shatou, Shajing, Bao'an District, Shenzhen, Guangdong, China

Tel: +(86) 0755-2985 2678 Fax: +(86) 0755-2985 2397 E-mail: info@gdksign.cn Web: www.gdksign.com

6. PHOTOGRAPHS OF EUT CONSTRUCTIONAL

Refer to Appendix - Photographs of EUT Constructional Details for KD2303S1652E.

Appendix

TRF RF_R1

Add: West Side of 1/F., Building C, Zone A, Fuyuan New Factory, Jiujiu Industrial Park, Minzhu, Shatou, Shajing, Bao'an District, Shenzhen, Guangdong, China

Tel: +(86) 0755-2985 2678 Fax: +(86) 0755-2985 2397 E-mail: info@gdkesign.cn Web: www.gdkesign.com

6.1. Appendix A: DTS Bandwidth

6.1.1. Test Result

TestMode	Antenna	Frequency[MHz]	DTS BW [MHz]	FL[MHz]	FH[MHz]	Limit[MHz]	Verdict
11B	Ant1	2412	10.00	2407.00	2417.00	0.5	PASS
		2437	10.04	2431.96	2442.00	0.5	PASS
		2462	9.60	2456.96	2466.56	0.5	PASS
11G	Ant1	2412	16.32	2403.84	2420.16	0.5	PASS
		2437	16.32	2428.84	2445.16	0.5	PASS
		2462	16.36	2453.84	2470.20	0.5	PASS
11N20SISO	Ant1	2412	17.60	2403.20	2420.80	0.5	PASS
		2437	17.60	2428.20	2445.80	0.5	PASS
		2462	17.60	2453.20	2470.80	0.5	PASS
11N40SISO	Ant1	2422	35.76	2404.40	2440.16	0.5	PASS
		2437	35.76	2419.40	2455.16	0.5	PASS
		2452	35.76	2434.40	2470.16	0.5	PASS

TRF RF_R1

Add: West Side of 1/F., Building C, Zone A, Fuyuan New Factory, Jiujiu Industrial Park, Minzhu, Shatou, Shajing, Bao'an District, Shenzhen, Guangdong, China

Tel: +(86) 0755-2985 2678 Fax: +(86) 0755-2985 2397 E-mail: info@gdksign.cn Web: www.gdksign.com

6.1.2. Test Graphs



TRF_RF_R1

Add: West Side of 1/F., Building C, Zone A, Fuyuan New Factory, Jiujiu Industrial Park, Minzhu, Shatou, Shajing, Bao'an District, Shenzhen, Guangdong, China

Tel: +(86) 0755-2985 2678 Fax: +(86) 0755-2985 2397 E-mail: info@gdksign.cn Web: www.gdksign.com

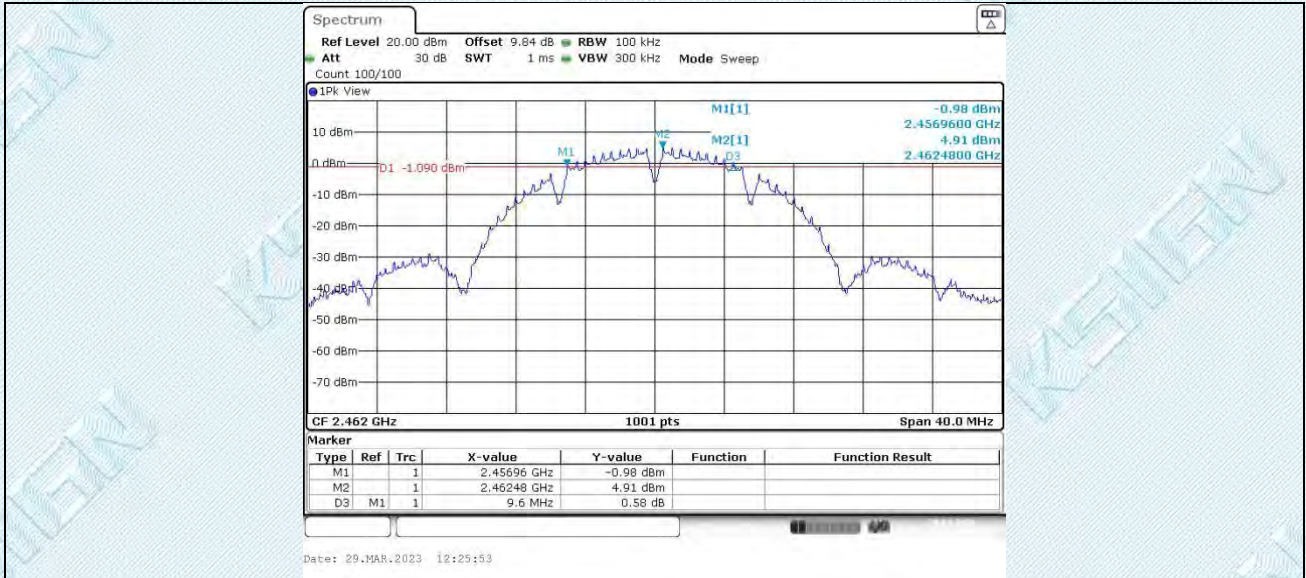

11G Ant1_2412

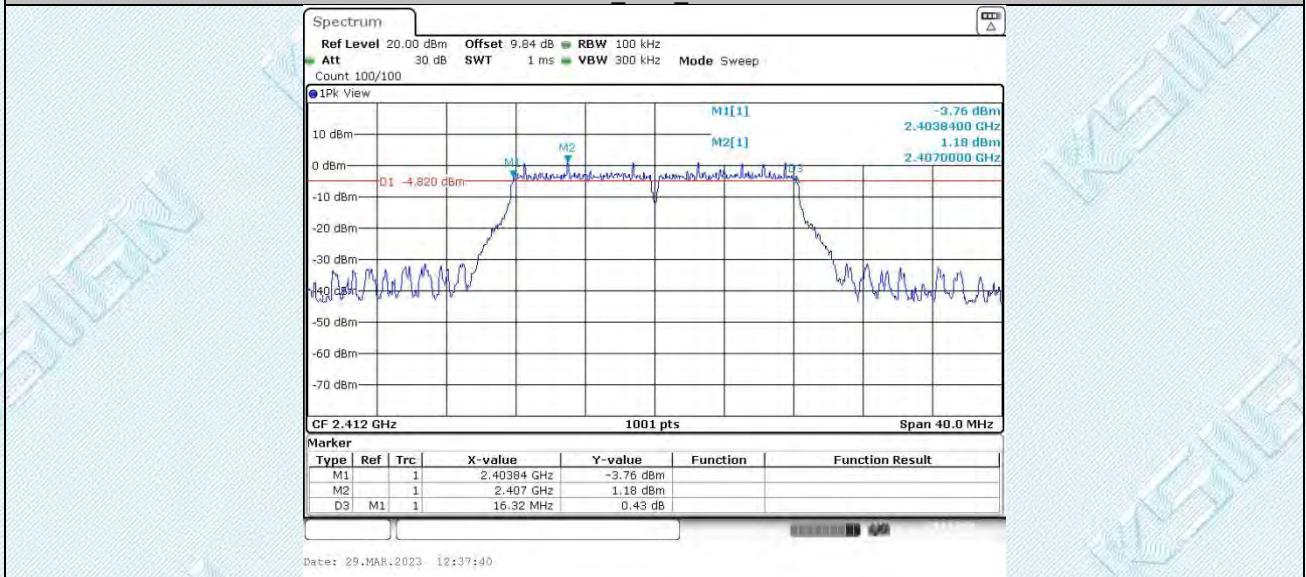

11G Ant1_2437

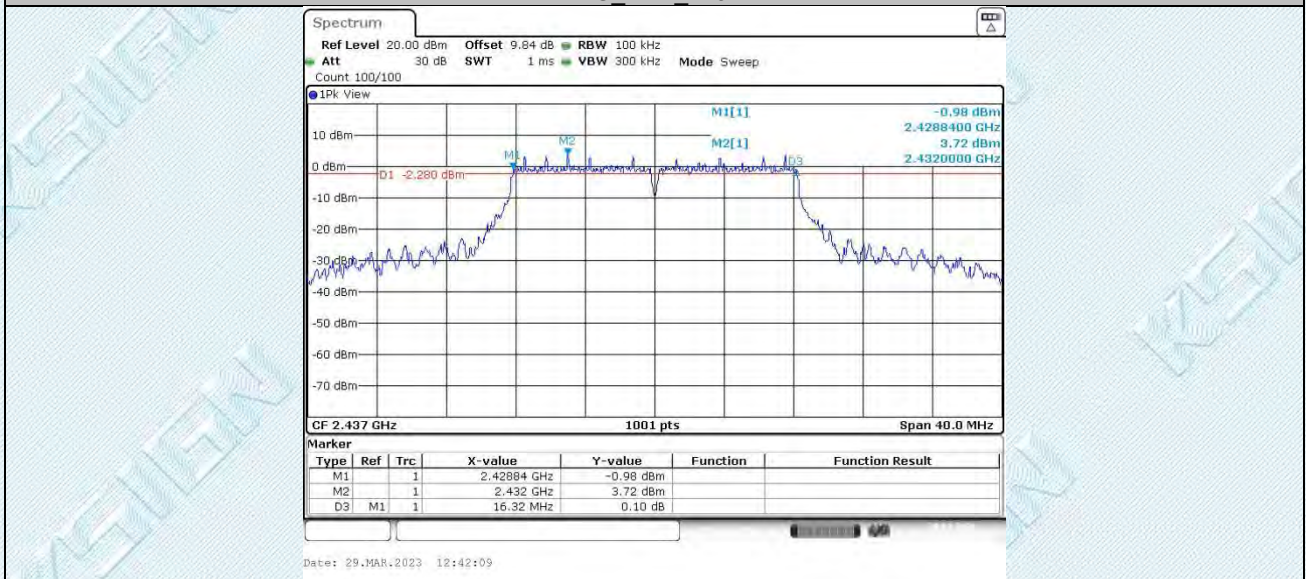

11G Ant1_2462

TRF_RF_R1

Add: West Side of 1/F., Building C, Zone A, Fuyuan New Factory, Jiujiu Industrial Park, Minzhu, Shatou, Shajing, Bao'an District, Shenzhen, Guangdong, China

Tel: +(86) 0755-2985 2678 Fax: +(86) 0755-2985 2397 E-mail: info@gdksign.cn Web: www.gdksign.com

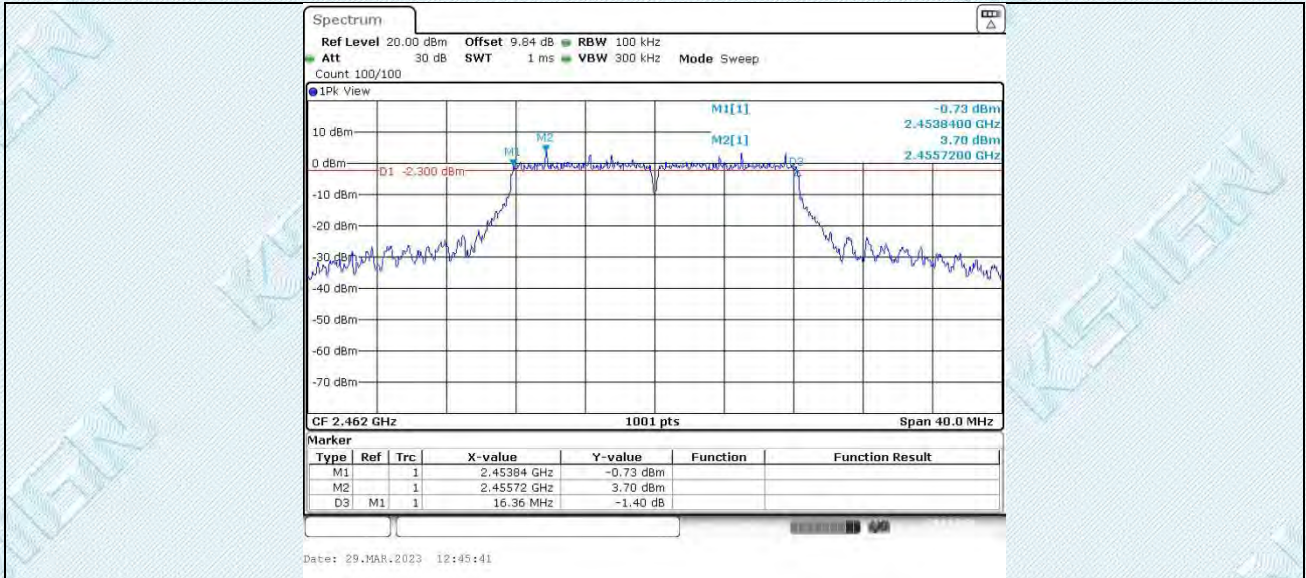

11N20SISO_Ant1_2412

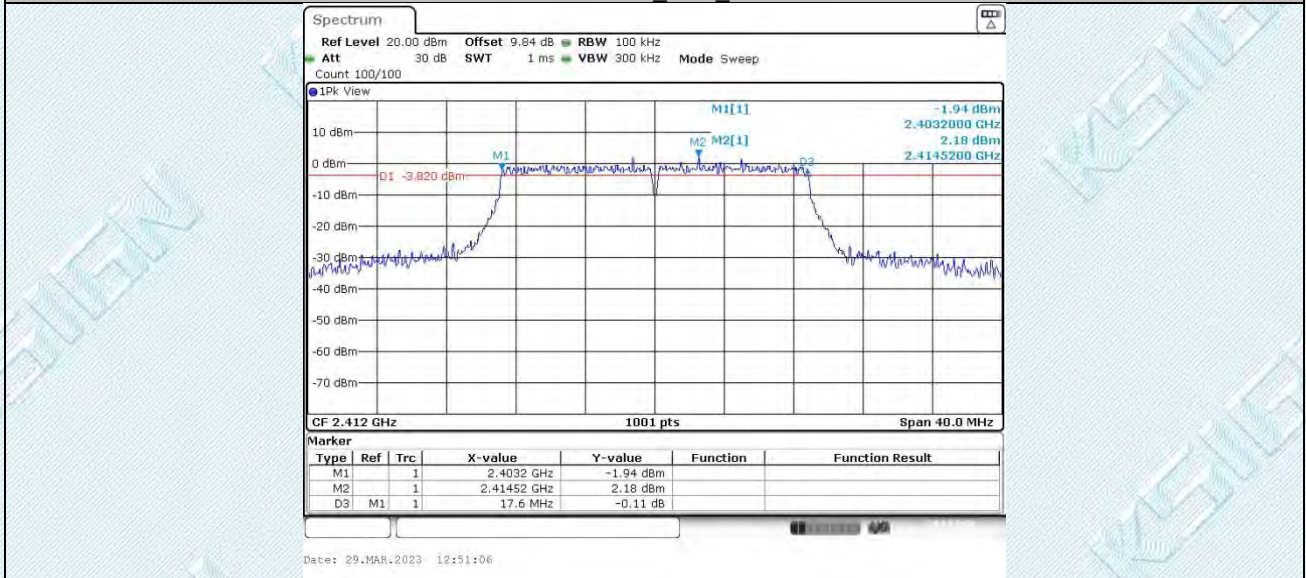

11N20SISO_Ant1_2437

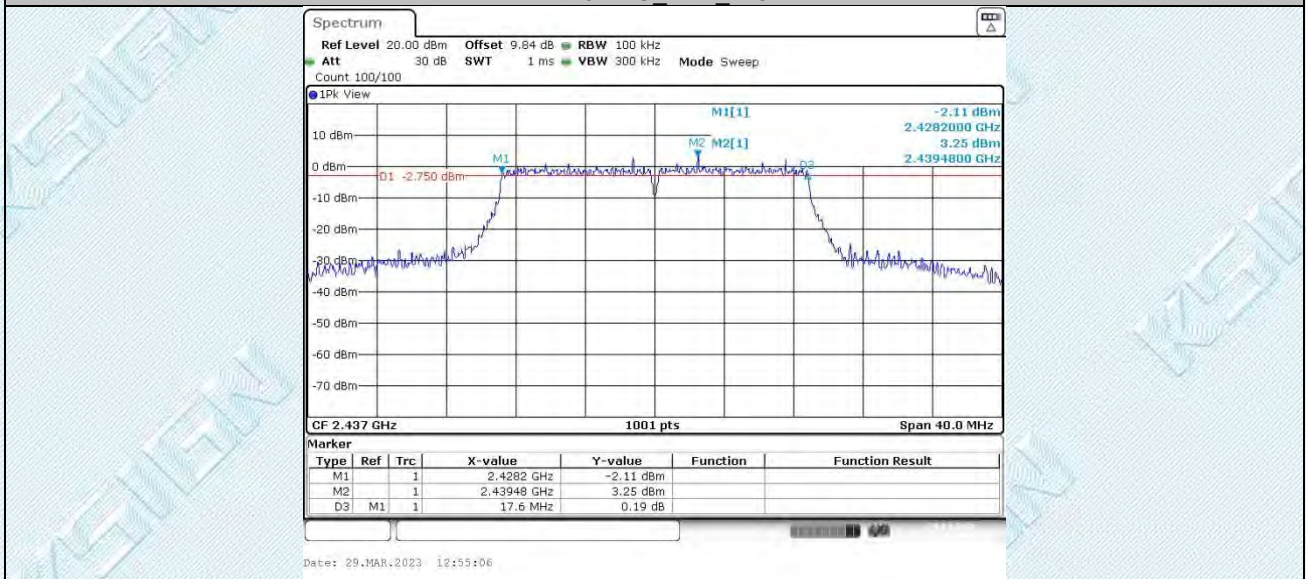

11N20SISO_Ant1_2462

TRF_RF_R1

Add: West Side of 1/F., Building C, Zone A, Fuyuan New Factory, Jiujiu Industrial Park, Minzhu, Shatou, Shajing, Bao'an District, Shenzhen, Guangdong, China

Tel: +(86) 0755-2985 2678 Fax: +(86) 0755-2985 2397 E-mail: info@gdksign.cn Web: www.gdksign.com

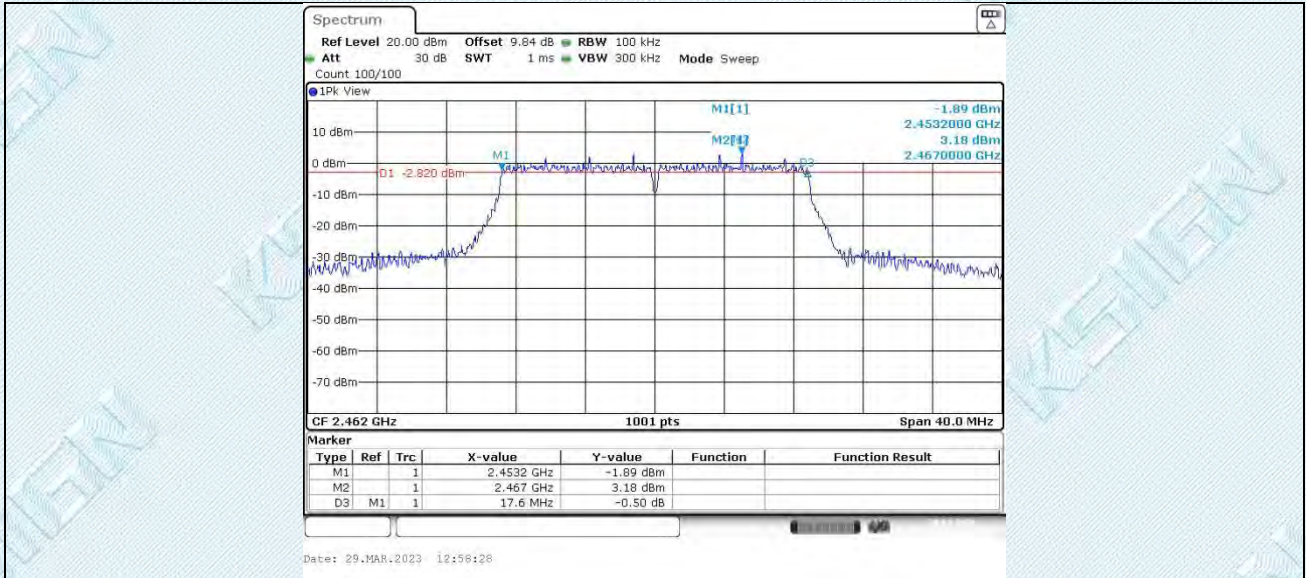

11N40SISO_Ant1_2422

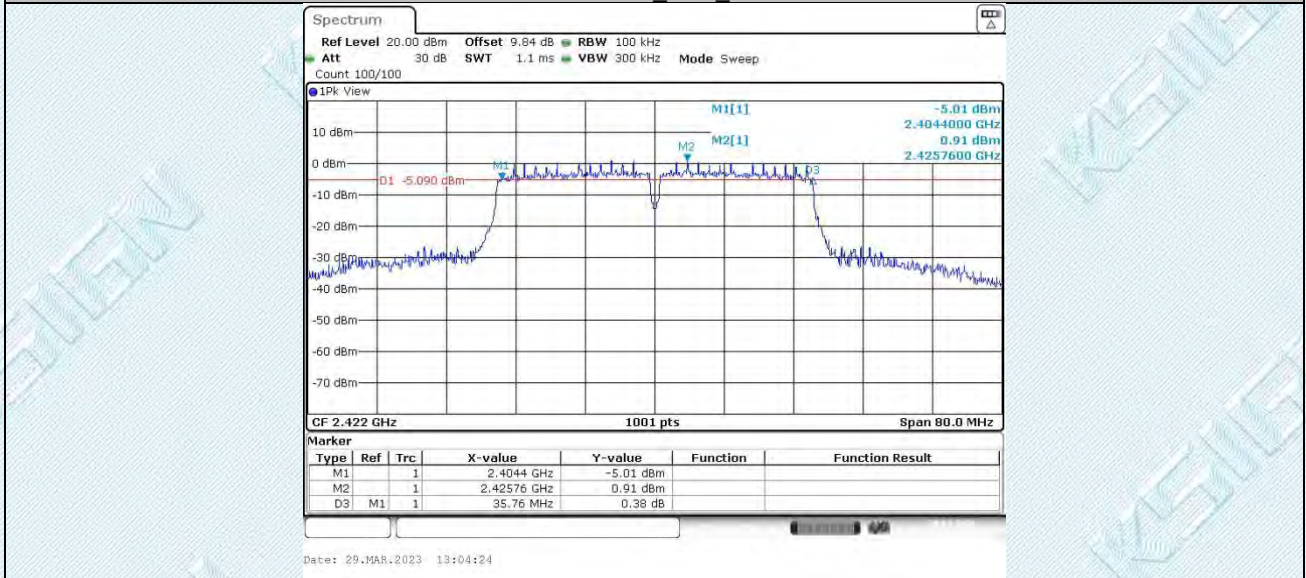

11N40SISO_Ant1_2437

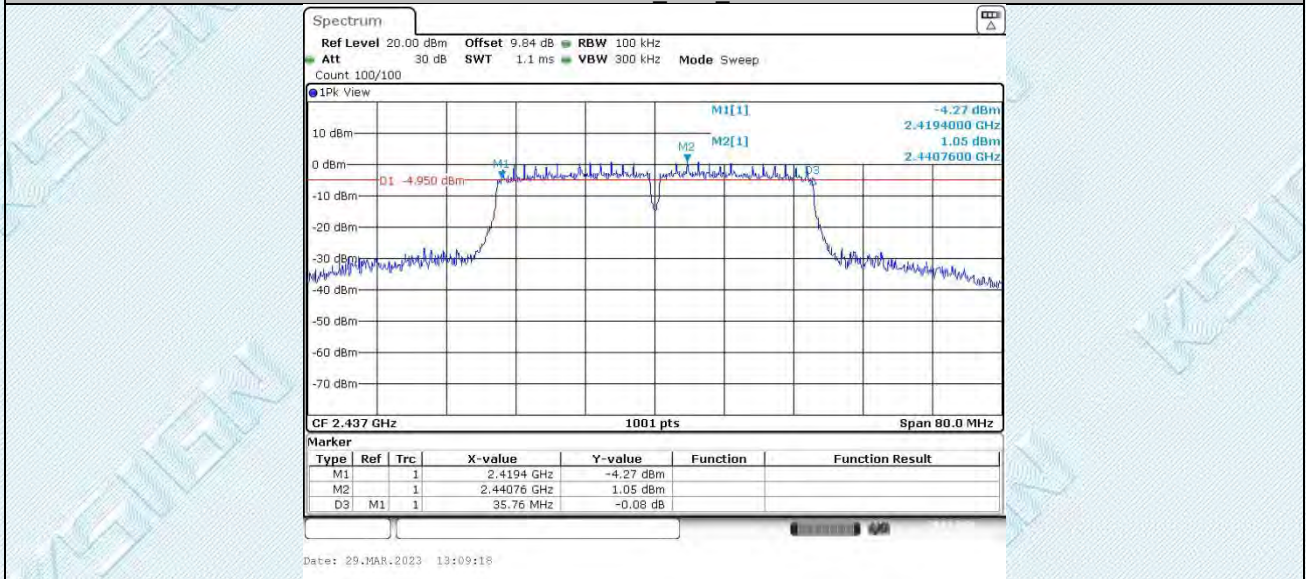

11N40SISO_Ant1_2452

TRF_RF_R1

Add: West Side of 1/F., Building C, Zone A, Fuyuan New Factory, Jiujiu Industrial Park, Minzhu, Shatou, Shajing, Bao'an District, Shenzhen, Guangdong, China

Tel: +(86) 0755-2985 2678 Fax: +(86) 0755-2985 2397 E-mail: info@gdksign.cn Web: www.gdksign.com

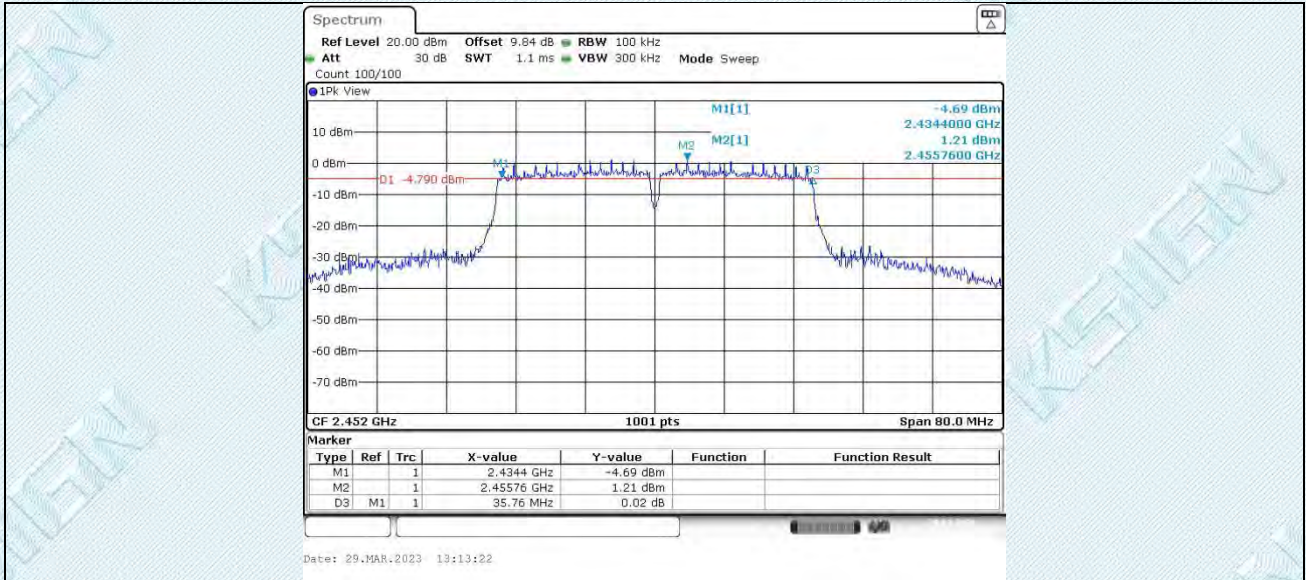

TRF_RF_R1

Add: West Side of 1/F., Building C, Zone A, Fuyuan New Factory, Jiujiu Industrial Park, Minzhu, Shatou, Shajing, Bao'an District, Shenzhen, Guangdong, China

Tel: +(86) 0755-2985 2678 Fax: +(86) 0755-2985 2397 E-mail: info@gdksign.cn Web: www.gdksign.com

6.2. Appendix B: Occupied Channel Bandwidth

6.2.1. Test Result

TestMode	Antenna	Channel Frequency[MHz]	OCB [MHz]	FL[MHz]	FH[MHz]	Limit[MHz]	Verdict
11B	Ant1	2412	15.145	2404.408	2419.552	---	PASS
		2437	15.105	2429.448	2444.552	---	PASS
		2462	15.105	2454.408	2469.512	---	PASS
11G	Ant1	2412	17.702	2403.089	2420.791	---	PASS
		2437	17.942	2427.969	2445.911	---	PASS
		2462	17.982	2452.929	2470.911	---	PASS
11N20SISO	Ant1	2412	18.581	2402.689	2421.271	---	PASS
		2437	18.581	2427.689	2446.271	---	PASS
		2462	18.581	2452.689	2471.271	---	PASS
11N40SISO	Ant1	2422	36.843	2403.538	2440.382	---	PASS
		2437	36.843	2418.538	2455.382	---	PASS
		2452	36.763	2433.538	2470.302	---	PASS

6.2.2. Test Graphs



TRF_RF_R1

Add: West Side of 1/F., Building C, Zone A, Fuyuan New Factory, Jiujiu Industrial Park, Minzhu, Shatou, Shajing, Bao'an District, Shenzhen, Guangdong, China

Tel: +(86) 0755-2985 2678 Fax: +(86) 0755-2985 2397 E-mail: info@gdksign.cn Web: www.gdksign.com

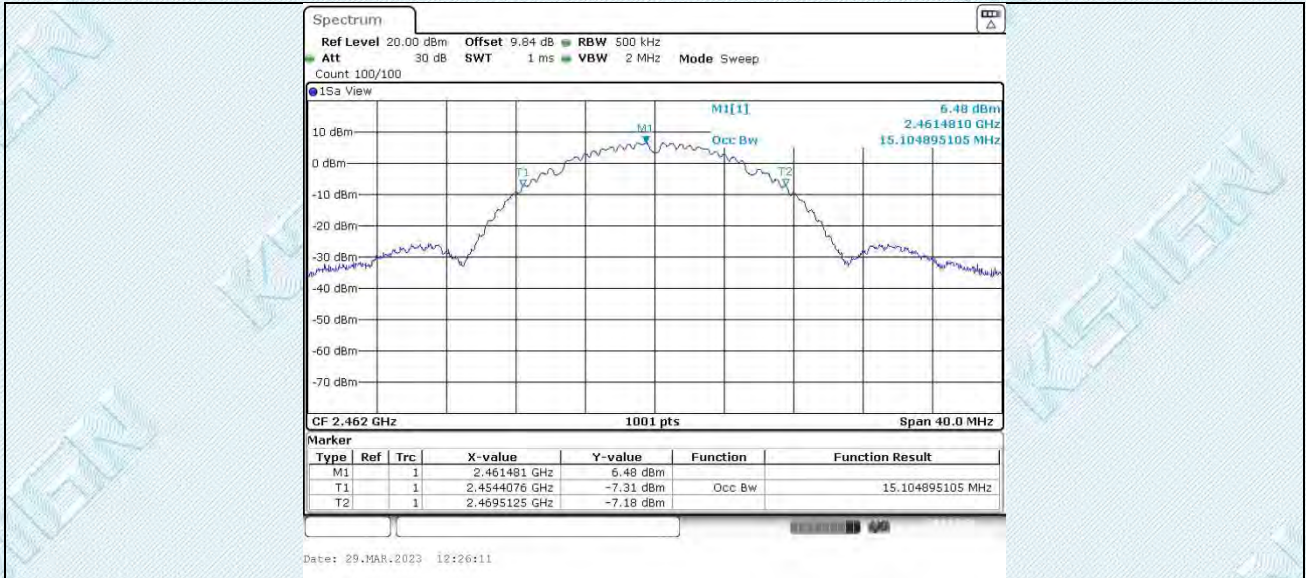

11G Ant1_2412

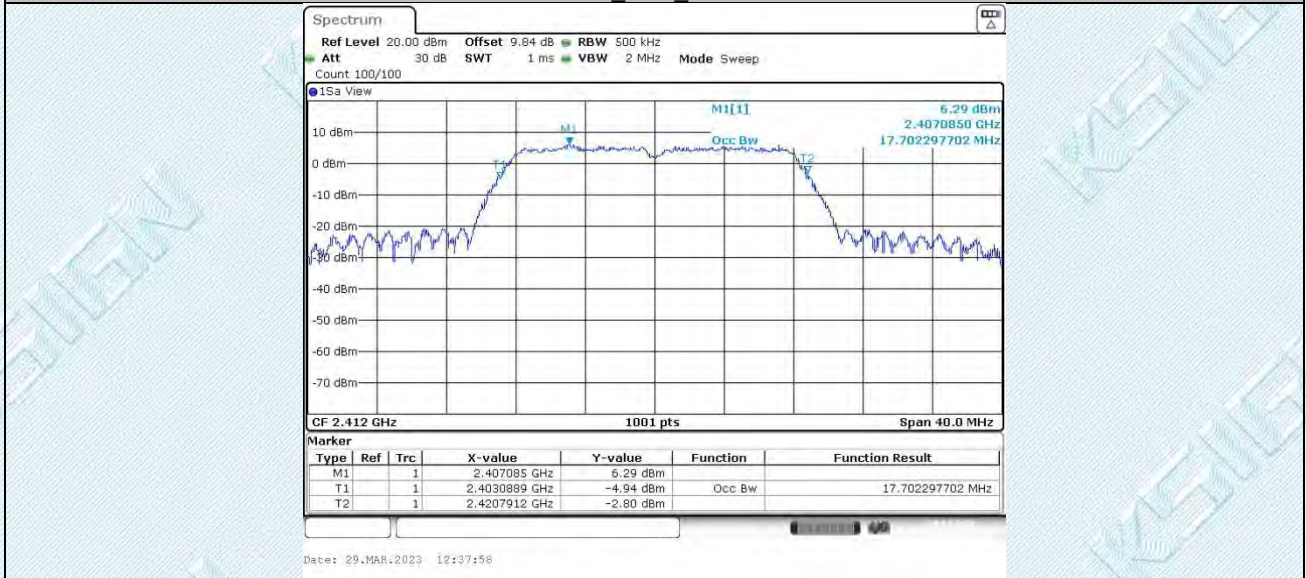

11G Ant1_2437

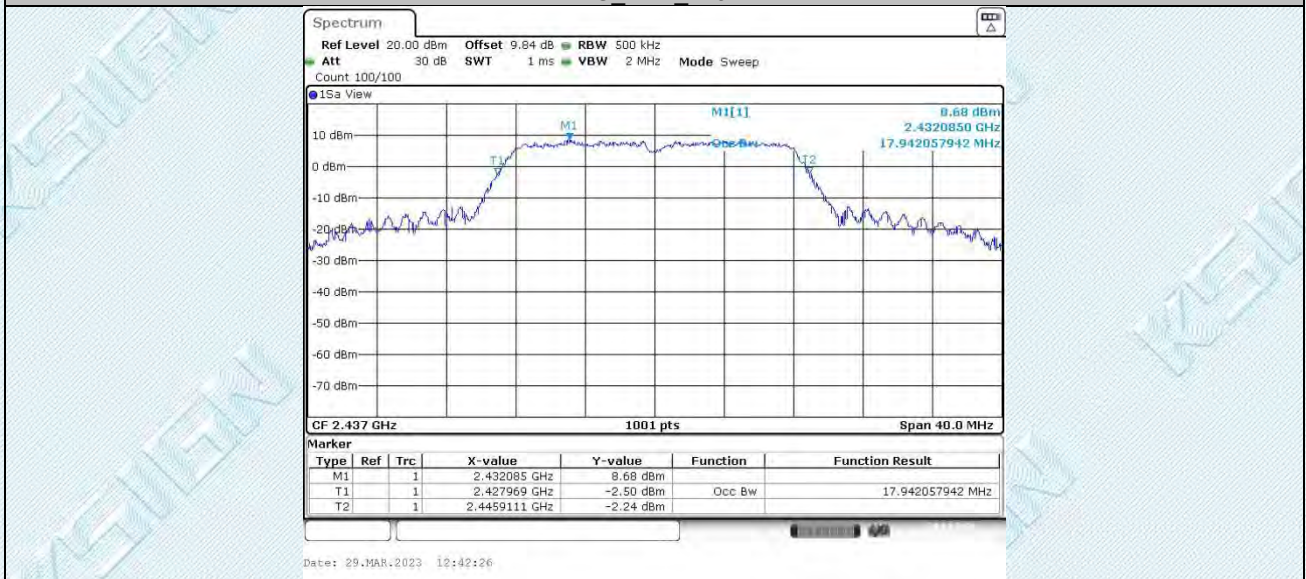

11G Ant1_2462

TRF_RF_R1

Add: West Side of 1/F., Building C, Zone A, Fuyuan New Factory, Jiujiu Industrial Park, Minzhu, Shatou, Shajing, Bao'an District, Shenzhen, Guangdong, China

Tel: +(86) 0755-2985 2678 Fax: +(86) 0755-2985 2397 E-mail: info@gdksign.cn Web: www.gdksign.com

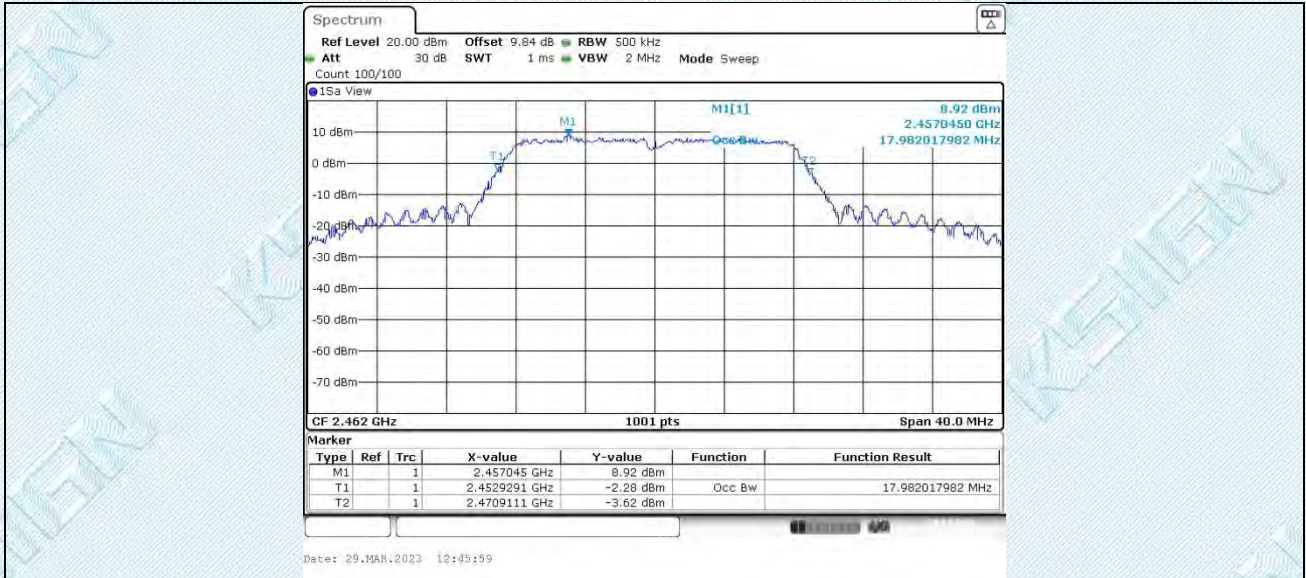

11N20SISO_Ant1_2412

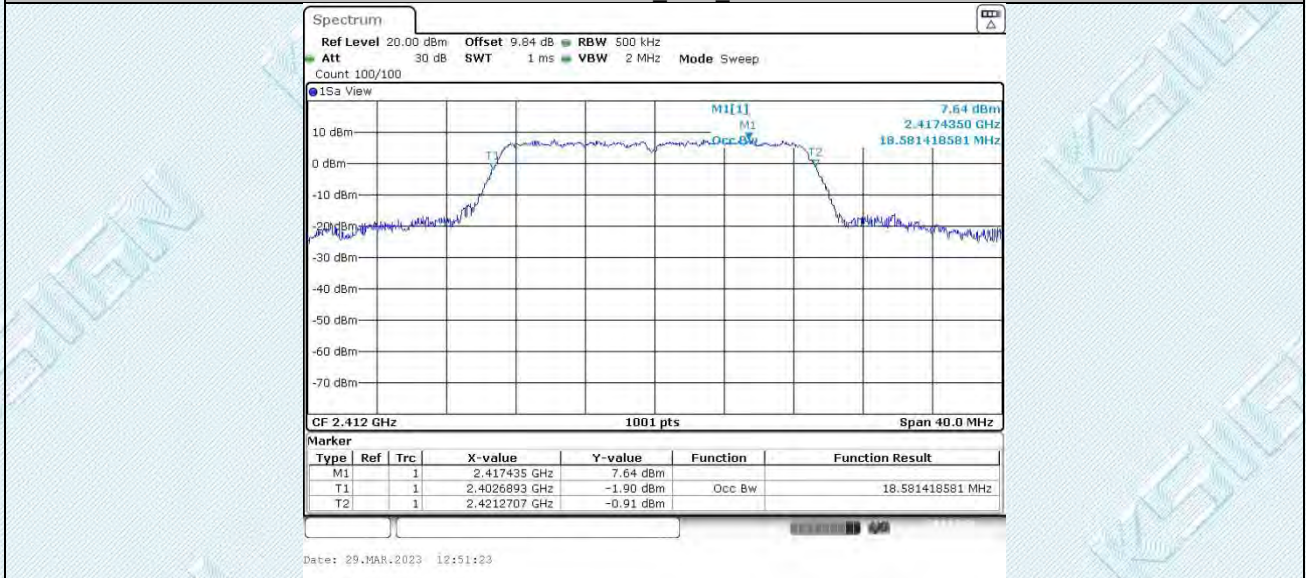

11N20SISO_Ant1_2437

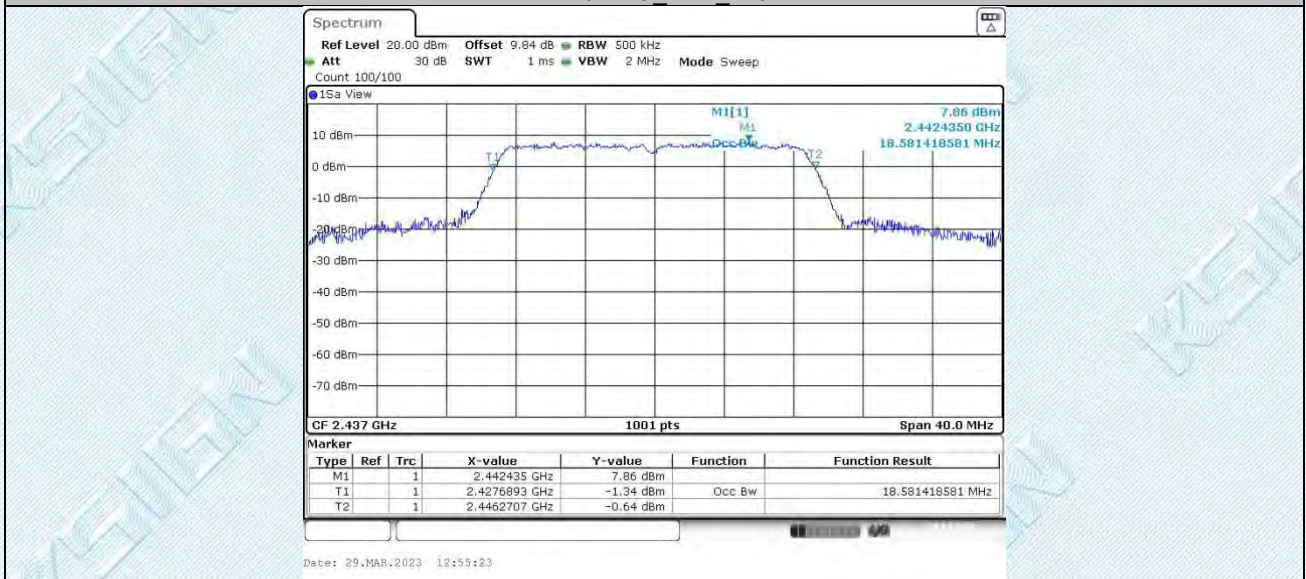

11N20SISO_Ant1_2462

TRF_RF_R1

Add: West Side of 1/F., Building C, Zone A, Fuyuan New Factory, Jiujiu Industrial Park, Minzhu, Shatou, Shajing, Bao'an District, Shenzhen, Guangdong, China

Tel: +(86) 0755-2985 2678 Fax: +(86) 0755-2985 2397 E-mail: info@gdksign.cn Web: www.gdksign.com

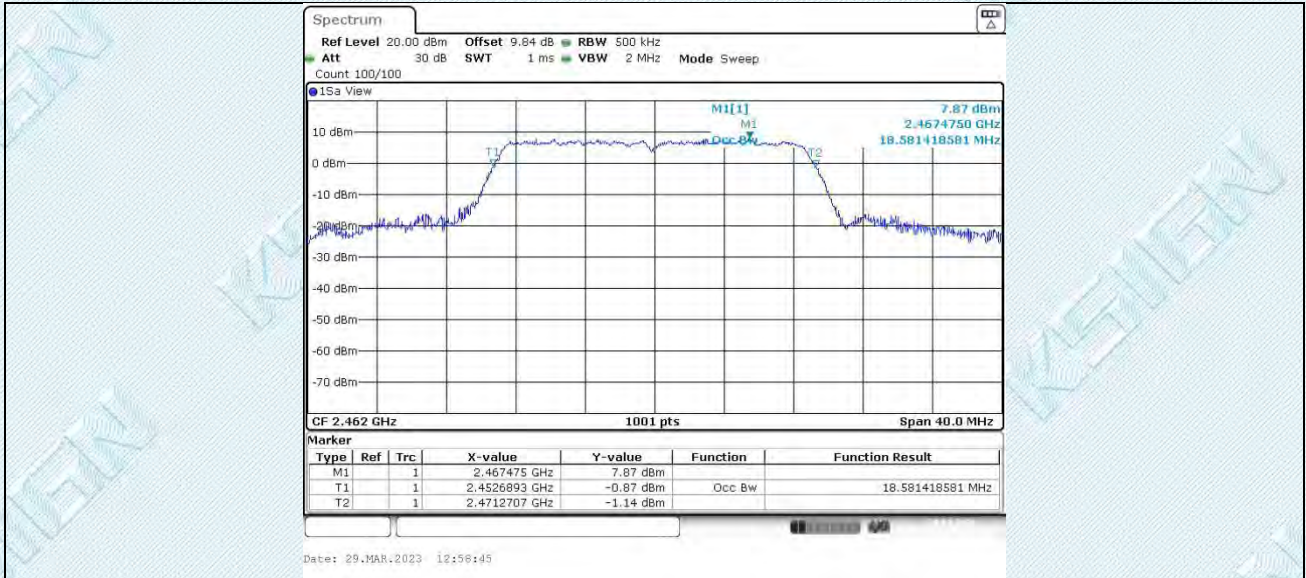

11N40SISO Ant1_2422

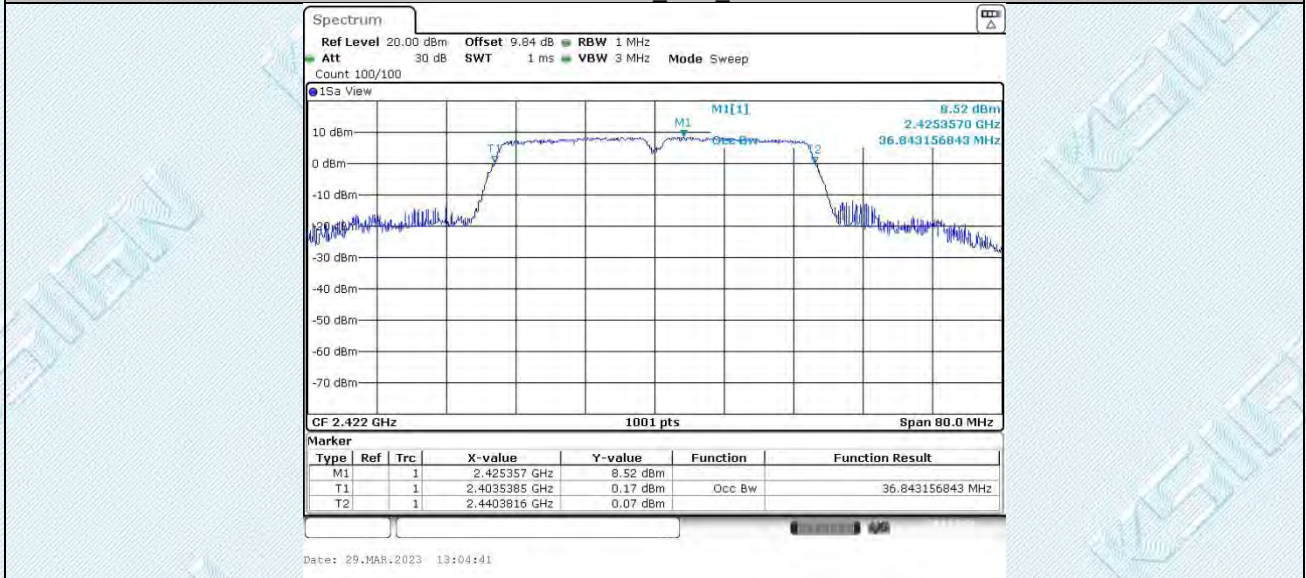

11N40SISO Ant1_2437

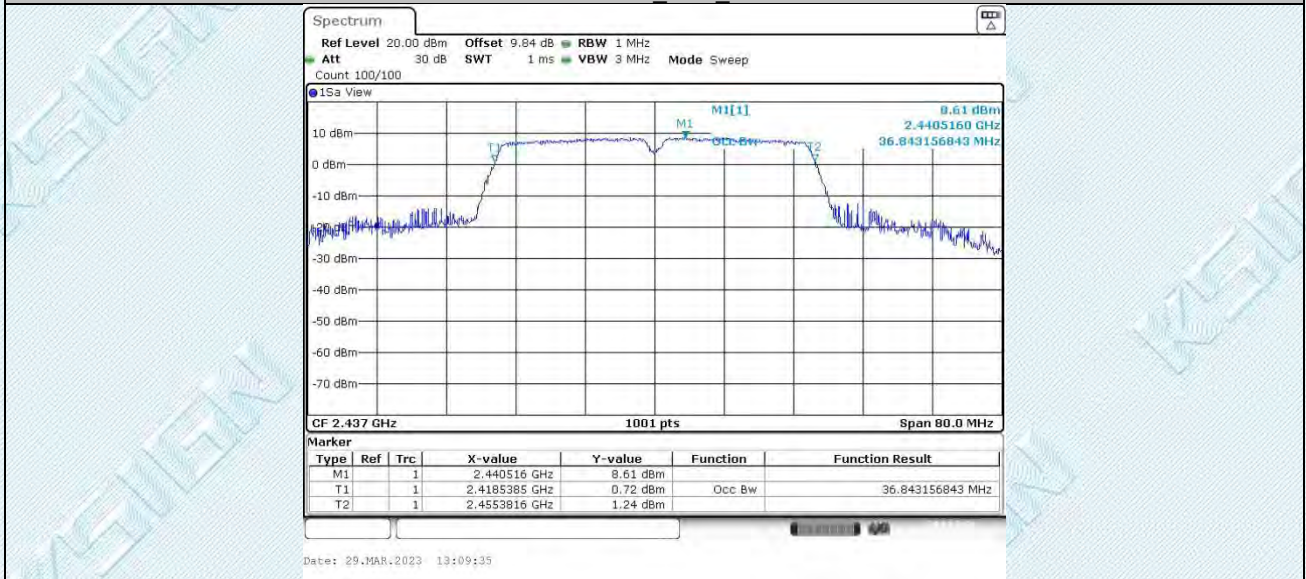

11N40SISO Ant1_2452

TRF_RF_R1

Add: West Side of 1/F., Building C, Zone A, Fuyuan New Factory, Jiujiu Industrial Park, Minzhu, Shatou, Shajing, Bao'an District, Shenzhen, Guangdong, China

Tel: +(86) 0755-2985 2678 Fax: +(86) 0755-2985 2397 E-mail: info@gdksign.cn Web: www.gdksign.com

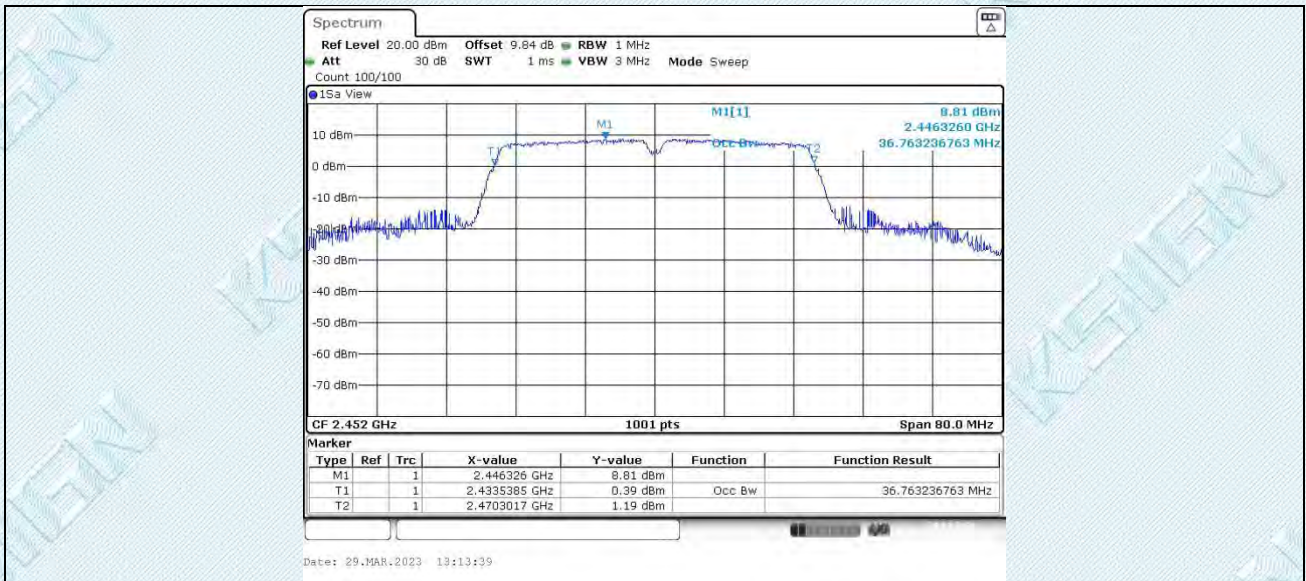

TRF_RF_R1

Add: West Side of 1/F., Building C, Zone A, Fuyuan New Factory, Jiujiu Industrial Park, Minzhu, Shatou, Shajing, Bao'an District, Shenzhen, Guangdong, China

Tel: +(86) 0755-2985 2678 Fax: +(86) 0755-2985 2397 E-mail: info@gdksign.cn Web: www.gdksign.com

6.3. Appendix C: Maximum conducted output power

6.3.1. Test Result Peak

TestMode	Antenna	Frequency [MHz]	Peak Power [dBm]	Conducted Limit [dBm]	Verdict
11B	Ant1	2412	17.45	≤30.00	PASS
		2437	17.52	≤30.00	PASS
		2462	17.45	≤30.00	PASS
11G	Ant1	2412	19.02	≤30.00	PASS
		2437	21.52	≤30.00	PASS
		2462	21.61	≤30.00	PASS
11N20SISO	Ant1	2412	21.36	≤30.00	PASS
		2437	21.52	≤30.00	PASS
		2462	21.54	≤30.00	PASS
11N40SISO	Ant1	2422	21.38	≤30.00	PASS
		2437	21.53	≤30.00	PASS
		2452	21.55	≤30.00	PASS

6.3.2. Test Graphs Peak



TRF_RF_R1

Add: West Side of 1/F., Building C, Zone A, Fuyuan New Factory, Jiujiu Industrial Park, Minzhu, Shatou, Shajing, Bao'an District, Shenzhen, Guangdong, China

Tel: +(86) 0755-2985 2678 Fax: +(86) 0755-2985 2397 E-mail: info@gdksign.cn Web: www.gdksign.com

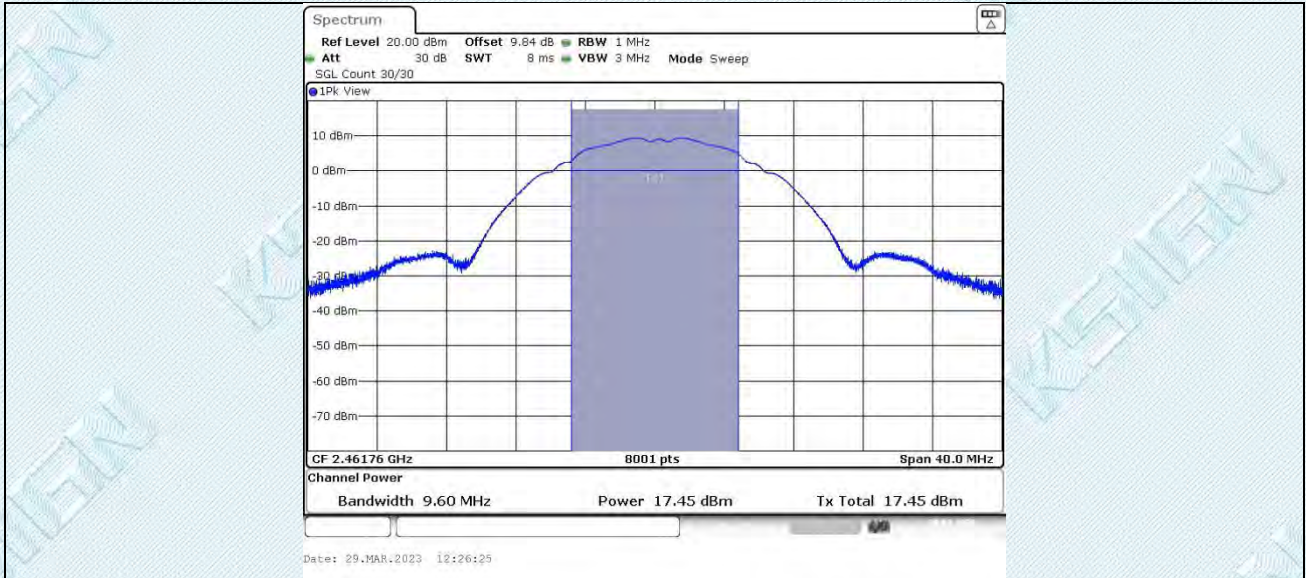

11G Ant1_2412

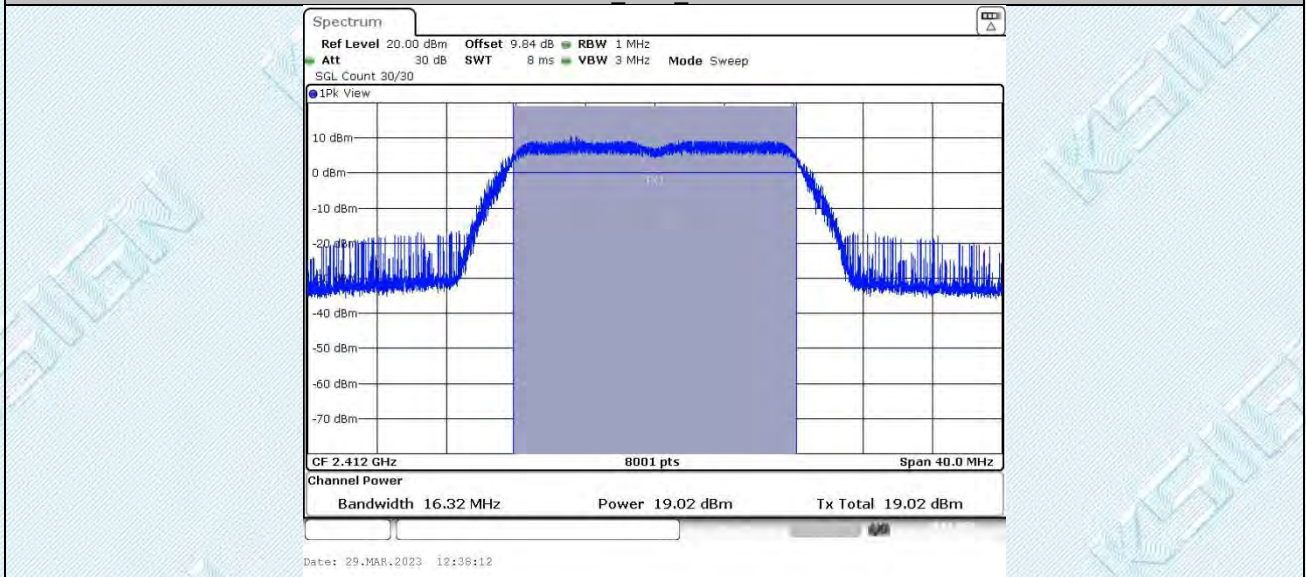

11G Ant1_2437

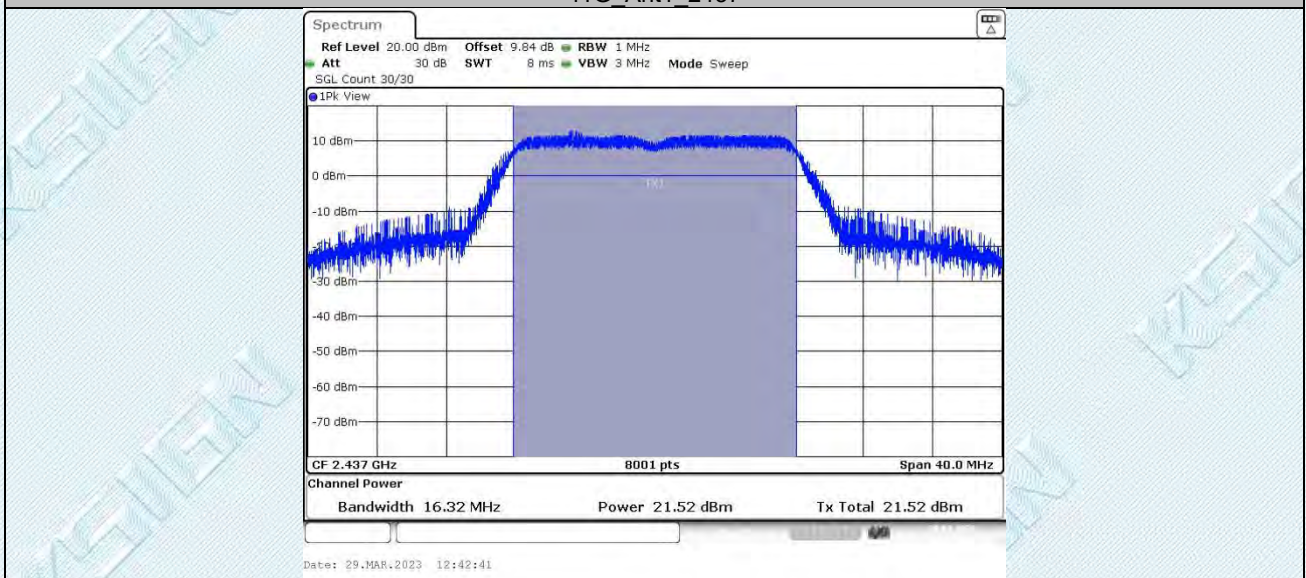

11G Ant1_2462

TRF RF_R1

Add: West Side of 1/F., Building C, Zone A, Fuyuan New Factory, Jiujiu Industrial Park, Minzhu, Shatou, Shajing, Bao'an District, Shenzhen, Guangdong, China

Tel: +(86) 0755-2985 2678 Fax: +(86) 0755-2985 2397 E-mail: info@gdkesign.cn Web: www.gdkesign.com

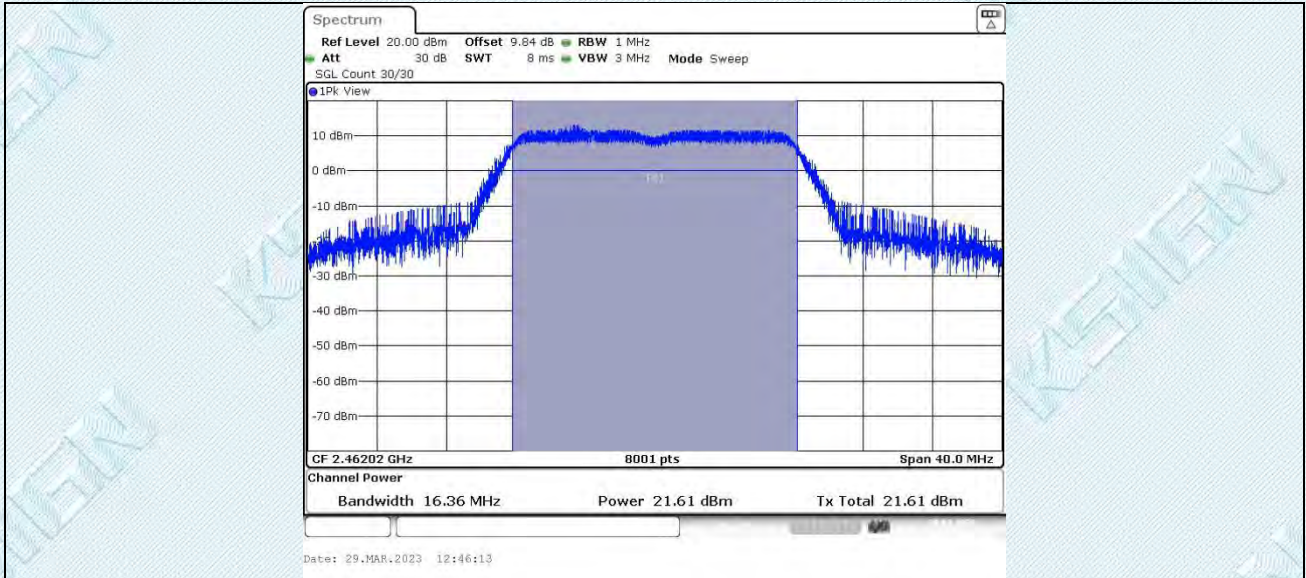

11N20SISO_Ant1_2412

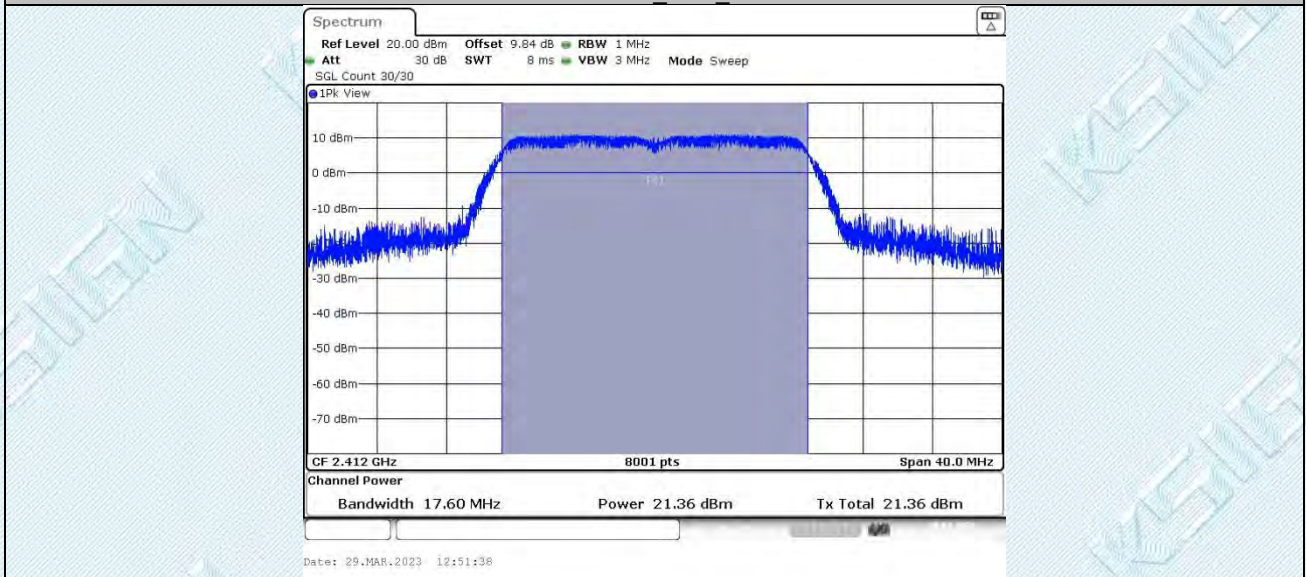

11N20SISO_Ant1_2437

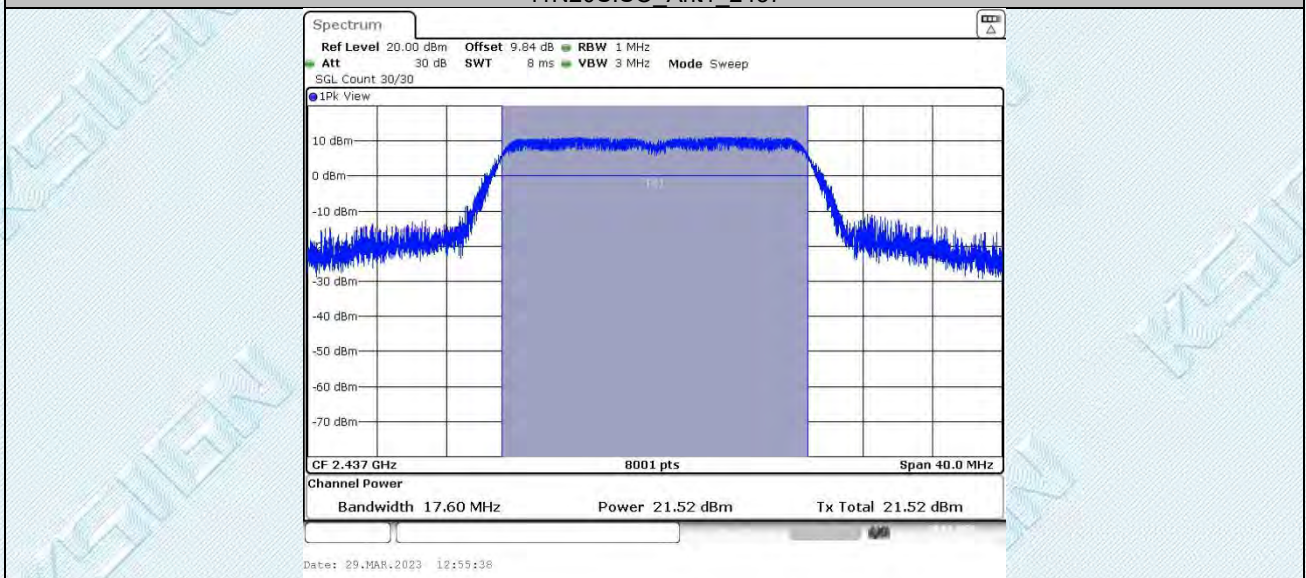

11N20SISO_Ant1_2462

TRF_RF_R1

Add: West Side of 1/F., Building C, Zone A, Fuyuan New Factory, Jiujiu Industrial Park, Minzhu, Shatou, Shajing, Bao'an District, Shenzhen, Guangdong, China

Tel: +(86) 0755-2985 2678 Fax: +(86) 0755-2985 2397 E-mail: info@gdksign.cn Web: www.gdksign.com

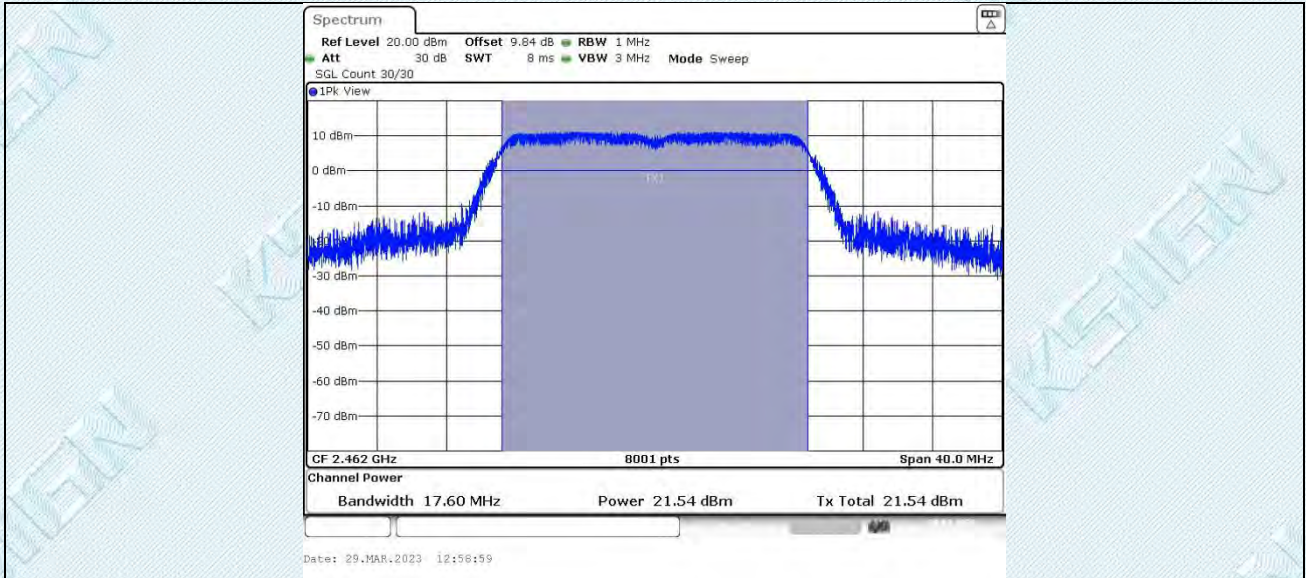

11N40SISO_Ant1_2422

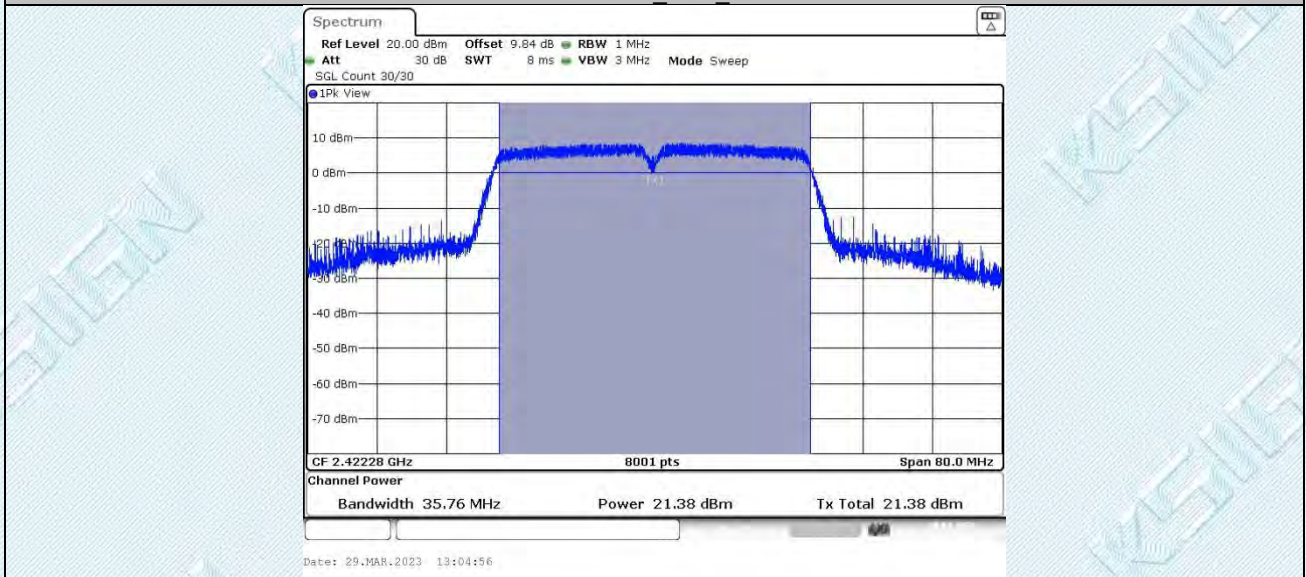

11N40SISO_Ant1_2437

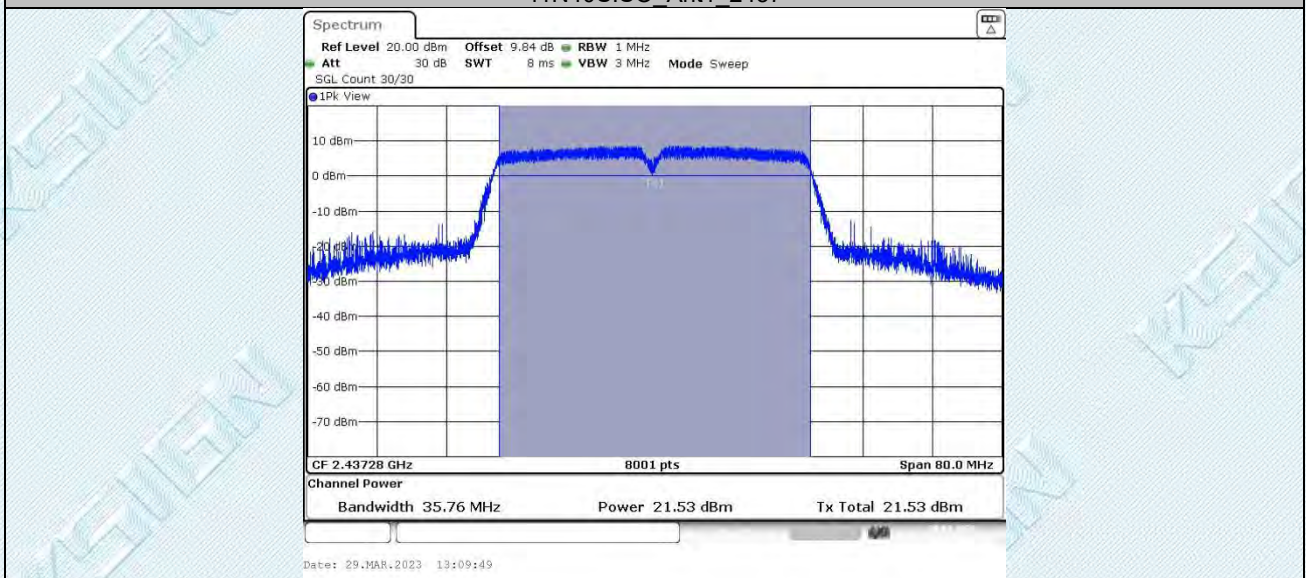

11N40SISO_Ant1_2452

TRF_RF_R1

Add: West Side of 1/F., Building C, Zone A, Fuyuan New Factory, Jiujiu Industrial Park, Minzhu, Shatou, Shajing, Bao'an District, Shenzhen, Guangdong, China

Tel: +(86) 0755-2985 2678 Fax: +(86) 0755-2985 2397 E-mail: info@gdksign.cn Web: www.gdksign.com

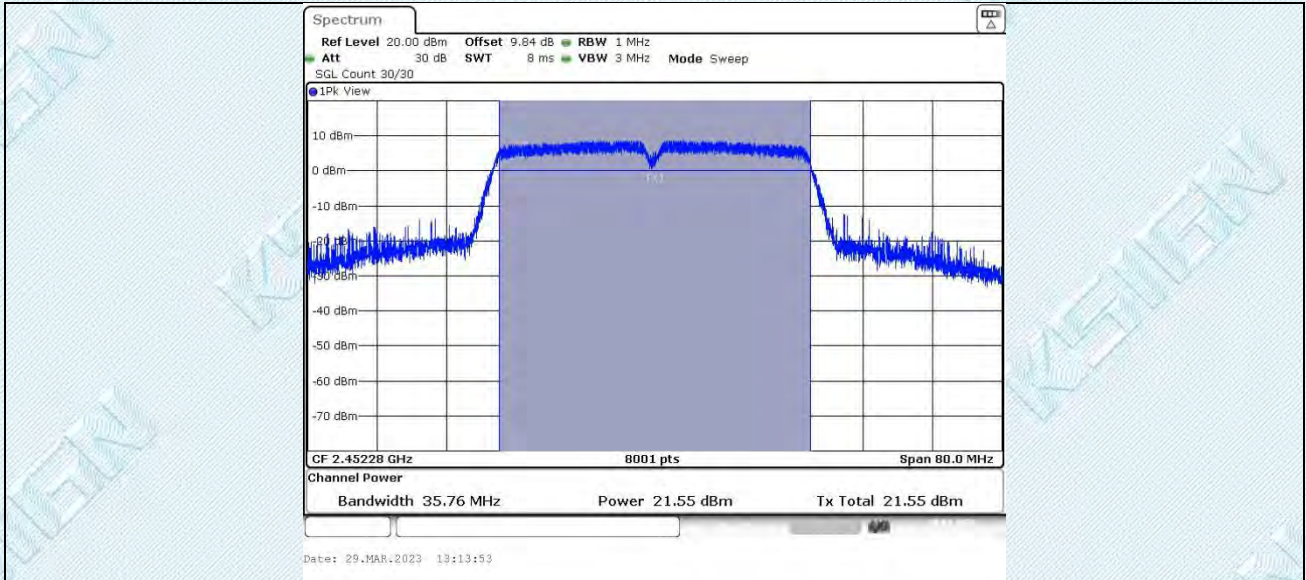

TRF_RF_R1

Add: West Side of 1/F., Building C, Zone A, Fuyuan New Factory, Jiujiu Industrial Park, Minzhu, Shatou, Shajing, Bao'an District, Shenzhen, Guangdong, China

Tel: +(86) 0755-2985 2678 Fax: +(86) 0755-2985 2397 E-mail: info@gdksign.cn Web: www.gdksign.com

6.4. Appendix D: Maximum power spectral density

6.4.1. Test Result

TestMode	Antenna	Frequency[MHz]	Result[dBm/3kHz]	Limit[dBm/3kHz]	Verdict
11B	Ant1	2412	-11.16	≤8.00	PASS
		2437	-11.25	≤8.00	PASS
		2462	-11.37	≤8.00	PASS
11G	Ant1	2412	-14.51	≤8.00	PASS
		2437	-11.97	≤8.00	PASS
		2462	-11.77	≤8.00	PASS
11N20SISO	Ant1	2412	-12.34	≤8.00	PASS
		2437	-12.39	≤8.00	PASS
		2462	-12.48	≤8.00	PASS
11N40SISO	Ant1	2422	-14.37	≤8.00	PASS
		2437	-13.5	≤8.00	PASS
		2452	-12.94	≤8.00	PASS

6.4.2. Test Graphs



TRF RF_R1

Add: West Side of 1/F., Building C, Zone A, Fuyuan New Factory, Jiujiu Industrial Park, Minzhu, Shatou, Shajing, Bao'an District, Shenzhen, Guangdong, China

Tel: +(86) 0755-2985 2678 Fax: +(86) 0755-2985 2397 E-mail: info@gdksign.cn Web: www.gdksign.com

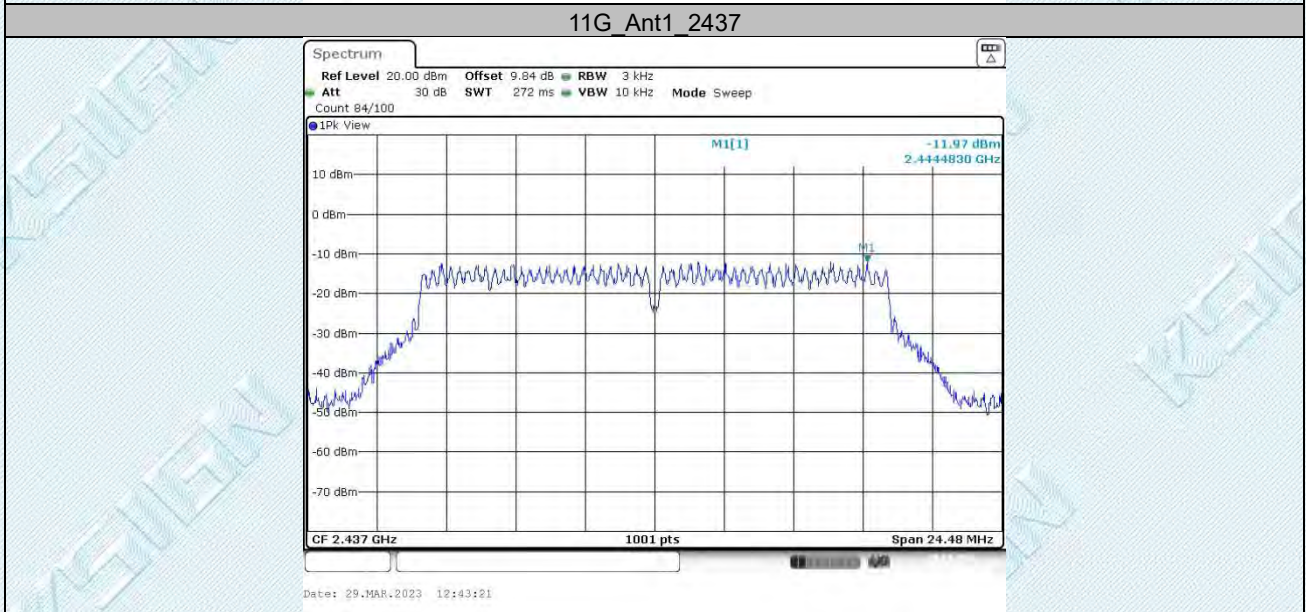
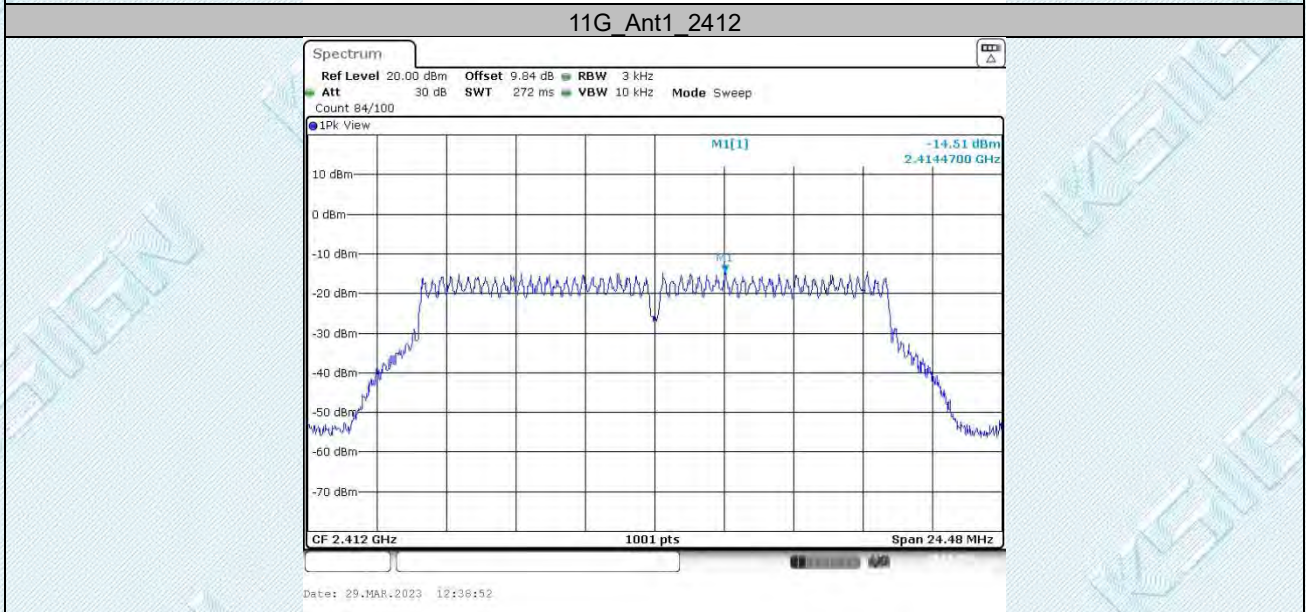
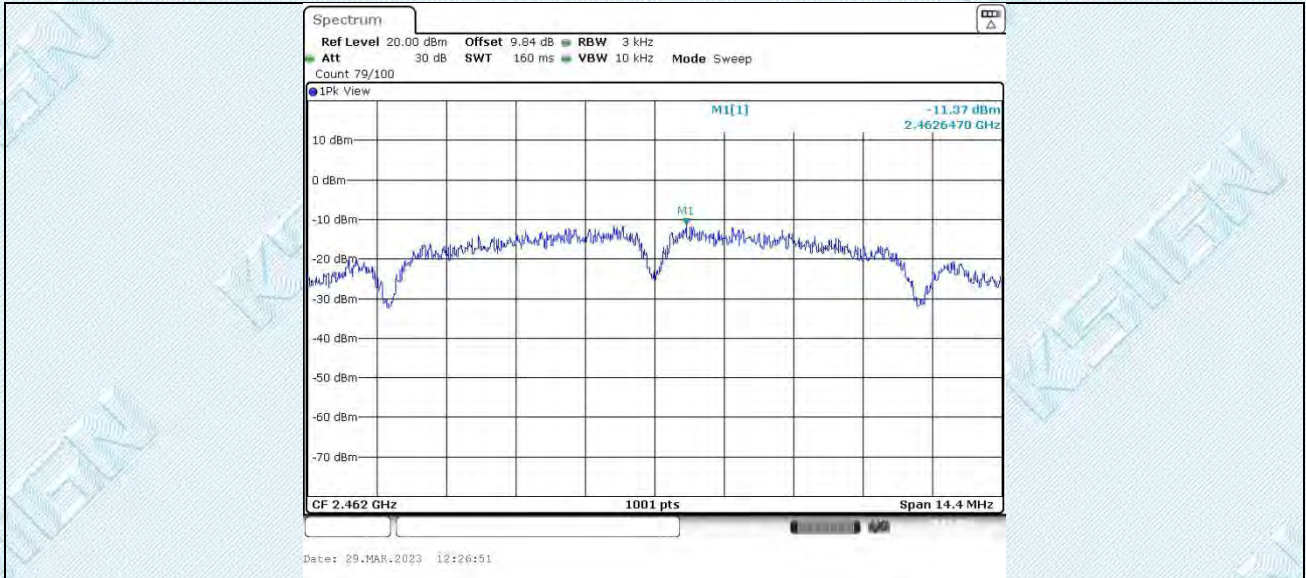

TRF RF_R1

Add: West Side of 1/F., Building C, Zone A, Fuyuan New Factory, Jiujiu Industrial Park, Minzhu, Shatou, Shajing, Bao'an District, Shenzhen, Guangdong, China

Tel: +(86) 0755-2985 2678 Fax: +(86) 0755-2985 2397 E-mail: info@gdksign.cn Web: www.gdksign.com

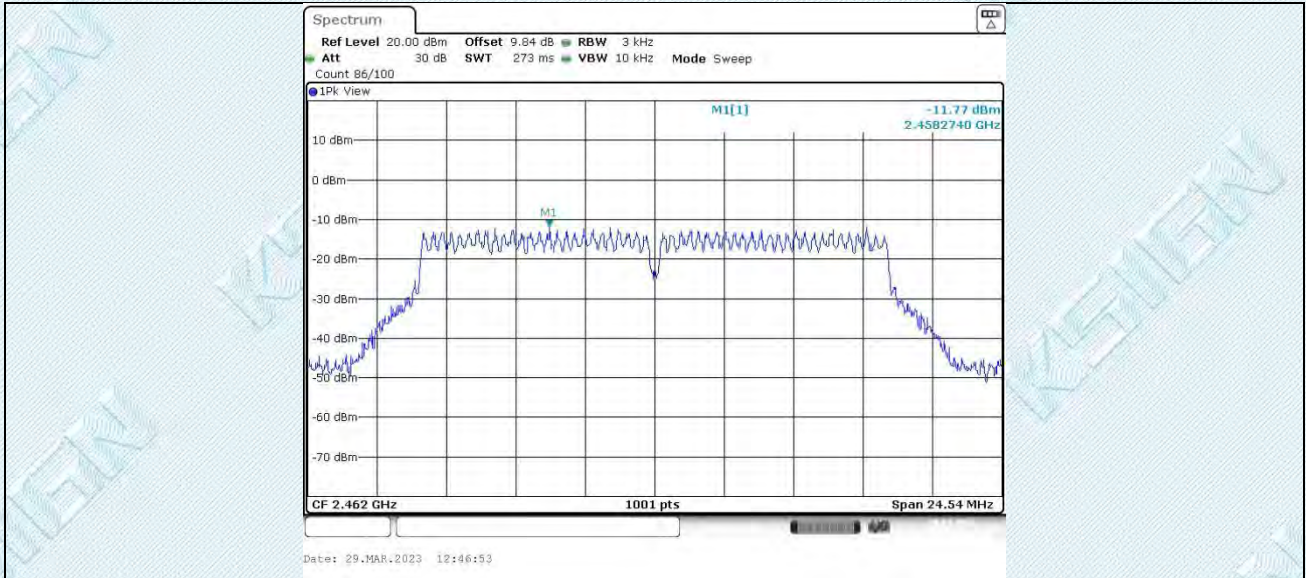

11N20SISO_Ant1_2412

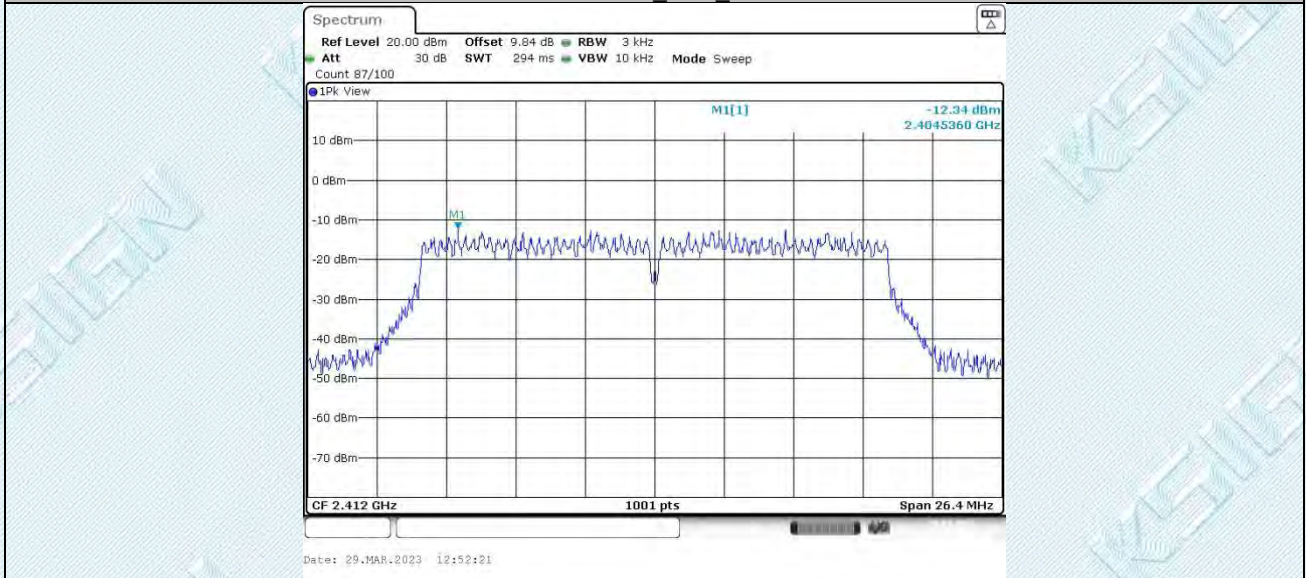

11N20SISO_Ant1_2437

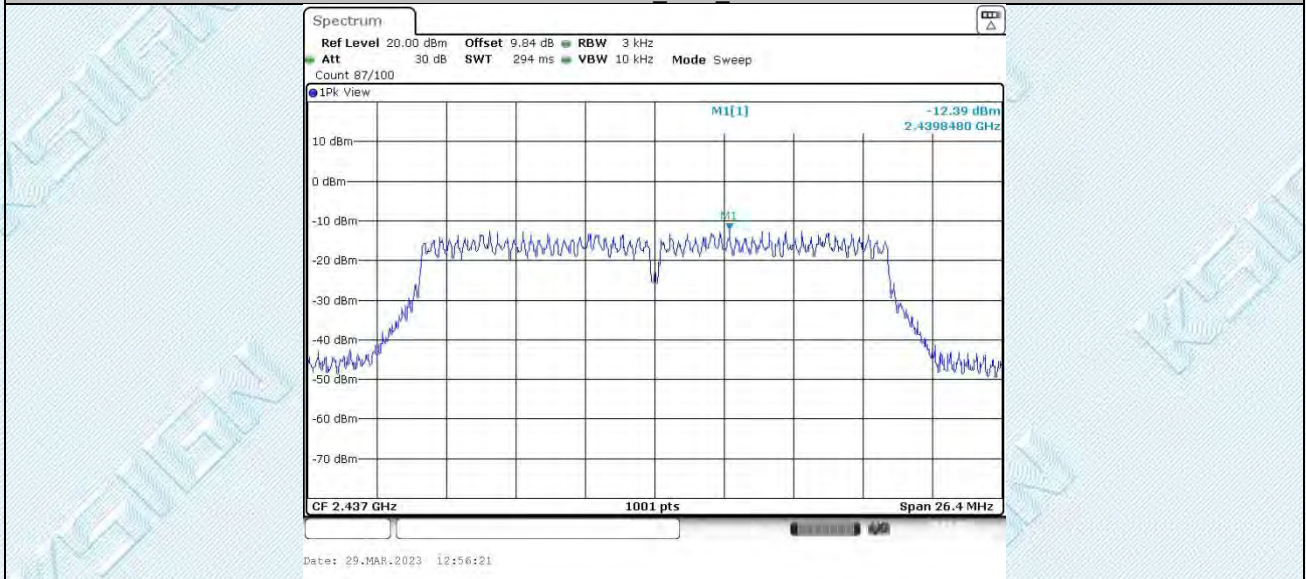

11N20SISO_Ant1_2462

TRF RF_R1

Add: West Side of 1/F., Building C, Zone A, Fuyuan New Factory, Jiujiu Industrial Park, Minzhu, Shatou, Shajing, Bao'an District, Shenzhen, Guangdong, China

Tel: +(86) 0755-2985 2678 Fax: +(86) 0755-2985 2397 E-mail: info@gdksign.cn Web: www.gdksign.com

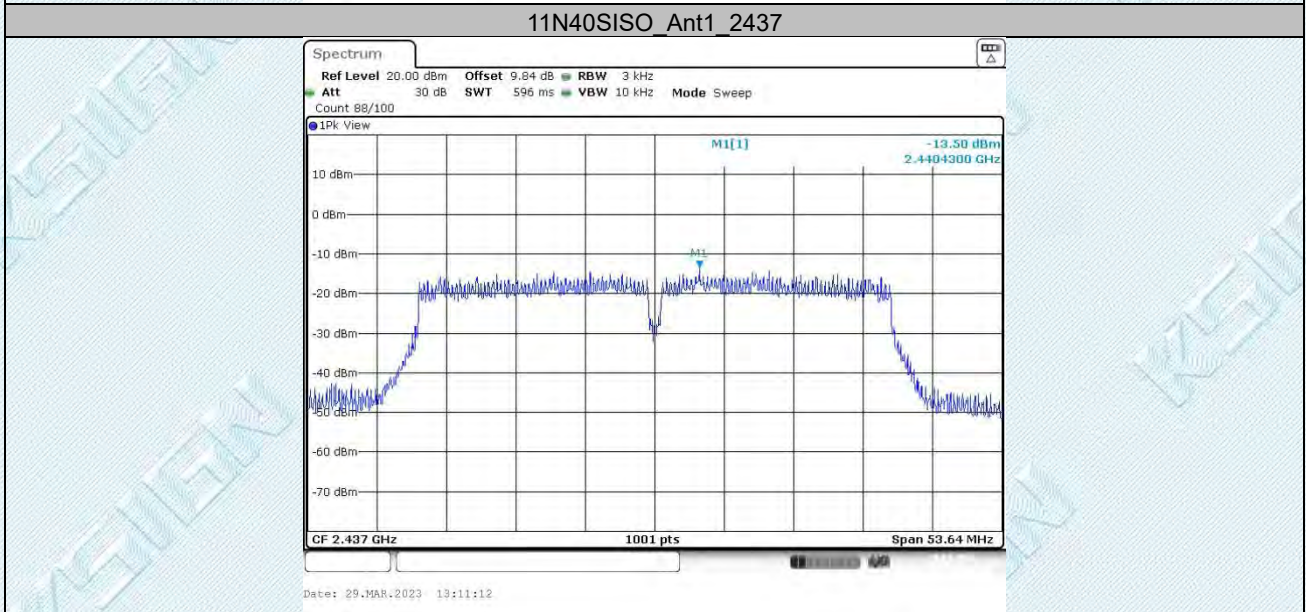
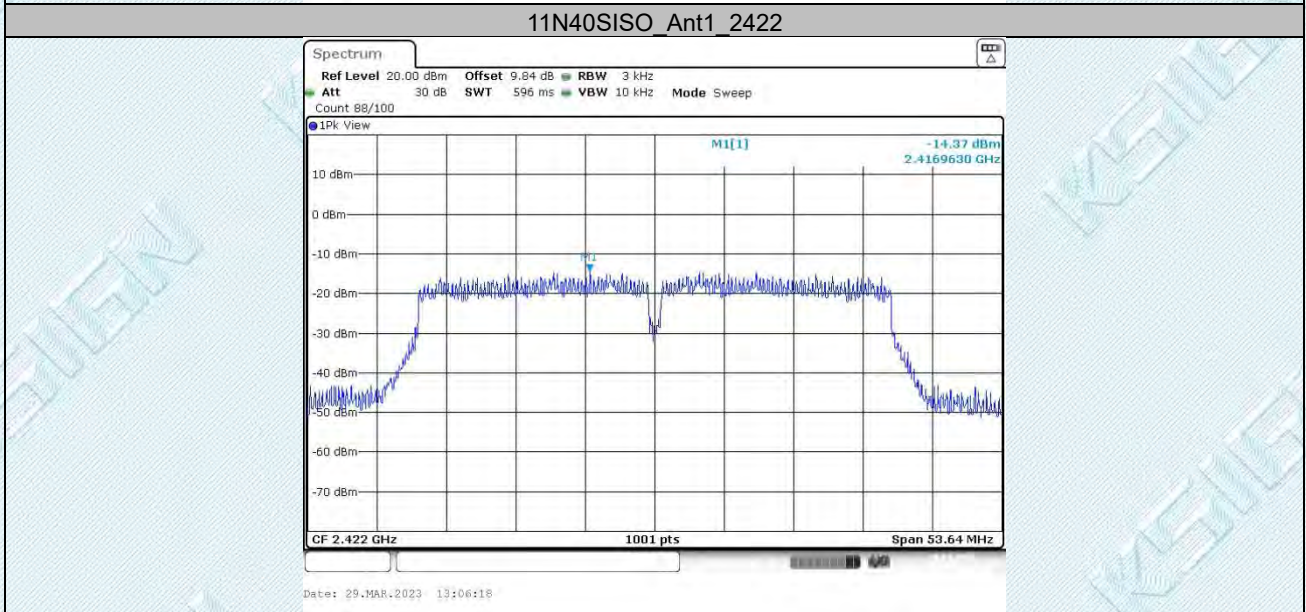
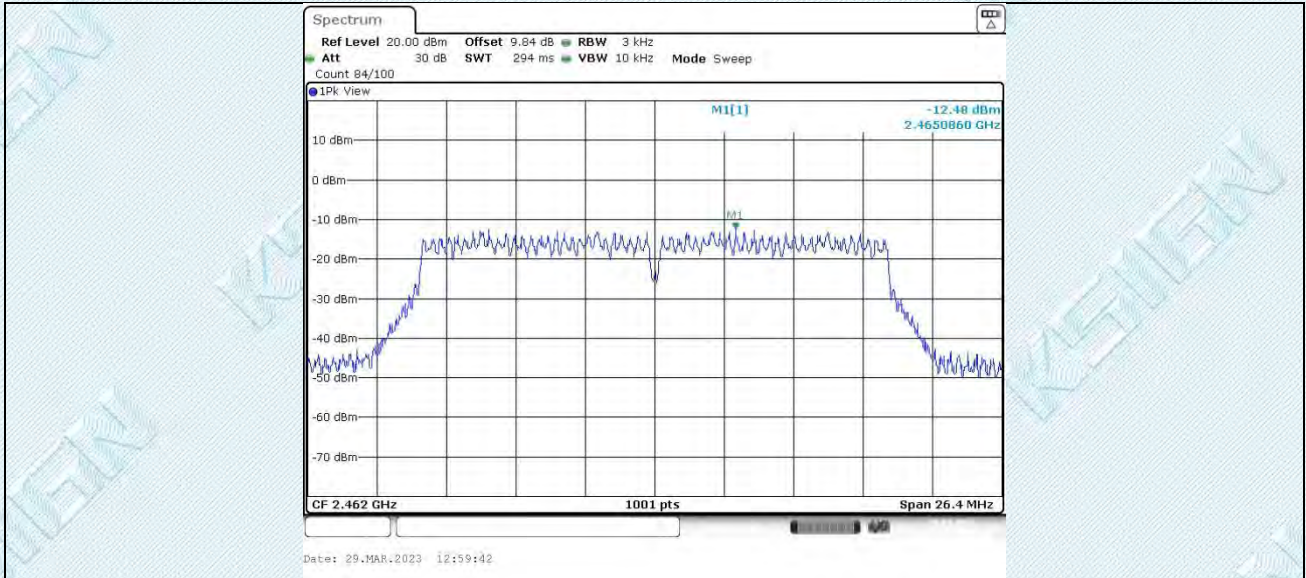

TRF RF_R1

Add: West Side of 1/F., Building C, Zone A, Fuyuan New Factory, Jiujiu Industrial Park, Minzhu, Shatou, Shajing, Bao'an District, Shenzhen, Guangdong, China

Tel: +(86) 0755-2985 2678 Fax: +(86) 0755-2985 2397 E-mail: info@gdksign.cn Web: www.gdksign.com

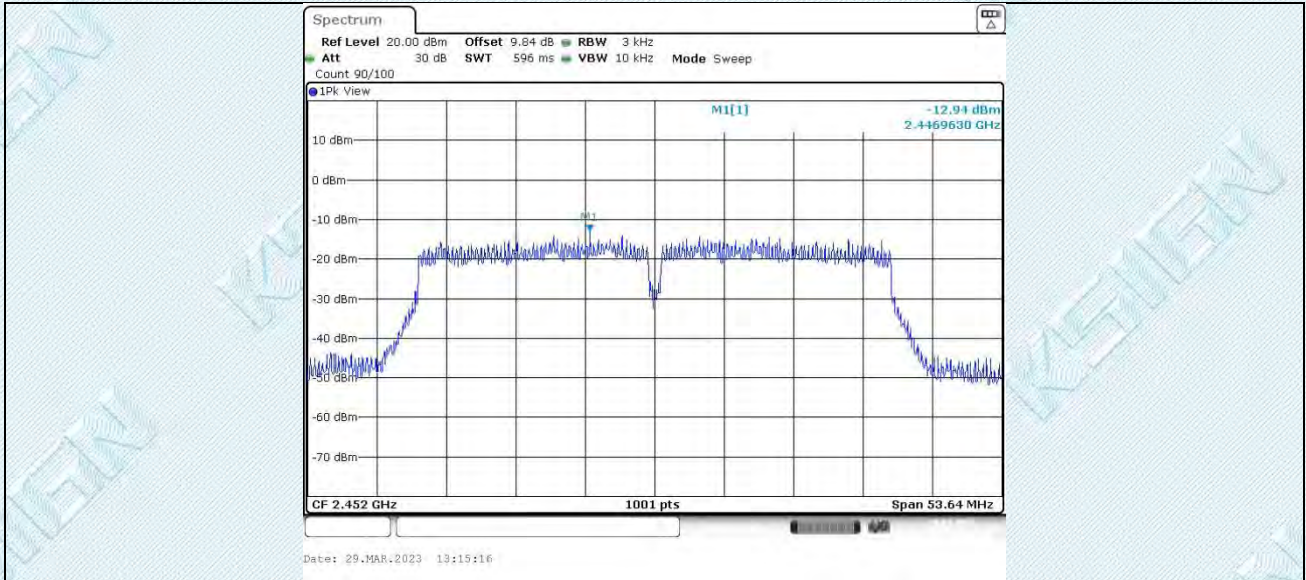

TRF_RF_R1

Add: West Side of 1/F., Building C, Zone A, Fuyuan New Factory, Jiujiu Industrial Park, Minzhu, Shatou, Shajing, Bao'an District, Shenzhen, Guangdong, China

Tel: +(86) 0755-2985 2678 Fax: +(86) 0755-2985 2397 E-mail: info@gdksign.cn Web: www.gdksign.com

6.5. Appendix E: Reference level measurement

6.5.1. Test Result

TestMode	Antenna	Freq[MHz]	Max.Point[MHz]	Result[dBm]
11B	Ant1	2412	2412.50	4.74
		2437	2437.50	4.84
		2462	2462.50	4.85
11G	Ant1	2412	2405.73	1.03
		2437	2442.00	3.73
		2462	2456.99	3.73
11N20SISO	Ant1	2412	2404.51	2.58
		2437	2432.00	3.19
		2462	2455.73	3.43
11N40SISO	Ant1	2422	2425.73	0.88
		2437	2440.73	1.02
		2452	2446.95	1.06

6.5.2. Test Graphs



TRF RF_R1

Add: West Side of 1/F., Building C, Zone A, Fuyuan New Factory, Jiujiu Industrial Park, Minzhu, Shatou, Shajing, Bao'an District, Shenzhen, Guangdong, China

Tel: +(86) 0755-2985 2678 Fax: +(86) 0755-2985 2397 E-mail: info@gdksign.cn Web: www.gdksign.com

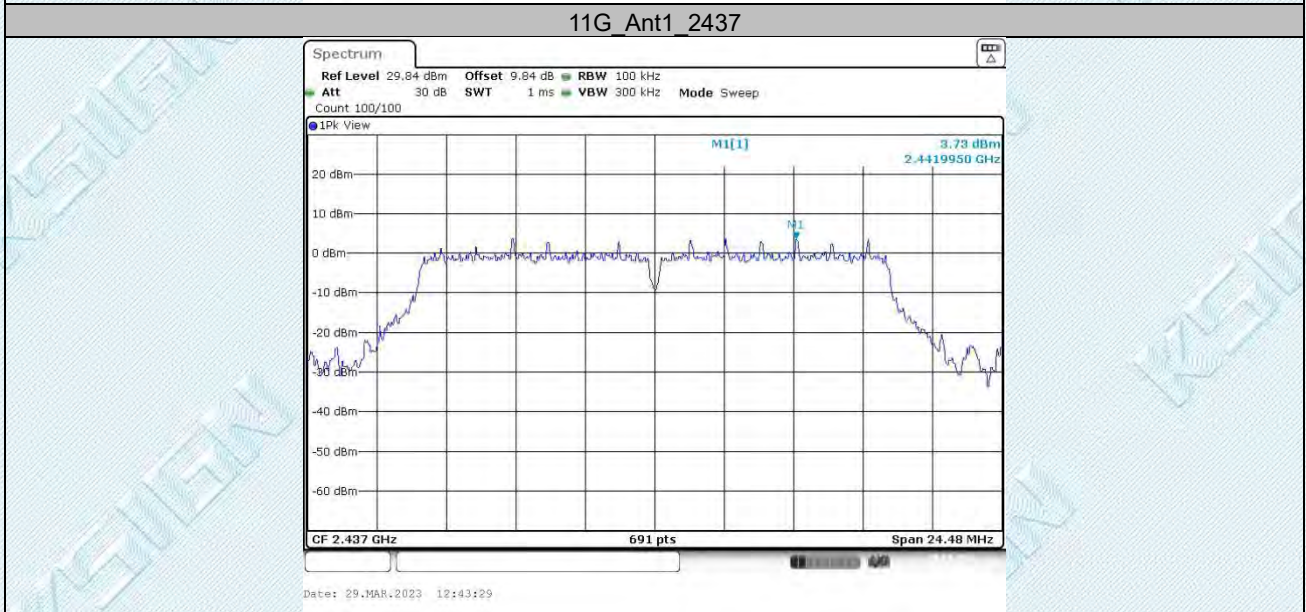
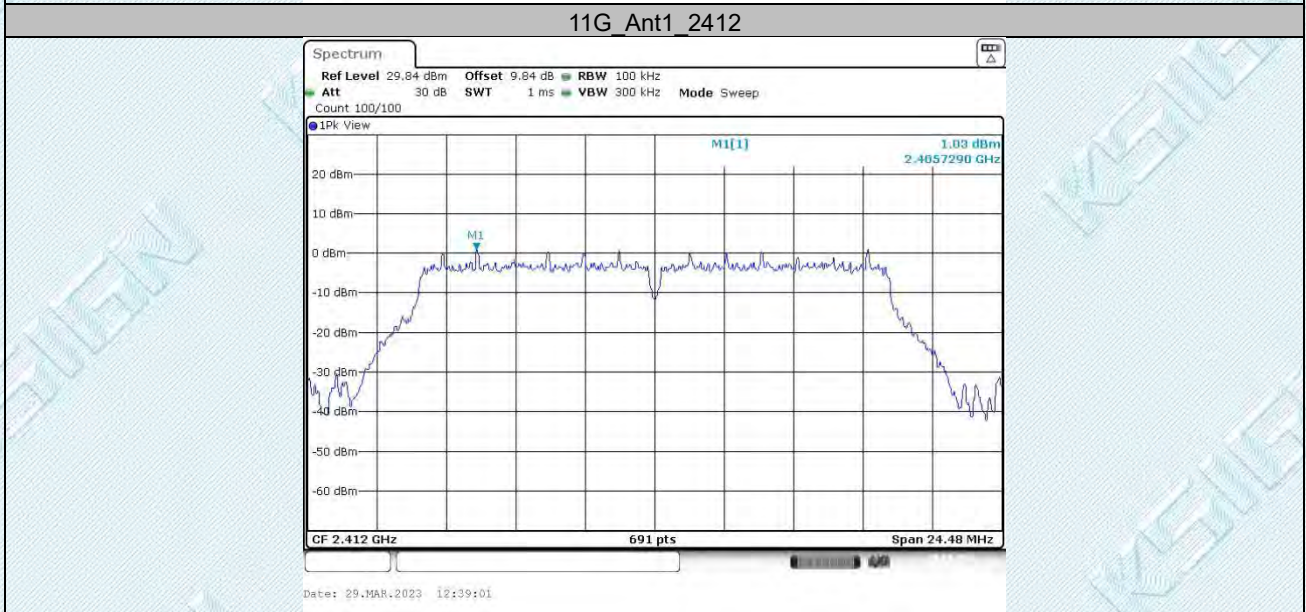
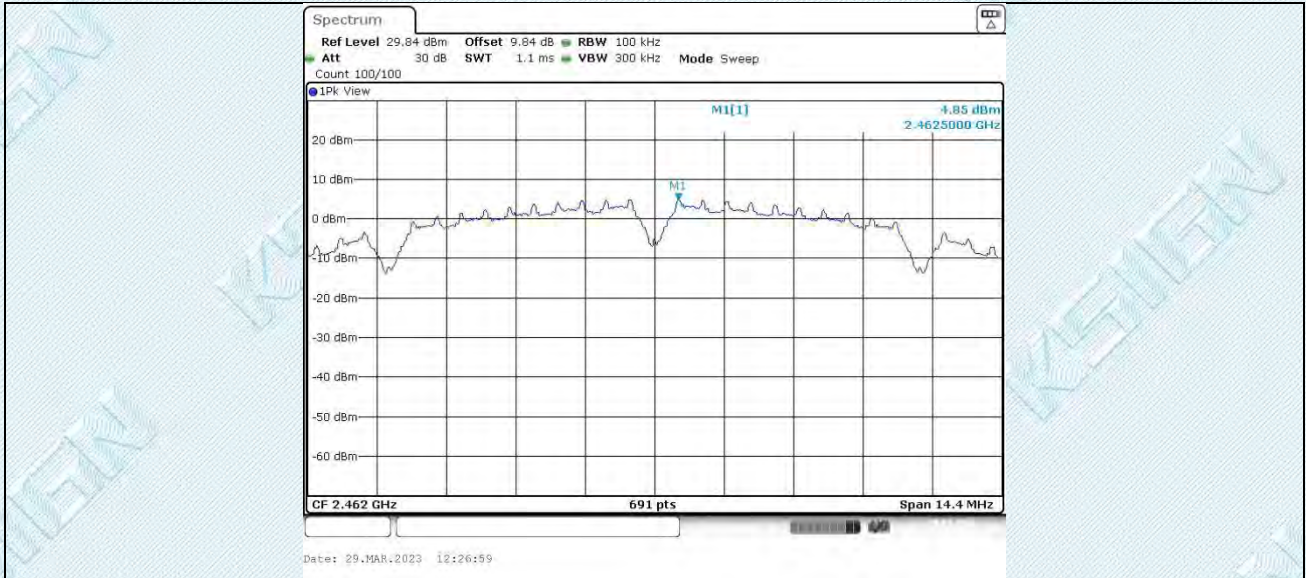

TRF RF_R1

Add: West Side of 1/F., Building C, Zone A, Fuyuan New Factory, Jiujiu Industrial Park, Minzhu, Shatou, Shajing, Bao'an District, Shenzhen, Guangdong, China

Tel: +(86) 0755-2985 2678 Fax: +(86) 0755-2985 2397 E-mail: info@gdksign.cn Web: www.gdksign.com

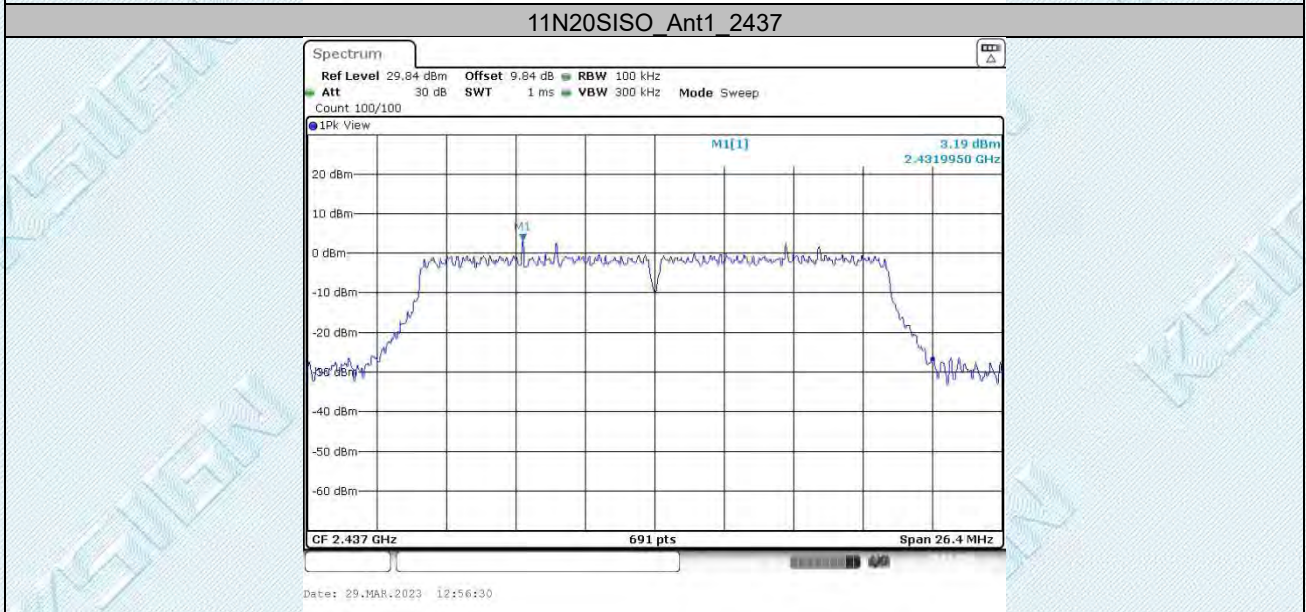
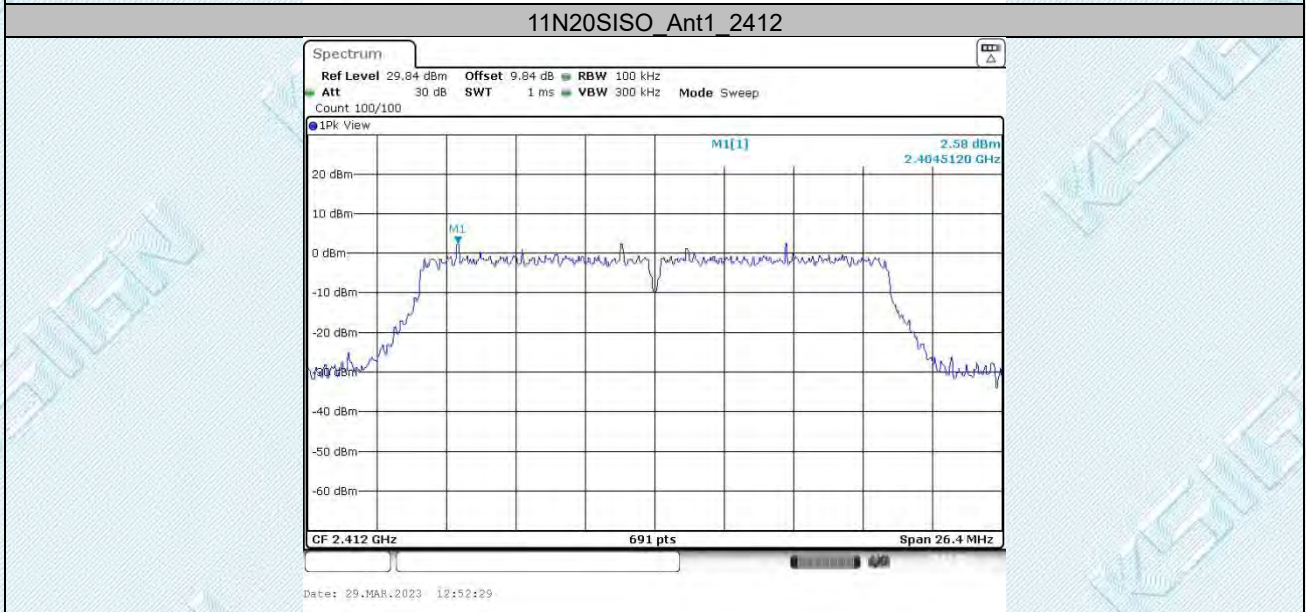
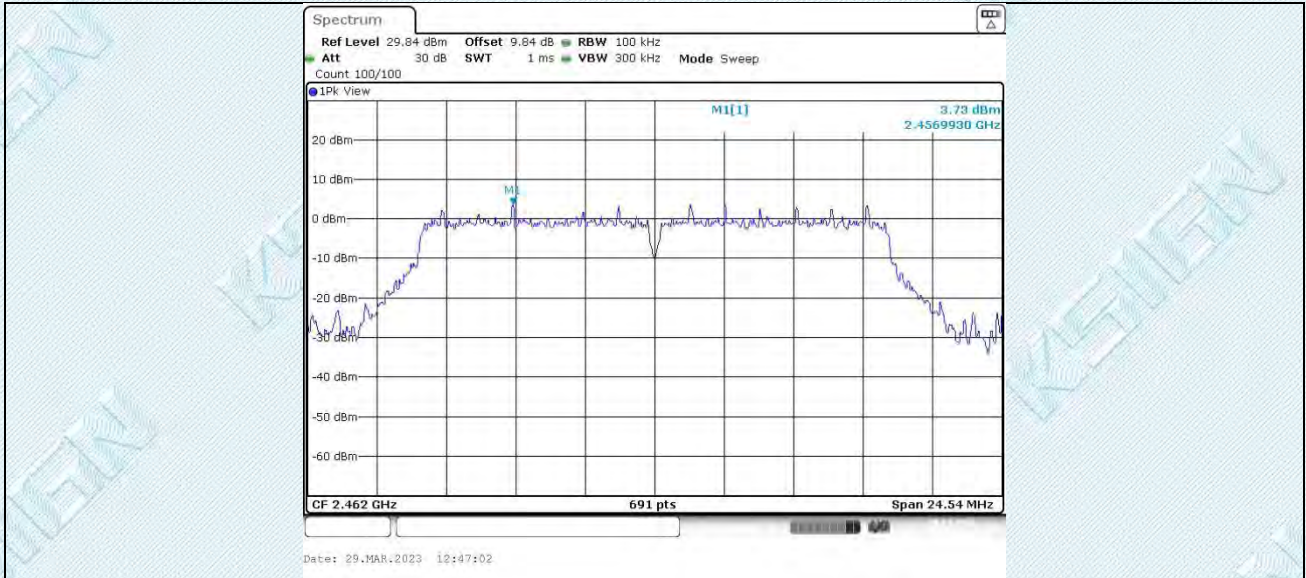

TRF RF_R1

Add: West Side of 1/F., Building C, Zone A, Fuyuan New Factory, Jiujiu Industrial Park, Minzhu, Shatou, Shajing, Bao'an District, Shenzhen, Guangdong, China

Tel: +(86) 0755-2985 2678 Fax: +(86) 0755-2985 2397 E-mail: info@gdksign.cn Web: www.gdksign.com

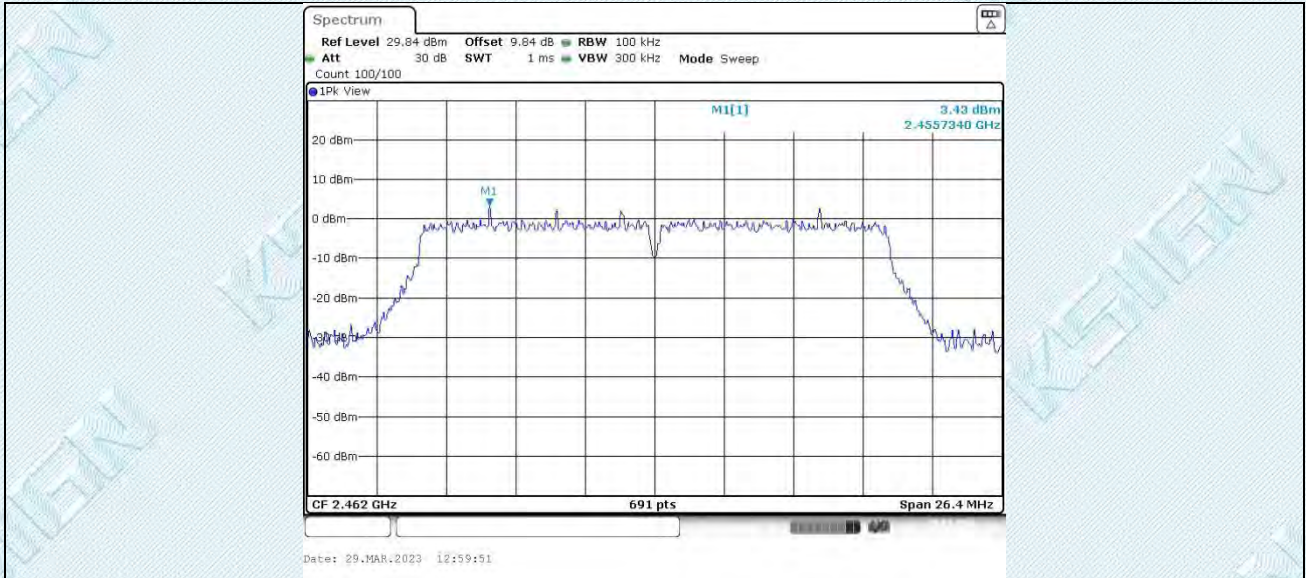

11N40SISO_Ant1_2422

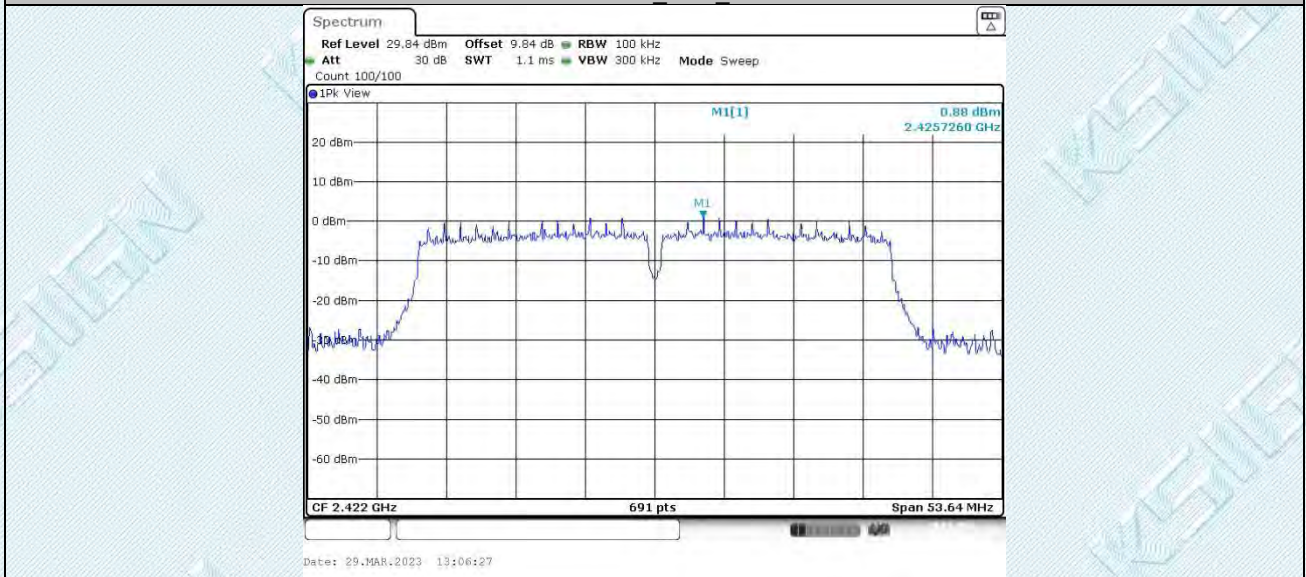

11N40SISO_Ant1_2437

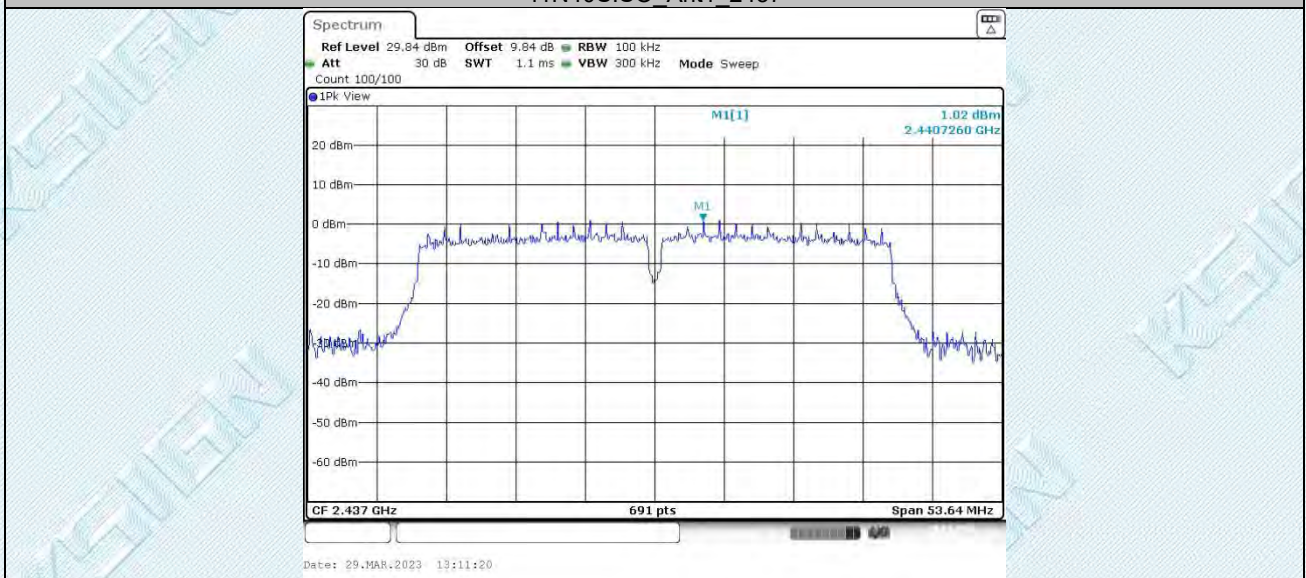

11N40SISO_Ant1_2452

TRF_RF_R1

Add: West Side of 1/F., Building C, Zone A, Fuyuan New Factory, Jiujiu Industrial Park, Minzhu, Shatou, Shajing, Bao'an District, Shenzhen, Guangdong, China

Tel: +(86) 0755-2985 2678 Fax: +(86) 0755-2985 2397 E-mail: info@gdksign.cn Web: www.gdksign.com

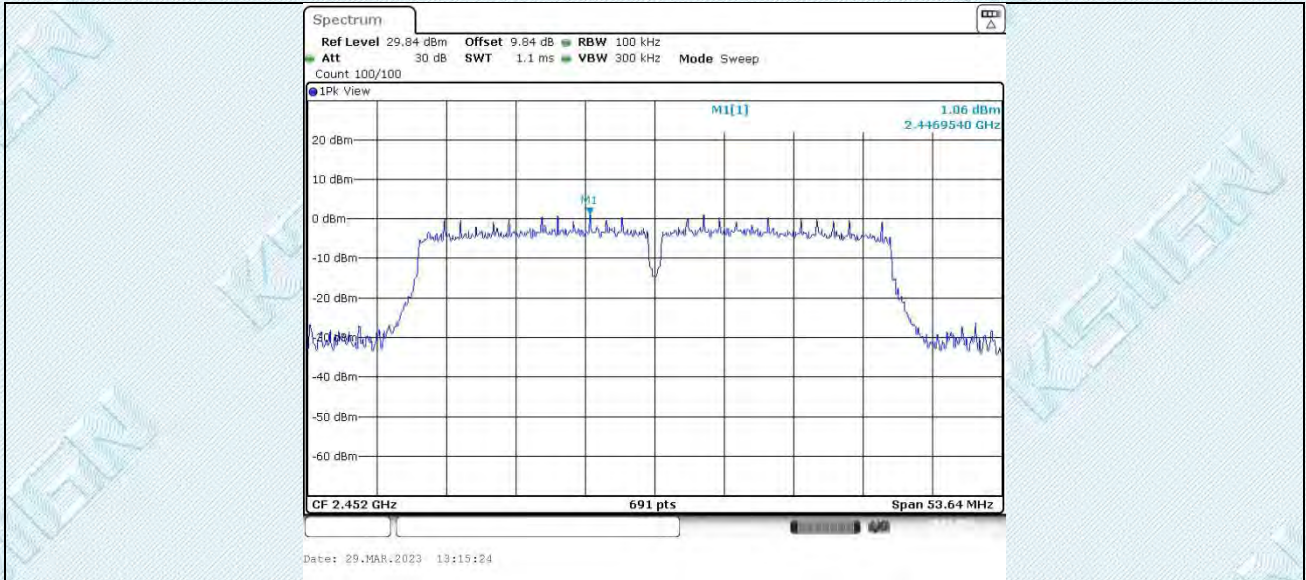

TRF_RF_R1

Add: West Side of 1/F., Building C, Zone A, Fuyuan New Factory, Jiujiu Industrial Park, Minzhu, Shatou, Shajing, Bao'an District, Shenzhen, Guangdong, China

Tel: +(86) 0755-2985 2678 Fax: +(86) 0755-2985 2397 E-mail: info@gdksign.cn Web: www.gdksign.com

6.6. Appendix F: Band edge measurements

6.6.1. Test Result

TestMode	Antenna	ChName	Frequency [MHz]	RefLevel[dBm]	Result[dBm]	Limit[dBm]	Verdict
11B	Ant1	Low	2412	4.74	-28.95	≤-15.26	PASS
		High	2462	4.85	-39.91	≤-15.15	PASS
11G	Ant1	Low	2412	1.03	-31.18	≤-18.97	PASS
		High	2462	3.73	-33.84	≤-16.27	PASS
11N20SISO	Ant1	Low	2412	2.58	-26.27	≤-17.42	PASS
		High	2462	3.43	-34.82	≤-16.57	PASS
11N40SISO	Ant1	Low	2422	0.88	-27.22	≤-19.12	PASS
		High	2452	1.06	-31.06	≤-18.94	PASS

6.6.2. Test Graphs

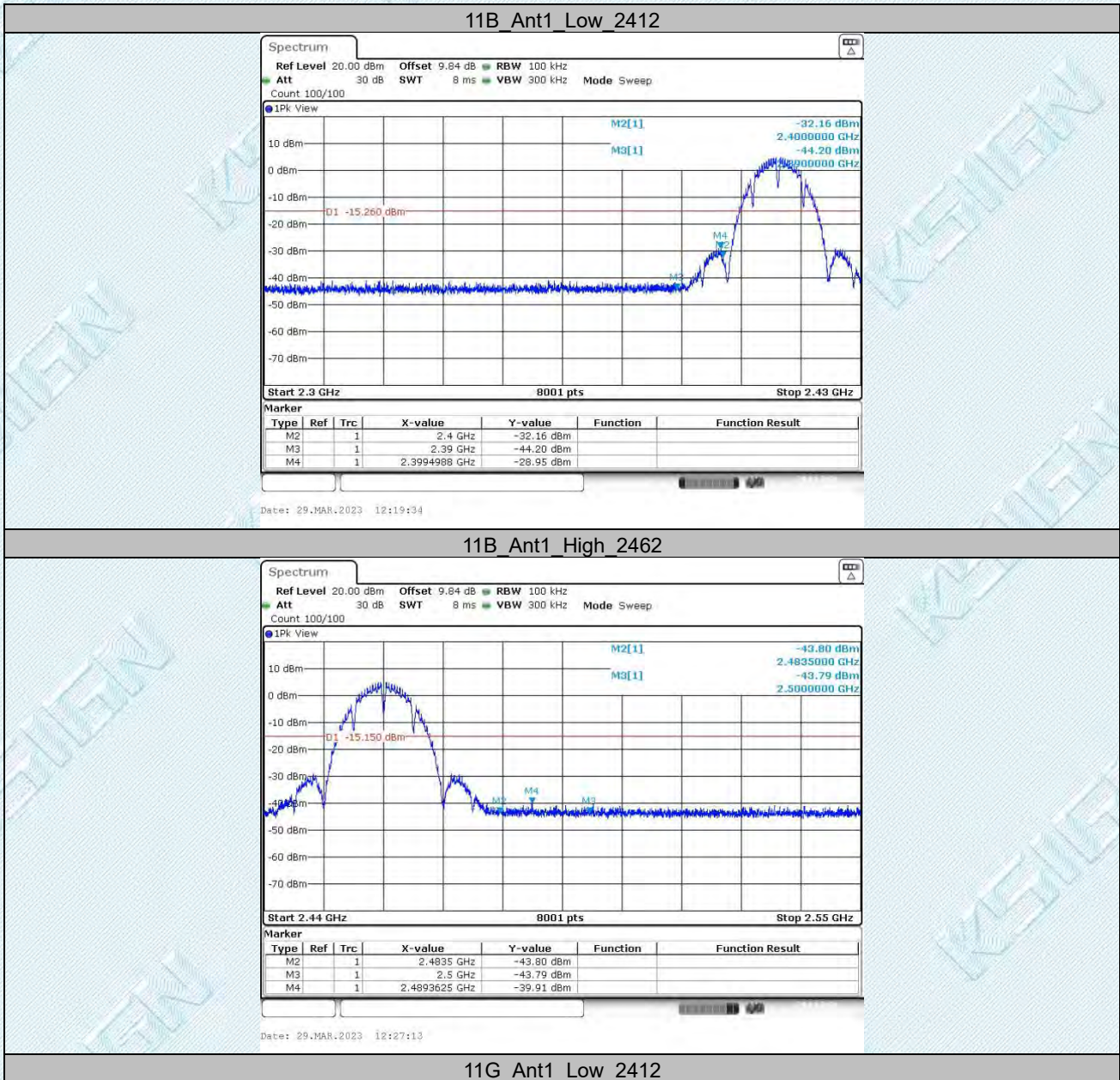

TRF_RF_R1

Add: West Side of 1/F., Building C, Zone A, Fuyuan New Factory, Jiujiu Industrial Park, Minzhu, Shatou, Shajing, Bao'an District, Shenzhen, Guangdong, China

Tel: +(86) 0755-2985 2678 Fax: +(86) 0755-2985 2397 E-mail: info@gdksign.cn Web: www.gdksign.com

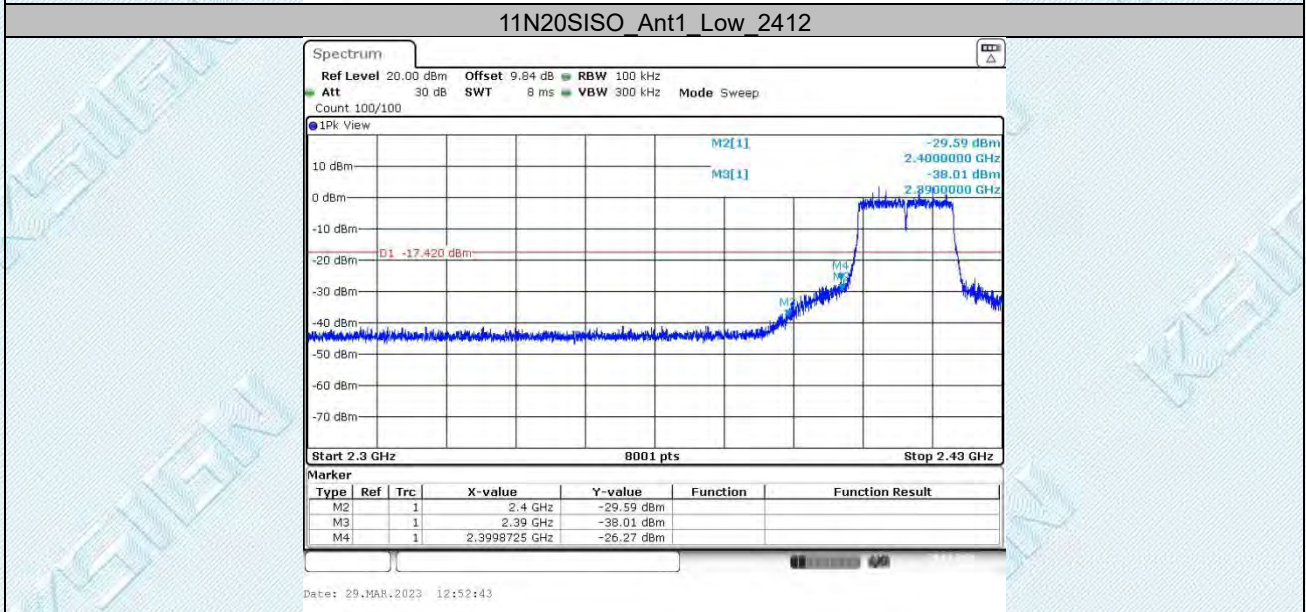
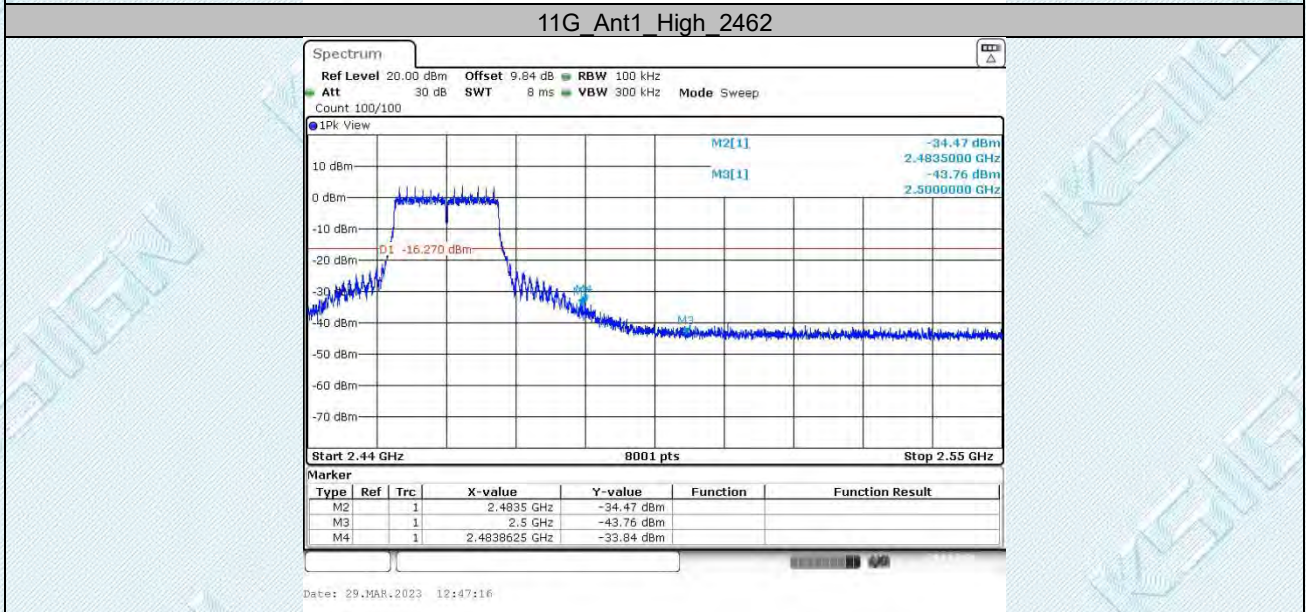
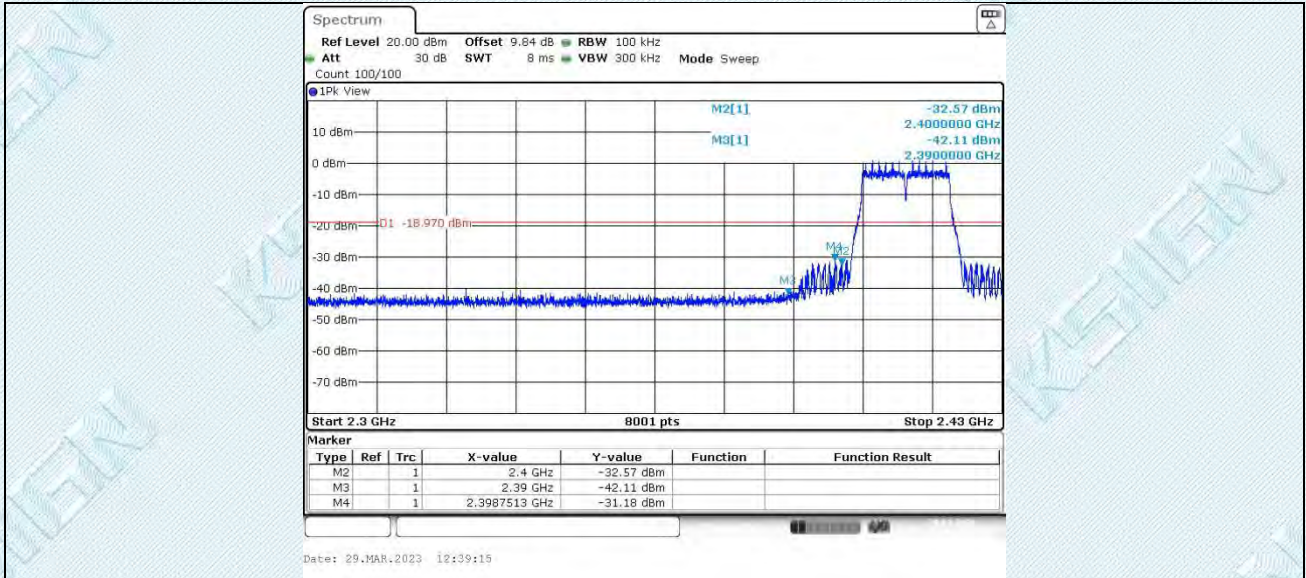

11N20SISO Ant1 High 2462

TRF_RF_R1

Add: West Side of 1/F., Building C, Zone A, Fuyuan New Factory, Jiujiu Industrial Park, Minzhu, Shatou, Shajing, Bao'an District, Shenzhen, Guangdong, China

Tel: +(86) 0755-2985 2678 Fax: +(86) 0755-2985 2397 E-mail: info@gdksign.cn Web: www.gdksign.com

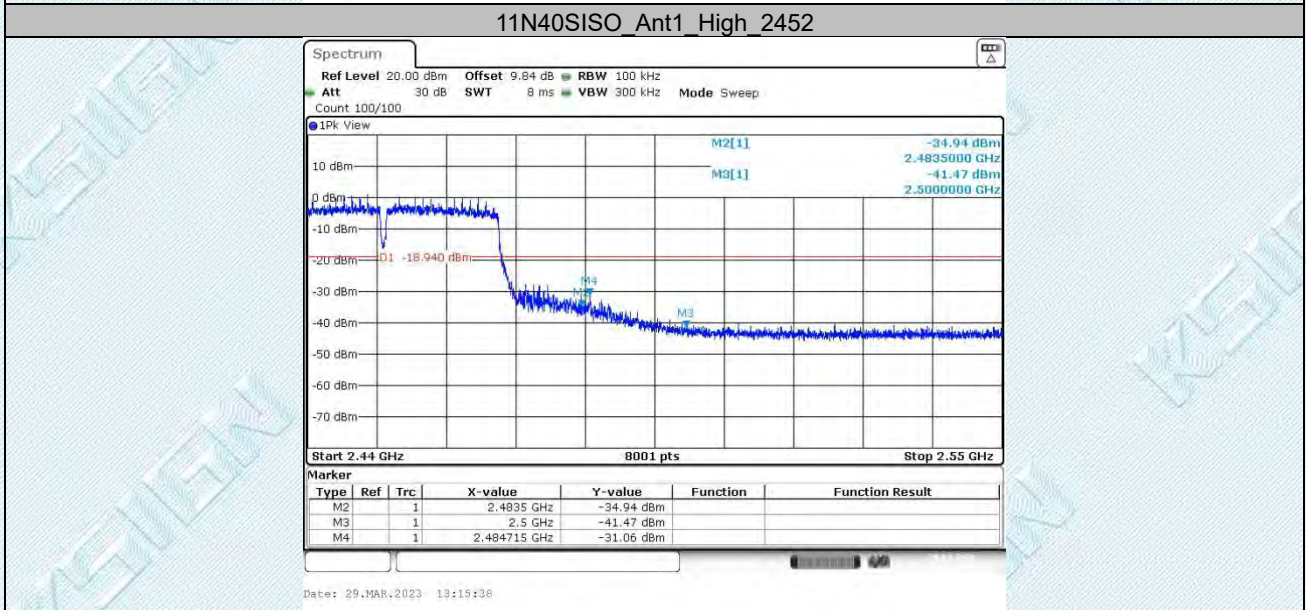
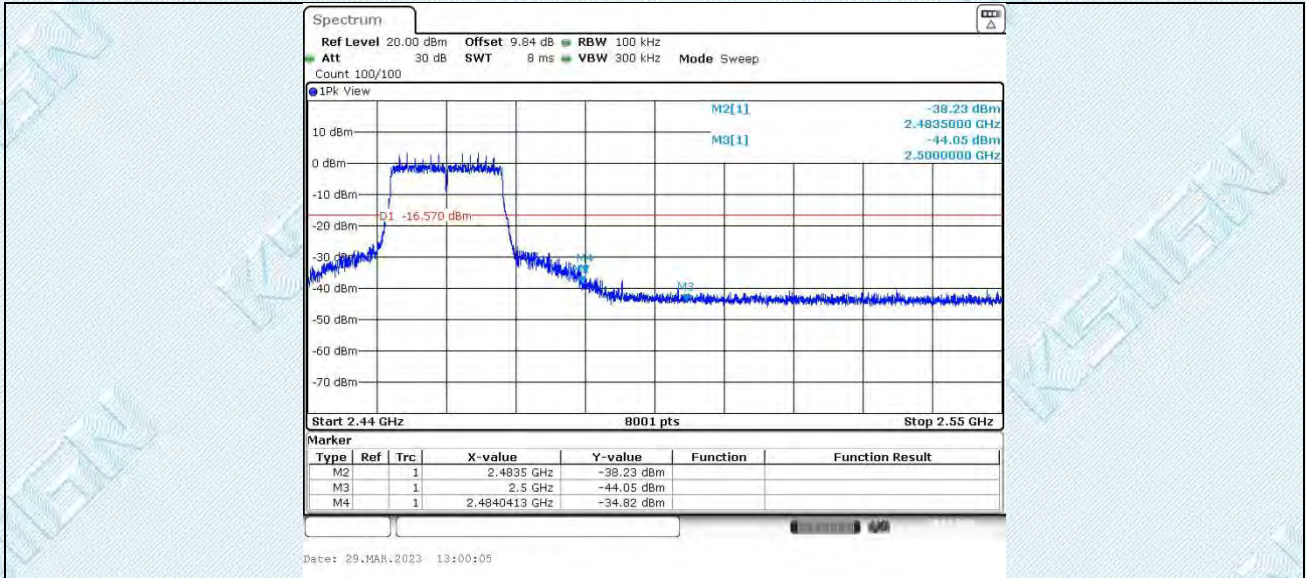

TRF_RF_R1

Add: West Side of 1/F., Building C, Zone A, Fuyuan New Factory, Jiujiu Industrial Park, Minzhu, Shatou, Shajing, Bao'an District, Shenzhen, Guangdong, China

Tel: +(86) 0755-2985 2678 Fax: +(86) 0755-2985 2397 E-mail: info@gdksign.cn Web: www.gdksign.com

6.7. Appendix G: Conducted Spurious Emission

6.7.1. Test Result

TestMode	Antenna	Frequency [MHz]	FreqRange [Mhz]	RefLevel [dBm]	Result [dBm]	Limit [dBm]	Verdict
11B	Ant1	2412	30~1000	4.74	-52.3	≤-15.26	PASS
			1000~26500	4.74	-39.67	≤-15.26	PASS
		2437	30~1000	4.84	-51.72	≤-15.16	PASS
			1000~26500	4.84	-41.53	≤-15.16	PASS
		2462	30~1000	4.85	-51.11	≤-15.15	PASS
			1000~26500	4.85	-43.42	≤-15.15	PASS
11G	Ant1	2412	30~1000	1.03	-52.25	≤-18.97	PASS
			1000~26500	1.03	-46.81	≤-18.97	PASS
		2437	30~1000	3.73	-51.29	≤-16.27	PASS
			1000~26500	3.73	-46.14	≤-16.27	PASS
		2462	30~1000	3.73	-51.86	≤-16.27	PASS
			1000~26500	3.73	-46.51	≤-16.27	PASS
11N20SISO	Ant1	2412	30~1000	2.58	-51.78	≤-17.42	PASS
			1000~26500	2.58	-46.3	≤-17.42	PASS
		2437	30~1000	3.19	-51.98	≤-16.81	PASS
			1000~26500	3.19	-46.5	≤-16.81	PASS
		2462	30~1000	3.43	-51.52	≤-16.57	PASS
			1000~26500	3.43	-46.9	≤-16.57	PASS
11N40SISO	Ant1	2422	30~1000	0.88	-51.69	≤-19.12	PASS
			1000~26500	0.88	-46.36	≤-19.12	PASS
		2437	30~1000	1.02	-52.02	≤-18.98	PASS
			1000~26500	1.02	-46.73	≤-18.98	PASS
		2452	30~1000	1.06	-52.13	≤-18.94	PASS
			1000~26500	1.06	-46.28	≤-18.94	PASS

6.7.2. Test Graphs

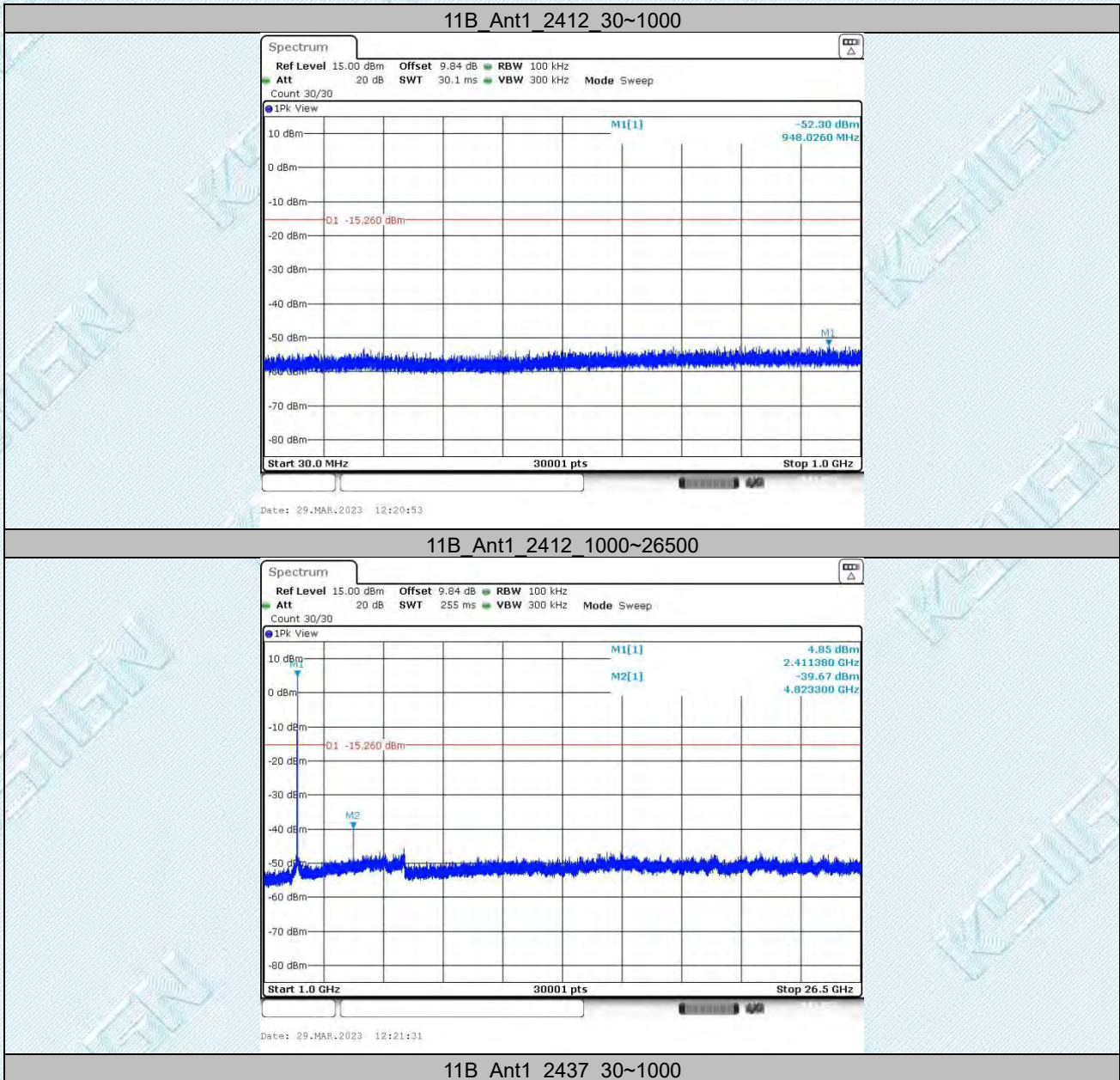

TRF_RF_R1

Add: West Side of 1/F., Building C, Zone A, Fuyuan New Factory, Jiujiu Industrial Park, Minzhu, Shatou, Shajing, Bao'an District, Shenzhen, Guangdong, China

Tel: +(86) 0755-2985 2678 Fax: +(86) 0755-2985 2397 E-mail: info@gdksign.cn Web: www.gdksign.com

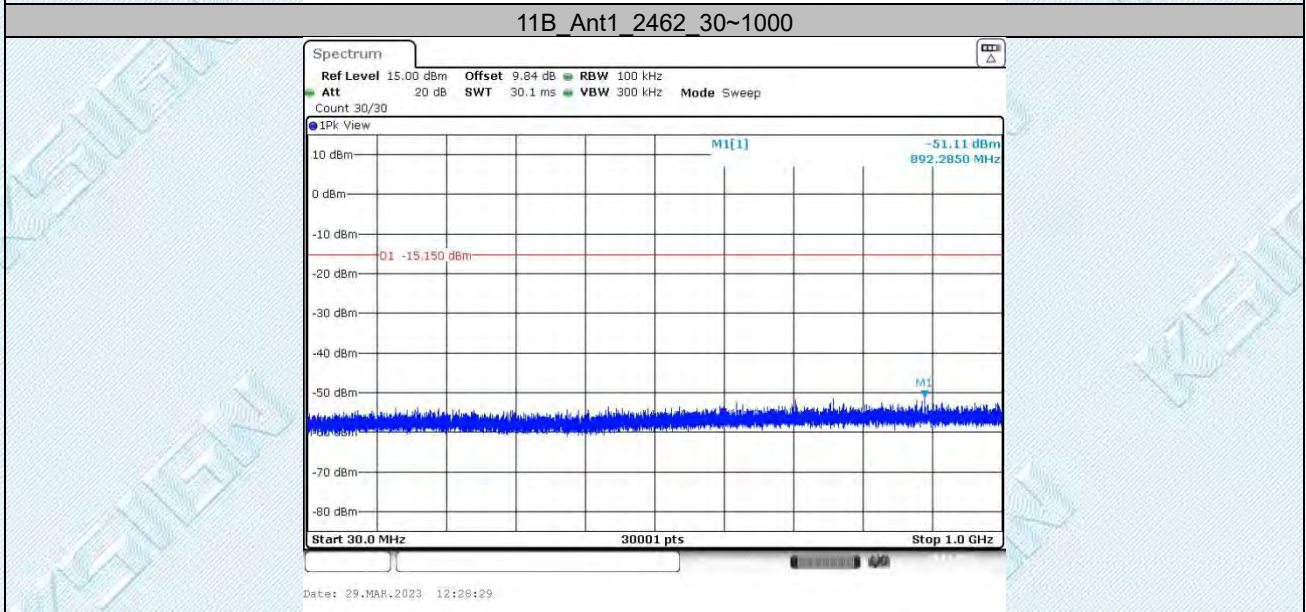
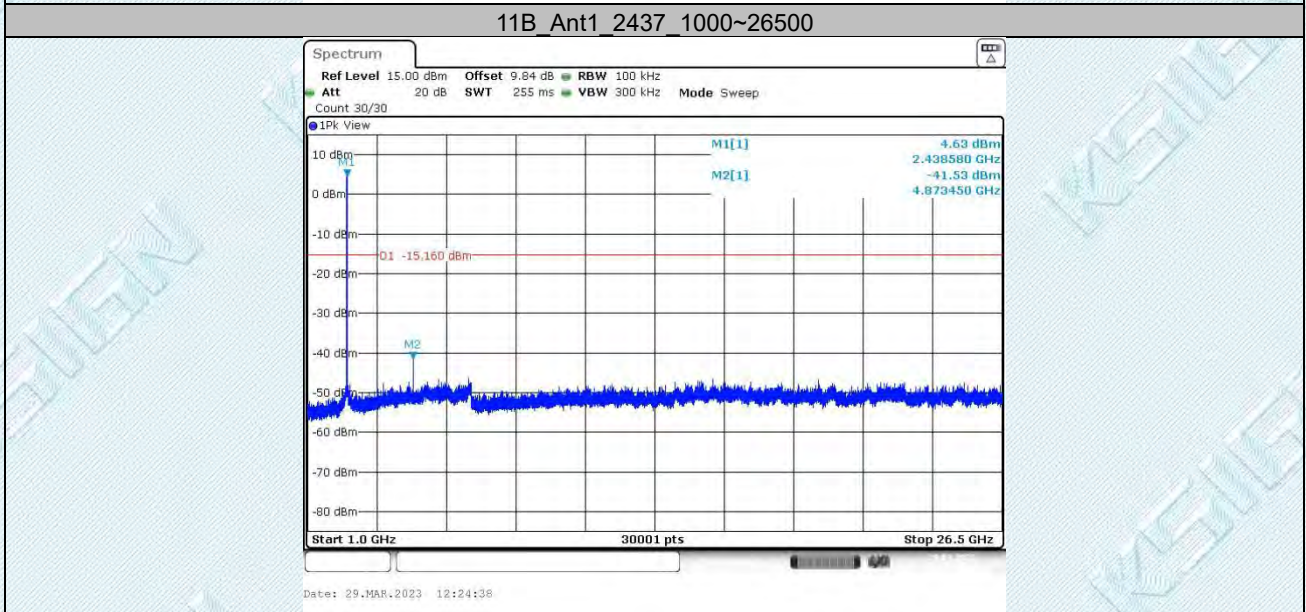
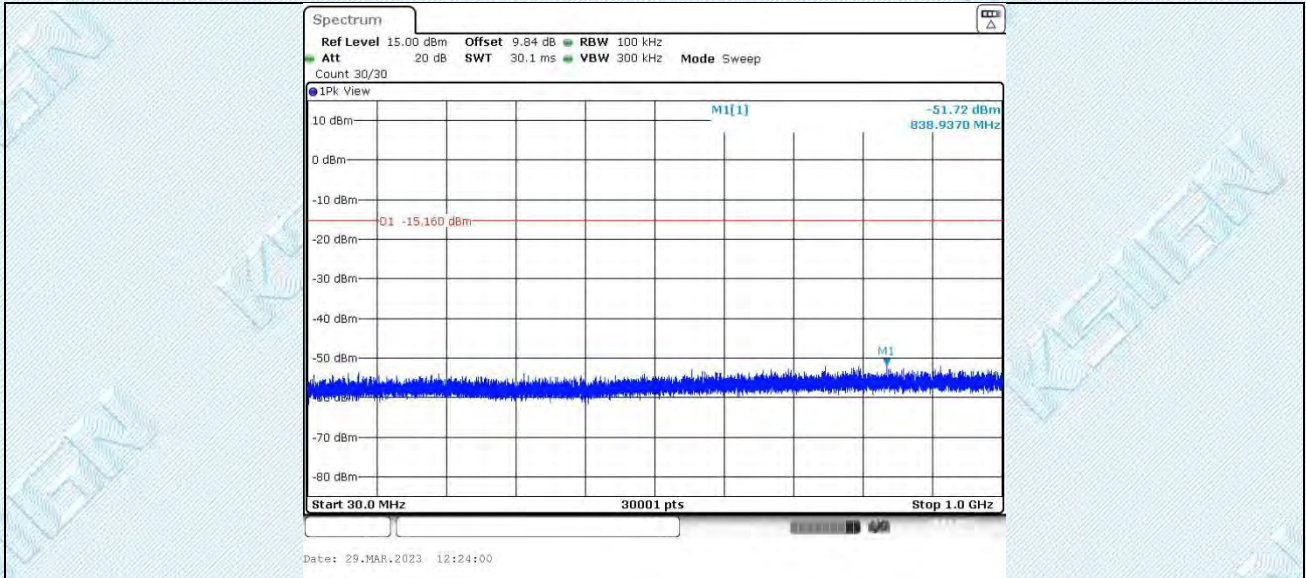

TRF RF_R1

Add: West Side of 1/F., Building C, Zone A, Fuyuan New Factory, Jiujiu Industrial Park, Minzhu, Shatou, Shajing, Bao'an District, Shenzhen, Guangdong, China

Tel: +(86) 0755-2985 2678 Fax: +(86) 0755-2985 2397 E-mail: info@gdksign.cn Web: www.gdksign.com

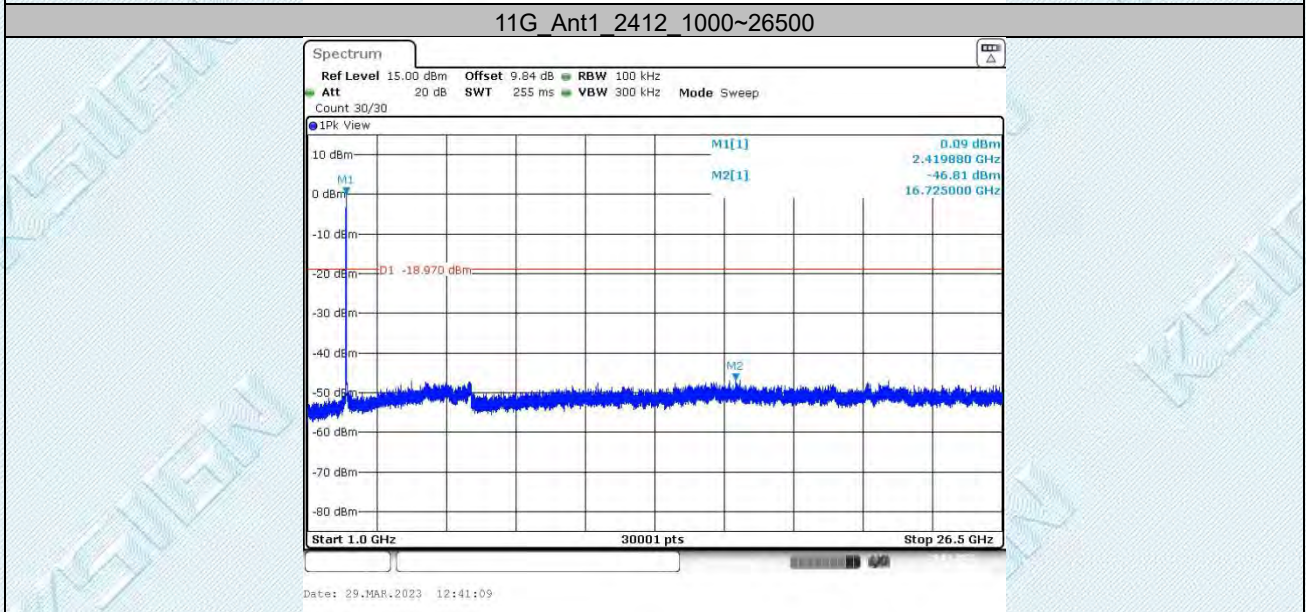
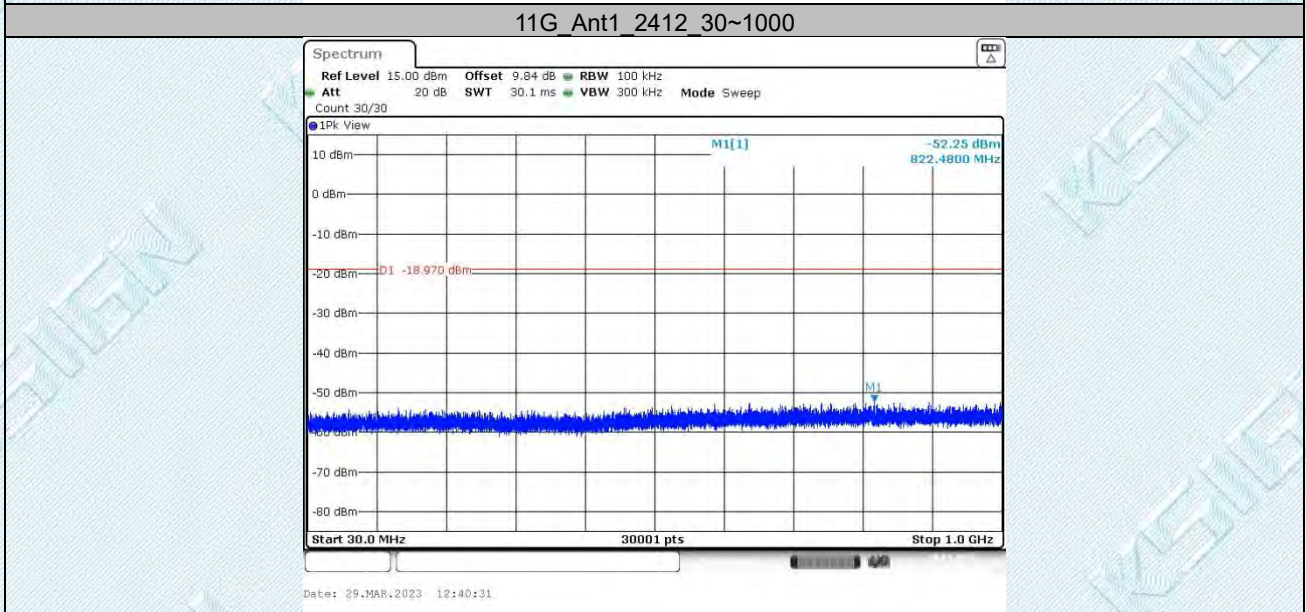
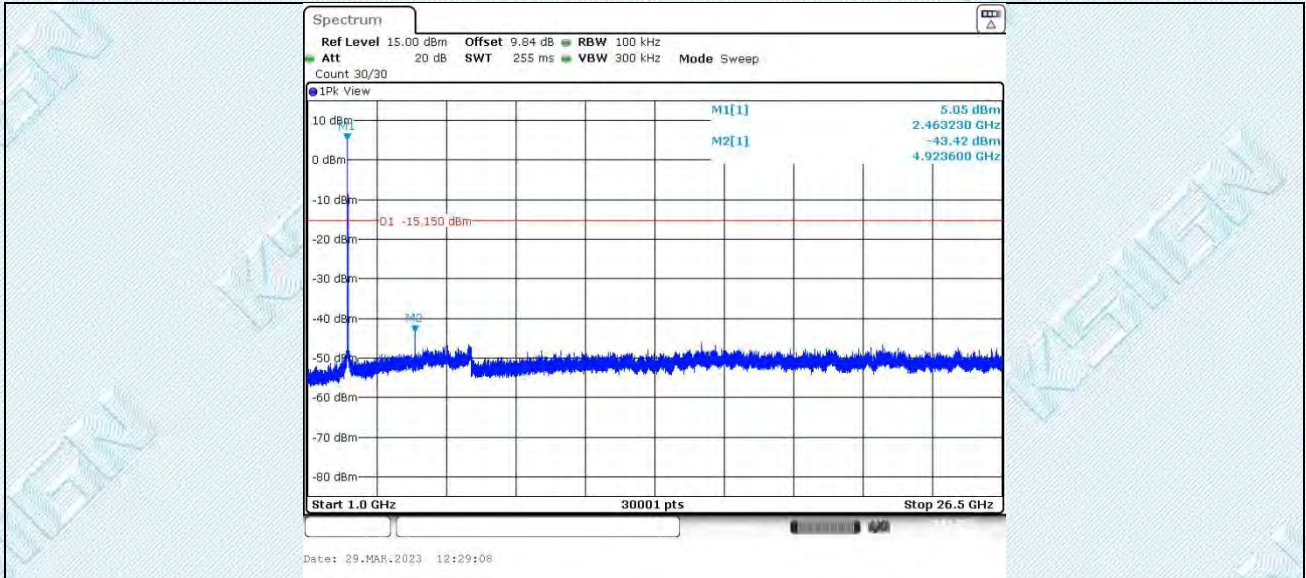

TRF RF_R1

Add: West Side of 1/F., Building C, Zone A, Fuyuan New Factory, Jiujiu Industrial Park, Minzhu, Shatou, Shajing, Bao'an District, Shenzhen, Guangdong, China

Tel: +(86) 0755-2985 2678 Fax: +(86) 0755-2985 2397 E-mail: info@gdksign.cn Web: www.gdksign.com

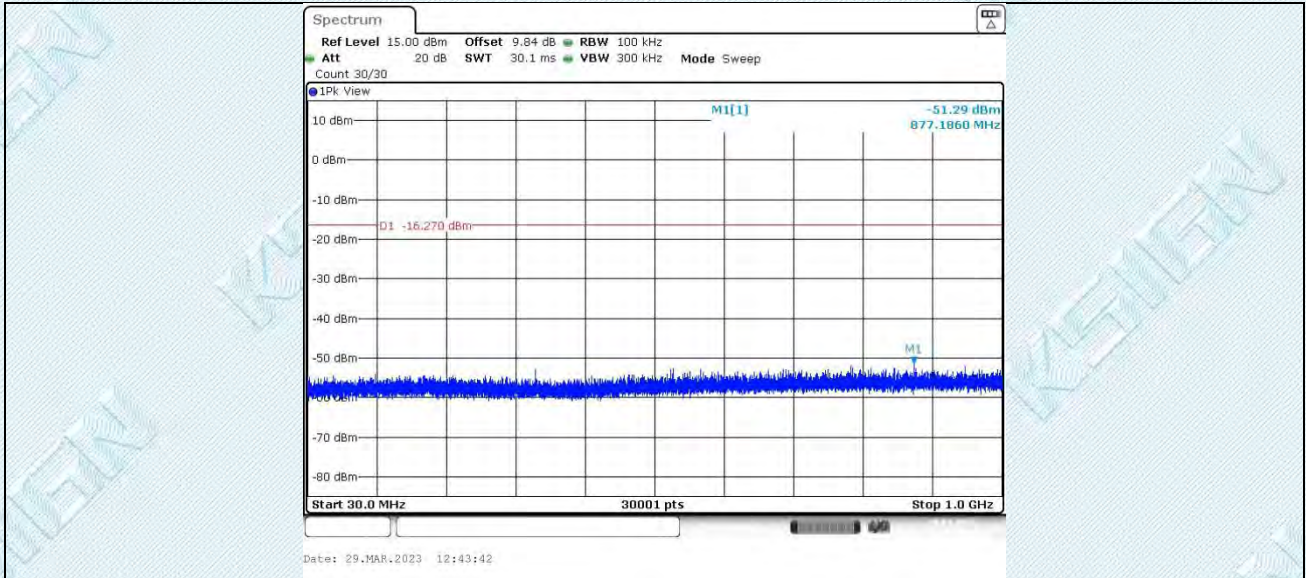

11G_Ant1_2437_1000~26500

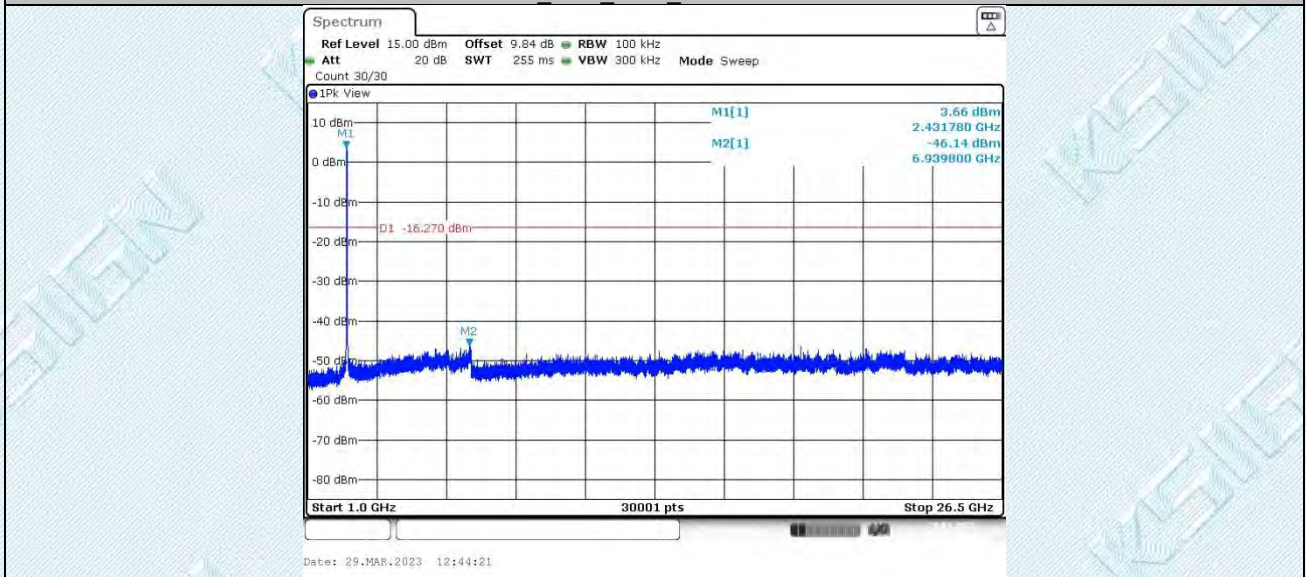

11G_Ant1_2462_30~1000

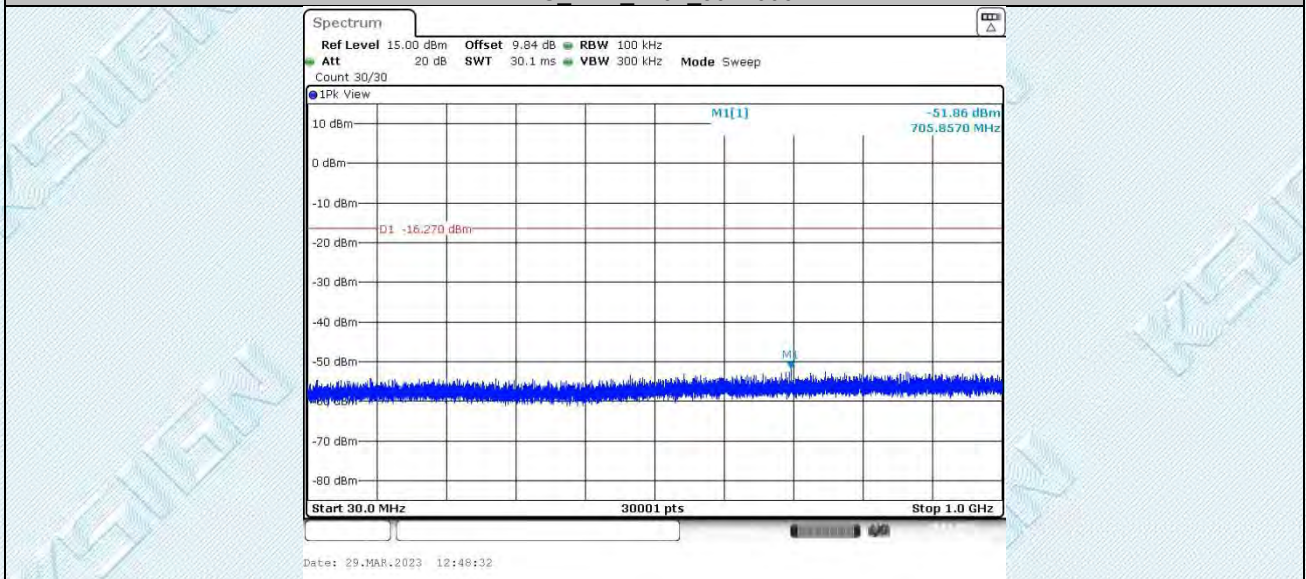

11G_Ant1_2462_1000~26500

TRF_RF_R1

Add: West Side of 1/F., Building C, Zone A, Fuyuan New Factory, Jiujiu Industrial Park, Minzhu, Shatou, Shajing, Bao'an District, Shenzhen, Guangdong, China

Tel: +(86) 0755-2985 2678 Fax: +(86) 0755-2985 2397 E-mail: info@gdksign.cn Web: www.gdksign.com

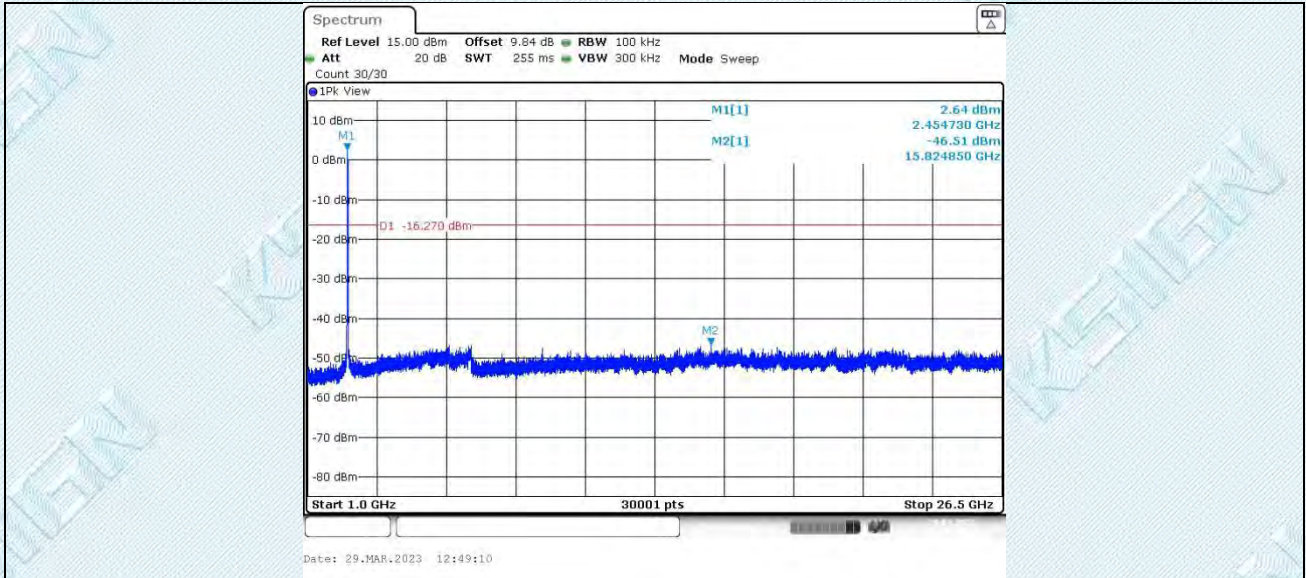

11N20SISO Ant1 2412 30~1000

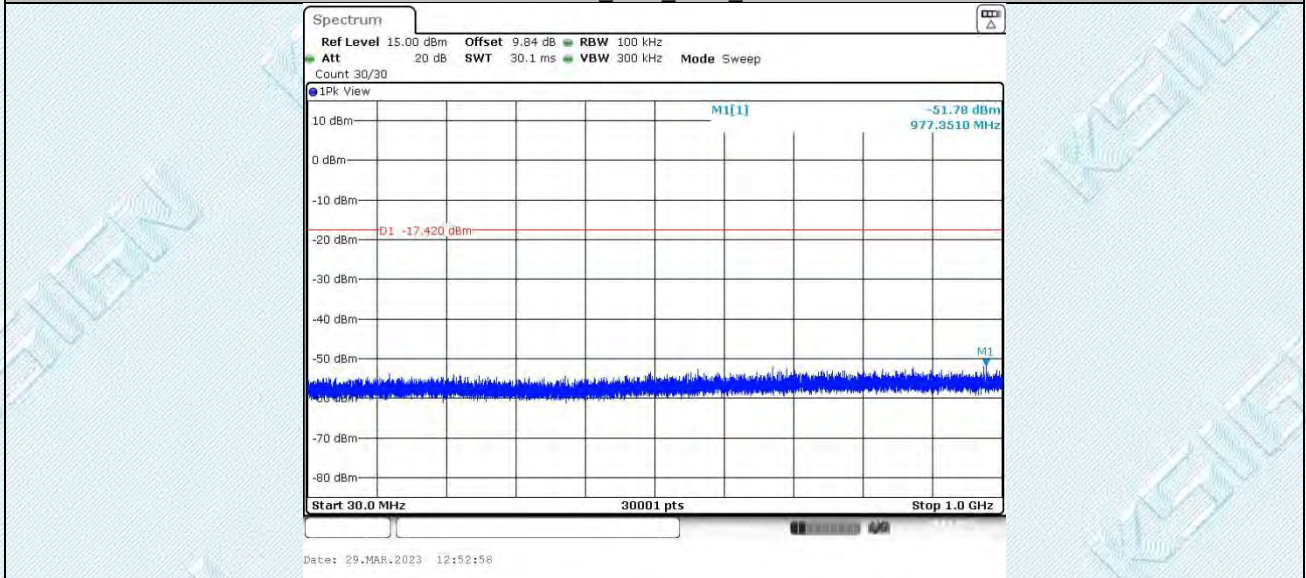

11N20SISO Ant1 2412 1000~26500

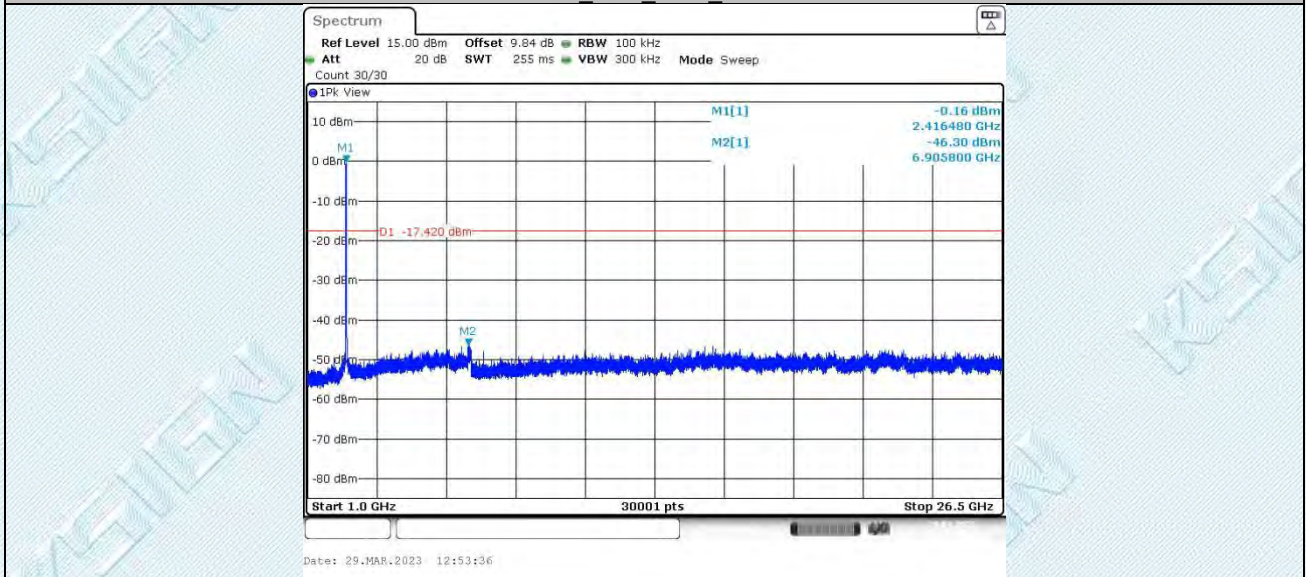

11N20SISO Ant1 2437 30~1000

TRF RF_R1

Add: West Side of 1/F., Building C, Zone A, Fuyuan New Factory, Jiujiu Industrial Park, Minzhu, Shatou, Shajing, Bao'an District, Shenzhen, Guangdong, China

Tel: +(86) 0755-2985 2678 Fax: +(86) 0755-2985 2397 E-mail: info@gdksign.cn Web: www.gdksign.com

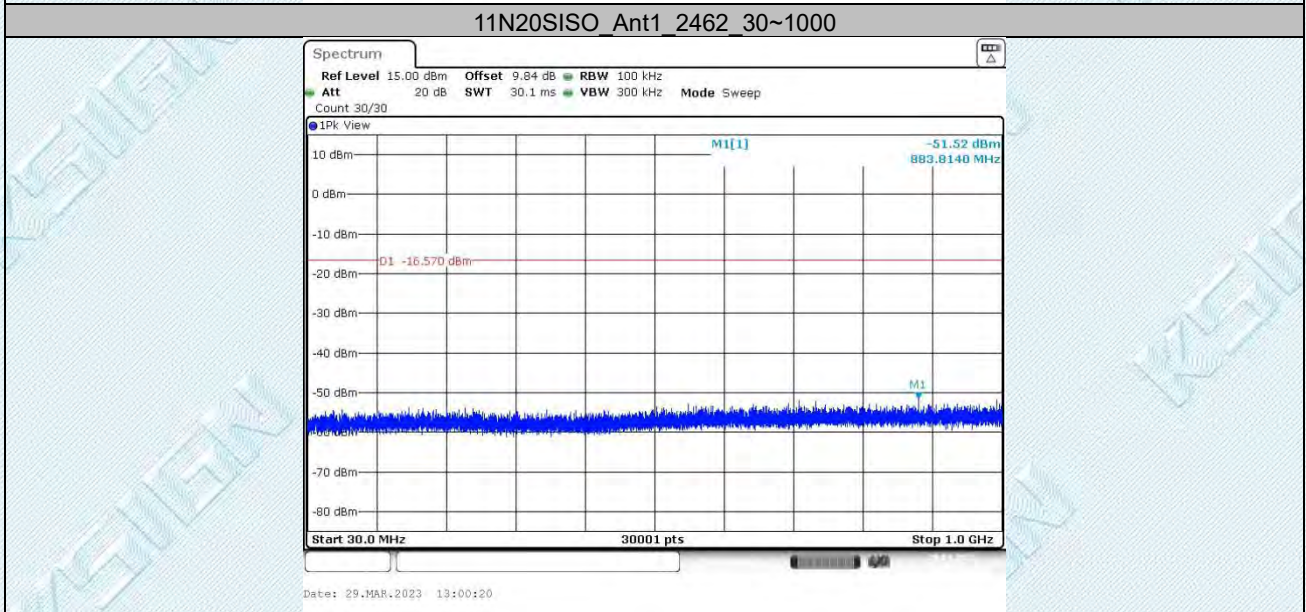
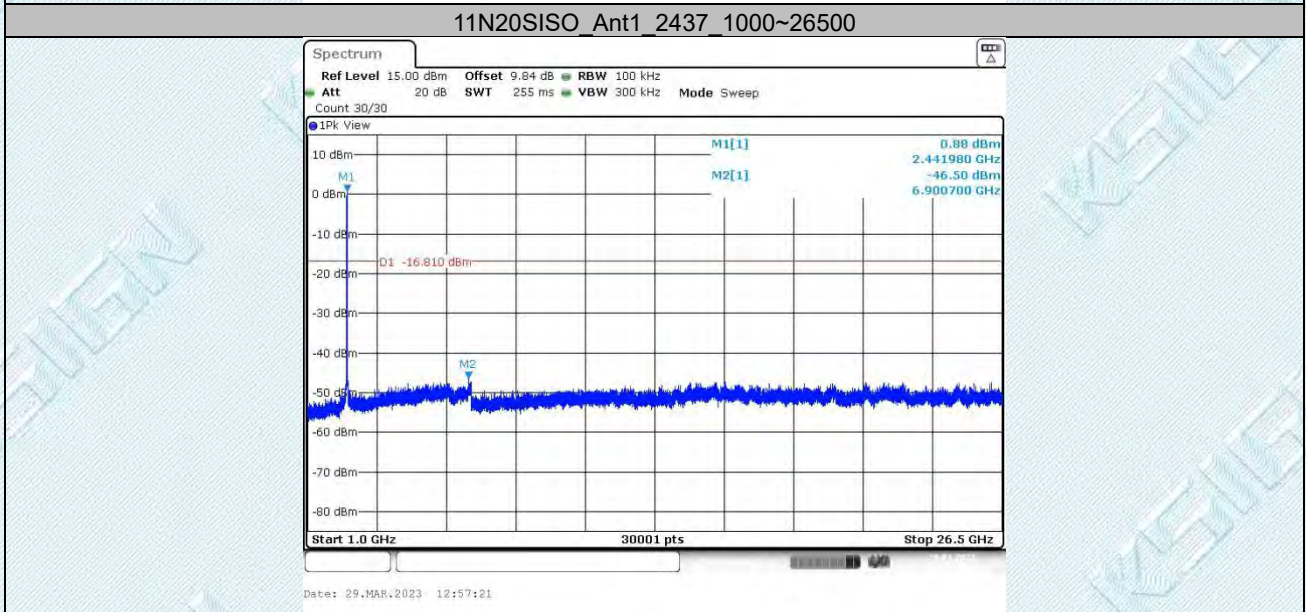
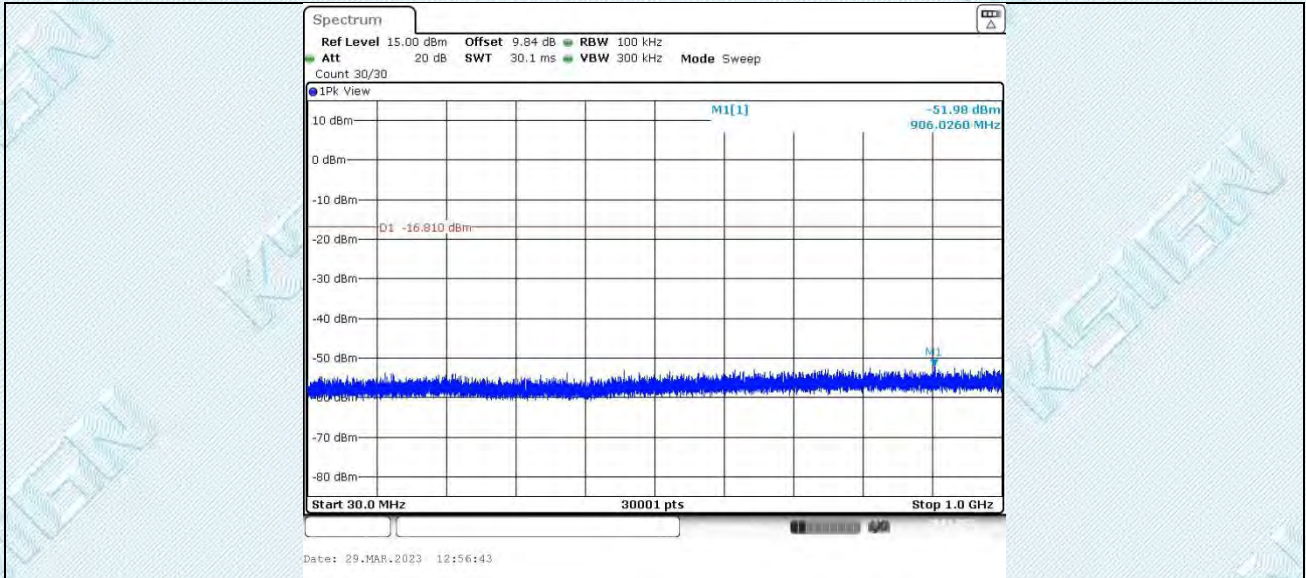

TRF RF_R1

Add: West Side of 1/F., Building C, Zone A, Fuyuan New Factory, Jiujiu Industrial Park, Minzhu, Shatou, Shajing, Bao'an District, Shenzhen, Guangdong, China

Tel: +(86) 0755-2985 2678 Fax: +(86) 0755-2985 2397 E-mail: info@gdksign.cn Web: www.gdksign.com

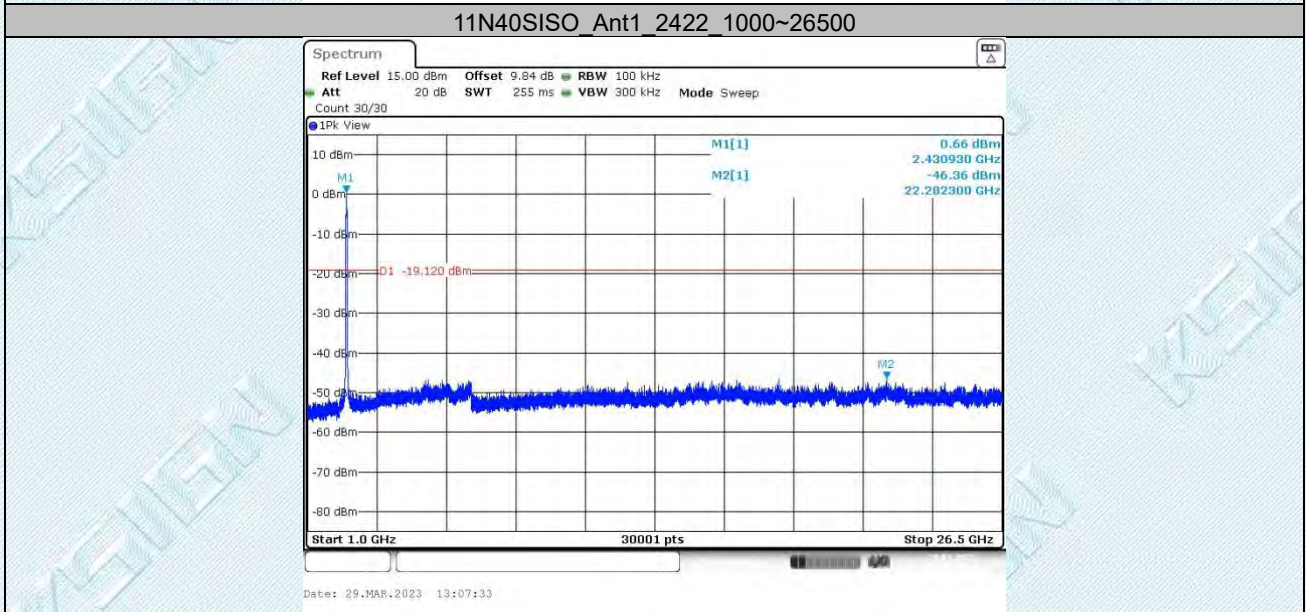
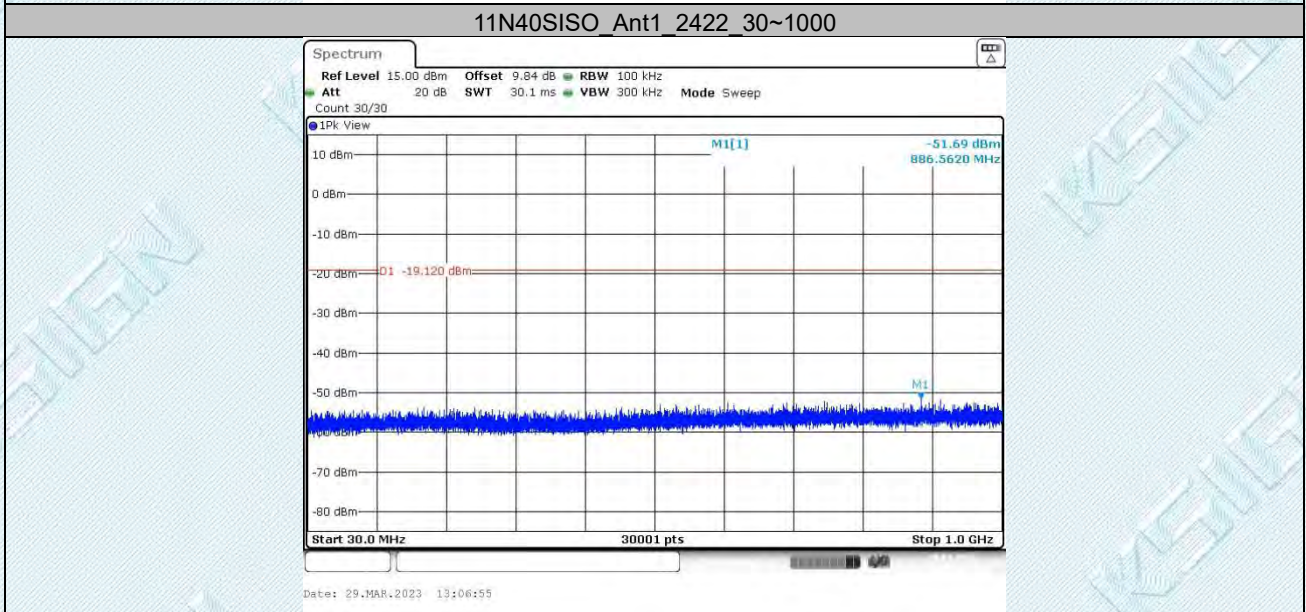
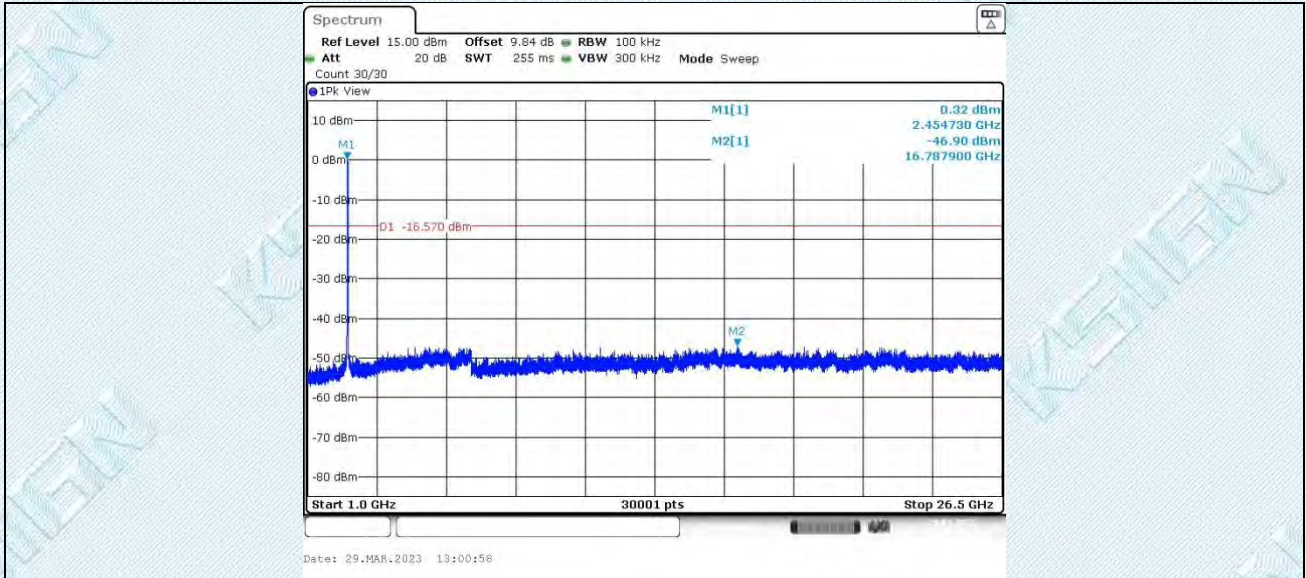

TRF RF_R1

Add: West Side of 1/F., Building C, Zone A, Fuyuan New Factory, Jiujiu Industrial Park, Minzhu, Shatou, Shajing, Bao'an District, Shenzhen, Guangdong, China

Tel: +(86) 0755-2985 2678 Fax: +(86) 0755-2985 2397 E-mail: info@gdksign.cn Web: www.gdksign.com

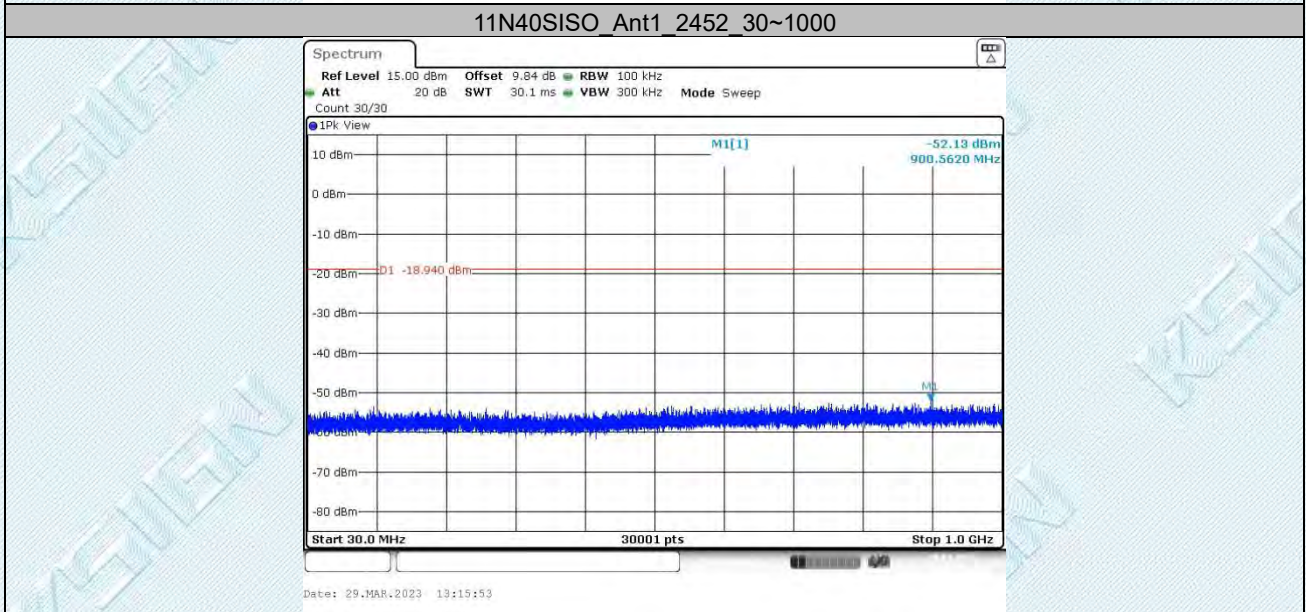
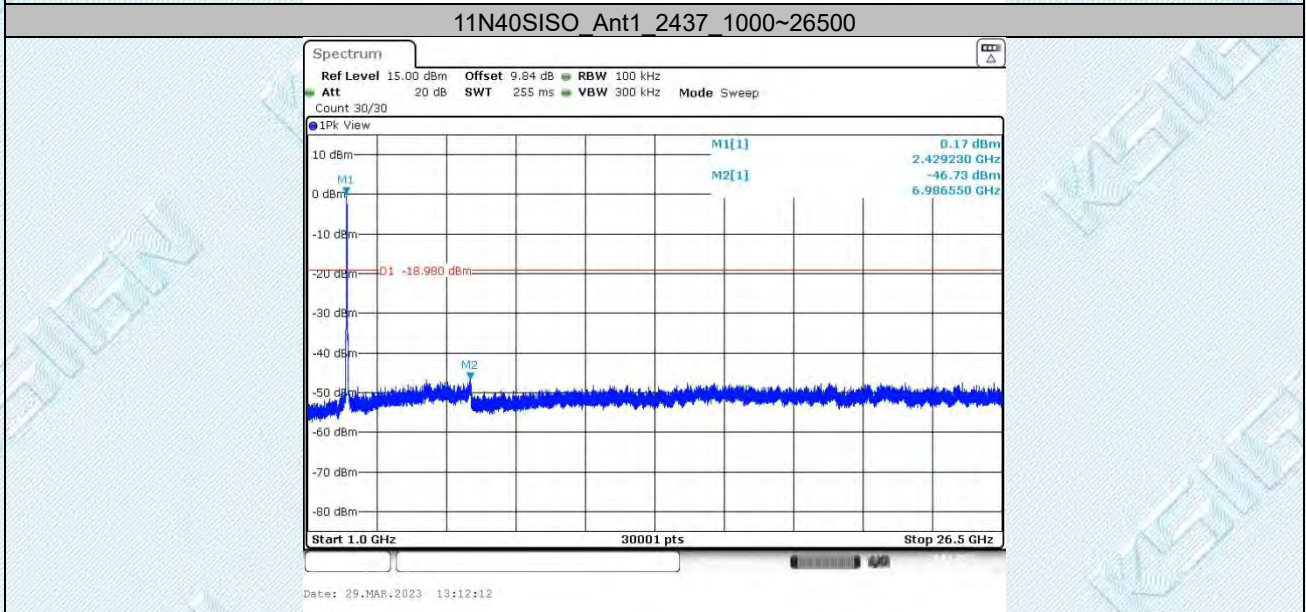
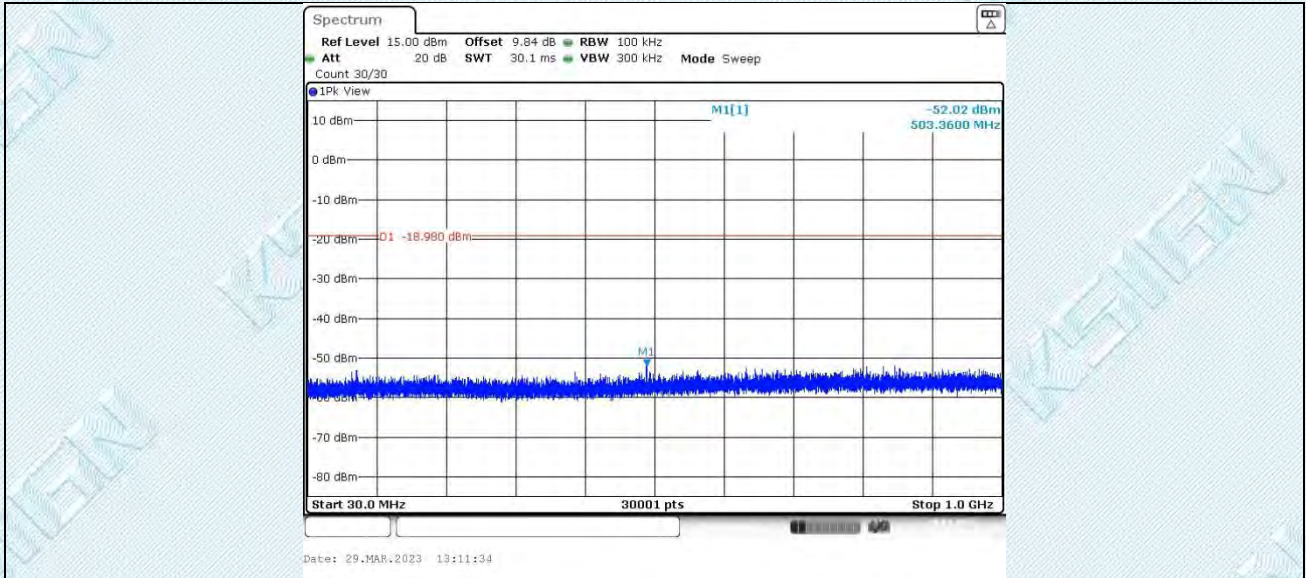

TRF_RF_R1

Add: West Side of 1/F., Building C, Zone A, Fuyuan New Factory, Jiujiu Industrial Park, Minzhu, Shatou, Shajing, Bao'an District, Shenzhen, Guangdong, China

Tel: +(86) 0755-2985 2678 Fax: +(86) 0755-2985 2397 E-mail: info@gdkesign.cn Web: www.gdkesign.com

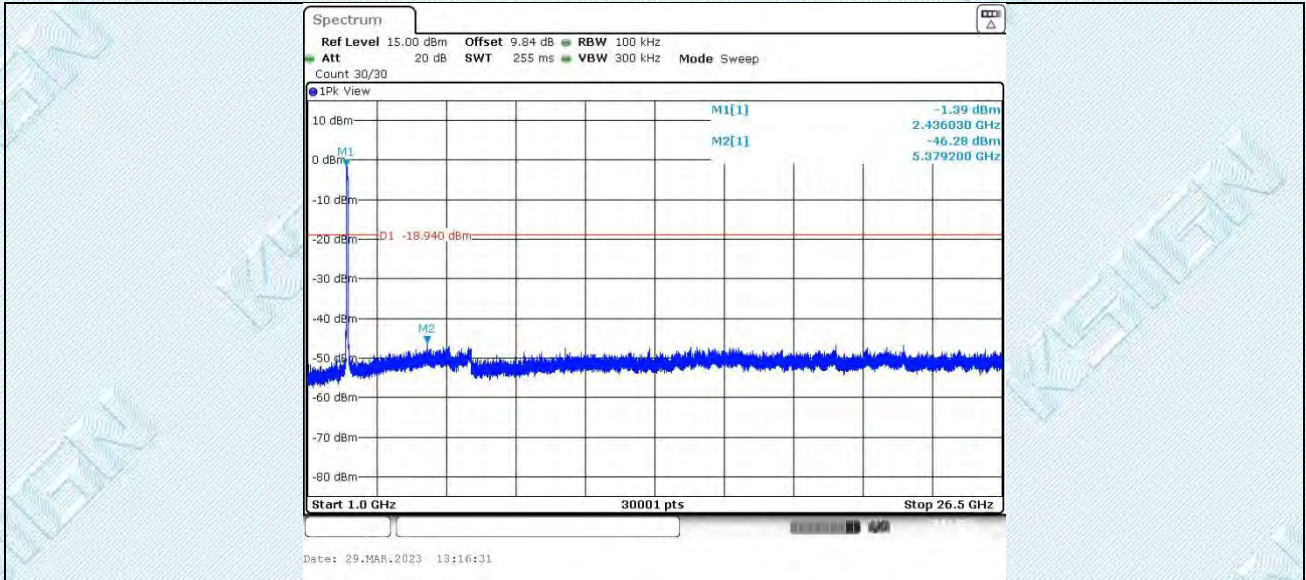

TRF_RF_R1

Add: West Side of 1/F., Building C, Zone A, Fuyuan New Factory, Jiujiu Industrial Park, Minzhu, Shatou, Shajing, Bao'an District, Shenzhen, Guangdong, China

Tel: +(86) 0755-2985 2678 Fax: +(86) 0755-2985 2397 E-mail: info@gdksign.cn Web: www.gdksign.com

6.8. Appendix H: Duty Cycle

6.8.1. Test Result

TestMode	Antenna	Frequency[MHz]	Transmission Duration [ms]	Transmission Period [ms]	Duty Cycle [%]
11B	Ant1	2437	20.00	20.00	100.00
11G	Ant1	2437	1.39	1.41	98.58
11N20SISO	Ant1	2437	5.09	5.11	99.61
11N40SISO	Ant1	2437	2.47	2.49	99.20

Note:

Duty Cycle=Transmission Duration/Transmission Period*100%

6.8.2. Test Graphs

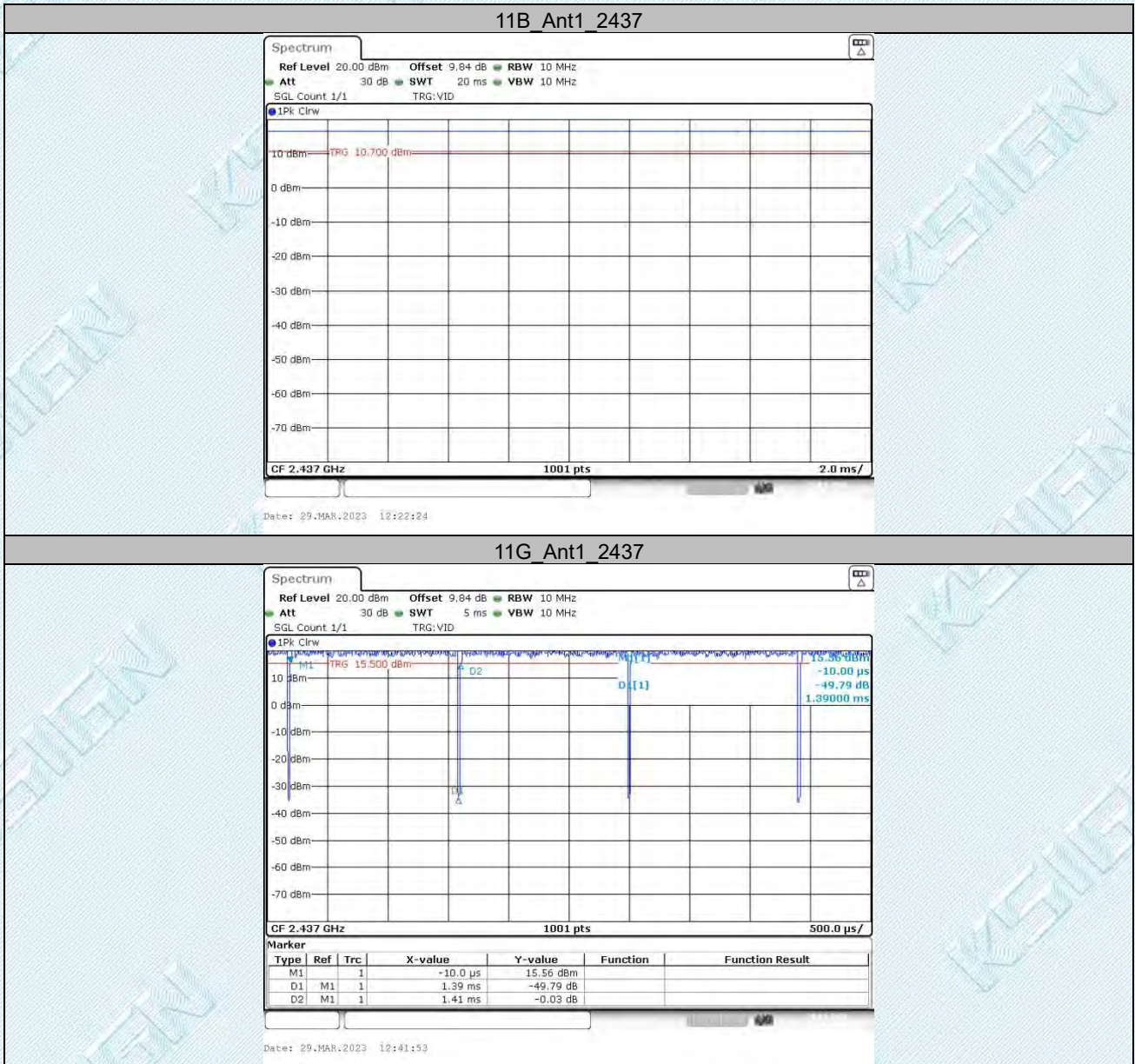

TRF_RF_R1

Add: West Side of 1/F., Building C, Zone A, Fuyuan New Factory, Jiujiu Industrial Park, Minzhu, Shatou, Shajing, Bao'an District, Shenzhen, Guangdong, China

Tel: +(86) 0755-2985 2678 Fax: +(86) 0755-2985 2397 E-mail: info@gdksign.cn Web: www.gdksign.com

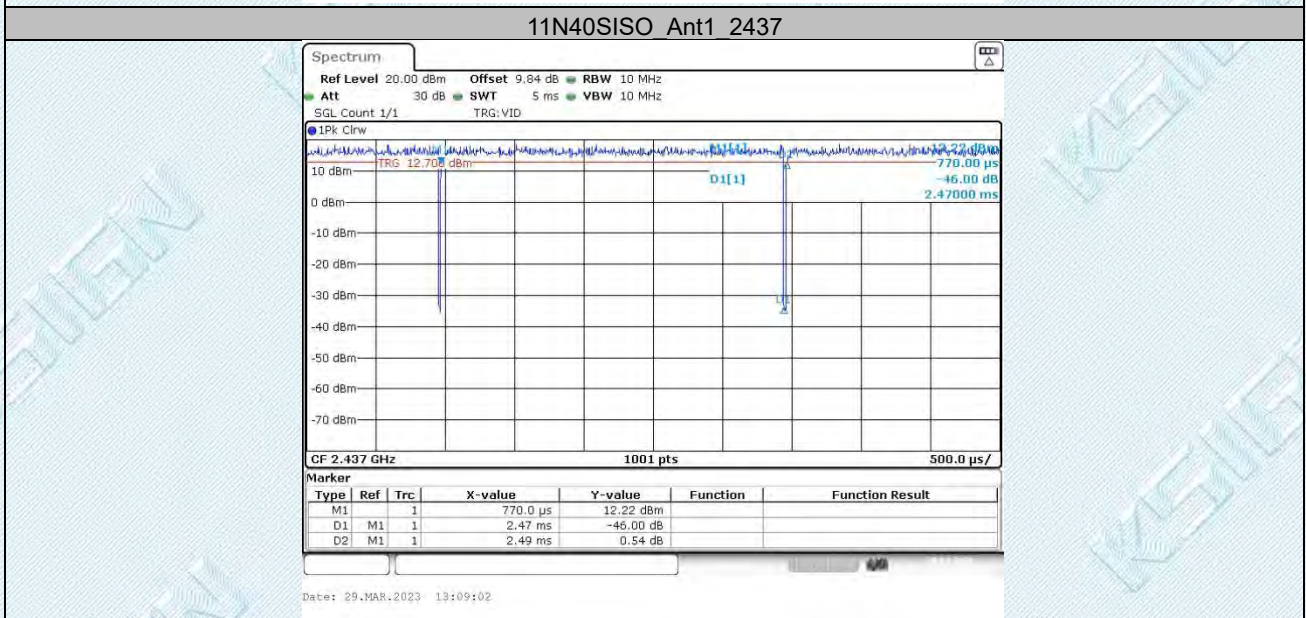
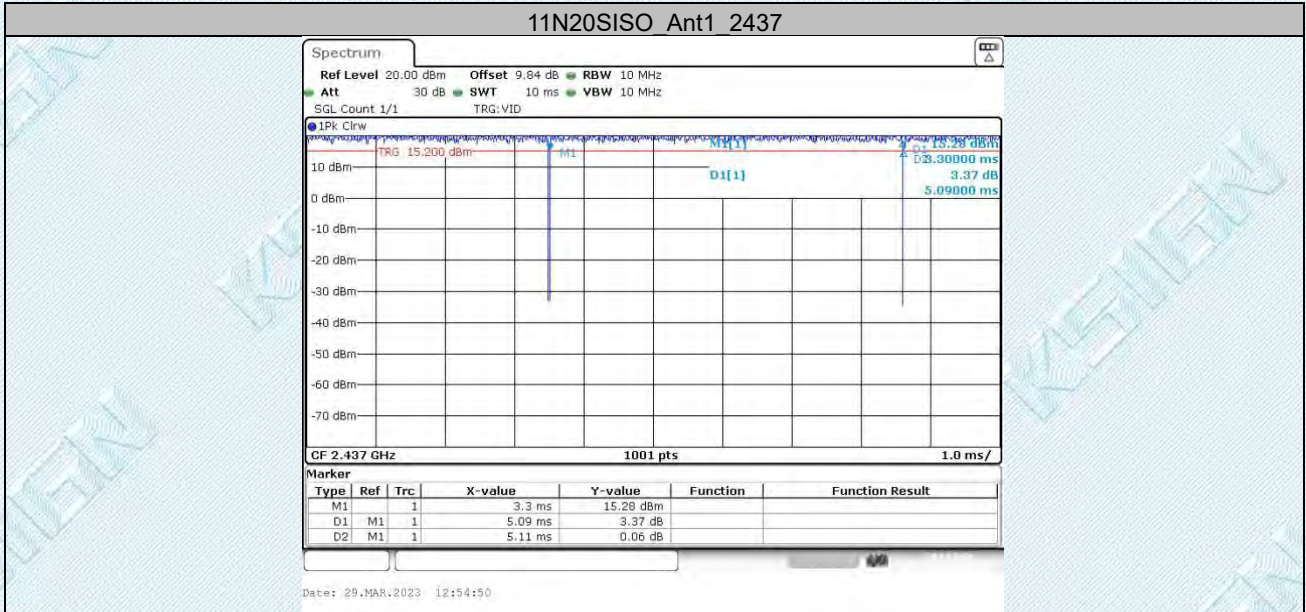

--THE END--