

INSTRUCTION
MANUAL

平面印刷品基本技术要求

深圳市云视机器人有限公司

设计:	日期:2023.04.19	物料名称	P1S说明书(英文)
尺寸:140*105mm	材质:100g双铜纸	产品型号	petgugu P1S
页数:24p	印刷颜色:单色印刷	物料编号	
比例:1:1	装订方式:骑马钉装	版次	V01 (04.19)
变更记录:			



petgugu

P1S Robot Vacuum Cleaner User manual

Please read this manual carefully before using the product and keep them properly.

Congratulations on the purchase of your petgugu ROBOTS!

We hope it brings you satisfaction. We trust your purchase will keep your home clean and provide you a high-quality life.

Should you encounter situations that have not been properly addressed in this User Manual, please contact our Customer Service Center, we will solve your specific problem. For more information, please visit the petgugu official website: **www.petgugu.com** or send email to the following email address: **service@petgugu.com**

The Company reserves the right to make technological and/or design changes to this product for continuous improvement.

IMPORTANT SAFETY INSTRUCTIONS

WARNING: Read all safety warnings and instructions. Failure to follow the warnings and instructions may result in electric shock, fire or serious injury.

READ ALL INSTRUCTIONS BEFORE USING THIS APPLIANCE.

For Household use only

When using an electrical appliance, basic precautions should always be followed, including the following:

1. The robot must be used in accordance with the directions in this User Manual. Our company cannot be held liable or responsible for any damages or injuries caused by improper use.
2. Do not allow to be used as a toy. Close attention is necessary when used by or near children.x
Do not allow children to sit on the vacuum.
3. Clear the area to be cleaned. Remove power cords and small objects from the floor that could entangle the Robot. Tuck rug fringe under the rug base, and lift items such as curtains and table cloths off the floor.
4. If there is a drop off in the cleaning area due to a step or stairs, you should operate the Robot to ensure that it can detect the step necessary to place a physical barrier at the edge to keep the unit from falling. Make sure the physical barrier is not a trip hazard.
5. Only use as described in this manual. Only use attachments recommended or sold by the manufacturer.
6. Please make sure your power supply voltage matches the power voltage marked on the Docking Station.
7. Do not handle or plug appliance with wet hands.
8. Non-rechargeable batteries are prohibited.
9. Do not use without dust bin and/or filters in place.
10. Do not operate the robot in an area where there are lit candles or fragile objects on the floor to be cleaned.
11. Do not use and store in extremely hot or cold environments (below -5°C /23°F or above 40°C/104°F). Please charge the robot in temperature above 0°C/32°F and below 40°C/104°F. Follow all charging instructions and do not charge the battery pack or appliance outside of the temperature range specified in the instructions. Charging improperly or at temperatures outside of the specified range may damage the battery and increase the risk of fire.
12. Keep hair, loose clothing, fingers, and all parts of body away from any openings and moving parts.
13. Do not operate the robot in a room where an infant or child is sleeping.
14. For INDOOR use ONLY. Do not use the robot in outdoor, commercial or industrial environments. Do not use Appliance on wet surfaces or surfaces with standing water.

15. Do not allow the robot to pick up large objects like stones, large pieces of paper or any item that may clog the robot.
16. Do not use the robot to pick up flammable or combustible materials such as gasoline, printer or copier toner, or use in areas where they may be present.
17. Do not use the robot to pick up anything that is burning or smoking, such as cigarettes, matches, hot ashes, or anything that could cause a fire.
18. Do not put any object into openings. Do not use with any opening blocked; keep free of dust, lint, hair, and anything that may reduce air flow.
19. Take care not to damage the power cord. Do not pull on or carry the robot or the Docking Station by the power cord, use the power cord as a handle, close a door on the power cord, or pull power cord around sharp edges or corners. Do not run the robot over the power cord. Keep power cord away from hot surfaces. Do not unplug by pulling on cord, To unplug, grasp the plug, not the cord.
20. If the power cord is damaged, it must be replaced by the manufacturer or its service agent in order to avoid a hazard.
21. Do not use the Docking Station if it is damaged.
22. Do not use the robot or the Docking Station if it is not working properly, has been dropped, damaged, left outdoors, or come in contact with water. It must be repaired by the manufacturer or its service agent in order to avoid a hazard.
23. Turn OFF the power switch before cleaning or maintaining the robot. Turn off all controls
24. The plug must be removed from the receptacle before cleaning or maintaining the Docking Station.
25. Remove the robot from the Docking Station, and turn OFF the power switch to the Appliance before removing the battery for disposal of the robot.
26. The battery must be removed and discarded according to local laws and regulations before disposal of the robot.
27. Please dispose of used batteries according to local laws and regulations.
28. Do not incinerate the robot even if it is severely damaged. The batteries can explode in a fire.
29. When not using the Docking Station for a long period of time, please unplug it.
30. Prevent unintentional starting. Ensure the switch is in the off position before connecting to battery pack, picking up or carrying the appliance. Carrying the robot with your finger on the switch or energizing the robot that have the switch on invites accidents.
31. When battery pack is not in use, keep it away from other metal objects, like paper clips, coins, keys, nails, screws, ect, that can make a connection from one terminal to another. Shorting the battery terminals together may cause burns or a fire.
32. Under abusive conditions, liquid may be ejected from the battery; avoid contact. If contact accidentally occurs,

flush with water. If liquid contacts eyes, additionally seek medical help. Liquid ejected from the battery may cause irritation or burns.

33. Do not use a battery pack that is damaged or modified. Damaged or modified batteries may exhibit unpredictable behavior resulting in fire, explosion or risk of injury.

34. Do not expose a battery pack or appliance to fire or excessive temperature. Exposure to fire or temperature above 130°C/265°F may cause explosion.

35. Have servicing performed by a qualified repair person using only identical replacement parts.

36. Do not modify or attempt to repair the robot or the battery pack (as applicable) except as indicated in the instructions.

37. Do not operate the robot in a room that has lit candles on furniture that the vacuum may accidentally hit or bump into.

38. Recharge only with the charger specified by the manufacturer. A charger that is suitable for one type of battery pack may create a risk of fire when used with another battery pack.

39. Use the robot only with specifically designated battery packs. Use of any other battery packs may create a risk of injury and fire.







40. The robot contains batteries that are only replaceable by skilled persons. To replace the robot's battery, please contact Customer Service.

41. If the robot is not going to be used for a long time, fully charge the robot, power it OFF, and unplug the Docking Station.

SAVE THESE INSTRUCTIONS

To satisfy RF exposure requirements, a separation distance of 20 cm or more should be maintained between this device and persons during device operation.

To ensure compliance, operations at closer than this distance is not recommended. The antenna used for this transmitter must not be co-located in conjunction with any other antenna or transmitter.

	Short-circuit-proof safety isolating transformer
	Switch mode power supply
	For indoor use only
	Direct current
	Alternating current
	detachable supply unit

Correct Disposal of this Product

This marking indicates that this product should not be disposed of with other household waste throughout the EU. To prevent possible harm to the environment or human health from uncontrolled waste disposal, recycle it responsibly to promote the sustainable reuse of material resources. To recycle your used device, please use the return and collection systems or contact the retailer where the product was purchased. They can safely recycle this product.



Federal Communications Commission (FCC) Interference Statement

This equipment has been tested and found to comply with the limits for a Class B digital device, pursuant to Part 15 of the FCC Rules.

These limits are designed to provide reasonable protection against harmful interference in a residential installation. This equipment generate, uses and can radiate radio frequency energy and, if not installed and used in accordance with the instructions, may cause harmful interference to radio communications.

However, there is no guarantee that interference will not occur in a particular installation. If this equipment does cause harmful interference to radio or television reception, which can be determined by turning the equipment off and on, the user is encouraged to try to correct the interference by one of the following measures:

- Reorient or relocate the receiving antenna.
- Increase the separation between the equipment and receiver.
- Connect the equipment into an outlet on a circuit different from that to which the receiver is connected.
- Consult the dealer or an experienced radio/TV technician for help.

This device complies with Part 15 of the FCC Rules. Operation is subject to the following two conditions:

- (1) This device may not cause harmful interference, and
- (2) this device must accept any interference received, including interference that may cause undesired operation.

FCC Caution:

Any changes or modifications not expressly approved by the party responsible for compliance could void the user's authority to operate this equipment.

RF exposure warning

This equipment complies with FCC radiation exposure limits set forth for an uncontrolled environment. This equipment must be installed and operated in accordance with provided instructions and the antenna(s) used for this transmitter must be installed and the antenna(s) used for this transmitter must be installed to provide a separation distance of at least 20 cm from all persons and must not be collocated or operating in conjunction with any other antenna or transmitter.

IC Caution:

This device contains licence-exempt transmitter(s)/receiver(s) that comply with Innovation, Science and Economic Development Canada's licence-exempt RSS(s). Operation is subject to the following two conditions:

(1) This device may not cause interference.

(2) This device must accept any interference, including interference that may cause undesired operation of the device. Any changes or modifications not expressly approved by the party responsible for compliance could void the user's authority to operate the equipment.

RF exposure statement:

The equipment complies with IC Radiation exposure limit set forth for uncontrolled environment. This equipment should be installed and operated with minimum distance 20cm between the radiator and your body.

Cet appareil contient des émetteurs / récepteurs exemptés de licence conformes aux RSS (RSS) d'Innovation, Sciences et Développement économique Canada. Le fonctionnement est soumis aux deux conditions suivantes:

(1) Cet appareil ne doit pas causer d'interférences.

(2) Cet appareil doit accepter toutes les interférences, y compris celles susceptibles de provoquer un fonctionnement indésirable de l'appareil.

Tout changement ou modification non expressément approuvé par la partie responsable de la conformité pourrait annuler l'autorité de l'utilisateur à utiliser l'équipement.

Déclaration d'exposition RF:

L'équipement est conforme à la limite d'exposition aux radiations de la IC établie pour un environnement non contrôlé. Cet équipement doit être installé et utilisé avec une distance minimale de 20cm entre le radiateur et votre corps.

Contents

1. Product introduction	8
1.1 Packing list	
1.2 Part name	
2. Preparation before use	11
2.1 Assembly and charging	
2.2 Environmental preparation	
3. Product use	13
3.1 Buttons operation and light effect and display state	
3.2 Use of virtual wall with magnetic stripe	
3.3 App download and networking	
3.4 Maintenance	
4. Anomalies	18
4.1 Troubleshooting	
5. Technical parameters	20

1. Product introduction / 1.1 Packing list

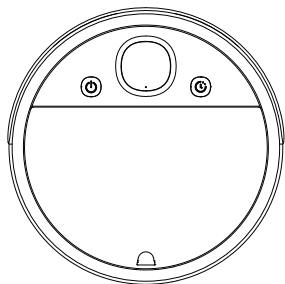

Robot

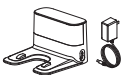

Charging base & power adapter



Dust bin



Virtual wall with magnetic stripe



High efficiency filter screen (HEPA)

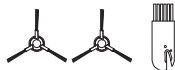

Side brush & cleaning tool



User manual

* The illustration in this manual is for reference only, and the actual appearance should be subject to the physical object.

1. Product introduction / 1.2 Part name

Front view

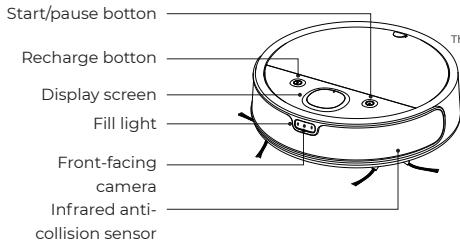

Internal view

Power switch
The green at the bottom of the button is in the startup state,
The red at the bottom of the button is in the shutdown state

Dust bin

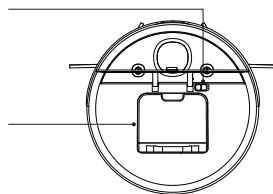

Bottom view

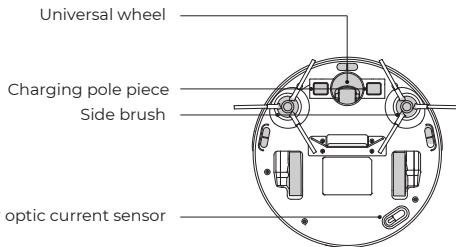
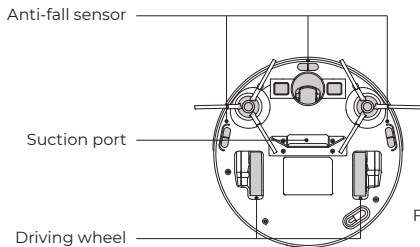

1. Product introduction / 1.2 Part name

Dust bin

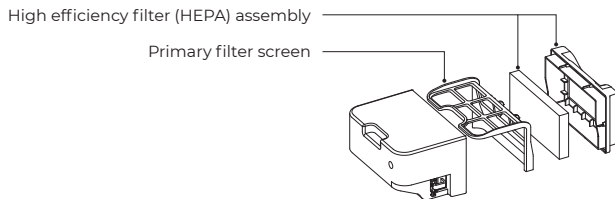

Charging base

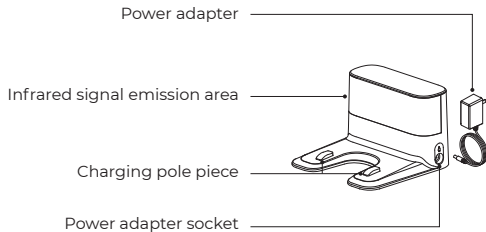

2. Preparation before use / 2.1 Assembly and charging

- 1** Remove the protective film on the robot and charging base



- 2** Install side brush

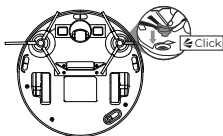

- 3** Place the charging base /connect the power supply

- * Place the charging base in an open area.
- * Connect the power supply and arrange the power cord.

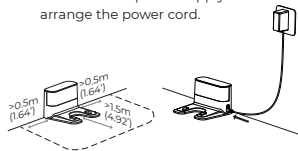

- 4** Turn on the power

Long press  button for 3s.

The button indicator is on and flashes for 3 times, and then you can hear the power-on voice prompt.

Note: If you press it for a long time and there is no response, please open the top flip cover of the robot to ensure that the bottom of power switch is in green startup state (the default state is open state).

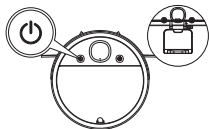

- 5** Charging

Place the robot to the charging base and pay attention to aligning with the charging pole piece. The charging time is about 4.5h.

Note: Please note that the robot cannot be charged when the power switch is turned off.

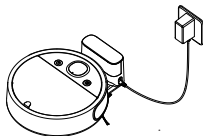

2. Preparation before use / 2.2 Using environment preparation

Sort out the space to be cleaned

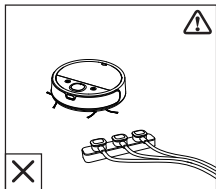

Sort out the articles on the floor, such as wires, slippers and other sundries, so as to avoid affecting the operation of the robot.

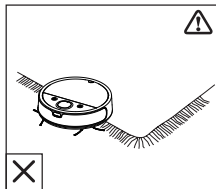

If the carpet at home has tassel edges, please put the edges under the carpet in advance.

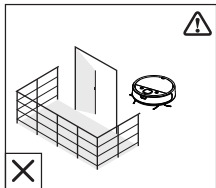

Please do not let the robot operate on wet and suspended floors, and close the doors of toilets and balconies.

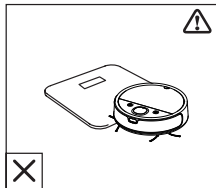

The robot can climb to the top of objects less than 12mm thick. If you don't want the robot to climb on them, please take them away.

3. Product use / 3.1 Buttons operation and display screen state



Long press  button for 3s:

Click  button:

Double click  button:

Click  button:

Long press  button for 6s:

Long press  button and  button
for 3s at the same time:

Turn on/off

Start/pause





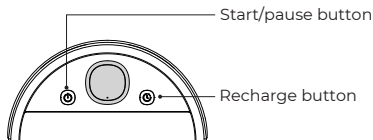

Fixed-point cleaning

Enter recharge mode

Switch the broadcast language
(Chinese/English/Japanese)

enter the networking mode



Robot state	Start/pause button light display state	Recharge button light display state	Display screen state
Start up	White light flashes slowly for three times and then goes out		
In cleaning	No light		
In charging	No light		
Automatic recharge	No light		
Error	Red light is always on	No light	
Error	Red light flashes	No light	
Enter the networking state	White light flashes slowly		WiFi
Successful networking	No light		

3. Product use / 3.2 Use of virtual wall with magnetic stripe

- 1 The virtual wall with magnetic stripe can be used to isolate any areas not to be cleaned (bathrooms with wet floors or areas that may jam the robot). In the area where you don't want the robot to enter and clean, stick the virtual wall with magnetic stripe along the entrance.

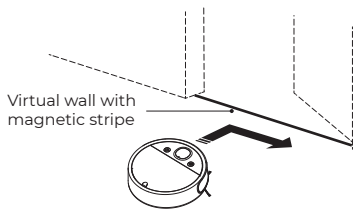

- 2 Please fix the virtual wall with magnetic stripe on the ground to prevent it from breaking away; otherwise, the use effect of the virtual wall with magnetic stripe will be affected.

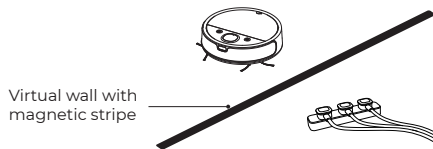

- 3 If necessary, cut the magnetic stripe short with scissors. Be sure to measure the length correctly before cutting.

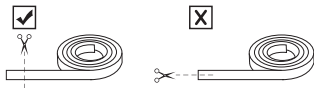

3. Product use / 3.3 App download and networking

Downloading and installation of the "petgugu" app

Method I : Scan the following QR code, and then download and install App as prompted.



Method II : Search "petgugu" in the App store, download and install the petgugu app.

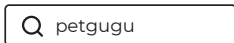

Note: The robot works with 2.4GHz Wi-Fi networks only.

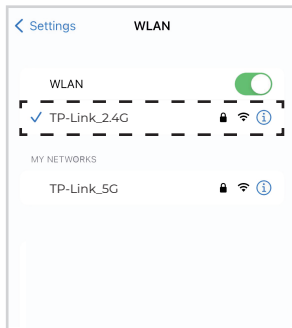

Tips:

- * Follow the guidance in the petgugu app to register, login, and pair the robot.
- * Please make sure that the mobile phone is connected to your Wi-Fi network before pairing the robot vacuum cleaner.

3. Product use / 3.4 Maintenance

* When cleaning and maintaining the robot and its accessories, please unplug the power supply of the charging base.



- 1 Open the robot surface cover and take out the dust bin.

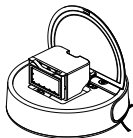

- 2 Remove the dust filter assembly.

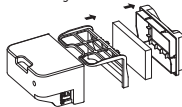

- 3 Dump rubbish.



- 4 Clean the primary filter screen.



- 5 Clean the high-efficiency filter screen.



3. Product use / 3.4 Maintenance

* When cleaning and maintaining the robot and its accessories, please unplug the power supply of the charging base.

1. Clean the anti-fall sensor to ensure its sensitivity.

2. Clean the charging pole piece to ensure smooth charging.

3. Clean the universal wheel to prevent hair entanglement.

4. Clean the suction port to ensure the cleaning effect.

5. Clean the driving wheels and keep them clean smoothly.

6. Clean the fiber optic current sensor to ensure its sensitivity.

7. Clean the side brush to prevent hair entanglement.



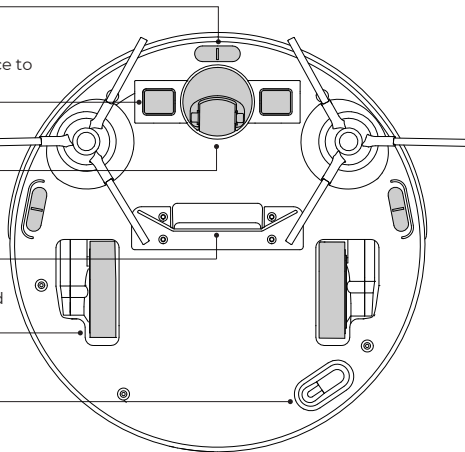

8. Clean the charging pole piece of the charging base to ensure smooth charging.



4. Anomalies / 4.1 Troubleshooting

In the process of using the product, if the following problems occur, you can check them accordingly and solve them independently.

S/N	Failure condition	Possible cause	Solution
1	Cleaning ability decreases or ash falls	Cleaning assembly is blocked.	It is recommended to replace consumables regularly, such as high efficiency filter screen (HEPA), primary filter screen, side brush, etc.
		Sensor and other components are covered with dust.	Refer to the section [maintenance] in the manual to clean the robot and other components.
2	Unable to connect to App	The home Wi-Fi user name or password entered is incorrect.	Please enter the correct Wi-Fi user name and password.
		The robot is out of Wi-Fi signal range.	Make sure the robot is within Wi-Fi signal range.
		When the network is connected, the robot has not entered the networking mode.	Long press  button and  button for 3s at the same time: enter the networking mode. For details, refer to the section [App download and networking] in the manual.
		The 2.4 GHz network is not used.	Switch to 2.4GHz network. For details, please refer to the section [App download and networking] in the manual.
3	Difficulty in recharging	The charging base is not placed correctly.	Please place the charging base in an open and flat area.
		The charging base is powered off or moved artificially.	Please check whether the charging base is connected to the power supply, and do not move the charging base position artificially when the robot is working.
		The home is too large and the environment is complex.	Before using the robot, please refer to the section [environmental preparation] in the manual to organize the home environment.
		The robot does not clean from the charging base.	It is recommended that the robot should start sweeping from the charging base.



4. Anomalies / 4.1 Troubleshooting

In the process of using the product, if the following problems occur, you can check them accordingly and solve them independently.

S/N	Failure condition	Possible cause	Solution
4	Unable to charge	The power supply is not connected, and the plug is loose.	Check that both ends of the power adapter are connected and powered on normally.
		The contact between the robot and the charging pole piece of the charging base is poor.	Ensure that the robot and the charging pole piece of the charging base are fully interacted, and regularly clean the robot and the charging pole piece of the charging base.
		If you don't use it for a long time, the battery will decline.	It is recommended to use this product frequently. If it is not used for a long time, please turn off the power switch under the surface cover after it is fully charged. Keep charging once a month. If the battery cannot be charged, please contact the after-sales service personnel.

* If you can't clear trouble according to the table, you can contact the after-sales service personnel.

5. Technical parameters

Product model	PIS		
Rated input of machine	19V  1A, 19W		
Docking Station Model	C3		
Rated Output Voltage	19V 	Rated Output Current	1A
Power Adapter Model	AD-0191900100US		
Power Adapter Input	100-240V~ 50-60Hz 0.8A		
Power Adapter Output	DC 19V, 1A, CLASS II		

Note: Since the product needs continuous improvement, the actual product shall prevail.
Our company reserves the right to update the product.

Warranty

This warranty covers the repair or replacement of the malfunction device at our company's discretion for a period of 1-year. In addition this certificate is void if altered. The serial number must be provided as well as all accessories to be eligible for warranty coverage. Please kindly fill in below form accurately and completely.

Order Number: _____

Serial Number: _____

Date of Purchase: _____

Important:

When returning this device, carefully pack the product to avoid damage in shipping. Damage in shipping is not covered by the Warranty and shall be the sole responsibility of Buyer. Damage or loss not covered by this Warranty or occurring outside the Warranty Period will require a fee to cover the cost of handling and shipping. All such fees and costs shall be the sole responsibility of Buyer.

Exclusion

Unless agreed in writing, the warranty will not apply if the defects relate to:

- Consumable parts such as filters, or brushes etc, that are subject to normal wear and tear, and require regular maintenance and/or replacement to ensure the proper functioning of your unit.
- Defects caused by rough or inappropriate handling or use or damage caused by accident, misuse, neglect, fire, water, lighting or other acts of nature, external sources such as weather, electrical outages or power surges.
- Improper operation or maintenance, use not in accordance with the product instructions or connection to improper voltage supply.
- Accident, abuse, misapplication, or any unauthorized repair, modification, or disassembly of the product.
- Any failure to adequately package the Product for transportation.
- Use of parts not in accordance with the product instructions.
- Use of parts and accessories other than those produced or recommended by our company.
- Use in a commercial environment as the Product is designed for residential use only.
- Consequential and incidental damages.
- Any product(s) purchased from unauthorized dealers/resellers.
- Products used outside the country of purchase.
- Lost and/or stolen products.



Scannen Sie den QR-Code, um das Online-Handbuch auf Deutsch zu erhalten.

Scannez le QR code pour obtenir le manuel en ligne en français.

Scansiona il codice QR per ottenere il manuale online in italiano.

Escanee el código QR para obtener el manual en línea en español.

コードをスキャンして、日本語のオンライン マニュアルを取得します。

🌐 Website: www.petgugu.com

✉ Email: service@petgugu.com