

# TEST REPORT

Report No. .... : KD2303S1274E02  
FCC ID ..... : 2AZ2R-N  
Applicant ..... : Shenzhen USEER Robotics Co.,Ltd.  
Address ..... : Building 2, Fashion Brand Industrial Park, E'Bu Town, Shenzhen-Shanwei Special Cooperation Zone, Shenzhen, Guangdong, China.  
Manufacturer ..... : Shenzhen USEER Robotics Co.,Ltd.  
Address ..... : Building 2, Fashion Brand Industrial Park, E'Bu Town, Shenzhen-Shanwei Special Cooperation Zone, Shenzhen, Guangdong, China.  
Product Name ..... : Robotic Vacuum Cleaner  
Trademark ..... : USEER, OKP, Lefant, PETGUGU  
Model/Type reference ..... : N3, L5,N\*,N\*\*,L\*,L\*\*(\*=9-0 or A-Z)  
Standard ..... : 47 CFR Part 15.247  
Date of Receipt ..... : March 14, 2023  
Date of Test Date ..... : March 14, 2023 to April 3, 2023  
Date of issue ..... : April 3, 2023  
**Test result** ..... : **Pass**

Prepared by:  
( Printed name + Signature )      Pai Zheng



Approved by:  
( Printed name + Signature )      Sky Dong



**Testing Laboratory Name** . : **KSIGN(Guangdong) Testing Co., Ltd.**

Address ..... : West Side of 1/F., Building C, Zone A, Fuyuan New Factory, Jiujiu Industrial Park, Minzhu, Shatou, Shajing, Bao'an District, Shenzhen, Guangdong, China

This test report may be duplicated completely for legal use with the approval of the applicant. It should not be reproduced except in full, without the written approval of our laboratory. The client should not use it to claim product endorsement by KSIGN. The test results in the report only apply to the tested sample. The test report shall be invalid without all the signatures of testing engineers, reviewer and approver. Any objections must be raised to KSIGN within 15 days since the date when the report is received. It will not be taken into consideration beyond this limit. The test report merely corresponds to the test sample. The report is invalid if it is not stamped with the "Testing Special Stamp" and the "Riding Seam Stamp".

**TABLE OF CONTENTS**

**Page**

<b>1. TEST SUMMARY .....</b>	<b>3</b>
1.1. Test Standards .....	3
1.2. Report Version .....	3
1.3. Test Description.....	4
1.4. Test Facility .....	5
1.5. Measurement Uncertainty.....	6
<b>2. GENERAL INFORMATION .....</b>	<b>6</b>
2.1. General Description Of EUT .....	6
2.2. Accessory Equipment Information .....	6
2.3. Description of Test Modes.....	6
2.4. Measurement Instruments List.....	7
<b>3. Evaluation Results (Evaluation) .....</b>	<b>11</b>
3.1. Antenna requirement.....	11
<b>4. Radio Spectrum Matter Test Results (RF) .....</b>	<b>11</b>
4.1. Conducted Emission at AC power line.....	11
4.2. Occupied Bandwidth .....	15
4.3. Maximum Conducted Output Power .....	16
4.4. Power Spectral Density.....	18
4.5. Emissions in non-restricted frequency bands .....	19
4.6. Band edge emissions (Radiated).....	21
4.7. Emissions in restricted frequency bands (below 1GHz) .....	26
4.8. Emissions in restricted frequency bands (above 1GHz).....	29
<b>5. EUT TEST PHOTOS.....</b>	<b>36</b>
<b>6. PHOTOGRAPHS OF EUT CONSTRUCTIONAL.....</b>	<b>38</b>
<b>Appendix .....</b>	<b>39</b>
6.1. Appendix A: DTS Bandwidth .....	40
6.2. Appendix B: Occupied Channel Bandwidth .....	43
6.3. Appendix C: Maximum conducted output power .....	46
6.4. Appendix D: Maximum power spectral density .....	49
6.5. ppendix E: Reference level measurement.....	52
6.6. Appendix F: Band edge measurements.....	55
6.7. Appendix G: Conducted Spurious Emission .....	57
6.8. Appendix H: Duty Cycle .....	61

# 1. TEST SUMMARY

## 1.1. Test Standards

The tests were performed according to following standards:

**47 CFR Part 15.247:** Operation within the bands 902-928 MHz, 2400-2483.5 MHz, and 5725-5850 MHz

## 1.2. Report Version

Revised No.	Date of issue	Description
01	April 3, 2023	Original

### 1.3. Test Description

Test Item	Standard	Requirement	Result
Antenna requirement	47 CFR Part 15.247	Part 15.203	Pass
Conducted Emission at AC power line	47 CFR Part 15.247	47 CFR 15.207(a)	Pass
Occupied Bandwidth	47 CFR Part 15.247	47 CFR 15.247(a)(2)	Pass
Maximum Conducted Output Power	47 CFR Part 15.247	47 CFR 15.247(b)(3)	Pass
Power Spectral Density	47 CFR Part 15.247	47 CFR 15.247(e)	Pass
Emissions in non-restricted frequency bands	47 CFR Part 15.247	47 CFR 15.247(d)	Pass
Band edge emissions (Radiated)	47 CFR Part 15.247	47 CFR 15.247(d)	Pass
Emissions in restricted frequency bands (below 1GHz)	47 CFR Part 15.247	47 CFR 15.247(d)	Pass
Emissions in restricted frequency bands (above 1GHz)	47 CFR Part 15.247	47 CFR 15.247(d)	Pass

TRF RF\_R1

Add: West Side of 1/F., Building C, Zone A, Fuyuan New Factory, Jiujiu Industrial Park, Minzhu, Shatou, Shajing, Bao'an District, Shenzhen, Guangdong, China

Tel: +(86) 0755-2985 2678 Fax: +(86) 0755-2985 2397 E-mail: info@gdksign.cn Web: www.gdksign.com

## 1.4. Test Facility

### **KSIGN(Guangdong) Testing Co., Ltd.**

West Side of 1/F., Building C, Zone A, Fuyuan New Factory, Jiujiu Industrial Park, Minzhu, Shatou, Shajing, Bao'an District, Shenzhen, Guangdong, China

The test facility is recognized, certified, or accredited by the following organizations:

#### **CNAS-Lab Code: L13261**

KSIGN(Guangdong) Testing Co., Ltd. has been assessed and proved to be in Compliance with CNAS-CL01 Accreditation Criteria for Testing and Calibration Laboratories (identical to ISO/IEC17025: 2017 General Requirements) for the Competence of Testing and Calibration Laboratories.

#### **A2LA-Lab Cert. No.: 5457.01**

KSIGN(Guangdong) Testing Co., Ltd. EMC Laboratory has been accredited by A2LA for technical competence in the field of electrical testing, and proved to be in compliance with ISO/IEC 17025:2017 General Requirements for the Competence of Testing and Calibration Laboratories and any additional program requirements in the identified field of testing

#### **ISED#: 25693 CAB identifier.: CN0096**

KSIGN(Guangdong) Testing Co., Ltd. has been listed by Innovation, Science and Economic Development Canada to perform electromagnetic emission measurement.

#### **FCC-Registration No.: 294912 Designation Number: CN1328**

KSIGN(Guangdong) Testing Co., Ltd. EMC Laboratory has been listed on the US Federal Communications Commission list of test facilities recognized to perform electromagnetic emissions measurements.

## 1.5. Measurement Uncertainty

Test Items	Measurement Uncertainty
Conducted Emission (150k-30MHz)	± 3.34dB
Output Power, Conducted	± 1.4dB
PSD, Conducted	± 1.0dB
Spurious Emissions, Conducted	± 3.3dB
RSE (1-18GHz)	± 4.68dB
RSE (30-1000MHz)	± 5.7dB
RSE (18-40GHz)	± 5.18dB

The reported uncertainty of measurement  $y \pm U$ , where expanded uncertainty  $U$  is based on a standard uncertainty multiplied by a coverage factor of  $k=2$ , providing a level of confidence of approximately 95 %.

## 2. GENERAL INFORMATION

### 2.1. General Description Of EUT

Test Sample Number:	1-1(Normal Sample), 1-2(Engineering Sample)
Product Name:	Robotic Vacuum Cleaner
Trademark:	USEER, OKP, Lefant, PETGUGU
Model / Type reference:	N3, L5,N*,N**,L*,L**(*=9-0 or A-Z)
Model Difference:	The only difference between product models is the color and appearance. Different model names are available to meet market demands. Other power supply methods, internal structures, circuits and key components are the same, and do not affect safety and electromagnetic compatibility performance.
Power Supply:	DC 14.4V from battery
Operation Frequency:	2402MHz to 2480MHz
Number of Channels:	40
Test Channel:	CH00:2402MHz, CH19:2440MHz, CH39:2480MHz
Modulation Type:	GFSK
Antenna Type:	PCB
Antenna Gain:	1.79dBi
Max TX Power:	4.91dBm

### 2.2. Accessory Equipment Information

The EUT was tested as an independent device.

### 2.3. Description of Test Modes

No.	Title	Description of Mode
Test Mode1	TX mode	Keep the EUT connect to AC power line and works in continuously transmitting mode with GFSK modulation.

## 2.4. Measurement Instruments List

Conducted Emission at AC power line				
Test Equipment	Manufacturer	Model No.	Serial No.	Cal. Until
LISN	R&S	ENV432	1326.6105.02	2024-02-17
EMI Test Receiver	R&S	ESR	102524	2024-02-17
Manual RF Switch	JS TOYO	/	MSW-01/002	2024-02-17
ISN CAT6	Schwarzbeck	CAT5 8158	227	2024-02-17
Color Signal Generator	Philips	PM5418	672926	2024-02-17
Power Absorbing Clamp	R&S	MDS-21	100925	2024-02-19

Occupied Bandwidth				
Test Equipment	Manufacturer	Model No.	Serial No.	Cal. Until
Wideband Radio Communication Tester	R&S	CMU200	115297	2024-02-17
Audio Analyzer	R&S	UPL16	100001	2024-02-17
Shielding box	Gxiong	GX-5915A	2201113	2024-02-17
High Pass Filter	COM-MW Technology Co., Ltd	ZHPF-M1.2-9G-187	09203403	2024-02-17
Band Stop Filter	COM-MW Technology Co., Ltd	ZBSF6-C820-920-188	09203401	2024-02-17
Splitter	COM-MW Technology Co., Ltd	ZPD-M1-8-2103	09203407	2024-02-17
Coaxial Cable	BEBES	A40-2.92M2.92F-4.5M	1907021	2024-02-17
Hygrothermograph	Anymetre	JB913	/	2024-02-17
Climate Chamber	Angul	AGNH80L	1903042120	2024-02-17
Spectrum Analyzer	HP	8593E	3831U02087	2024-02-17
Dual Output DC Power Supply	Agilent	E3646A	MY40009992	2024-02-17
RF Control Unit	Tonscend	JS0806-2	/	2024-02-17
Analog Signal Generator	HP	83752A	3344A00337	2024-02-17
Vector Signal Generator	Agilent	N5182A	MY50142520	2024-02-17
Wideband Radio Communication Tester	R&S	CMW500	157282	2024-02-17
Spectrum Analyzer	R&S	FSV40-N	101798	2024-02-17

Maximum Conducted Output Power				
Test Equipment	Manufacturer	Model No.	Serial No.	Cal. Until
Wideband Radio Communication Tester	R&S	CMU200	115297	2024-02-17
Audio Analyzer	R&S	UPL16	100001	2024-02-17
Shielding box	Gxiong	GX-5915A	2201113	2024-02-17
High Pass Filter	COM-MW Technology Co., Ltd	ZHPF-M1.2-9G-187	09203403	2024-02-17
Band Stop Filter	COM-MW Technology Co., Ltd	ZBSF6-C820-920-188	09203401	2024-02-17
Splitter	COM-MW Technology Co., Ltd	ZPD-M1-8-2103	09203407	2024-02-17
Coaxial Cable	BEBES	A40-2.92M2.92F-4.5M	1907021	2024-02-17

TRF RF\_R1

Add: West Side of 1/F., Building C, Zone A, Fuyuan New Factory, Jiujiu Industrial Park, Minzhu, Shatou, Shajing, Bao'an District, Shenzhen, Guangdong, China

Tel: +(86) 0755-2985 2678 Fax: +(86) 0755-2985 2397 E-mail: info@gdksign.cn Web: www.gdksign.com

Hygrothermograph	Anymetre	JB913	/	2024-02-17
Climate Chamber	Angul	AGNH80L	1903042120	2024-02-17
Spectrum Analyzer	HP	8593E	3831U02087	2024-02-17
Dual Output DC Power Supply	Agilent	E3646A	MY40009992	2024-02-17
RF Control Unit	Tonscend	JS0806-2	/	2024-02-17
Analog Signal Generator	HP	83752A	3344A00337	2024-02-17
Vector Signal Generator	Agilent	N5182A	MY50142520	2024-02-17
Wideband Radio Communication Tester	R&S	CMW500	157282	2024-02-17
Spectrum Analyzer	R&S	FSV40-N	101798	2024-02-17

Power Spectral Density				
Test Equipment	Manufacturer	Model No.	Serial No.	Cal. Until
Wideband Radio Communication Tester	R&S	CMU200	115297	2024-02-17
Audio Analyzer	R&S	UPL16	100001	2024-02-17
Shielding box	Gxiong	GX-5915A	2201113	2024-02-17
High Pass Filter	COM-MW Technology Co., Ltd	ZHPF-M1.2-9G-187	09203403	2024-02-17
Band Stop Filter	COM-MW Technology Co., Ltd	ZBSF6-C820-920-188	09203401	2024-02-17
Splitter	COM-MW Technology Co., Ltd	ZPD-M1-8-2103	09203407	2024-02-17
Coaxial Cable	BEBES	A40-2.92M2.92F-4.5M	1907021	2024-02-17
Hygrothermograph	Anymetre	JB913	/	2024-02-17
Climate Chamber	Angul	AGNH80L	1903042120	2024-02-17
Spectrum Analyzer	HP	8593E	3831U02087	2024-02-17
Dual Output DC Power Supply	Agilent	E3646A	MY40009992	2024-02-17
RF Control Unit	Tonscend	JS0806-2	/	2024-02-17
Analog Signal Generator	HP	83752A	3344A00337	2024-02-17
Vector Signal Generator	Agilent	N5182A	MY50142520	2024-02-17
Wideband Radio Communication Tester	R&S	CMW500	157282	2024-02-17
Spectrum Analyzer	R&S	FSV40-N	101798	2024-02-17

Emissions in non-restricted frequency bands				
Test Equipment	Manufacturer	Model No.	Serial No.	Cal. Until
Wideband Radio Communication Tester	R&S	CMU200	115297	2024-02-17
Audio Analyzer	R&S	UPL16	100001	2024-02-17
Shielding box	Gxiong	GX-5915A	2201113	2024-02-17
High Pass Filter	COM-MW Technology Co., Ltd	ZHPF-M1.2-9G-187	09203403	2024-02-17
Band Stop Filter	COM-MW Technology Co., Ltd	ZBSF6-C820-920-188	09203401	2024-02-17
Splitter	COM-MW Technology Co., Ltd	ZPD-M1-8-2103	09203407	2024-02-17

TRF RF\_R1

Add: West Side of 1/F., Building C, Zone A, Fuyuan New Factory, Jiujiu Industrial Park, Minzhu, Shatou, Shajing, Bao'an District, Shenzhen, Guangdong, China

Tel: +(86) 0755-2985 2678 Fax: +(86) 0755-2985 2397 E-mail: info@gdkesign.cn Web: www.gdkesign.com



Coaxial Cable	BEBES	A40-2.92M2.92F-4.5M	1907021	2024-02-17
Hygrothermograph	Anymetre	JB913	/	2024-02-17
Climate Chamber	Angul	AGNH80L	1903042120	2024-02-17
Spectrum Analyzer	HP	8593E	3831U02087	2024-02-17
Dual Output DC Power Supply	Agilent	E3646A	MY40009992	2024-02-17
RF Control Unit	Tonscend	JS0806-2	/	2024-02-17
Analog Signal Generator	HP	83752A	3344A00337	2024-02-17
Vector Signal Generator	Agilent	N5182A	MY50142520	2024-02-17
Wideband Radio Communication Tester	R&S	CMW500	157282	2024-02-17
Spectrum Analyzer	R&S	FSV40-N	101798	2024-02-17

Band edge emissions (Radiated)				
Test Equipment	Manufacturer	Model No.	Serial No.	Cal. Until
Color Signal Generator	Philips	PM5418	672926	2024-02-17
Ultra-Broadband logarithmic period Antenna	Schwarzbeck	VULB 9163	1230	2025-02-18
Pre-Amplifier	Schwarzbeck	BBV 9745	9745#129	2024-02-17
Broadcast Television Signal Generator	R&S	SFE100	141038	2024-02-17
Analog Signal Generator	Agilent	8648A	3847M00445	2024-02-17
EMI Test Receiver	R&S	ESR	102525	2024-02-17
Loop Antenna	Beijin ZHINAN	ZN30900C	18050	2024-02-19
Horn Antenna	Schwarzbeck	BBHA 9120 D	2023	2026-02-19
Pre-Amplifier	EMCI	EMC051835SE	980662	2024-02-17
Spectrum Analyzer	Keysight	N9020A	MY46471971	2024-02-17

Emissions in restricted frequency bands (below 1GHz)				
Test Equipment	Manufacturer	Model No.	Serial No.	Cal. Until
Color Signal Generator	Philips	PM5418	672926	2024-02-17
Ultra-Broadband logarithmic period Antenna	Schwarzbeck	VULB 9163	1230	2025-02-18
Pre-Amplifier	Schwarzbeck	BBV 9745	9745#129	2024-02-17
Broadcast Television Signal Generator	R&S	SFE100	141038	2024-02-17
Analog Signal Generator	Agilent	8648A	3847M00445	2024-02-17
EMI Test Receiver	R&S	ESR	102525	2024-02-17
Loop Antenna	Beijin ZHINAN	ZN30900C	18050	2024-02-19
Horn Antenna	Schwarzbeck	BBHA 9120 D	2023	2026-02-19
Pre-Amplifier	EMCI	EMC051835SE	980662	2024-02-17
Spectrum Analyzer	Keysight	N9020A	MY46471971	2024-02-17

Emissions in restricted frequency bands (above 1GHz)				
Test Equipment	Manufacturer	Model No.	Serial No.	Cal. Until

TRF RF\_R1

Add: West Side of 1/F., Building C, Zone A, Fuyuan New Factory, Jiujiu Industrial Park, Minzhu, Shatou, Shajing, Bao'an District, Shenzhen, Guangdong, China

Tel: +(86) 0755-2985 2678 Fax: +(86) 0755-2985 2397 E-mail: info@gdkesign.cn Web: www.gdkesign.com

Color Signal Generator	Philips	PM5418	672926	2024-02-17
Ultra-Broadband logarithmic period Antenna	Schwarzbeck	VULB 9163	1230	2025-02-18
Pre-Amplifier	Schwarzbeck	BBV 9745	9745#129	2024-02-17
Broadcast Television Signal Generator	R&S	SFE100	141038	2024-02-17
Analog Signal Generator	Agilent	8648A	3847M00445	2024-02-17
EMI Test Receiver	R&S	ESR	102525	2024-02-17
Loop Antenna	Beijin ZHINAN	ZN30900C	18050	2024-02-19
Horn Antenna	Schwarzbeck	BBHA 9120 D	2023	2026-02-19
Pre-Amplifier	EMCI	EMC051835SE	980662	2024-02-17
Spectrum Analyzer	Keysight	N9020A	MY46471971	2024-02-17

TRF RF\_R1

Add: West Side of 1/F., Building C, Zone A, Fuyuan New Factory, Jiujiu Industrial Park, Minzhu, Shatou, Shajing, Bao'an District, Shenzhen, Guangdong, China

Tel: +(86) 0755-2985 2678 Fax: +(86) 0755-2985 2397 E-mail: info@gdkesign.cn Web: www.gdkesign.com

### 3. Evaluation Results (Evaluation)

#### 3.1. Antenna requirement

Test Requirement:	An intentional radiator shall be designed to ensure that no antenna other than that furnished by the responsible party shall be used with the device. The use of a permanently attached antenna or of an antenna that uses a unique coupling to the intentional radiator shall be considered sufficient to comply with the provisions of this section.
Conclusion:	The directional gain of the antenna less than 6dBi, please refer to the EUT internal photographs antenna photo.

### 4. Radio Spectrum Matter Test Results (RF)

#### 4.1. Conducted Emission at AC power line

Test Requirement:	Except as shown in paragraphs (b) and (c) of this section, for an intentional radiator that is designed to be connected to the public utility (AC) power line, the radio frequency voltage that is conducted back onto the AC power line on any frequency or frequencies, within the band 150 kHz to 30 MHz, shall not exceed the limits in the following table, as measured using a 50 $\mu$ H/50 ohms line impedance stabilization network (LISN).		
Test Limit:	Frequency of emission (MHz)	Conducted limit (dB $\mu$ V)	
		Quasi-peak	Average
	0.15-0.5	66 to 56*	56 to 46*
	0.5-5	56	46
	5-30	60	50
	*Decreases with the logarithm of the frequency.		
Test Method:	Refer to ANSI C63.10-2013 section 6.2, standard test method for ac power-line conducted emissions from unlicensed wireless devices		

##### 4.1.1. E.U.T. Operation:

Operating Environment:	
Temperature:	23.5 °C
Humidity:	51.7 %
Atmospheric Pressure:	101 kPa
Final test mode:	Test Mode1

**4.1.2. Test Setup Diagram:**

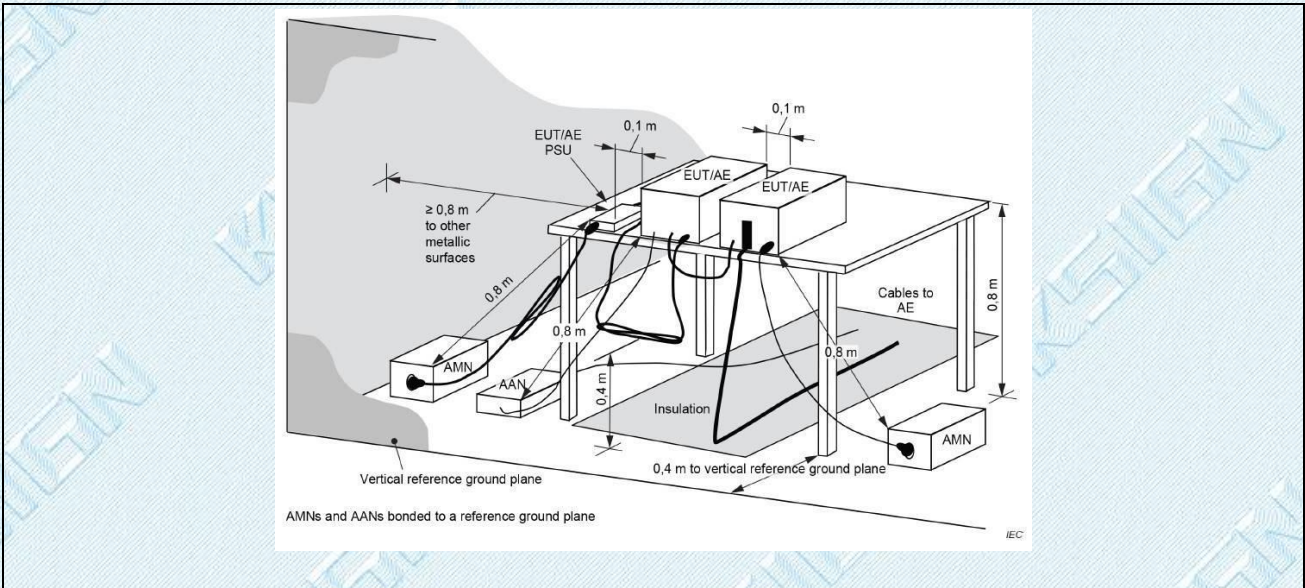

**Remark:**

1. Both 120 VAC, 50/60 Hz power supply have been tested, only the worst result of 120 VAC, 60 Hz was reported as below.
2. Measurement = Reading Level+ Correct Factor
3. Over = Measurement -Limit

4.1.3. Test Data:

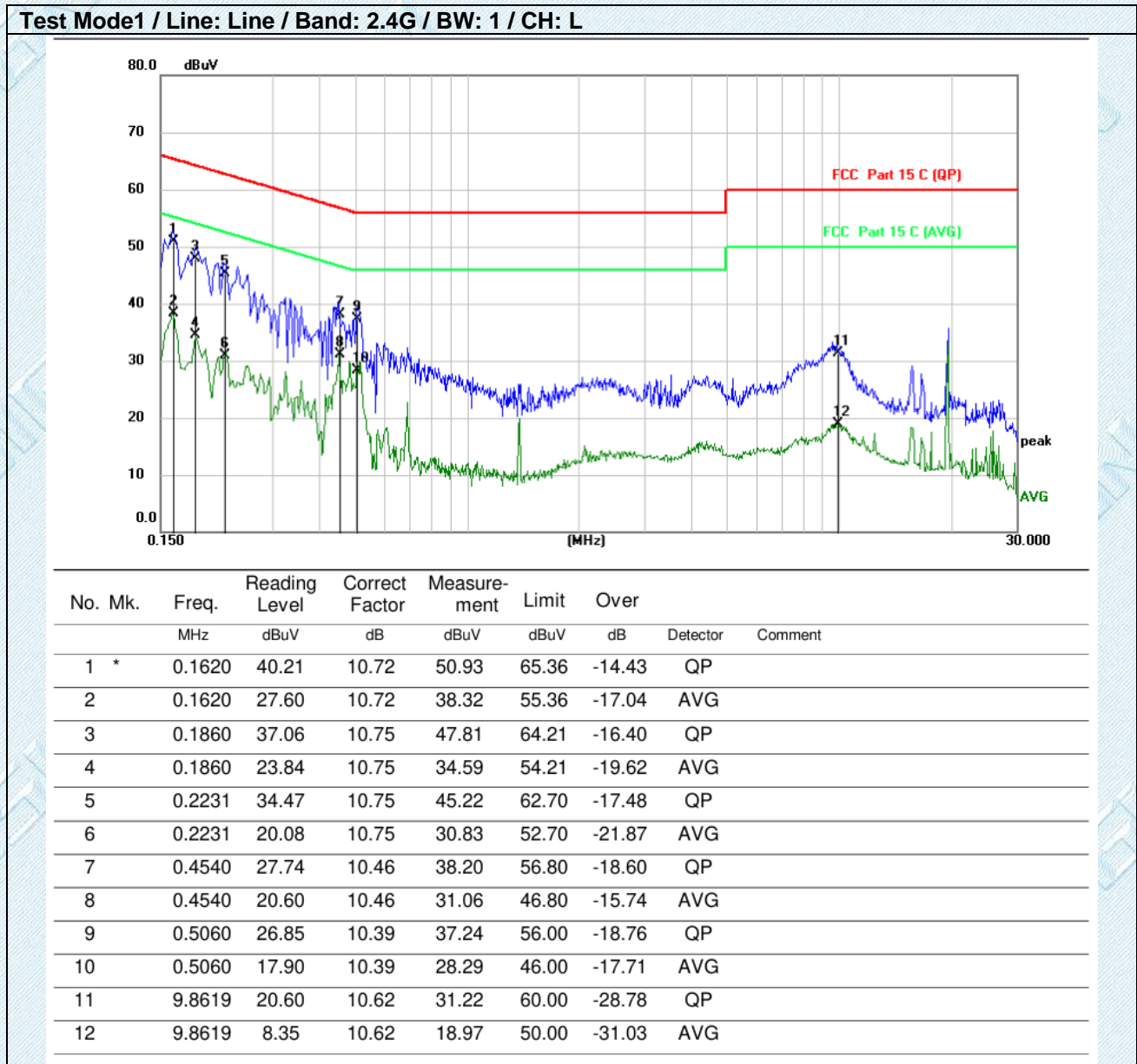

TRF RF\_R1

Add: West Side of 1/F., Building C, Zone A, Fuyuan New Factory, Jiujiu Industrial Park, Minzhu, Shatou, Shajing, Bao'an District, Shenzhen, Guangdong, China

Tel: +(86) 0755-2985 2678 Fax: +(86) 0755-2985 2397 E-mail: info@gdksign.cn Web: www.gdksign.com

Test Mode1 / Line: Neutral / Band: 2.4G / BW: 1 / CH: L

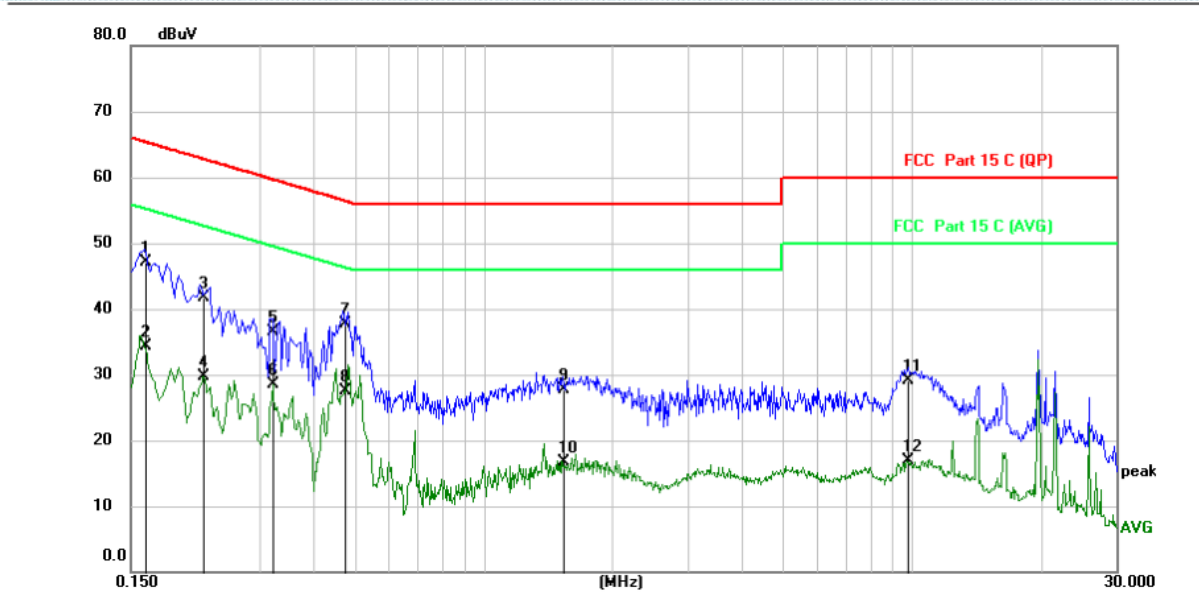

No.	Mk.	Freq. MHz	Reading Level dBuV	Correct Factor dB	Measure- ment dBuV	Limit dBuV	Over dB	Detector	Comment
1	*	0.1620	36.37	10.71	47.08	65.36	-18.28	QP	
2		0.1620	23.52	10.71	34.23	55.36	-21.13	AVG	
3		0.2220	31.02	10.73	41.75	62.74	-20.99	QP	
4		0.2220	19.06	10.73	29.79	52.74	-22.95	AVG	
5		0.3220	26.07	10.52	36.59	59.66	-23.07	QP	
6		0.3220	17.91	10.52	28.43	49.66	-21.23	AVG	
7		0.4740	27.21	10.52	37.73	56.44	-18.71	QP	
8		0.4740	17.01	10.52	27.53	46.44	-18.91	AVG	
9		1.5300	17.22	10.50	27.72	56.00	-28.28	QP	
10		1.5300	6.21	10.50	16.71	46.00	-29.29	AVG	
11		9.7379	18.60	10.59	29.19	60.00	-30.81	QP	
12		9.7379	6.41	10.59	17.00	50.00	-33.00	AVG	

TRF RF\_R1

Add: West Side of 1/F., Building C, Zone A, Fuyuan New Factory, Jiujiu Industrial Park, Minzhu, Shatou, Shajing, Bao'an District, Shenzhen, Guangdong, China

Tel: +(86) 0755-2985 2678 Fax: +(86) 0755-2985 2397 E-mail: info@gdksign.cn Web: www.gdksign.com

## 4.2. Occupied Bandwidth

Test Requirement:	Systems using digital modulation techniques may operate in the 902-928 MHz, and 2400-2483.5 MHz bands. The minimum 6 dB bandwidth shall be at least 500 kHz.
Test Limit:	Section (a)(2), Systems using digital modulation techniques may operate in the 902-928 MHz, and 2400-2483.5 MHz bands. The minimum 6 dB bandwidth shall be at least 500 kHz.
Test Method:	DTS bandwidth
Procedure:	<ul style="list-style-type: none"> <li>a) Set RBW = 100 kHz.</li> <li>b) Set the VBW <math>\geq</math> [3 × RBW].</li> <li>c) Detector = peak.</li> <li>d) Trace mode = max hold.</li> <li>e) Sweep = auto couple.</li> <li>f) Allow the trace to stabilize.</li> <li>g) Measure the maximum width of the emission that is constrained by the frequencies associated with the two outermost amplitude points (upper and lower frequencies) that are attenuated by 6 dB relative to the maximum level measured in the fundamental emission.</li> </ul>

### 4.2.1. E.U.T. Operation:

Operating Environment:	
Temperature:	23.5 °C
Humidity:	51.7 %
Atmospheric Pressure:	101 kPa
Final test mode:	Test Mode1

### 4.2.2. Test Setup Diagram:

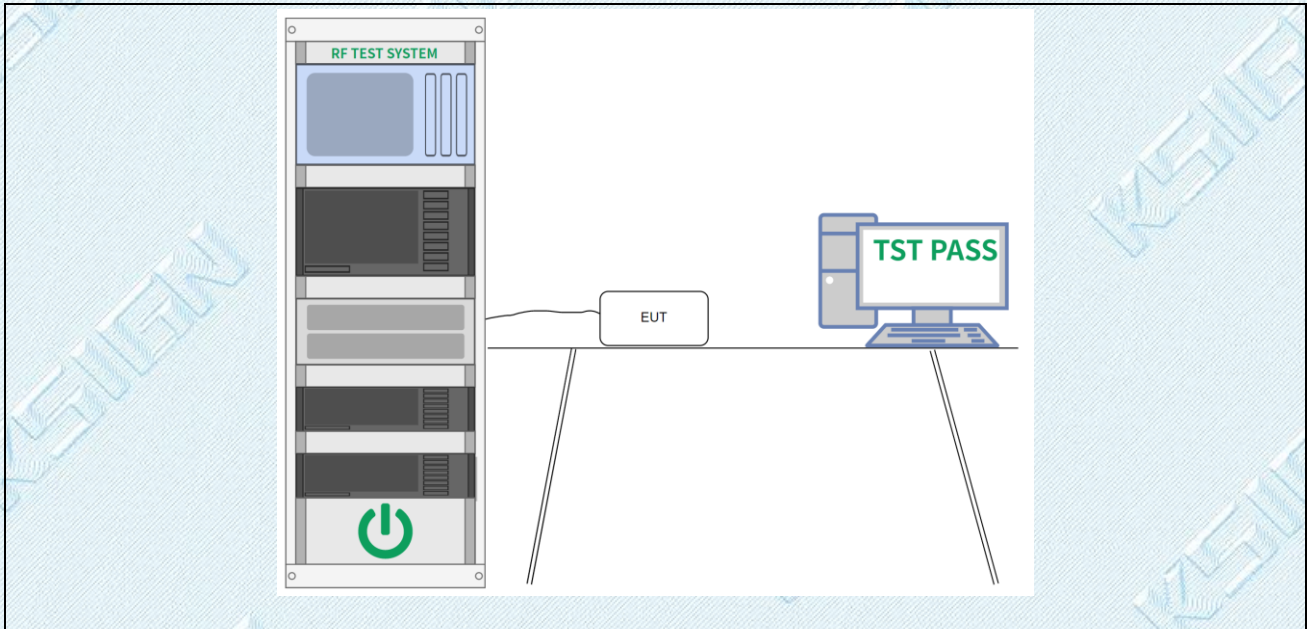

### 4.2.3. Test Data:

Please Refer to Appendix for Details.

### 4.3. Maximum Conducted Output Power

Test Requirement:	For systems using digital modulation in the 902-928 MHz, 2400-2483.5 MHz, and 5725-5850 MHz bands: 1 Watt. As an alternative to a peak power measurement, compliance with the one Watt limit can be based on a measurement of the maximum conducted output power. Maximum Conducted Output Power is defined as the total transmit power delivered to all antennas and antenna elements averaged across all symbols in the signaling alphabet when the transmitter is operating at its maximum power control level. Power must be summed across all antennas and antenna elements. The average must not include any time intervals during which the transmitter is off or is transmitting at a reduced power level. If multiple modes of operation are possible (e.g., alternative modulation methods), the maximum conducted output power is the highest total transmit power occurring in any mode.
Test Limit:	For systems using digital modulation in the 902-928 MHz, 2400-2483.5 MHz, and 5725-5850 MHz bands: 1 Watt. As an alternative to a peak power measurement, compliance with the one Watt limit can be based on a measurement of the maximum conducted output power. Maximum Conducted Output Power is defined as the total transmit power delivered to all antennas and antenna elements averaged across all symbols in the signaling alphabet when the transmitter is operating at its maximum power control level. Power must be summed across all antennas and antenna elements. The average must not include any time intervals during which the transmitter is off or is transmitting at a reduced power level. If multiple modes of operation are possible (e.g., alternative modulation methods), the maximum conducted output power is the highest total transmit power occurring in any mode.
Test Method:	Maximum peak conducted output power
Procedure:	ANSI C63.10-2013, section 11.9.1 Maximum peak conducted output power

#### 4.3.1. E.U.T. Operation:

Operating Environment:	
Temperature:	23.5 °C
Humidity:	51.7 %
Atmospheric Pressure:	101 kPa
Final test mode:	Test Mode 1

#### 4.3.2. Test Setup Diagram:

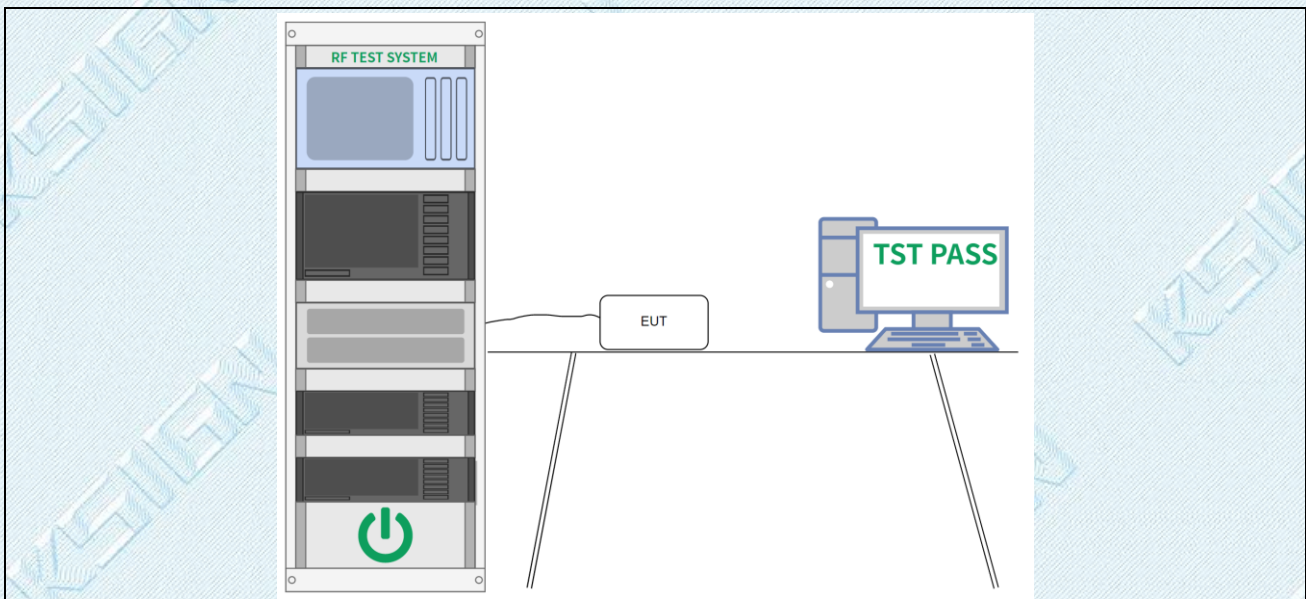

TRF RF\_R1

Add: West Side of 1/F., Building C, Zone A, Fuyuan New Factory, Jiujiu Industrial Park, Minzhu, Shatou, Shajing, Bao'an District, Shenzhen, Guangdong, China

Tel: +(86) 0755-2985 2678 Fax: +(86) 0755-2985 2397 E-mail: info@gdksign.cn Web: www.gdksign.com



---

#### 4.3.3. Test Data:

Please Refer to Appendix for Details.

### 4.4. Power Spectral Density

Test Requirement:	For digitally modulated systems, the power spectral density conducted from the intentional radiator to the antenna shall not be greater than 8 dBm in any 3 kHz band during any time interval of continuous transmission. This power spectral density shall be determined in accordance with the provisions of paragraph (b) of this section. The same method of determining the conducted output power shall be used to determine the power spectral density.
Test Limit:	For digitally modulated systems, the power spectral density conducted from the intentional radiator to the antenna shall not be greater than 8 dBm in any 3 kHz band during any time interval of continuous transmission. This power spectral density shall be determined in accordance with the provisions of paragraph (b) of this section. The same method of determining the conducted output power shall be used to determine the power spectral density.
Test Method:	Maximum power spectral density level in the fundamental emission

#### 4.4.1. E.U.T. Operation:

Operating Environment:	
Temperature:	23.5 °C
Humidity:	51.7 %
Atmospheric Pressure:	101 kPa
Final test mode:	Test Mode1

#### 4.4.2. Test Setup Diagram:

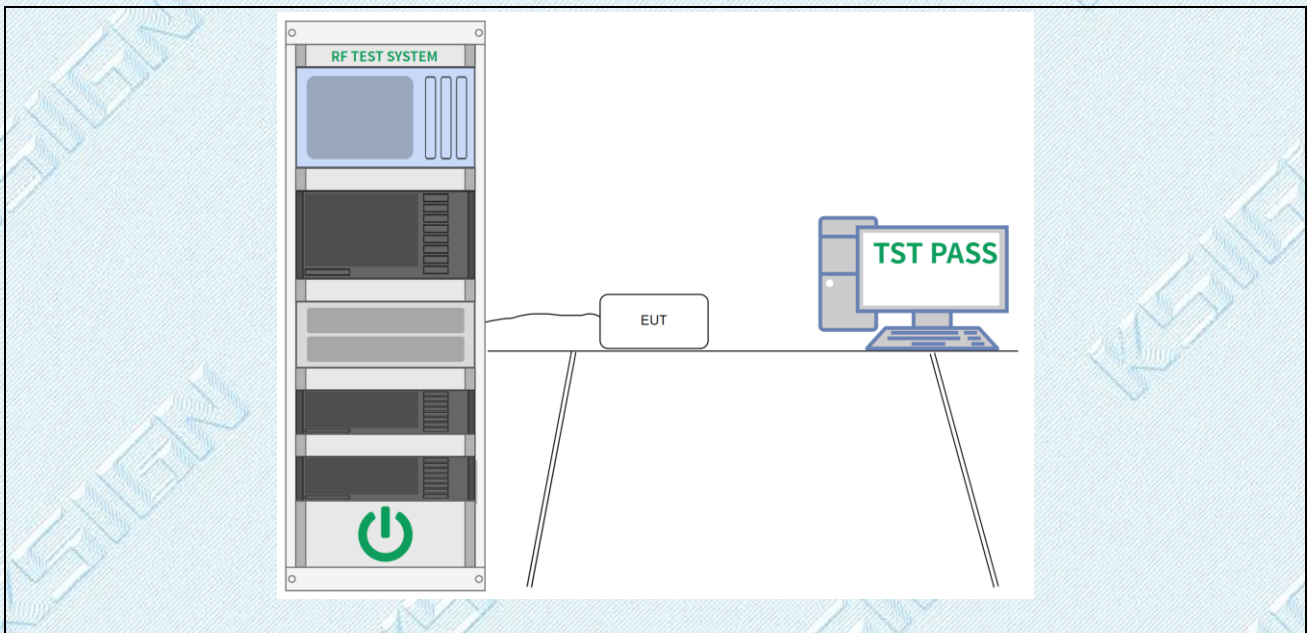

#### 4.4.3. Test Data:

Please Refer to Appendix for Details.

### 4.5. Emissions in non-restricted frequency bands

Test Requirement:	In any 100 kHz bandwidth outside the frequency band in which the spread spectrum or digitally modulated intentional radiator is operating, the radio frequency power that is produced by the intentional radiator shall be at least 20 dB below that in the 100 kHz bandwidth within the band that contains the highest level of the desired power, based on either an RF conducted or a radiated measurement, provided the transmitter demonstrates compliance with the peak conducted power limits. If the transmitter complies with the conducted power limits based on the use of RMS averaging over a time interval, as permitted under paragraph (b)(3) of this section, the attenuation required under this paragraph shall be 30 dB instead of 20 dB. Attenuation below the general limits specified in § 15.209(a) is not required.
Test Limit:	In any 100 kHz bandwidth outside the frequency band in which the spread spectrum or digitally modulated intentional radiator is operating, the radio frequency power that is produced by the intentional radiator shall be at least 20 dB below that in the 100 kHz bandwidth within the band that contains the highest level of the desired power, based on either an RF conducted or a radiated measurement, provided the transmitter demonstrates compliance with the peak conducted power limits. If the transmitter complies with the conducted power limits based on the use of RMS averaging over a time interval, as permitted under paragraph (b)(3) of this section, the attenuation required under this paragraph shall be 30 dB instead of 20 dB. Attenuation below the general limits specified in § 15.209(a) is not required.
Test Method:	Emissions in nonrestricted frequency bands
Procedure:	ANSI C63.10-2013 Section 11.11.1, Section 11.11.2, Section 11.11.3

#### 4.5.1. E.U.T. Operation:

Operating Environment:	
Temperature:	23.5 °C
Humidity:	51.7 %
Atmospheric Pressure:	101 kPa
Final test mode:	Test Mode1

#### 4.5.2. Test Setup Diagram:

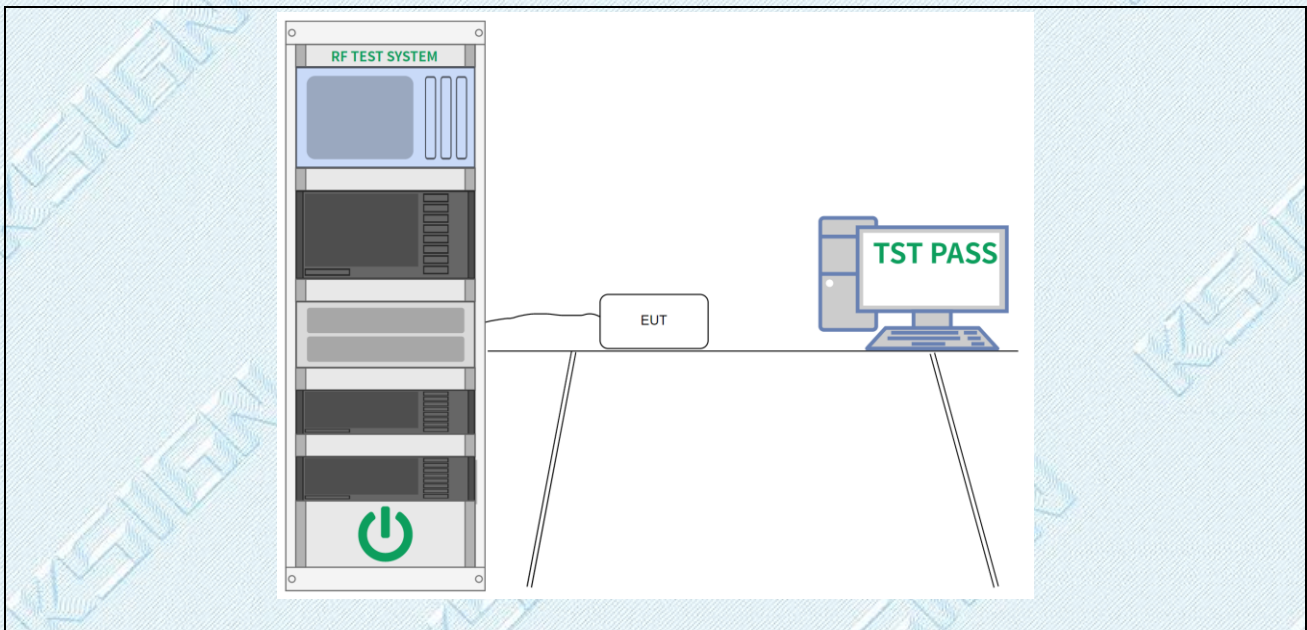

TRF RF\_R1

Add: West Side of 1/F., Building C, Zone A, Fuyuan New Factory, Jiujiu Industrial Park, Minzhu, Shatou, Shajing, Bao'an District, Shenzhen, Guangdong, China

Tel: +(86) 0755-2985 2678 Fax: +(86) 0755-2985 2397 E-mail: info@gdksign.cn Web: www.gdksign.com

#### 4.5.3. Test Data:

Please Refer to Appendix for Details.

#### 4.6. Band edge emissions (Radiated)

Test Requirement:	In addition, radiated emissions which fall in the restricted bands, as defined in § 15.205(a), must also comply with the radiated emission limits specified in § 15.209(a)(see § 15.205(c)).		
Test Limit:	Frequency (MHz)	Field strength (microvolts/meter)	Measurement distance (meters)
	0.009-0.490	2400/F(kHz)	300
	0.490-1.705	24000/F(kHz)	30
	1.705-30.0	30	30
	30-88	100 **	3
	88-216	150 **	3
	216-960	200 **	3
	Above 960	500	3
** Except as provided in paragraph (g), fundamental emissions from intentional radiators operating under this section shall not be located in the frequency bands 54-72 MHz, 76-88 MHz, 174-216 MHz or 470-806 MHz. However, operation within these frequency bands is permitted under other sections of this part, e.g., §§ 15.231 and 15.241.			
Test Method:	Radiated emissions tests		
Procedure:	ANSI C63.10-2013 section 6.6.4		

##### 4.6.1. E.U.T. Operation:

Operating Environment:	
Temperature:	23.5 °C
Humidity:	51.7 %
Atmospheric Pressure:	101 kPa
Final test mode:	Test Mode 1

Note:

- 1.Measurement = Reading level + Correct Factor
- 2.Correct Factor=Antenna Factor + Cable Loss -Preamplifier Factor

4.6.2. Test Data:

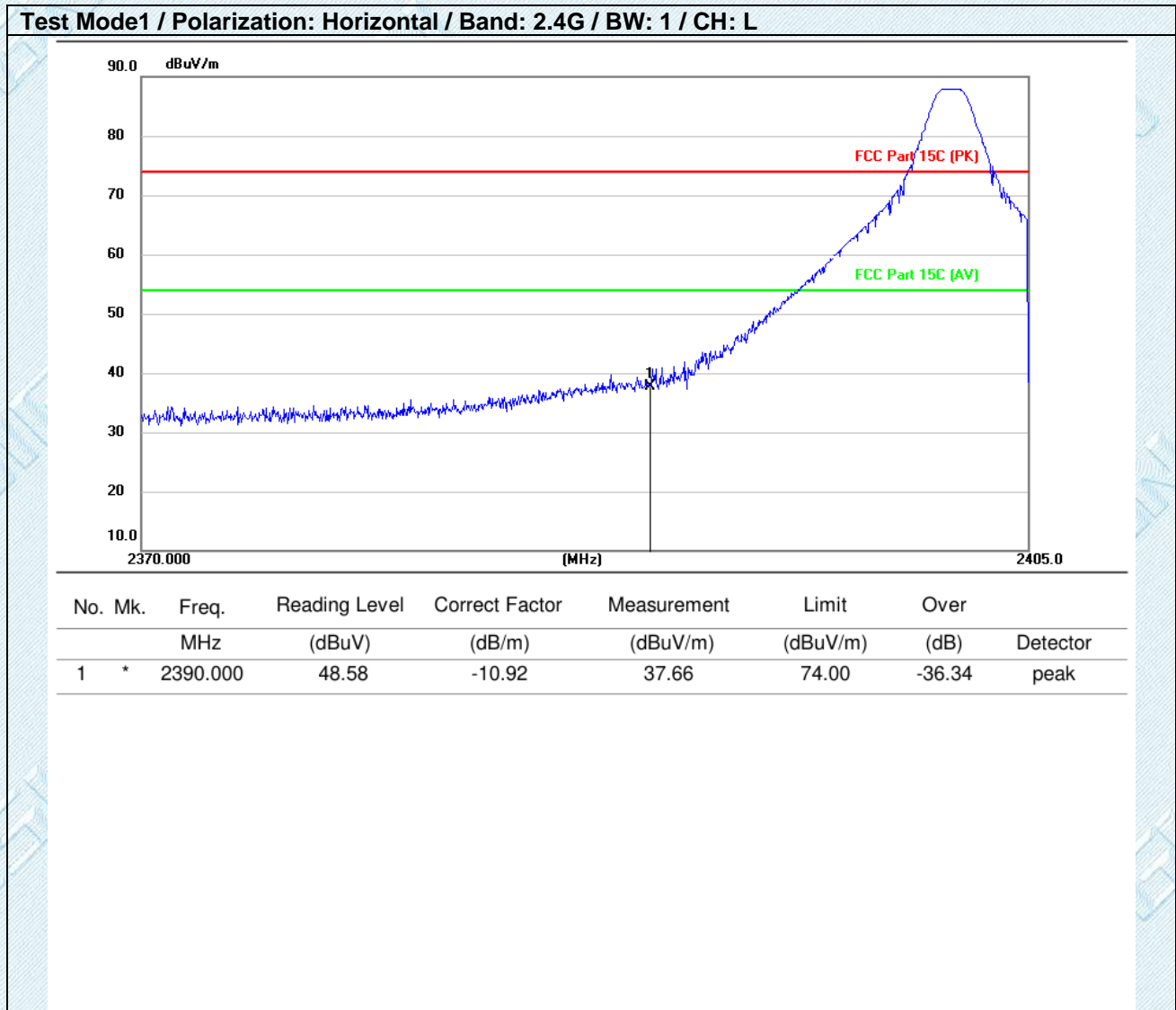

TRF RF\_R1

Add: West Side of 1/F., Building C, Zone A, Fuyuan New Factory, Jiujiu Industrial Park, Minzhu, Shatou, Shajing, Bao'an District, Shenzhen, Guangdong, China

Tel: +(86) 0755-2985 2678 Fax: +(86) 0755-2985 2397 E-mail: info@gdksign.cn Web: www.gdksign.com

**Test Mode1 / Polarization: Vertical / Band: 2.4G / BW: 1 / CH: L**

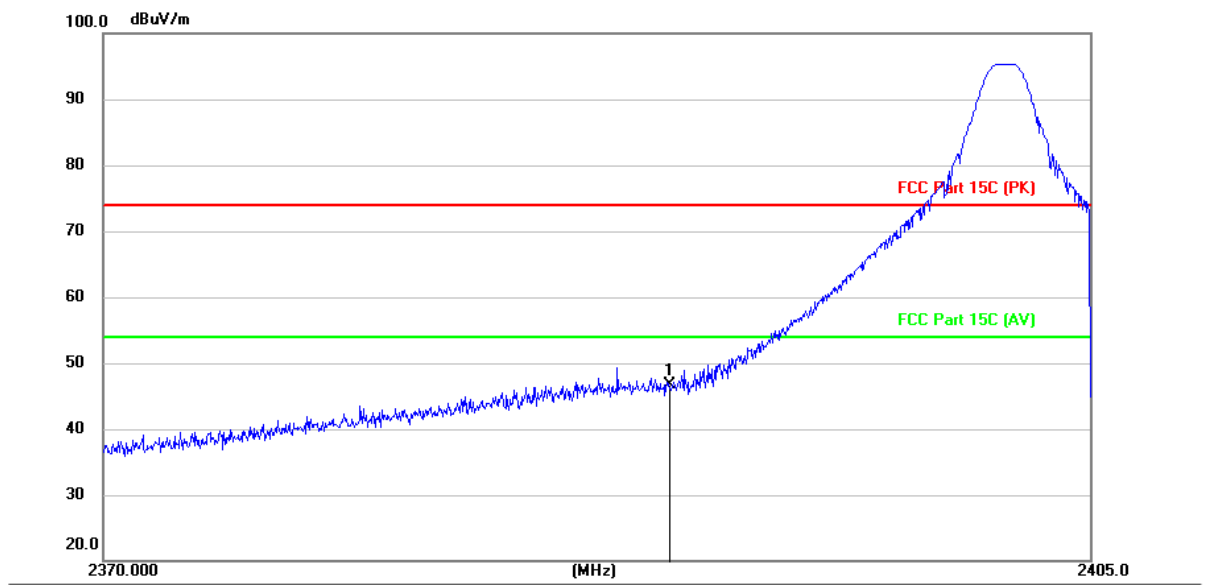

No.	Mk.	Freq. MHz	Reading Level (dBuV)	Correct Factor (dB/m)	Measurement (dBuV/m)	Limit (dBuV/m)	Over (dB)	Detector
1	*	2390.000	57.57	-10.92	46.65	74.00	-27.35	peak

TRF RF\_R1

Add: West Side of 1/F., Building C, Zone A, Fuyuan New Factory, Jiujiu Industrial Park, Minzhu, Shatou, Shajing, Bao'an District, Shenzhen, Guangdong, China

Tel: +(86) 0755-2985 2678 Fax: +(86) 0755-2985 2397 E-mail: info@gdksign.cn Web: www.gdksign.com

Test Mode1 / Polarization: Horizontal / Band: 2.4G / BW: 1 / CH: H

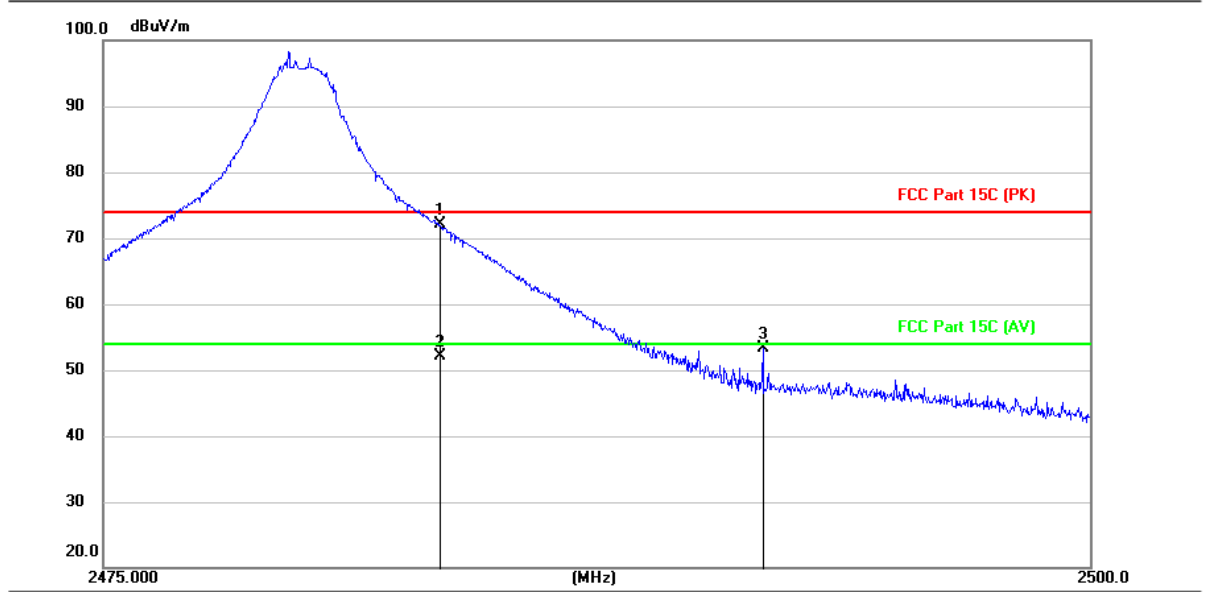

No.	Mk.	Freq. MHz	Reading Level (dBuV)	Correct Factor (dB/m)	Measurement (dBuV/m)	Limit (dBuV/m)	Over (dB)	Detector
1	*	2483.500	82.91	-10.88	72.03	74.00	-1.97	peak
2		2483.500	62.91	-10.88	52.03	54.00	-1.97	AVG
3		2491.677	64.16	-10.89	53.27	74.00	-20.73	peak

TRF RF\_R1

Add: West Side of 1/F., Building C, Zone A, Fuyuan New Factory, Jiujiu Industrial Park, Minzhu, Shatou, Shajing, Bao'an District, Shenzhen, Guangdong, China

Tel: +(86) 0755-2985 2678 Fax: +(86) 0755-2985 2397 E-mail: info@gdksign.cn Web: www.gdksign.com



**Test Mode1 / Polarization: Vertical / Band: 2.4G / BW: 1 / CH: H**

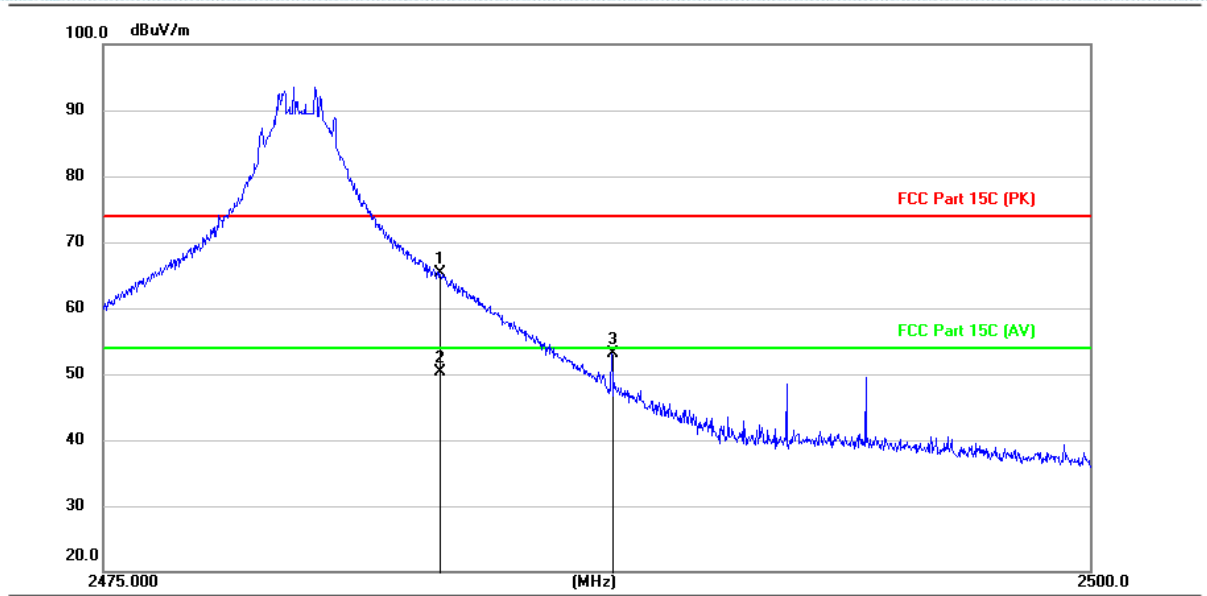

No.	Mk.	Freq. MHz	Reading Level (dBuV)	Correct Factor (dB/m)	Measurement (dBuV/m)	Limit (dBuV/m)	Over (dB)	Detector
1		2483.500	76.15	-10.88	65.27	74.00	-8.73	peak
2	*	2483.500	61.15	-10.88	50.27	54.00	-3.73	AVG
3		2487.867	64.08	-10.88	53.20	74.00	-20.80	peak

**Note:**

Since the peak value is less than the limit of the AVG value, there is no AVG data.

### 4.7. Emissions in restricted frequency bands (below 1GHz)

Test Requirement:	In addition, radiated emissions which fall in the restricted bands, as defined in § 15.205(a), must also comply with the radiated emission limits specified in § 15.209(a)(see § 15.205(c)).		
Test Limit:	Frequency (MHz)	Field strength (microvolts/meter)	Measurement distance (meters)
	0.009-0.490	2400/F(kHz)	300
	0.490-1.705	24000/F(kHz)	30
	1.705-30.0	30	30
	30-88	100 **	3
	88-216	150 **	3
	216-960	200 **	3
	Above 960	500	3
** Except as provided in paragraph (g), fundamental emissions from intentional radiators operating under this section shall not be located in the frequency bands 54-72 MHz, 76-88 MHz, 174-216 MHz or 470-806 MHz. However, operation within these frequency bands is permitted under other sections of this part, e.g., §§ 15.231 and 15.241.			
Test Method:	Radiated emissions tests		
Procedure:	ANSI C63.10-2013 section 6.6.4		

#### 4.7.1. E.U.T. Operation:

Operating Environment:	
Temperature:	23.5 °C
Humidity:	51.7 %
Atmospheric Pressure:	101 kPa
Final test mode:	Test Mode1

Note:

- Both modes of BLE 1Mbps were tested at Low, Middle, and High channel and recorded worst mode at Low channel.
- Measurement = Reading level + Correct Factor  
Correct Factor=Antenna Factor + Cable Loss - Pre-amplifier Factor

4.7.2. Test Data:

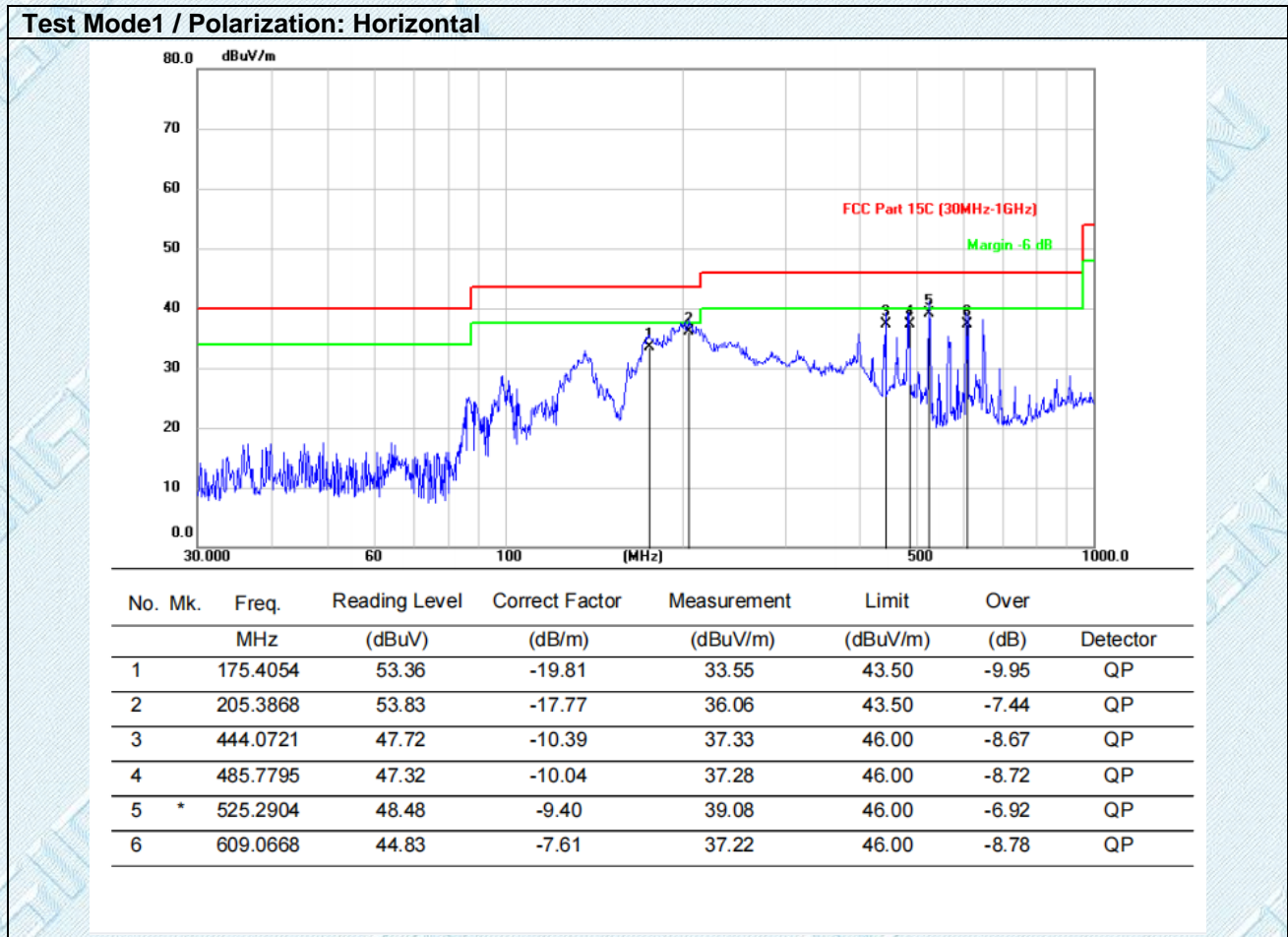

TRF RF\_R1

Add: West Side of 1/F., Building C, Zone A, Fuyuan New Factory, Jiujiu Industrial Park, Minzhu, Shatou, Shajing, Bao'an District, Shenzhen, Guangdong, China

Tel: +(86) 0755-2985 2678 Fax: +(86) 0755-2985 2397 E-mail: info@gdksign.cn Web: www.gdksign.com

**Test Mode1 / Polarization: Vertical**

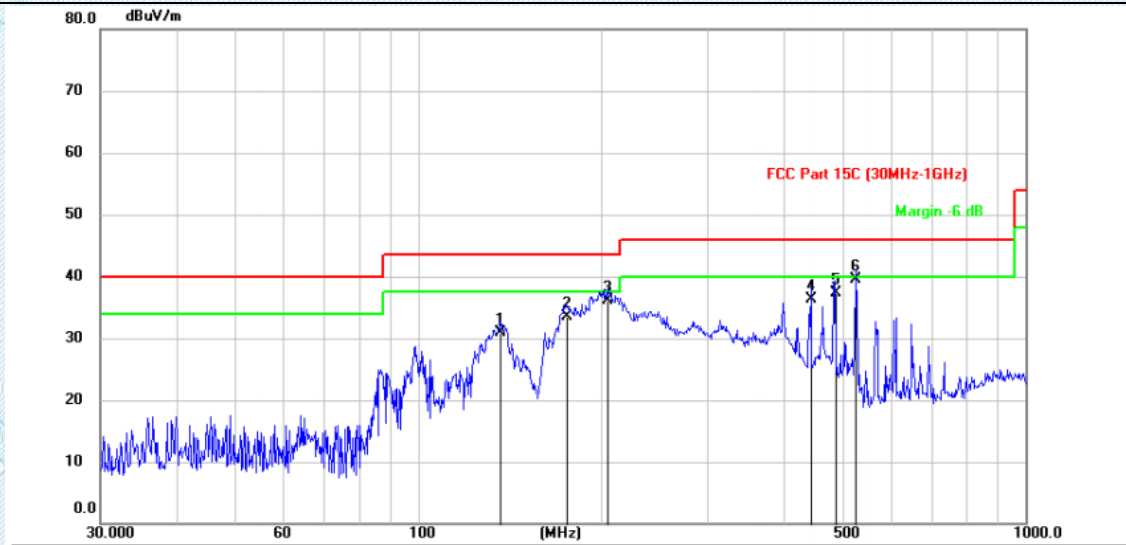

No.	Mk.	Freq. MHz	Reading Level (dBuV)	Correct Factor (dB/m)	Measurement (dBuV/m)	Limit (dBuV/m)	Over (dB)	Detector
1		136.7952	52.34	-21.34	31.00	43.50	-12.50	QP
2		175.4054	53.36	-19.81	33.55	43.50	-9.95	QP
3		205.3868	53.83	-17.77	36.06	43.50	-7.44	QP
4		443.9165	46.76	-10.40	36.36	46.00	-9.64	QP
5		485.7796	47.32	-10.04	37.28	46.00	-8.72	QP
6	*	525.2904	48.90	-9.40	39.50	46.00	-6.50	QP

TRF RF\_R1

Add: West Side of 1/F., Building C, Zone A, Fuyuan New Factory, Jiujiu Industrial Park, Minzhu, Shatou, Shajing, Bao'an District, Shenzhen, Guangdong, China

Tel: +(86) 0755-2985 2678 Fax: +(86) 0755-2985 2397 E-mail: info@gdksign.cn Web: www.gdksign.com

### 4.8. Emissions in restricted frequency bands (above 1GHz)

Test Requirement:	In addition, radiated emissions which fall in the restricted bands, as defined in § 15.205(a), must also comply with the radiated emission limits specified in § 15.209(a)(see § 15.205(c)).		
Test Limit:	Frequency (MHz)	Field strength (microvolts/meter)	Measurement distance (meters)
	0.009-0.490	2400/F(kHz)	300
	0.490-1.705	24000/F(kHz)	30
	1.705-30.0	30	30
	30-88	100 **	3
	88-216	150 **	3
	216-960	200 **	3
	Above 960	500	3
	** Except as provided in paragraph (g), fundamental emissions from intentional radiators operating under this section shall not be located in the frequency bands 54-72 MHz, 76-88 MHz, 174-216 MHz or 470-806 MHz. However, operation within these frequency bands is permitted under other sections of this part, e.g., §§ 15.231 and 15.241.		
Test Method:	Radiated emissions tests		
Procedure:	ANSI C63.10-2013 section 6.6.4		

#### 4.8.1. E.U.T. Operation:

Operating Environment:	
Temperature:	23.5 °C
Humidity:	51.7 %
Atmospheric Pressure:	101 kPa
Final test mode:	Test Mode 1

Note:

- 1.Measurement = Reading level + Correct Factor
- 2.Correct Factor=Antenna Factor + Cable Loss - Preamplifier Factor

4.8.2. Test Data:

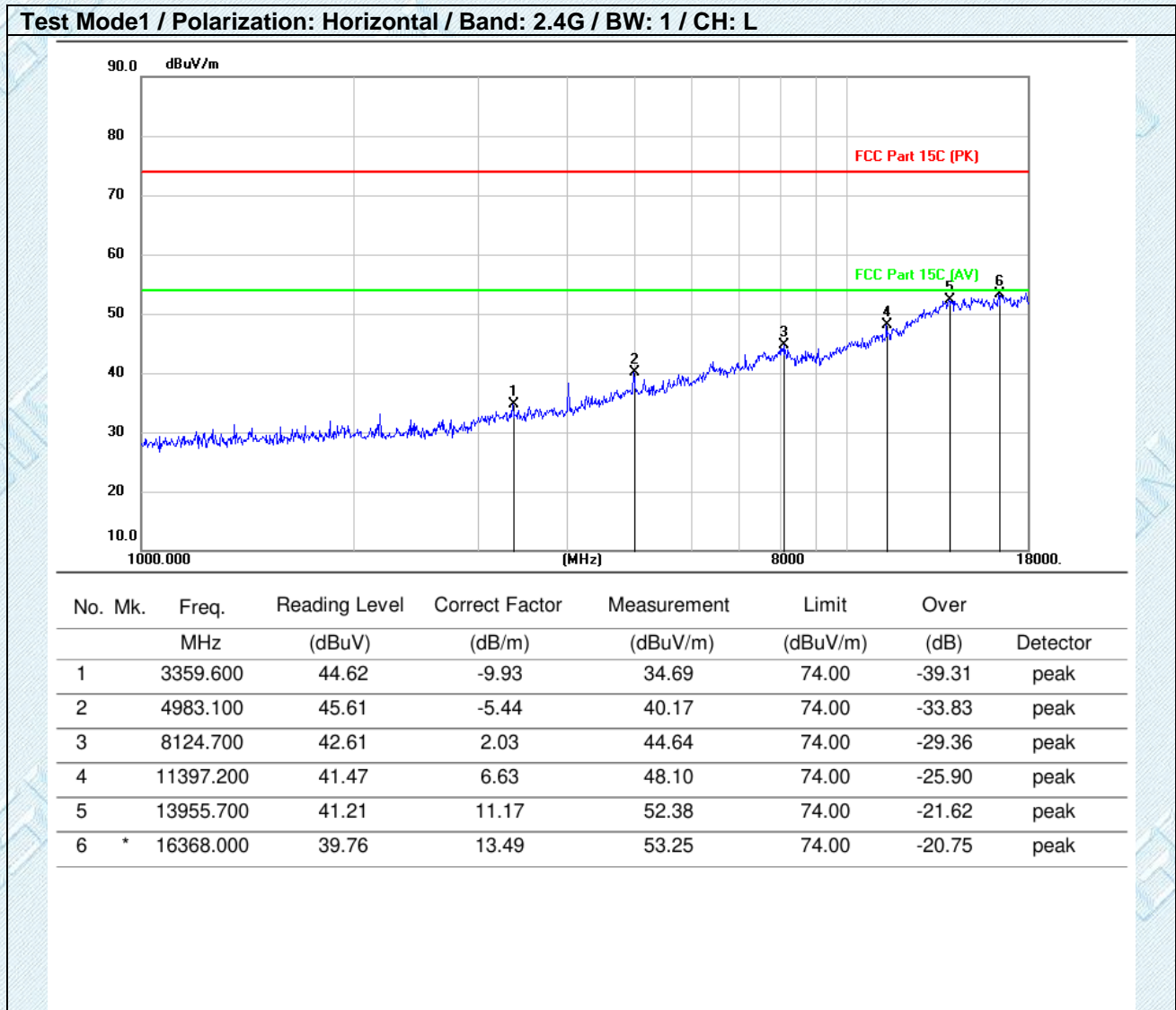

TRF RF\_R1

Add: West Side of 1/F., Building C, Zone A, Fuyuan New Factory, Jiujiu Industrial Park, Minzhu, Shatou, Shajing, Bao'an District, Shenzhen, Guangdong, China

Tel: +(86) 0755-2985 2678 Fax: +(86) 0755-2985 2397 E-mail: info@gdksign.cn Web: www.gdksign.com

**Test Mode1 / Polarization: Vertical / Band: 2.4G / BW: 1 / CH: L**

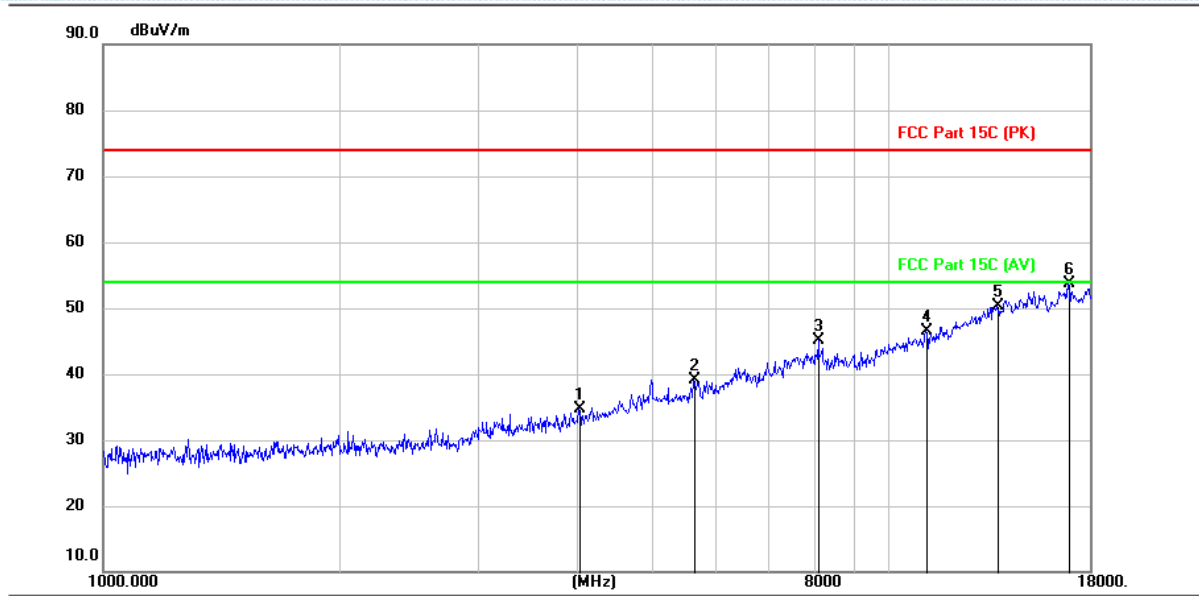

No. Mk.	Freq. MHz	Reading Level (dBuV)	Correct Factor (dB/m)	Measurement (dBuV/m)	Limit (dBuV/m)	Over (dB)	Detector
1	4032.800	43.12	-8.32	34.80	74.00	-39.20	peak
2	5639.300	43.69	-4.62	39.07	74.00	-34.93	peak
3	8116.200	43.00	2.04	45.04	74.00	-28.96	peak
4	11140.500	40.56	6.03	46.59	74.00	-27.41	peak
5	13748.300	39.46	10.92	50.38	74.00	-23.62	peak
6 *	16893.300	40.42	13.20	53.62	74.00	-20.38	peak

TRF RF\_R1

Add: West Side of 1/F., Building C, Zone A, Fuyuan New Factory, Jiujiu Industrial Park, Minzhu, Shatou, Shajing, Bao'an District, Shenzhen, Guangdong, China

Tel: +(86) 0755-2985 2678 Fax: +(86) 0755-2985 2397 E-mail: info@gdksign.cn Web: www.gdksign.com

**Test Mode1 / Polarization: Horizontal / Band: 2.4G / BW: 1 / CH: M**

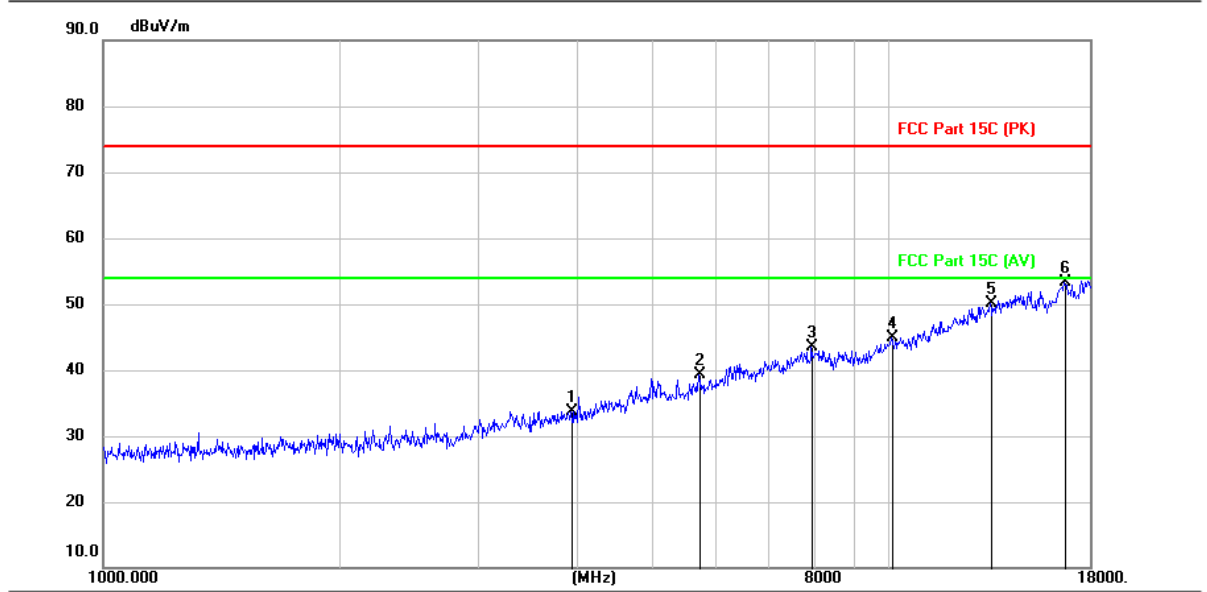

No. Mk.	Freq. MHz	Reading Level (dBuV)	Correct Factor (dB/m)	Measurement (dBuV/m)	Limit (dBuV/m)	Over (dB)	Detector
1	3939.300	42.32	-8.58	33.74	74.00	-40.26	peak
2	5717.500	43.80	-4.43	39.37	74.00	-34.63	peak
3	7944.500	41.53	1.93	43.46	74.00	-30.54	peak
4	10071.200	40.76	4.19	44.95	74.00	-29.05	peak
5	13461.000	39.45	10.56	50.01	74.00	-23.99	peak
6 *	16713.100	39.88	13.48	53.36	74.00	-20.64	peak

TRF RF\_R1

Add: West Side of 1/F., Building C, Zone A, Fuyuan New Factory, Jiujiu Industrial Park, Minzhu, Shatou, Shajing, Bao'an District, Shenzhen, Guangdong, China

Tel: +(86) 0755-2985 2678 Fax: +(86) 0755-2985 2397 E-mail: info@gdksign.cn Web: www.gdksign.com



**Test Mode1 / Polarization: Vertical / Band: 2.4G / BW: 1 / CH: M**

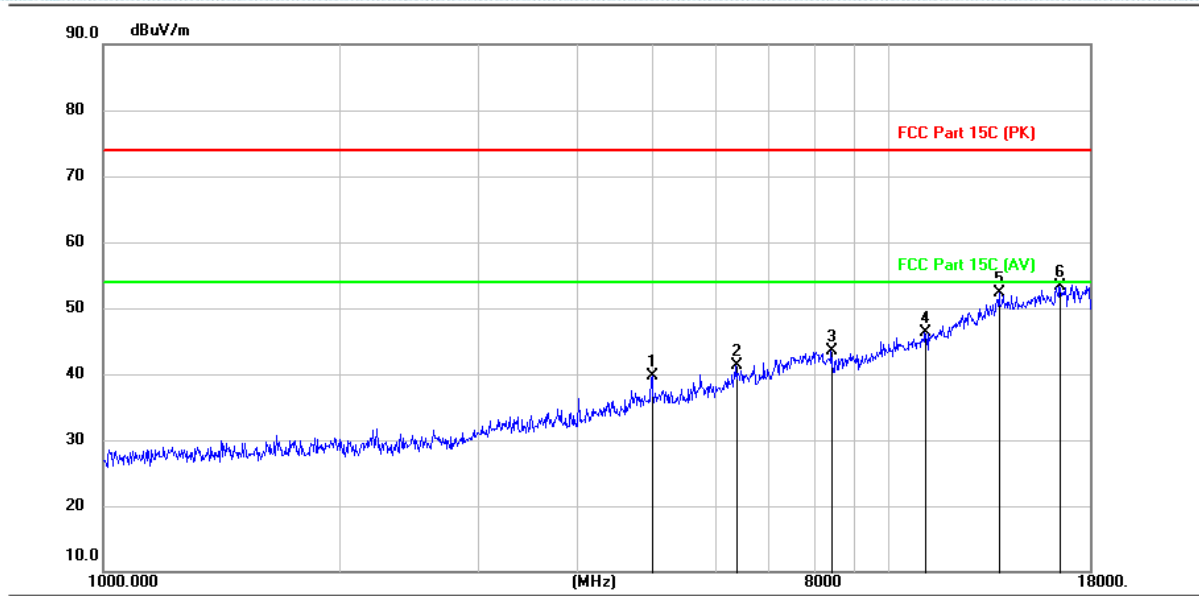

No. Mk.	Freq. MHz	Reading Level (dBuV)	Correct Factor (dB/m)	Measurement (dBuV/m)	Limit (dBuV/m)	Over (dB)	Detector
1	4988.200	45.22	-5.43	39.79	74.00	-34.21	peak
2	6385.600	43.79	-2.49	41.30	74.00	-32.70	peak
3	8429.000	41.46	1.96	43.42	74.00	-30.58	peak
4	11109.900	40.42	5.96	46.38	74.00	-27.62	peak
5	13836.700	41.36	11.03	52.39	74.00	-21.61	peak
6 *	16478.500	39.52	13.76	53.28	74.00	-20.72	peak

TRF RF\_R1

Add: West Side of 1/F., Building C, Zone A, Fuyuan New Factory, Jiujiu Industrial Park, Minzhu, Shatou, Shajing, Bao'an District, Shenzhen, Guangdong, China

Tel: +(86) 0755-2985 2678 Fax: +(86) 0755-2985 2397 E-mail: info@gdksign.cn Web: www.gdksign.com

**Test Mode1 / Polarization: Horizontal / Band: 2.4G / BW: 1 / CH: H**

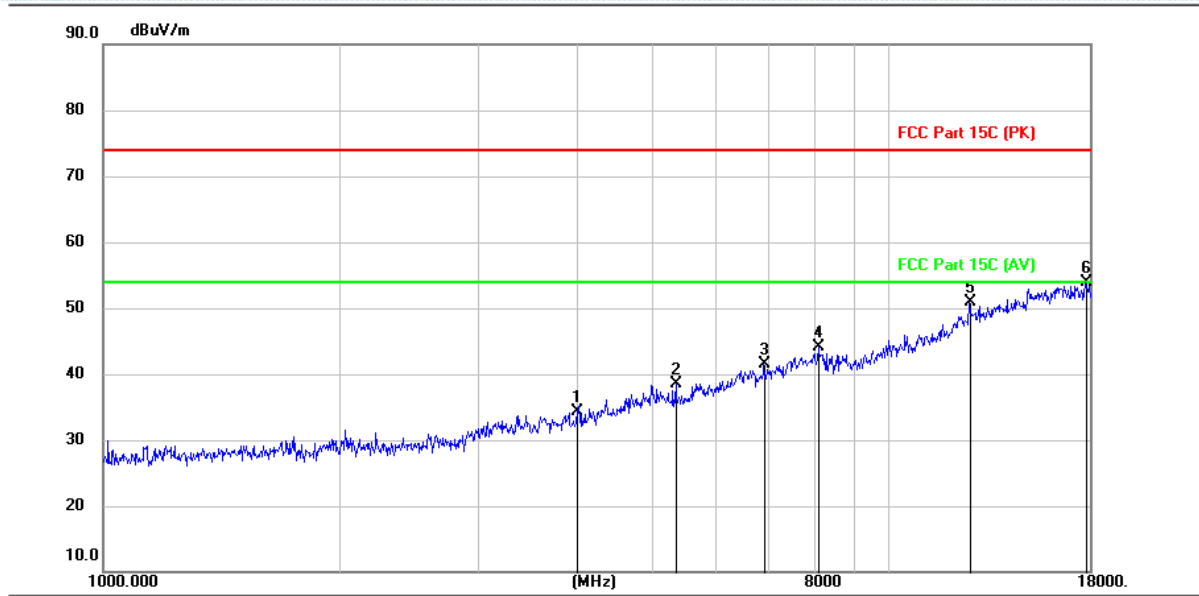

No. Mk.	Freq. MHz	Reading Level (dBuV)	Correct Factor (dB/m)	Measurement (dBuV/m)	Limit (dBuV/m)	Over (dB)	Detector
1	4009.000	42.59	-8.39	34.20	74.00	-39.80	peak
2	5352.000	43.51	-5.07	38.44	74.00	-35.56	peak
3	6916.000	42.39	-0.94	41.45	74.00	-32.55	peak
4	8114.500	42.14	2.04	44.18	74.00	-29.82	peak
5	12677.300	41.66	9.30	50.96	74.00	-23.04	peak
6 *	17792.600	40.33	13.53	53.86	74.00	-20.14	peak

TRF RF\_R1

Add: West Side of 1/F., Building C, Zone A, Fuyuan New Factory, Jiujiu Industrial Park, Minzhu, Shatou, Shajing, Bao'an District, Shenzhen, Guangdong, China

Tel: +(86) 0755-2985 2678 Fax: +(86) 0755-2985 2397 E-mail: info@gdksign.cn Web: www.gdksign.com

**Test Mode1 / Polarization: Vertical / Band: 2.4G / BW: 1 / CH: H**

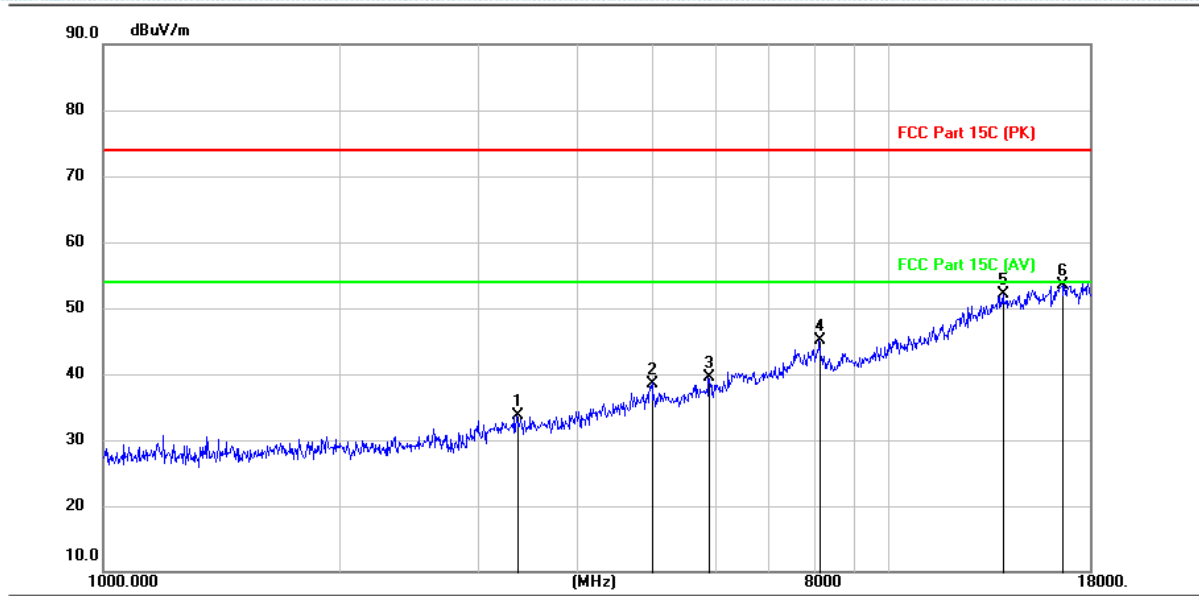

No. Mk.	Freq. MHz	Reading Level (dBuV)	Correct Factor (dB/m)	Measurement (dBuV/m)	Limit (dBuV/m)	Over (dB)	Detector
1	3359.600	43.69	-9.93	33.76	74.00	-40.24	peak
2	4988.200	44.03	-5.43	38.60	74.00	-35.40	peak
3	5890.900	43.53	-4.04	39.49	74.00	-34.51	peak
4	8151.900	43.14	2.03	45.17	74.00	-28.83	peak
5	13974.400	40.85	11.19	52.04	74.00	-21.96	peak
6 *	16616.200	39.84	13.63	53.47	74.00	-20.53	peak

**Note:**

1. From 18GHz to 26.5GHz, the amplitude of spurious emissions which are attenuated by more than 20dB below the permissible value has no need to be reported.
2. Since the peak value is less than the limit of the AVG value, there is no AVG data.

TRF RF\_R1

Add: West Side of 1/F., Building C, Zone A, Fuyuan New Factory, Jiujiu Industrial Park, Minzhu, Shatou, Shajing, Bao'an District, Shenzhen, Guangdong, China

Tel: +(86) 0755-2985 2678 Fax: +(86) 0755-2985 2397 E-mail: info@gdksign.cn Web: www.gdksign.com



**Emissions in restricted frequency bands (above 1GHz)**

TRF RF\_R1

Add: West Side of 1/F., Building C, Zone A, Fuyuan New Factory, Jiujiu Industrial Park, Minzhu, Shatou, Shajing, Bao'an District, Shenzhen, Guangdong, China

Tel: +(86) 0755-2985 2678 Fax: +(86) 0755-2985 2397 E-mail: info@gdksign.cn Web: www.gdksign.com

## 6. PHOTOGRAPHS OF EUT CONSTRUCTIONAL

Refer to Appendix - Photographs of EUT Constructional Details for KD2303S1274E.

# Appendix

TRF RF\_R1

Add: West Side of 1/F., Building C, Zone A, Fuyuan New Factory, Jiujiu Industrial Park, Minzhu, Shatou, Shajing, Bao'an District, Shenzhen, Guangdong, China

Tel: +(86) 0755-2985 2678 Fax: +(86) 0755-2985 2397 E-mail: info@gdkesign.cn Web: www.gdkesign.com

## 6.1. Appendix A: DTS Bandwidth

### 6.1.1. Test Result

TestMode	Antenna	Freq[MHz]	DTS BW [MHz]	FL[MHz]	FH[MHz]	Limit[MHz]	Verdict
BLE_1M	Ant1	2402	0.68	2401.65	2402.34	0.5	PASS
		2440	0.71	2439.64	2440.35	0.5	PASS
		2480	0.73	2479.63	2480.36	0.5	PASS



### 6.1.2. Test Graphs



TRF RF\_R1

Add: West Side of 1/F., Building C, Zone A, Fuyuan New Factory, Jiujiu Industrial Park, Minzhu, Shatou, Shajing, Bao'an District, Shenzhen, Guangdong, China

Tel: +(86) 0755-2985 2678 Fax: +(86) 0755-2985 2397 E-mail: info@gdksign.cn Web: www.gdksign.com

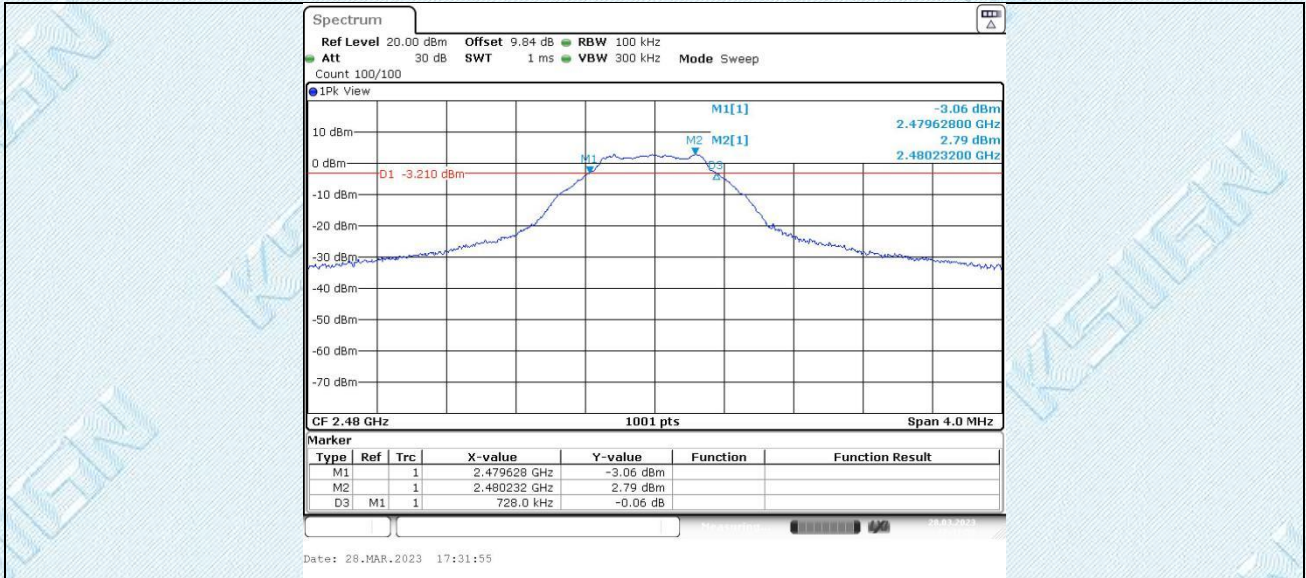

TRF RF\_R1

Add: West Side of 1/F., Building C, Zone A, Fuyuan New Factory, Jiujiu Industrial Park, Minzhu, Shatou, Shajing, Bao'an District, Shenzhen, Guangdong, China

Tel: +(86) 0755-2985 2678 Fax: +(86) 0755-2985 2397 E-mail: info@gdksign.cn Web: www.gdksign.com

## 6.2. Appendix B: Occupied Channel Bandwidth

### 6.2.1. Test Result

TestMode	Antenna	Freq[MHz]	OCB [MHz]	FL[MHz]	FH[MHz]	Limit[MHz]	Verdict
BLE_1M	Ant1	2402	1.063	2401.465	2402.527	---	PASS
		2440	1.063	2439.461	2440.523	---	PASS
		2480	1.067	2479.461	2480.527	---	PASS

TRF RF\_R1

Add: West Side of 1/F., Building C, Zone A, Fuyuan New Factory, Jiujiu Industrial Park, Minzhu, Shatou, Shajing, Bao'an District, Shenzhen, Guangdong, China

Tel: +(86) 0755-2985 2678 Fax: +(86) 0755-2985 2397 E-mail: info@gdksign.cn Web: www.gdksign.com

### 6.2.2. Test Graphs



TRF\_RF\_R1

Add: West Side of 1/F., Building C, Zone A, Fuyuan New Factory, Jiujiu Industrial Park, Minzhu, Shatou, Shajing, Bao'an District, Shenzhen, Guangdong, China

Tel: +(86) 0755-2985 2678 Fax: +(86) 0755-2985 2397 E-mail: info@gdksign.cn Web: www.gdksign.com

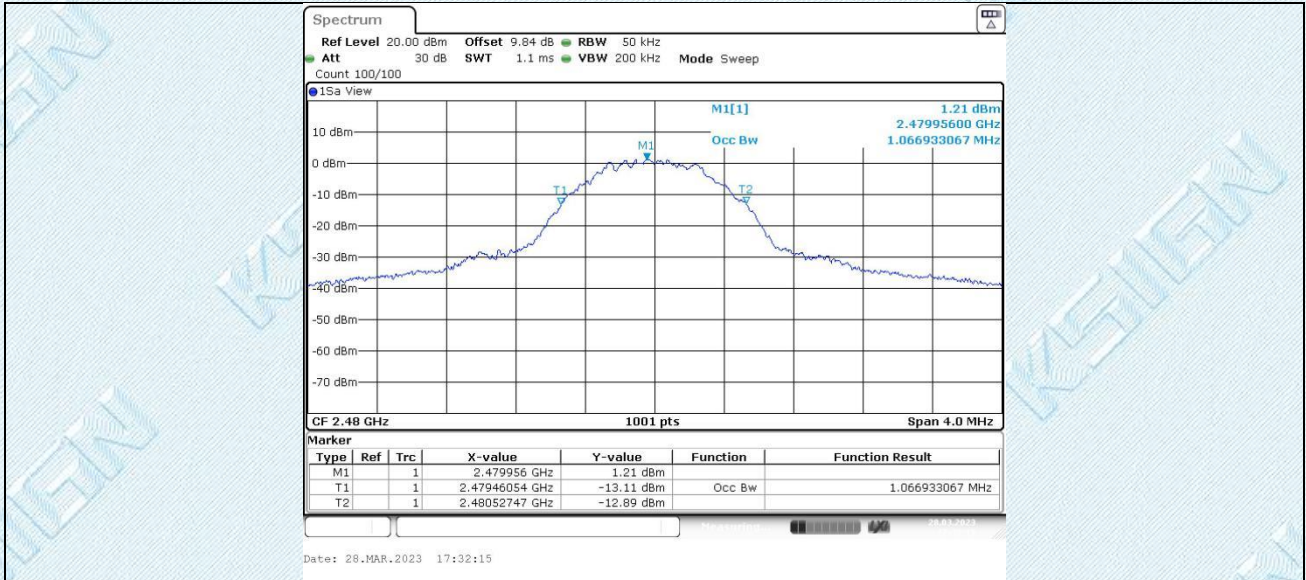

TRF RF\_R1

Add: West Side of 1/F., Building C, Zone A, Fuyuan New Factory, Jiujiu Industrial Park, Minzhu, Shatou, Shajing, Bao'an District, Shenzhen, Guangdong, China

Tel: +(86) 0755-2985 2678 Fax: +(86) 0755-2985 2397 E-mail: info@gdksign.cn Web: www.gdksign.com

### 6.3. Appendix C: Maximum conducted output power

#### 6.3.1. Test Result Peak

TestMode	Antenna	Freq[MHz]	Conducted Peak Power [dBm]	Conducted Limit[dBm]	Verdict
BLE_1M	Ant1	2402	4.91	≤30	PASS
		2440	4.53	≤30	PASS
		2480	3.83	≤30	PASS

### 6.3.2. Test Graphs Peak

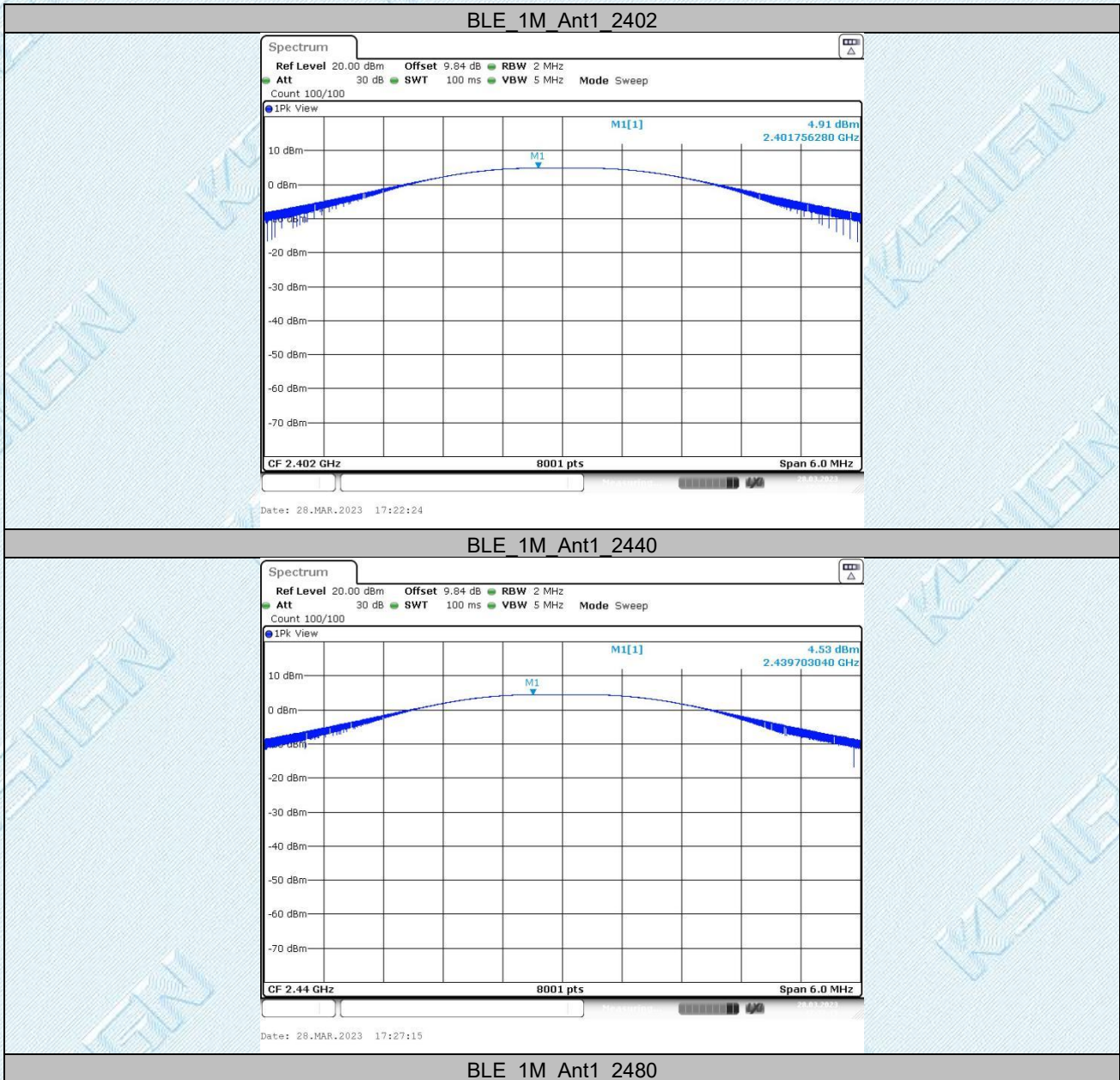

TRF\_RF\_R1

Add: West Side of 1/F., Building C, Zone A, Fuyuan New Factory, Jiujiu Industrial Park, Minzhu, Shatou, Shajing, Bao'an District, Shenzhen, Guangdong, China

Tel: +(86) 0755-2985 2678 Fax: +(86) 0755-2985 2397 E-mail: info@gdksign.cn Web: www.gdksign.com

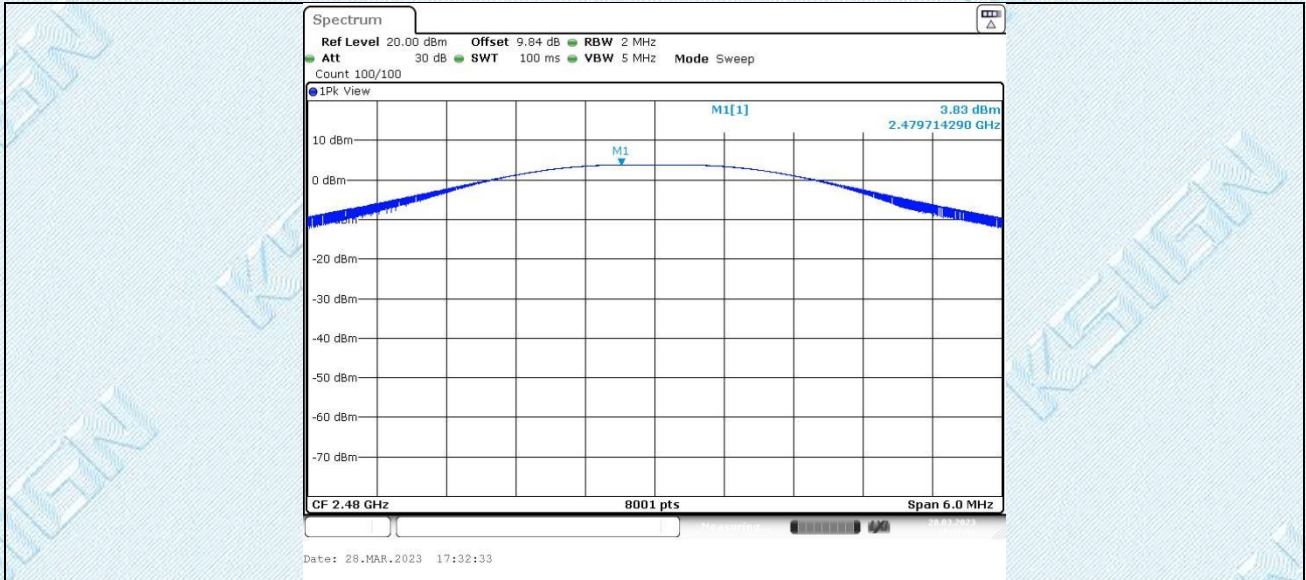

TRF RF\_R1

Add: West Side of 1/F., Building C, Zone A, Fuyuan New Factory, Jiujiu Industrial Park, Minzhu, Shatou, Shajing, Bao'an District, Shenzhen, Guangdong, China

Tel: +(86) 0755-2985 2678 Fax: +(86) 0755-2985 2397 E-mail: info@gdksign.cn Web: www.gdksign.com



## 6.4. Appendix D: Maximum power spectral density

### 6.4.1. Test Result

TestMode	Antenna	Freq[MHz]	Result[dBm/3kHz]	Limit[dBm/3kHz]	Verdict
BLE_1M	Ant1	2402	-9.33	≤8.00	PASS
		2440	-9.99	≤8.00	PASS
		2480	-10.67	≤8.00	PASS

TRF RF\_R1

Add: West Side of 1/F., Building C, Zone A, Fuyuan New Factory, Jiujiu Industrial Park, Minzhu, Shatou, Shajing, Bao'an District, Shenzhen, Guangdong, China

Tel: +(86) 0755-2985 2678 Fax: +(86) 0755-2985 2397 E-mail: info@gdksign.cn Web: www.gdksign.com

### 6.4.2. Test Graphs



TRF\_RF\_R1

Add: West Side of 1/F., Building C, Zone A, Fuyuan New Factory, Jiujiu Industrial Park, Minzhu, Shatou, Shajing, Bao'an District, Shenzhen, Guangdong, China

Tel: +(86) 0755-2985 2678 Fax: +(86) 0755-2985 2397 E-mail: info@gdkesign.cn Web: www.gdkesign.com

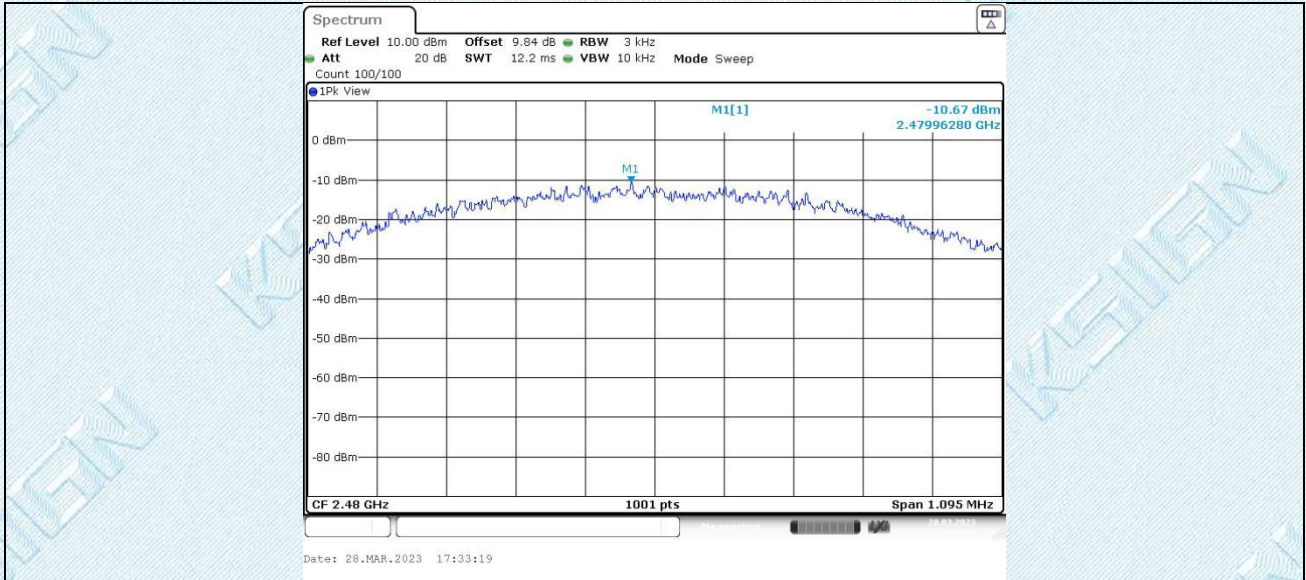

TRF RF\_R1

Add: West Side of 1/F., Building C, Zone A, Fuyuan New Factory, Jiujiu Industrial Park, Minzhu, Shatou, Shajing, Bao'an District, Shenzhen, Guangdong, China

Tel: +(86) 0755-2985 2678 Fax: +(86) 0755-2985 2397 E-mail: info@gdksign.cn Web: www.gdksign.com

## 6.5. Appendix E: Reference level measurement

### 6.5.1. Test Result

TestMode	Antenna	Freq[MHz]	Max.Point[MHz]	Result[dBm]
BLE_1M	Ant1	2402	2402.26	3.92
		2440	2440.25	4.10
		2480	2479.74	2.83

### 6.5.2. Test Graphs



TRF\_RF\_R1

Add: West Side of 1/F., Building C, Zone A, Fuyuan New Factory, Jiujiu Industrial Park, Minzhu, Shatou, Shajing, Bao'an District, Shenzhen, Guangdong, China

Tel: +(86) 0755-2985 2678 Fax: +(86) 0755-2985 2397 E-mail: info@gdksign.cn Web: www.gdksign.com

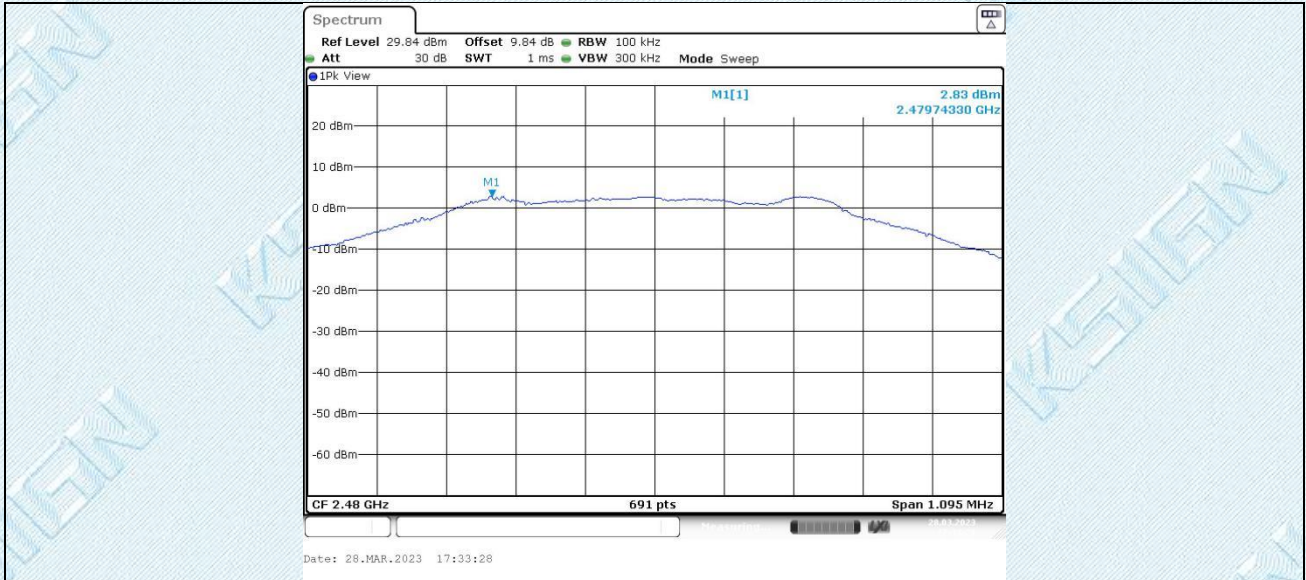

TRF RF\_R1

Add: West Side of 1/F., Building C, Zone A, Fuyuan New Factory, Jiujiu Industrial Park, Minzhu, Shatou, Shajing, Bao'an District, Shenzhen, Guangdong, China

Tel: +(86) 0755-2985 2678 Fax: +(86) 0755-2985 2397 E-mail: info@gdksign.cn Web: www.gdksign.com

## 6.6. Appendix F: Band edge measurements

### 6.6.1. Test Result

TestMode	Antenna	ChName	Freq[MHz]	RefLevel[dBm]	Result[dBm]	Limit[dBm]	Verdict
BLE_1M	Ant1	Low	2402	3.92	-31.39	≤-16.08	PASS
		High	2480	2.83	-36.46	≤-17.17	PASS

### 6.6.2. Test Graphs



TRF\_RF\_R1

Add: West Side of 1/F., Building C, Zone A, Fuyuan New Factory, Jiujiu Industrial Park, Minzhu, Shatou, Shajing, Bao'an District, Shenzhen, Guangdong, China

Tel: +(86) 0755-2985 2678 Fax: +(86) 0755-2985 2397 E-mail: info@gdksign.cn Web: www.gdksign.com



## 6.7. Appendix G: Conducted Spurious Emission

### 6.7.1. Test Result

TestMode	Antenna	Freq[MHz]	FreqRange [MHz]	RefLevel [dBm]	Result [dBm]	Limit [dBm]	Verdict
BLE_1M	Ant1	2402	30~1000	3.92	-51.91	≤-16.08	PASS
			1000~26500	3.92	-46.12	≤-16.08	PASS
		2440	30~1000	4.10	-52.13	≤-15.9	PASS
			1000~26500	4.10	-46.76	≤-15.9	PASS
		2480	30~1000	2.83	-51.72	≤-17.17	PASS
			1000~26500	2.83	-46.67	≤-17.17	PASS

TRF RF\_R1

Add: West Side of 1/F., Building C, Zone A, Fuyuan New Factory, Jiujiu Industrial Park, Minzhu, Shatou, Shajing, Bao'an District, Shenzhen, Guangdong, China

Tel: +(86) 0755-2985 2678 Fax: +(86) 0755-2985 2397 E-mail: info@gdksign.cn Web: www.gdksign.com

### 6.7.2. Test Graphs

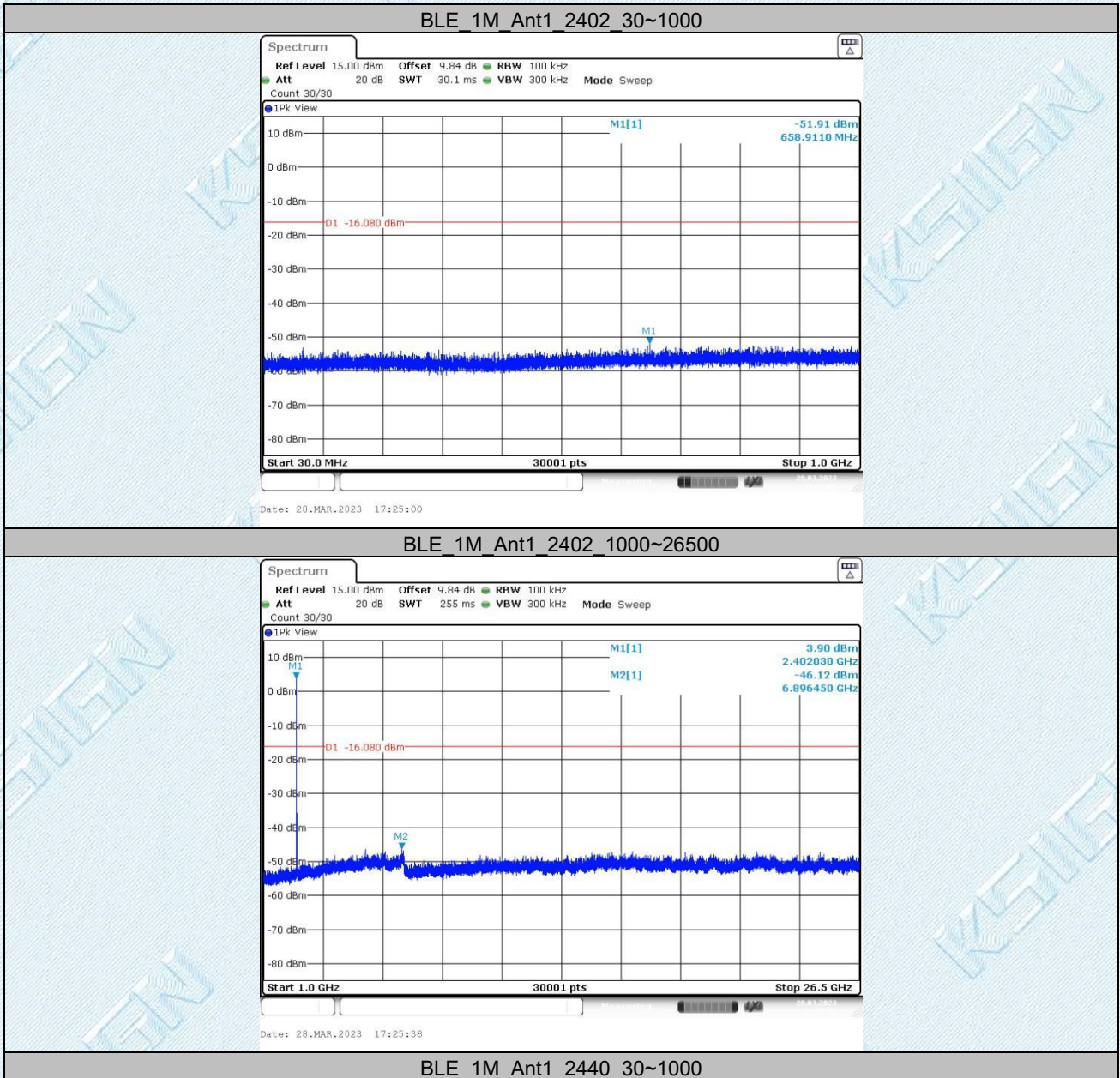

TRF\_RF\_R1

Add: West Side of 1/F., Building C, Zone A, Fuyuan New Factory, Jiujiu Industrial Park, Minzhu, Shatou, Shajing, Bao'an District, Shenzhen, Guangdong, China

Tel: +(86) 0755-2985 2678 Fax: +(86) 0755-2985 2397 E-mail: info@gdksign.cn Web: www.gdksign.com

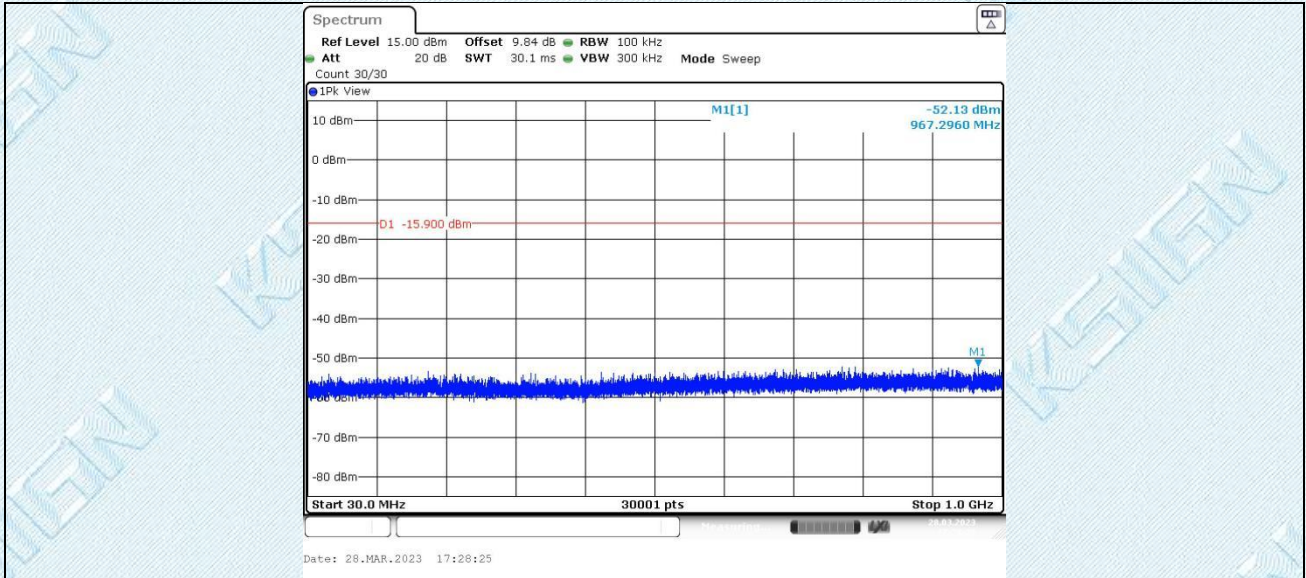

BLE 1M Ant1 2440 1000~26500

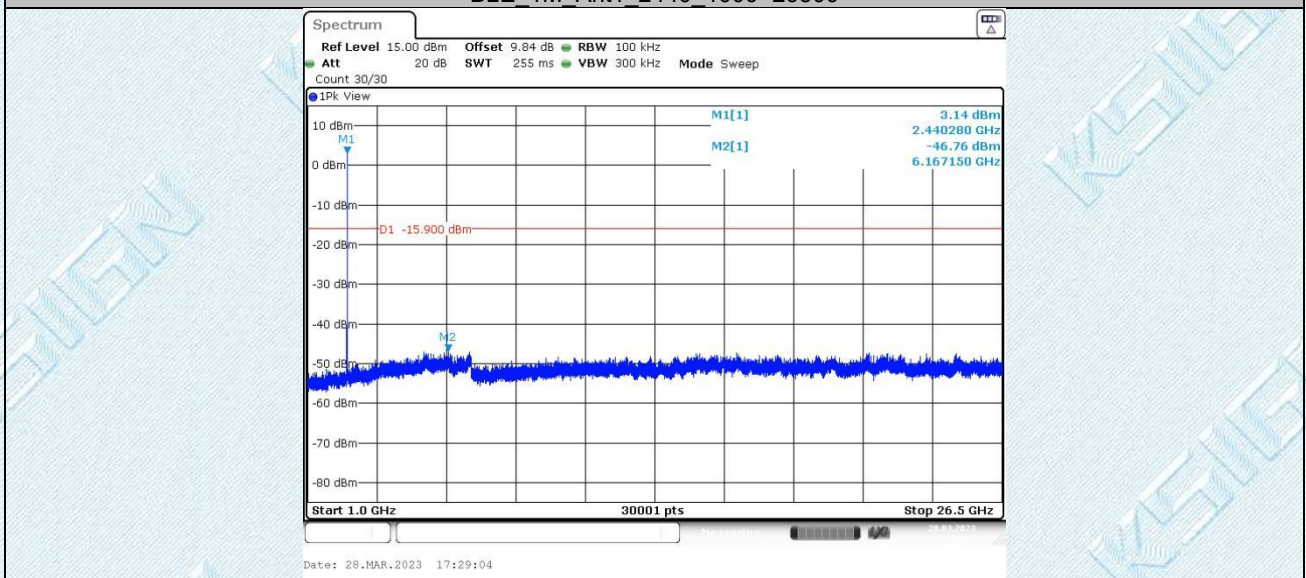

BLE 1M Ant1 2480 30~1000

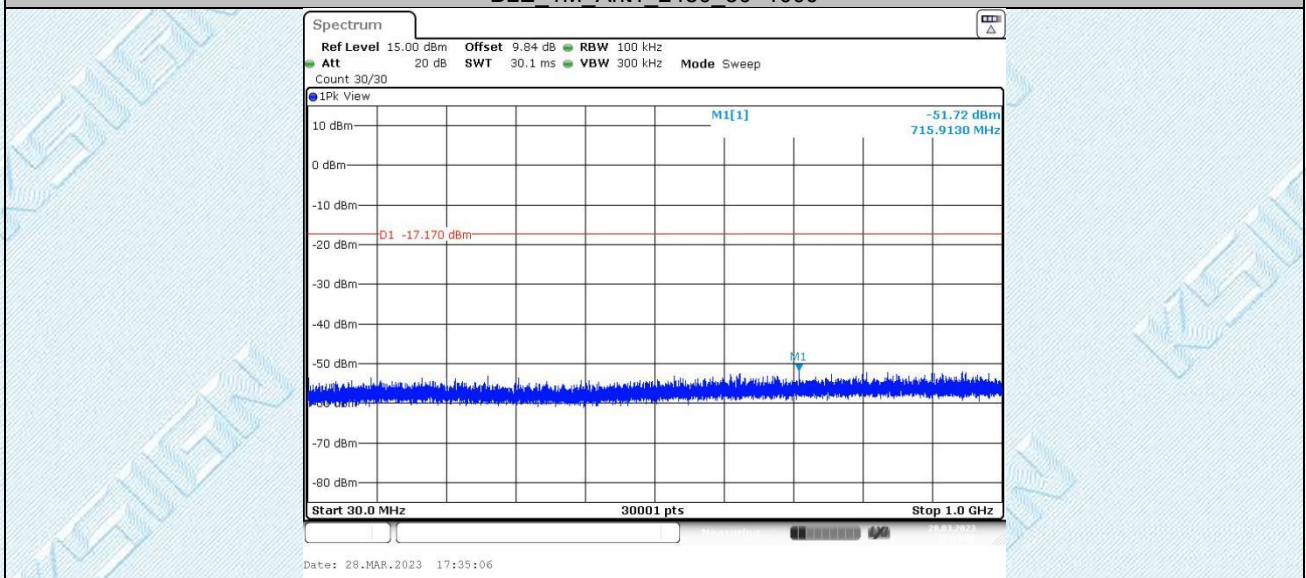

BLE 1M Ant1 2480 1000~26500

TRF RF\_R1

Add: West Side of 1/F., Building C, Zone A, Fuyuan New Factory, Jiujiu Industrial Park, Minzhu, Shatou, Shajing, Bao'an District, Shenzhen, Guangdong, China

Tel: +(86) 0755-2985 2678 Fax: +(86) 0755-2985 2397 E-mail: info@gdkesign.cn Web: www.gdkesign.com

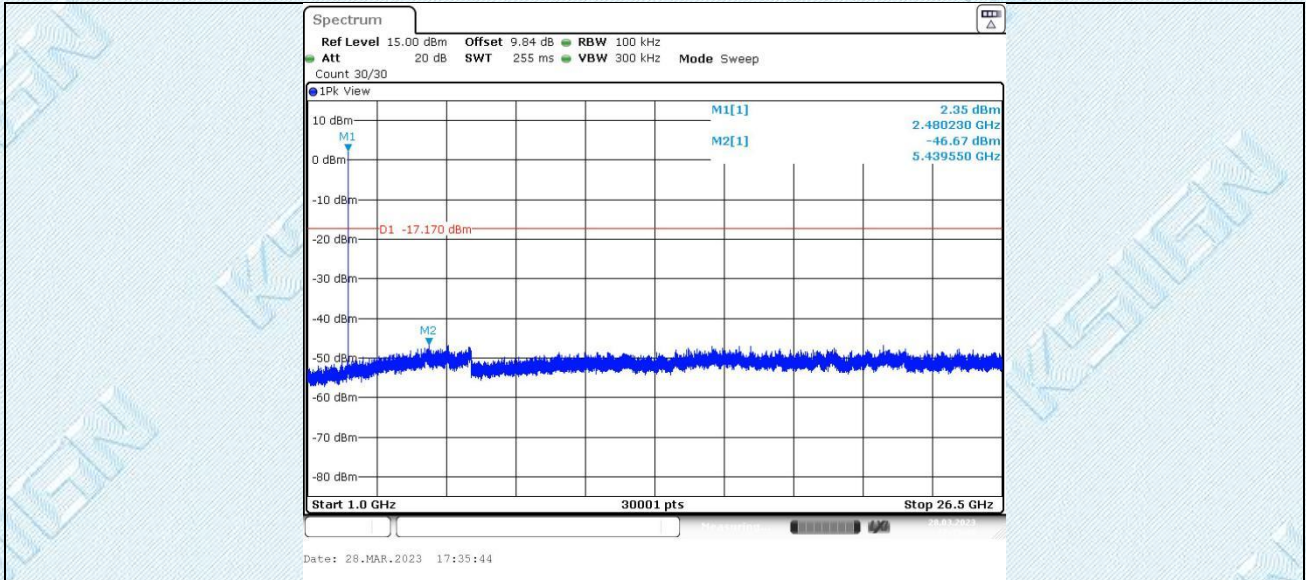

TRF RF\_R1

Add: West Side of 1/F., Building C, Zone A, Fuyuan New Factory, Jiujiu Industrial Park, Minzhu, Shatou, Shajing, Bao'an District, Shenzhen, Guangdong, China

Tel: +(86) 0755-2985 2678 Fax: +(86) 0755-2985 2397 E-mail: info@gdksign.cn Web: www.gdksign.com

## 6.8. Appendix H: Duty Cycle

### 6.8.1. Test Result

TestMode	Antenna	Freq[MHz]	ON Time [ms]	Period [ms]	DC [%]	Limit	Verdict
BLE 1M	Ant1	2440	0.38	0.63	60.32	---	PASS

DC(%)=ON Time(ms)/Period(ms)\*100%

### 6.8.2. Test Graphs

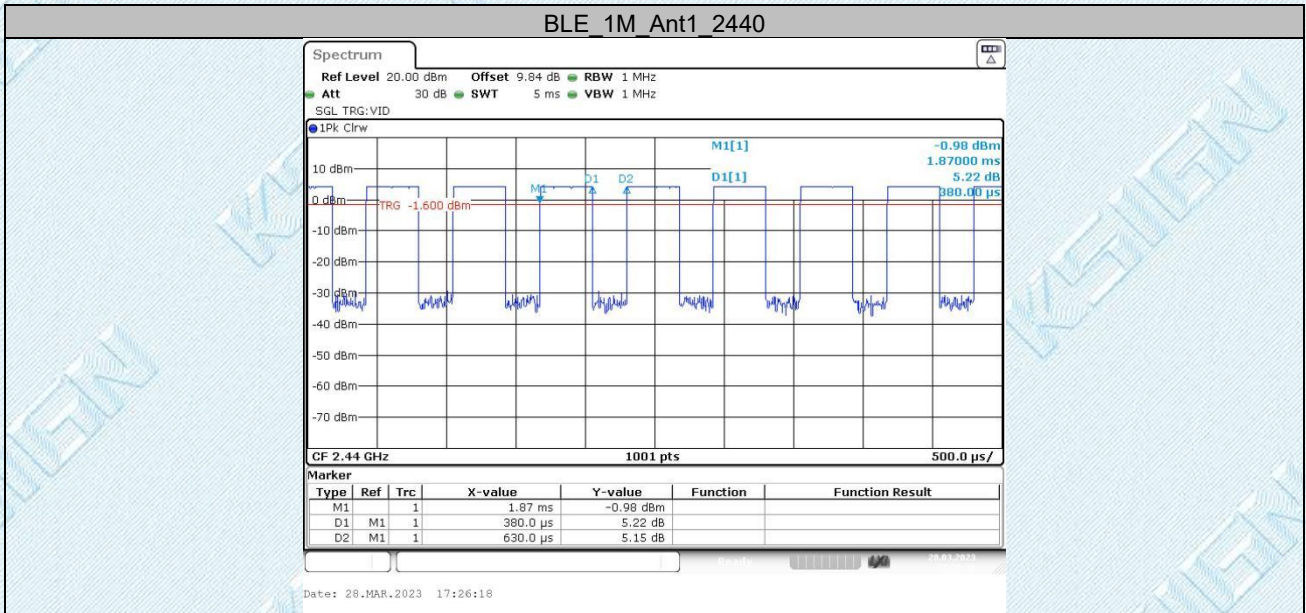

--THE END--