

TEST REPORT

Report No..... : KD2208S3798E
FCC ID..... : 2AZ2R-LT1
Applicant..... : Shenzhen USEER Robotics Co.,Ltd.
Address..... : Building 2, Fashion Brand Industrial Park, E'Bu Town, Shenzhen-Shanwei Special Cooperation Zone, Shenzhen, Guangdong, China.
Manufacturer..... : Shenzhen USEER Robotics Co.,Ltd.
Address..... : Building 2, Fashion Brand Industrial Park, E'Bu Town, Shenzhen-Shanwei Special Cooperation Zone, Shenzhen, Guangdong, China.
Product Name..... : Mopping Robotic
Trademark..... : Lefant,USEER,OKP,PETGUGU
Model/Type reference..... : LT1, T1, LT*, LT**, T*, T**(*=9-0 or A-Z)
Standard..... : 47 CFR Part 15.249
Date of Receipt..... : August 24, 2022
Date of Test Date..... : August 24, 2022 to November 22, 2022
Date of issue..... : November 22, 2022
Test result..... : Pass

Prepared by:
(Printed name + Signature) Pai Zheng



Approved by:
(Printed name + Signature) Sky Dong



Testing Laboratory Name...: KSIGN(Guangdong) Testing Co., Ltd.
Address..... : West Side of 1/F., Building C, Zone A, Fuyuan New Factory, Jiujiu Industrial Park, Minzhu, Shatou, Shajing, Bao'an District, Shenzhen, Guangdong, China

This test report may be duplicated completely for legal use with the approval of the applicant. It should not be reproduced except in full, without the written approval of our laboratory. The client should not use it to claim product endorsement by KSIGN. The test results in the report only apply to the tested sample. The test report shall be invalid without all the signatures of testing engineers, reviewer and approver. Any objections must be raised to TSTLMS within 15 days since the date when the report is received. It will not be taken into consideration beyond this limit. The test report merely corresponds to the test sample. The report is invalid if it is not stamped with the "Testing Special Stamp" and the "Riding Seam Stamp".

TABLE OF CONTENTS**Page**

1. TEST SUMMARY	3
1.1. Test Standards	3
1.2. Report Version	3
1.3. Test Description	4
1.4. Test Facility	5
1.5. Measurement Uncertainty	6
2. GENERAL INFORMATION	7
2.1. General Description Of EUT	7
2.2. Accessory Equipment Information	7
2.3. Description of Test Modes	7
2.4. Measurement Instruments List	8
3. EVALUATION RESULTS (EVALUATION)	11
3.1. Antenna requirement	11
4. RADIO SPECTRUM MATTER TEST RESULTS (RF)	11
4.1. Conducted Emission at AC power line	11
4.2. 20dB Occupied Bandwidth	15
4.3. Field strength of fundamental	19
4.4. Bandedge	21
4.5. Radiated Emission (below 1GHz)	23
4.6. Radiated Emission (above 1GHz)	31
5. EUT TEST PHOTOS	39
6. PHOTOGRAPHS OF EUT CONSTRUCTIONAL	41

1. TEST SUMMARY

1.1. Test Standards

The tests were performed according to following standards:

47 CFR Part 15.249: Operation within the bands 902-928 MHz, 2400-2483.5 MHz, 5725-5875 MHz, and 24.0-24.25 GHz

1.2. Report Version

Revised No.	Date of issue	Description
01	November 22, 2022	Original

1.3. Test Description

Test Item	Standard	Requirement	Result
Antenna requirement	47 CFR Part 15.249	Part 15.203	Pass
Conducted Emission at AC power line	47 CFR Part 15.249	47 CFR 15.207(a)	Pass
Occupied Bandwidth	47 CFR Part 15.249	47 CFR 15.215(c)	Pass
Field strength of fundamental	47 CFR Part 15.249	47 CFR 15.249(a)	Pass
Emissions around the fundamental which falls within the restriction frequency bands	47 CFR Part 15.249	47 CFR 15.249(d)	Pass
Emissions in restricted frequency bands (below 1GHz)	47 CFR Part 15.249	47 CFR 15.249(a) 47 CFR 15.249(d) 47 CFR 15.249(e)	Pass
Emissions in restricted frequency bands (above 1GHz)	47 CFR Part 15.249	47 CFR 15.249(a) 47 CFR 15.249(d) 47 CFR 15.249(e)	Pass

1.4. Test Facility

KSIGN(Guangdong) Testing Co., Ltd.

West Side of 1/F., Building C, Zone A, Fuyuan New Factory, Jiujiu Industrial Park, Minzhu, Shatou, Shajing, Bao'an District, Shenzhen, Guangdong, China

The test facility is recognized, certified, or accredited by the following organizations:

CNAS-Lab Code: L13261

KSIGN(Guangdong) Testing Co., Ltd. has been assessed and proved to be in Compliance with CNAS-CL01 Accreditation Criteria for Testing and Calibration Laboratories (identical to ISO/IEC17025: 2017 General Requirements) for the Competence of Testing and Calibration Laboratories.

A2LA-Lab Cert. No.: 5457.01

KSIGN(Guangdong) Testing Co., Ltd. EMC Laboratory has been accredited by A2LA for technical competence in the field of electrical testing, and proved to be in compliance with ISO/IEC 17025:2017 General Requirements for the Competence of Testing and Calibration Laboratories and any additional program requirements in the identified field of testing

ISED#: 25693 CAB identifier.: CN0096

KSIGN(Guangdong) Testing Co., Ltd. has been listed by Innovation, Science and Economic Development Canada to perform electromagnetic emission measurement.

FCC-Registration No.: 294912 Designation Number: CN1328

KSIGN(Guangdong) Testing Co., Ltd. EMC Laboratory has been listed on the US Federal Communications Commission list of test facilities recognized to perform electromagnetic emissions measurements.

1.5. Measurement Uncertainty

Test Items	Measurement Uncertainty
Conducted Emission (150k-30MHz)	± 3.34dB
RSE (30-1000MHz)	± 5.7dB
RSE (1-18GHz)	± 4.68dB
RSE (18-40GHz)	± 5.18dB

The reported uncertainty of measurement $y \pm U$, where expanded uncertainty U is based on a standard uncertainty multiplied by a coverage factor of $k=2$, providing a level of confidence of approximately 95 %.

2. GENERAL INFORMATION

2.1. General Description Of EUT

Product Name:	Mopping Robotic
Trademark:	Lefant,USEER,OKP,PETGUGU
Model / Type reference:	LT1, T1, LT*, LT**, T*, T**(*=9-0 or A-Z)
Model different:	The only difference between product models is the color and appearance. Different model names are available to meet market demands. Other power supply methods, internal structures, circuits and key components are the same, and do not affect safety and electromagnetic compatibility performance.
Power supply:	DC 12.8V from battery
Operation Frequency:	921MHz~927.9MHz
Number of Channels:	20
Modulation Type:	GFSK
Antenna Type:	Spring
Antenna Gain:	3dBi

2.2. Accessory Equipment Information

The EUT was tested as an independent device.

2.3. Description of Test Modes

No.	Title	Description of Mode
Test Mode1	921M SRD	Keep EUT is transmitting mode

The Applicant provides communication tools software(Engineer mode) to control the EUT for staying in continuous transmitting mode for testing .There are 20 channels provided to the EUT and Low(Channel 01)/Mid(Channel 08)/High (Channel 19) were selected to test.

Channel	Frequency (MHz)	Channel	Frequency (MHz)
1	921.0	11	925.8
2	921.3	12	926.1
3	921.6	13	926.4
4	921.9	14	926.7
5	922.2	15	922.8
6	923.4	16	927.0
7	923.7	17	927.3
8	924.0	18	927.6
9	923.1	19	927.9
10	924.6	20	925.2

2.4. Measurement Instruments List

Conducted Emission at AC power line				
Test Equipment	Manufacturer	Model No.	Serial No.	Cal. Until
LISN	R&S	ENV432	1326.6105.02	2023-03-04
EMI Test Receiver	R&S	ESR	102524	2023-03-04
Manual RF Switch	JS TOYO	/	MSW-01/002	2023-03-04
ISN CAT6	Schwarzbeck	CAT5 8158	227	2023-03-04
Color Signal Generator	Philips	PM5418	672926	2023-03-04
Power Absorbing Clamp	R&S	MDS-21	100925	2023-03-26

Occupied Bandwidth				
Test Equipment	Manufacturer	Model No.	Serial No.	Cal. Until
Wideband Radio Communication Tester	R&S	CMU200	115297	2023-03-04
Audio Analyzer	R&S	UPL16	100001	2023-03-04
Shielding box	Gxiong	GX-5915A	2201113	2023-04-23
High Pass Filter	COM-MW Technology Co., Ltd	ZHPF-M1.2-9G-187	09203403	2023-03-04
Band Stop Filter	COM-MW Technology Co., Ltd	ZBSF6-C820-920-188	09203401	2023-03-04
Splitter	COM-MW Technology Co., Ltd	ZPD-M1-8-2103	09203407	2023-03-04
Coaxial Cable	BEBES	A40-2.92M2.92F-4.5M	1907021	2023-03-04
Hygrothermograph	Anymetre	JB913	/	2023-03-07
Climate Chamber	Angul	AGNH80L	1903042120	2023-03-04
Spectrum Analyzer	HP	8593E	3831U02087	2023-03-04
Dual Output DC Power Supply	Agilent	E3646A	MY40009992	2023-03-04
RF Control Unit	Tonscend	JS0806-2	/	2023-03-04
Analog Signal Generator	HP	83752A	3344A00337	2023-03-04
Vector Signal Generator	Agilent	N5182A	MY50142520	2023-03-04
Wideband Radio Communication Tester	R&S	CMW500	157282	2023-03-04
Spectrum Analyzer	R&S	FSV40-N	101798	2023-03-04

Field strength of fundamental				
Test Equipment	Manufacturer	Model No.	Serial No.	Cal. Until
Ultra-Broadband logarithmic period Antenna	Schwarzbeck	VULB 9163	1230	2023-04-12
Pre-Amplifier	Schwarzbeck	BBV 9745	9745#129	2023-03-04
Color Signal Generator	Philips	PM5418	672926	2023-03-04
Broadcast Television Signal Generator	R&S	SFE100	141038	2023-03-04
Analog Signal Generator	Agilent	8648A	3847M00445	2023-03-04
EMI Test Receiver	R&S	ESR	102525	2023-03-04
Horn Antenna	Schwarzbeck	BBHA 9120 D	2023	2023-03-29
Pre-Amplifier	EMCI	EMC051835SE	980662	2023-03-04
Spectrum Analyzer	Keysight	N9020A	MY46471971	2023-03-04

TRF EMC_R1

Add: West Side of 1/F., Building C, Zone A, Fuyuan New Factory, Jiujiu Industrial Park, Minzhu, Shatou, Shajing, Bao'an District, Shenzhen, Guangdong, China

Tel: +(86) 0755-2985 2678 Fax: +(86) 0755-2985 2397 E-mail: info@gdkesign.cn Web: www.gdkesign.com

Loop Antenna	Beijin ZHINAN	ZN30900C	18050	2023-03-05
--------------	---------------	----------	-------	------------

Emissions around the fundamental which falls within the restriction frequency bands				
Test Equipment	Manufacturer	Model No.	Serial No.	Cal. Until
Ultra-Broadband logarithmic period Antenna	Schwarzbeck	VULB 9163	1230	2023-04-12
Pre-Amplifier	Schwarzbeck	BBV 9745	9745#129	2023-03-04
Color Signal Generator	Philips	PM5418	672926	2023-03-04
Broadcast Television Signal Generator	R&S	SFE100	141038	2023-03-04
Analog Signal Generator	Agilent	8648A	3847M00445	2023-03-04
EMI Test Receiver	R&S	ESR	102525	2023-03-04
Horn Antenna	Schwarzbeck	BBHA 9120 D	2023	2023-03-29
Pre-Amplifier	EMCI	EMC051835SE	980662	2023-03-04
Spectrum Analyzer	Keysight	N9020A	MY46471971	2023-03-04
Loop Antenna	Beijin ZHINAN	ZN30900C	18050	2023-03-05

Emissions in restricted frequency bands (below 1GHz)				
Test Equipment	Manufacturer	Model No.	Serial No.	Cal. Until
Ultra-Broadband logarithmic period Antenna	Schwarzbeck	VULB 9163	1230	2023-04-12
Pre-Amplifier	Schwarzbeck	BBV 9745	9745#129	2023-03-04
Color Signal Generator	Philips	PM5418	672926	2023-03-04
Broadcast Television Signal Generator	R&S	SFE100	141038	2023-03-04
Analog Signal Generator	Agilent	8648A	3847M00445	2023-03-04
EMI Test Receiver	R&S	ESR	102525	2023-03-04
Horn Antenna	Schwarzbeck	BBHA 9120 D	2023	2023-03-29
Pre-Amplifier	EMCI	EMC051835SE	980662	2023-03-04
Spectrum Analyzer	Keysight	N9020A	MY46471971	2023-03-04
Loop Antenna	Beijin ZHINAN	ZN30900C	18050	2023-03-05

TRF EMC_R1

Add: West Side of 1/F., Building C, Zone A, Fuyuan New Factory, Jiujiu Industrial Park, Minzhu, Shatou, Shajing, Bao'an District, Shenzhen, Guangdong, China

Tel: +(86) 0755-2985 2678 Fax: +(86) 0755-2985 2397 E-mail: info@gdkesign.cn Web: www.gdkesign.com

Emissions in restricted frequency bands (above 1GHz)				
Test Equipment	Manufacturer	Model No.	Serial No.	Cal. Until
Ultra-Broadband logarithmic period Antenna	Schwarzbeck	VULB 9163	1230	2023-04-12
Pre-Amplifier	Schwarzbeck	BBV 9745	9745#129	2023-03-04
Color Signal Generator	Philips	PM5418	672926	2023-03-04
Broadcast Television Signal Generator	R&S	SFE100	141038	2023-03-04
Analog Signal Generator	Agilent	8648A	3847M00445	2023-03-04
EMI Test Receiver	R&S	ESR	102525	2023-03-04
Horn Antenna	Schwarzbeck	BBHA 9120 D	2023	2023-03-29
Pre-Amplifier	EMCI	EMC051835SE	980662	2023-03-04
Spectrum Analyzer	Keysight	N9020A	MY46471971	2023-03-04
Loop Antenna	Beijin ZHINAN	ZN30900C	18050	2023-03-05

TRF EMC_R1

Add: West Side of 1/F., Building C, Zone A, Fuyuan New Factory, Jiujiu Industrial Park, Minzhu, Shatou, Shajing, Bao'an District, Shenzhen, Guangdong, China

Tel: +(86) 0755-2985 2678 Fax: +(86) 0755-2985 2397 E-mail: info@gdkesign.cn Web: www.gdkesign.com

3. Evaluation Results (Evaluation)

3.1. Antenna requirement

Test Requirement:	An intentional radiator shall be designed to ensure that no antenna other than that furnished by the responsible party shall be used with the device. The use of a permanently attached antenna or of an antenna that uses a unique coupling to the intentional radiator shall be considered sufficient to comply with the provisions of this section.
-------------------	--------------------------------------------------------------------------------------------------------------------------------------------------------------------------------------------------------------------------------------------------------------------------------------------------------------------------------------------------------

3.1.1. Conclusion:

The directional gain of the antenna less than 6dBi. It comply with the standard requirement. In case of replacement of broken antenna the same antenna type must be used.
 Antenna structure please refer to the EUT internal photographs antenna photo.

4. Radio Spectrum Matter Test Results (RF)

4.1. Conducted Emission at AC power line

Test Requirement:	Except as shown in paragraphs (b)and (c)of this section, for an intentional radiator that is designed to be connected to the public utility (AC) power line, the radio frequency voltage that is conducted back onto the AC power line on any frequency or frequencies, within the band 150 kHz to 30 MHz, shall not exceed the limits in the following table, as measured using a 50 μH/50 ohms line impedance stabilization network (LISN).		
Test Limit:	Frequency of emission (MHz)	Conducted limit (dBμV)	
		Quasi-peak	Average
	0.15-0.5	66 to 56*	56 to 46*
	0.5-5	56	46
	5-30	60	50
	*Decreases with the logarithm of the frequency.		
Test Method:	Refer to ANSI C63.10-2013 section 6.2, standard test method for ac power-line conducted emissions from unlicensed wireless devices		

4.1.1. E.U.T. Operation:

Operating Environment:	
Temperature:	25.9 °C
Humidity:	54.7 %
Atmospheric Pressure:	101 kPa
Final test mode:	Test Mode1

4.1.2. Test Setup Diagram:

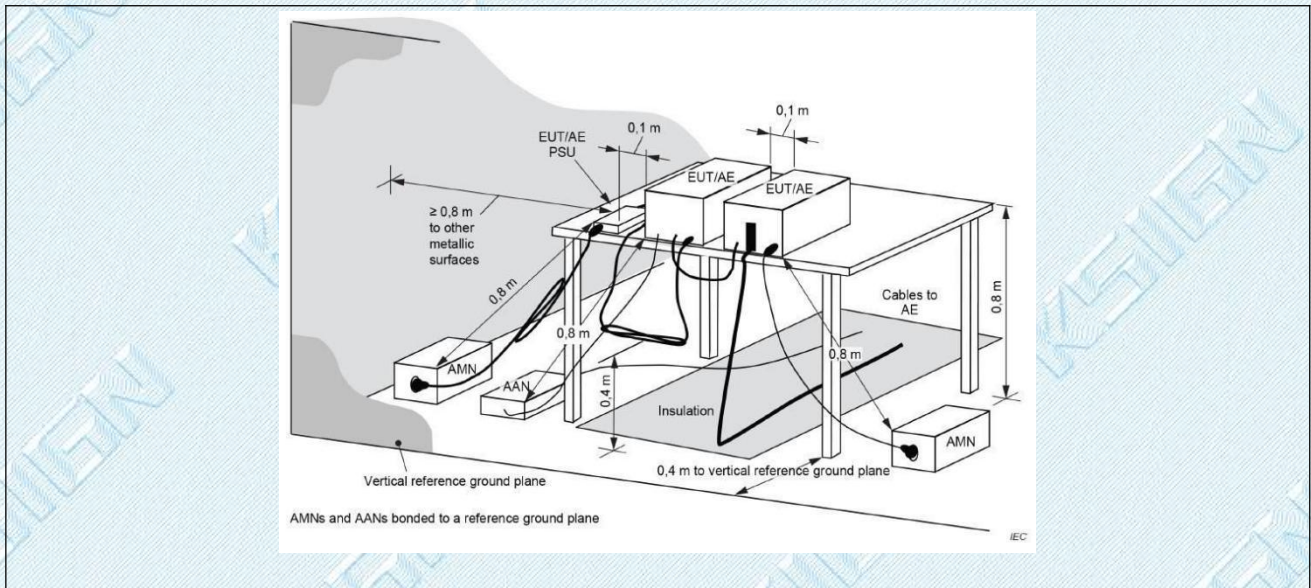

4.1.3. Test Data:

Test Mode1 / Line: Line

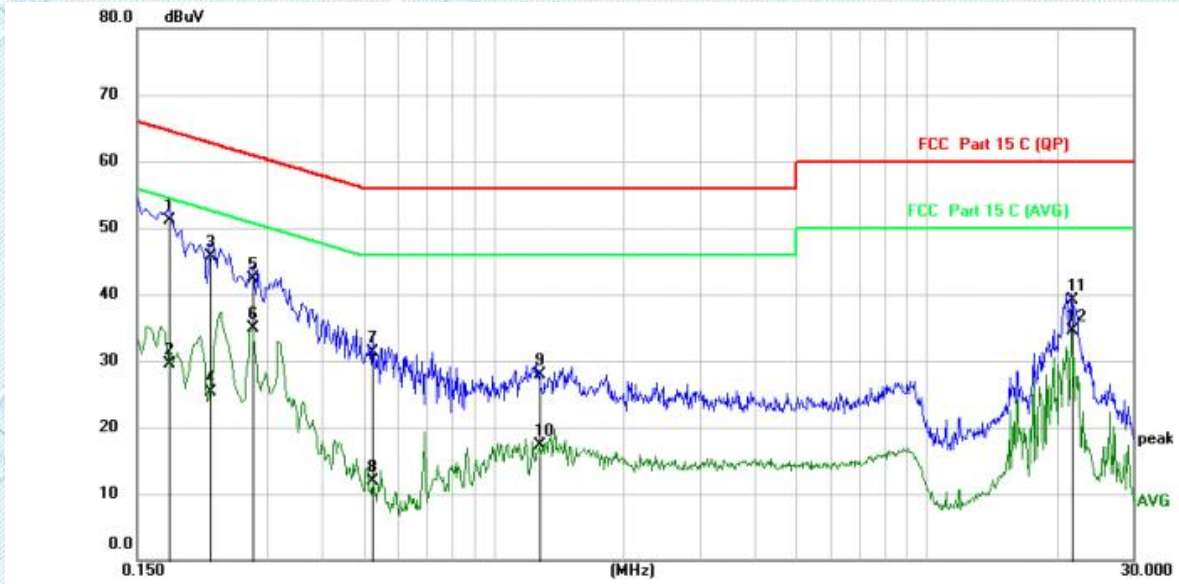

No. Mk.	Freq. MHz	Reading Level dBuV	Correct Factor dB	Measurement dBuV	Limit dBuV	Over dB	Detector	Comment
1 *	0.1785	40.34	10.74	51.08	64.56	-13.48	QP	
2	0.1785	18.74	10.74	29.48	54.56	-25.08	AVG	
3	0.2220	34.86	10.75	45.61	62.74	-17.13	QP	
4	0.2220	14.48	10.75	25.23	52.74	-27.51	AVG	
5	0.2779	31.61	10.61	42.22	60.88	-18.66	QP	
6	0.2779	24.22	10.61	34.83	50.88	-16.05	AVG	
7	0.5260	20.92	10.41	31.33	56.00	-24.67	QP	
8	0.5260	1.41	10.41	11.82	46.00	-34.18	AVG	
9	1.2820	17.54	10.41	27.95	56.00	-28.05	QP	
10	1.2820	6.95	10.41	17.36	46.00	-28.64	AVG	
11	21.6620	28.56	10.64	39.20	60.00	-20.80	QP	peak
12	21.6620	23.95	10.64	34.59	50.00	-15.41	AVG	AVG

Test Mode1 / Line: Neutral

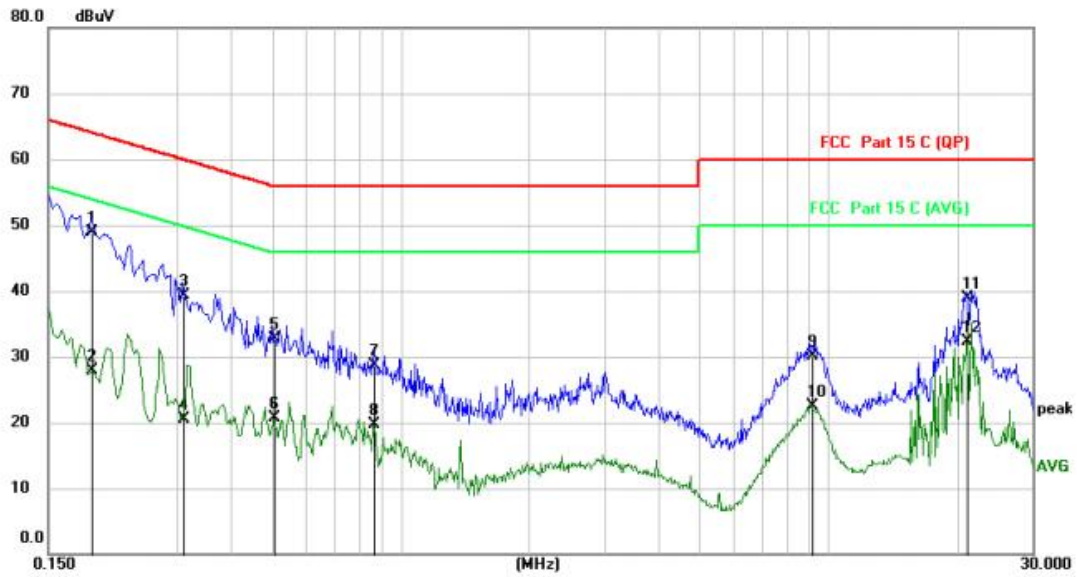

No.	Mk.	Freq.	Reading Level	Correct Factor	Measurement	Limit	Over	Detector	Comment
		MHz	dBuV	dB	dBuV	dBuV	dB		
1	*	0.1900	38.20	10.75	48.95	64.04	-15.09	QP	
2		0.1900	17.25	10.75	28.00	54.04	-26.04	AVG	
3		0.3100	28.84	10.51	39.35	59.97	-20.62	QP	
4		0.3100	9.98	10.51	20.49	49.97	-29.48	AVG	
5		0.5060	22.18	10.52	32.70	56.00	-23.30	QP	
6		0.5060	10.18	10.52	20.70	46.00	-25.30	AVG	
7		0.8660	18.26	10.45	28.71	56.00	-27.29	QP	
8		0.8660	9.23	10.45	19.68	46.00	-26.32	AVG	
9		9.1580	19.50	10.58	30.08	60.00	-29.92	QP	
10		9.1580	11.85	10.58	22.43	50.00	-27.57	AVG	
11		21.1140	28.09	10.89	38.98	60.00	-21.02	QP	
12		21.1140	21.48	10.89	32.37	50.00	-17.63	AVG	

TRF EMC_R1

Add: West Side of 1/F., Building C, Zone A, Fuyuan New Factory, Jiujiu Industrial Park, Minzhu, Shatou, Shajing, Bao'an District, Shenzhen, Guangdong, China

Tel: +(86) 0755-2985 2678 Fax: +(86) 0755-2985 2397 E-mail: info@gdkesign.cn Web: www.gdkesign.com

4.2. 20dB Occupied Bandwidth

Test Requirement:	Intentional radiators operating under the alternative provisions to the general emission limits, as contained in §§ 15.217 through 15.257 and in subpart E of this part, must be designed to ensure that the 20 dB bandwidth of the emission, or whatever bandwidth may otherwise be specified in the specific rule section under which the equipment operates, is contained within the frequency band designated in the rule section under which the equipment is operated.
Test Limit:	Intentional radiators operating under the alternative provisions to the general emission limits, as contained in §§ 15.217 through 15.257 and in subpart E of this part, must be designed to ensure that the 20 dB bandwidth of the emission, or whatever bandwidth may otherwise be specified in the specific rule section under which the equipment operates, is contained within the frequency band designated in the rule section under which the equipment is operated.
Test Method:	Occupied bandwidth—relative measurement procedure
Procedure:	<p>a) The spectrum analyzer center frequency is set to the nominal EUT channel center frequency. The span range for the EMI receiver or spectrum analyzer shall be between two times and five times the OBW.</p> <p>b) The nominal IF filter bandwidth (3 dB RBW) shall be in the range of 1% to 5% of the OBW and video bandwidth (VBW) shall be approximately three times RBW, unless otherwise specified by the applicable requirement.</p> <p>c) Set the reference level of the instrument as required, keeping the signal from exceeding the maximum input mixer level for linear operation. In general, the peak of the spectral envelope shall be more than $[10 \log (OBW/RBW)]$ below the reference level. Specific guidance is given in 4.1.5.2.</p> <p>d) Steps a) through c) might require iteration to adjust within the specified tolerances.</p> <p>e) The dynamic range of the instrument at the selected RBW shall be more than 10 dB below the target “-xx dB down” requirement; that is, if the requirement calls for measuring the -20 dB OBW, the instrument noise floor at the selected RBW shall be at least 30 dB below the reference value.</p> <p>f) Set detection mode to peak and trace mode to max hold.</p> <p>g) Determine the reference value: Set the EUT to transmit an unmodulated carrier or modulated signal, as applicable. Allow the trace to stabilize. Set the spectrum analyzer marker to the highest level of the displayed trace (this is the reference value).</p> <p>h) Determine the “-xx dB down amplitude” using $[(\text{reference value}) - xx]$. Alternatively, this calculation may be made by using the marker-delta function of the instrument.</p> <p>i) If the reference value is determined by an unmodulated carrier, then turn the EUT modulation ON, and either clear the existing trace or start a new trace on the spectrum analyzer and allow the new trace to stabilize. Otherwise, the trace from step g) shall be used for step j).</p> <p>j) Place two markers, one at the lowest frequency and the other at the highest frequency of the envelope of the spectral display, such that each marker is at or slightly below the “-xx dB down amplitude” determined in step h). If a marker is below this “-xx dB down amplitude” value, then it shall be as close as possible to this value. The occupied bandwidth is the frequency difference between the two markers. Alternatively, set a marker at the lowest frequency of the envelope of the spectral display, such that the marker is at or slightly below the “-xx dB down amplitude” determined in step h). Reset the marker-delta function and move the marker to the other side of the emission until the delta marker amplitude is at the same level as the reference marker amplitude. The marker-delta frequency reading at this point is the specified emission</p>

TRF EMC_R1

Add: West Side of 1/F., Building C, Zone A, Fuyuan New Factory, Jiujiu Industrial Park, Minzhu, Shatou, Shajing, Bao'an District, Shenzhen, Guangdong, China

Tel: +(86) 0755-2985 2678 Fax: +(86) 0755-2985 2397 E-mail: info@gdksign.cn Web: www.gdksign.com

	bandwidth. k) The occupied bandwidth shall be reported by providing plot(s) of the measuring instrument display; the plot axes and the scale units per division shall be clearly labeled. Tabular data may be reported in addition to the plot(s).
--	-------------------------------------------------------------------------------------------------------------------------------------------------------------------------------------------------------------------------------------------------------

4.2.1. E.U.T. Operation:

Operating Environment:	
Temperature:	24.6 °C
Humidity:	54.2 %
Atmospheric Pressure:	101 kPa
Final test mode:	Test Mode1

4.2.2. Test Setup Diagram:

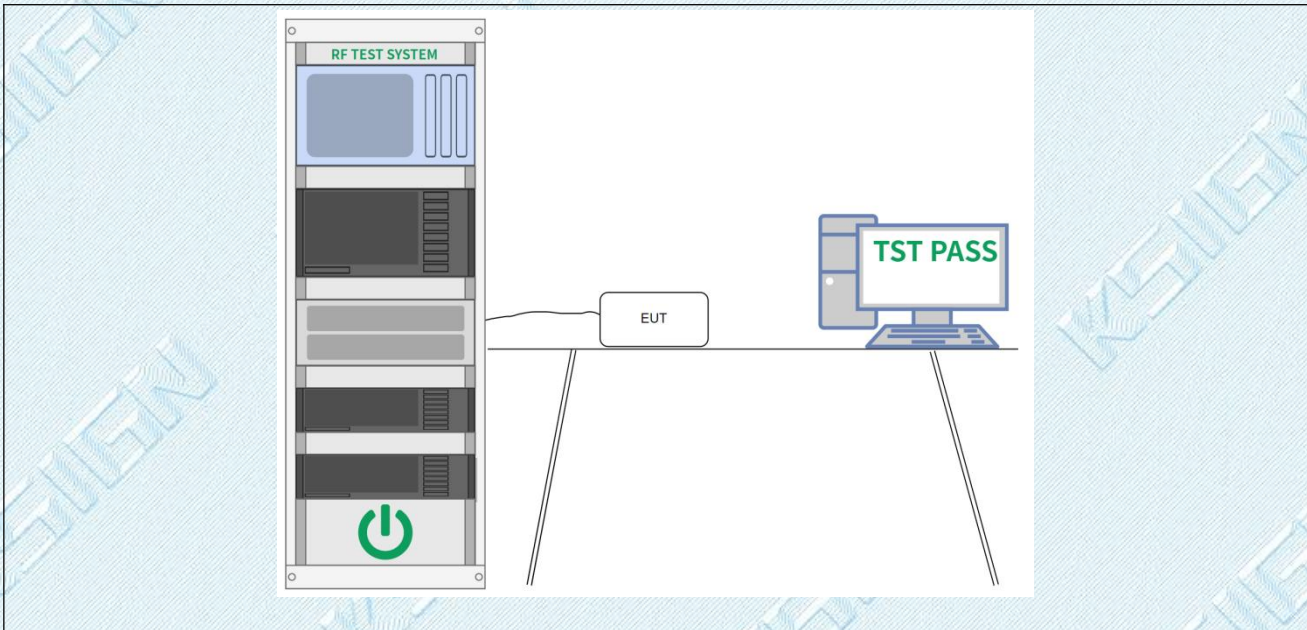

4.2.3. Test Data:

TestMode	Antenna	Freq(MHz)	20dB OCB [kHz]	Verdict
SRD	Ant1	921.0	370.5	Pass
		924.0	384.9	Pass
		927.9	389.3	Pass

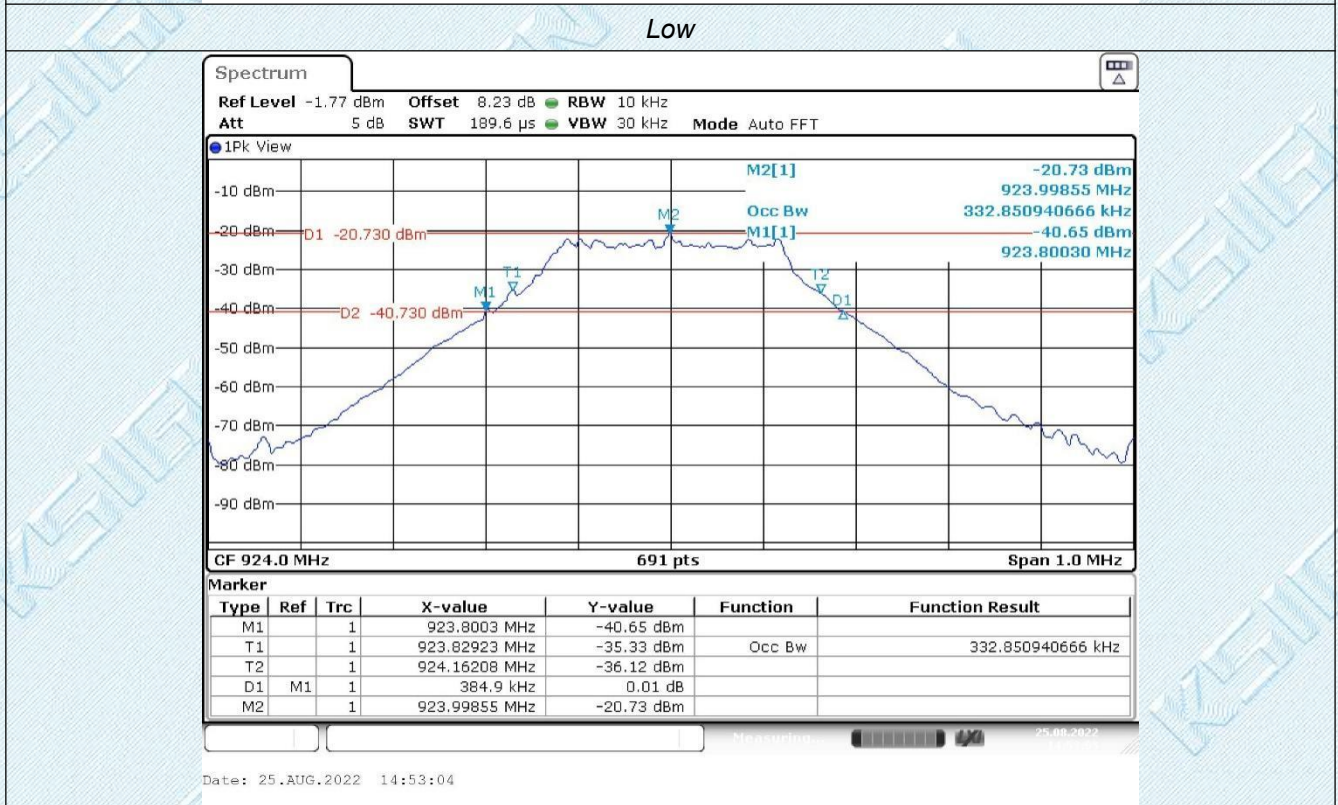
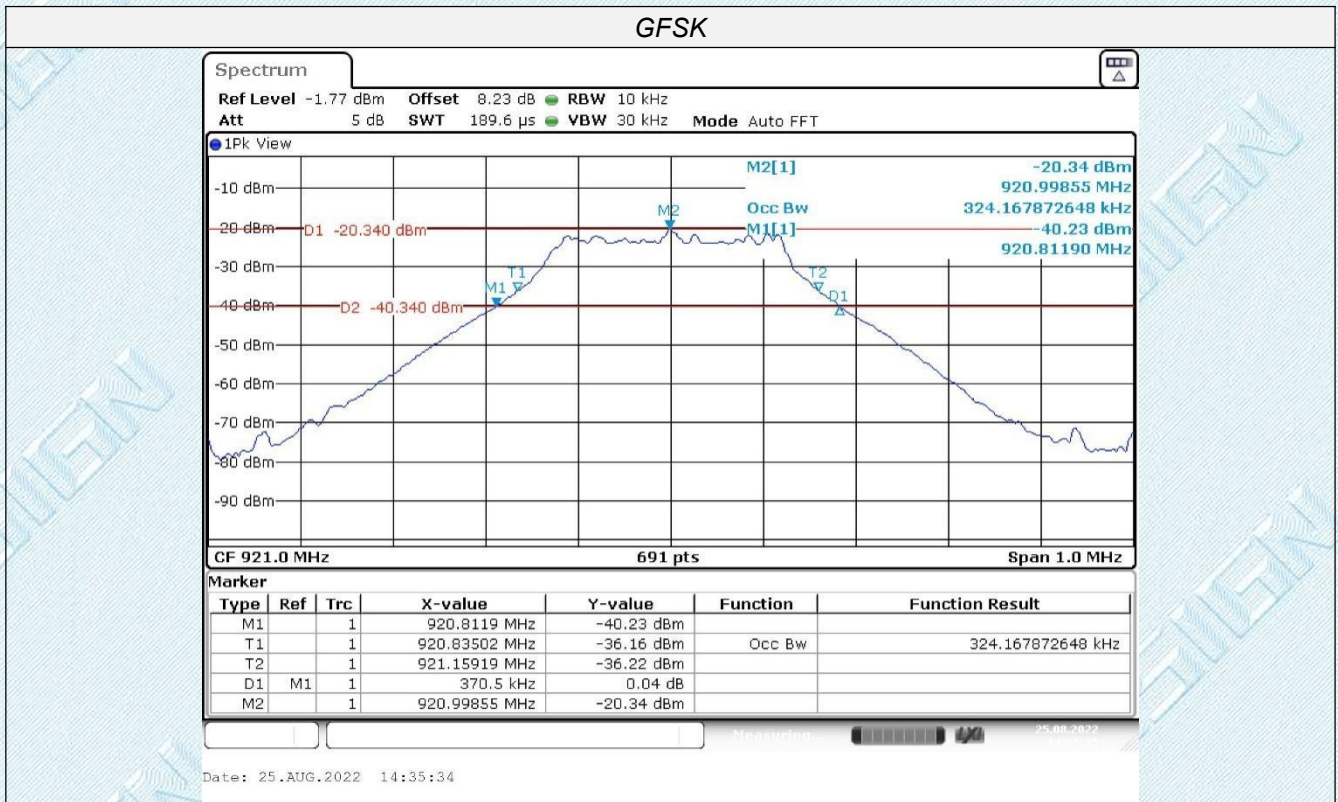

Mid

TRF EMC_R1

Add: West Side of 1/F., Building C, Zone A, Fuyuan New Factory, Jiujiu Industrial Park, Minzhu, Shatou, Shajing, Bao'an District, Shenzhen, Guangdong, China

Tel: +(86) 0755-2985 2678 Fax: +(86) 0755-2985 2397 E-mail: info@gdkesign.cn Web: www.gdkesign.com

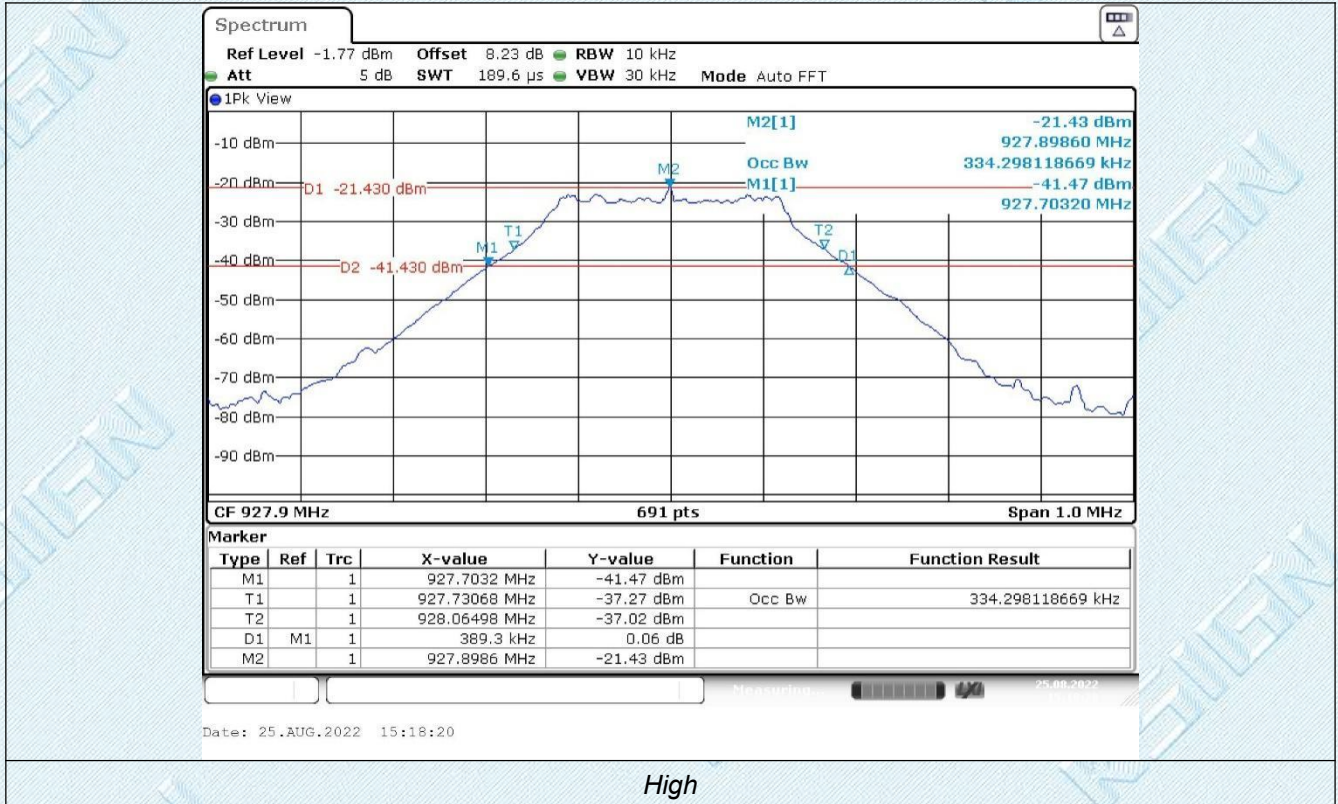

High

4.3. Field strength of fundamental

Test Requirement:	Except as provided in paragraph (b) of this section, the field strength of emissions from intentional radiators operated within these frequency bands shall comply with the following:		
	Fundamental frequency	Field strength of fundamental (millivolts/meter)	Field strength of harmonics (microvolts/meter)
	902-928 MHz	50	500
	2400-2483.5 MHz	50	500
	5725-5875 MHz	50	500
	24.0-24.25 GHz	250	2500
Test Limit:	Except as provided in paragraph (b) of this section, the field strength of emissions from intentional radiators operated within these frequency bands shall comply with the following:		
	Fundamental frequency	Field strength of fundamental (millivolts/meter)	Field strength of harmonics (microvolts/meter)
	902-928 MHz	50	500
	2400-2483.5 MHz	50	500
	5725-5875 MHz	50	500
	24.0-24.25 GHz	250	2500

4.3.1. E.U.T. Operation:

Operating Environment:	
Temperature:	25.1 °C
Humidity:	49.5 %
Atmospheric Pressure:	101 kPa
Final test mode:	Test Mode1

4.3.2. Test Data:

Frequency (MHz)	Read Level (dBUV/m)	Correct Factor (dB/m)	Level (dBUV/m)	Limit (dBUV/m)	Over (dBUV/m)	Polarization	Test value
921.0	96.24	-4.02	92.22	114	-21.78	Horizontal	Peak
924.0	97.72	-3.99	93.73	114	-20.27	Horizontal	Peak
927.9	95.72	-3.97	91.78	114	-22.22	Horizontal	Peak
921.0	97.08	-4.02	93.06	114	-20.94	Vertical	Peak
924.0	97.71	-3.99	93.72	114	-20.28	Vertical	Peak
927.9	96.21	-3.97	92.24	114	-21.76	Vertical	Peak
921.0	87.52	-4.02	83.50	94	-10.50	Horizontal	AVG
924.0	87.63	-3.99	83.64	94	-10.36	Horizontal	AVG
927.9	85.78	-3.97	81.81	94	-12.19	Horizontal	AVG
921.0	87.07	-4.02	83.05	94	-10.95	Vertical	AVG
924.0	87.75	-3.99	83.76	94	-10.24	Vertical	AVG
927.9	86.24	-3.97	82.27	94	-11.73	Vertical	AVG

Note:

Level=Read Level+Correct Factor

Over=Level - Limit

4.4. Bandedge

Test Requirement:	Emissions radiated outside of the specified frequency bands, except for harmonics, shall be attenuated by at least 50 dB below the level of the fundamental or to the general radiated emission limits in § 15.209, whichever is the lesser attenuation.		
Test Limit:	Emissions radiated outside of the specified frequency bands, except for harmonics, shall be attenuated by at least 50 dB below the level of the fundamental or to the general radiated emission limits in § 15.209, whichever is the lesser attenuation.		
	Frequency (MHz)	Field strength (microvolts/meter)	Measurement distance (meters)
	0.009-0.490	2400/F(kHz)	300
	0.490-1.705	24000/F(kHz)	30
	1.705-30.0	30	30
	30-88	100 **	3
	88-216	150 **	3
	216-960	200 **	3
	Above 960	500	3
	** Except as provided in paragraph (g), fundamental emissions from intentional radiators operating under this section shall not be located in the frequency bands 54-72 MHz, 76-88 MHz, 174-216 MHz or 470-806 MHz. However, operation within these frequency bands is permitted under other sections of this part, e.g., §§ 15.231 and 15.241.		
Test Method:	ANSI C63.10-2013 section 6.6.4		
Procedure:	ANSI C63.10-2013 section 6.6.4		

4.4.1. E.U.T. Operation:

Operating Environment:	
Temperature:	25.1 °C
Humidity:	49.5 %
Atmospheric Pressure:	101 kPa
Final test mode:	Test Mode1

4.4.2. Test Data:

Frequency(MHz):		921		Polarity:		HORIZONTAL
Frequency (MHz)	Reading Level (dBuV/m)	Correc Factor (dB/m)	Measurement (dBuV/m)	Limit (dBuV/m)	Over (dB)	Detector
902.00	39.19	0.00	39.19	46	-6.81	QP

Frequency(MHz):		921		Polarity:		Vertical
Frequency (MHz)	Reading Level (dBuV/m)	Correc Factor (dB/m)	Measurement (dBuV/m)	Limit (dBuV/m)	Over (dB)	Detector
902.00	40.51	0.00	40.51	46	-5.49	QP

Frequency(MHz):		927.9		Polarity:		HORIZONTAL
Frequency (MHz)	Reading Level (dBuV/m)	Correc Factor (dB/m)	Measurement (dBuV/m)	Limit (dBuV/m)	Over (dB)	Detector
928.00	49.30	-3.95	45.35	46	-0.65	QP

Frequency(MHz):		927.9		Polarity:		Vertical
Frequency (MHz)	Reading Level (dBuV/m)	Correc Factor (dB/m)	Measurement (dBuV/m)	Limit (dBuV/m)	Over (dB)	Detector
928.00	47.82	-3.95	43.87	46	-2.13	QP

4.5. Radiated Emission (below 1GHz)

Test Requirement:	<p>47 CFR 15.249(a) 47 CFR 15.249(d) 47 CFR 15.249(e)</p>																																							
Test Limit:	<p>Except as provided in paragraph (b) of this section, the field strength of emissions from intentional radiators operated within these frequency bands shall comply with the following:</p> <table border="1" data-bbox="491 566 1431 797"> <thead> <tr> <th>Fundamental frequency</th> <th>Field strength of fundamental (millivolts/meter)</th> <th>Field strength of harmonics (microvolts/meter)</th> </tr> </thead> <tbody> <tr> <td>902-928 MHz</td> <td>50</td> <td>500</td> </tr> <tr> <td>2400-2483.5 MHz</td> <td>50</td> <td>500</td> </tr> <tr> <td>5725-5875 MHz</td> <td>50</td> <td>500</td> </tr> <tr> <td>24.0-24.25 GHz</td> <td>250</td> <td>2500</td> </tr> </tbody> </table> <p>Emissions radiated outside of the specified frequency bands, except for harmonics, shall be attenuated by at least 50 dB below the level of the fundamental or to the general radiated emission limits in § 15.209, whichever is the lesser attenuation.</p> <table border="1" data-bbox="491 1016 1431 1346"> <thead> <tr> <th>Frequency (MHz)</th> <th>Field strength (microvolts/meter)</th> <th>Measurement distance (meters)</th> </tr> </thead> <tbody> <tr> <td>0.009-0.490</td> <td>2400/F(kHz)</td> <td>300</td> </tr> <tr> <td>0.490-1.705</td> <td>24000/F(kHz)</td> <td>30</td> </tr> <tr> <td>1.705-30.0</td> <td>30</td> <td>30</td> </tr> <tr> <td>30-88</td> <td>100 **</td> <td>3</td> </tr> <tr> <td>88-216</td> <td>150 **</td> <td>3</td> </tr> <tr> <td>216-960</td> <td>200 **</td> <td>3</td> </tr> <tr> <td>Above 960</td> <td>500</td> <td>3</td> </tr> </tbody> </table> <p>** Except as provided in paragraph (g), fundamental emissions from intentional radiators operating under this section shall not be located in the frequency bands 54-72 MHz, 76-88 MHz, 174-216 MHz or 470-806 MHz. However, operation within these frequency bands is permitted under other sections of this part, e.g., §§ 15.231 and 15.241.</p> <p>As shown in § 15.35(b), for frequencies above 1000 MHz, the field strength limits in paragraphs (a) and (b) of this section are based on average limits. However, the peak field strength of any emission shall not exceed the maximum permitted average limits specified above by more than 20 dB under any condition of modulation. For point-to-point operation under paragraph (b) of this section, the peak field strength shall not exceed 2500 millivolts/meter at 3 meters along the antenna azimuth.</p>	Fundamental frequency	Field strength of fundamental (millivolts/meter)	Field strength of harmonics (microvolts/meter)	902-928 MHz	50	500	2400-2483.5 MHz	50	500	5725-5875 MHz	50	500	24.0-24.25 GHz	250	2500	Frequency (MHz)	Field strength (microvolts/meter)	Measurement distance (meters)	0.009-0.490	2400/F(kHz)	300	0.490-1.705	24000/F(kHz)	30	1.705-30.0	30	30	30-88	100 **	3	88-216	150 **	3	216-960	200 **	3	Above 960	500	3
Fundamental frequency	Field strength of fundamental (millivolts/meter)	Field strength of harmonics (microvolts/meter)																																						
902-928 MHz	50	500																																						
2400-2483.5 MHz	50	500																																						
5725-5875 MHz	50	500																																						
24.0-24.25 GHz	250	2500																																						
Frequency (MHz)	Field strength (microvolts/meter)	Measurement distance (meters)																																						
0.009-0.490	2400/F(kHz)	300																																						
0.490-1.705	24000/F(kHz)	30																																						
1.705-30.0	30	30																																						
30-88	100 **	3																																						
88-216	150 **	3																																						
216-960	200 **	3																																						
Above 960	500	3																																						
Test Method:	Radiated emissions tests																																							
Procedure:	ANSI C63.10-2013 section 6.6.4																																							

4.5.1. E.U.T. Operation:

Operating Environment:	
Temperature:	25.1 °C
Humidity:	49.5 %
Atmospheric Pressure:	101 kPa
Final test mode:	Test Mode1

Note:

Both modes of were tested at Low, Middle, and High channel.

4.5.2. Test Data:

Test Mode1 / Polarization: Horizontal /CH: L



No.	Mk.	Freq. MHz	Reading Level (dBuV)	Correct Factor (dB/m)	Measurement (dBuV/m)	Limit (dBuV/m)	Over (dB)	Detector
1		77.4297	49.85	-20.81	29.04	40.00	-10.96	QP
2		216.0240	45.50	-17.29	28.21	46.00	-17.79	QP
3		232.2874	45.89	-16.51	29.38	46.00	-16.62	QP
4		402.1204	43.57	-10.89	32.68	46.00	-13.32	QP
5		569.8101	47.54	-8.41	39.13	46.00	-6.87	QP
6	*	922.4413	96.24	-4.02	92.22	46.00	46.22	QP

Note:
NO.6 is the fundamental frequency.

Test Mode1 / Polarization: Vertical / CH: L

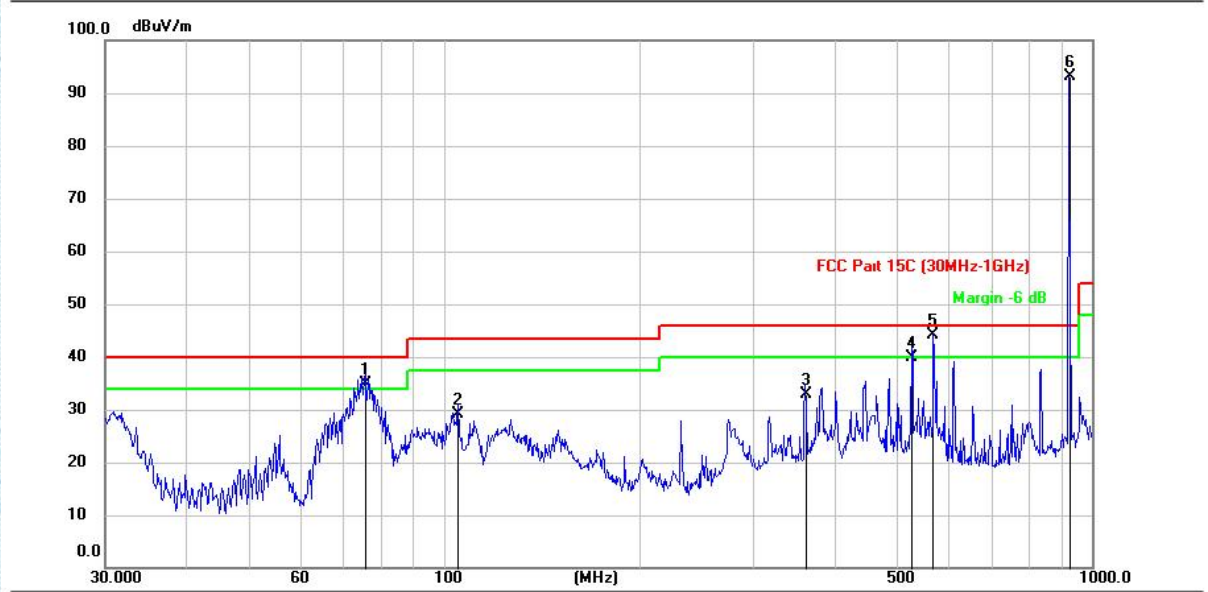

No.	Mk.	Freq. MHz	Reading Level (dBuV)	Correct Factor (dB/m)	Measurement (dBuV/m)	Limit (dBuV/m)	Over (dB)	Detector
1	!	75.7379	55.21	-20.38	34.83	40.00	-5.17	QP
2		105.2348	47.05	-18.03	29.02	43.50	-14.48	QP
3		360.1950	45.03	-12.21	32.82	46.00	-13.18	QP
4		527.6904	49.17	-9.36	39.81	46.00	-6.19	QP
5	!	570.0100	52.64	-8.41	44.23	46.00	-1.77	QP
6	*	922.4413	97.08	-4.02	93.06	46.00	47.06	QP

Note:
NO.6 is the fundamental frequency.

Test Mode1 / Polarization: Horizontal / CH: M



No.	Mk.	Freq. MHz	Reading Level (dBuV)	Correct Factor (dB/m)	Measurement (dBuV/m)	Limit (dBuV/m)	Over (dB)	Detector
1		76.6195	53.01	-20.61	32.40	40.00	-7.60	QP
2		150.0108	54.97	-21.40	33.57	43.50	-9.93	QP
3	!	216.8803	57.99	-17.24	40.75	46.00	-5.25	QP
4		360.0687	51.94	-12.21	39.73	46.00	-6.27	QP
5	!	569.9724	54.25	-8.41	45.84	46.00	-0.16	QP
6	*	925.6848	97.72	-3.99	93.73	46.00	47.73	QP

Note:
NO.6 is the fundamental frequency.

Test Mode1 / Polarization: Vertical / CH: M



No.	Mk.	Freq. MHz	Reading Level (dBuV)	Correct Factor (dB/m)	Measurement (dBuV/m)	Limit (dBuV/m)	Over (dB)	Detector
1		77.4297	49.85	-20.81	29.04	40.00	-10.96	QP
2		216.0240	45.50	-17.29	28.21	46.00	-17.79	QP
3		232.2874	45.89	-16.51	29.38	46.00	-16.62	QP
4		402.1204	43.57	-10.89	32.68	46.00	-13.32	QP
5		569.8101	47.54	-8.41	39.13	46.00	-6.87	QP
6	*	925.6847	97.71	-3.99	93.72	46.00	47.72	QP

Note:
NO.6 is the fundamental frequency.

Test Mode1 / Polarization: Horizontal / CH: H



No.	Mk.	Freq. MHz	Reading Level (dBuV)	Correct Factor (dB/m)	Measurement (dBuV/m)	Limit (dBuV/m)	Over (dB)	Detector
1	!	76.7279	56.51	-20.64	35.87	40.00	-4.13	QP
2		150.7390	58.48	-21.39	37.09	43.50	-6.41	QP
3	!	217.3110	57.99	-17.23	40.76	46.00	-5.24	QP
4		289.9569	54.13	-14.91	39.22	46.00	-6.78	QP
5	!	573.6685	50.67	-8.32	42.35	46.00	-3.65	QP
6	*	932.0747	95.72	-3.94	91.78	46.00	45.78	QP

Note:
NO.6 is the fundamental frequency.

Test Mode1 / Polarization: Vertical / CH: H



No.	Mk.	Freq. MHz	Reading Level (dBuV)	Correct Factor (dB/m)	Measurement (dBuV/m)	Limit (dBuV/m)	Over (dB)	Detector
1		77.4680	51.35	-20.82	30.53	40.00	-9.47	QP
2		153.7017	45.01	-21.31	23.70	43.50	-19.80	QP
3		232.6691	48.39	-16.48	31.91	46.00	-14.09	QP
4		403.9335	47.06	-10.87	36.19	46.00	-9.81	QP
5	!	571.9749	51.04	-8.36	42.68	46.00	-3.32	QP
6	*	928.8711	96.21	-3.97	92.24	46.00	46.24	QP

Note:
NO.6 is the fundamental frequency.

4.6. Radiated Emission (above 1GHz)

Test Requirement:	47 CFR 15.249(a) 47 CFR 15.249(d) 47 CFR 15.249(e)																																							
Test Limit:	<p>Except as provided in paragraph (b) of this section, the field strength of emissions from intentional radiators operated within these frequency bands shall comply with the following:</p> <table border="1" data-bbox="491 566 1433 797"> <thead> <tr> <th>Fundamental frequency</th> <th>Field strength of fundamental (millivolts/meter)</th> <th>Field strength of harmonics (microvolts/meter)</th> </tr> </thead> <tbody> <tr> <td>902-928 MHz</td> <td>50</td> <td>500</td> </tr> <tr> <td>2400-2483.5 MHz</td> <td>50</td> <td>500</td> </tr> <tr> <td>5725-5875 MHz</td> <td>50</td> <td>500</td> </tr> <tr> <td>24.0-24.25 GHz</td> <td>250</td> <td>2500</td> </tr> </tbody> </table> <p>Emissions radiated outside of the specified frequency bands, except for harmonics, shall be attenuated by at least 50 dB below the level of the fundamental or to the general radiated emission limits in § 15.209, whichever is the lesser attenuation.</p> <table border="1" data-bbox="491 1016 1433 1346"> <thead> <tr> <th>Frequency (MHz)</th> <th>Field strength (microvolts/meter)</th> <th>Measurement distance (meters)</th> </tr> </thead> <tbody> <tr> <td>0.009-0.490</td> <td>2400/F(kHz)</td> <td>300</td> </tr> <tr> <td>0.490-1.705</td> <td>24000/F(kHz)</td> <td>30</td> </tr> <tr> <td>1.705-30.0</td> <td>30</td> <td>30</td> </tr> <tr> <td>30-88</td> <td>100 **</td> <td>3</td> </tr> <tr> <td>88-216</td> <td>150 **</td> <td>3</td> </tr> <tr> <td>216-960</td> <td>200 **</td> <td>3</td> </tr> <tr> <td>Above 960</td> <td>500</td> <td>3</td> </tr> </tbody> </table> <p>** Except as provided in paragraph (g), fundamental emissions from intentional radiators operating under this section shall not be located in the frequency bands 54-72 MHz, 76-88 MHz, 174-216 MHz or 470-806 MHz. However, operation within these frequency bands is permitted under other sections of this part, e.g., §§ 15.231 and 15.241.</p> <p>As shown in § 15.35(b), for frequencies above 1000 MHz, the field strength limits in paragraphs (a) and (b) of this section are based on average limits. However, the peak field strength of any emission shall not exceed the maximum permitted average limits specified above by more than 20 dB under any condition of modulation. For point-to-point operation under paragraph (b) of this section, the peak field strength shall not exceed 2500 millivolts/meter at 3 meters along the antenna azimuth.</p>	Fundamental frequency	Field strength of fundamental (millivolts/meter)	Field strength of harmonics (microvolts/meter)	902-928 MHz	50	500	2400-2483.5 MHz	50	500	5725-5875 MHz	50	500	24.0-24.25 GHz	250	2500	Frequency (MHz)	Field strength (microvolts/meter)	Measurement distance (meters)	0.009-0.490	2400/F(kHz)	300	0.490-1.705	24000/F(kHz)	30	1.705-30.0	30	30	30-88	100 **	3	88-216	150 **	3	216-960	200 **	3	Above 960	500	3
Fundamental frequency	Field strength of fundamental (millivolts/meter)	Field strength of harmonics (microvolts/meter)																																						
902-928 MHz	50	500																																						
2400-2483.5 MHz	50	500																																						
5725-5875 MHz	50	500																																						
24.0-24.25 GHz	250	2500																																						
Frequency (MHz)	Field strength (microvolts/meter)	Measurement distance (meters)																																						
0.009-0.490	2400/F(kHz)	300																																						
0.490-1.705	24000/F(kHz)	30																																						
1.705-30.0	30	30																																						
30-88	100 **	3																																						
88-216	150 **	3																																						
216-960	200 **	3																																						
Above 960	500	3																																						
Test Method:	Radiated emissions tests																																							
Procedure:	ANSI C63.10-2013 section 6.6.4																																							

4.6.1. E.U.T. Operation:

Operating Environment:	
Temperature:	25.1 °C
Humidity:	49.5 %
Atmospheric Pressure:	101 kPa
Final test mode:	Test Mode1

4.6.2. Test Data:

Test Mode1 / Polarization: Horizontal / CH: L

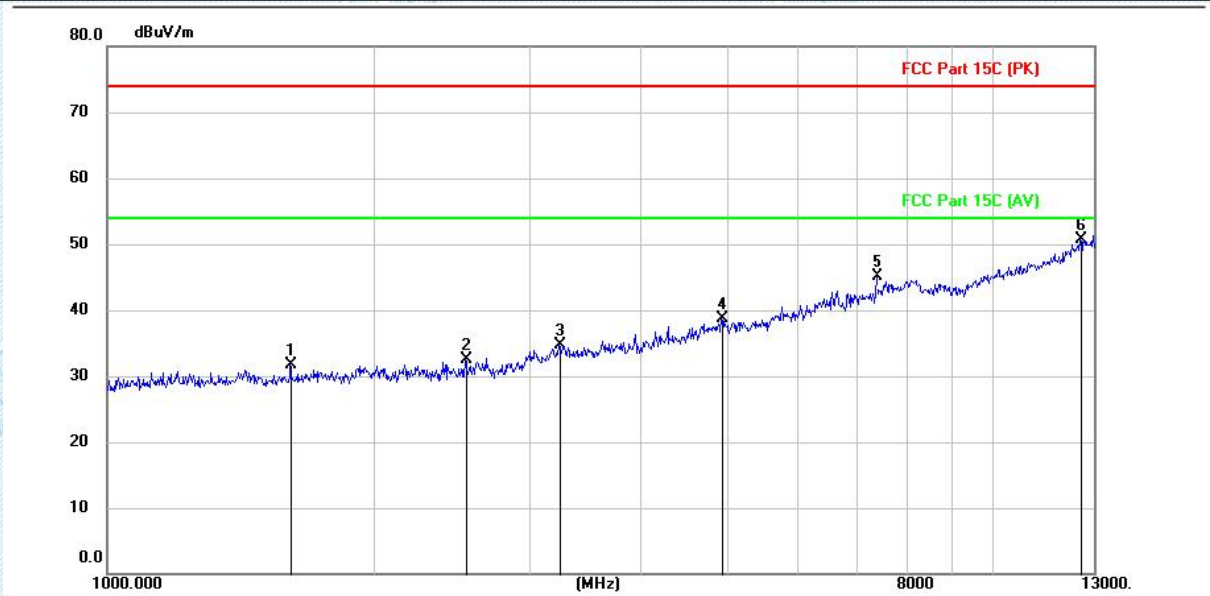

No. Mk.	Freq. MHz	Reading Level (dBuV)	Correct Factor (dB/m)	Measurement (dBuV/m)	Limit (dBuV/m)	Over (dB)	Detector
1	1610.800	43.21	-11.58	31.63	74.00	-42.37	peak
2	2538.400	43.32	-10.86	32.46	74.00	-41.54	peak
3	3242.800	44.76	-10.15	34.61	74.00	-39.39	peak
4	4940.800	44.28	-5.55	38.73	74.00	-35.27	peak
5	7392.400	44.68	0.49	45.17	74.00	-28.83	peak
6 *	12542.800	41.72	9.05	50.77	74.00	-23.23	peak

Test Mode1 / Polarization: Vertical / CH: L

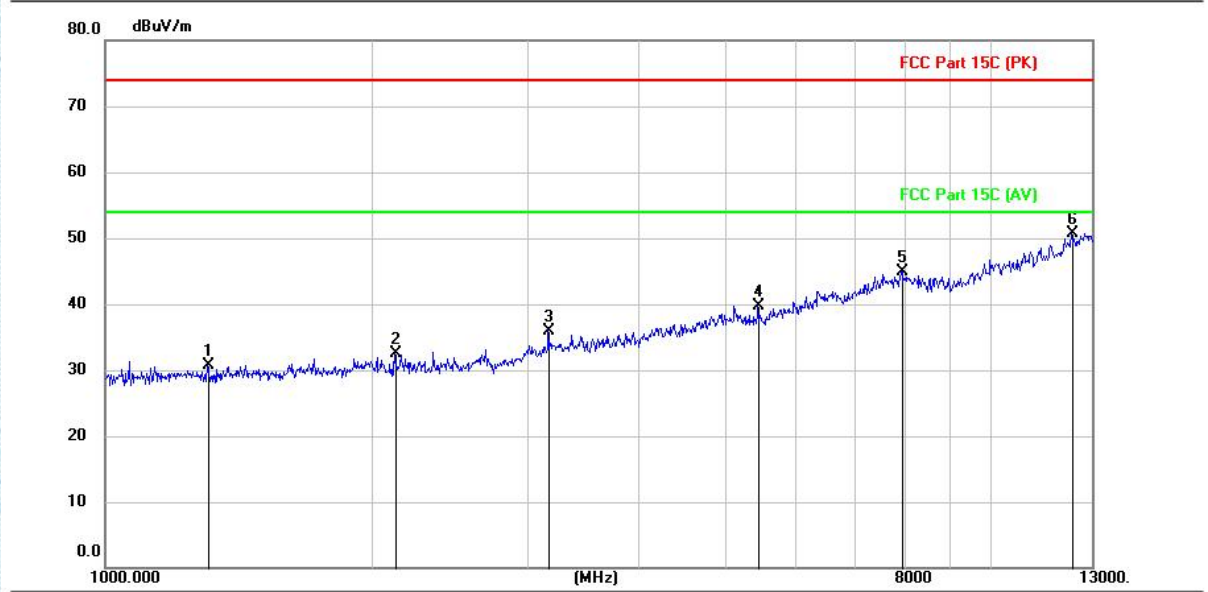

No. Mk.	Freq. MHz	Reading Level (dBuV)	Correct Factor (dB/m)	Measurement (dBuV/m)	Limit (dBuV/m)	Over (dB)	Detector
1	1302.400	42.72	-11.97	30.75	74.00	-43.25	peak
2	2126.800	43.57	-11.01	32.56	74.00	-41.44	peak
3	3164.800	46.21	-10.29	35.92	74.00	-38.08	peak
4	5455.600	44.65	-4.96	39.69	74.00	-34.31	peak
5	7946.800	43.07	1.93	45.00	74.00	-29.00	peak
6 *	12346.000	42.05	8.63	50.68	74.00	-23.32	peak

Test Mode1 / Polarization: Horizontal / CH: M

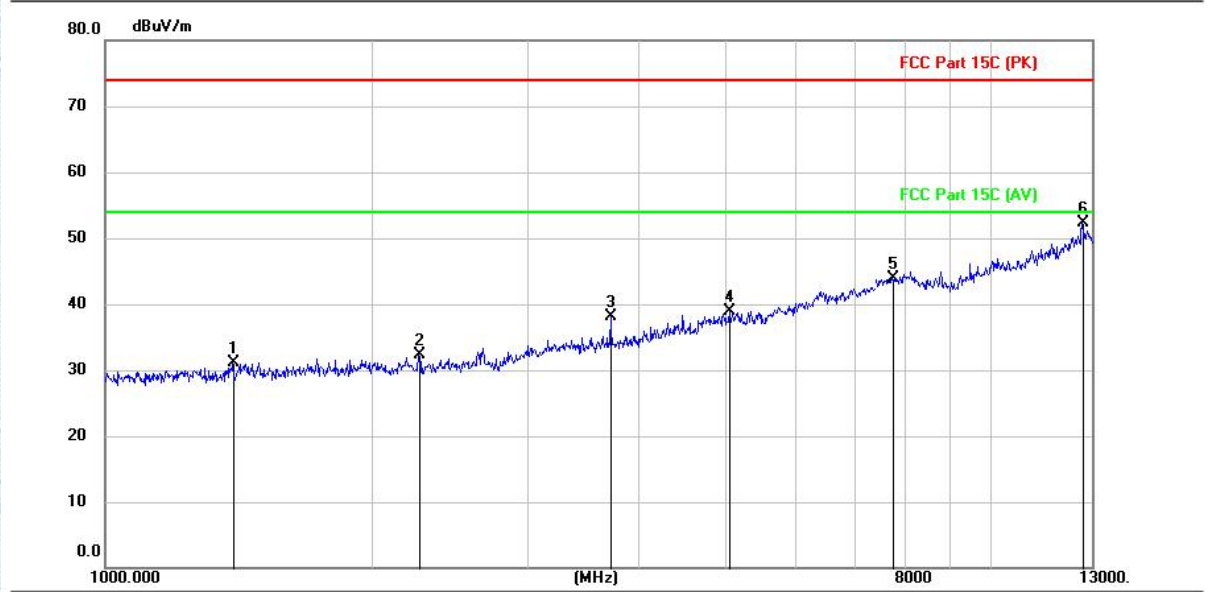

No. Mk.	Freq. MHz	Reading Level (dBuV)	Correct Factor (dB/m)	Measurement (dBuV/m)	Limit (dBuV/m)	Over (dB)	Detector
1	1393.600	43.01	-11.91	31.10	74.00	-42.90	peak
2	2266.000	43.22	-10.97	32.25	74.00	-41.75	peak
3	3720.400	47.30	-9.13	38.17	74.00	-35.83	peak
4	5058.400	44.18	-5.34	38.84	74.00	-35.16	peak
5	7757.200	42.53	1.46	43.99	74.00	-30.01	peak
6 *	12696.400	43.05	9.35	52.40	74.00	-21.60	peak

TRF EMC_R1

Add: West Side of 1/F., Building C, Zone A, Fuyuan New Factory, Jiujiu Industrial Park, Minzhu, Shatou, Shajing, Bao'an District, Shenzhen, Guangdong, China

Tel: +(86) 0755-2985 2678 Fax: +(86) 0755-2985 2397 E-mail: info@gdkesign.cn Web: www.gdkesign.com

Test Mode1 / Polarization: Vertical / CH: M

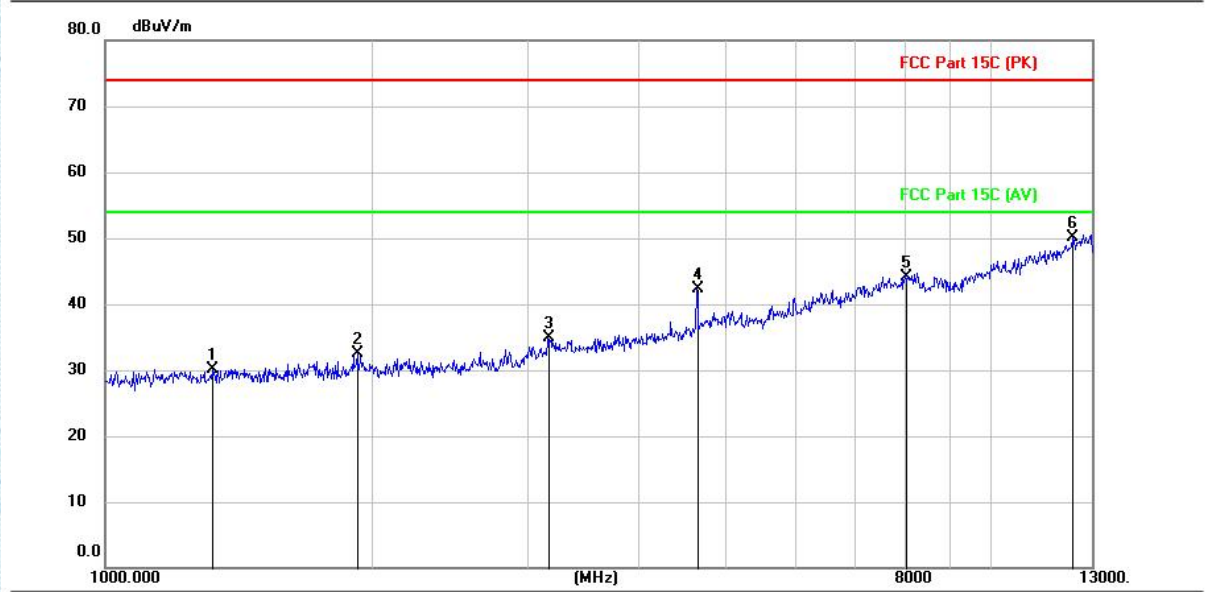

No. Mk.	Freq. MHz	Reading Level (dBuV)	Correct Factor (dB/m)	Measurement (dBuV/m)	Limit (dBuV/m)	Over (dB)	Detector
1	1319.200	42.15	-11.96	30.19	74.00	-43.81	peak
2	1931.200	43.66	-11.12	32.54	74.00	-41.46	peak
3	3168.400	45.12	-10.29	34.83	74.00	-39.17	peak
4	4650.400	48.69	-6.35	42.34	74.00	-31.66	peak
5	8020.000	42.14	2.06	44.20	74.00	-29.80	peak
6 *	12361.600	41.51	8.66	50.17	74.00	-23.83	peak

Test Mode1 / Polarization: Horizontal / CH: H

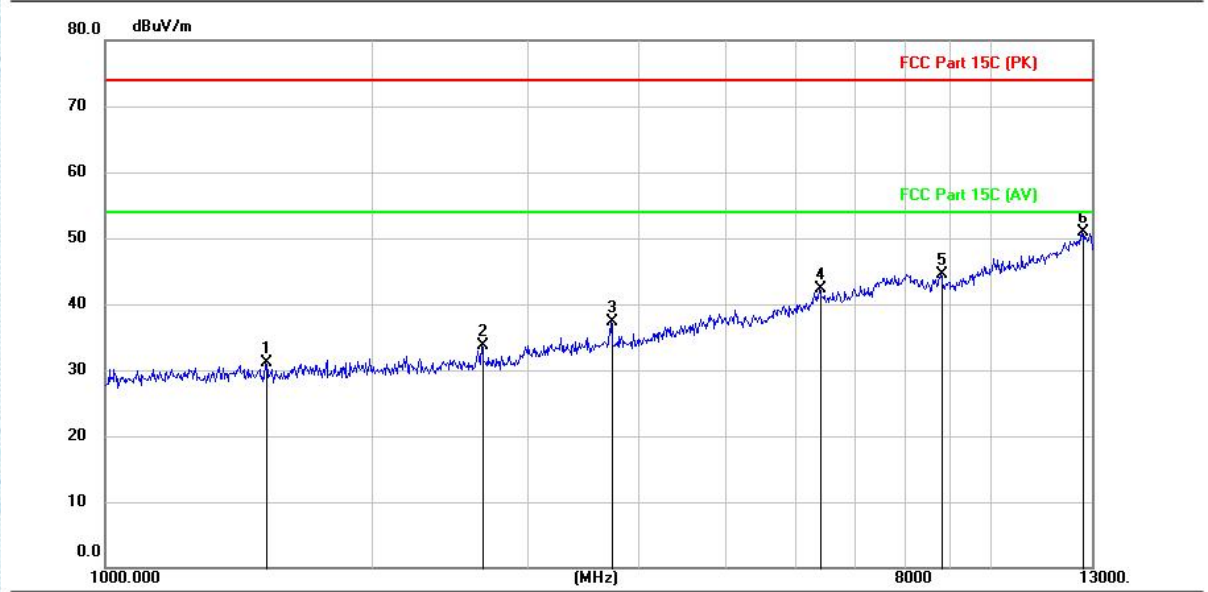

No. Mk.	Freq. MHz	Reading Level (dBuV)	Correct Factor (dB/m)	Measurement (dBuV/m)	Limit (dBuV/m)	Over (dB)	Detector
1	1516.000	42.87	-11.74	31.13	74.00	-42.87	peak
2	2666.800	44.54	-10.78	33.76	74.00	-40.24	peak
3	3732.400	46.34	-9.09	37.25	74.00	-36.75	peak
4	6398.800	44.78	-2.45	42.33	74.00	-31.67	peak
5	8790.400	42.69	1.86	44.55	74.00	-29.45	peak
6 *	12686.800	41.57	9.33	50.90	74.00	-23.10	peak

Test Mode1 / Polarization: Vertical / CH: H

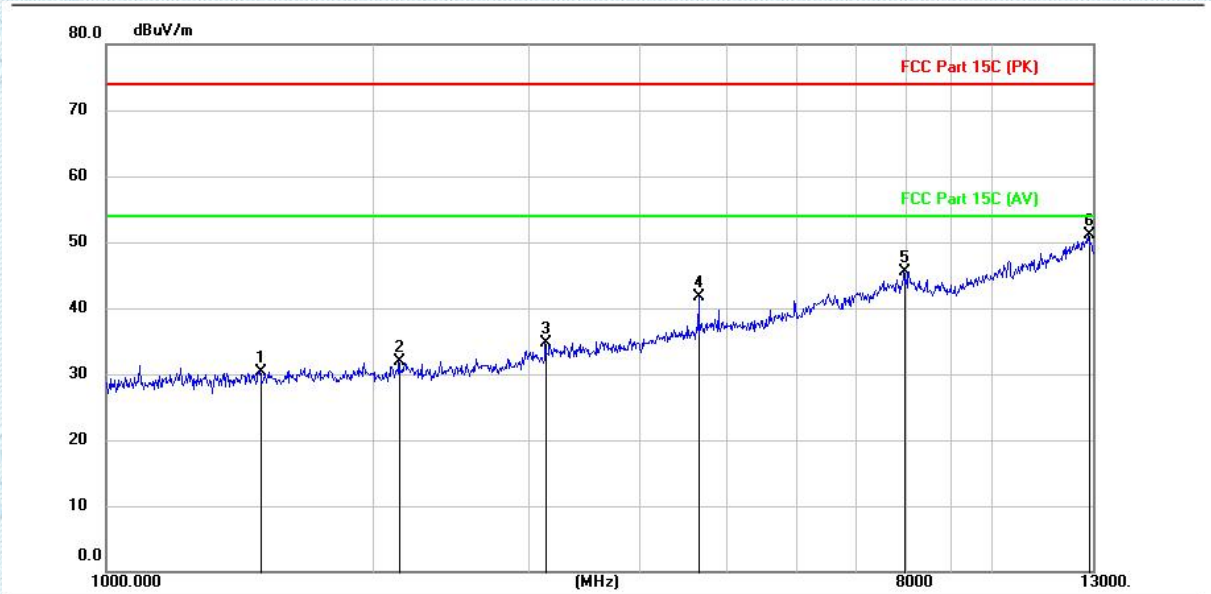

No.	Mk.	Freq. MHz	Reading Level (dBuV)	Correct Factor (dB/m)	Measurement (dBuV/m)	Limit (dBuV/m)	Over (dB)	Detector
1		1489.600	42.16	-11.78	30.38	74.00	-43.62	peak
2		2147.200	42.89	-11.00	31.89	74.00	-42.11	peak
3		3136.000	45.11	-10.34	34.77	74.00	-39.23	peak
4		4660.000	47.99	-6.32	41.67	74.00	-32.33	peak
5		7980.400	43.55	2.02	45.57	74.00	-28.43	peak
6	*	12862.000	41.46	9.66	51.12	74.00	-22.88	peak

Note:

- 1.From 13GHz to 26.5GHz,the amplitude of spurious emissions which are attenuated by more than 20dB below the permissible value has no need to be reported.
- 2.Since the peak value is less than the limit of the AVG value, there is no AVG data.

5. EUT TEST PHOTOS

Conducted Emission at AC power line



Emissions in restricted frequency bands (below 1GHz)



Emissions in restricted frequency bands (above 1GHz)

TRF EMC_R1

Add: West Side of 1/F., Building C, Zone A, Fuyuan New Factory, Jiujiu Industrial Park, Minzhu, Shatou, Shajing, Bao'an District, Shenzhen, Guangdong, China

Tel: +(86) 0755-2985 2678 Fax: +(86) 0755-2985 2397 E-mail: info@gdkesign.cn Web: www.gdkesign.com

6. PHOTOGRAPHS OF EUT CONSTRUCTIONAL

Refer to Appendix - Photographs of EUT Constructional Details for KD2208S3798E.

--THE END--