



SPECIFICATION

Shenzhen DreamLNK Technology Co., Ltd.
深圳市骏晔科技有限公司

915MHZ Spring Coil Antenna

Product Specification

Client Name		Frequency Band	915 MHz
Wire Name		Version	A1
Customer's Part Number		DreamLNK's Part Number	T1-05
RF Designer	Jason Wang	RF Manager	Knight Ai
Structural Designer		Structural Design Manager	
Technical Director		Date	2022-11-28

Client confirmation:

Whether the product meets your requirements? OK NG

Contents

Cover	1
Contents	2
1. Photos	3
2. Parameters	3
3. S11 Data	4
4. Structure	6
5. Application & Design Guidance.....	7
6. Environmental reliability experiment report	8
7. Contact us	8

The information provided by us should be kept strictly confidential, and it is not allowed to disclose to anyone else or other companies, without prior written consent

1. Photos

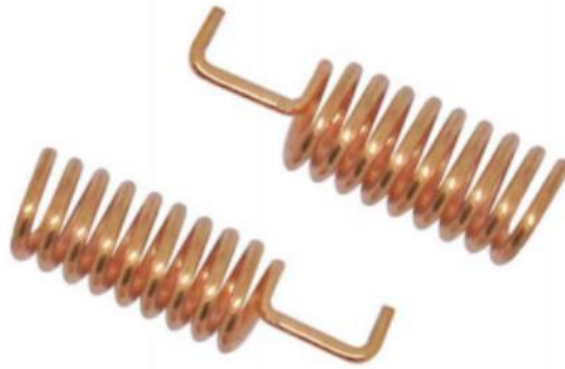

2. Parameters

Test parameters			
Product Name	915Mhz Spring Antenna	Model No	T1-05
Electrical Specifications			
Frequency Range	915MHz	Polarization	Vertical
Input Impedance	50 Ω	Radiation direction	Omnidirectional
VSWR	≤ 1.5	Power Capacity	50W
Gain	3.0 dBi	Bandwidth	/
Mechanical Specifications			
Dimensions	D5.5*17.5MM	Color	Gold
Installation	Welding on PCB	Antenna Material	Phosphor bronze
Relative Humidity	40~85%	Storage Temperature	-30°C~+65°C
Working Temperature	-40°C~+85°C		

The information provided by us should be kept strictly confidential, and it is not allowed to disclose to anyone else or other companies, without prior written consent

3. S11 DATA (VSWR, Return loss, Smith)

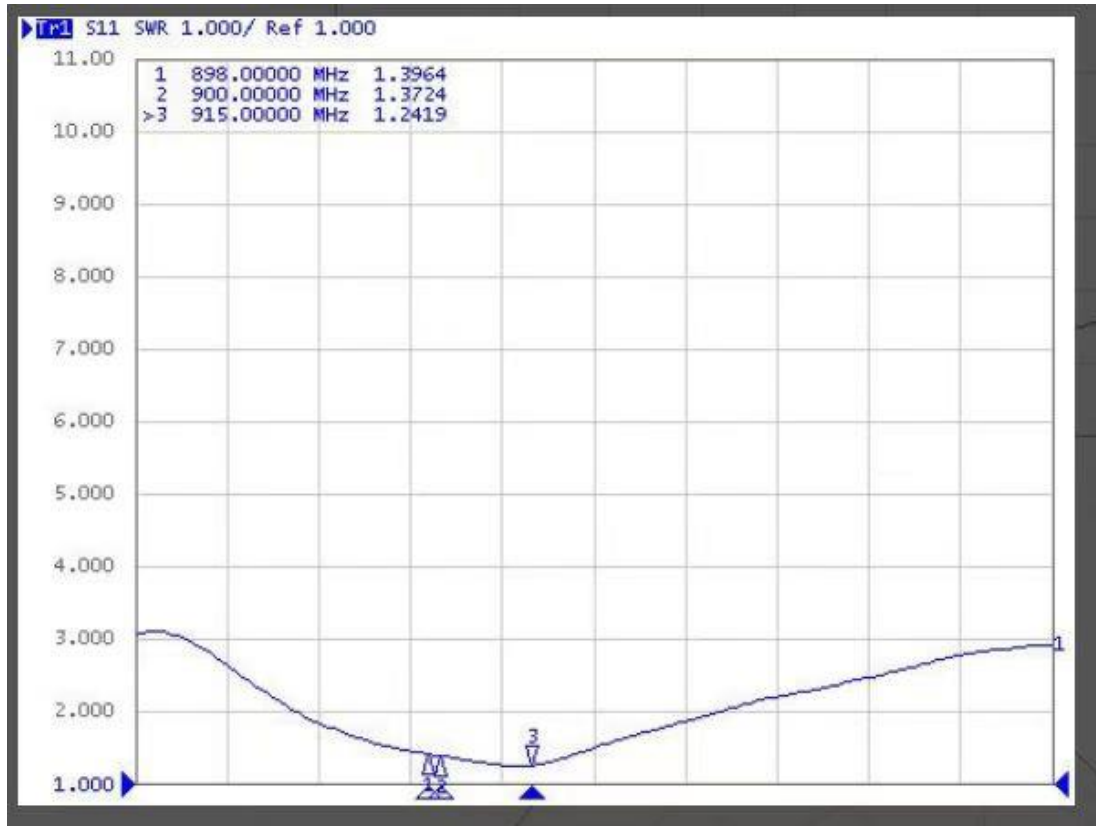

Passive Test For 915												
Freq (MHz)	Effi (%)	Effi (dB)	Gain (dBi)	Gain (dBd)	UHS (%)	DHS (%)	Max (dB)	Min (dB)	Directivity (dBi)	Beamwidth (3dB)	AttH (dB)	AttV (dB)
910	55.26	-2.45	2.72	0.52	10.946	45.562	2.72	-17.89	3.81	30	40.53	40.65
915	64.85	-1.88	3	0.85	13.107	51.746	3	-16.52	3.83	30	40.53	40.65
920	54.78	-2.61	2.65	0.5	10.886	43.895	2.65	-18.37	3.76	30	40.3	40.57

910.00MHz - 920.00MHz Gain

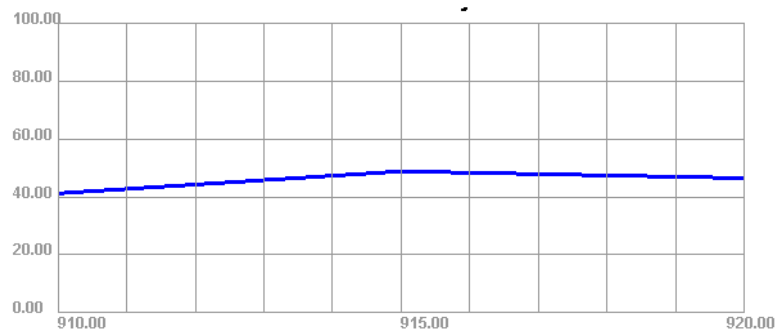
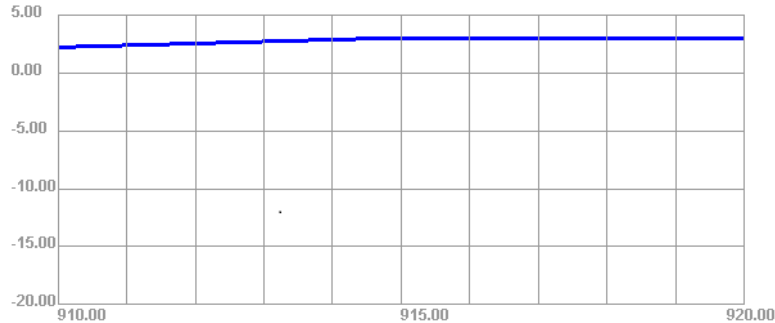

Application Information	
04Version	5.247.353
TotalTime	4m 44s 232ms
AdditionalInfor	NULL

The information provided by us should be kept strictly confidential, and it is not allowed to disclose to anyone else or other companies, without prior written consent

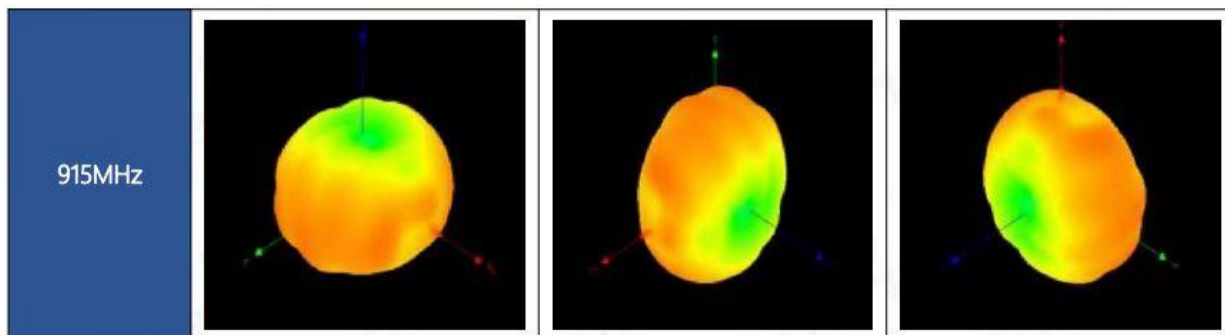
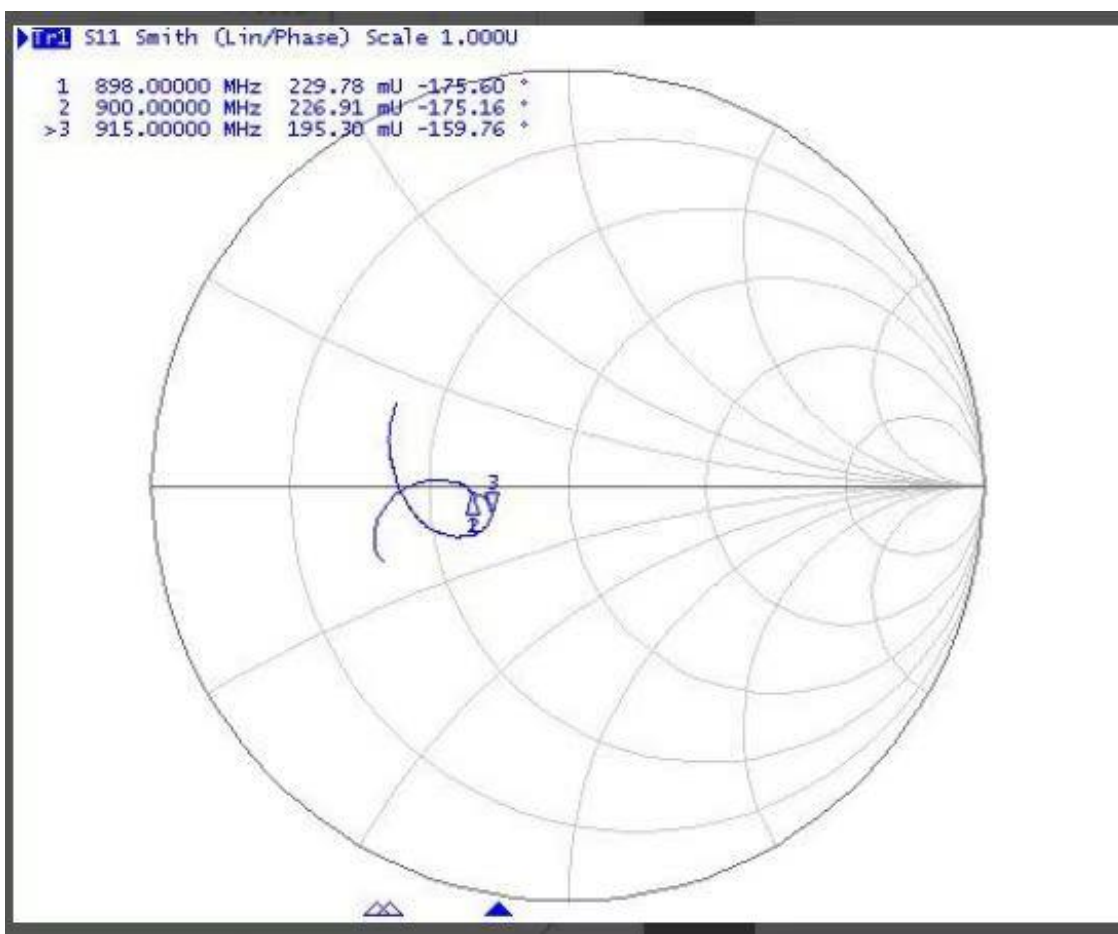

The information provided by us should be kept strictly confidential, and it is not allowed to disclose to anyone else or other companies, without prior written consent

4. Structure Diagram

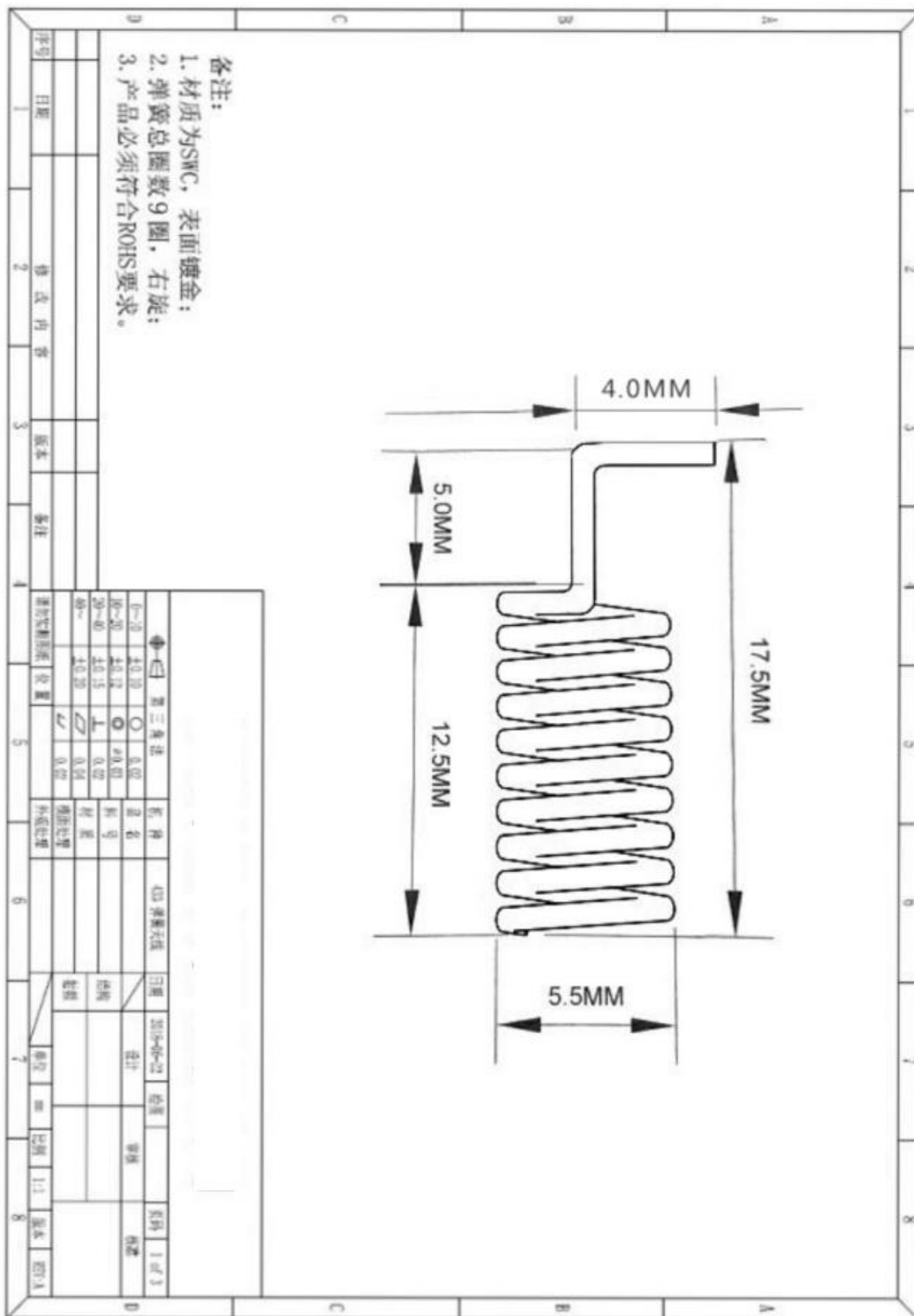

5. Application & Design Guidance

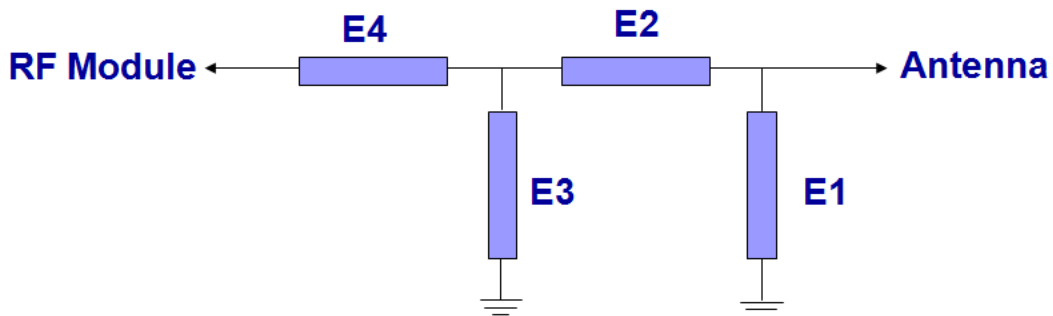
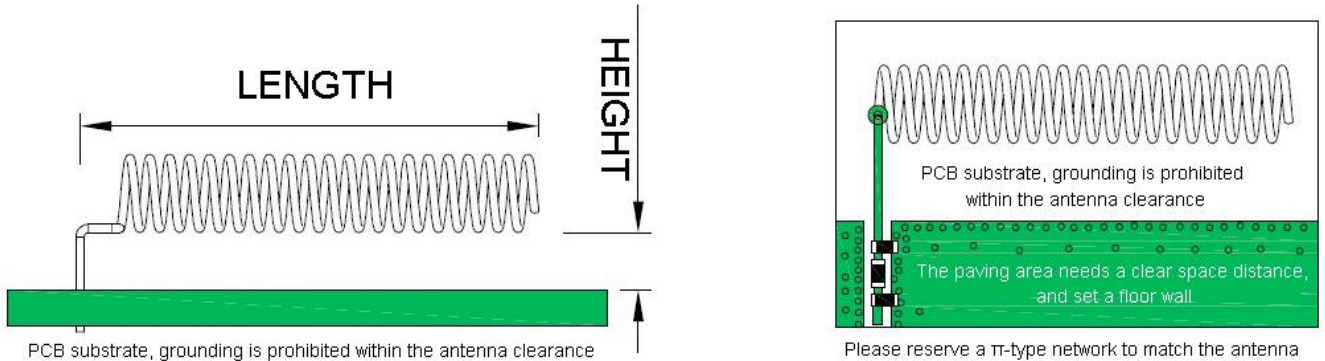

Note: The antenna design process needs to combine the product shape and structure, the position of the RF module signal input and output interface, and the position of the interference source inside the product to determine the position, angle, distance from the floor, and height from the PCB substrate.

Please reserve a π -type network to match the antenna. When debugging the antenna, be sure to provide a complete product shell and internal PCBA function board, calculate the external interference source and parasitic capacitance into the matching, so that the antenna can achieve the best performance indicators and work efficiency.

The PCB trace of the matching network refers to the 0.5mm line width, and the grounding on both sides of the network refers to the 0.35mm spacing to maintain good impedance characteristics.

If you have any questions, please send PCB documents to this e-mail support@dreamlnk.com

6. Environmental reliability experiment report

Item	Test condition	Specification
Storage environment	Tested temperature, humidity and air pressure as following without specifying: 1. The temperature is -30 °C ~ + 80 °C 2. Relative humidity is 45% -85% 3. The air pressure is 86kpa-106kpa	The electrical mechanical performance is normal
High and low temperature test	Perform 5 cycles between 70 °C and 40 °C, then check the appearance quality, under normal conditions 1-2H	The size should meet the requirements for mechanical and electrical performance
Resistant to constant heat and humidity	Test Relative humidity: 95 ± 3%, Test temperature: 40 °C. After continuous 2H running, take out the sample, and measure its electrical properties within 5 minutes, put the sample in a normal condition for another 1-2H, check the appearance quality	The size should meet the standard, and meet for mechanical and electrical performance
Vibration test	Vibration frequency range 10-55HZ, displacement amplitude: 0.35MM, acceleration amplitude: 50.0M / S, frequency of sweeping cycle: 30 times	Normal electrical and mechanical performance
Drop test	1M high-altitude free fall 3 times, in the direction of mutually perpendicular axes	Normal electrical and mechanical performance

7. Contact us

Shenzhen DreamLnk Technology Co., Ltd

★ Data collection, Smart home, Internet of Things applications, Wireless remote control technology, Remote active RFID, Antennas ★

Office Add.: Room 603, Unit C, Zone A, Huameiju Business Center, Xinhua Rd., Bao'an District, Shenzhen, Guangdong Province, China

Factory Add.: Huazhi Innovation Valley, No. 7 Yuhua Street, 138 Industrial Zone, Tangxia Town, Dongguan, Guangdong Province, China

TEL.: +86-755-29369047

FAX: +86-755-27844601

E-mail: sales@dreamlnk.com

Web: www.iot-rf.com