

# WayGoal

## Projector Instruction



Please read this manual carefully before use and keep it for future use.

# Table of Contents

English -----	3-21
Deutsch -----	22-41
Italiano -----	42-61
Français -----	62-81
Español -----	82-101

# Table of Contents (English )

Important Safety Considerations -----	4
Nams and Functions of Projector Parts -----	6
• Equipment Connection -----	7
• Get To Know The Remote Control -----	8
Installation and Adjustment -----	9
System Setting -----	11
• Bluetooth Function -----	12
Wireless Mirroring WiFi / DLNA Connection Function -----	12
• Screen Mirroring Connection With Projector -----	12
• Screen Mirroring Connection With Same WiFi -----	14
• DLNA Connection -----	16
How to Clean -----	19
Q&A -----	20
Specification -----	21

# Important Safety Considerations

Thank you for your purchasing.

Please read through this user manual before use.

Please keep the manual properly for reference after reading.

1. Please don't put the projector in the place where the cold/warm air of the air conditioner blows directly. Condensation of water or high temperature will lead to product damage.
2. Please make sure don't gather things around the projector and the vent is not blocked to avoid overheating.
3. Please prevent foreign objects such as nails or paper scraps from falling into the machine. Never insert any metal objects such as iron wires or screwdrivers into the machine. If a foreign object falls into the machine accidentally, please turn off the power immediately and try to remove the foreign object;
4. Please don't let any liquid into the machine to avoid leakage.
5. Please use soft packing material when you move the projector. To protect the lens from scratch, please use the lens protection cover. Please don't subject the projector to strong vibrations.
6. Please be aware that the vent will be heat after projection. Please don't touch it or it might burned your skin.
7. Please don't look at the lens/lamps directly after the projector is on, it might hurt your eyes.

**Attention**



Please don't open the machine by yourself to avoid leakage. If there is anything wrong, please contact customer service for help.

**Attention**



Please don't put the machine into rain or moist environment to avoid fire or leakage

# Important Safety Considerations

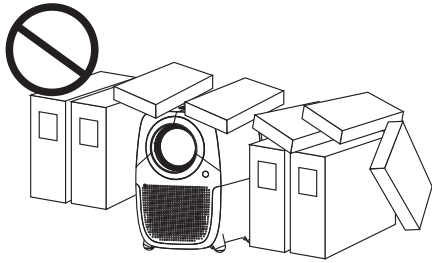

Please don't pile things around the machine.

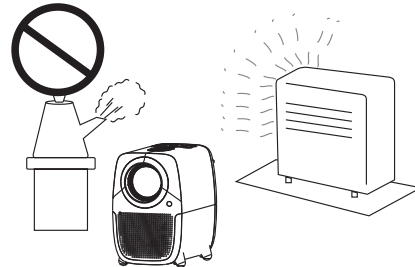

Please don't put it in hot or humid places.

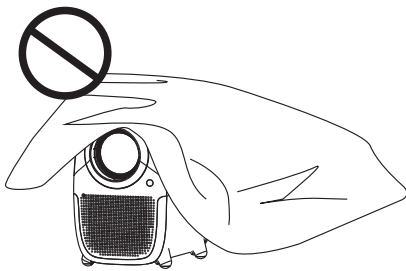

Please don't block the ventilation holes (intake or exhaust)

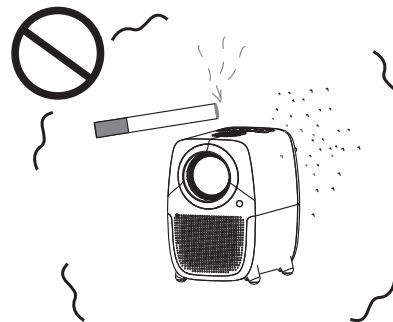

Please don't put it in dusty and smoky places.

# Names and Functions of Projector Parts

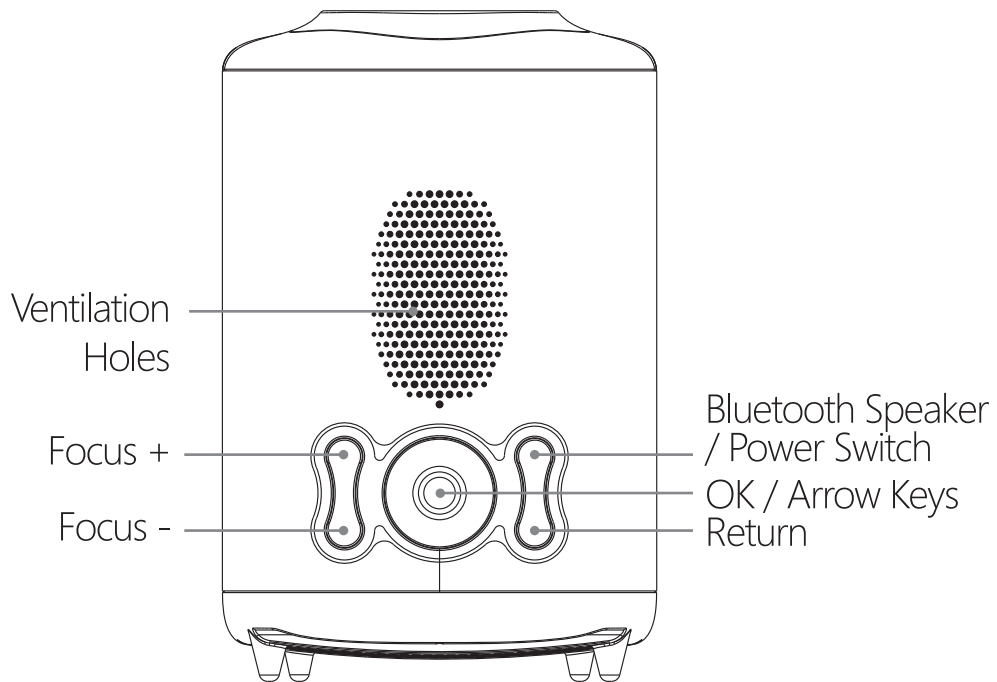
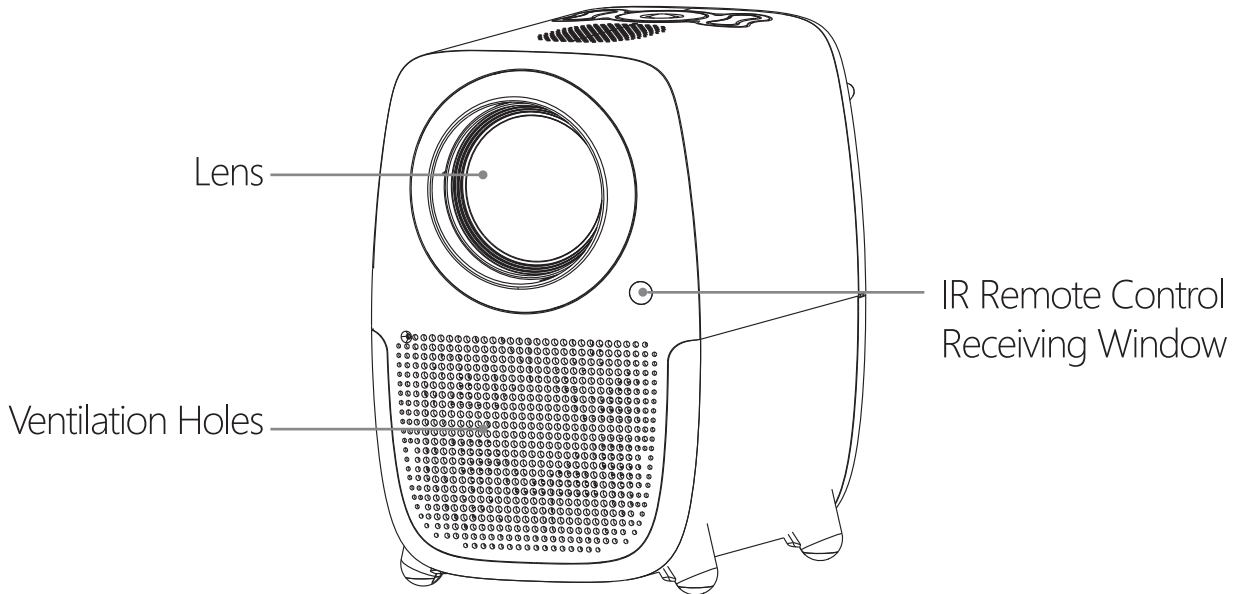

# Names and Functions of Projector Parts

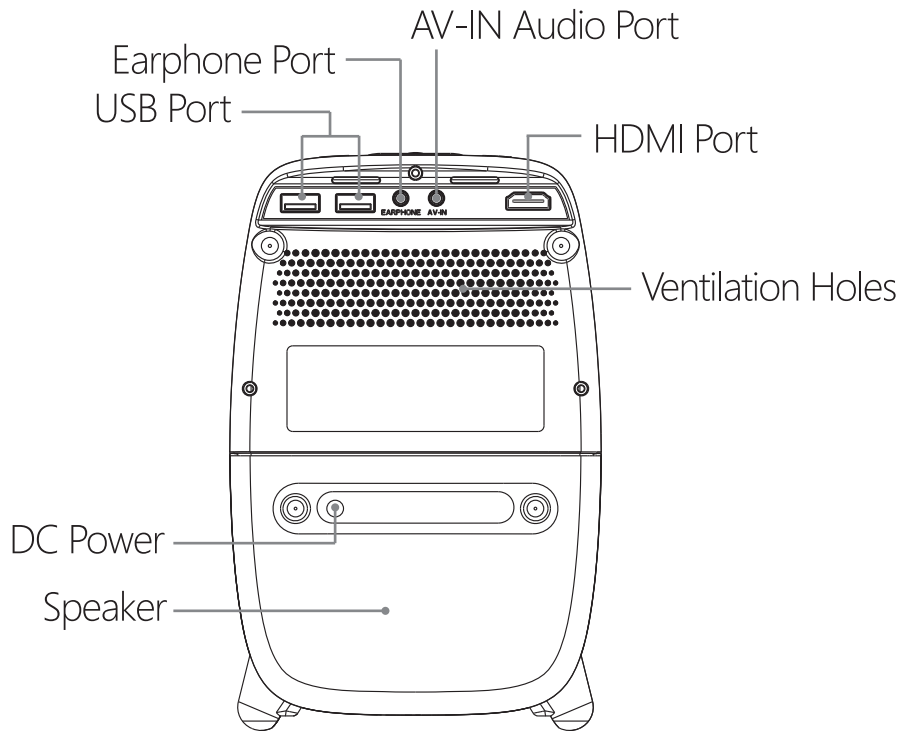

## Equipment Connection

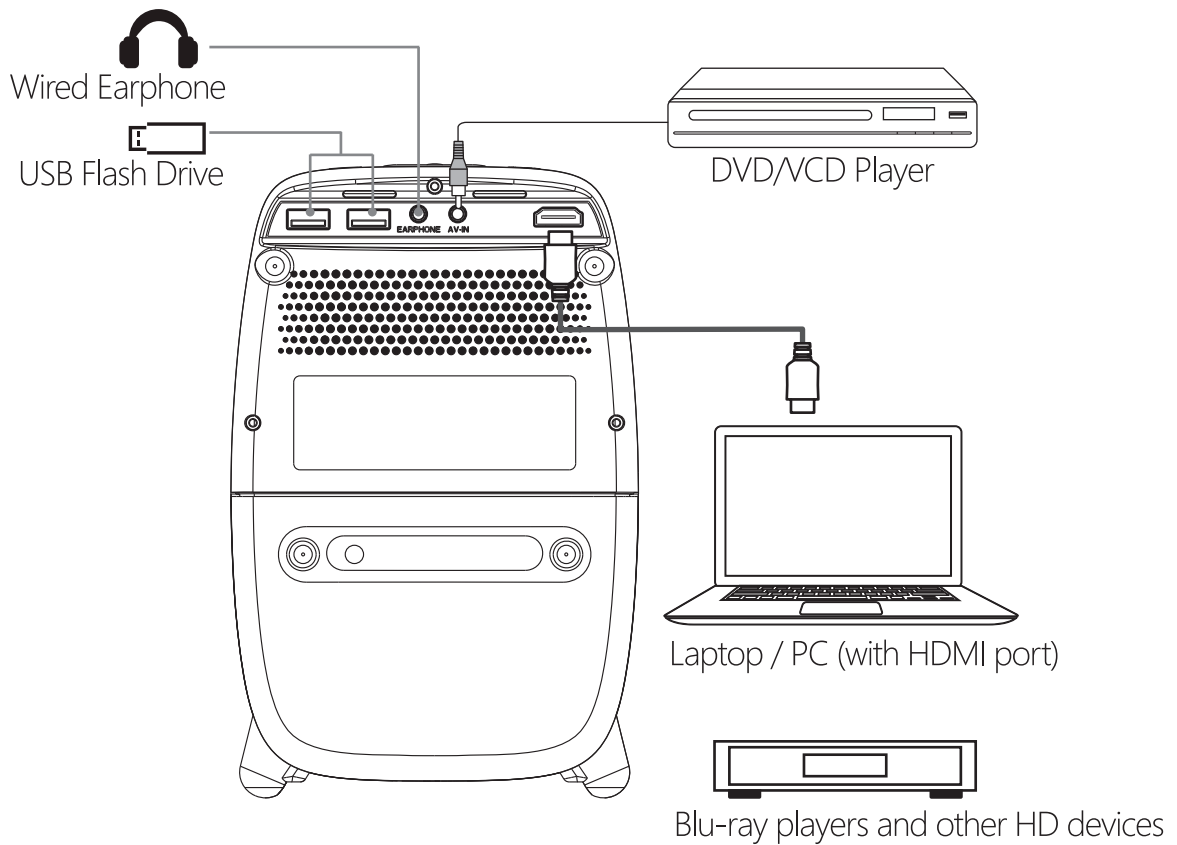

## Get To Know The Remote Control

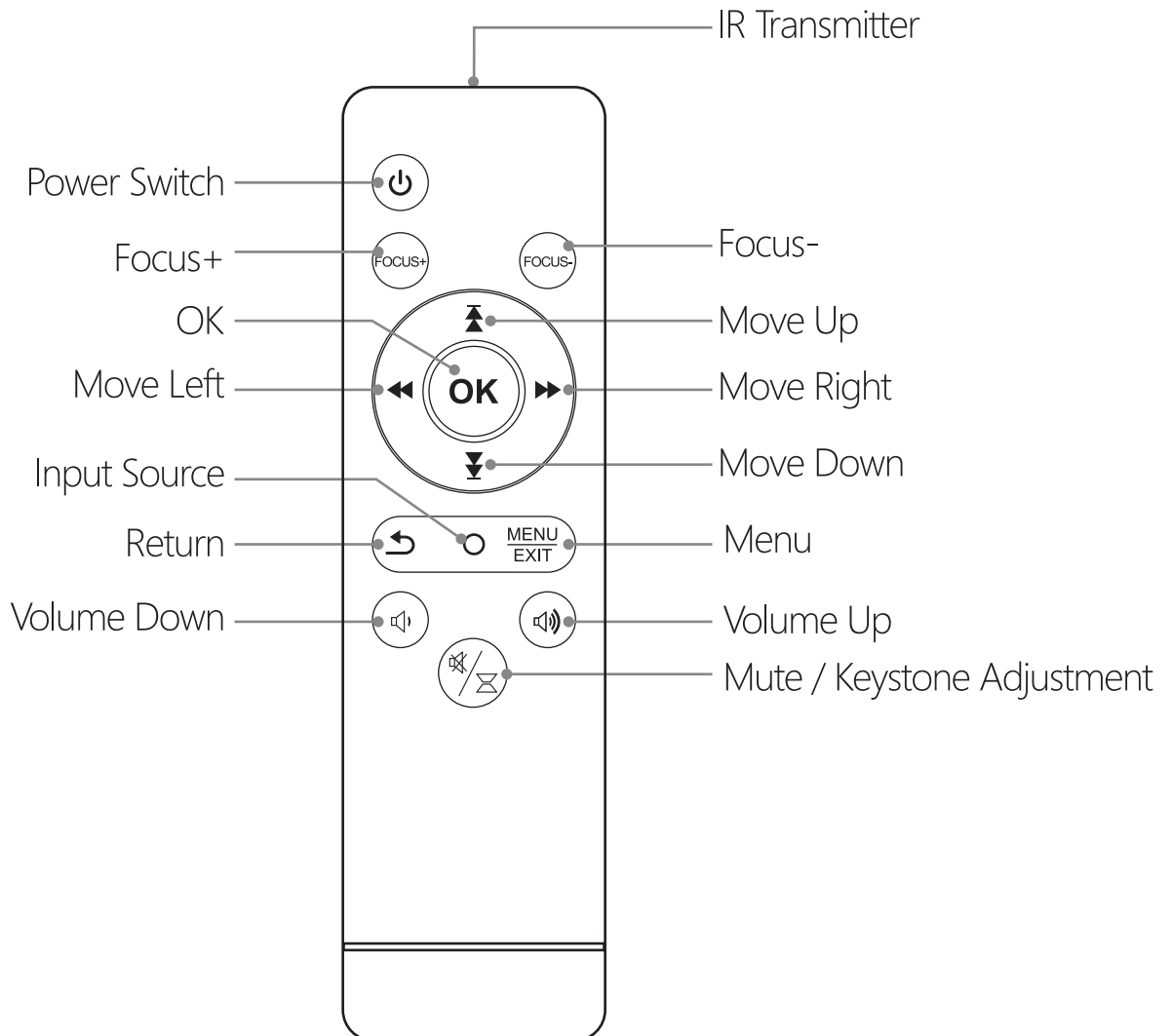

### Attentions:

- \* Please use AAA battery
- \* Please don't drop or tread on it, or splash any kind of liquid into it.
- \* Please don't place it near a heat source or in a place exposed to direct sunlight or in a damp room.



# Installment and Adjustment

## 1. Setup

Place the projector horizontally or make it face the ceiling. Keep it in charge. Press the power switch button on the remote control or top of the projector.

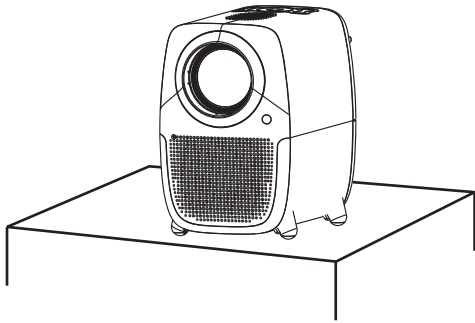

Flat surface

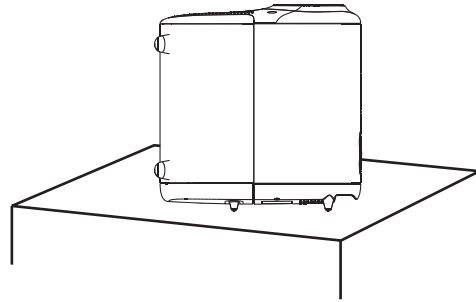

## 2. Adjust Focus and Keystone

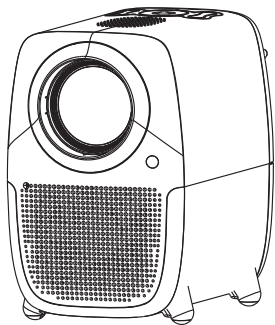

Remote Control

### Distortion Image Example

Keystone Distortion



Blurred Image



### How to Adjust Keystone

Press 'Mute/Keystone Adjustment' button on the remote > Use Up/Down arrow key to adjust image > Press 'Mute/Keystone Adjustment' button again to bring back sound.

\* After press the mute button, it is normal that the sounds disappear.

### How to Adjust Focus

Press Focus± button on the top of the projector or the remote control to adjust focus.

### 3. Project Distance

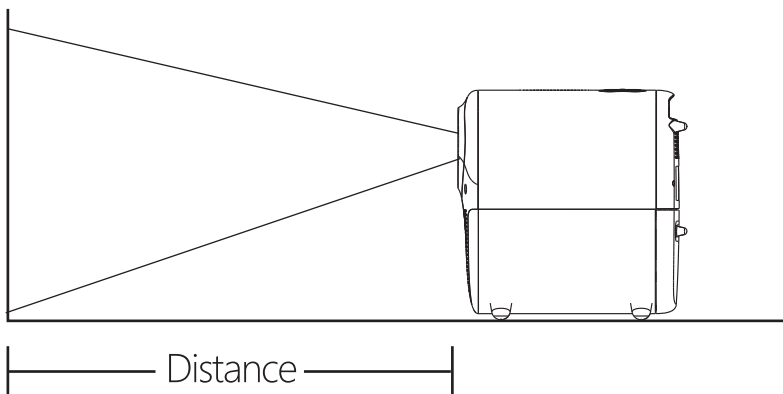

Screen Size (inch)	Project Distance (meter)
30 inch	1 m
60 inch	2 m
90 inch	3 m
120 inch	4 m
150 inch	5 m
200 inch	6 m
250 inch	8 m

\*The measurement data may have deviation, please take the actual as the standard.

### 4. Turn Off After Use

Press the power switch button on the remote control or top of the projector. Turn off the device according to the system prompt.

\*Please store the device in a dry and cool place after use.

## System Setting

Press Menu button on the remote or choose setting on the main menu to access system setting page.

Use arrow keys to choose and press OK button to access.

There are many pages inside of system setting. Please use arrow keys to choose the one you need: 'PICTURE' - 'SOUND' - 'OPTION'

### Image and Display Setting

Image page: Use arrow keys to choose Picture Mode, Color Temperature, Aspect Ratio, Keystone etc.

#### \* Picture Mode

Press OK button to access Image Mode > Press arrow keys to choose different display modes > Adjust brightness, contrast, color saturation according to your needs

#### \* Color Temperature

Choose warm colors, cool colors, standard colors as you like. Adjust red, green, blue color if you want.

#### \* Aspect Ratio

Choose from 4:3, 16:9 and auto adjustment.

#### \* Keystone Setting

Press 'Mute/Keystone Adjustment' button on the remote > Use Up/Down arrow key to adjust image > Press 'Mute/Keystone Adjustment' button again to bring back sound.

\* After press the mute button, it is normal that the sounds disappear.

### Sound Setting

It has many sound effects like: Standard, User, Music, Movie, Sport, AI. Set bass and treble according to your needs.

\*Note: NOT support Dolby sound. Of the video doesn't have sound, please check if it uses Dolby sound in source video.

### System Setting

\*Language Setting: set the language of the system.

\*Restore Factory Default: restore the factory default setting.

## Bluetooth Function

- \* It can only be used as a speaker when you turn on BT function.
- \* Long press the power switch button until the lamp of the projector is off > Release the button and the connection tip tone comes out > search 'BT PROJECTOR' on your device > connect it with your device
- \* In bluetooth mode, you can't use the projection function.
- \* Please control the volume on your device.
- \* Turn off Bluetooth mode: press return button to access main menu page and disconnect Bluetooth connection.

## Wireless Mirroring WiFi/DLNA Connection Function

\*Don't recommend iOS buyer to use 'Screen Mirroring Connection With Projector'. If you use mirroring connection to project the video on your phone, you have to use mobile traffic/data to access the Internet.

### Screen Mirroring Connection With Projector

Choose  icon and press OK button > Wait for completion of initial setup in seconds > The WiFi name of the projector shows up on the screen(Display\_6F6A) > Connect the WiFi of the projector

#### 1. iOS Display:

Open the Screen Mirroring / AirPlay function > Find the same WiFi name > Click and connect >Done

\*Name(SSID) and password(PSK) is on the projection screen.

#### 2. Android Display:

Open the Multi-screen / Miracast function on the Android device > Find the same WiFi name > Click and connect >Done

\*Name(SSID) and password(PSK) is on the projection screen.

Note: Some APPs only accept up to 720P resolution.

Not all device support Multi-Screen/Wireless Display. If device can't search projector WiFi name, please restart projector.

## Screen Mirroring Connection With Projector

1. Choose  icon and press OK

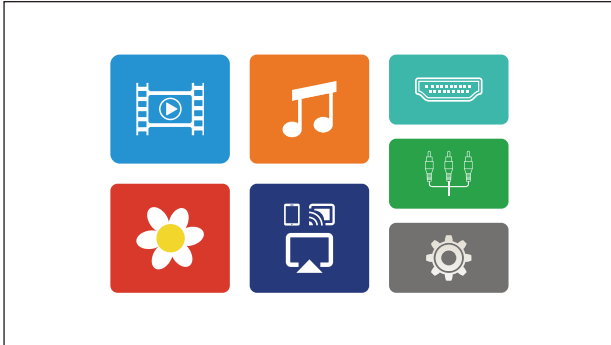

2. Wait a few seconds.

Connection page shows up. Use your phone to connect the WIFI of the projector (Name: Display\_6F6A, Password: 12345678)



### iOS Display

Click the Screen Mirroring / AirPlay function



Connect the device named 'Display\_6F6A'



### Android Display

Click the Multi-screen / Miracast function



Connect the device named 'Display\_6F6A'



## Screen Mirroring Connection With Same WIFI

### IOS/Android Display

\* Download a browser APP like Chrome that supports QR scan function on your phone first

Choose  icon and press OK button > Use your phone to connect with the WIFI you want(not support 5G) > Use browser to scan QR code on the bottom of the projection screen > Choose the same WiFi that your phone is connecting with > Open the Multi-Screen/Miracast function on your phone > Choose the WIFI name of projector: "Display\_6F6A" > Choose 'Trust' if your phone asks > Done

### IOS/Android Display

\*Download a browser APP like Chrome that supports QR scan function on your phone first.

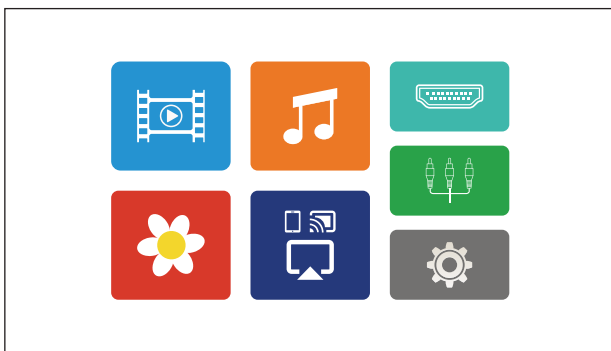

1. Choose  icon and press OK



2. Use your phone to connect with the WIFI you want(not support 5G)



3. Take Chrome as example  
Open it and click the Search Bar



4. Click the Scan icon



5. Scan QR code on the bottom of the projection screen



6. Choose the same WiFi that your phone is connecting with



7. Open the Multi-Screen/Miracast function on your phone



8. Connect the device named "Display\_6F6A"  
\*Choose 'Trust' if your phone asks

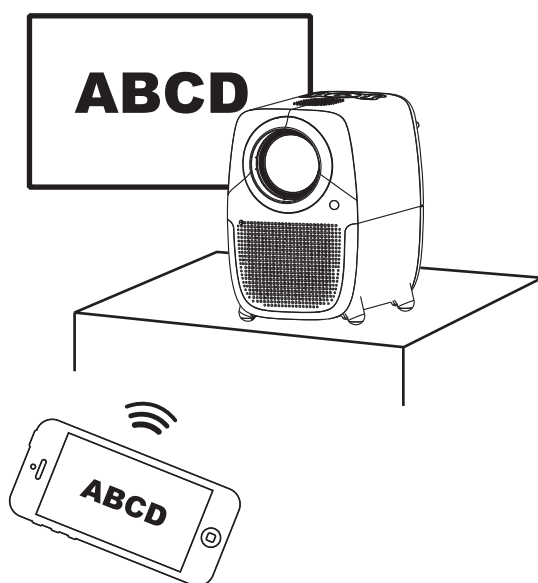

9. Connection succeed

## DLNA Connection

### Step 1:

Choose  icon and press OK button > Wait for completion of initial setup in seconds  
> The WiFi name of the projector shows up on the screen

### Step 2: Connect your phone with your home WiFi

Open the WiFi setting on your phone > Connect the WiFi in your home

### Step 3: Connect projector with the same home WiFi

\*Download a browser APP like Chrome that supports QR scan function on your phone first

Scan QR code on the bottom of the projection screen > Choose the same WiFi in your home > Enter password > Wait for connection

\*If the top of the projection screen shows up your home WiFi name, it means the connection is successful.

Note: NOT support 5G wifi

\*Note:

Some APPs don't support DLNA connection due to copyright issue.

Some APPs only accept up to 720P resolution.

### Step 4: DLNA Display

\*Some APPs have TV/Project Screen function. Please find and click on it in video playback page.

\*Find the name of the projector (Display\_6F6A) in your phone > Connect it > Projector will display the video on your phone.

## How to change WiFi on the projector

\*If you would like to change the WiFi, please enter the IP address of the projector(It is on the side of the projection screen), or scan the QR code to access setting page to choose a different WiFi

Note: DLNA connection supports up to 720P. If the video doesn't play or get stuck, please choose a lower resolution format.

If you would like to use a different device to connect with the projector, please disconnect the first device first.



## DLNA Wireless Connection

\*Download a browser APP like Chrome that supports QR scan function on your phone first

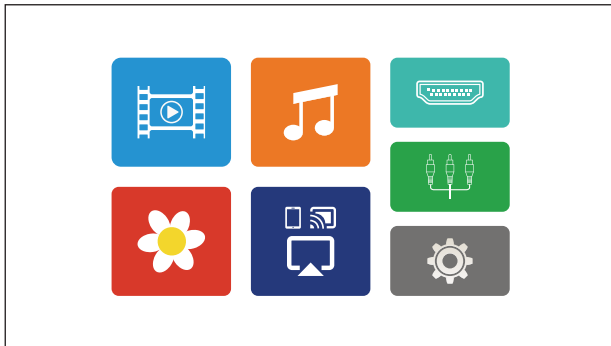

1. Choose  icon and press OK



2. Wait a few seconds.  
Connection page shows up



3. Use your phone to connect with the WIFI you want(not support 5G)



4. Take Chrome as example  
Open it and click the Search Bar

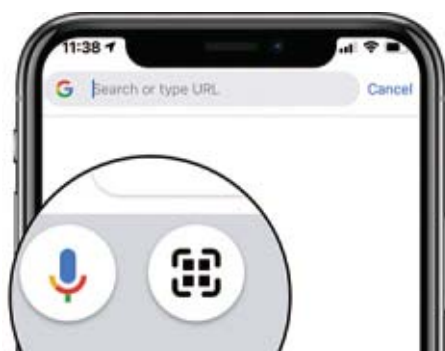

5. Click the Scan icon



6. Scan QR code on the bottom of the projection screen



7. Choose the same WiFi that your phone is connecting with  
\*If the top of the projection screen shows up your home WiFi name, it means the connection is successful.



8. Some APPs have TV/Project Screen function. Please find and click on it in the video playback page.



9. Connect the device named (Display\_6F6A)

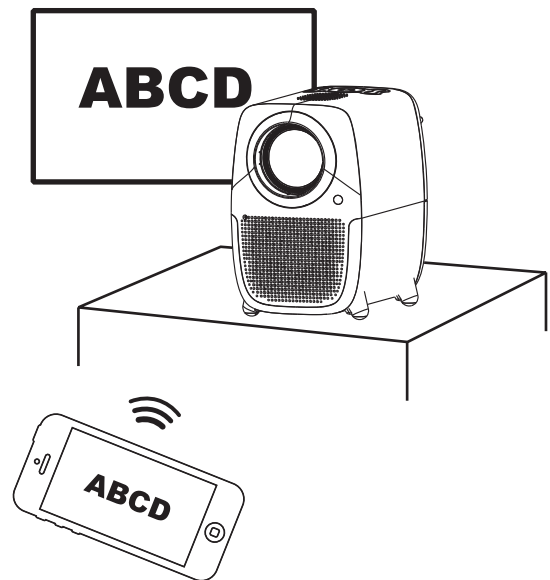

10. Connection succeed

## How to Clean

Please disconnect the power adapter before clean.

Please don't use insecticide or other volatile chemicals on Projector or its lens.

Please don't let rubber or ethylene products contact the products for a long time. The coating will be damaged or peeled off.

### Clean Projector

Please wipe with soft and dry cotton cloth. If it is very dirty, please wipe with a soft cloth dampened with diluted neutral detergent and use dry cloth to make it dry. If you use chemical fiber cloth, please be careful.

To avoid damage or coating peeled off, please don't use thinner, benzene or other solvents.

Do not scratch the projector with nails or other hard objects to avoid scratching

### Clean Lens

Please use the professional cleaning kit such as air blower, lens cleaning tissue etc. to clean the lens. Or it will cause scratch.

### Clean Ventilation Holes

Too many dust will caused the projector overheating. Please clean ventilation holes at least every 1000 hours use.

Turn off the projector > Disconnect the power adapter > Insert brush into a mini vaccum cleaner > Use it to clean outside of projector

Avoid direct use of vacuum cleaners without connectors, or use nozzles for cleaning.

## Q&A

If you have any question, please contact us via Amazon email. Please send us your order ID and some pictures to make things clear.

1. There is no sound during video playing

Check if you press Mute button on the remote > Check if the video use Dolby sound > Turn down the Dolby sound mode on the video. (The projector doesn't support Dolby sound)

2. Image got blurred.

Check the resolution of the video. If its resolution is low, please shorten the projection distance.

Use the focus button on the remote to adjust the focus until the image is clear.

Recommend to use it in a dim environment to get better viewing experience.

3. How to change the WiFi connection of the projector

Please enter the IP address of the projector(It is on the side of the projection screen), or scan the QR code to access setting page to choose a different WiFi.

4. Projector keeps turning off

It might due to the overheating. Please check if there is somethin blocking the entilation holes. Please don't pile things up around the projector.

5. Insert USB flash drive but can't access it on the projector

The projector supports up to 32G USB flash drive. Please check if your flash drive is 32GB or below.

6. Can't connect my phone with projector.

Please send some pictures and descrip the issue to us. Please contact us via Amazon email and we are happy to help.

7. Remote Control is not working.

Please change the battery and keep the remote point to the IR remote control receiving window of the projector.

8. The fans is too loud.

It is normal that it has noise when the cooling system is working because the projector with high brightness need heat dissipation in time. So please do not put the projector in hot environment or too long to use at one time, If the sound of the video is not enough, we recommend you use an extra speaker to get better sound effect.

## Specification

Lamp Life	Up to 50,000 hours
Screen Size	30-250 inch
Projection Distance	1-8 m
Speaker	3W*2
Electric Focusing Mode	Yes
Keystone	± 40 degree

File Type	Support Format
Video	MPG, VOB, AVI, MKV, MP4, MOV, 3GP, FLV, WMV, ASF, MKV
Music	MP3, WMA, MP2, AAC, FLAC, 3GP, WAV
Image	jpg, png, bmp



\*When you use wireless Mirroring WiFi Connection, the projector supports up to 1080P video. When you use DLNA connection, it only supports up to 720P.

\*If the projector can't access your files, please check if the files are damaged or the format is not included in the form.

## FCC Statement

This equipment has been tested and found to comply with the limits for a Class B digital device, pursuant to part 15 of the FCC rules. These limits are designed to provide reasonable protection against harmful interference in a residential installation. This equipment generates, uses and can radiate radio frequency energy and, if not installed and used in accordance with the instructions, may cause harmful interference to radio communications. However, there is no guarantee that interference will not occur in a particular installation. If this equipment does cause harmful interference to radio or television reception, which can be determined by turning the equipment off and on, the user is encouraged to try to correct the interference by one or more of the following measures:

- Reorient or relocate the receiving antenna.
- Increase the separation between the equipment and receiver.
- Connect the equipment into an outlet on a circuit different from that to which the receiver is connected.
- Consult the dealer or an experienced radio/TV technician for help.

To assure continued compliance, any changes or modifications not expressly approved by the party.

Responsible for compliance could void the user's authority to operate this equipment. (Example- use only shielded interface cables when connecting to computer or peripheral devices).

This equipment complies with Part 15 of the FCC Rules. Operation is subject to the following two conditions:

- (1) This device may not cause harmful interference, and
- (2) This device must accept any interference received, including interference that may cause undesired operation.

## FCC Radiation Exposure Statement:

The equipment complies with FCC Radiation exposure limits set forth for uncontrolled environment. This equipment should be installed and operated with minimum distance 20cm between the radiator and your body