

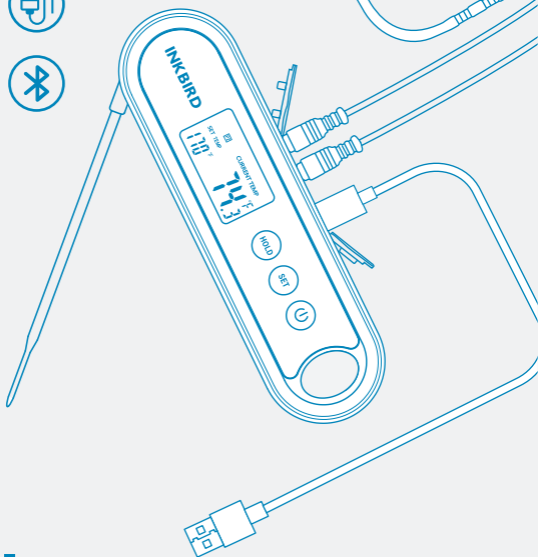

**INKBIRD**



**IHT-2PB**

***Bluetooth Digital Food  
Thermometer  
With 2 External Probes***

# Contents

<b>01</b>	<b>Overview</b>	01
<b>02</b>	<b>Features &amp; Specifications</b>	01
<b>03</b>	<b>Product Diagram</b>	02
<b>04</b>	<b>Connection</b>	03
	<ul style="list-style-type: none"><li>• Free App Download</li><li>• Bluetooth Connection</li></ul>	
<b>05</b>	<b>Key Definition</b>	06
<b>06</b>	<b>Operation Instructions</b>	07
	<ul style="list-style-type: none"><li>• App Operating Functions</li><li>• Menu Instruction</li><li>• Parameter Setting Guide</li><li>• Operating Functions Of The Built-In Probe (unplugging the external probes)</li><li>• BBQ Functions (plugging the external probes)</li></ul>	
<b>07</b>	<b>Q&amp;A About Abnormalities</b>	23
<b>08</b>	<b>Important Notes/Warning</b>	24
<b>09</b>	<b>Product Warranty</b>	25
<b>10</b>	<b>FCC Requirement</b>	25
<b>11</b>	<b>Meat Temperature &amp; Doneness Chart</b>	27



This instant-read Bluetooth food thermometer is designed with 2 sockets for external probes, in addition to a built-in probe. Therefore, it's available to measure temperature via 3 channels simultaneously. Also, you can control the device via Bluetooth on your phone, making it easier and faster to operate. You can use it to measure various food, such as steak, turkey, pork, chicken, fish, and drinks, etc. It helps you cook at a precise temperature for each specific food, a good helper to create perfect meals for your family and friends.

- Product Name: Bluetooth Digital Food Thermometer
- Product Model: IHT-2PB
- 3 stainless steel probes for temperature measuring
- Heat-resistant, waterproof probe cables
- Temperature range of probes: -50.0°C-300°C (-58.0°F-572°F)
- Measurement accuracy:  $\pm 0.5^{\circ}\text{C}/\pm 1.0^{\circ}\text{F}$
- Readout time(Built-in Probe): 2 seconds
- Support Bluetooth connection
- Auto-off/sleep mode
- Clear backlit LCD Screen
- HOLD function to lock the measured temperature on the LCD screen
- ALARM function to alert you when the measured temperature reaches the present temperature for your food
- Temperature calibration:  $-4.9^{\circ}\text{C}\sim 4.9^{\circ}\text{C}/-9.9^{\circ}\text{F}\sim 9.9^{\circ}\text{F}$
- Waterproof to IPX5
- Rechargeable lithium battery, more convenient to use; It only takes 1 hour to get the battery fully charged.
- Easy to be stored with the attached hook and magnet
- 2-year product warranty

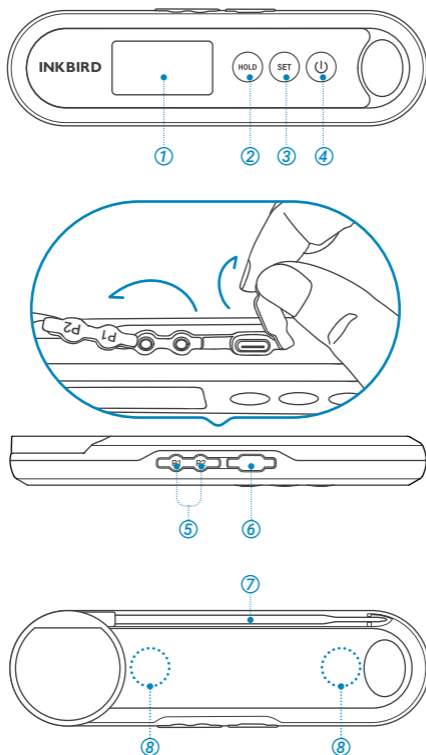

① LCD Screen & Backlight

② HOLD/UP Button

③ SET Button

④ POWER/DOWN Button

⑤ Probe 1/2 Sockets

⑥ Battery Charge Port

⑦ Built-in Probe

⑧ Magnetic Back

## Free App Download

Get BBQGo Pro from Google Play or App Store for free, or you can scan the QR codes below to download the app directly.



Android



iOS

Please make sure the following requirements are met to download the apps smoothly:

- Your IOS devices must be running IOS 11 or above to download the app.
- Your Android devices must be running Android 5.0 or above to download the app.

## Bluetooth Connection

# A

Press the button to turn on Bluetooth; press the button again to turn off Bluetooth. You would see the Bluetooth icon flashing at a frequency of 2Hz, which means the application is searching to connect. When the Bluetooth icon is off, Bluetooth is disconnected.



# B

Open BBQGO Pro App, the installed application on your phone.

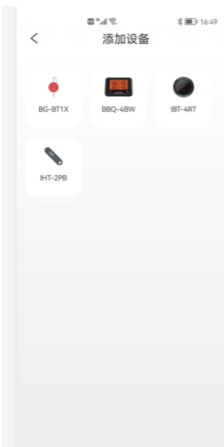

# C

Click to add a device.



D

Choose IHT-2PB.



E

Make sure the Bluetooth icon on IHT-2PB is flashing at a frequency of 2Hz, and then click Next Step.

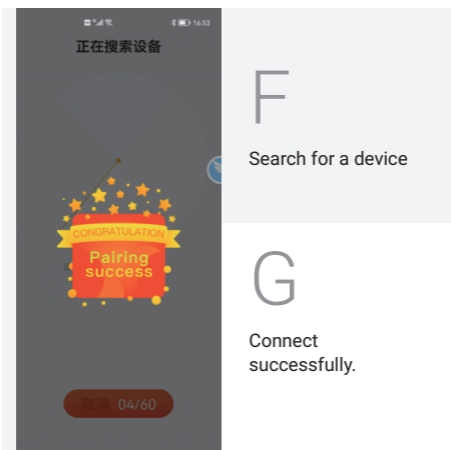

## 05

## Key Definition



**SET** Press and hold the button for 2 seconds to enter the menu for function setting. During the setting process, press the button to choose functions; press and hold the button for 2 seconds to quit and save setting changes.

**⏻** Press the button to turn on the device. In normal mode, press and hold the button for 2 seconds to turn off the device. In setting mode, press the button to decrease the value of parameters; long press the button to quickly decrease the value of parameters.

**HOLD** In normal mode, press the button to lock or unlock the value of current temperature; press and hold the button for 3 seconds to switch the display of 3 channels. In setting mode, press the button to increase the value of parameters; long press the button to quickly increase the value of parameters.





## App Operating Functions

### • Operation Interface



## • Setting Menu

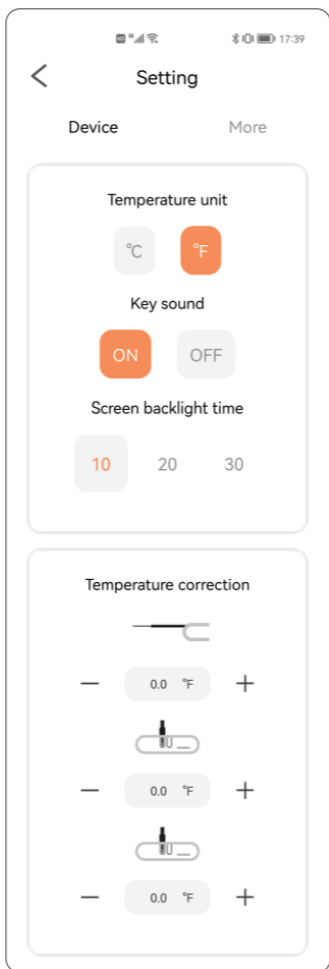

- **More Settings**

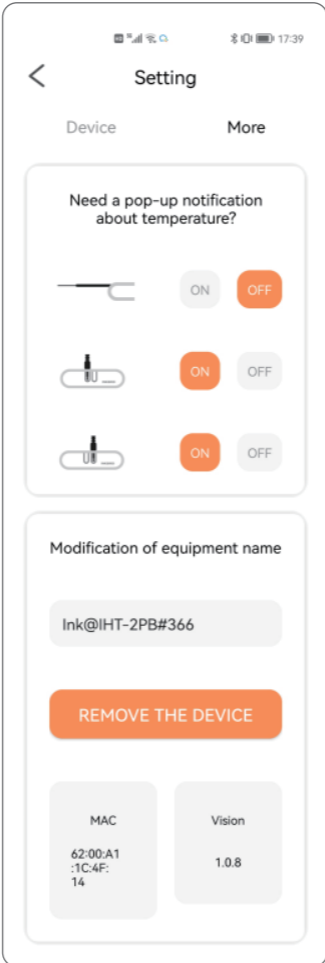

## Menu Instruction

MENU ITEMS	DIS-PLAY	FUNCTIONS	SETTING RANGE	DEFAULT VALUES
CF	CF	Celsius/ Fahrenheit	C/F	F
BEE	bEE	Key sound	ON or OFF	ON
BLT	blt	Backlight active time	5~60S	10S
ALM	ALn	Alarm function for the built-in probe	ON/OFF	OFF
TS	tS	Alarm value for the built-in probe	-50.0°C~300°C	77.0°C
			-58.0°F~572°F	170°F
CA	cA	Temperature calibration for the built-in probe	-4.9°C~4.9°C	0.0°C
			-9.9°F~9.9°F	0.0°F
ALM1	ALn <sub>1</sub>	Alarm function for the external probe1	ON or OFF	ON
TS1	tS <sub>1</sub>	Alarm value for the external probe1	-50.0°C~300°C	77.0°C
			-58.0°F~572°F	170°F
CA1	cA <sub>1</sub>	Temperature calibration for the external probe1	-4.9°C~4.9°C	0.0°C
			-9.9°F~9.9°F	0.0°F
ALM2	ALn <sub>2</sub>	Alarm function for the external probe2	ON or OFF	ON
TS2	tS <sub>2</sub>	Alarm value for the external probe2	-50.0°C~300°C	77.0°C
			-58.0°F~572°F	170°F
CA2	cA <sub>2</sub>	Temperature calibration for the external probe2	-4.9°C~4.9°C	0.0°C
			-9.9°F~9.9°F	0.0°F

## Parameter Setting Guide

### Temperature Display Unit of °C/°F

**Step 1:** press and hold **SET** button for 2 seconds to enter the menu for function setting, then press the button to choose CF function.

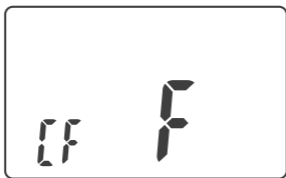

**Step 2:** press **HOLD** or **POWER** button to choose °C or °F.

**NOTE:** All parameters will be restored to their default values once you change the temperature unit.

**Step 3:** press and hold **SET** button for 2 seconds to quit and save changes. (All changes will be automatically saved if there is no operation in 30 seconds.)

### Key Sound

**Step 1:** press and hold **SET** button for 2 seconds to enter the menu for function setting, then press the button to choose BEE function.



**Step 2:** press **HOLD** or **POWER** button to choose ON or OFF.

**Step 3:** press and hold **SET** button for 2 seconds to quit and save changes. (All changes will be automatically saved if there is no operation in 30 seconds.)

## ***Backlight Active Time***

**Step 1:** press and hold **SET** button for 2 seconds to enter the menu for function setting, then press the button to choose BLT function.



**Step 2:** press **HOLD** or **⏻** button to increase or decrease the value; long press **HOLD** or **⏻** button to quickly increase or decrease the value. (The active time of the backlight is adjustable from 5 to 60 seconds.)

**Step 3:** press and hold **SET** button for 2 seconds to quit and save changes. (All changes will be automatically saved if there is no operation in 30 seconds.)

## ***Alarm Function for the Built-in Probe***

**Step 1:** press and hold **SET** button for 2 seconds to enter the menu for function setting, then press the button to choose ALM function.







**Step 2:** press  or  button to choose ON or OFF.

**Step 3:** press and hold  button for 2 seconds to quit and save changes. (All changes will be automatically saved if there is no operation in 30 seconds.)

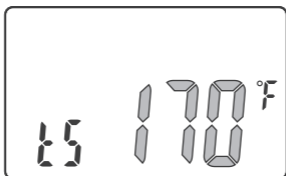
## ***Alarm Value Setting for the Built-in Probe***

**Step 1:** press and hold  button for 2 seconds to enter the menu for function setting, then press the button to choose TS function.



**Step 2:** press  or  button to increase or decrease the value; long press  or  to quickly increase or decrease the value.

**Step 3:** press and hold  button for 2 seconds to quit and save changes. (All changes will be automatically saved if there is no operation in 30 seconds.)

## ***Temperature Calibration for the Built-in Probe***

**Step 1:** press and hold  button for 2 seconds to enter the menu for function setting, then press the button to choose CA function.



**Step 2:** press **HOLD** or **⏻** button to increase or decrease the value; long press **HOLD** or **⏻** to quickly increase or decrease the value.

**Step 3:** press and hold **SET** button for 2 seconds to quit and save changes. (All changes will be automatically saved if there is no operation in 30 seconds.)

When the current temperature is 75.5°F, the screen displays 75.8°F after setting the CA value as 0.3°F.



## ***Alarm Function for P1 (the External Probe1)***

**Step 1:** press and hold **SET** button for 2 seconds to enter the menu for function setting, then press the button to choose ALM2 function.

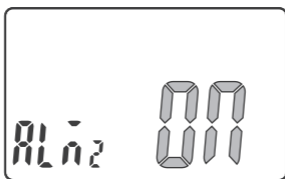

**Step 2:** press **HOLD** or **⏻** button to choose ON or OFF.

**Step 3:** press and hold **SET** button for 2 seconds to quit and save changes. (All changes will be automatically saved if there is no operation in 30 seconds.)

## ***Alarm Value Setting for P2 (the External Probe2)***



**Step 1:** press and hold **SET** button for 2 seconds to enter the menu for function setting, then press the button to choose TS2 function.



**Step 2:** press **HOLD** or **⏻** button to increase or decrease the value; long press **HOLD** or **⏻** to quickly increase or decrease the value.

**Step 3:** press and hold **SET** button for 2 seconds to quit and save changes. (All changes will be automatically saved if there is no operation in 30 seconds.)

## ***Temperature Calibration for P1 (the External Probe 1)***

**Step 1:** press and hold **SET** button for 2 seconds to enter the menu for function setting, then press the button to choose CA2 function.



**Step 2:** press **HOLD** or **⏻** button to increase or decrease the value; long press **HOLD** or **⏻** to quickly increase or decrease the value.

**Step 3:** press and hold **SET** button for 2 seconds to quit and save changes. (All changes will be automatically saved if there is no operation in 30 seconds.)

When the current temperature is 75.5°F, the screen displays 75.8°F after setting the CA value as 0.3°F.



## ***Alarm Function for P2 (the External Probe 2)***

**Step 1:** press and hold **SET** button for 2 seconds to enter the menu for function setting, then press the button to choose ALM2 function.

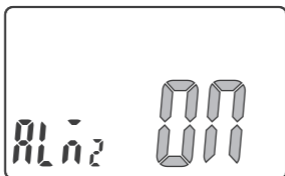



**Step 2:** press **HOLD** or **POWER** button to choose ON or OFF.

**Step 3:** press and hold **SET** button for 2 seconds to quit and save changes. (All changes will be automatically saved if there is no operation in 30 seconds.)

## ***Alarm Value Setting for P2 (the External Probe2)***

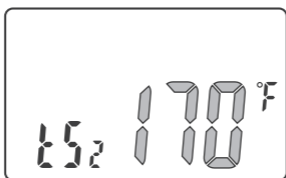
**Step 1:** press and hold **SET** button for 2 seconds to enter the menu for function setting, then press the button to choose TS2 function.







**Step 2:** press  or  button to increase or decrease the value; long press or to quickly increase or decrease the value.

**Step 3:** press and hold  button for 2 seconds to quit and save changes. (All changes will be automatically saved if there is no operation in 30 seconds.)

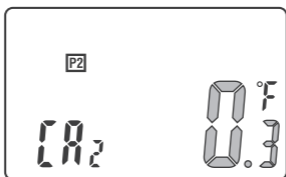
## ***Temperature Calibration for P2 (the External Probe 2)***

**Step 1:** press and hold  button for 2 seconds to enter the menu for function setting, then press the button to choose CA2 function.



**Step 2:** press  or  button to increase or decrease the value; long press  or  to quickly increase or decrease the value.

**Step 3:** press and hold  button for 2 seconds to quit and save changes. (All changes will be automatically saved if there is no operation in 30 seconds.)

When the current temperature is 75.5°F, the screen displays 75.8°F after setting the CA value as 0.3°F.

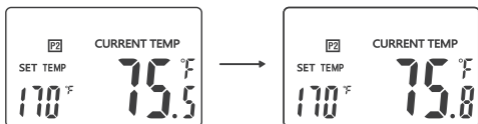

## Operating Functions Of The Built-In Probe (unplugging the external probes)

### *Screen Display*

Without plugging the external probes, the built-in probe is the current channel. The LCD screen displays data of the current channel in priority.

When ALM=ON (the alarm function is on), the screen displays SET TEMP and the alarm value of the probe.

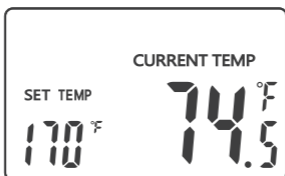

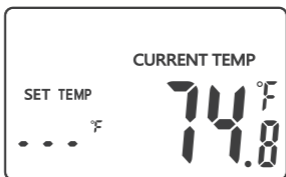

When ALM=OFF (the alarm function is off), the screen displays SET TEMP and " . . . ".



## **Turn ON/OFF**

**Automatically:** The device is automatically turned on by unfolding the built-in probe. It is turned off when you fold the probe back.

**Manually:** Press  button to turn on the device. Regardless of the probe being folded or unfolded, you can press and hold  button for 2 seconds to turn off the device.

**Auto Reboot:** In probe being unfolded state, the device will automatically sleep if there is no operation or no dynamic of current temperature over 3 minutes. In that situation, if the temperature suddenly changes, the device will automatically return to work.

## **Alarm Function**

When you set ALM as OFF, the alarm function is off, and the screen only displays the current measured temperature.

When you set ALM as ON, the alarm function is on, and the screen displays the alarm value (TS) and the current measured temperature.

A  symbol will appear on the screen if the current temperature reaches the alarm value (TS). Meanwhile, the device will alarm you with a “bi-bi-bi” sound repeating at an interval of 2 seconds. And the backlight will keep active for 60 seconds.

**How To Cancel The Alarm:** ① Press any button to cancel the alarm; ② The alarm will automatically stop if the temperature goes lower than the alarm value.

## **Backlight**

Backlight helps you check data conveniently. Without any operation, the backlight will keep activated for the time of BLT parameter, then be off automatically . You can press any button to activate it when it's off. If you unfold the probe, the backlight will be activated automatically when the probe detects a temperature change.

## **BBQ FUNCTIONS**

### **(plugging the external probes)**

## **Screen Display**

When you plug the external probe P1, the P1 probe is the current channel. The LCD screen displays data of the current channel in priority. P1 symbol appears on the screen.

When ALM1=ON (the alarm function of P1 probe is on),the screen displays SET TEMP and the alarm value of P1 probe.

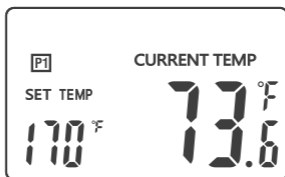

When ALM1=OFF (the alarm function of P1 probe is off),the screen displays SET TEMP and " . . . ".

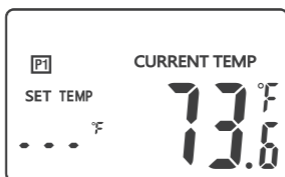

When you plug the external probe P2, the P2 probe is the current channel. The LCD screen displays data of the current channel in priority. P2 symbol appears on the screen.

When ALM2=ON (the alarm function of P2 probe is on),the screen displays SET TEMP and the alarm value of P2probe.

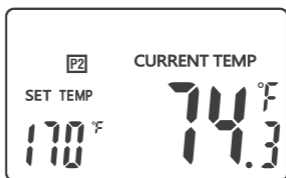

When ALM2=OFF (the alarm function of P2 probe is off),the screen displays SET TEMP and " - - - ".

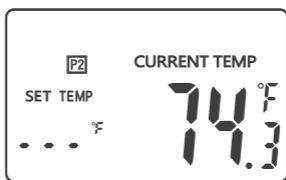

When you plug both external probes simultaneously, both external probes are current channels. The LCD screen alternately displays data of both external probes at a frequency of 0.5Hz.

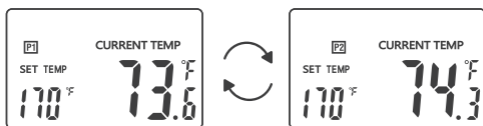

## ***Alarm 1&2 Function***

When you set ALM1 (or ALM2) as OFF, the alarm function of P1 (or P2) probe is off, and the screen only display the current measured temperature.

When you set ALM1 (or ALM2) as ON, the alarm function of P1 (or P2) probe is on, and the screen displays the alarm value of P1(or P2) probe (TS1/2) and the current measured temperature.

A  symbol will appear on the screen if the current temperature reaches the alarm value (TS1/TS2). Meanwhile, the device will alarm you with a “bi-bi-bi” sound repeating at an interval of 2 seconds. And the backlight will be activated for 60 seconds.

How To Cancel The Alarm:

- ① Press any button to cancel the alarm;
- ② The alarm will automatically stop if the temperature goes lower than the alarm value.

### ***Note:***

When you use the external probes, please

1. Place the external probes inside the oven if you use an oven;
2. Make sure the external probes are inserted into the thickest center part of the meat; Avoid bones and fat;
3. Make sure the probe cables stay away from extrusion and fire;
4. Place or hang the thermometer away from the fire.

### ***Backlight***

Backlight helps you check data conveniently. Without any operation, the backlight will keep activated for the time of BLT parameter, then be off automatically . You can press any button to activate it when it's off. If you unfold the probe, the backlight will be activated automatically when the probe detects a temperature change.



## Display Switch Over

Press and hold  button for 3 seconds to switch to display data of the built-in probe. The screen will automatically return to display data of the current channels in 20 seconds if there is no more manual switchover.

## 07

## Q&A About Abnormalities

**Q1:** What can you do if the screen displays “Er”, “—” or other abnormal values?

**Answer:** Please contact INKBIRD in time.

**Q2:** What can you do if the screen do not display any value about P1 after inserting an external probe into the P1 jack?

**Answer:** Please do as follows:

- unplug the external probe;
- insert it into the P1 jack again with steady force;
- rotate the jack plug to make sure that it has good contact with the P1 jack.

If the display problem is still unsolved, or the screen displays “Er1”, please contact INKBIRD.

**Q3:** What can you do if the screen do not display any value about P2 after inserting an external probe into the P2 jack?

**Answer:** Please do as follows:

- unplug the external probe;
- insert it into the P2 jack again with steady force;
- rotate the jack plug to make sure that it has good

contact with the P2 jack.

If the display problem is still unsolved, or the screen displays "Er2", please contact INKBIRD.

**Q4:** Why can't you turn on/off the thermometer by folding/unfolding the probe?

**Answer:** Please make sure both external probes are not plugging in both jacks. The unfold-to-turn-on function can only work without external probes.

**Q5:** Can you use the thermometer while the battery is charging?

**Answer:** Yes.

## 08

## *Important Notes/Warning*

- Please do not allow the probes or the probe cables to touch the fire, or it may result in burning and fusing.
- Please insert the probe deep enough into the meat if the display reading value is too high or increases too quickly. To detect the temperature of the meat, probes should be inserted into the thickest part of the meat. Avoid bones and fat.
- Please wear gloves when you clean or use the probes. Do not touch the probes or cables immediately after use, or it may result in scalding or stab wounds.
- Please keep the probes away from children to avoid possible harm.
- Please clean and air-dry the probes after use.
- Please do not immerse the thermometer in the water, though it can be rinsed with water.
- Please do not clean the jack plug of each probe with water, or it may cause bad contact.
- Please do not use the stainless steel probes in

microwave ovens.

- Please do not use the product beyond the temperature range from -50°C to 300°C (-58°F to 572°F), or it may cause damages.
- Children aged 12 or under 12 should use it with parental guidance.

## 09

### *Product Warranty*



This item carries a 2-year warranty against defects in either components or workmanship. During this period, products that prove to be defective will, at the discretion of INKBIRD, be either repaired or replaced without charge.

## 10

### *FCC Requirement*



changes or modifications not expressly approved by the party responsible for compliance could void the user's authority to operate the equipment.

This device complies with Part 15 of the FCC Rules. Operation is subject to the following two conditions:

- (1) this device may not cause harmful interference, and
- (2) this device must accept any interference received, including interference that may cause undesired operation.

Note: This equipment has been tested and found to comply with the limits for a Class B digital device,

pursuant to Part 15 of the FCC Rules. These limits are designed to provide reasonable protection against harmful interference in a residential installation. This equipment generates, uses, and can radiate radio frequency energy, and if not installed and used in accordance with the instructions, may cause harmful interference to radio communications. However, there is no guarantee that interference will not occur in a particular installation. If this equipment does cause harmful interference to radio or television reception, which can be determined by turning the equipment off and on, the user is encouraged to try to correct the interference by one or more of the following measures:

- Reorient or relocate the receiving antenna.
- Increase the separation between the equipment and receiver.
- Connect the equipment into an outlet on a circuit different from that to which the receiver is connected.
- Consult the dealer or an experienced radio/TV technician for help.

This equipment complies with FCC radiation exposure limits set forth for an uncontrolled environment. This equipment should be installed and operated with a minimum distance of 20cm between the radiator & your body. This transmitter must not be co-located or operating in conjunction with any other antenna or transmitter.



# Meat Temperature & Doneness Chart



MEAT	Rare	M.Rare	Medium	M.Well	Done
Beef	49°C/ 120°F	54°C/ 130°F	60°C/ 140°F	66°C/ 150°F	77°C/170°F
Veal	49°C/ 120°F	54°C/ 130°F	60°C/ 140°F	66°C/ 150°F	77°C/170°F
Lamb	49°C/ 120°F	54°C/ 130°F	60°C/ 140°F	66°C/ 150°F	77°C/170°F
Pork					63°C/145°F
Chicken					74°C/165°F
Turkey					74°C/165°F
Fish					63°C/145°F
Hamburger					75°C/167°F
BBQ Smoke					102°C~110°C/ 216°F~230°F
Hot Smoke					52°C~80°C/ 126°F~176°F
Cold Smoke					20°C~30°C/ 68°F~86°F





## **INKBIRD TECH.C.L**

Support@inkbird.com

www.inkbird.com

4/F E, Bldg 713, Pengji Industrial Zone,  
Liantang St, Luohu Dist, Shenzhen, China.



V1.0

骑马订 80\*160mm