

**Winees**  
Witness Fun Moments

Winees

## User Instructions M3 Plus & M3

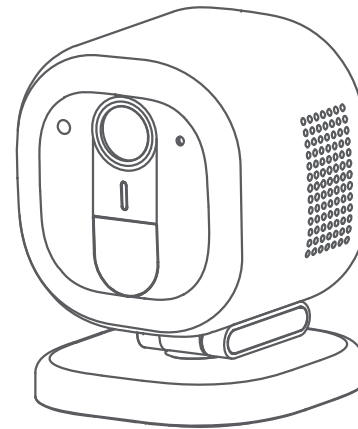

English 01

Deutsch 13

日本語 23

# EN CONTENTS

01 IN THE BOX

PRODUCT OVERVIEW 02

03 APP SETUP

INSTALLATION 04

06 LIGHT INDICATIONS

CAUTIONS 07

11 NEED HELP?

## IN THE BOX



Camera



Power Adapter



Power Cable

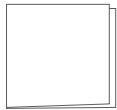

User Instructions

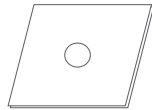

3M Tape

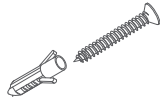

Screws

1EN

## PRODUCT OVERVIEW

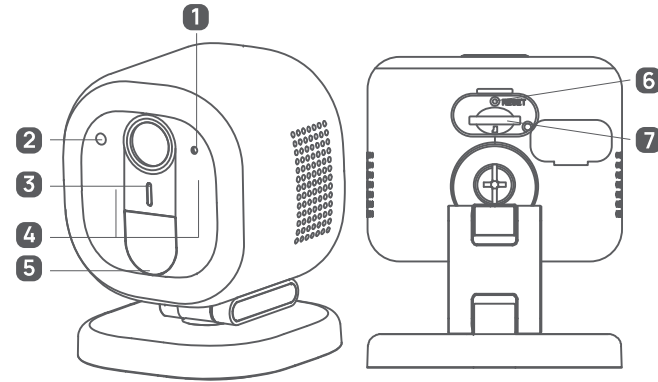

- 1. Mic
- 2. Light Sensor
- 3. Light Indicator
- 4. IR LED
- 5. Spotlight (only in M3Plus)

- 6. Reset Button
- 7. MicroSD Card Slot

EN 2

## APP SETUP

1. Scan the QR code below to download the AiDot APP.



Or search for "AiDot" in App Store or Google Play



2. Power on the camera, you will hear "Waiting for Wi-Fi configuration" with the camera's indicator light flashing in green.

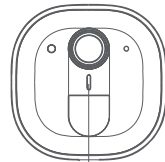

LED indicator flashing green

3. In the AiDot app, press '+' - select Winees M3Plus/M3 Cam the instructions on App.



3EN

4. Place the M3Plus or M3 Cam in the area where you plan to install to test the video quality, ensure that the camera can work normally after the final installation.

## INSTALLATION

● Install on the wall

For a better user experience, we recommend you to install the camera as the below conditions.

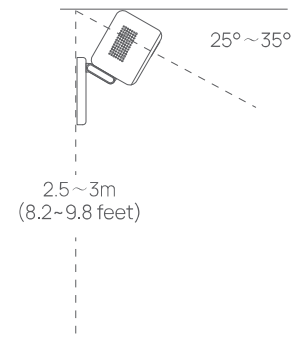

EN4

On a masonry surface (3M tape can be used to fix the position before screw driven in)

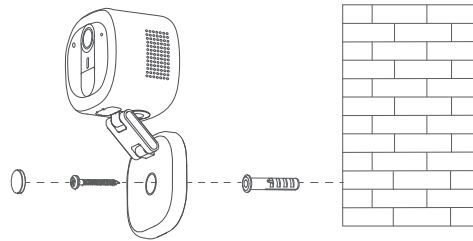

On a wooden surface (3M tape can be used to fix the position before screw driven in)

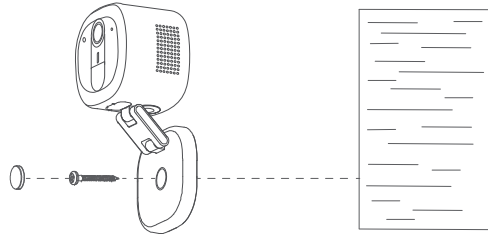

5 EN

● Install on the ceiling (3M tape can be used to fix the position before screw driven in)

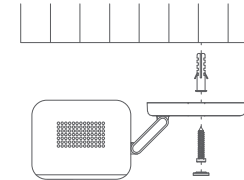

● Place on the table or other flat surface (3M tape can be used to fix the position)

## LIGHT INDICATIONS

Status	Description
Solid Red	Power on/System booting / Factory resetting
Flashing Red	Wireless connection , cloud connecting fail
Solid Green	Wireless connected
Flashing Green	System ready for WiFi setup / Firmware update
Red and Green flashing alternately	Unable to connect to the cloud

EN 6

## CAUTIONS

To avoid personal injury and/or possible product damage, the following cautions must be followed:

1. Please use the provided adapter instead of others in case of any damage to the product.
2. Keep out of reach of children. This product contains small magnets and other small parts, which can cause choking or injury if ingested.
3. To prevent early failure, the camera should only be installed in operating environments ranging between -20°C ~ 50°C (-4°F ~ 122°F).
4. Do not install
  - close to heat source
  - near the metal objects and mirrors that cause radio signal attenuation or shading.
5. Do not disassemble or reinstall the camera, otherwise it may cause security risks.
6. Unplug the power cord before cleaning. Do not clean the camera with any liquids, spray cleaner or wet cloth.
7. The slot and opening are used for ventilation, not allowed to be blocked or covered.
8. This product only can be connected to 2.4G WIFI.

7 EN

### ■ FCC Statement

This device complies with Part 15 of the FCC Rules. Operation is subject to the following two conditions:

- (1) This device may not cause harmful interference.
- (2) This device must accept any interference received, including interference that may cause undesired operation.

■ Note: The grantee is not responsible for any changes or modifications not expressly approved by the party responsible for compliance. Such modifications could void the user's authority to operate the equipment.

■ Note: This equipment has been tested and found to comply with the limits for a Class B digital device, pursuant to part 15 of the FCC Rules. These limits are designed to provide reasonable protection against harmful interference in a residential installation. This equipment generates uses and can radiate radio frequency energy and, if not installed and used in accordance with the instructions, may cause harmful interference to radio communications. However, there is no guarantee that interference will not occur in a particular installation. If this equipment does cause harmful interference to radio or television reception, which can be determined by turning the

EN 8

equipment off and on, the user is encouraged to try to correct the interference by one or more of the following measures:

- Reorient or relocate the receiving antenna.
- Increase the separation between the equipment and receiver.
- Connect the equipment into an outlet on a circuit different from that to which the receiver is connected.
- Consult the dealer or an experienced radio/TV technician for help.

#### ● RF Exposure Statement

This equipment complies with FCC radiation exposure limits set forth for an uncontrolled environment. This equipment should be installed and operated with minimum distance of 20 cm between the radiator and your body.

#### ● ISED Statement

This device contains licence-exempt transmitter(s)/receiver(s) that comply with Innovation, Science and Economic Development Canada's licence-exempt RSS(s). Operation is subject to the following two

9 EN

conditions:

- 1.This device may not cause interference.
- 2.This device must accept any interference, including interference that may cause undesired operation of the device.

L'émetteur/récepteur exempt de licence contenu dans le présent appareil est conforme aux CNR d'Innovation, Sciences et Développement économique Canada applicables aux appareils radio exempts de licence. L'exploitation est autorisée aux deux conditions suivantes :

1. L'appareil ne doit pas produire de brouillage;
2. L'appareil doit accepter tout brouillage radioélectrique subi, même si le brouillage est susceptible d'en compromettre le fonctionnement.

This equipment complies with ISED RSS-102 radiation exposure limits set forth for an uncontrolled environment.

This equipment should be installed and operated with a minimum distance of 20cm between the radiator and any part of your body.

EN10

Pour se conformer aux exigences de conformité CNR 102 RF exposition, une distance de séparation d'au moins 20 cm doit être maintenue entre l'antenne de cet appareil et toutes les personnes.



## NEED HELP?

Email our support team:  
[support@iwinees.com](mailto:support@iwinees.com)

Linkzone Technology Co., Limited  
Room 510, 5/F, Wayson Commercial  
Building, 28 Connaught Road West,  
Sheung Wan, Hong Kong, China  
Phone: 1-855-334-9800  
Website: [www.iwinees.com](http://www.iwinees.com)

**Made in China**

11EN



Help Center

# DE INHALT

**13** IN DER BOX

PRODUKTÜBERSICHT **14**

**15** EINRICHTUNG

INSTALLATION **16**

**19** LEUCHTANZEIGEN

WARNUNGEN **19**

**21** BRAUCHEN SIE HILFE



## IN DER BOX



Kamera



Netzadapter



Netzkabel

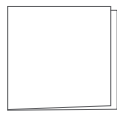

Gebrauchsanweisung

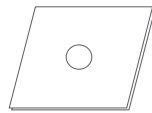

3M Bänder



Schrauben

13DE

## PRODUKTÜBERSICHT

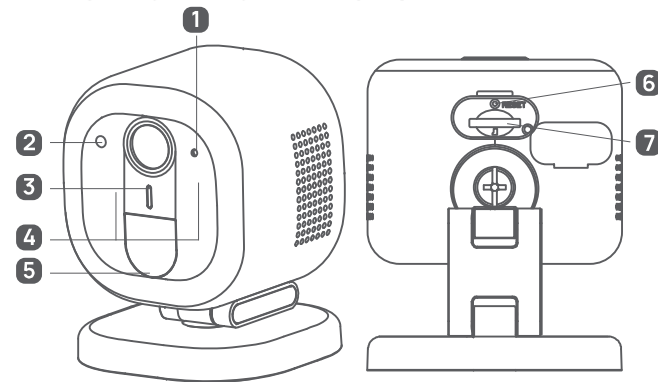

- 1. Mic
- 2. Lichtsensor
- 3. Statuslicht
- 4. IR LED
- 5. Scheinwerferlicht (Nur in M3Plus)
- 6. Rückstattaste
- 7. Micro-SD-Kartensteckplatz

DE14

## EINRICHTUNG

1. Scannen Sie den QR-Code unten, um die AiDot APP herunterzuladen.



Oder suchen Sie im App Store oder bei Google Play nach



2. Schalten Sie die Kamera ein. Sie hören "Waiting for Wi-Fi configuration" (Warten auf Wi-Fi-Konfiguration) und die Anzeileuchte der Kamera blinkt grün.

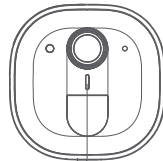

LED-Anzeige blinkt grün

3. Drücken Sie in der AiDot-App auf "+" - "Geräte", wählen Sie Winees M3Plus/M3 Kamera und folgen Sie den Anweisungen in der



15DE

4. Platzieren Sie den M3Plus/M3 Kamera in dem Bereich, in dem Sie die Installation planen, um die Videoqualität zu testen und sicherzustellen, dass die Kamera nach der endgültigen Installation normal funktioniert.

## INSTALLATION

● Installation an der Wand  
Für eine bessere Benutzererfahrung empfehlen wir Ihnen, die Kamera unter den unten aufgeführten Bedingungen zu installieren.

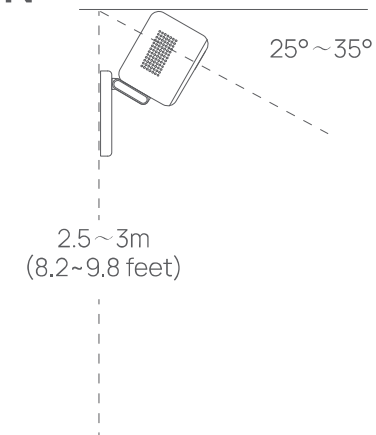

DE16

Auf einer gemauerten Oberfläche (3M-Klebeband kann zur Fixierung der Position vor dem Eindrehen der Schrauben verwendet werden)

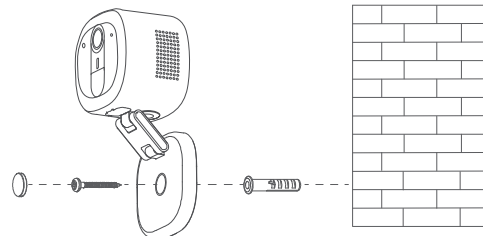

Auf einer hölzernen Oberfläche (3M-Klebeband kann zur Fixierung der Position vor dem Eindrehen der Schrauben verwendet werden)

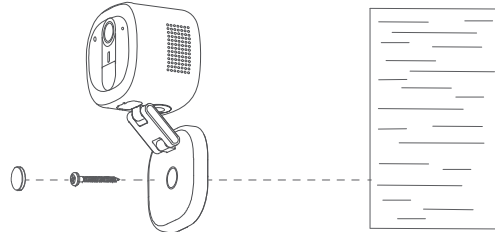

17 DE

■ Installation an der Decke (3M-Klebeband kann verwendet werden, um die Position zu fixieren, bevor die Schrauben eingeschlagen werden)

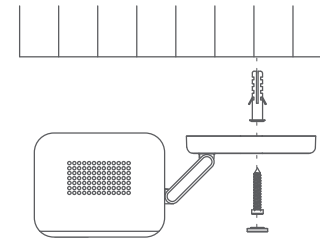

■ Auf den Tisch oder eine andere flache Oberfläche legen (3M-Klebeband kann zur Fixierung der Position verwendet werden)

DE18

## LEUCHTANZEIGEN

Status	Beschreibung
Einfarbig rot	Einschalten/Systemstart/ Werksrücksetzung
Rot blinkend	Drahtlose Verbindung, Cloud- Verbindung fehlgeschlagen
Einfarbig grün	Drahtlos verbunden
Grün blinkend	System bereit für WiFi-Setup / Firmware-Update
Rot und Grün blinken abwechselnd	Keine Verbindung zur Cloud möglich

## WARNUNGEN

Um Verletzungen und/oder mögliche Produktschäden zu vermeiden, müssen die folgenden Vorsichtsmaßnahmen befolgt werden:

1. Bitte verwenden Sie stattdessen den mitgelieferten Adapter  
andere im Falle einer Beschädigung des Produkts.
2. Außerhalb der Reichweite von Kindern aufbewahren.  
Dieses Produkt enthält  
kleine Magnete und andere Kleinteile, die verursachen  
können

19DE

Verschlucken oder Verletzungen bei Verschlucken.  
3. Um einen vorzeitigen Ausfall zu verhindern, sollte die  
Kamera nur sein  
installiert in Betriebsumgebungen zwischen  
-20 °C ~ 50 °C (-4 °F ~ 122 °F).

4. Nicht installieren  
- in der Nähe einer Wärmequelle  
- in der Nähe von Metallgegenständen und Spiegeln, die  
eine Dämpfung oder Abschattung des Funksignals  
verursachen.

Um Verletzungen und/oder mögliche Produktschäden zu  
5. Bauen Sie die Kamera andernfalls nicht auseinander  
und installieren Sie sie nicht neu  
Dies kann Sicherheitsrisiken verursachen.

6. Ziehen Sie vor der Reinigung das Netzkabel ab. Nicht  
säubern  
die Kamera mit Flüssigkeiten, Sprühreiniger oder einem  
feuchten Tuch.

7. Der Schlitz und die Öffnung dienen der Belüftung,  
nicht  
darf gesperrt oder abgedeckt werden.

8. Dieses Produkt kann nur mit 2,4 G WIFI verbunden  
werden.



## BRAUCHEN SIE HILFE

Kontaktieren Sie unser Support-Team:  
[support@iwinees.com](mailto:support@iwinees.com)

**UK**  
**REP** Business name: APEX CE SPECIALISTS LIMITED  
Business address: 89 Princess Street,  
Manchester, M1 4HT, UK  
Email: [info@apex-ce.com](mailto:info@apex-ce.com)  
Tel: +441616371080

**EU**  
**REP** Business name: APEX CE SPECIALISTS LIMITED  
Business address: UNIT 3D NORTH POINT HOUSE, NORTH POINT  
BUSINESS PARK, NEW MALLOW ROAD, CORK, T23 AT2P, IRELAND  
Email: [info@apex-ce.com](mailto:info@apex-ce.com)  
Tel: +35 321 2066339

**Linkzone Technology Co., Limited ROOM**  
Raum 510, 5/F, Wayson Commercial Building,  
28 Connaught Road West, Sheung Wan,  
Hongkong, China  
Phone: 1-855-334-9800  
Website: [www.iwinees.com](http://www.iwinees.com)  
**Made in China**

21DE



Help Center

# JP

## 目次

**23** パッケージ内容

製品概要 **24**

**25** アプリセットアップ

インストール **26**

**28** ライトインジケーター

注意 **29**

**31** 助けが必要?

## パッケージ内容

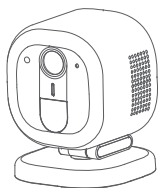

カメラ



電源アダプター



電源ケーブル



ユーザーマニュアル

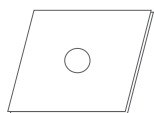

3Mテープ

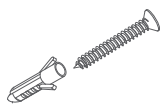

ネジ

23JP

## 製品概要

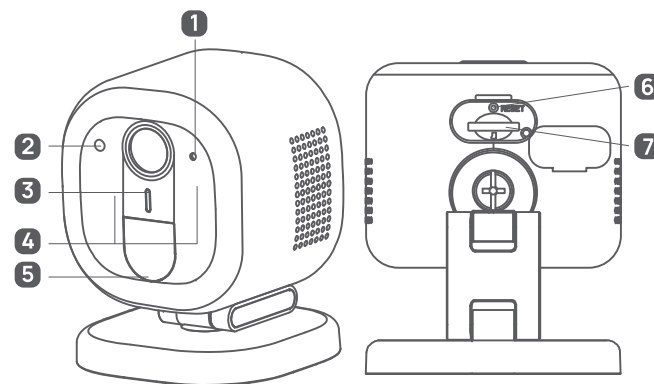

1. マイク
2. ライトセンサー
3. ライトインジケータ
4. IR LED
5. M3 plusのみ

6. リセットボタン
7. マイクロSDカードスロット

JP 24

## アプリセットアップ

1. 下記のQRコードを読み取ってください。



または、App StoreまたはGoogle Playで「AiDot」を検索してください。



2. カメラの電源を入れると、「Waiting for Wi-Fi configuration」の提示音が鳴り、本体のLED状態ライトが緑に点滅します。

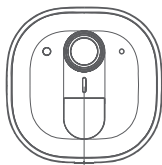

LED状態ライトが緑に点滅

3. AiDotアプリで、「+」-「デバイス」を押し、M3 plus or M3 カメラを選択し、画面の指示に従って操作してください。



25 JP

4. M3 plus or M3 カメラの設置位を決めたら、設置する前に必ずアプリで画質の角度・画質をテストし、ニーズに応じて調整してください。そうすることで、設置完成後の調整の手間を省くことができます。

## インストール

### ● 壁面に設置

より快適にお使いいただくために、以下の条件でカメラを設置することをお勧めします。

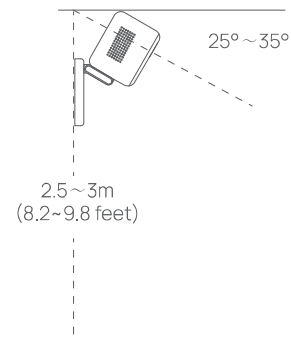

JP26

石造りの表面 (3Mテープで位置を固定してからネジを打ち込むことができます。)

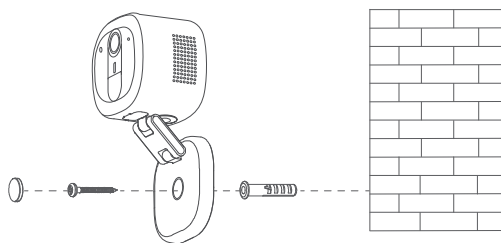

木製の場合 (3Mテープで固定し、ネジを打ち込む)

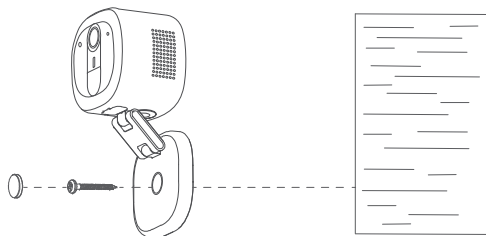

27JP

● 天井に設置 (3Mテープはねじ込み前に位置を固定するために使用することができます。)

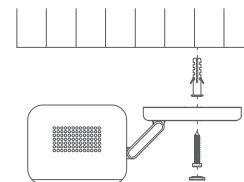

● テーブルまたは他の平らな面に置きます (3Mテープを使用して位置を固定できます)

## ライトインジケータ

状態	説明
赤色で点灯	電源オン/システム起動/工場出荷時設定
赤色で点滅	無線接続、クラウド接続ができない
緑色で点灯	無線接続成功
緑色で点滅	WiFi接続できる状態 / ファームウェア更新
赤と緑が交互に点滅	クラウドに接続できない

JP 28



## 注意

人身事故や製品破損を防ぐため、以下の注意事項を必ず守ってください。

- 1.万一、破損した場合は、付属のアダプターを代用してください。
- 2.子供の手の届かないところに保管してください。本製品には小さな磁石などの部品が使われており、飲み込むと窒息、けがをしたりする可能性があります。
- 3.早期故障を防ぐため、カメラは-20°C～50°C (-4°F～122°F)の範囲の動作環境にのみ設置してください。
- 4.下記の設置場所は避けてください。
  - 熱源に近い場所
  - 電波の減衰や遮光の原因となる金属物や鏡の近くには設置しないでください。
- 5.カメラ本体分解をしたり、改造したりしないでください(故障の原因となります)

29 JP

6.お手入れの際は、必ず電源コードを抜いてください。また、液体やスプレークリーナー、濡れた布などでカメラを拭かないでください(故障や感電の恐れがあります)。

7.スロットや開口部は熱の蓄積を防ぐため、カメラ周辺の空気循環を遮断しないでください。

8.本製品は、2.4G WIFIのみ接続可能です。

JP 30

## 助けが必要?

サポートチームへお問い合わせください。  
[support@iwinees.com](mailto:support@iwinees.com)

**Linkzone Technology Co., Limited**  
Room 510, 5/F, Wayson Commercial  
Building, 28 Connaught Road West,  
Sheung Wan, Hong Kong, China  
Phone: 1-855-334-9800  
Website: [www.iwinees.com](http://www.iwinees.com)  
中国製



Help Center

骑马钉

材质：105G铜版纸

尺寸：80\*80mm

展开尺寸：160\*80mm

印刷方式：单黑双面印刷、过光膜

\*红字部分不印刷

;  
**FCC WARNING**

This device complies with part 15 of the FCC Rules. Operation is subject to the following two conditions: (1) this device may not cause harmful interference, and (2) this device must accept any interference received, including interference that may cause undesired operation.

Any changes or modifications not expressly approved by the party responsible for compliance could void the user's authority to operate the equipment.

**NOTE:** This equipment has been tested and found to comply with the limits for a Class B digital device, pursuant to Part 15 of the FCC Rules. These limits are designed to provide reasonable protection against harmful interference in a residential installation. This equipment generates, uses and can radiate radio frequency energy and, if not installed and used in accordance with the instructions, may cause harmful interference to radio communications. However, there is no guarantee that interference will not occur in a particular installation.

If this equipment does cause harmful interference to radio or television reception, which can be determined by turning the equipment off and on, the user is encouraged to try to correct the interference by one or more of the following measures:

- Reorient or relocate the receiving antenna.
- Increase the separation between the equipment and receiver.
- Connect the equipment into an outlet on a circuit different from that to which the receiver is connected.
- Consult the dealer or an experienced radio/TV technician for help.

To maintain compliance with FCC's RF Exposure guidelines, This equipment should be installed and operated with minimum 20cm distance between the radiator and your body: Use only the supplied antenna.