

6 Safety Human Exposure

6.1 Radio Frequency Exposure Compliance

6.1.1 Electromagnetic Fields

RESULT:
Pass
Test Specification

 Test standard : CFR47 FCC Part 2: Subpart J Section 1.1310
 FCC CFR 47 Part 1(1.1310) KDB 680106 D01 v03

According to the table 1 of FCC Part 2.1310, the reference limit as below:

Frequency range (MHz)	Electric field strength (V/m)	Magnetic field strength (A/m)	Power density (mW/cm ²)	Averaging time (minutes)
(A) Limits for Occupational/Controlled Exposure				
0.3-3.0	614	1.63	*100	6
3.0-30	1842/f	4.89/f	*900/f ²	6
30-300	61.4	0.163	1.0	6
300-1,500			f/300	6
1,500-100,000			5	6
(B) Limits for General Population/Uncontrolled Exposure				
0.3-1.34	614	1.63	*100	30
1.34-30	824/f	2.19/f	*180/f ²	30
30-300	27.5	0.073	0.2	30
300-1,500			f/1500	30
1,500-100,000			1.0	30

f = frequency in MHz * = Plane-wave equivalent power density

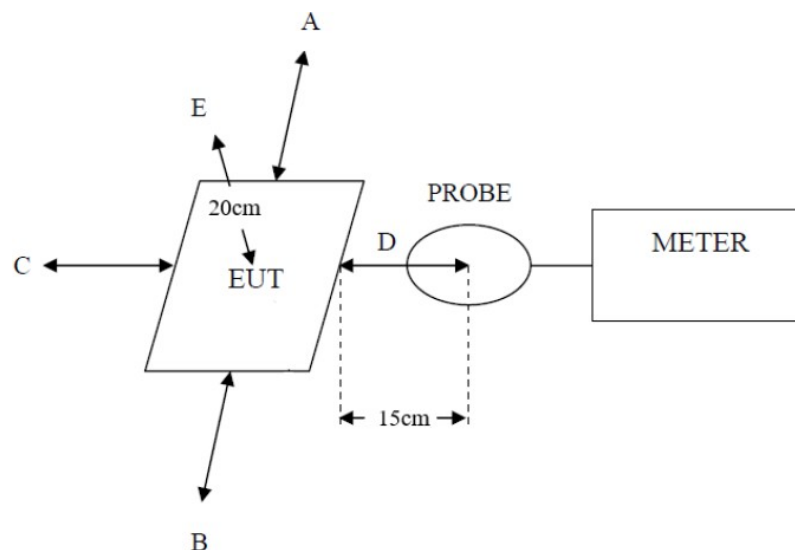
Test Setup:

Test Result:

Table: H-Field Strength at 15 cm from the edges surrounding the EUT and 20cm from the top surface of the EUT

EUT Test Mode	Measured H-Field Strength Values (A/m)					50% Limit (A/m)	Limit (A/m)	Result
	Test Position Top	Test Position front	Test Position rear	Test Position left	Test Position right			
10% Battery Level	0.183	0.182	0.182	0.184	0.182	0.815	1.63	Pass
50% Battery Level	0.171	0.175	0.165	0.176	0.176	0.815	1.63	Pass
90% Battery Level	0.152	0.165	0.146	0.169	0.169	0.815	1.63	Pass