

## FCC Certification Test Report

**Report No.:** FCBHDC-WTW-P20120816 R1

**Test Model:** F-41B

**FCC ID:** 2AYY9FMP182

**Received Date:** Dec. 24, 2020

**Test Date:** Dec. 31, 2020 ~ Jan. 01, 2021

**Issued Date:** Mar. 03, 2021

**Applicant:** FCNT Limited

**Address:** Chuorinkan 7-10-1 Yamato, Kanagawa 242-0007, Japan

**Issued By:** Bureau Veritas Consumer Products Services (H.K.) Ltd., Taoyuan Branch  
Lin Kou Laboratories

**Lab Address:** No. 47-2, 14th Ling, Chia Pau Vil., Lin Kou Dist., New Taipei City, Taiwan

**Test Location:** No. 19, Hwa Ya 2nd Rd., Wen Hwa Vil., Kwei Shan Dist., Taoyuan City  
33383, TAIWAN

**FCC Registration /  
Designation Number:** 328930 / TW1050



This report is for your exclusive use. Any copying or replication of this report to or for any other person or entity, or use of our name or trademark, is permitted only with our prior written permission. This report sets forth our findings solely with respect to the test samples identified herein. The results set forth in this report are not indicative or representative of the quality or characteristics of the lot from which a test sample was taken or any similar or identical product unless specifically and expressly noted. Our report includes all of the tests requested by you and the results thereof based upon the information that you provided to us. You have 60 days from date of issuance of this report to notify us of any material error or omission caused by our negligence, provided, however, that such notice shall be in writing and shall specifically address the issue you wish to raise. A failure to raise such issue within the prescribed time shall constitute your unqualified acceptance of the completeness of this report, the tests conducted and the correctness of the report contents. Unless specific mention, the uncertainty of measurement has been explicitly taken into account to declare the compliance or non-compliance to the specification.

## Table of Contents

<b>Release Control Record .....</b>	<b>3</b>
<b>1 Certificate of Conformity .....</b>	<b>4</b>
<b>2 Summary of Test Results.....</b>	<b>5</b>
2.1 Measurement Uncertainty .....	5
2.2 Modification Record .....	5
<b>3 General Information .....</b>	<b>6</b>
3.1 General Description of EUT .....	6
3.2 Features of EUT .....	6
3.3 Operating Modes of EUT and Determination of Worst Case Operating Mode .....	7
3.4 Test Program Used and Operation Descriptions.....	7
3.5 Primary Clock Frequencies of Internal Source .....	8
<b>4 Configuration and Connections with EUT .....</b>	<b>9</b>
4.1 Connection Diagram of EUT and Peripheral Devices .....	9
4.2 Configuration of Peripheral Devices and Cable Connections .....	10
<b>5 Conducted Emissions at Mains Ports.....</b>	<b>11</b>
5.1 Limits .....	11
5.2 Test Instruments .....	11
5.3 Test Arrangement .....	12
5.4 Test Results.....	13
<b>6 Radiated Emissions up to 1 GHz .....</b>	<b>15</b>
6.1 Limits .....	15
6.2 Test Instruments .....	16
6.3 Test Arrangement .....	17
6.4 Test Results.....	18
<b>7 Radiated Emissions above 1 GHz.....</b>	<b>20</b>
7.1 Limits .....	20
7.2 Test Instruments .....	21
7.3 Test Arrangement .....	22
7.4 Test Results.....	23
<b>8 Pictures of Test Arrangements .....</b>	<b>27</b>
<b>Appendix – Information of the Testing Laboratories .....</b>	<b>28</b>

### Release Control Record

Issue No.	Description	Date Issued
FCBHDC-WTW-P20120816	Original Release	Jan. 11, 2021
FCBHDC-WTW-P20120816 R1	Revising Applicant and FCC ID	Mar. 03, 2021



## 2 Summary of Test Results

47 CFR FCC Part 15, Subpart B / ICES-003:2016 Issue 6, updated Apr. 2019, Class B  
 ANSI C63.4:2014

FCC Clause	ICES-003 Clause	Test Item	Result/Remarks	Verdict
15.107	6.1	AC Power Line Conducted Emissions	Minimum passing Class B margin is -12.64 dB at 0.15000 MHz	Pass
15.109	6.2.1	Radiated Emissions up to 1 GHz	Minimum passing Class B margin is -3.71 dB at 178.51 MHz	Pass
	6.2.2	Radiated Emissions above 1 GHz	Minimum passing Class B margin is -12.41 dB at 26340.94 MHz	Pass

Note:

1. There is no deviation to the applied test methods and requirements covered by the scope of this report.
2. Determining compliance based on the results of the compliance measurement, not taking into account measurement instrumentation uncertainty.

### 2.1 Measurement Uncertainty

Where relevant, the following measurement uncertainty levels have been estimated for tests performed on the EUT:

Measurement	Frequency	Expanded Uncertainty (k=2) ( $\pm$ )
Conducted Emissions at mains ports	150 kHz ~ 30 MHz	2.79 dB
Radiated Emissions up to 1 GHz	30 MHz ~ 1 GHz	4.14 dB
Radiated Emissions above 1 GHz	Above 1 GHz	5.04 dB

### 2.2 Modification Record

There were no modifications required for compliance.

### 3 General Information

#### 3.1 General Description of EUT

Product	Smart Phone
Brand	FUJITSU
Test Model	F-41B
FCC ID	2AYY9FMP182
Status of EUT	Engineering Sample
Operating Software	Android 11
Power Supply Rating	3.85 Vdc (Battery) 5 Vdc (Adapter)
Accessory Device	Refer to Note as below
Data Cable Supplied	N/A

Note:

1. The EUT contains following accessory devices.

Product	Brand	Model	Description
Adapter	NTT docomo	AC adaptor 06	I/P: 100-240 Vac, 50/60 Hz, 0.8 A O/P: 5 Vdc, 3 A
Battery	N/A	CA54310-0081	3.85 Vdc, 3500 mAh, 13.47Wh

#### 3.2 Features of EUT

The tests reported herein were performed according to the method specified by FCNT Limited, for detailed feature description, please refer to the manufacturer's specifications or user's manual.

### 3.3 Operating Modes of EUT and Determination of Worst Case Operating Mode

Test modes are presented in the report as below.

Mode	Test Condition
	Conducted Emission
1	GSM850 Link + BT Link + WLAN (2.4G) Link + GPS Rx + Earphone + Adapter
2	WCDMA1900 Link + BT Link + WLAN (5G) Link + GPS Rx + Earphone + Adapter
3	LTE Band5 Link + BT Link + WLAN (5G) Link + Camera + Earphone + Adapter
4	PCS1900 Idle + BT Link + WLAN (5G) Link + MPEG4 + USB Cable + Earphone + USB Link
5	GSM850 Rx (Low Channel) + Earphone + Adapter
6	GSM850 Rx (Middle Channel) + Earphone + Adapter
7	GSM850 Rx (High Channel) + Earphone + Adapter
8	LTE Band12 Rx (Low Channel) + Earphone + Adapter
9	LTE Band12 Rx (Middle Channel) + Earphone + Adapter
10	LTE Band12 Rx (High Channel) + Earphone + Adapter
	Radiated Emission
1	GSM850 Link + BT Link + WLAN (2.4G) Link + GPS Rx + Earphone + Adapter
2	WCDMA1900 Link + BT Link + WLAN (5G) Link + Camera + Earphone + Adapter
3	LTE Band5 Link + BT Link + WLAN (2.4G) Link + MPEG4 + USB Cable + Earphone + USB Link
4	PCS1900 Idle + BT Link + WLAN (2.4G) Link + NFC On (Stand alone)
5	GSM850 Rx (Low Channel) + Earphone + Adapter
6	GSM850 Rx (Middle Channel) + Earphone + Adapter
7	GSM850 Rx (High Channel) + Earphone + Adapter
8	LTE Band12 Rx (Low Channel) + Earphone + Adapter
9	LTE Band12 Rx (Middle Channel) + Earphone + Adapter
10	LTE Band12 Rx (High Channel) + Earphone + Adapter
11	LTE Band5 Link + BT Link + WLAN (2.4G) Link + MPEG4 + USB Cable + Earphone + USB Link (X Axis)
12	LTE Band5 Link + BT Link + WLAN (2.4G) Link + MPEG4 + USB Cable + Earphone + USB Link (Y Axis)

Remark:

- For conducted emission test, we had pre-tested all modes at 120V/60Hz and 240V/60Hz, test mode 2 at 240V/60Hz was the worst case and only this mode was presented in the report.
- For radiated emission test, we had pre-tested all modes at 120V/60Hz and 240V/60Hz, test mode 3 at 120V/60Hz was the worst case and only this mode was presented in the report.

### 3.4 Test Program Used and Operation Descriptions

#### For Conducted Emission

- The EUT was charged from adapter via USB cable.
- The EUT linked with Bluetooth earphone.
- The EUT sent audio signal to the earphone.
- The EUT communicated data with the Radio Communication Analyzer, GPS simulator and Wireless AP, which acted as communication partners.

### **For Radiated Emission**

- a. The EUT was charged from notebook via USB cable.
- b. The EUT linked with Bluetooth earphone.
- c. The EUT sent audio signal to the earphone.
- d. The EUT communicated data with the Radio Communication Analyzer and Wireless AP, which acted as communication partners.

### **3.5 Primary Clock Frequencies of Internal Source**

The highest frequency generated or used within the EUT or on which the EUT operates or tunes is 5 GHz, provided by FCNT Limited, for detailed internal source, please refer to the manufacturer's specifications.



## 4 Configuration and Connections with EUT

### 4.1 Connection Diagram of EUT and Peripheral Devices

#### For Conducted Emission

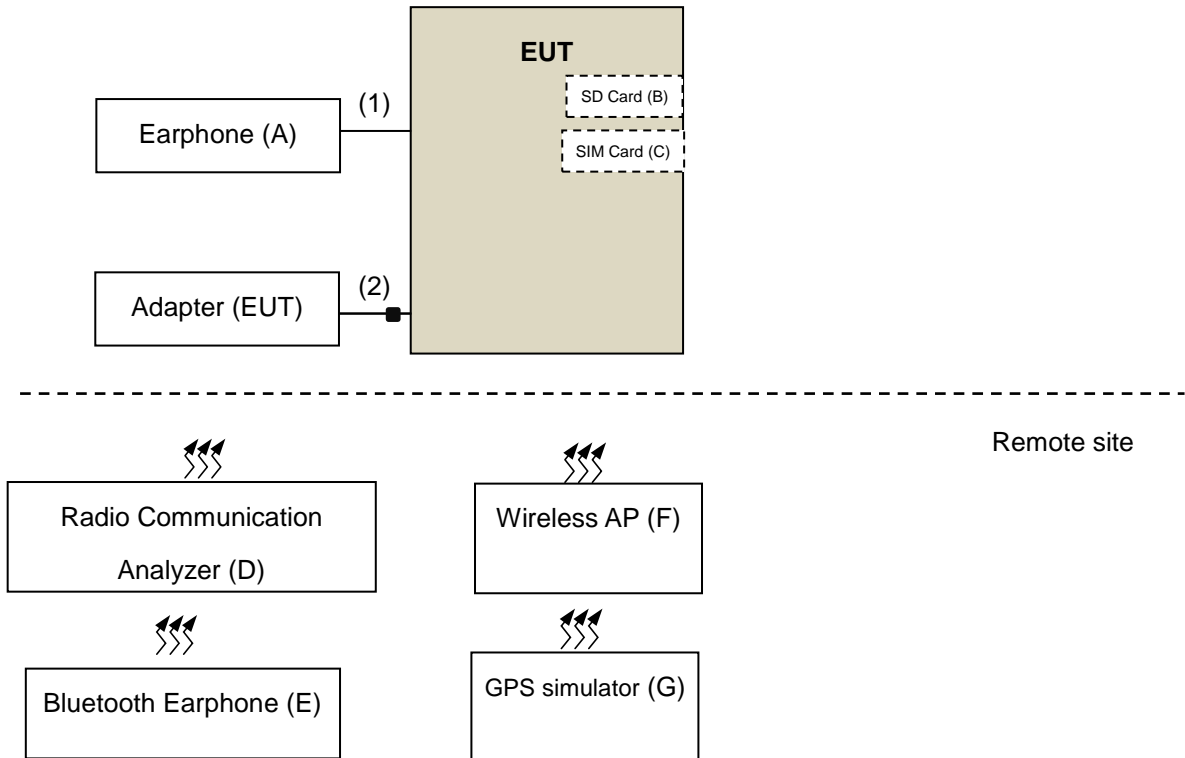

#### For Radiated Emission

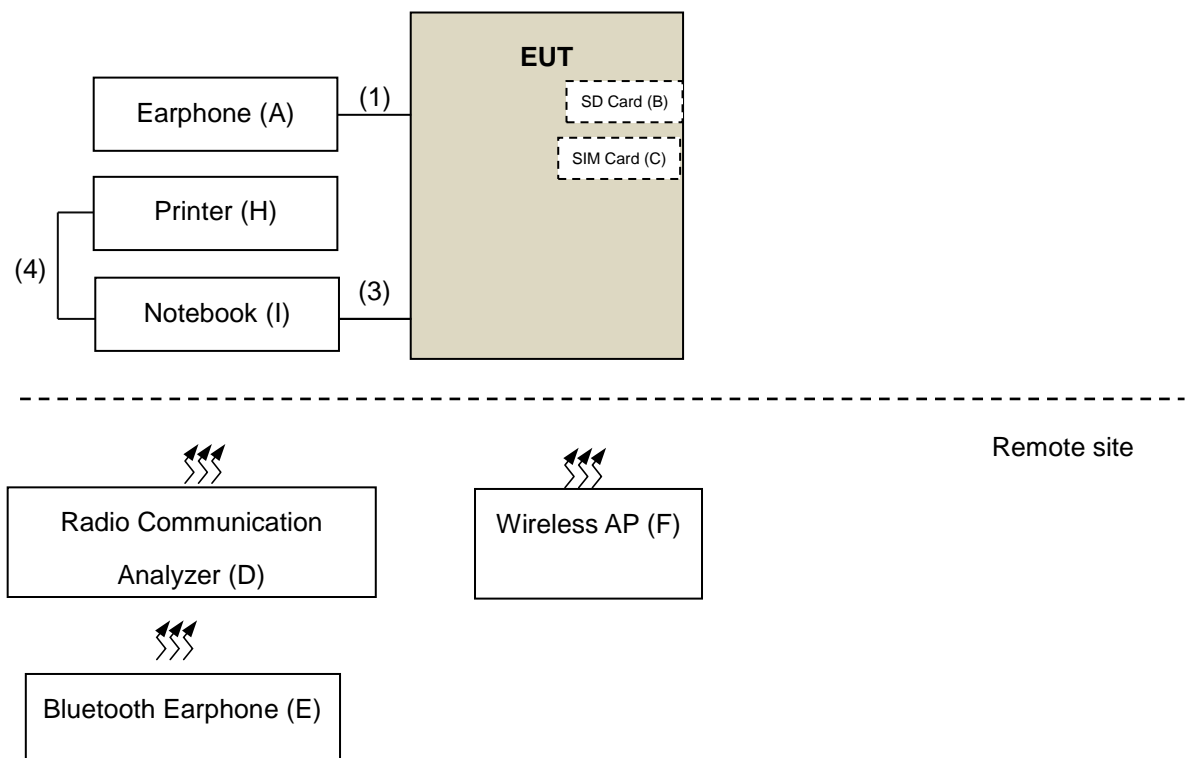

#### 4.2 Configuration of Peripheral Devices and Cable Connections

ID	Product	Brand	Model No.	Serial No.	FCC ID	Remarks
A.	EARPHONE	Apple	MB770FE/B	N/A	N/A	--
B.	SD Card	Sandisk	N/A	N/A	N/A	16GB
C.	SIM Card	R&S	N/A	N/A	N/A	--
D.	Radio Communication Analyzer	Anritsu	MT8820C	6201010284	N/A	--
E.	BLUETOOTH EARPHONE	ELECOM	LBT-MPHS400	N/A	N/A	--
F.	D-LINK DIR-826L 11a/n USB 1000M Router	D-LINK	DIR826L	QBQ91C9000416	N/A	--
G.	GPS simulator	PENDULUM	GSG-54	191121	N/A	--
H.	PRINTER	EPSON	T22	MEEZ070388	N/A	--
I.	Notebook	DELL	Latitude 5501	F42VP13	N/A	--

Note:

1. All power cords of the above support units are non-shielded (1.8m).
2. Items I acted as communication partners to transfer data.

ID	Cable Descriptions	Qty.	Length (m)	Shielding (Yes/No)	Cores (Qty.)	Remarks
1.	Earphone Cable	1	1.2	N	0	--
2.	Adapter Cable	1	1.15	Y	1	Accessory of the EUT
3.	USB Cable	1	1.2	Y	0	--
4.	USB Cable	1	1	Y	0	--

Note: The core(s) is(are) originally attached to the cable(s).

## 5 Conducted Emissions at Mains Ports

### 5.1 Limits

Frequency (MHz)	Class A (dBuV)		Class B (dBuV)	
	Quasi-peak	Average	Quasi-peak	Average
0.15 - 0.5	79	66	66 - 56	56 - 46
0.50 - 5.0	73	60	56	46
5.0 - 30.0	73	60	60	50

- Notes: 1. The lower limit shall apply at the transition frequencies.  
 2. The limit decreases linearly with the logarithm of the frequency in the range of 0.15 to 0.50 MHz.

### 5.2 Test Instruments

Description & Manufacturer	Model No.	Serial No.	Cal. Date	Cal. Due
Test Receiver ROHDE & SCHWARZ	ESCI	100613	Dec. 04, 2020	Dec. 03, 2021
RF signal cable Woken	5D-FB	Cable-cond1-01	Sep. 04, 2020	Sep. 03, 2021
LISN ROHDE & SCHWARZ (EUT)	ENV216	101826	Feb. 20, 2020	Feb. 19, 2021
LISN ROHDE & SCHWARZ (Peripheral)	ESH3-Z5	100311	Aug. 28, 2020	Aug. 27, 2021
Software ADT	BV ADT_Cond_ V7.3.7.4	NA	NA	NA

- Note: 1. The calibration interval of the above test instruments is 12 months and the calibrations are traceable to NML/ROC and NIST/USA.  
 2. The test was performed in HwaYa Shielded Room 1. (Conduction 1)  
 3. The VCCI Site Registration No. is C-12040.

### 5.3 Test Arrangement

- The EUT was placed 0.4 meters from the conducting wall of the shielded room with EUT being connected to the power mains through a line impedance stabilization network (LISN). Other support units were connected to the power mains through another LISN. The two LISNs provide 50 Ohm/ 50 uH of coupling impedance for the measuring instrument.
- Both lines of the power mains connected to the EUT were checked for maximum conducted interference.
- The test results of conducted emissions at mains ports are recorded of six worst margins for quasi-peak (mandatory) [and average (if necessary)] values against the limits at frequencies of interest unless the margin is 20 dB or greater.

Note: The resolution bandwidth and video bandwidth of test receiver is 9 kHz for quasi-peak detection (QP) and average detection (AV) at frequency 0.15 MHz – 30 MHz.

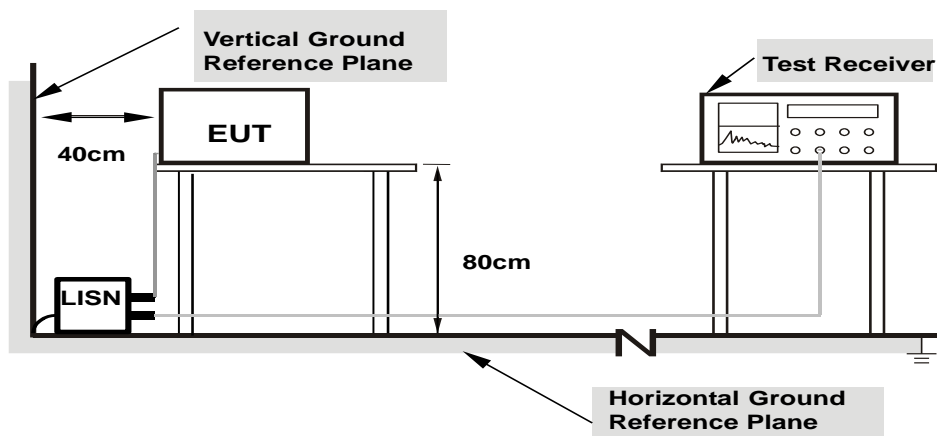

- Note: 1. Support units were connected to second LISN.**  
**2. Both of LISNs (AMN) are 80 cm from EUT and at least 80 cm from other units and other metal planes**

### 5.4 Test Results

<b>Frequency Range</b>	150kHz ~ 30MHz	<b>Detector Function &amp; Resolution Bandwidth</b>	Quasi-Peak (QP) / Average (AV), 9kHz
<b>Input Power</b>	240Vac, 60Hz	<b>Environmental Conditions</b>	11°C, 66%RH
<b>Tested by</b>	Slash Huang	<b>Test Date</b>	2020/12/31
<b>Test Mode</b>	Mode 2		

Phase Of Power : Line (L)										
No	Frequency (MHz)	Correction Factor (dB)	Reading Value (dBuV)		Emission Level (dBuV)		Limit (dBuV)		Margin (dB)	
			Q.P.	AV.	Q.P.	AV.	Q.P.	AV.	Q.P.	AV.
1	0.17400	9.83	41.21	18.91	51.04	28.74	64.77	54.77	-13.73	-26.03
2	0.23000	9.85	36.34	16.98	46.19	26.83	62.45	52.45	-16.26	-25.62
3	0.28600	9.86	32.15	13.67	42.01	23.53	60.64	50.64	-18.63	-27.11
4	3.68600	9.99	32.46	20.78	42.45	30.77	56.00	46.00	-13.55	-15.23
5	4.09800	10.00	32.44	20.38	42.44	30.38	56.00	46.00	-13.56	-15.62
6	4.51400	10.01	31.85	20.53	41.86	30.54	56.00	46.00	-14.14	-15.46

**Remarks:**

1. Q.P. and AV. are abbreviations of quasi-peak and average individually.
2. The emission levels of other frequencies were very low against the limit.
3. Margin value = Emission level – Limit value
4. Correction factor = Insertion loss + Cable loss
5. Emission Level = Correction Factor + Reading Value

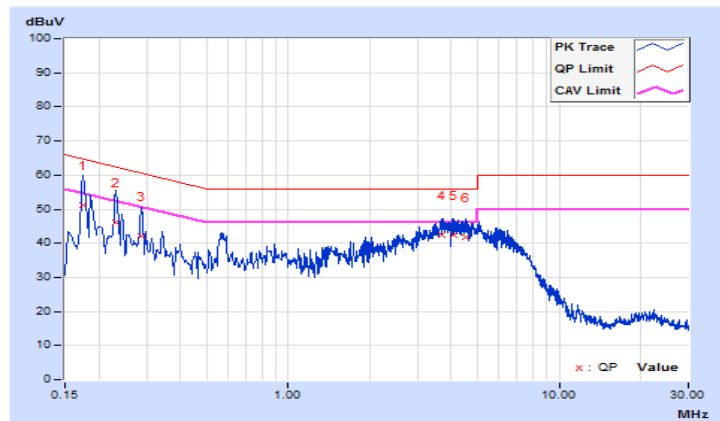

<b>Frequency Range</b>	150kHz ~ 30MHz	<b>Detector Function &amp; Resolution Bandwidth</b>	Quasi-Peak (QP) / Average (AV), 9kHz
<b>Input Power</b>	240Vac, 60Hz	<b>Environmental Conditions</b>	11°C, 66%RH
<b>Tested by</b>	Slash Huang	<b>Test Date</b>	2020/12/31
<b>Test Mode</b>	Mode 2		

Phase Of Power : Neutral (N)										
No	Frequency (MHz)	Correction Factor (dB)	Reading Value (dBuV)		Emission Level (dBuV)		Limit (dBuV)		Margin (dB)	
			Q.P.	AV.	Q.P.	AV.	Q.P.	AV.	Q.P.	AV.
1	0.15000	9.84	43.52	20.23	53.36	30.07	66.00	56.00	-12.64	-25.93
2	0.20600	9.85	38.04	16.80	47.89	26.65	63.37	53.37	-15.48	-26.72
3	0.26200	9.87	33.35	12.97	43.22	22.84	61.37	51.37	-18.15	-28.53
4	0.31800	9.88	28.66	8.38	38.54	18.26	59.76	49.76	-21.22	-31.50
5	3.76600	10.04	28.08	16.00	38.12	26.04	56.00	46.00	-17.88	-19.96
6	4.65800	10.05	30.97	16.93	41.02	26.98	56.00	46.00	-14.98	-19.02

**Remarks:**

1. Q.P. and AV. are abbreviations of quasi-peak and average individually.
2. The emission levels of other frequencies were very low against the limit.
3. Margin value = Emission level – Limit value
4. Correction factor = Insertion loss + Cable loss
5. Emission Level = Correction Factor + Reading Value

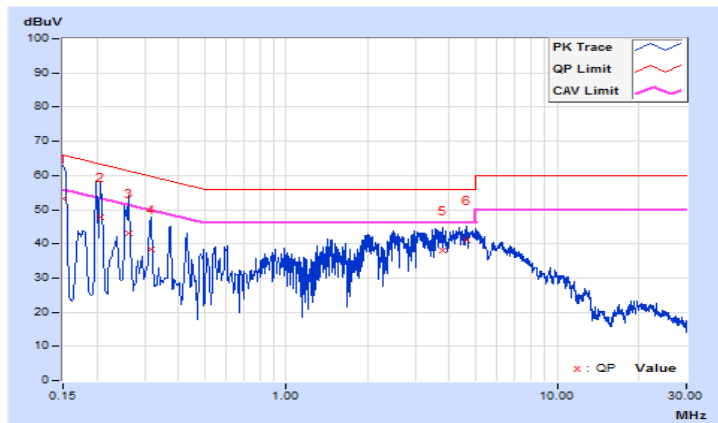

## 6 Radiated Emissions up to 1 GHz

### 6.1 Limits

Emissions radiated outside of the specified bands, shall be according to the general radiated limits as following:

Radiated Emissions Limits at 10 meters (dB $\mu$ V/m)				
Frequencies (MHz)	FCC 15B / ICES-003, Class A	FCC 15B / ICES-003, Class B	CISPR 22, Class A	CISPR 22, Class B
30-88	39	29.5	40	30
88-216	43.5	33.1		
216-230	46.4	35.6		
230-960			47	37
960-1000	49.5	43.5		

Radiated Emissions Limits at 3 meters (dB $\mu$ V/m)				
Frequencies (MHz)	FCC 15B / ICES-003, Class A	FCC 15B / ICES-003, Class B	CISPR 22, Class A	CISPR 22, Class B
30-88	49.5	40	50.5	40.5
88-216	54	43.5		
216-230	56.9	46		
230-960			57.5	47.5
960-1000	60	54		

#### Notes:

1. The lower limit shall apply at the transition frequencies.
2. Emission level (dB $\mu$ V/m) = 20 log Emission level ( $\mu$ V/m).
3. QP detector shall be applied if not specified.

## 6.2 Test Instruments

Description & Manufacturer	Model No.	Serial No.	Cal. Date	Cal. Due
Test Receiver ROHDE & SCHWARZ (V)	ESR	101240	Oct. 30, 2020	Oct. 29, 2021
Test Receiver ROHDE & SCHWARZ (H)	ESR	101264	Apr. 16, 2020	Apr. 15, 2021
BILOG Antenna SCHWARZBECK (V)	VULB9168	9168-148	Nov. 05, 2020	Nov. 04, 2021
BILOG Antenna SCHWARZBECK (H)	VULB9168	9168-156	Nov. 05, 2020	Nov. 04, 2021
Preamplifier Sonoma (V)	310N	352924	Jun. 08, 2020	Jun. 07, 2021
Preamplifier Sonoma (H)	310N	352923	Jun. 08, 2020	Jun. 07, 2021
RF signal cable (with 5dB PAD) Times (V)	LMR-600 (18M) +LMR-400 (7M)	CABLE-CH1 (VER) -01	Sep. 04, 2020	Sep. 03, 2021
RF signal cable (with 5dB PAD) Times (H)	LMR-600 (11.8M) +LMR-400 (7M)	CABLE-CH1 (HOR) -01	Sep. 04, 2020	Sep. 03, 2021
Software BV ADT	BV ADT_Radiated_ V8.7.08	NA	NA	NA
Antenna Tower (V)	MFA-440	9707	NA	NA
Antenna Tower (H)	MFA-440	970705	NA	NA
Turn Table	DS430	50303	NA	NA
Controller (V)	MF7802	074	NA	NA
Controller (H)	MF7802	08093	NA	NA

- NOTE: 1. The calibration interval of the above test instruments is 12 months and the calibrations are traceable to NML/ROC and NIST/USA.
2. The test was performed in HwaYa Chamber 1.
3. The VCCI Site Registration No. is R-11893.



### 6.3 Test Arrangement

- The EUT was placed on the top of a rotating table 0.8 meters above the ground at an accredited test facility. The table was rotated 360 degrees to determine the position of the highest radiation.
- The EUT was set 10 meters away from the interference-receiving antenna, which was mounted on the top of a variable-height antenna tower.
- The antenna is a broadband antenna, and its height is varied from one meter to four meters above the ground to determine the maximum value of the field strength. Both horizontal and vertical polarizations of the antenna are set to make the measurement.
- For each suspected emission, the EUT was arranged to its worst case and then the antenna was tuned to heights from 1 meter to 4 meters and the rotatable table was turned from 0 degrees to 360 degrees to find the maximum reading.
- The test-receiver system was set to quasi-peak detect function and specified bandwidth with maximum hold mode when the test frequency is below 1 GHz.

Note: The resolution bandwidth and video bandwidth of test receiver/spectrum analyzer is 120 kHz for quasi-peak detection (QP) at frequency below 1 GHz.

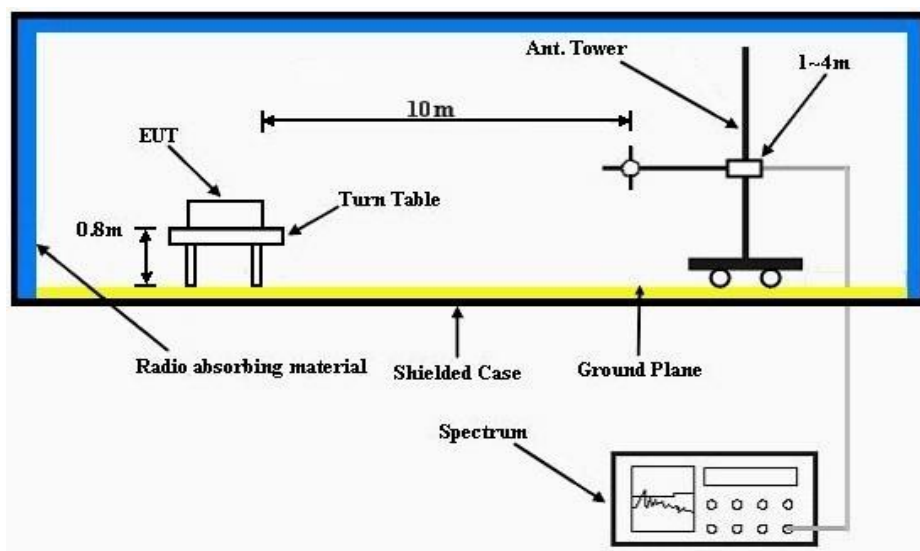

### 6.4 Test Results

<b>Frequency Range</b>	30MHz ~ 1GHz	<b>Detector Function &amp; Resolution Bandwidth</b>	Quasi-Peak (QP), 120kHz
<b>Tested By</b>	Jim Lee	<b>Environmental Conditions</b>	18°C, 66%RH
<b>Test Mode</b>	Mode 3	<b>Test Date</b>	2020/12/31

Antenna Polarity & Test Distance : Horizontal at 10 m								
No	Frequency (MHz)	Emission Level (dBuV/m)	Limit (dBuV/m)	Margin (dB)	Antenna Height (m)	Table Angle (Degree)	Raw Value (dBuV)	Correction Factor (dB/m)
1	155.67	21.68 QP	30.00	-8.32	3.50 H	35	34.81	-13.13
2	193.55	22.32 QP	30.00	-7.68	4.00 H	86	37.71	-15.39
3	228.08	21.26 QP	30.00	-8.74	3.00 H	288	37.13	-15.87
4	456.19	24.59 QP	37.00	-12.41	3.00 H	94	33.01	-8.42
5	703.21	25.85 QP	37.00	-11.15	2.50 H	33	29.88	-4.03
6	754.53	26.85 QP	37.00	-10.15	2.50 H	34	29.40	-2.55

**Remarks:**

1. Emission Level(dBuV/m) = Raw Value(dBuV) + Correction Factor(dB/m)
2. Correction Factor(dB/m) = Antenna Factor (dB/m) + Cable Factor (dB) – Pre-Amplifier Factor (dB)
3. The other emission levels were very low against the limit.
4. Margin value = Emission level – Limit value

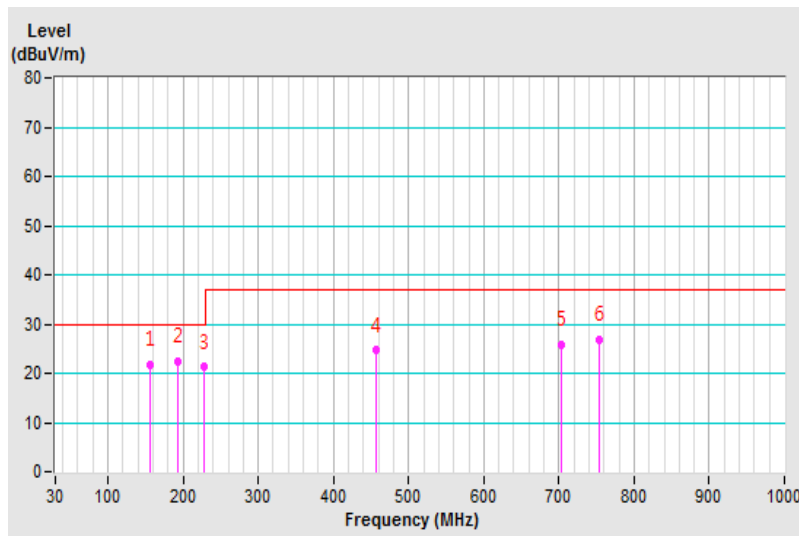

<b>Frequency Range</b>	30MHz ~ 1GHz	<b>Detector Function &amp; Resolution Bandwidth</b>	Quasi-Peak (QP), 120kHz
<b>Tested By</b>	Jim Lee	<b>Environmental Conditions</b>	18°C, 66%RH
<b>Test Mode</b>	Mode 3	<b>Test Date</b>	2020/12/31

Antenna Polarity & Test Distance : Vertical at 10 m								
No	Frequency (MHz)	Emission Level (dBuV/m)	Limit (dBuV/m)	Margin (dB)	Antenna Height (m)	Table Angle (Degree)	Raw Value (dBuV)	Correction Factor (dB/m)
1	39.07	22.17 QP	30.00	-7.83	3.00 V	172	36.44	-14.27
2	158.58	24.49 QP	30.00	-5.51	2.00 V	94	37.65	-13.16
<b>3</b>	<b>178.51</b>	<b>26.29 QP</b>	<b>30.00</b>	<b>-3.71</b>	<b>1.00 V</b>	<b>61</b>	<b>40.80</b>	<b>-14.51</b>
4	194.28	25.62 QP	30.00	-4.38	1.00 V	336	41.75	-16.13
5	228.04	21.98 QP	30.00	-8.02	1.00 V	343	37.98	-16.00
6	456.19	30.94 QP	37.00	-6.06	3.50 V	2	38.74	-7.80

**Remarks:**

1. Emission Level(dBuV/m) = Raw Value(dBuV) + Correction Factor(dB/m)
2. Correction Factor(dB/m) = Antenna Factor (dB/m) + Cable Factor (dB) – Pre-Amplifier Factor (dB)
3. The other emission levels were very low against the limit.
4. Margin value = Emission level – Limit value

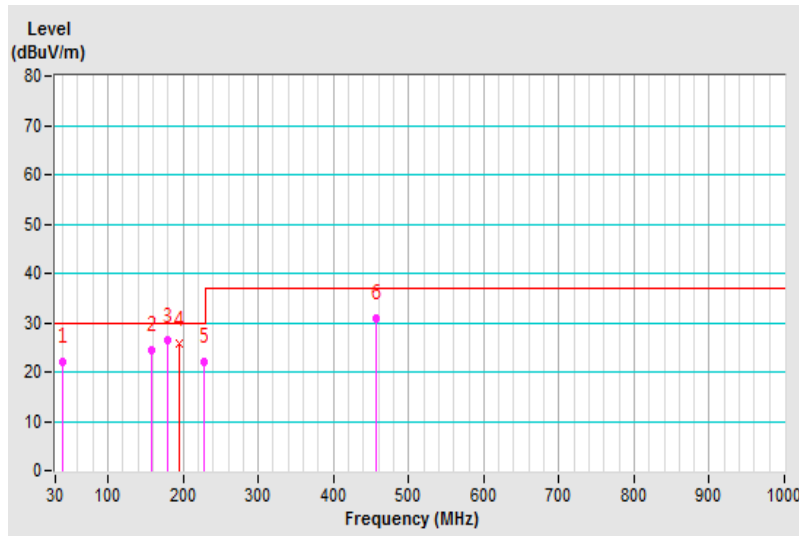

## 7 Radiated Emissions above 1 GHz

### 7.1 Limits

Emissions radiated outside of the specified bands, shall be according to the general radiated limits as following:

Radiated Emissions Limits at 10 meters (dB $\mu$ V/m)				
Frequencies (MHz)	FCC 15B / ICES-003, Class A	FCC 15B / ICES-003, Class B	CISPR 22, Class A	CISPR 22, Class B
1000-3000	Avg: 49.5	Avg: 43.5	Not defined	Not defined
Above 3000	Peak: 69.5	Peak: 63.5	Not defined	Not defined

Radiated Emissions Limits at 3 meters (dB $\mu$ V/m)				
Frequencies (MHz)	FCC 15B / ICES-003, Class A	FCC 15B / ICES-003, Class B	CISPR 22, Class A	CISPR 22, Class B
1000-3000	Avg: 60	Avg: 54	Avg: 56 Peak: 76	Avg: 50 Peak: 70
Above 3000	Peak: 80	Peak: 74	Avg: 60 Peak: 80	Avg: 54 Peak: 74

Notes:

1. The lower limit shall apply at the transition frequencies.
2. Emission level (dB $\mu$ V/m) = 20 log Emission level (uV/m).
3. As shown in 15.35(b), for frequencies above 1000 MHz, the field strength limits are based on average detector, however, the peak field strength of any emission shall not exceed the maximum permitted average limits, specified above by more than 20 dB under any condition of modulation.

Radiated Emissions Limits at 1.5 meters (dB $\mu$ V/m)		
Frequencies (MHz)	FCC 15B / ICES-003, Class A	FCC 15B / ICES-003, Class B
Above 18000	Avg: 66 Peak: 86	Avg: 60 Peak: 80

Note: Limit@1.5m = Limit@3m + 20log(3/1.5)

Frequency Range (For unintentional radiators)

Highest frequency generated or used in the device or on which the device operates or tunes (MHz)	Upper frequency of measurement range (MHz)
Below 1.705	30
1.705-108	1000
108-500	2000
500-1000	5000
Above 1000	5 <sup>th</sup> harmonic of the highest frequency or 40 GHz, whichever is lower

## 7.2 Test Instruments

Description & Manufacturer	Model No.	Serial No.	Cal. Date	Cal. Due
Test Receiver ROHDE & SCHWARZ (Above 1GHz)	ESR7	101471	Mar. 11, 2020	Mar. 10, 2021
Spectrum Analyzer Agilent	E4446A	MY51100039	Dec. 01, 2020	Nov. 30, 2021
RF signal cable (with 5dB PAD) Times	LMR-400 (18M)	CABLE-CH2-01	Mar. 23, 2020	Mar. 22, 2021
HORN Antenna (with 4dB PAD) SCHWARZBECK	BBHA 9120 D	9120D-405	Nov. 22, 2020	Nov. 21, 2021
Pre-Amplifier Agilent (Above 1GHz)	8449B	3008A01961	Sep. 04, 2020	Sep. 03, 2021
RF Coaxial Cable JUNFLON+EMC	JUNFLON+EMC10 4-SM-SM-6000	Cable-CH2- 02(MWX3221308G003+1307 10)	Jan. 18, 2020	Jan. 17, 2021
Software BV ADT	BV ADT_Radiated_ V8.7.08	NA	NA	NA
Antenna Tower BV ADT	AT100	AT93021702	NA	NA
Turn Table BV ADT	TT100	TT93021702	NA	NA
Controller BV ADT	SC100	SC93021702	NA	NA
RF Coaxial Cable EMCI	EMC102-KM-KM- 1000	170819	Sep. 04, 2020	Sep. 03, 2021
RF Coaxial Cable Rosnol	K1K50-UP0279- K1K50-3000	181129-1	Sep. 04, 2020	Sep. 03, 2021
Fix tool for Boresight antenna	BAF-01	2	NA	NA
Pre-amplifier (18GHz- 40GHz) EMC	EMC184045B	980175	Sep. 04, 2020	Sep. 03, 2021
HORN Antenna (with 3dB PAD) SCHWARZBECK	BBHA 9170	148	Nov. 22, 2020	Nov. 21, 2021

- Note: 1. The calibration interval of the above test instruments is 12 months and the calibrations are traceable to NML/ROC and NIST/USA.
2. The test was performed in HwaYa Chamber 2. (966 Chamber 1)
3. The VCCI Site Registration No. is G-10018.

### 7.3 Test Arrangement

- The EUT was placed on the top of a rotating table 0.8 meters above the ground at an accredited chamber room. The table was rotated 360 degrees to determine the position of the highest radiation.
- The EUT was set 3 meters away from the interference-receiving antenna, which was mounted on the top of a variable-height antenna tower.
- For frequency range 1 GHz ~ 18 GHz, the EUT was set 3 meters away from the interference-receiving antenna, which was mounted on the top of a variable-height antenna tower.
- For frequency range 18 GHz ~ 40 GHz, the EUT was set 1.5 meters away from the interference-receiving antenna, which was mounted on the top of a variable-height antenna tower.
- The height of antenna can be varied from one meter to four meters, the height of adjustment depends on the EUT height and the antenna 3 dB beamwidth both, to detect the maximum value of the field strength. Both horizontal and vertical polarizations of the antenna are set to make the measurement.
- For each suspected emission, the EUT was arranged to its worst case and then the antenna was tuned to heights and the rotatable table was turned from 0 degrees to 360 degrees to find the maximum reading.
- The spectrum analyzer system was set to peak and average detect function and specified bandwidth with maximum hold mode when the test frequency is above 1 GHz.

Note: The resolution bandwidth of test receiver/spectrum analyzer is 1 MHz and video bandwidth is 3 MHz for Peak detection (PK) at frequency above 1 GHz. The resolution bandwidth of test receiver/spectrum analyzer is 1 MHz for Average detection (AV) at frequency above 1 GHz.

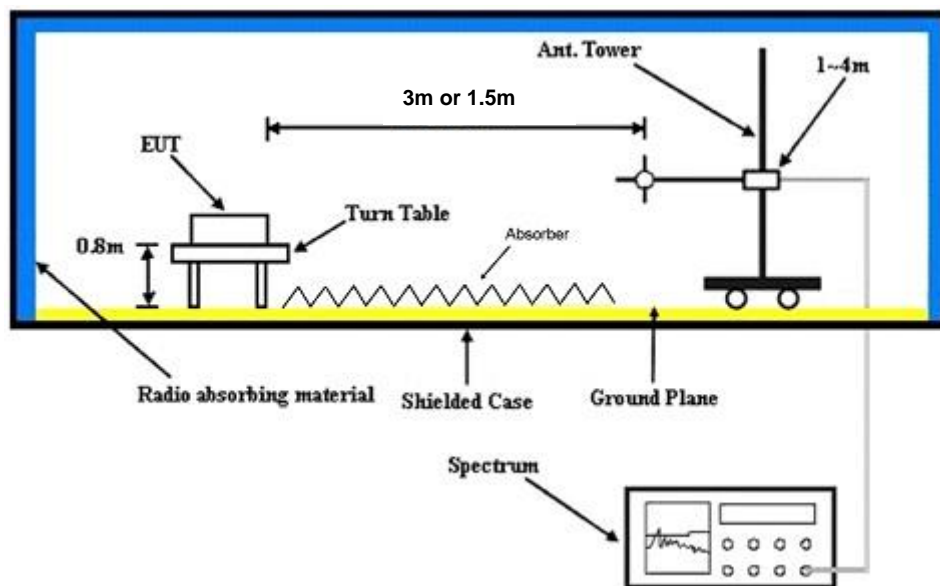

### 7.4 Test Results

<b>Frequency Range</b>	1GHz ~ 18GHz	<b>Detector Function &amp; Resolution Bandwidth</b>	Peak (PK) / Average (AV), 1MHz
<b>Tested By</b>	Kai Chu	<b>Environmental Conditions</b>	21°C, 69%RH
<b>Test Mode</b>	Mode 3	<b>Test Date</b>	2021/1/1

Antenna Polarity & Test Distance : Horizontal at 3 m								
No	Frequency (MHz)	Emission Level (dBuV/m)	Limit (dBuV/m)	Margin (dB)	Antenna Height (m)	Table Angle (Degree)	Raw Value (dBuV)	Correction Factor (dB/m)
1	2199.54	46.02 PK	74.00	-27.98	2.11 H	69	41.92	4.10
2	2199.54	32.76 AV	54.00	-21.24	2.11 H	69	28.66	4.10
3	4880.90	49.24 PK	74.00	-24.76	1.90 H	110	40.91	8.33
4	4880.90	35.97 AV	54.00	-18.03	1.90 H	110	27.64	8.33
5	6464.65	51.56 PK	74.00	-22.44	1.00 H	300	38.38	13.18
6	6464.65	38.80 AV	54.00	-15.20	1.00 H	300	25.62	13.18

**Remarks:**

1. Emission Level(dBuV/m) = Raw Value(dBuV) + Correction Factor(dB/m)
2. Correction Factor(dB/m) = Antenna Factor (dB/m) + Cable Factor (dB) – Pre-Amplifier Factor (dB)
3. The other emission levels were very low against the limit.
4. Margin value = Emission level – Limit value

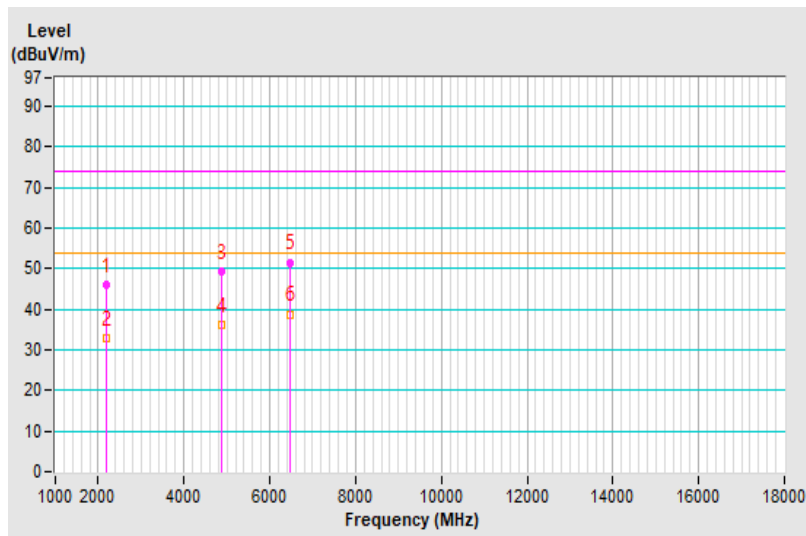

<b>Frequency Range</b>	1GHz ~ 18GHz	<b>Detector Function &amp; Resolution Bandwidth</b>	Peak (PK) / Average (AV), 1MHz
<b>Tested By</b>	Kai Chu	<b>Environmental Conditions</b>	21°C, 69%RH
<b>Test Mode</b>	Mode 3	<b>Test Date</b>	2021/1/1

Antenna Polarity & Test Distance : Vertical at 3 m								
No	Frequency (MHz)	Emission Level (dBuV/m)	Limit (dBuV/m)	Margin (dB)	Antenna Height (m)	Table Angle (Degree)	Raw Value (dBuV)	Correction Factor (dB/m)
1	2206.48	46.48 PK	74.00	-27.52	1.00 V	347	42.47	4.01
2	2206.48	32.91 AV	54.00	-21.09	1.00 V	347	28.90	4.01
3	5111.96	49.47 PK	74.00	-24.53	1.65 V	18	40.07	9.40
4	5111.96	36.36 AV	54.00	-17.64	1.65 V	18	26.96	9.40
5	6759.02	53.43 PK	74.00	-20.57	1.00 V	7	39.97	13.46
6	6759.02	39.09 AV	54.00	-14.91	1.00 V	7	25.63	13.46

**Remarks:**

1. Emission Level(dBuV/m) = Raw Value(dBuV) + Correction Factor(dB/m)
2. Correction Factor(dB/m) = Antenna Factor (dB/m) + Cable Factor (dB) – Pre-Amplifier Factor (dB)
3. The other emission levels were very low against the limit.
4. Margin value = Emission level – Limit value

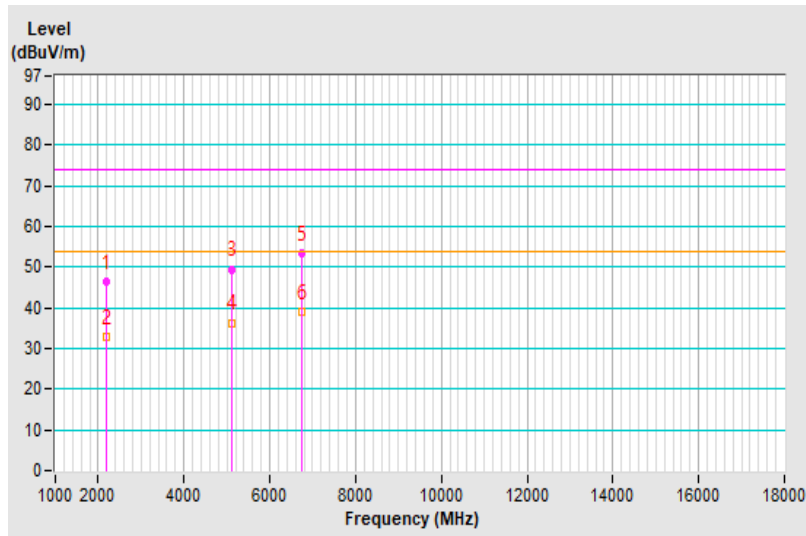



<b>Frequency Range</b>	18GHz ~ 40GHz	<b>Detector Function &amp; Resolution Bandwidth</b>	Peak (PK) / Average (AV), 1MHz
<b>Tested By</b>	Kai Chu	<b>Environmental Conditions</b>	21°C, 69%RH
<b>Test Mode</b>	Mode 3	<b>Test Date</b>	2021/1/1

Antenna Polarity & Test Distance : Horizontal at 1.5 m								
No	Frequency (MHz)	Emission Level (dBuV/m)	Limit (dBuV/m)	Margin (dB)	Antenna Height (m)	Table Angle (Degree)	Raw Value (dBuV)	Correction Factor (dB/m)
1	26325.43	60.09 PK	80.00	-19.91	1.00 H	154	55.06	5.03
2	26325.43	46.73 AV	60.00	-13.27	1.00 H	154	41.70	5.03

**Remarks:**

1. Emission Level(dBuV/m) = Raw Value(dBuV) + Correction Factor(dB/m)
2. Correction Factor(dB/m) = Antenna Factor (dB/m) + Cable Factor (dB) – Pre-Amplifier Factor (dB)
3. The other emission levels were very low against the limit.
4. Margin value = Emission level – Limit value

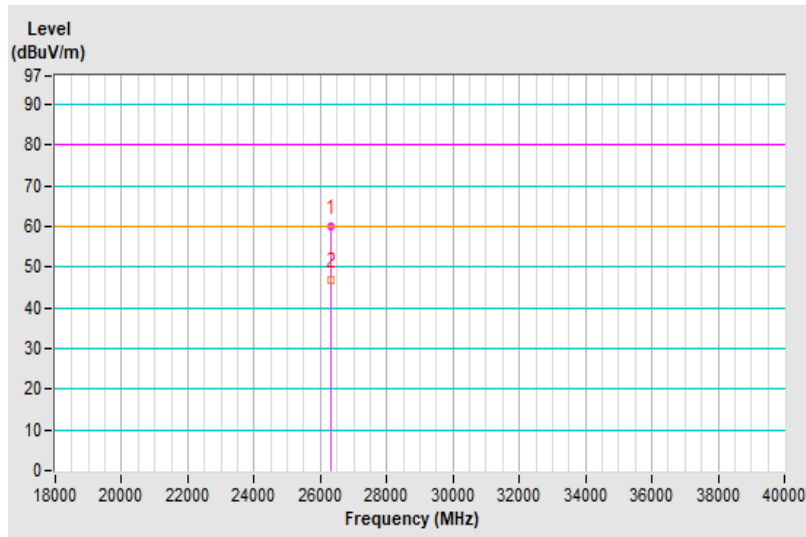

<b>Frequency Range</b>	18GHz ~ 40GHz	<b>Detector Function &amp; Resolution Bandwidth</b>	Peak (PK) / Average (AV), 1MHz
<b>Tested By</b>	Kai Chu	<b>Environmental Conditions</b>	21°C, 69%RH
<b>Test Mode</b>	Mode 3	<b>Test Date</b>	2021/1/1

Antenna Polarity & Test Distance : Vertical at 1.5 m								
No	Frequency (MHz)	Emission Level (dBuV/m)	Limit (dBuV/m)	Margin (dB)	Antenna Height (m)	Table Angle (Degree)	Raw Value (dBuV)	Correction Factor (dB/m)
1	26340.94	61.48 PK	80.00	-18.52	1.42 V	81	56.44	5.04
2	26340.94	47.59 AV	60.00	-12.41	1.42 V	81	42.55	5.04

**Remarks:**

1. Emission Level(dBuV/m) = Raw Value(dBuV) + Correction Factor(dB/m)
2. Correction Factor(dB/m) = Antenna Factor (dB/m) + Cable Factor (dB) – Pre-Amplifier Factor (dB)
3. The other emission levels were very low against the limit.
4. Margin value = Emission level – Limit value

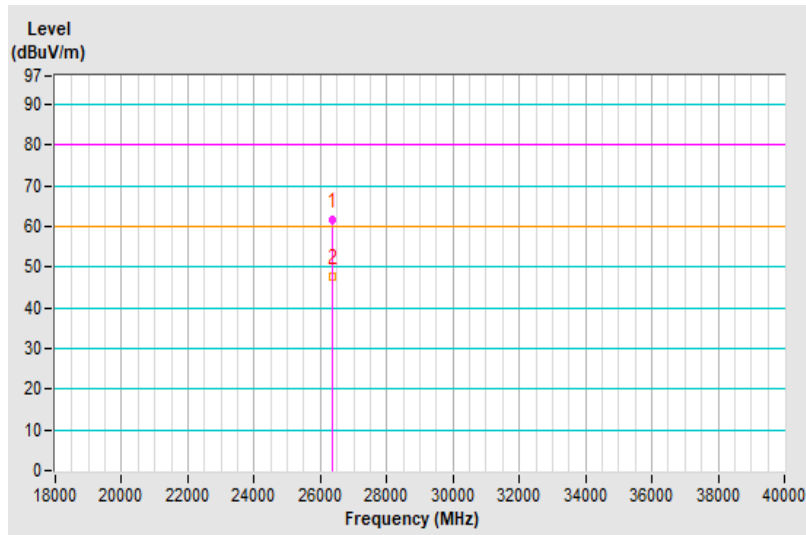

## 8 Pictures of Test Arrangements

Please refer to TSup Photo.pdf.

## Appendix – Information of the Testing Laboratories

We, Bureau Veritas Consumer Products Services (H.K.) Ltd., Taoyuan Branch, were founded in 1988 to provide our best service in EMC, Radio, Telecom and Safety consultation. Our laboratories are FCC recognized accredited test firms and accredited according to ISO/IEC 17025.

If you have any comments, please feel free to contact us at the following:

**Lin Kou EMC/RF Lab**

Tel: 886-2-26052180

Fax: 886-2-26051924

**Hsin Chu EMC/RF/Telecom Lab**

Tel: 886-3-6668565

Fax: 886-3-6668323

**Hwa Ya EMC/RF/Safety Lab**

Tel: 886-3-3183232

Fax: 886-3-3270892

**Email:** [service.adt@tw.bureauveritas.com](mailto:service.adt@tw.bureauveritas.com)

**Web Site:** [www.bureauveritas-adt.com](http://www.bureauveritas-adt.com)

The address and road map of all our labs can be found in our web site also.

--- END ---