



中认信通
CHINA CERTIFICATION ICT CO., LTD (DONGGUAN)



TEST REPORT

Applicant: Welink Communications

Address: 1881 W Traverse PKWY Lehi Utah United States

FCC ID: 2AYX4-PMP-SIV1

Product Name: WELINK-SR

Model: PMP-SIV1

**Standard(s): 47 CFR Part 15, Subpart C(15.255)
ANSI C63.10-2013**

The above equipment has been tested and found compliant with the requirement of the relative standards by China Certification ICT Co., Ltd (Dongguan)

Report Number: CR22080030-00A

Date Of Issue: 2023/3/7

Reviewed By: Sun Zhong

Sun Zhong

Title: Manager

Test Laboratory: China Certification ICT Co., Ltd (Dongguan)

No. 113, Pingkang Road, Dalang Town, Dongguan,
Guangdong, China
Tel: +86-769-82016888

Test Facility

The Test site used by China Certification ICT Co., Ltd (Dongguan) to collect test data is located on the No. 113, Pingkang Road, Dalang Town, Dongguan, Guangdong, China.

The lab has been recognized as the FCC accredited lab under the KDB 974614 D01 and is listed in the FCC Public Access Link (PAL) database, FCC Registration No. : 442868, the FCC Designation No. : CN1314.

The lab has been recognized by Innovation, Science and Economic Development Canada to test to Canadian radio equipment requirements, the CAB identifier: CN0123.

Declarations

China Certification ICT Co., Ltd (Dongguan) is not responsible for the authenticity of any test data provided by the applicant. Data included from the applicant that may affect test results are marked with a triangle symbol “▲”. Customer model name, addresses, names, trademarks etc. are not considered data.

Unless otherwise stated the results shown in this test report refer only to the sample(s) tested.

This report cannot be reproduced except in full, without prior written approval of the Company.

This report is valid only with a valid digital signature. The digital signature may be available only under the Adobe software above version 7.0.

This report may contain data that are not covered by the accreditation scope and shall be marked with an asterisk “★”.

CONTENTS

TEST FACILITY	2
DECLARATIONS.....	2
DOCUMENT REVISION HISTORY	5
1. GENERAL INFORMATION	6
1.1 PRODUCT DESCRIPTION FOR EQUIPMENT UNDER TEST (EUT)	6
1.2 DESCRIPTION OF TEST CONFIGURATION.....	7
1.2.2 Support Equipment List and Details	7
1.2.3 Support Cable List and Details	7
1.2.4 Block Diagram of Test Setup.....	8
1.3 FAR FIELD BOUNDARY CALCULATIONS	10
1.4 MEASUREMENT UNCERTAINTY	11
2. SUMMARY OF TEST RESULTS	12
3. REQUIREMENTS AND TEST PROCEDURES	13
3.1 AC LINE CONDUCTED EMISSIONS.....	13
3.1.1 Applicable Standard.....	13
3.1.2 EUT Setup.....	14
3.1.3 EMI Test Receiver Setup	14
3.1.4 Test Procedure	15
3.1.5 Corrected Amplitude & Margin Calculation.....	15
3.2 RADIATED EMISSIONS	16
3.2.1 Applicable Standard.....	16
3.2.2 EUT Setup.....	16
3.2.3 EMI Test Receiver & Spectrum Analyzer Setup	18
3.2.4 Test Procedure	18
3.2.5 Corrected Amplitude & Margin Calculation.....	18
3.3 EMISSION BANDWIDTH:	19
3.3.1 Applicable Standard.....	19
3.3.2 EUT Setup.....	19
3.3.3 Test Procedure	19
3.4 EQUIVALENT ISOTROPICALLY RADIATED POWER (EIRP)	20
3.4.1 Applicable Standard.....	20
3.4.2 Test Procedure	20
3.5 PEAK CONDUCTED OUTPUT POWER	21
3.5.1 Applicable Standard.....	21
3.5.2 Test Procedure	21
3.6 FREQUENCY STABILITY.....	22
3.6.1 Applicable Standard.....	22
3.6.2 Test Procedure	22
3.7 OPERATION RESTRICTION AND GROUP INSTALLTION.....	23
3.7.1 Applicable Standard.....	23

3.7.2 Result of Operation Restriction.....23

3.7.3 Result of Group installation23

3.8 ANTENNA REQUIREMENT 23

3.8.1 Applicable Standard.....23

3.8.2 Judgment.....23

4. TEST DATA AND RESULTS 24

4.1 AC LINE CONDUCTED EMISSIONS 24

4.2 RADIATION SPURIOUS EMISSIONS 29

4.3 EMISSION BANDWIDTH: 42

4.4 EQUIVALENT ISOTROPICALLY RADIATED POWER (EIRP): 49

4.5 PEAK CONDUCTED OUTPUT POWER: 51

4.6 FREQUENCY STABILITY: 53

5. RF EXPOSURE EVALUATION 55

5.1 MAXIMUM PERMISSIBLE EXPOSURE (MPE) 55

5.1.1 APPLICABLE STANDARD..... 55

5.1.2 PROCEDURE..... 55

DOCUMENT REVISION HISTORY

Revision Number	Report Number	Description of Revision	Date of Revision
1.0	CR22080030-00A	Original Report	2023/3/7

1. GENERAL INFORMATION

1.1 Product Description for Equipment under Test (EUT)

EUT Name:	WELINK-SR
EUT Model:	PMP-SIV1
Operation Frequency Range:	58.32-69.12 GHz
Modulation Type:	$\pi/2$ -BPSK, $\pi/2$ -QPSK, $\pi/2$ -16QAM
Rated Input Voltage:	DC 48V
Serial Number:	CR22080030-RF-S1
EUT Received Date:	2022/8/22
EUT Received Status:	Good

Operation Frequency Detail:

Channel	Frequency (GHz)	Channel	Frequency (GHz)
1	58.32	4	64.80
2	60.48	5	66.96
3	62.64	6	69.12

Per section 15.31(m), the below frequencies were performed the test as below:

Test Channel	Frequency (GHz)
Lowest	58.32
Middle	64.80
Highest	69.12

Antenna Information Detail ▲ :

Antenna Type	input impedance (Ohm)	Frequency Range	Antenna Gain
Microstrip Patch	50	57~71GHz	18 dBi

The Method of §15.203 Compliance:

- Antenna must be permanently attached to the unit.
- Antenna must use a unique type of connector to attach to the EUT.
- Unit must be professionally installed, and installer shall be responsible for verifying that the correct antenna is employed with the unit.

Accessory Information:

No Accessory.

1.2 Description of Test Configuration

1.2.1 EUT Operation Condition:

EUT Operation Mode:	The system was configured for testing in Engineering Mode, which was provided by the manufacturer.
Equipment Modifications:	No
EUT Exercise Software:	No
Engineering Mode was provided by manufacturer ▲. The maximum power was configured default setting.	

1.2.2 Support Equipment List and Details

Manufacturer	Description	Model	Serial Number
DELL	Laptop	E6410	GYXJ3 A00 JSD2
Welink	POE	Unknown	Unknown
Unknown	RJ45 Load	R100W	RL02
Unknown	Load	100W	L06
ZHAOXIN	DC Power Supply	RXN-6010D	21R6010D0912386

1.2.3 Support Cable List and Details

Cable Description	Shielding Type	Ferrite Core	Length (m)	From Port	To
RJ45 Cable	No	No	0.3	POE	EUT
RJ45 Cable	No	Yes	3	POE	Laptop
RJ45 Cable	No	Yes	3	EUT	Laptop
RJ45 Cable	No	No	3	EUT	RJ45 Load
DC Cable	No	No	3	EUT	Load
Power Cable	No	No	1.5	EUT	DC Power Supply
Power Cable	No	No	1.2	LISN	DC Power Supply

1.2.4 Block Diagram of Test Setup

Conducted emissions:

POE:

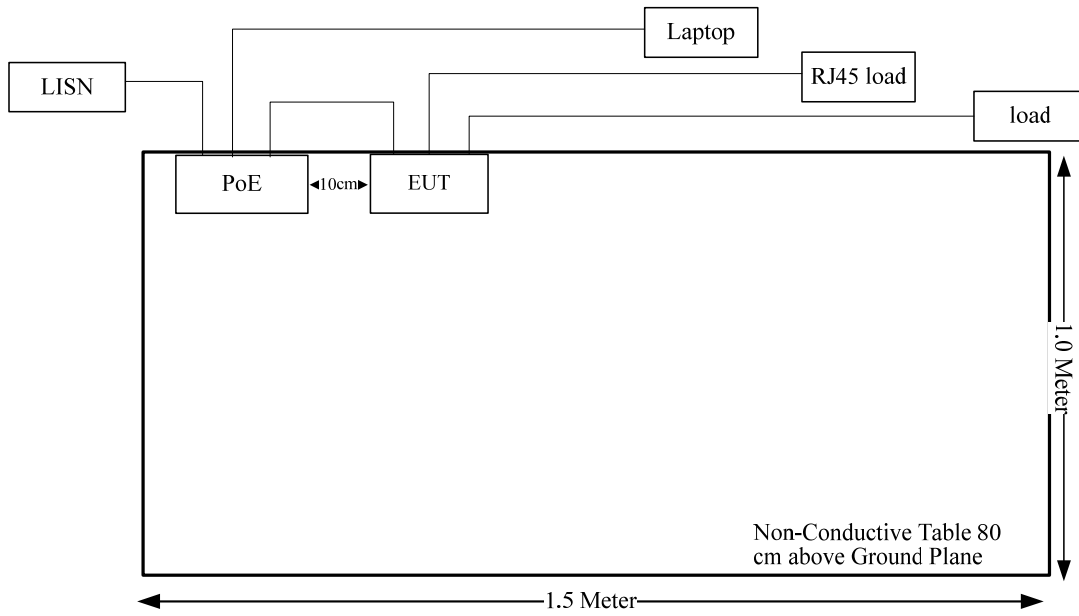

DC Power:

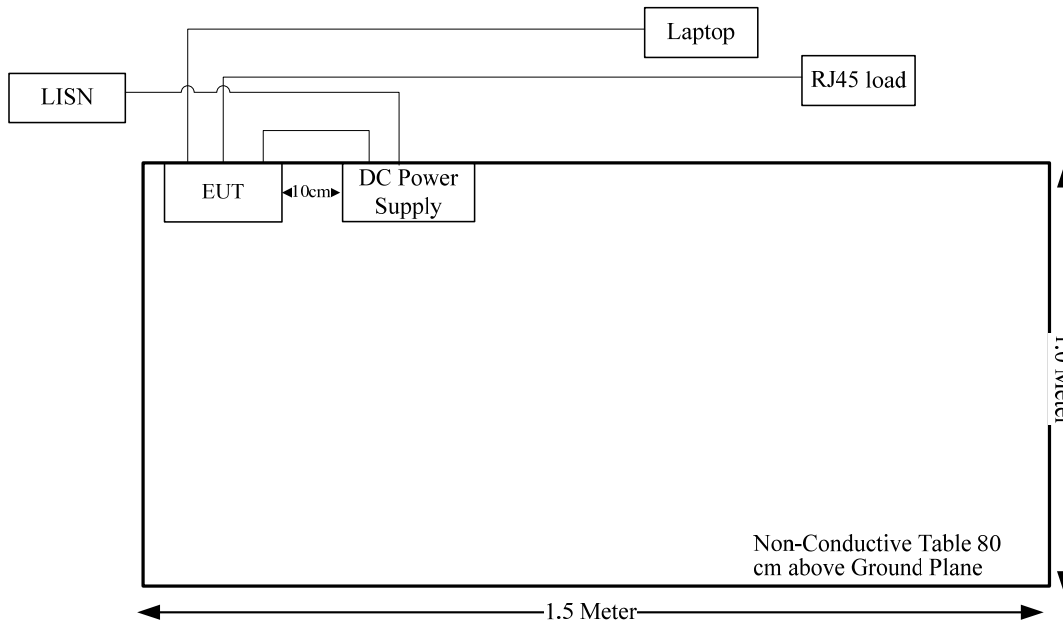

Radiated emissions:
POE:

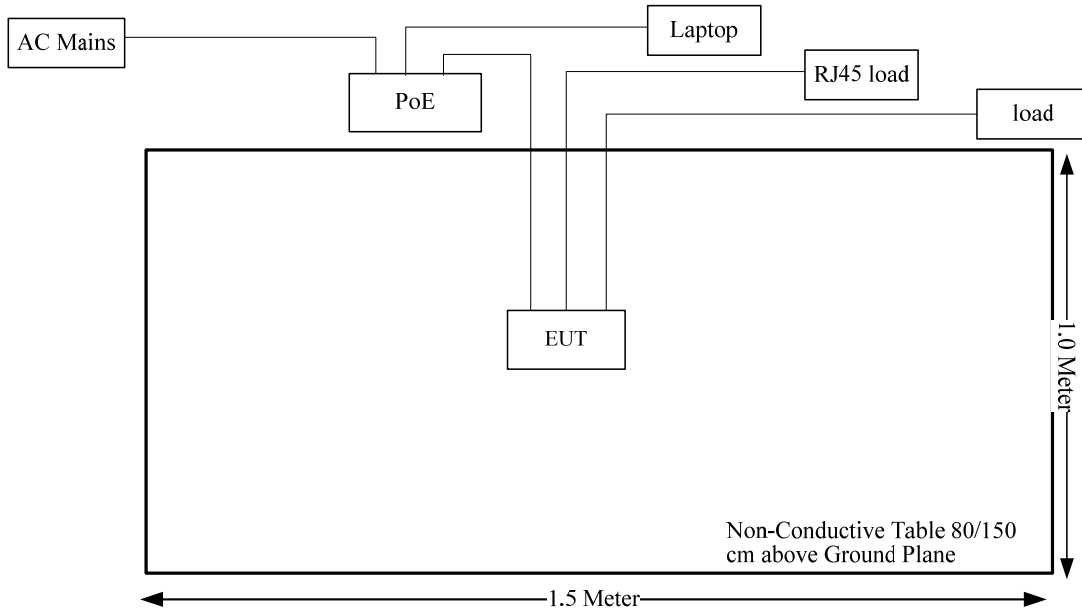

DC Power:

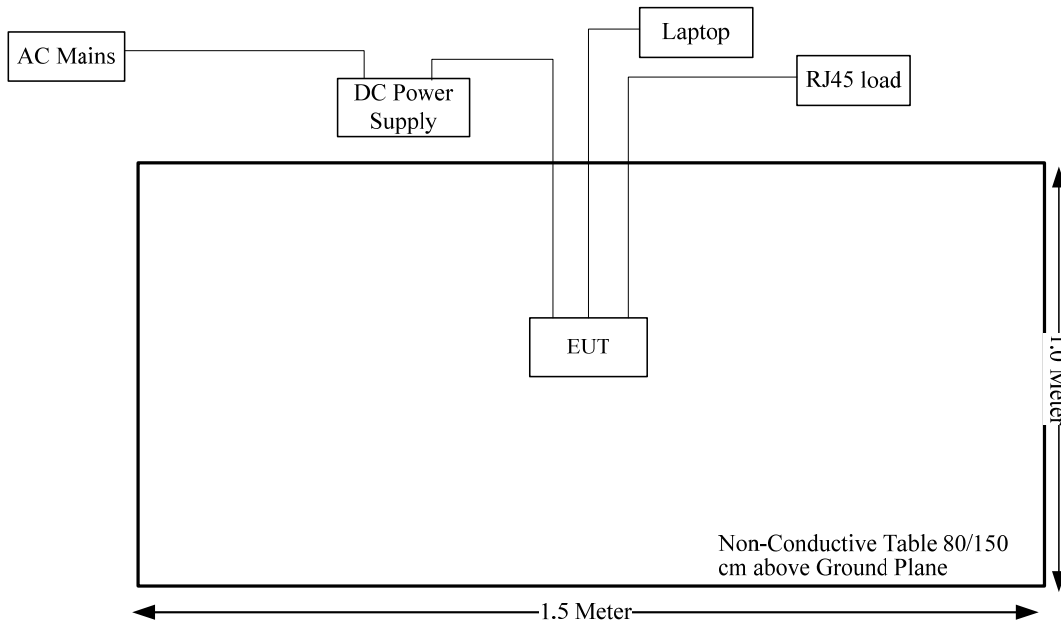

1.3 FAR Field Boundary Calculations

The far-field boundary is given in ANSI C63.10-2013:

$$R_m = 2D^2 / \lambda$$

Where:

D is the largest dimension of the antenna aperture in m and

λ is the free-space wavelength in m at the frequency of measurement.

The minimum test distance for the frequency range 40GHz-200GHz determine as below:

Model	Frequency Range (GHz)	Largest Dimension of the Horn Antenna (mm)	Minimum Test Distance R_m (m)
M19RH	40-60	46.3	0.57
861V/385	50-75	43.7	0.64
M12RH	60-90	30.02	0.36
M08RH	90-140	19.7	0.23
M05RH	140-220	12.5	0.30

Note: The test distances used were 1.0 m from 40 GHz to 90 GHz, and 0.5 m from 90 GHz to 200 GHz, it can be seen that the EUT was always in the Far-field of the Receive Antenna during all Radiated Emissions Tests.

1.4 Measurement Uncertainty

Otherwise required by the applicant or Product Regulations, Decision Rule in this report did not consider the uncertainty. The extended uncertainty given in this report is obtained by combining the standard uncertainty times the coverage factor K with the 95% confidence interval.

Parameter	Measurement Uncertainty
Occupied Channel Bandwidth	±5 %
Unwanted Emissions, radiated	30M~200MHz: 4.15 dB, 200M~1GHz: 5.61 dB, 1G~6GHz: 5.14 dB, 6G~18GHz: 5.93 dB, 18G~26.5G: 5.47 dB, 26.5G~40G: 5.63 dB 40~60G: 4.83dB, 60G~90G: 4.94dB, 90G-140G: 5.46dB, 140G-220G: 6.00dB
Temperature	±1 °C
Humidity	±5%
DC and low frequency voltages	±0.4%
Duty Cycle	1%
AC Power Lines Conducted Emission	2.8 dB (150 kHz to 30 MHz)

2. SUMMARY OF TEST RESULTS

Standard(s)/Rule(s)	Description of Test	Result
§15.207(a)	Conduction Emissions	Compliant
15.205, §15.209, §15.255(d)	Radiated Emissions	Compliant
§15.215, §15.255 (e)	Emission Bandwidth	Compliant
§15.255(c)	Equivalent Isotropically Radiated Power (EIRP)	Compliant
§15.255(e)	Peak Conducted Output Power	Compliant
§15.255 (f)	Frequency Stability	Compliant
§15.255 (a)(h)	Operation Restriction And Group Installation	Compliant
§15.203	Antenna Requirement	Compliant
§15.255(g), §1.1310, §2.1091	Maximum Permissible Exposure (MPE)	Compliant

3. REQUIREMENTS AND TEST PROCEDURES

3.1 AC Line Conducted Emissions

3.1.1 Applicable Standard

FCC§15.207(a).

(a) Except as shown in paragraphs (b) and (c) of this section, for an intentional radiator that is designed to be connected to the public utility (AC) power line, the radio frequency voltage that is conducted back onto the AC power line on any frequency or frequencies, within the band 150 kHz to 30 MHz, shall not exceed the limits in the following table, as measured using a 50 μ H/50 ohms line impedance stabilization network (LISN). Compliance with the provisions of this paragraph shall be based on the measurement of the radio frequency voltage between each power line and ground at the power terminal. The lower limit applies at the boundary between the frequency ranges.

Frequency of emission (MHz)	Conducted limit (dB μ V)	
	Quasi-peak	Average
0.15-0.5	66 to 56*	56 to 46*
0.5-5	56	46
5-30	60	50

*Decreases with the logarithm of the frequency.

(b) The limit shown in paragraph (a) of this section shall not apply to carrier current systems operating as intentional radiators on frequencies below 30 MHz. In lieu thereof, these carrier current systems shall be subject to the following standards:

(1) For carrier current system containing their fundamental emission within the frequency band 535-1705 kHz and intended to be received using a standard AM broadcast receiver: no limit on conducted emissions.

(2) For all other carrier current systems: 1000 μ V within the frequency band 535-1705 kHz, as measured using a 50 μ H/50 ohms LISN.

(3) Carrier current systems operating below 30 MHz are also subject to the radiated emission limits in §15.205, §15.209, §15.221, §15.223, or §15.227, as appropriate.

(c) Measurements to demonstrate compliance with the conducted limits are not required for devices which only employ battery power for operation and which do not operate from the AC power lines or contain provisions for operation while connected to the AC power lines. Devices that include, or make provisions for, the use of battery chargers which permit operating while charging, AC adapters or battery eliminators or that connect to the AC power lines indirectly, obtaining their power through another device which is connected to the AC power lines, shall be tested to demonstrate compliance with the conducted limits.

3.1.2 EUT Setup

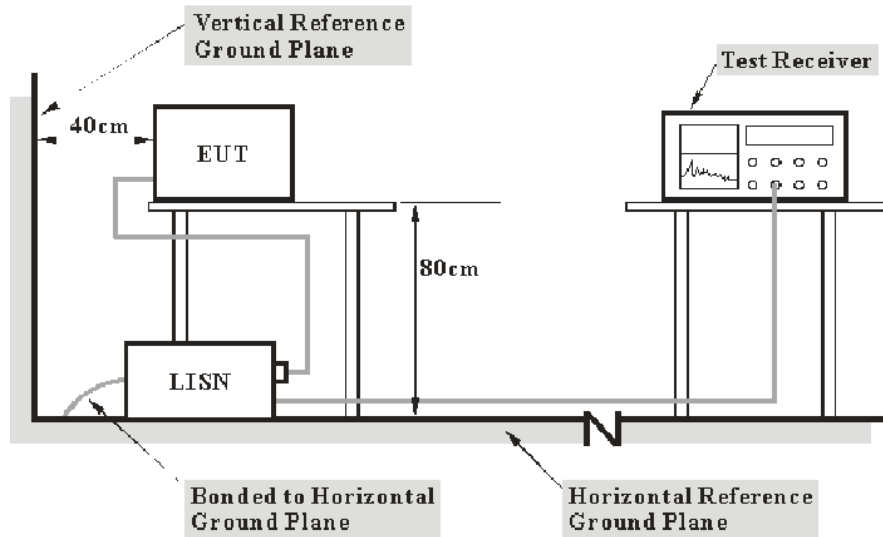

- Note: 1. Support units were connected to second LISN.
 2. Both of LISNs (AMN) 80 cm from EUT and at the least 80 cm from other units and other metal planes support units.

The setup of EUT is according with per ANSI C63.10-2013 measurement procedure. The specification used was with the FCC Part 15.207 limits.

The spacing between the peripherals was 10 cm.

3.1.3 EMI Test Receiver Setup

The EMI test receiver was set to investigate the spectrum from 150 kHz to 30 MHz.

During the conducted emission test, the EMI test receiver was set with the following configurations:

Frequency Range	IF B/W
150 kHz – 30 MHz	9 kHz

3.1.4 Test Procedure

During the conducted emission test, the EUT was connected to the outlet of the first LISN.

The frequency and amplitude of the six highest ac power-line conducted emissions relative to the limit, measured over all the current-carrying conductors of the EUT power cords, and the operating frequency or frequency to which the EUT is tuned (if appropriate), should be reported, unless such emissions are more than 20 dB below the limit. AC power-line conducted emissions measurements are to be separately carried out only on each of the phase (“hot”) line(s) and (if used) on the neutral line(s), but not on the ground [protective earth] line(s). If less than six emission frequencies are within 20 dB of the limit, then the noise level of the measuring instrument at representative frequencies should be reported. The specific conductor of the power-line cord for each of the reported emissions should be identified. Measure the six highest emissions with respect to the limit on each current-carrying conductor of each power cord associated with the EUT (but not the power cords of associated or peripheral equipment that are part of the test configuration). Then, report the six highest emissions with respect to the limit from among all the measurements identifying the frequency and specific current-carrying conductor identified with the emission. The six highest emissions should be reported for each of the current-carrying conductors, or the six highest emissions may be reported over all the current-carrying conductors.

3.1.5 Corrected Amplitude & Margin Calculation

The basic equation is as follows:

Result = Reading + Factor

Factor = attenuation caused by cable loss + voltage division factor of AMN

The “**Margin**” column of the following data tables indicates the degree of compliance within the applicable limit. The equation for margin calculation is as follows:

Margin = Limit – Result

3.2 Radiated Emissions

3.2.1 Applicable Standard

FCC §15.255

(d) Limits on spurious emissions:

- (1) The power density of any emissions outside the 57-71 GHz band shall consist solely of spurious emissions.
- (2) Radiated emissions below 40 GHz shall not exceed the general limits in § 15.209.
- (3) Between 40 GHz and 200 GHz, the level of these emissions shall not exceed 90 pW/cm^2 at a distance of 3 meters.
- (4) The levels of the spurious emissions shall not exceed the level of the fundamental emission.

3.2.2 EUT Setup

Below 1GHz:

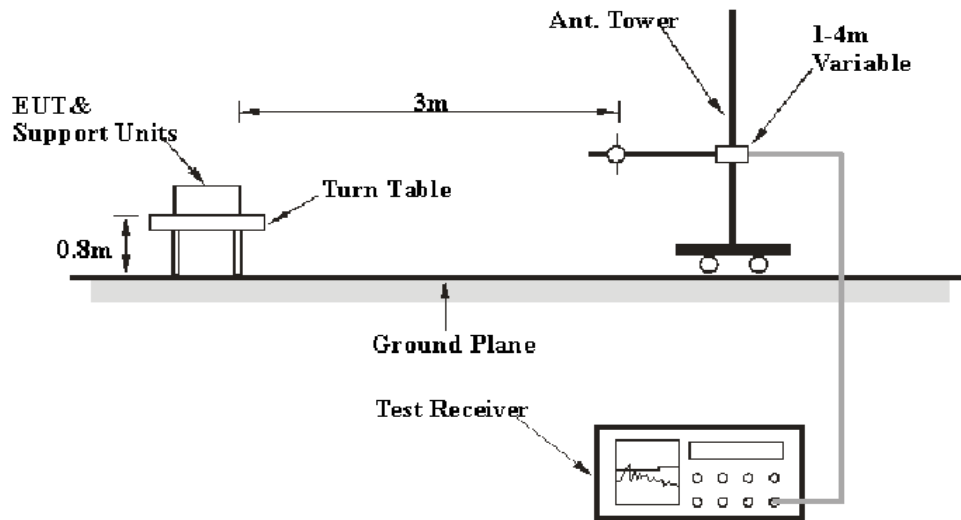

1-26.5 GHz:

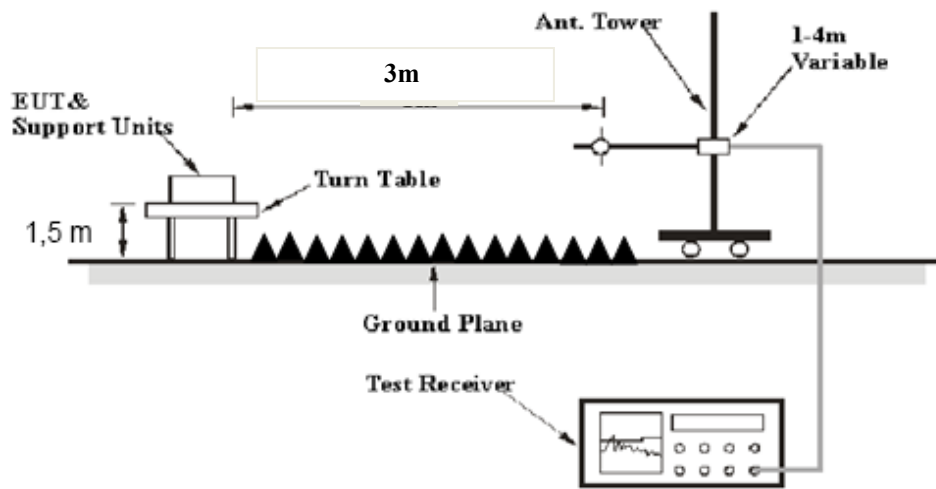

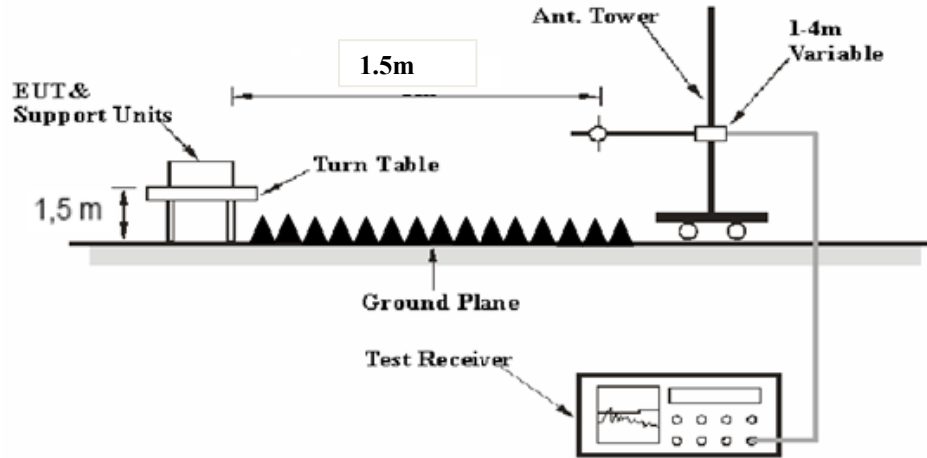
26.5-40 GHz:**Above 40GHz:**

The antenna is scanned around the entire perimeter surface of the EUT, in both horizontal and vertical polarizations, at the distance of 1.0 m from 40 GHz to 90 GHz, and 0.5 m from 90 GHz to 200 GHz.

The radiated emission and out of band emission tests were performed in the 3 meters chamber test site A, using the setup accordance with the ANSI C63.10-2013 The specification used was the FCC 15.209/15.205 and FCC 15.255 limits.

3.2.3 EMI Test Receiver & Spectrum Analyzer Setup

The system was investigated from 30 MHz to 200 GHz.

During the radiated emission test, the EMI test receiver & Spectrum Analyzer Setup were set with the following configurations:

Frequency Range	RBW	Video B/W	IF B/W	Detector
30 MHz – 1000 MHz	120 kHz	300 kHz	120 kHz	QP
1-40 GHz	1MHz	3 MHz	/	PK
	1MHz	10 Hz	/	Ave
40 GHz – 200 GHz	1MHz	3 MHz	/	PK

If the maximized peak measured value complies with under the QP/Average limit more than 6dB, then it is unnecessary to perform an QP/Average measurement.

3.2.4 Test Procedure

Refer to ANSI C63.10-2013 Clauses 9.9, 9.12, and 9.13.

A Maximizing procedure was performed to ensure that the highest emissions from the EUT were actually measured in all of the Test Arrangements of the EUT and Local Support Equipment.

In accordance with FCC Rules Part 15 Subpart A Section 15.35, from 30 MHz to 1 GHz all radiated emissions measurements were made using a Quasi-peak Detector, and from 1 GHz to 40 GHz, all radiated emissions measurements were made using a Peak Detector and CISPR Average Detector. In accordance with FCC Rules Part 15 Subpart C Section 15.255, from 40 GHz to 200 GHz, all radiated emissions measurements were made using a Peak Detector.

According to C63.10, the 26.5-40GHz test result shall be extrapolated to the specified distance using an extrapolation factor of 20dB/decade from 3m to 1.5m

Distance extrapolation factor = $20 \log (\text{specific distance [3m]}/\text{test distance [1.5m]})$ dB= 6.02 dB

All emissions under the average limit and under the noise floor have not recorded in the report.

3.2.5 Corrected Amplitude & Margin Calculation

The basic equation is as follows:

Factor = Antenna Factor + Cable Loss- Amplifier Gain

For 30MHz-26.5GHz:

Result = Reading + Factor

For 26.5GHz-40GHz

Result = Reading + Factor-Distance extrapolation Factor

The “**Margin**” column of the following data tables indicates the degree of compliance within the applicable limit. The equation for margin calculation is as follows:

Margin = Limit – Result

3.3 Emission Bandwidth:

3.3.1 Applicable Standard

FCC §15.255 (e)

(1) Transmitters with an emission bandwidth of less than 100 MHz must limit their peak transmitter conducted output power to the product of 500 mW times their emission bandwidth divided by 100 MHz. For the purposes of this paragraph, emission bandwidth is defined as the instantaneous frequency range occupied by a steady state radiated signal with modulation, outside which the radiated power spectral density never exceeds 6 dB below the maximum radiated power spectral density in the band, as measured with a 100 kHz resolution bandwidth spectrum analyzer. The center frequency must be stationary during the measurement interval, even if not stationary during normal operation (e.g., for frequency hopping devices).

FCC §15.215

Intentional radiators operating under the alternative provisions to the general emission limits, as contained in §§ 15.217 through 15.257 and in Subpart E of this part, must be designed to ensure that the 20 dB bandwidth of the emission, or whatever bandwidth may otherwise be specified in the specific rule section under which the equipment operates, is contained within the frequency band designated in the rule section under which the equipment is operated.

3.3.2 EUT Setup

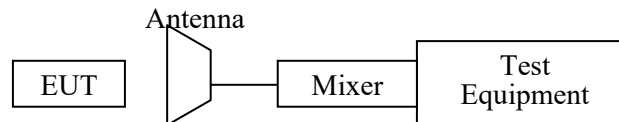

3.3.3 Test Procedure

- a) Set RBW = 100 kHz.
- b) Set the video bandwidth (VBW) $\geq 3 \times$ RBW.
- c) Detector = Peak.
- d) Trace mode = max hold.
- e) Sweep = auto couple.
- f) Allow the trace to stabilize.
- g) Measure the maximum width of the emission that is constrained by the frequencies associated with the two outermost amplitude points (upper and lower frequencies) that are attenuated by 6 dB relative to the maximum level measured in the fundamental emission.

3.4 Equivalent Isotropically Radiated Power (EIRP)

3.4.1 Applicable Standard

FCC §15.255(c)

(1) Products other than fixed field disturbance sensors and short-range devices for interactive motion sensing shall comply with one of the following emission limits, as measured during the transmit interval:

(i) The average power of any emission shall not exceed 40 dBm and the peak power of any emission shall not exceed 43 dBm;

3.4.2 Test Procedure

Refer to ANSI C63.10-2013 Clause 9.11

Maximizing procedure was performed on the highest emissions to ensure that the EUT complied with all installation combinations.

3.5 Peak Conducted Output Power

3.5.1 Applicable Standard

FCC §15.255(e)

(e) Except as specified paragraph (e)(1) of this section, the peak transmitter conducted output power shall not exceed 500 mW. Depending on the gain of the antenna, it may be necessary to operate the intentional radiator using a lower peak transmitter output power in order to comply with the EIRP limits specified in paragraph (b) of this section.

3.5.2 Test Procedure

Refer to ANSI C63.10-2013 Clause 9.7: equation to calculate power output.

3.6 Frequency Stability

3.6.1 Applicable Standard

FCC §15.255(f)

(f) Frequency stability. Fundamental emissions must be contained within the frequency bands specified in this section during all conditions of operation. Equipment is presumed to operate over the temperature range -20 to $+50$ degrees Celsius with an input voltage variation of 85% to 115% of rated input voltage, unless justification is presented to demonstrate otherwise.

3.6.2 Test Procedure

Frequency Stability vs. Temperature: The adapter of the equipment under test was connected to an AC power source. The EUT was placed inside the temperature chamber. Place the Horn antenna inside the temperature chamber. Place the EUT antenna toward the Horn antenna.

After the temperature stabilized for approximately 20 minutes, the frequency output was recorded from the communication test set.

Frequency Stability vs. Voltage: An external variable AC power supply was connected to the equipment under test. The voltage was set from 85% to 115% of the nominal value. The output frequency was recorded for each voltage.

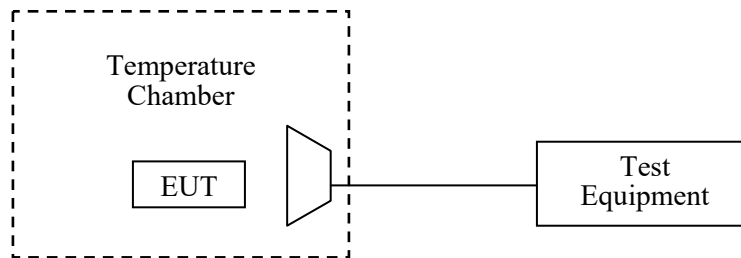

3.7 Operation Restriction And Group Installtion

3.7.1 Applicable Standard

§15.255 (a) Operation under the provisions of this section is not permitted for the following products:

- (1) Equipment used on aircraft or satellites.
- (2) Field disturbance sensors, including vehicle radar systems, unless the field disturbance sensors are employed for fixed operation. For the purposes of this section, the reference to fixed operation includes field disturbance sensors installed in fixed equipment, even if the sensor itself moves within the equipment.

§15.255 (h) Any transmitter that has received the necessary FCC equipment authorization under the rules of this chapter may be mounted in a group installation for simultaneous operation with one or more other transmitter(s) that have received the necessary FCC equipment authorization, without any additional equipment authorization. However, no transmitter operating under the provisions of this section may be equipped with external phase-locking inputs that permit beam-forming arrays to be realized.

3.7.2 Result of Operation Restriction

The Manufacturer declared that the EUT will not be advertised or sold for use on aircraft or satellites. The user manual includes a statement that cautions users that it is not permitted to use the product on aircraft or satellites.

3.7.3 Result of Group installation

The frequency, amplitude and phase of the transmit signal are set within the EUT. There are no external phase-locking inputs or any other means of combining two or more units together to realize a beam-forming array

3.8 Antenna Requirement

3.8.1 Applicable Standard

FCC §15.203

An intentional radiator shall be designed to ensure that no antenna other than that furnished by the responsible party shall be used with the device. The use of a permanently attached antenna or of an antenna that uses a unique coupling to the intentional radiator shall be considered sufficient to comply with the provisions of this section. The manufacturer may design the unit so that a broken antenna can be replaced by the user, but the user of a standard antenna jack or electrical connector is prohibited. The structure and application of the EUT were analyzed to determine compliance with section §15.203 of the rules. §15.203 state that the subject device must meet the following criteria:

- a. Antenna must be permanently attached to the unit.
- b. Antenna must use a unique type of connector to attach to the EUT.
- c. Unit must be professionally installed, and installer shall be responsible for verifying that the correct antenna is employed with the unit.

3.8.2 Judgment

Please refer to the Antenna Information detail in Section 1.

4. TEST DATA AND RESULTS

4.1 AC Line Conducted Emissions

Serial Number:	CR22080030-RF-S1	Test Date:	2022/11/12
Test Site:	CE	Test Mode:	Transmitting(π 2-16QAM low channel was the worst)
Tester:	Vic Du	Test Result:	Pass

Environmental Conditions:					
Temperature: (°C)	25.1	Relative Humidity: (%)	63	ATM Pressure: (kPa)	101.4

Test Equipment List and Details:

Manufacturer	Description	Model	Serial Number	Calibration Date	Calibration Due Date
R&S	LISN	ENV216	101134	2022/04/01	2023/03/31
R&S	EMI Test Receiver	ESR3	102726	2022/07/15	2023/07/14
MICRO-COAX	Coaxial Cable	UTIFLEX	C-0200-01	2022/08/07	2023/08/06
Audix	Test Software	E3	190306 (V9)	N/A	N/A

** Statement of Traceability: China Certification ICT Co., Ltd (Dongguan) attests that all calibrations have been performed, traceable to National Primary Standards and International System of Units (SI).*

POE:
Line:

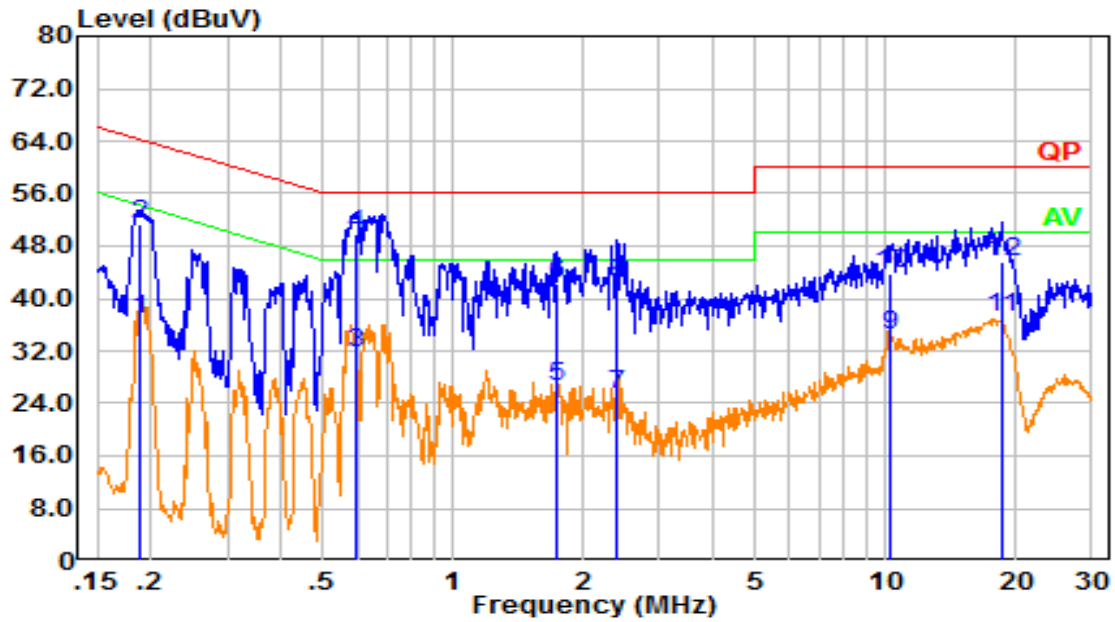

No.	Frequency (MHz)	Reading (dBμV)	Factor (dB)	Result (dBμV)	Limit (dBμV)	Margin (dB)	Detector
1	0.188	27.36	9.61	36.97	54.15	17.18	Average
2	0.188	41.71	9.61	51.32	64.15	12.83	QP
3	0.600	22.06	9.62	31.68	46.00	14.32	Average
4	0.600	40.30	9.62	49.92	56.00	6.08	QP
5	1.728	16.90	9.63	26.53	46.00	19.47	Average
6	1.728	32.73	9.63	42.36	56.00	13.64	QP
7	2.398	15.78	9.64	25.42	46.00	20.58	Average
8	2.398	32.48	9.64	42.12	56.00	13.88	QP
9	10.275	24.75	9.67	34.42	50.00	15.58	Average
10	10.275	34.09	9.67	43.76	60.00	16.24	QP
11	18.556	27.30	9.76	37.06	50.00	12.94	Average
12	18.556	35.94	9.76	45.70	60.00	14.30	QP

Neutral:

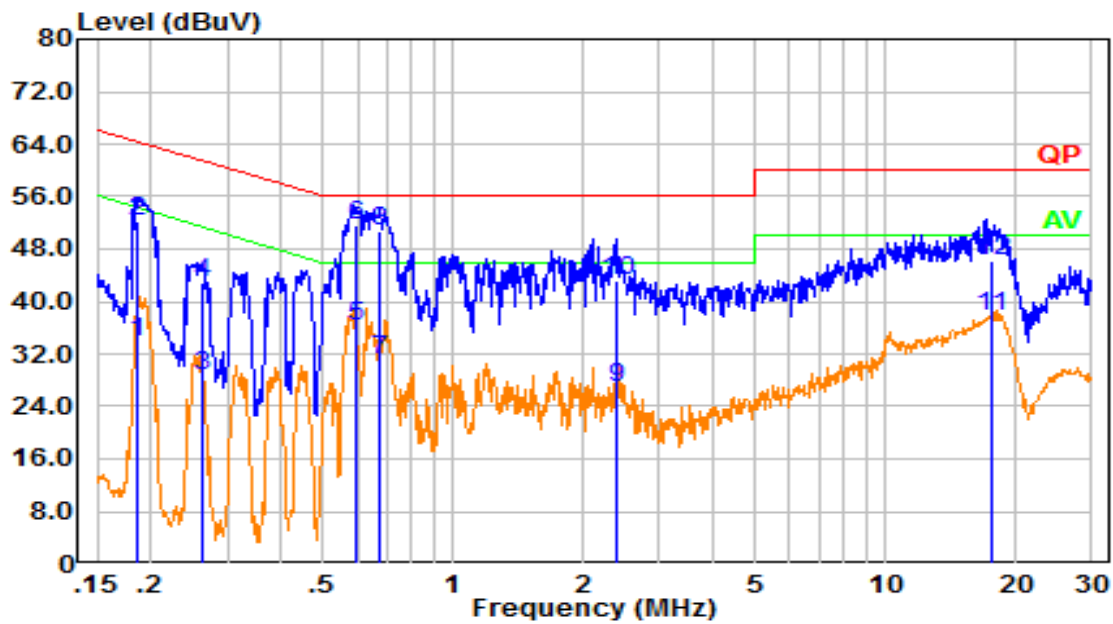

No.	Frequency (MHz)	Reading (dB μ V)	Factor (dB)	Result (dB μ V)	Limit (dB μ V)	Margin (dB)	Detector
1	0.185	24.24	9.61	33.85	54.28	20.43	Average
2	0.185	42.49	9.61	52.10	64.28	12.18	QP
3	0.262	19.12	9.61	28.73	51.38	22.65	Average
4	0.262	33.33	9.61	42.94	61.38	18.44	QP
5	0.594	26.54	9.62	36.16	46.00	9.84	Average
6	0.594	42.09	9.62	51.71	56.00	4.29	QP
7	0.676	21.62	9.62	31.24	46.00	14.76	Average
8	0.676	41.13	9.62	50.75	56.00	5.25	QP
9	2.396	17.24	9.64	26.87	46.00	19.13	Average
10	2.396	33.38	9.64	43.02	56.00	12.98	QP
11	17.611	28.19	9.69	37.88	50.00	12.12	Average
12	17.611	36.62	9.69	46.31	60.00	13.69	QP

DC Power:
Line:

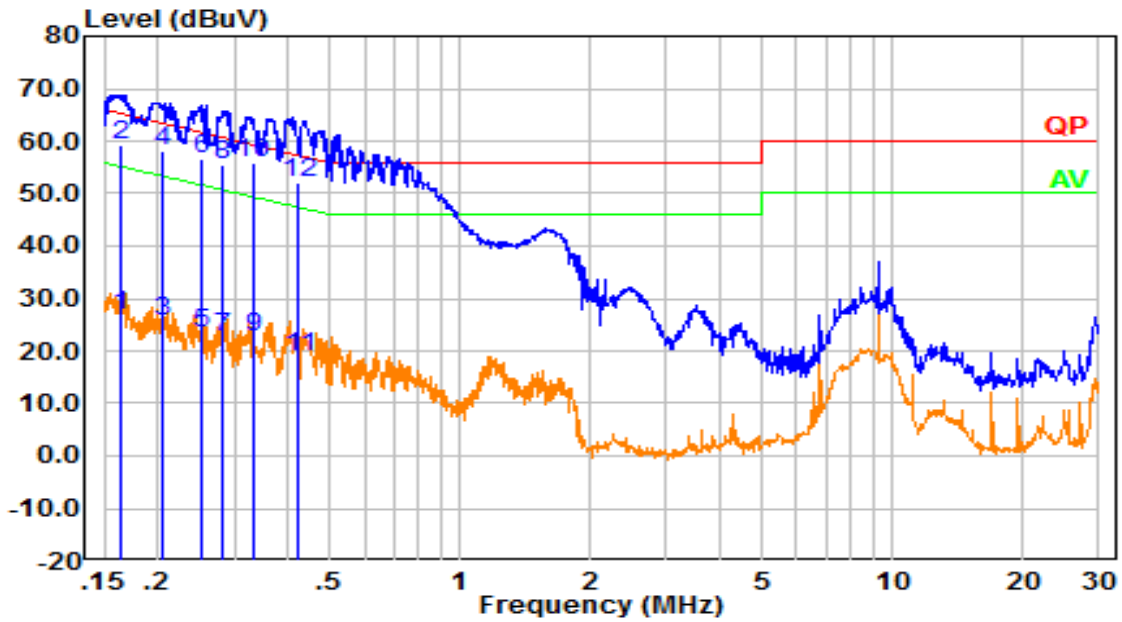

No.	Frequency (MHz)	Reading (dBμV)	Factor (dB)	Result (dBμV)	Limit (dBμV)	Margin (dB)	Detector
1	0.164	17.02	9.61	26.63	55.27	28.64	Average
2	0.164	49.74	9.61	59.35	65.27	5.92	QP
3	0.205	16.01	9.61	25.62	53.40	27.78	Average
4	0.205	48.67	9.61	58.28	63.40	5.12	QP
5	0.251	13.73	9.61	23.34	51.71	28.37	Average
6	0.251	46.91	9.61	56.52	61.71	5.19	QP
7	0.283	13.01	9.61	22.62	50.73	28.11	Average
8	0.283	46.00	9.61	55.61	60.73	5.12	QP
9	0.331	13.00	9.61	22.61	49.43	26.83	Average
10	0.331	46.23	9.61	55.84	59.43	3.59	QP
11	0.422	9.36	9.61	18.97	47.41	28.44	Average
12	0.422	42.62	9.61	52.23	57.41	5.18	QP

Neutral:

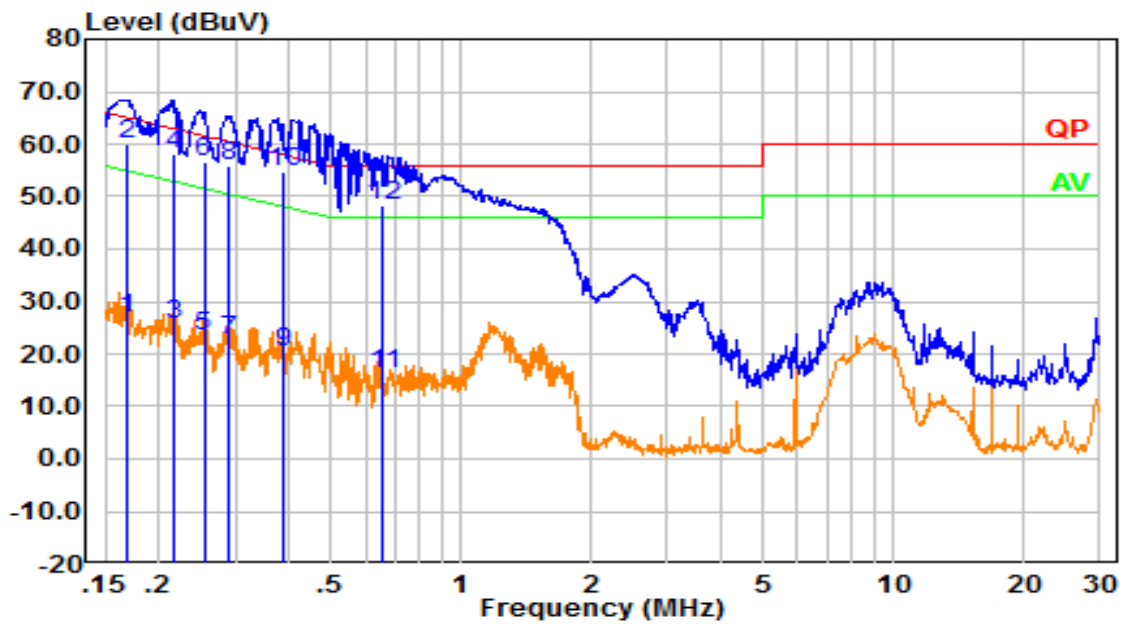

No.	Frequency (MHz)	Reading (dB μ V)	Factor (dB)	Result (dB μ V)	Limit (dB μ V)	Margin (dB)	Detector
1	0.169	17.26	9.61	26.87	55.02	28.15	Average
2	0.169	50.51	9.61	60.12	65.02	4.90	QP
3	0.215	16.04	9.61	25.65	53.00	27.35	Average
4	0.215	48.52	9.61	58.13	63.00	4.87	QP
5	0.254	13.60	9.61	23.21	51.63	28.42	Average
6	0.254	47.03	9.61	56.64	61.63	4.99	QP
7	0.288	13.16	9.61	22.77	50.57	27.80	Average
8	0.288	46.40	9.61	56.01	60.57	4.56	QP
9	0.387	10.65	9.61	20.26	48.13	27.87	Average
10	0.387	45.21	9.61	54.82	58.13	3.31	QP
11	0.659	6.54	9.62	16.16	46.00	29.84	Average
12	0.659	38.63	9.62	48.25	56.00	7.75	QP

4.2 Radiation Spurious Emissions

Serial Number:	CR22080030-RF-S1	Test Date:	2022/09/05~2022/09/26
Test Site:	966-1,966-2	Test Mode:	Transmitting
Tester:	coco Tian, Carl Xue	Test Result:	Pass

Environmental Conditions:

Temperature: (°C)	25.8~26.3	Relative Humidity: (%)	53~54	ATM Pressure: (kPa)	100~100.1
----------------------	-----------	---------------------------	-------	------------------------	-----------

Test Equipment List and Details:

Manufacturer	Description	Model	Serial Number	Calibration Date	Calibration Due Date
Sunol Sciences	Antenna	JB6	A082520-5	2020/10/19	2023/10/18
R&S	EMI Test Receiver	ESR3	102724	2022/07/15	2023/07/14
TIMES MICROWAVE	Coaxial Cable	LMR-600-UltraFlex	C-0470-02	2022/07/17	2023/07/16
TIMES MICROWAVE	Coaxial Cable	LMR-600-UltraFlex	C-0780-01	2022/07/17	2023/07/16
Sonoma	Amplifier	310N	186165	2022/07/17	2023/07/16
ETS-Lindgren	Horn Antenna	3115	9912-5985	2020/10/13	2023/10/12
R&S	Spectrum Analyzer	FSV40	101591	2022/07/15	2023/07/14
MICRO-COAX	Coaxial Cable	UFA210A-1-1200-70U300	217423-008	2022/08/07	2023/08/06
MICRO-COAX	Coaxial Cable	UFA210A-1-2362-300300	235780-001	2022/08/07	2023/08/06
Mini	Pre-amplifier	ZVA-183-S+	5969001149	2021/11/10	2022/11/09
Audix	Test Software	E3	201021 (V9)	N/A	N/A
PASTERNAK	Horn Antenna	PE9852/2F-20	112002	2021/02/05	2024/02/04
AH	Preamplifier	PAM-1840VH	190	2021/11/19	2022/11/18
MICRO-COAX	Coaxial Cable	UFB142A-1-2362-200200	235772-001	2022/08/07	2023/08/06
PASTERNAK	Horn Antenna	PE9850/2F-20	072001	2021/02/05	2024/02/04
OML	Harmonic Mixer	WR19/M19HWD	U60314-1	2020/10/16	2023/10/15
OML	Horn Antenna	M19RH	11648-03	2020/10/16	2023/10/15
OML	Harmonic Mixer	WR12/M12HWD	E60119-1	2020/10/17	2023/10/16
OML	Horn Antenna	M12RH	E60119-2	2020/10/18	2023/10/17
OML	Harmonic Mixer	WR08/M08HWD	F60315-1	2020/10/22	2023/10/21
OML	Horn Antenna	M08RH	F60315-2	2020/10/24	2023/10/23
OML	Harmonic Mixer	WR05/M05HWD	G60107-1	2020/10/25	2023/10/24
OML	Horn Antenna	M05RH	G60107-2	2020/10/26	2023/10/25

*** Statement of Traceability:** China Certification ICT Co., Ltd (Dongguan) attests that all calibrations have been performed, traceable to National Primary Standards and International System of Units (SI).

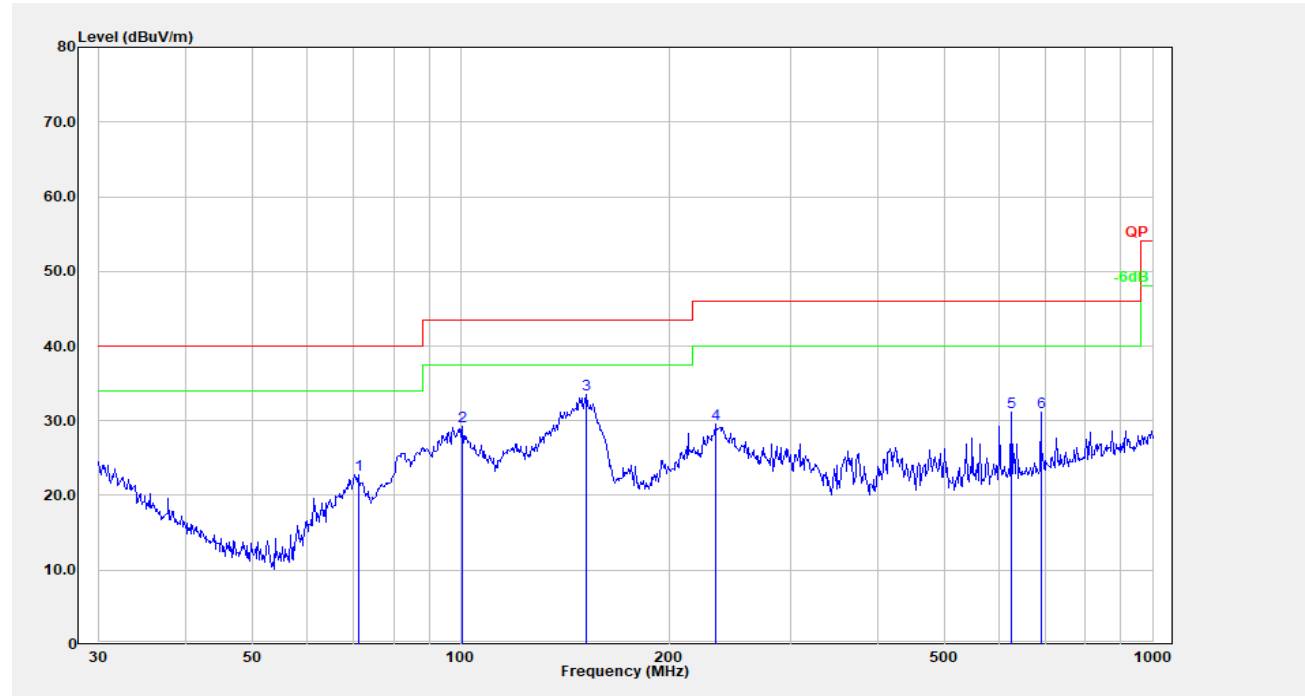
Test Data:1) 30MHz-1GHz($\pi/2$ -16QAM low channel was the worst):**POE:****Horizontal:**

No.	Frequency (MHz)	Reading (dB μ V)	Factor (dB/m)	Result (dB μ V/m)	Limit (dB μ V/m)	Margin (dB)	Detector
1	71.080	39.65	-16.84	22.81	40.00	17.19	Peak
2	100.581	43.68	-14.44	29.24	43.50	14.26	Peak
3	152.130	45.77	-12.28	33.49	43.50	10.01	Peak
4	233.349	42.76	-13.22	29.54	46.00	16.46	Peak
5	625.078	36.02	-4.84	31.18	46.00	14.82	Peak
6	689.565	34.85	-3.75	31.10	46.00	14.90	Peak

Vertical:

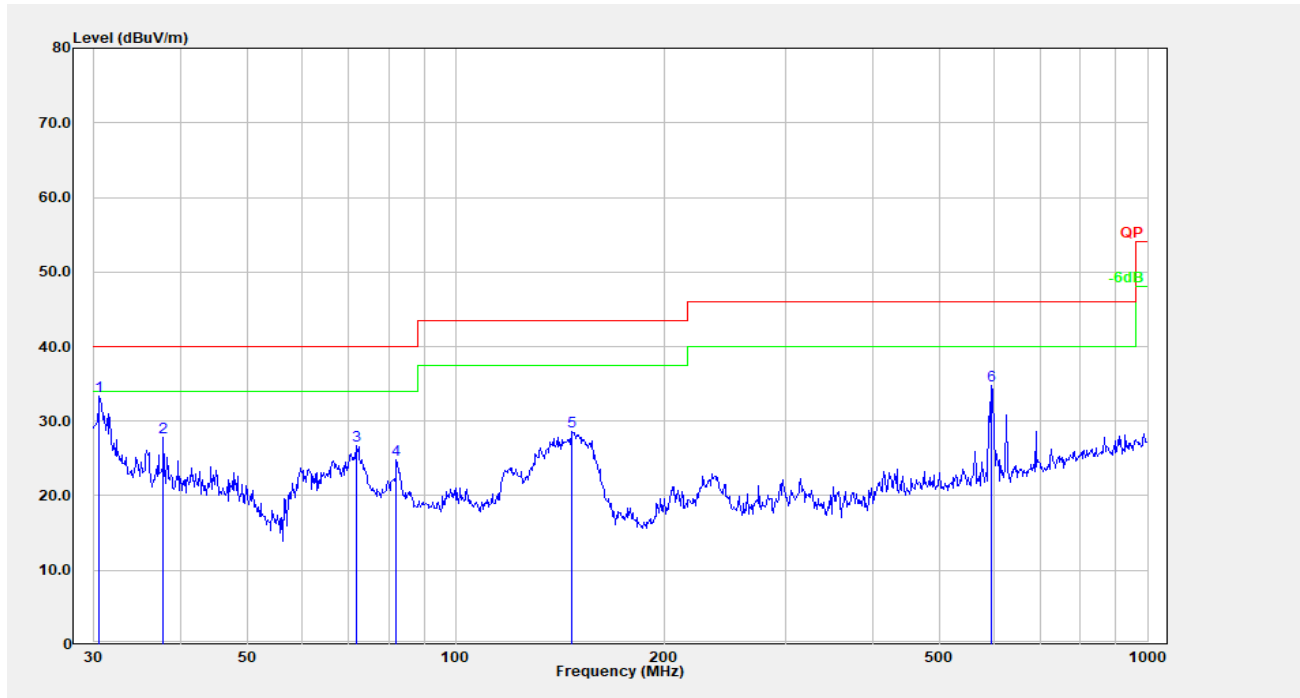

No.	Frequency (MHz)	Reading (dBμV)	Factor (dB/m)	Result (dBμV/m)	Limit (dBμV/m)	Margin (dB)	Detector
1	30.531	37.56	-4.20	33.37	40.00	6.63	Peak
2	37.812	37.60	-9.77	27.83	40.00	12.17	Peak
3	71.832	43.62	-16.91	26.71	40.00	13.29	Peak
4	82.071	42.39	-17.60	24.79	40.00	15.21	Peak
5	146.888	40.81	-12.23	28.58	43.50	14.92	Peak
6	595.133	40.21	-5.42	34.79	46.00	11.21	Peak

DC Power:
Horizontal:

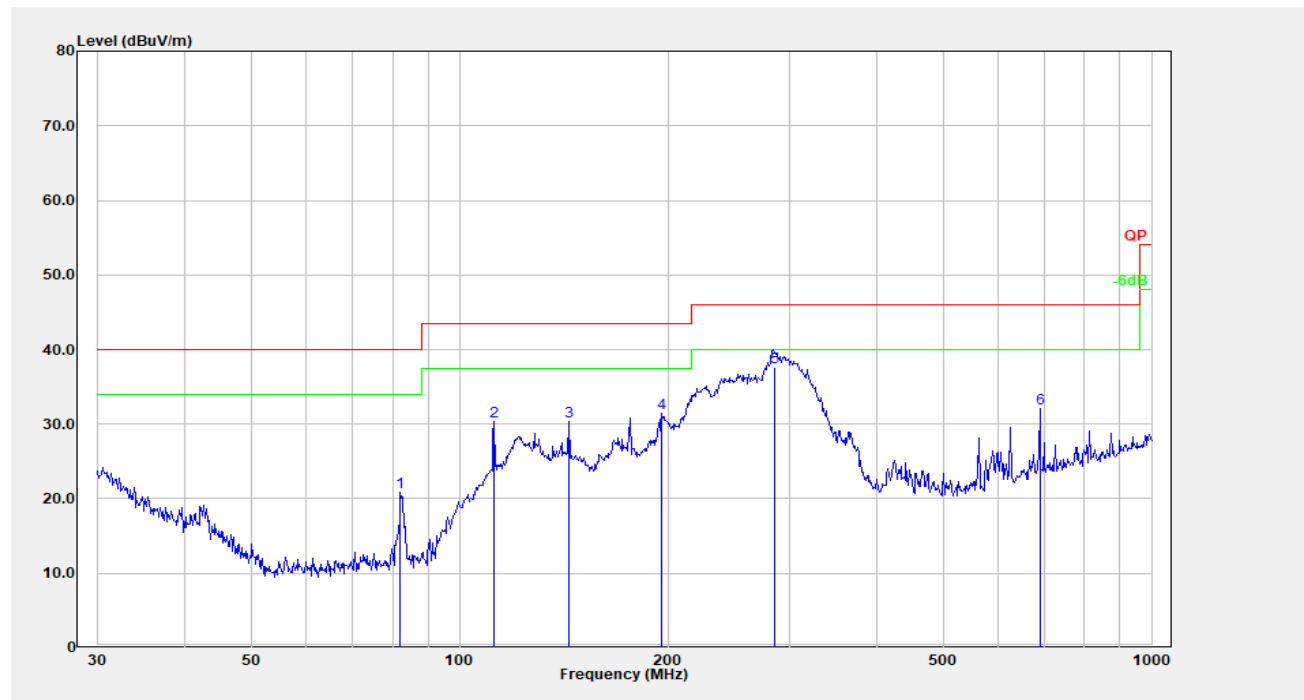

No.	Frequency (MHz)	Reading (dBμV)	Factor (dB/m)	Result (dBμV/m)	Limit (dBμV/m)	Margin (dB)	Detector
1	82.071	38.52	-17.60	20.91	40.00	19.09	Peak
2	112.131	42.82	-12.40	30.42	43.50	13.08	Peak
3	143.830	42.54	-12.20	30.34	43.50	13.16	Peak
4	195.822	44.34	-12.82	31.51	43.50	11.99	Peak
5	284.853	49.22	-11.55	37.67	46.00	8.33	QP
6	689.565	35.77	-3.75	32.02	46.00	13.98	Peak

Vertical:

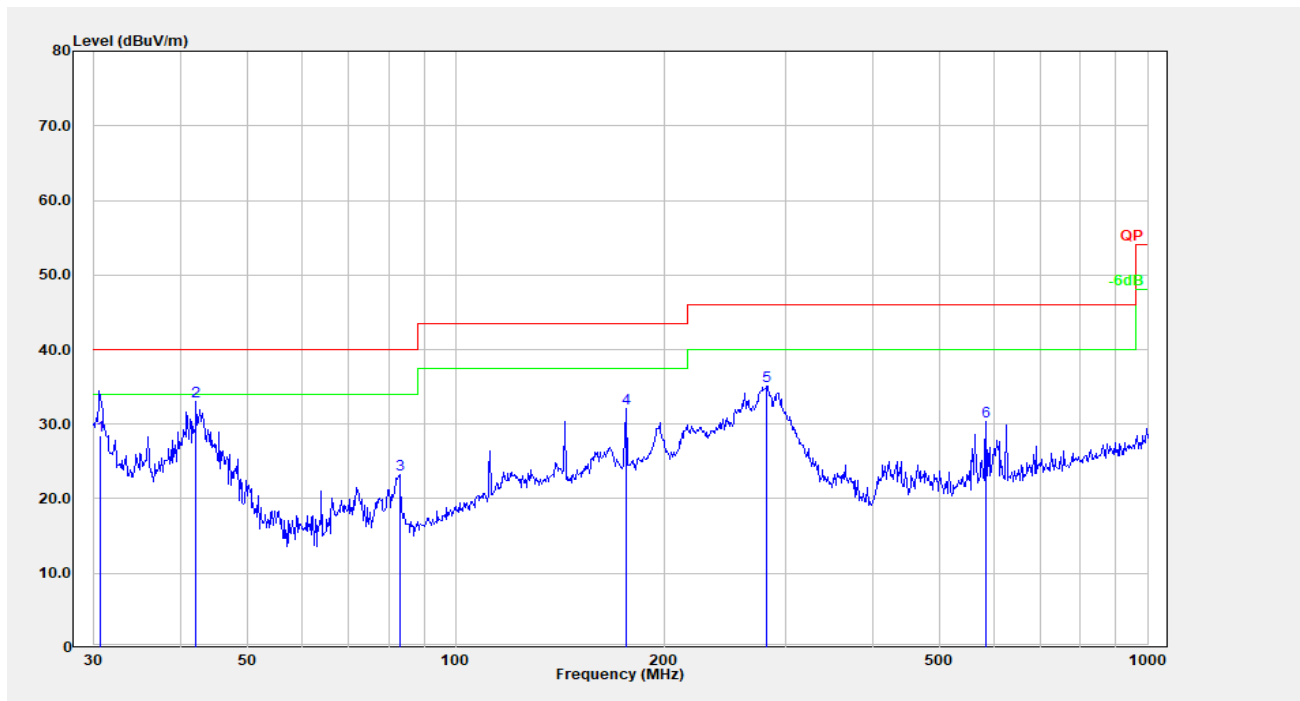

No.	Frequency (MHz)	Reading (dB μ V)	Factor (dB/m)	Result (dB μ V/m)	Limit (dB μ V/m)	Margin (dB)	Detector
1	30.666	32.74	-4.30	28.44	40.00	11.56	QP
2	42.154	45.84	-12.77	33.07	40.00	6.93	Peak
3	82.938	40.82	-17.50	23.32	40.00	16.68	Peak
4	176.269	45.68	-13.53	32.15	43.50	11.35	Peak
5	281.995	46.87	-11.73	35.14	46.00	10.86	Peak
6	584.790	36.04	-5.73	30.31	46.00	15.69	Peak

2) 1GHz-40GHz(POE was the worst): **$\pi/2$ -BPSK:**

Frequency (MHz)	Receiver		Polar (H/V)	Factor (dB/m)	Result (dB μ V/m)	Limit (dB μ V/m)	Margin (dB)
	Reading (dB μ V)	Detector					
Low Channel:				58.32	GHz		
2397.60	45.03	PK	H	3.52	48.55	74.00	25.45
2397.60	33.02	AV	H	3.52	36.54	54.00	17.46
1822.90	44.88	PK	V	1.40	46.28	74.00	27.72
1822.90	32.44	AV	V	1.40	33.84	54.00	20.16
23517.60	52.71	PK	H	5.96	58.67	74.00	15.33
23517.60	40.36	AV	H	5.96	46.32	54.00	7.68
21300.30	52.24	PK	V	5.27	57.51	74.00	16.49
21300.30	40.12	AV	V	5.27	45.39	54.00	8.61
39257.30	52.55	PK	H	16.41	62.94	74.00	11.06
39257.30	40.01	AV	H	16.41	50.40	54.00	3.60
36579.30	53.59	PK	V	13.71	61.28	74.00	12.72
36579.30	41.06	AV	V	13.71	48.75	54.00	5.25
Middle Channel:				64.8	GHz		
2397.60	44.00	PK	H	3.52	47.52	74.00	26.48
2397.60	32.00	AV	H	3.52	35.52	54.00	18.48
1829.70	51.30	PK	V	1.43	52.73	74.00	21.27
1829.70	39.15	AV	V	1.43	40.58	54.00	13.42
23398.50	51.83	PK	H	6.04	57.87	74.00	16.13
23398.50	39.42	AV	H	6.04	45.46	54.00	8.54
21104.80	52.38	PK	V	5.50	57.88	74.00	16.12
21104.80	40.20	AV	V	5.50	45.70	54.00	8.30
36605.40	53.50	PK	H	13.78	61.26	74.00	12.74
36605.40	41.23	AV	H	13.78	48.99	54.00	5.01
39554.40	52.87	PK	V	15.91	62.76	74.00	11.24
39554.40	40.36	AV	V	15.91	50.25	54.00	3.75
High Channel:				69.12	GHz		
2397.60	44.11	PK	H	3.52	47.63	74.00	26.37
2397.60	32.06	AV	H	3.52	35.58	54.00	18.42
1812.70	46.64	PK	V	1.35	47.99	74.00	26.01
1812.70	34.32	AV	V	1.35	35.67	54.00	18.33
20591.30	52.15	PK	H	5.74	57.89	74.00	16.11
20591.30	40.08	AV	H	5.74	45.82	54.00	8.18
21747.50	52.48	PK	V	5.12	57.60	74.00	16.40
21747.50	40.24	AV	V	5.12	45.36	54.00	8.64
39273.50	52.05	PK	H	16.39	62.42	74.00	11.58
39273.50	40.00	AV	H	16.39	50.37	54.00	3.63
33654.00	53.70	PK	V	15.07	62.75	74.00	11.25
33654.00	41.31	AV	V	15.07	50.36	54.00	3.64

π 2-QPSK:

Frequency (MHz)	Receiver		Polar (H/V)	Factor (dB/m)	Result (dB μ V/m)	Limit (dB μ V/m)	Margin (dB)
	Reading (dB μ V)	Detector					
Low Channel: 58.32 GHz							
2397.60	45.35	PK	H	3.52	48.87	74.00	25.13
2397.60	33.41	AV	H	3.52	36.93	54.00	17.07
1822.90	44.94	PK	V	1.40	46.34	74.00	27.66
1822.90	32.06	AV	V	1.40	33.46	54.00	20.54
23517.60	52.89	PK	H	5.96	58.85	74.00	15.15
23517.60	40.00	AV	H	5.96	45.96	54.00	8.04
21300.30	52.67	PK	V	5.27	57.94	74.00	16.06
21300.30	40.27	AV	V	5.27	45.54	54.00	8.46
39257.30	51.12	PK	H	16.41	61.51	74.00	12.49
39257.30	39.06	AV	H	16.41	49.45	54.00	4.55
36579.30	53.36	PK	V	13.71	61.05	74.00	12.95
36579.30	41.19	AV	V	13.71	48.88	54.00	5.12
Middle Channel: 64.8 GHz							
2397.60	43.75	PK	H	3.52	47.27	74.00	26.73
2397.60	31.95	AV	H	3.52	35.47	54.00	18.53
1829.70	50.83	PK	V	1.43	52.26	74.00	21.74
1829.70	38.66	AV	V	1.43	40.09	54.00	13.91
23398.50	52.30	PK	H	6.04	58.34	74.00	15.66
23398.50	39.52	AV	H	6.04	45.56	54.00	8.44
21104.80	52.22	PK	V	5.50	57.72	74.00	16.28
21104.80	40.23	AV	V	5.50	45.73	54.00	8.27
36605.40	53.61	PK	H	13.78	61.37	74.00	12.63
36605.40	41.09	AV	H	13.78	48.85	54.00	5.15
39554.40	53.17	PK	V	15.91	63.06	74.00	10.94
39554.40	40.47	AV	V	15.91	50.36	54.00	3.64
High Channel: 69.12 GHz							
2397.60	44.20	PK	H	3.52	47.72	74.00	26.28
2397.60	31.85	AV	H	3.52	35.37	54.00	18.63
1812.70	46.24	PK	V	1.35	47.59	74.00	26.41
1812.70	34.48	AV	V	1.35	35.83	54.00	18.17
20591.30	52.23	PK	H	5.74	57.97	74.00	16.03
20591.30	39.82	AV	H	5.74	45.56	54.00	8.44
21747.50	52.23	PK	V	5.12	57.35	74.00	16.65
21747.50	40.68	AV	V	5.12	45.80	54.00	8.20
39273.50	51.52	PK	H	16.39	61.89	74.00	12.11
39273.50	39.19	AV	H	16.39	49.56	54.00	4.44
33654.00	53.41	PK	V	15.07	62.46	74.00	11.54
33654.00	41.11	AV	V	15.07	50.16	54.00	3.84

π 2-16QAM:

Frequency (MHz)	Receiver		Polar (H/V)	Factor (dB/m)	Result (dB μ V/m)	Limit (dB μ V/m)	Margin (dB)
	Reading (dB μ V)	Detector					
Low Channel: 58.32 GHz							
2397.60	45.78	PK	H	3.52	49.30	74.00	24.70
2397.60	32.26	AV	H	3.52	35.78	54.00	18.22
1822.90	45.20	PK	V	1.40	46.60	74.00	27.40
1822.90	31.68	AV	V	1.40	33.08	54.00	20.92
23517.60	53.19	PK	H	5.96	59.15	74.00	14.85
23517.60	40.11	AV	H	5.96	46.07	54.00	7.93
21300.30	52.85	PK	V	5.27	58.12	74.00	15.88
21300.30	40.61	AV	V	5.27	45.88	54.00	8.12
39257.30	53.31	PK	H	16.41	63.70	74.00	10.30
39257.30	39.69	AV	H	16.41	50.08	54.00	3.92
36579.30	54.24	PK	V	13.71	61.93	74.00	12.07
36579.30	41.80	AV	V	13.71	49.49	54.00	4.51
Middle Channel: 64.8 GHz							
2397.60	43.80	PK	H	3.52	47.32	74.00	26.68
2397.60	31.55	AV	H	3.52	35.07	54.00	18.93
1829.70	50.55	PK	V	1.43	51.98	74.00	22.02
1829.70	38.50	AV	V	1.43	39.93	54.00	14.07
23398.50	51.32	PK	H	6.04	57.36	74.00	16.64
23398.50	39.85	AV	H	6.04	45.89	54.00	8.11
21104.80	52.29	PK	V	5.50	57.79	74.00	16.21
21104.80	40.06	AV	V	5.50	45.56	54.00	8.44
36605.40	54.32	PK	H	13.78	62.08	74.00	11.92
36605.40	42.13	AV	H	13.78	49.89	54.00	4.11
39554.40	51.90	PK	V	15.91	61.79	74.00	12.21
39554.40	39.45	AV	V	15.91	49.34	54.00	4.66
High Channel: 69.12 GHz							
2397.60	44.70	PK	H	3.52	48.22	74.00	25.78
2397.60	31.35	AV	H	3.52	34.87	54.00	19.13
1812.70	46.89	PK	V	1.35	48.24	74.00	25.76
1812.70	34.60	AV	V	1.35	35.95	54.00	18.05
20591.30	52.30	PK	H	5.74	58.04	74.00	15.96
20591.30	40.05	AV	H	5.74	45.79	54.00	8.21
21747.50	52.12	PK	V	5.12	57.24	74.00	16.76
21747.50	40.49	AV	V	5.12	45.61	54.00	8.39
39273.50	50.07	PK	H	16.39	60.44	74.00	13.56
39273.50	38.46	AV	H	16.39	48.83	54.00	5.17
33654.00	54.24	PK	V	15.07	63.29	74.00	10.71
33654.00	40.96	AV	V	15.07	50.01	54.00	3.99

3) 40-200GHz: **π 2-BPSK:**

Frequency (GHz)	Receiver		Polar (H/V)	Factor (dB/m)	Field Strength (dB μ V/m)	Power Density (pW/cm ²)	Limit (pW/cm ²)
	Reading (dB μ V)	Detector					
Low Channel:				58.32	GHz		
52.320	48.64	PK	H	40.71	79.81	25.39	90.00
53.210	49.61	PK	V	40.85	80.92	32.78	90.00
71.650	48.57	PK	H	43.73	82.76	50.08	90.00
72.400	47.65	PK	V	43.84	81.95	41.56	90.00
92.350	49.57	PK	H	45.40	79.41	23.16	90.00
93.010	50.32	PK	V	45.48	80.24	28.03	90.00
192.400	47.55	PK	H	51.19	83.18	55.16	90.00
193.240	46.74	PK	V	51.22	82.40	46.10	90.00
Middle Channel:				64.8	GHz		
52.440	48.62	PK	H	40.73	79.81	25.39	90.00
50.980	48.22	PK	V	40.50	79.18	21.96	90.00
72.610	48.17	PK	H	43.88	82.51	47.28	90.00
73.140	48.22	PK	V	43.96	82.64	48.71	90.00
93.240	50.33	PK	H	45.51	80.28	28.29	90.00
92.640	49.21	PK	V	45.43	79.08	21.46	90.00
192.340	46.32	PK	H	51.18	81.94	41.46	90.00
192.410	47.22	PK	V	51.19	82.85	51.13	90.00
High Channel:				69.12	GHz		
51.340	49.65	PK	H	40.56	80.67	30.95	90.00
52.550	48.66	PK	V	40.75	79.87	25.73	90.00
72.640	48.20	PK	H	43.88	82.54	47.61	90.00
72.810	48.65	PK	V	43.91	83.02	53.17	90.00
92.300	50.33	PK	H	45.39	80.16	27.52	90.00
93.140	50.62	PK	V	45.49	80.55	30.11	90.00
192.740	46.20	PK	H	51.20	81.84	40.52	90.00
193.540	48.21	PK	V	51.24	83.89	64.96	90.00

π 2-QPSK:

Frequency (GHz)	Receiver		Polar (H/V)	Factor (dB/m)	Field Strength (dB μ V/m)	Power Density (pW/cm ²)	Limit (pW/cm ²)
	Reading (dB μ V)	Detector					
Low Channel:				58.32	GHz		
53.200	49.24	PK	H	40.85	80.55	30.11	90.00
52.140	50.20	PK	V	40.68	81.34	36.11	90.00
74.510	48.51	PK	H	44.17	83.14	54.66	90.00
73.620	49.22	PK	V	44.03	83.71	62.32	90.00
92.240	50.66	PK	H	45.38	80.48	29.63	90.00
93.200	51.57	PK	V	45.50	81.51	37.55	90.00
191.240	45.62	PK	H	51.14	81.20	34.97	90.00
192.060	46.52	PK	V	51.17	82.13	43.32	90.00
Middle Channel:				64.8	GHz		
52.200	48.62	PK	H	40.69	79.77	25.16	90.00
53.140	49.52	PK	V	40.84	80.82	32.04	90.00
73.240	47.21	PK	H	43.98	81.65	38.78	90.00
72.590	48.22	PK	V	43.87	82.55	47.72	90.00
92.110	49.21	PK	H	45.37	79.02	21.17	90.00
93.180	50.32	PK	V	45.50	80.26	28.16	90.00
192.040	46.19	PK	H	51.17	81.80	40.15	90.00
192.650	47.35	PK	V	51.20	82.99	52.80	90.00
High Channel:				69.12	GHz		
53.240	49.65	PK	H	40.86	80.97	33.16	90.00
52.740	48.62	PK	V	40.78	79.86	25.68	90.00
72.110	49.21	PK	H	43.80	83.47	58.97	90.00
73.620	49.52	PK	V	44.03	84.01	66.78	90.00
93.140	50.20	PK	H	45.49	80.13	27.33	90.00
92.580	51.47	PK	V	45.42	81.33	36.03	90.00
192.570	46.51	PK	H	51.19	82.14	43.42	90.00
192.650	47.25	PK	V	51.20	82.89	51.60	90.00

π 2-16QAM:

Frequency (GHz)	Receiver		Polar (H/V)	Factor (dB/m)	Field Strength (dB μ V/m)	Power Density (pW/cm ²)	Limit (pW/cm ²)	
	Reading (dB μ V)	Detector						
Low Channel:				58.32	GHz			
53.690	49.65	PK	H	40.93	81.04	33.70	90.00	
54.680	50.32	PK	V	41.08	81.86	40.71	90.00	
73.620	48.74	PK	H	44.03	83.23	55.80	90.00	
72.540	49.62	PK	V	43.87	83.95	65.87	90.00	
93.140	49.65	PK	H	45.49	79.58	24.08	90.00	
92.540	50.74	PK	V	45.42	80.60	30.46	90.00	
193.650	45.32	PK	H	51.24	81.00	33.39	90.00	
193.570	47.51	PK	V	51.24	83.19	55.29	90.00	
Middle Channel:				64.8	GHz			
53.240	49.62	PK	H	40.86	80.94	32.94	90.00	
52.870	50.65	PK	V	40.80	81.91	41.18	90.00	
73.210	48.65	PK	H	43.97	83.08	53.93	90.00	
72.650	49.01	PK	V	43.88	83.35	57.37	90.00	
93.650	48.65	PK	H	45.56	78.65	19.44	90.00	
92.480	49.62	PK	V	45.41	79.47	23.48	90.00	
192.870	45.32	PK	H	51.21	80.97	33.16	90.00	
192.660	46.11	PK	V	51.20	81.75	39.69	90.00	
High Channel:				69.12	GHz			
52.740	47.00	PK	H	40.78	78.24	17.69	90.00	
53.500	48.21	PK	V	40.90	79.57	24.02	90.00	
72.950	48.65	PK	H	43.93	83.04	53.41	90.00	
73.010	47.55	PK	V	43.94	81.95	41.56	90.00	
93.240	48.65	PK	H	45.51	78.60	19.22	90.00	
92.660	49.62	PK	V	45.43	79.49	23.59	90.00	
192.540	45.00	PK	H	51.19	80.63	30.67	90.00	
193.600	45.87	PK	V	51.24	81.55	37.90	90.00	

Note:

Factor = Antenna Factor

Field Strength = Reading + Factor + 20log(dMeas/dSpecLimit)

dMeas is the measurement distance, in m

dSpecLimit is the distance specified by the limit, in m

$$PD = \frac{E_{\text{SpecLimit}}^2}{377}$$

where

PD is the power density at the distance specified by the limit, in W/m²
 $E_{\text{SpecLimit}}$ is the field strength at the distance specified by the limit, in V/m

The Specified distance is 3m.

Test Plots ($\pi/2$ -BPSK low channel was the worst)

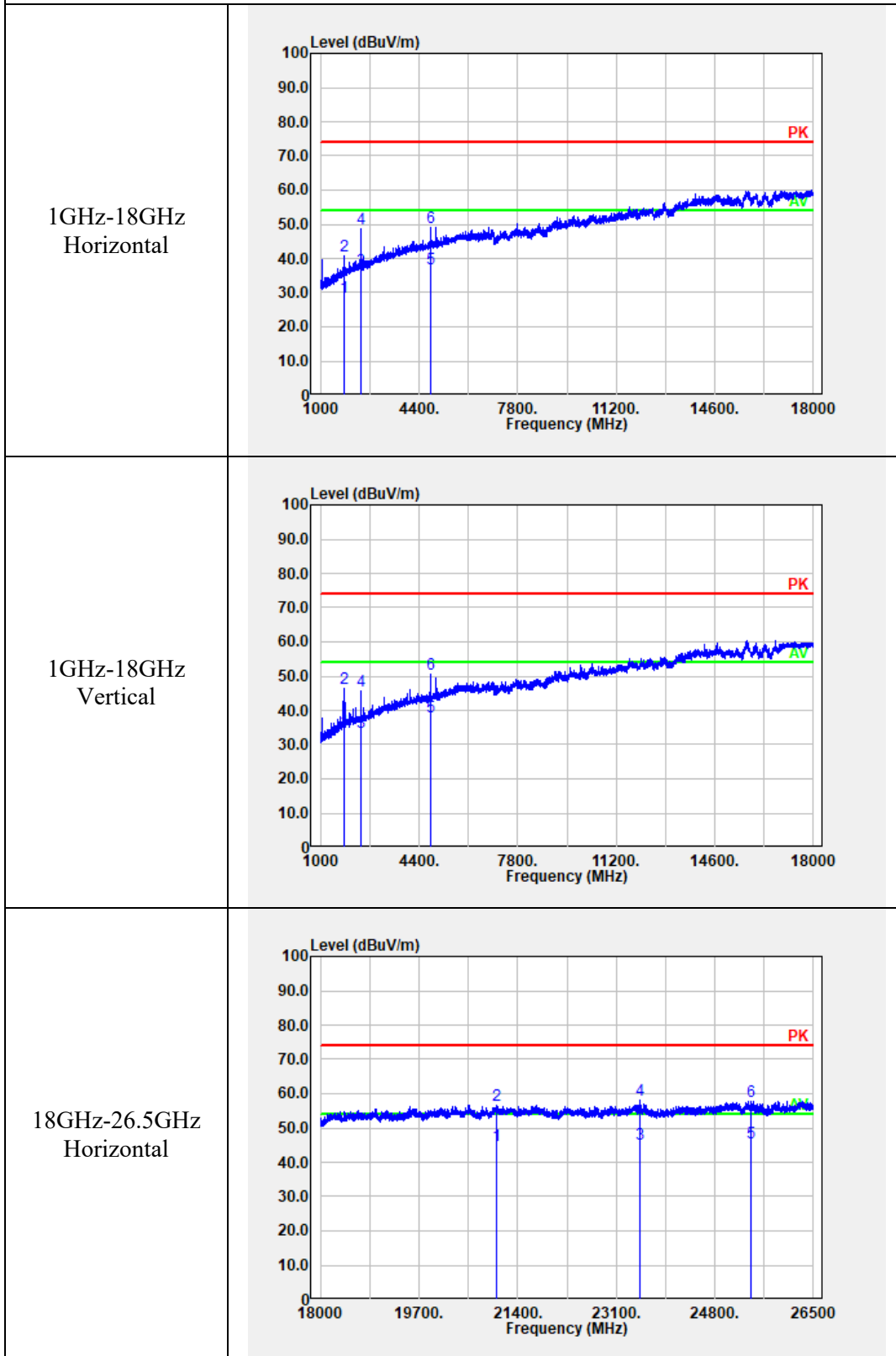

Test Plots

<p>18GHz-26.5GHz Vertical</p>	
<p>26.5GHz-40GHz Horizontal</p>	
<p>26.5GHz-40GHz Vertical</p>	

4.3 Emission Bandwidth:

Serial Number:	CR22080030-RF-S1	Test Date:	2022/09/23
Test Site:	966-1	Test Mode:	Transmitting
Tester:	coco Tian	Test Result:	N/A

Environmental Conditions:

Temperature: (°C)	26.5	Relative Humidity: (%)	57	ATM Pressure: (kPa)	101.2
----------------------	------	---------------------------	----	------------------------	-------

Test Equipment List and Details:

Manufacturer	Description	Model	Serial Number	Calibration Date	Calibration Due Date
Agilent	Spectrum Analyzer	E4440A	MY44303354	2022/07/15	2023/07/14
Agilent	Harmonic Mixer	Agilent 11970V	2521A01768	2020/11/08	2023/11/07
Flann Microwave	Horn Antenna	861V/385	738	2020/11/08	2023/11/07
BACL	Test Software	E4440A	V1.1	N/A	N/A

** Statement of Traceability: China Certification ICT Co., Ltd (Dongguan) attests that all calibrations have been performed, traceable to National Primary Standards and International System of Units (SI).*

Test Data:

Test Modes	Test Frequency (GHz)	6 dB Emission Bandwidth (GHz)	20 dB Emission Bandwidth (GHz)
$\pi/2$ -BPSK	58.32	0.983	2.131
	64.80	1.008	2.072
	69.12	1.403	2.097
$\pi/2$ -QPSK	58.32	1.625	2.018
	64.80	1.713	2.228
	69.12	1.641	2.213
$\pi/2$ -16QAM	58.32	1.686	1.969
	64.80	1.449	2.055
	69.12	1.174	2.197

6dB Emission Bandwidth

58.32 GHz
 $\pi/2$ -BPSK

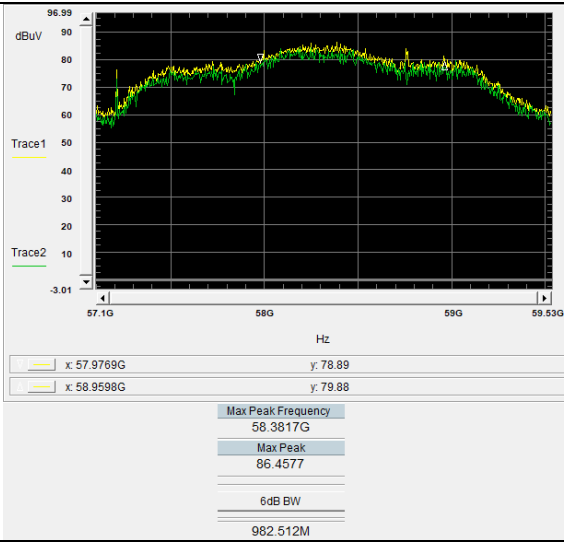

64.8 GHz
 $\pi/2$ -BPSK

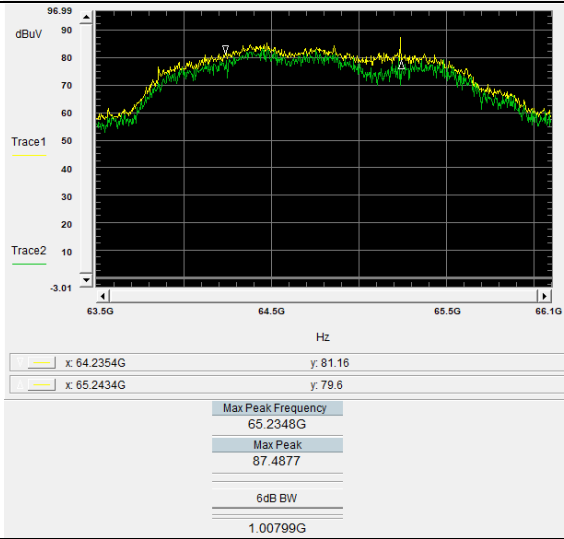

69.12 GHz
 $\pi/2$ -BPSK

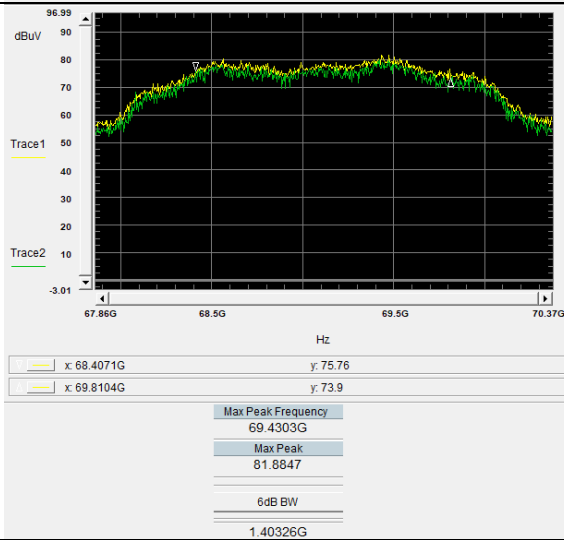

6dB Emission Bandwidth

58.32 GHz
 $\pi/2$ -QPSK

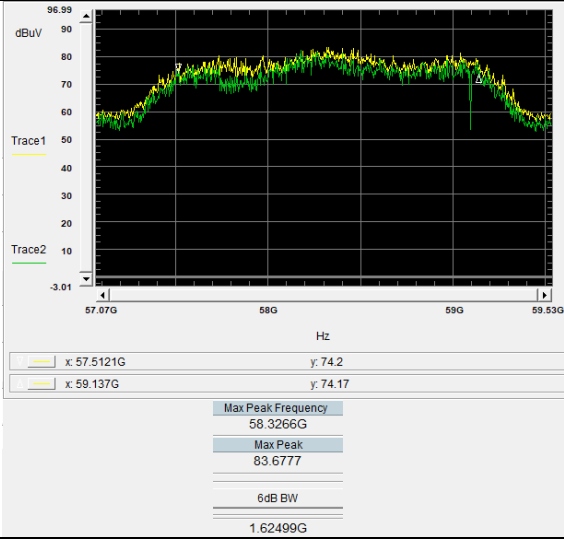

64.8 GHz
 $\pi/2$ -QPSK

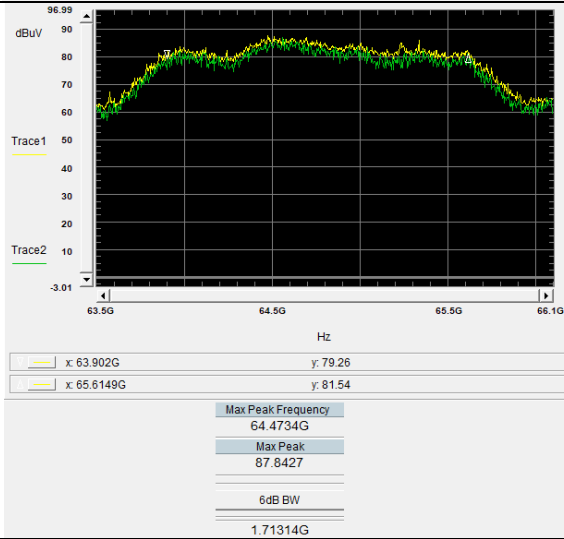

69.12 GHz
 $\pi/2$ -QPSK

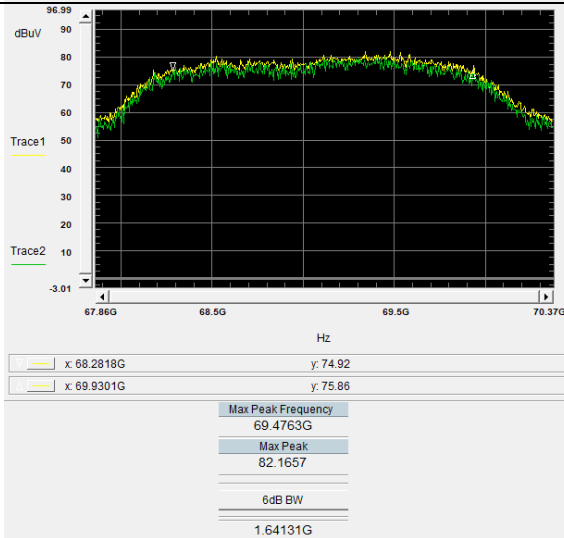

6dB Emission Bandwidth	
<p>58.32 GHz $\pi/2$-16QAM</p>	<p>Max Peak Frequency: 58.3143G Max Peak: 85.7907 6dB BW: 1.68639G</p>
<p>64.8 GHz $\pi/2$-16QAM</p>	<p>Max Peak Frequency: 64.9363G Max Peak: 84.0027 6dB BW: 1.44925G</p>
<p>69.12 GHz $\pi/2$-16QAM</p>	<p>Max Peak Frequency: 69.2006G Max Peak: 86.1697 6dB BW: 1.17356G</p>

20dB Emission Bandwidth

58.32 GHz
 $\pi/2$ -BPSK

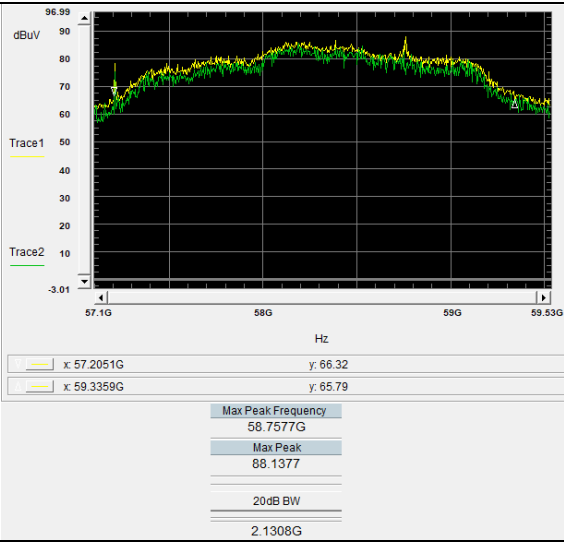

64.8 GHz
 $\pi/2$ -BPSK

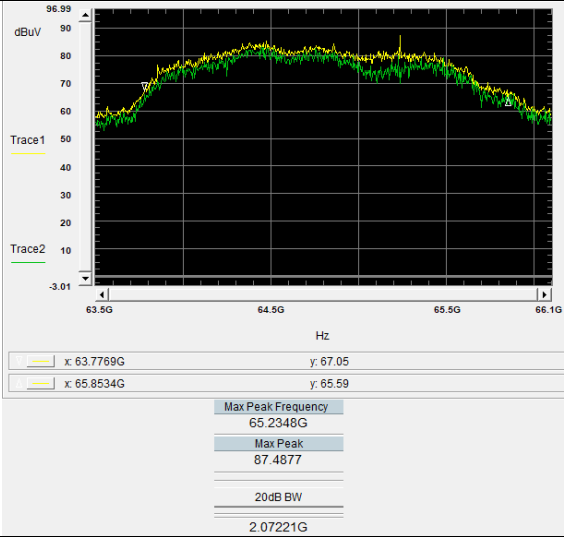

69.12 GHz
 $\pi/2$ -BPSK

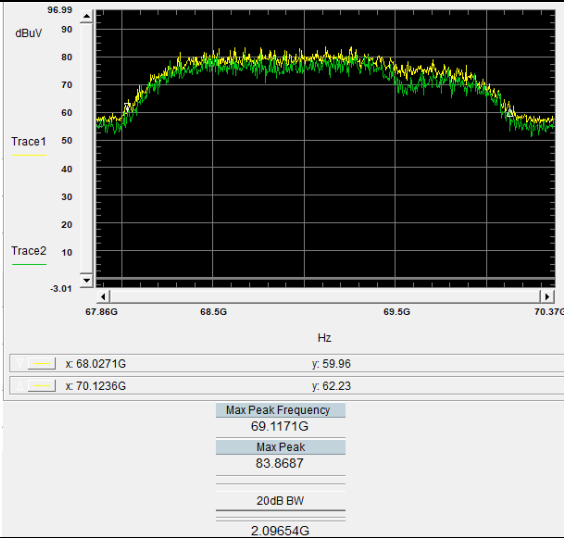

20dB Emission Bandwidth

58.32 GHz
 $\pi/2$ -QPSK

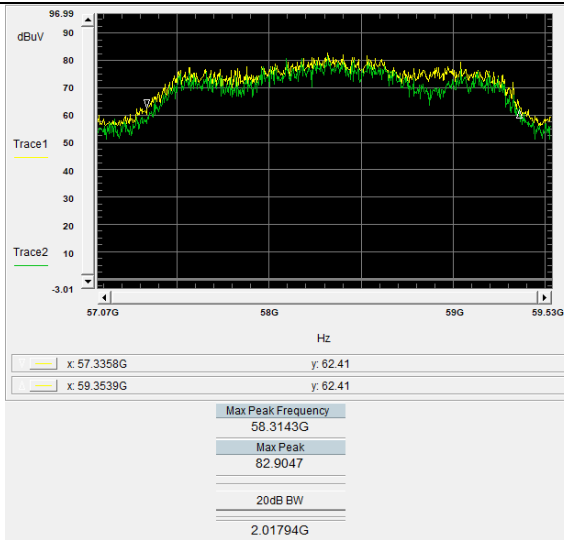

64.8 GHz
 $\pi/2$ -QPSK

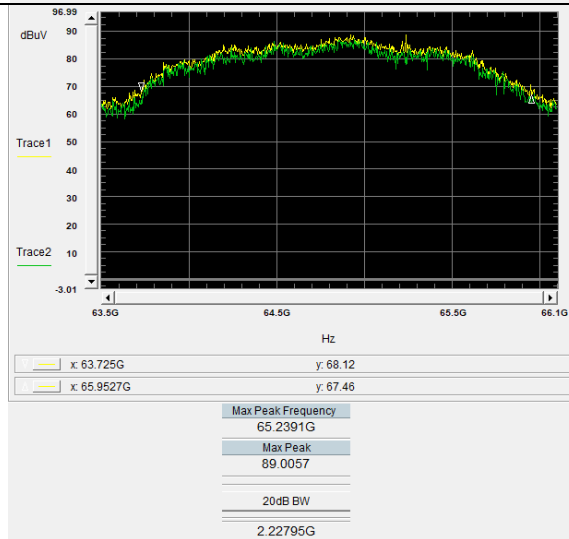

69.12 GHz
 $\pi/2$ -QPSK

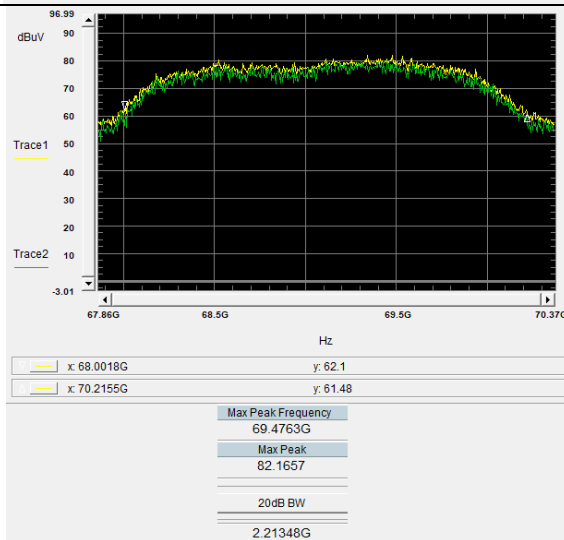

20dB Emission Bandwidth

58.32 GHz
 $\pi/2$ -16QAM

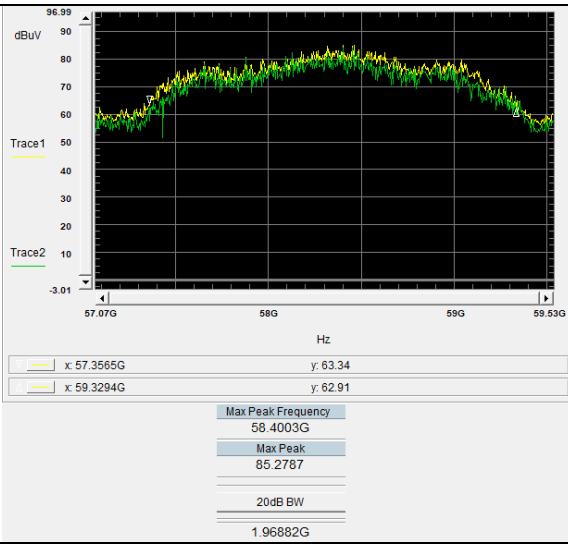

64.8 GHz
 $\pi/2$ -16QAM

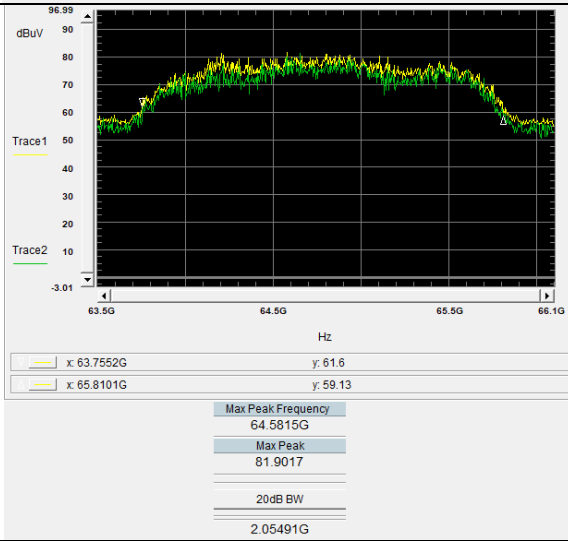

69.12 GHz
 $\pi/2$ -16QAM

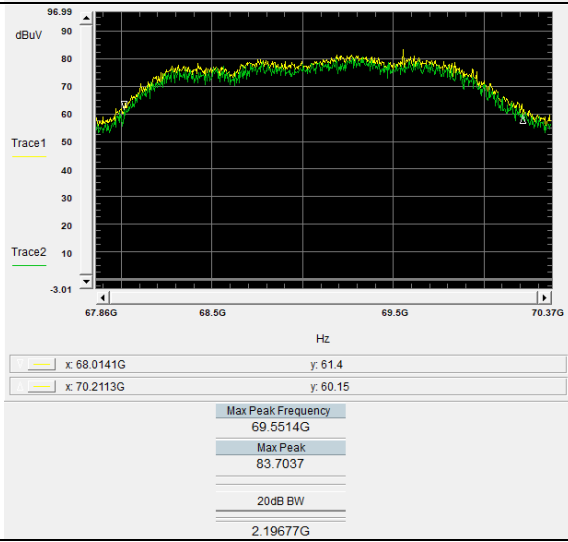

4.4 Equivalent Isotropically Radiated Power (EIRP):

Serial Number:	CR22080030-RF-S1	Test Date:	2022/09/26
Test Site:	966-1	Test Mode:	Transmitting
Tester:	coco Tian	Test Result:	Pass

Environmental Conditions:

Temperature: (°C)	25.8	Relative Humidity: (%)	54	ATM Pressure: (kPa)	100
----------------------	------	---------------------------	----	------------------------	-----

Test Equipment List and Details:

Manufacturer	Description	Model	Serial Number	Calibration Date	Calibration Due Date
Flann Microwave	Horn Antenna	861V/385	738	2020/11/08	2023/11/07
millitech	RF Detector	DET-15-RPFW0	A18521	2019/12/15	2022/12/15
Tektronix	Digital Phosphor Oscilloscope	TDS 3054	B015264	2022/01/05	2023/01/04
Agilent	Signal Generator	E8247C	MY43321352	2022/04/01	2023/03/31
Agilent	mm-Wave Source Modules	83557A	3942A00697	2022/04/01	2023/03/31

* Statement of Traceability: China Certification ICT Co., Ltd (Dongguan) attests that all calibrations have been performed, traceable to National Primary Standards and International System of Units (SI).

Test Data:

π 2-BPSK

Frequency (GHz)	DSO		Polar (H/V)	Substituted Level (dBm)	Antenna Gain (dBi)	EIRP (dBm)	Limit (dBm)
	Reading (mV)	Detector					
58.32	128.00	PK	V	-10.88	24.00	32.99	43.00
58.32	118.00	AV	V	-11.23	24.00	32.64	40.00
64.80	117.00	PK	V	-11.78	24.00	33.01	43.00
64.80	107.00	AV	V	-12.17	24.00	32.62	40.00
69.12	124.00	PK	V	-12.61	24.00	32.74	43.00
69.12	116.00	AV	V	-12.90	24.00	32.45	40.00

 π 2-QPSK

Frequency (GHz)	DSO		Polar (H/V)	Substituted Level (dBm)	Antenna Gain (dBi)	EIRP (dBm)	Limit (dBm)
	Reading (mV)	Detector					
58.32	141.00	PK	V	-10.46	24.00	33.41	43.00
58.32	123.00	AV	V	-11.05	24.00	32.82	40.00
64.80	131.00	PK	V	-11.29	24.00	33.50	43.00
64.80	112.00	AV	V	-11.97	24.00	32.82	40.00
69.12	14.65	PK	V	-21.89	24.00	23.46	43.00
69.12	0.87	AV	V	-34.15	24.00	11.20	40.00

 π 2-16QAM

Frequency (GHz)	DSO		Polar (H/V)	Substituted Level (dBm)	Antenna Gain (dBi)	EIRP (dBm)	Limit (dBm)
	Reading (mV)	Detector					
58.32	168.00	PK	V	-9.69	24.00	34.18	43.00
58.32	113.00	AV	V	-11.42	24.00	32.45	40.00
64.80	132.00	PK	V	-11.25	24.00	33.54	43.00
64.80	81.00	AV	V	-13.38	24.00	31.41	40.00
69.12	152.00	PK	V	-11.73	24.00	33.62	43.00
69.12	101.00	AV	V	-13.50	24.00	31.85	40.00

$$EIRP = E_{meas} + 20\log(\text{Measurement distance}) - 104.7$$

$$E_{meas} = 126.8 - 20\log(\lambda) + \text{Substituted level} - \text{Antenna Gain}$$

$$\text{Measurement distance} = 1m$$

4.5 Peak Conducted Output Power:

Serial Number:	CR22080030-RF-S1	Test Date:	2022/09/26
Test Site:	966-1	Test Mode:	Transmitting
Tester:	coco Tian	Test Result:	Pass

Environmental Conditions:

Temperature: (°C)	25.8	Relative Humidity: (%)	54	ATM Pressure: (kPa)	100
----------------------	------	---------------------------	----	------------------------	-----

Test Equipment List and Details:

Manufacturer	Description	Model	Serial Number	Calibration Date	Calibration Due Date
Flann Microwave	Horn Antenna	861V/385	738	2020/11/08	2023/11/07
millitech	RF Detector	DET-15-RPFW0	A18521	2019/12/15	2022/12/15
Tektronix	Digital Phosphor Oscilloscope	TDS 3054	B015264	2022/01/05	2023/01/04
Agilent	Signal Generator	E8247C	MY43321352	2022/04/01	2023/03/31
Agilent	mm-Wave Source Modules	83557A	3942A00697	2022/04/01	2023/03/31

** Statement of Traceability: China Certification ICT Co., Ltd (Dongguan) attests that all calibrations have been performed, traceable to National Primary Standards and International System of Units (SI).*

Test Data: **π 2-BPSK:**

Frequency (GHz)	Peak EIRP Power (dBm)	Antenna Gain (dBi)	Peak Conducted Power (dBm)	Limit (dBm)	Margin (dB)
58.32	32.99	18.00	14.99	27	12.01
64.80	33.01	18.00	15.01	27	11.99
69.12	32.74	18.00	14.74	27	12.26

 π 2-QPSK:

Frequency (GHz)	Peak EIRP Power (dBm)	Antenna Gain (dBi)	Peak Conducted Power (dBm)	Limit (dBm)	Margin (dB)
58.32	33.41	18.00	15.41	27	11.59
64.80	33.50	18.00	15.50	27	11.50
69.12	23.46	18.00	5.46	27	21.54

 π 2-16QAM:

Frequency (GHz)	Peak EIRP Power (dBm)	Antenna Gain (dBi)	Peak Conducted Power (dBm)	Limit (dBm)	Margin (dB)
58.32	34.18	18.00	16.18	27	10.82
64.80	33.54	18.00	15.54	27	11.46
69.12	33.62	18.00	15.62	27	11.38

Note:

For radiated emissions measurements, calculated transmitter conducted output power $P(con)$

$$P(con) = EIRP - \text{Antenna gain (dBi)}$$

4.6 Frequency Stability:

Serial Number:	CR22080030-RF-S1	Test Date:	2022/09/26
Test Site:	RF	Test Mode:	Transmitting
Tester:	coco Tian	Test Result:	Pass

Environmental Conditions:

Temperature: (°C)	26.5	Relative Humidity: (%)	61	ATM Pressure: (kPa)	100
----------------------	------	---------------------------	----	------------------------	-----

Test Equipment List and Details:

Manufacturer	Description	Model	Serial Number	Calibration Date	Calibration Due Date
Agilent	Spectrum Analyzer	E4440A	MY44303354	2022/07/15	2023/07/14
Agilent	Harmonic Mixer	Agilent 11970V	2521A01768	2020/11/08	2023/11/07
Flann Microwave	Horn Antenna	861V/385	738	2020/11/08	2023/11/07
BACL	TEMP&HUMI Test Chamber	BTH-150-40	30174	2022/04/06	2023/04/05
UNI-T	Multimeter	UT39A+	C210582554	2021/09/30	2022/09/29
BACL	Test Software	E4440A	V1.1	N/A	N/A

* Statement of Traceability: China Certification ICT Co., Ltd (Dongguan) attests that all calibrations have been performed, traceable to National Primary Standards and International System of Units (SI).

Test Data: **$\pi/2$ -BPSK:**

Temperature	Voltage	Frequency (GHz)			
		f_L	f_H	f_L Limit	f_H Limit
-20	48	57.31020	70.00250	57	71
-10	48	57.31110	70.00310	57	71
0	48	57.31040	70.00340	57	71
10	48	57.31120	70.00300	57	71
20	48	57.31050	70.00290	57	71
30	48	57.31070	70.00320	57	71
40	48	57.31090	70.00270	57	71
50	48	57.31110	70.00300	57	71
20	42	57.31120	70.00350	57	71
20	54	57.31120	70.00300	57	71

π 2-QPSK:

Temperature	Voltage	Frequency (GHz)			
		f _L	f _H	f _L Limit	f _H Limit
°C	V _{DC}				
-20	48	57.39750	70.07350	57	71
-10	48	57.39780	70.07410	57	71
0	48	57.39840	70.07420	57	71
10	48	57.39850	70.07390	57	71
20	48	57.39760	70.07400	57	71
30	48	57.39810	70.07440	57	71
40	48	57.39830	70.07370	57	71
50	48	57.39840	70.07390	57	71
20	42	57.39850	70.07420	57	71
20	54	57.39840	70.07420	57	71

 π 2-16QAM:

Temperature	Voltage	Frequency (GHz)			
		f _L	f _H	f _L Limit	f _H Limit
°C	V _{DC}				
-20	48	57.41790	70.06510	57	71
-10	48	57.41890	70.06570	57	71
0	48	57.41840	70.06550	57	71
10	48	57.41850	70.06530	57	71
20	48	57.41810	70.06590	57	71
30	48	57.41810	70.06560	57	71
40	48	57.41890	70.06520	57	71
50	48	57.41880	70.06550	57	71
20	42	57.41800	70.06570	57	71
20	54	57.41870	70.06610	57	71

5. RF EXPOSURE EVALUATION

5.1 MAXIMUM PERMISSIBLE EXPOSURE (MPE)

5.1.1 Applicable Standard

FCC §15.255(g) & §1.1310 & §2.1091

Regardless of the power density levels permitted under this subpart, devices operating under the provisions of this subpart are subject to the radiofrequency radiation exposure requirements specified in §§ 1.1307(b), 2.1091, and 2.1093 of this chapter, as appropriate. Applications for equipment authorization of devices operating under this section must contain a statement confirming compliance with these requirements for both fundamental emissions and unwanted emissions. Technical information showing the basis for this statement must be submitted to the Commission upon request.

Systems operating under the provisions of this section shall be operated in a manner that ensures that the public is not exposed to radio frequency energy levels in excess of the Commission's guidelines. See §1.1307(b)(1) of this chapter.

Limits for Maximum Permissible Exposure (MPE) (§1.1310, §2.1091)

(B) Limits for General Population/Uncontrolled Exposure				
Frequency Range (MHz)	Electric Field Strength (V/m)	Magnetic Field Strength (A/m)	Power Density (mW/cm²)	Averaging Time (minutes)
0.3–1.34	614	1.63	*(100)	30
1.34–30	824/f	2.19/f	*(180/f ²)	30
30–300	27.5	0.073	0.2	30
300–1500	/	/	f/1500	30
1500–100,000	/	/	1.0	30

f = frequency in MHz; * = Plane-wave equivalent power density;

According to §1.1310 and §2.1091 RF exposure is calculated.

5.1.2 Procedure

Prediction of power density at the distance of the applicable MPE limit

$S = PG/4\pi R^2$ = power density (in appropriate units, e.g. mW/cm²);

P = power input to the antenna (in appropriate units, e.g., mW);

G = power gain of the antenna in the direction of interest relative to an isotropic radiator, the power gain factor, is normally numeric gain;

R = distance to the center of radiation of the antenna (appropriate units, e.g., cm);

5.2 Measurement Result

Frequency (GHz)	Antenna Gain		Conducted output power including Tune-up Tolerance		Evaluation Distance (cm)	Power Density (mW/cm ²)	MPE Limit (mW/cm ²)
	(dBi)	(numeric)	(dBm)	(mW)			
58.32-69.12	18.00	63.1	17	50.12	20	0.6292	1

Note:

The Value of Maximum Conducted Power including Tune-up Tolerance was declared by the customer.

Result: The device meet FCC MPE at 20 cm distance.

===== **END OF REPORT** =====