

# FCC Test Report

Omni-ID  
BLE tag, Model: Sense Shield

In accordance with FCC 47 CFR Part 15B  
(2.4 GHz Bluetooth)

Prepared for: Omni-ID  
The Enterprise Centre  
Coxbridge Business Park  
Alton Road  
Farnham  
Surrey  
GU10 5EH  
UNITED KINGDOM



FCC ID: 2AYWZ -SENSE-SHIELD

## COMMERCIAL-IN-CONFIDENCE

Document 75949856-13 Issue 01

SIGNATURE			
NAME	JOB TITLE	RESPONSIBLE FOR	ISSUE DATE
Andy Lawson	EMC Chief Engineer	Authorised Signatory	21 October 2021

Signatures in this approval box have checked this document in line with the requirements of TÜV SÜD document control rules.

### ENGINEERING STATEMENT

The measurements shown in this report were made in accordance with the procedures described on test pages. All reported testing was carried out on a sample equipment to demonstrate limited compliance with FCC 47 CFR Part 15B. The sample tested was found to comply with the requirements defined in the applied rules.

RESPONSIBLE FOR	NAME	DATE	SIGNATURE
Testing	Graeme Lawler	21 October 2021	

FCC Accreditation  
90987 Octagon House, Fareham Test Laboratory

### EXECUTIVE SUMMARY

A sample of this product was tested and found to be compliant with FCC 47 CFR Part 15B: 2020 for the tests detailed in section 1.3.

		<b>DISCLAIMER AND COPYRIGHT</b> This non-binding report has been prepared by TÜV SÜD with all reasonable skill and care. The document is confidential to the potential Client and TÜV SÜD. No part of this document may be reproduced without the prior written approval of TÜV SÜD. © 2021 TÜV SÜD. This report relates only to the actual item/items tested.
		<b>ACCREDITATION</b> Our UKAS Accreditation does not cover opinions and interpretations and any expressed are outside the scope of our UKAS Accreditation. Results of tests not covered by our UKAS Accreditation Schedule are marked NUA (Not UKAS Accredited).

TÜV SÜD  
is a trading name of TÜV SÜD Ltd  
Registered in Scotland at East Kilbride,  
Glasgow G75 0QF, United Kingdom  
Registered number: SC215164

TÜV SÜD Ltd is a  
TÜV SÜD Group Company

Phone: +44 (0) 1489 558100  
Fax: +44 (0) 1489 558101  
[www.tuvsud.com/en](http://www.tuvsud.com/en)

TÜV SÜD  
Octagon House  
Concorde Way  
Fareham  
Hampshire PO15 5RL  
United Kingdom



## Contents

<b>1</b>	<b>Report Summary .....</b>	<b>2</b>
1.1	Report Modification Record.....	2
1.2	Introduction.....	2
1.3	Brief Summary of Results .....	3
1.4	Declaration of Build Status .....	4
1.5	Product Information .....	7
1.6	Deviations from the Standard.....	7
1.7	EUT Modification Record .....	7
1.8	Test Location .....	8
<b>2</b>	<b>Test Details .....</b>	<b>9</b>
2.1	Radiated Disturbance.....	9
<b>3</b>	<b>Test Equipment Information .....</b>	<b>36</b>
3.1	General Test Equipment Used.....	36
<b>4</b>	<b>Incident Reports .....</b>	<b>37</b>
<b>5</b>	<b>Measurement Uncertainty .....</b>	<b>38</b>



# 1 Report Summary

## 1.1 Report Modification Record

Alterations and additions to this report will be issued to the holders of each copy in the form of a complete document.

Issue	Description of Change	Date of Issue
1	First Issue	21 October 2021

**Table 1**

## 1.2 Introduction

Applicant	Omni-ID
Manufacturer	Omni-ID
Model Number(s)	Sense Shield
Serial Number(s)	Not Serialised (Storix ID 551011-54)
Hardware Version(s)	K
Software Version(s)	1.7
Number of Samples Tested	1
Test Specification/Issue/Date	FCC 47 CFR Part 15B: 2020
Order Number	20200033
Date	27-August-2020
Date of Receipt of EUT	11-February-2021
Start of Test	25-August-2021
Finish of Test	25-August-2021
Name of Engineer(s)	Graeme Lawler
Related Document(s)	ANSI C63.4: 2014



### 1.3 Brief Summary of Results

A brief summary of the tests carried out in accordance with FCC 47 CFR Part 15B is shown below.

Section	Specification Clause	Test Description	Result	Comments/Base Standard
Configuration and Mode: Battery Powered - Idle				
2.1	15.109	Radiated Disturbance	Pass	ANSI C63.4: 2014

**Table 2**



**1.4 Declaration of Build Status**

Equipment Description

Technical Description: <i>(Please provide a brief description of the intended use of the equipment including the technologies the product supports)</i>	A BLE tag used to locate personnel and Assets Tag advertises only and does not pair.	
Manufacturer:	Omni Id	
Model:	Sense Shield	
Part Number:	CP14828	
Hardware Version:	K	
Software Version:	1.7	
FCC ID of the product under test – <a href="#">see guidance here</a>	2AYWZ -SENSE-SHIELD	
IC ID of the product under test – <a href="#">see guidance here</a>	Not Applicable	

**Table 3**

Intentional Radiators

Technology	Bluetooth Low Energy					
Frequency Range (MHz to MHz)	2401-2481					
Conducted Declared Output Power (dBm)	8					
Antenna Gain (dBi)	0					
Supported Bandwidth(s) (MHz) (e.g. 1 MHz, 20 MHz, 40 MHz)	1 MHz					
Modulation Scheme(s) (e.g. GFSK, QPSK etc)	FSK					
ITU Emission Designator ( <a href="#">see guidance here</a> ) (not mandatory for Part 15 devices)	1M00XD					
Bottom Frequency (MHz)	2401					
Middle Frequency (MHz)	2441					
Top Frequency (MHz)	2481					

**Table 4**

Un-intentional Radiators

Highest frequency generated or used in the device or on which the device operates or tunes	
Lowest frequency generated or used in the device or on which the device operates or tunes	
Class A Digital Device (Use in commercial, industrial or business environment) <input type="checkbox"/>	
Class B Digital Device (Use in residential environment only) <input type="checkbox"/>	

**Table 5**



AC Power Source

AC supply frequency:		Hz
Voltage		V
Max current:		A
Single Phase <input type="checkbox"/> Three Phase <input type="checkbox"/>		

**Table 6**

DC Power Source

Nominal voltage:		V
Extreme upper voltage:		V
Extreme lower voltage:		V
Max current:		A

**Table 7**

Battery Power Source

Voltage:	3	V
End-point voltage:	1.8	V (Point at which the battery will terminate)
Alkaline <input checked="" type="checkbox"/> Leclanche <input type="checkbox"/> Lithium <input type="checkbox"/> Nickel Cadmium <input type="checkbox"/> Lead Acid* <input type="checkbox"/> *(Vehicle regulated)		
Other <input type="checkbox"/>	Please detail:	

**Table 8**

Charging

Can the EUT transmit whilst being charged	Yes <input type="checkbox"/> No <input checked="" type="checkbox"/>
---	---

**Table 9**

Temperature

Minimum temperature:	-20	°C
Maximum temperature:	60	°C

**Table 10**

Cable Loss

Adapter Cable Loss (Conducted sample)	0	dB
---------------------------------------	---	----

**Table 11**



Antenna Characteristics

Antenna connector <input type="checkbox"/>			State impedance		Ohm
Temporary antenna connector <input type="checkbox"/>			State impedance		Ohm
Integral antenna <input checked="" type="checkbox"/>	Type:	PCB Etch	Gain	0	dBi
External antenna <input type="checkbox"/>	Type:		Gain		dBi
For external antenna only: Standard Antenna Jack <input type="checkbox"/> If yes, describe how user is prohibited from changing antenna (if not professional installed): Equipment is only ever professionally installed <input type="checkbox"/> Non-standard Antenna Jack <input type="checkbox"/>					

**Table 12**

Ancillaries (if applicable)

Manufacturer:		Part Number:	
Model:		Country of Origin:	

**Table 13**

I hereby declare that the information supplied is correct and complete.

Name: Charles Vilner  
 Position held: Engineering Director  
 Date: 01 September 2021



**1.5 Product Information**

**1.5.1 Technical Description**

The equipment under test (EUT) was a BLE tag used to locate personnel and as an Assets Tag.  
 The EUT advertises only and does not pair.

**1.5.2 EUT Port/Cable Identification**

Port	Max Cable Length specified	Usage	Type	Screened
None (See note)	-	-	-	-

**Table 14**

Note: The EUT does not have any ports.

**1.5.3 Test Configuration**

Configuration	Description
Battery Powered	The EUT was powered from its internal battery.

**Table 15**

**1.5.4 Modes of Operation**

Mode	Description
Idle	All transmitters were set to idle.

**Table 16**

**1.6 Deviations from the Standard**

No deviations from the applicable test standard were made during testing.

**1.7 EUT Modification Record**

The table below details modifications made to the EUT during the test programme.

The modifications incorporated during each test are recorded on the appropriate test pages.

Modification State	Description of Modification still fitted to EUT	Modification Fitted By	Date Modification Fitted
Model: Sense Shield, Serial Number: Not Serialised (Storix ID 551011-54)			
0	As supplied by the customer	Not Applicable	Not Applicable

**Table 17**





**1.8 Test Location**

TÜV SÜD conducted the following tests at our Fareham Test Laboratory.

Test Name	Name of Engineer(s)	Accreditation
Configuration and Mode: Battery Powered - Idle		
Radiated Disturbance	Graeme Lawler	UKAS

**Table 18**

Office Address:

TÜV SÜD  
Octagon House  
Concorde Way  
Fareham  
Hampshire  
PO15 5RL  
United Kingdom



## 2 Test Details

### 2.1 Radiated Disturbance

#### 2.1.1 Specification Reference

FCC 47 CFR Part 15B, Clause 15.109

#### 2.1.2 Equipment Under Test and Modification State

Sense Shield, S/N: Not Serialised (Storix ID 551011-54) - Modification State 0

#### 2.1.3 Date of Test

25-August-2021

#### 2.1.4 Test Method

The EUT was set up on a non-conductive table 0.8 m above a reference ground plane insulated support 0.1 m above a ground reference plane within a semi-anechoic chamber on a remotely controlled turntable.

A pre-scan of the EUT emissions profile using a peak detector was made at a 3 m antenna distance whilst varying the antenna-to-EUT azimuth and polarisation.

For an EUT which could reasonable be used in multiple planes, pre-scans were performed with the EUT orientated in X, Y and Z planes with reference to the ground plane.

Using a list of the highest emissions detected during the pre-scan along with their bearing and associated antenna polarisation, the EUT was then formally measured using a Quasi-Peak, Peak or CISPR Average detector as appropriate.

The readings were maximised by adjusting the antenna height, polarisation and turntable azimuth, in accordance with the specification.

#### 2.1.5 Example Calculation

Below 1 GHz:

Quasi-Peak level (dB $\mu$ V/m) = Receiver level (dB $\mu$ V) + Correction Factor (dB/m)

Margin (dB) = Quasi-Peak level (dB $\mu$ V/m) - Limit (dB $\mu$ V/m)

Above 1 GHz:

CISPR Average level (dB $\mu$ V/m) = Receiver level (dB $\mu$ V) + Correction Factor (dB/m)

Margin (dB) = CISPR Average level (dB $\mu$ V/m) - Limit (dB $\mu$ V/m)

Peak level (dB $\mu$ V/m) = Receiver level (dB $\mu$ V) + Correction Factor (dB/m)

Margin (dB) = Peak level (dB $\mu$ V/m) - Limit (dB $\mu$ V/m)

**2.1.6 Example Test Setup Diagram**

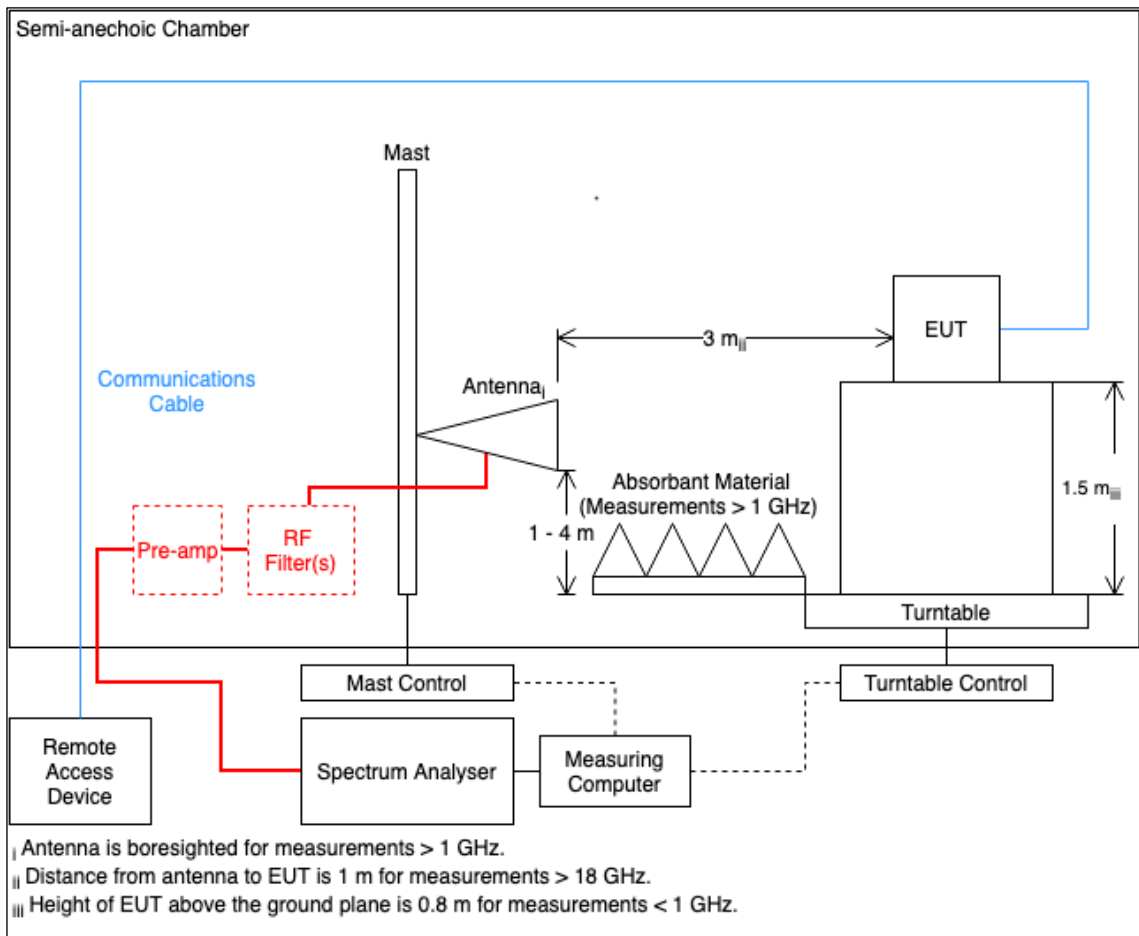

**Figure 1**

**2.1.7 Environmental Conditions**

Ambient Temperature 17.2 °C  
 Relative Humidity 60.1 %

**2.1.8 Specification Limits**

Required Specification Limits, Field Strength - Class B Test Limit at a 3 m Measurement Distance		
Frequency Range (MHz)	Test Limit (µV/m)	Test Limit (dBµV/m)
30 to 88	100	40.0
88 to 216	150	43.5
216 to 960	200	46.0
Above 960	500	54.0

**Supplementary information:**  
 Note 1. A Quasi-peak detector is to be used for measurements below 1 GHz.  
 Note 2. A CISPR Average detector is to be used for measurements above 1 GHz.  
 Note 3. The Peak test limit above 1 GHz is 20 dB higher than the CISPR Average test limit.

**Table 19**



**2.1.9 Test Results**

**Results for Configuration and Mode: Battery Powered - Idle.**

**This test was performed to the requirements of the Class B limits.**

Performance assessment of the EUT made during this test: Pass.

Detailed results are shown below.

Highest frequency generated or used within the EUT: 2.48 GHz  
 Which necessitates an upper frequency test limit of: 12.4 GHz (Tested to 13.0 GHz)

The EUT is handheld, body-worn, or ceiling-mounted equipment and has therefore been tested in three different orientations in accordance with ANSI C63.4, Clause 6.3.2.1.

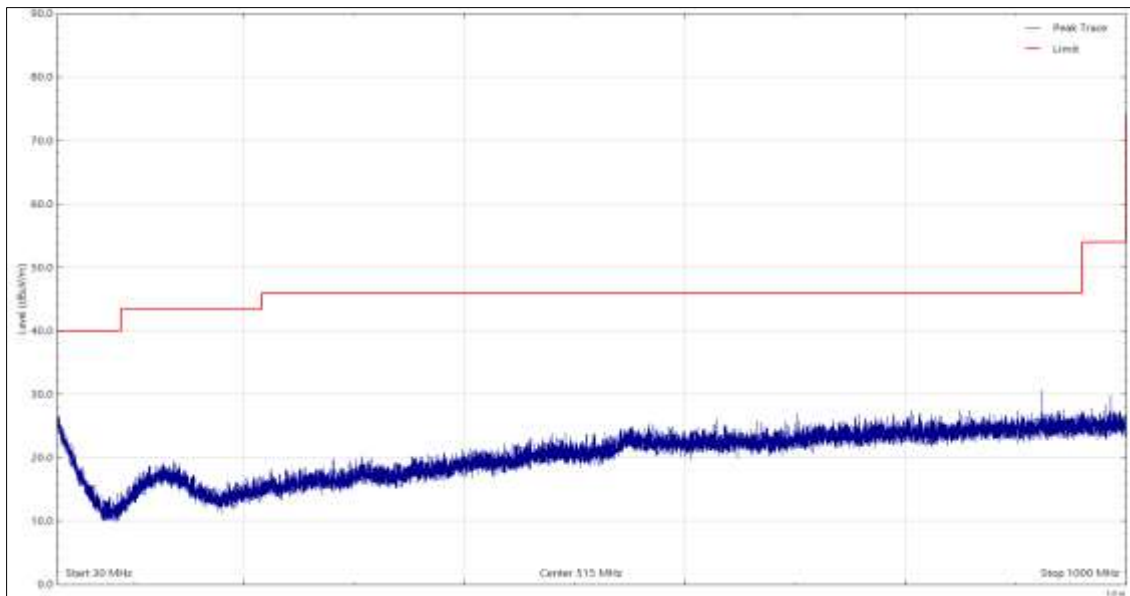
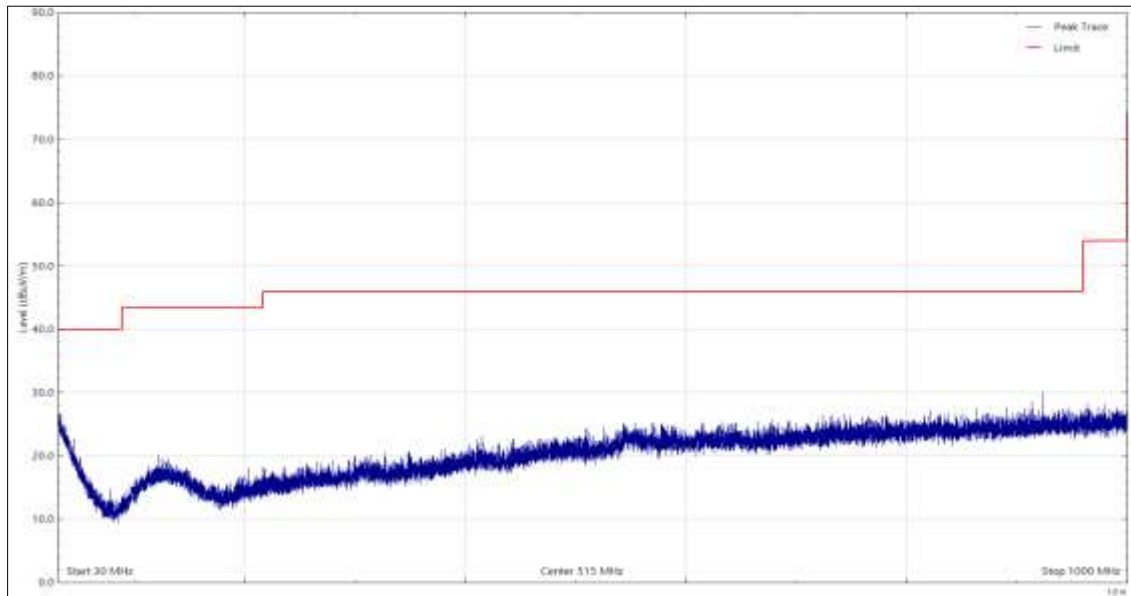

**Figure 2 - 30 MHz to 1 GHz, Quasi-Peak, Vertical - X Orientation**

Frequency (MHz)	Level (dBµV/m)	Limit (dBµV/m)	Margin (dB)	Detector	Angle (°)	Height (cm)	Polarisation
*							

**Table 20**

\*No final measurements were made as all peak emissions seen above the measurement system noise floor during the pre-scan were greater than 10 dB below the test limit.

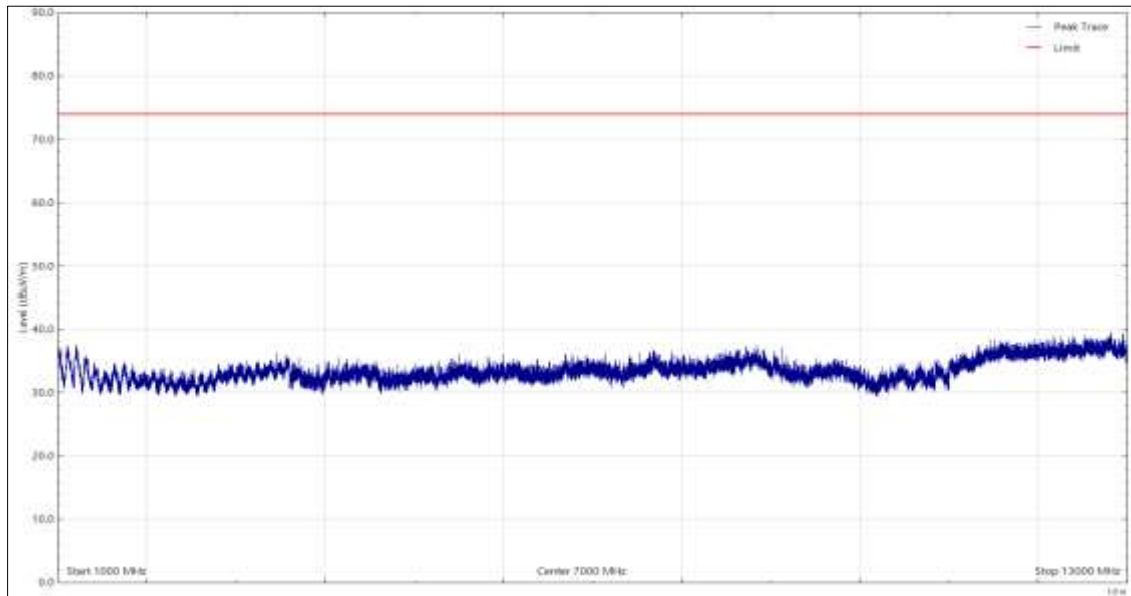

**Figure 3 - 30 MHz to 1 GHz, Quasi-Peak, Horizontal - X Orientation**

Frequency (MHz)	Level (dBµV/m)	Limit (dBµV/m)	Margin (dB)	Detector	Angle (°)	Height (cm)	Polarisation
*							

**Table 21**

\*No final measurements were made as all peak emissions seen above the measurement system noise floor during the pre-scan were greater than 10 dB below the test limit.

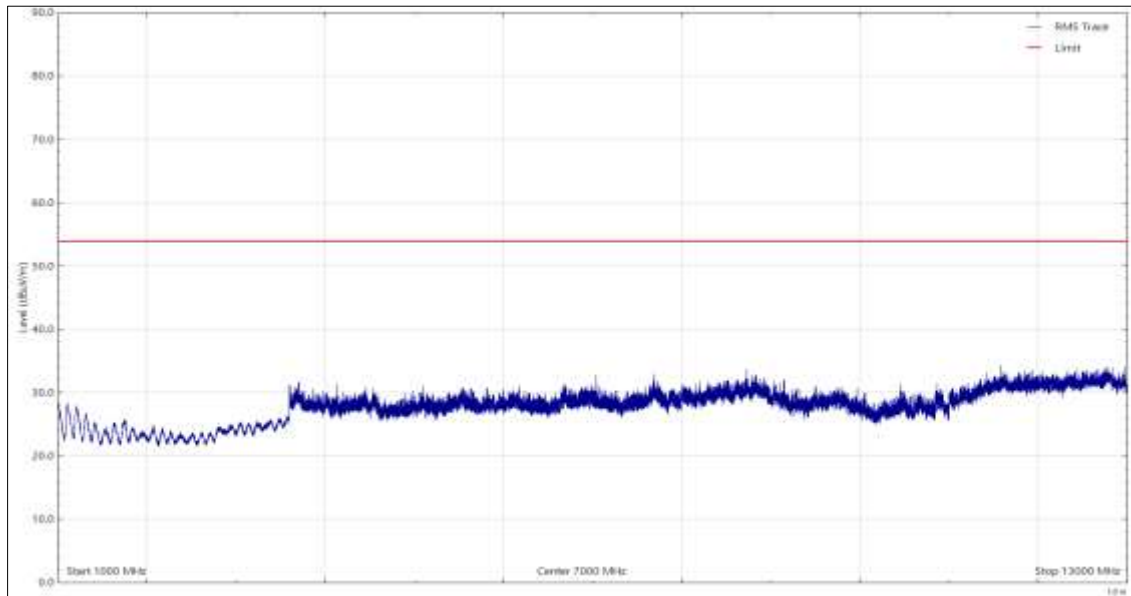

**Figure 4 - 1 GHz to 13 GHz, Peak, Vertical - X Orientation**

Frequency (MHz)	Level (dBµV/m)	Limit (dBµV/m)	Margin (dB)	Detector	Angle (°)	Height (cm)	Polarisation
*							

**Table 22**

\*No final measurements were made as all peak emissions seen above the measurement system noise floor during the pre-scan were greater than 10 dB below the test limit.

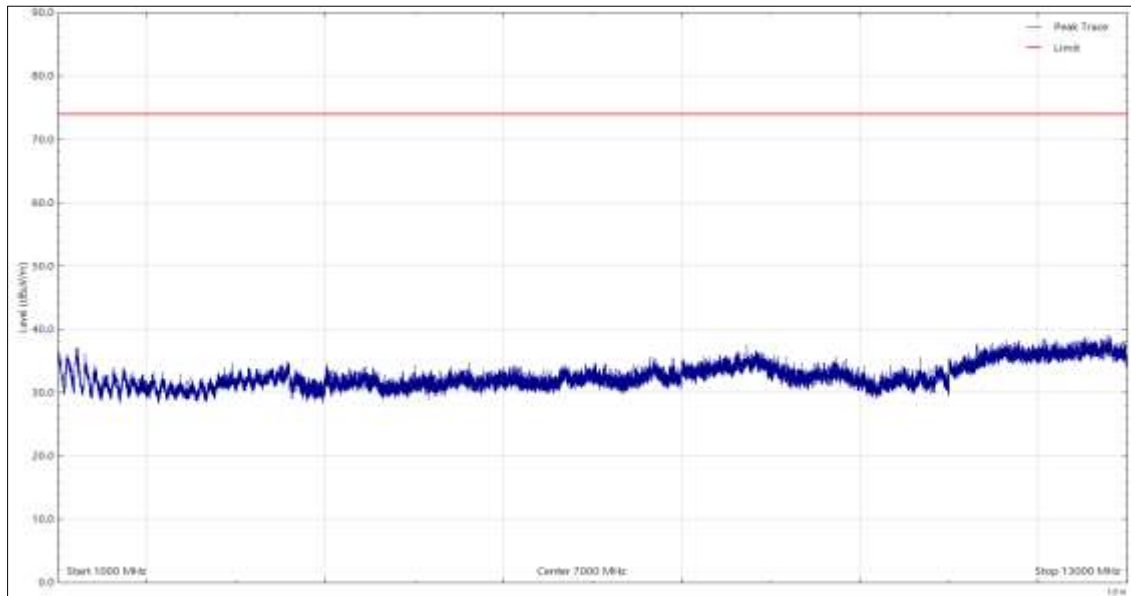

**Figure 5 - 1 GHz to 13 GHz, CISPR Average, Vertical - X Orientation**

Frequency (MHz)	Level (dBµV/m)	Limit (dBµV/m)	Margin (dB)	Detector	Angle (°)	Height (cm)	Polarisation
*							

**Table 23**

\*No final measurements were made as all peak emissions seen above the measurement system noise floor during the pre-scan were greater than 10 dB below the test limit.



**Figure 6 - 1 GHz to 13 GHz, Peak, Horizontal - X Orientation**

Frequency (MHz)	Level (dBµV/m)	Limit (dBµV/m)	Margin (dB)	Detector	Angle (°)	Height (cm)	Polarisation
*							

**Table 24**

\*No final measurements were made as all peak emissions seen above the measurement system noise floor during the pre-scan were greater than 10 dB below the test limit.



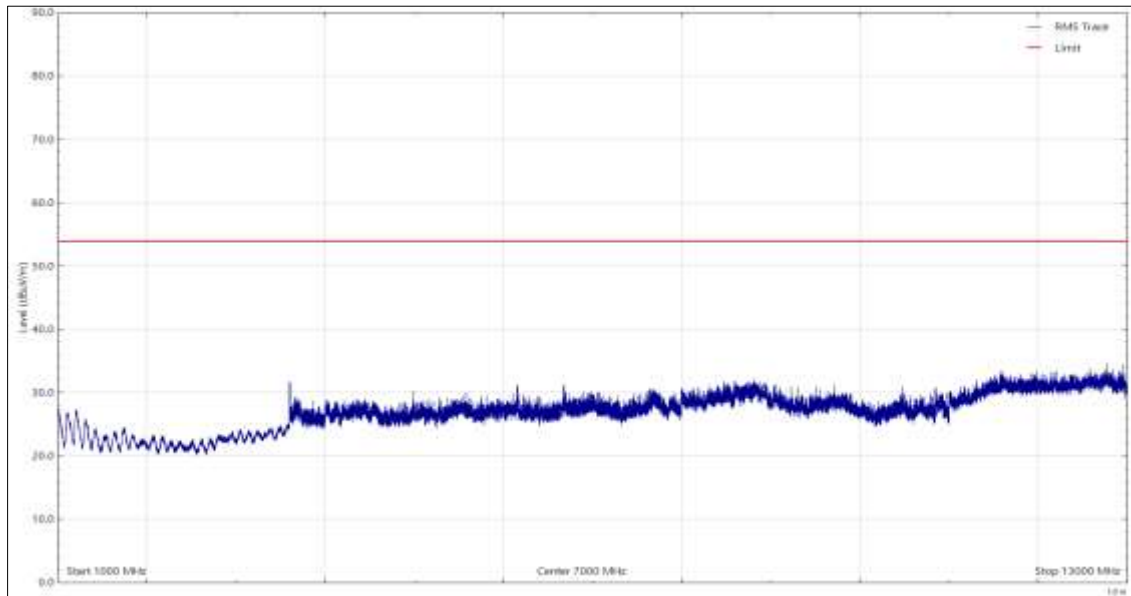
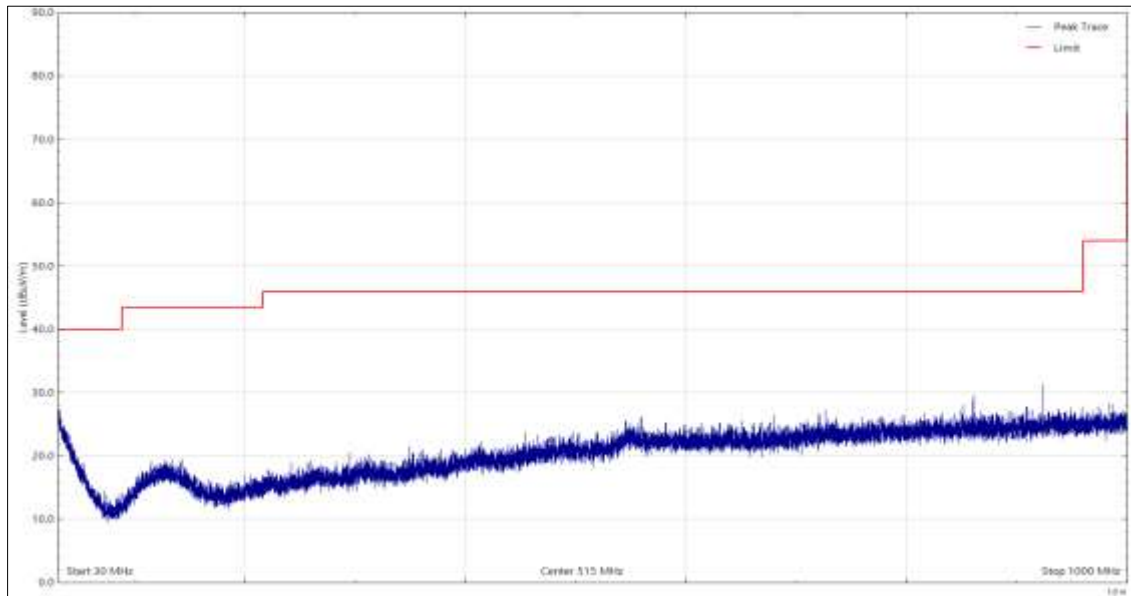

**Figure 7 - 1 GHz to 13 GHz, CISPR Average, Horizontal - X Orientation**

Frequency (MHz)	Level (dBµV/m)	Limit (dBµV/m)	Margin (dB)	Detector	Angle (°)	Height (cm)	Polarisation
*							

**Table 25**

\*No final measurements were made as all peak emissions seen above the measurement system noise floor during the pre-scan were greater than 10 dB below the test limit.

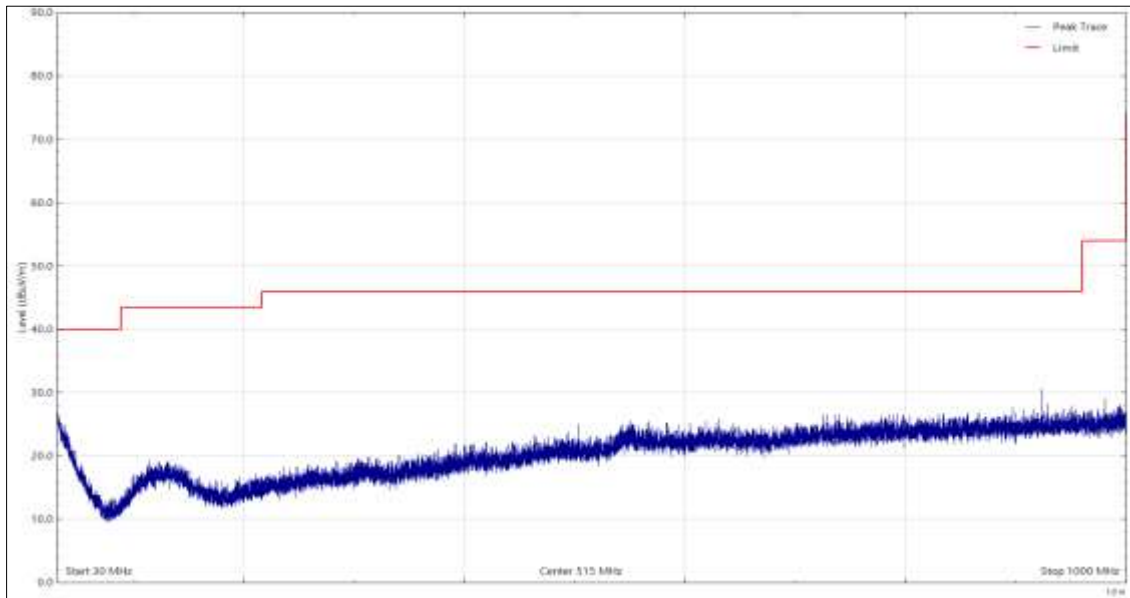

**Figure 8 - 30 MHz to 1 GHz, Quasi-Peak, Vertical - Y Orientation**

Frequency (MHz)	Level (dBµV/m)	Limit (dBµV/m)	Margin (dB)	Detector	Angle (°)	Height (cm)	Polarisation
*							

**Table 26**

\*No final measurements were made as all peak emissions seen above the measurement system noise floor during the pre-scan were greater than 10 dB below the test limit.

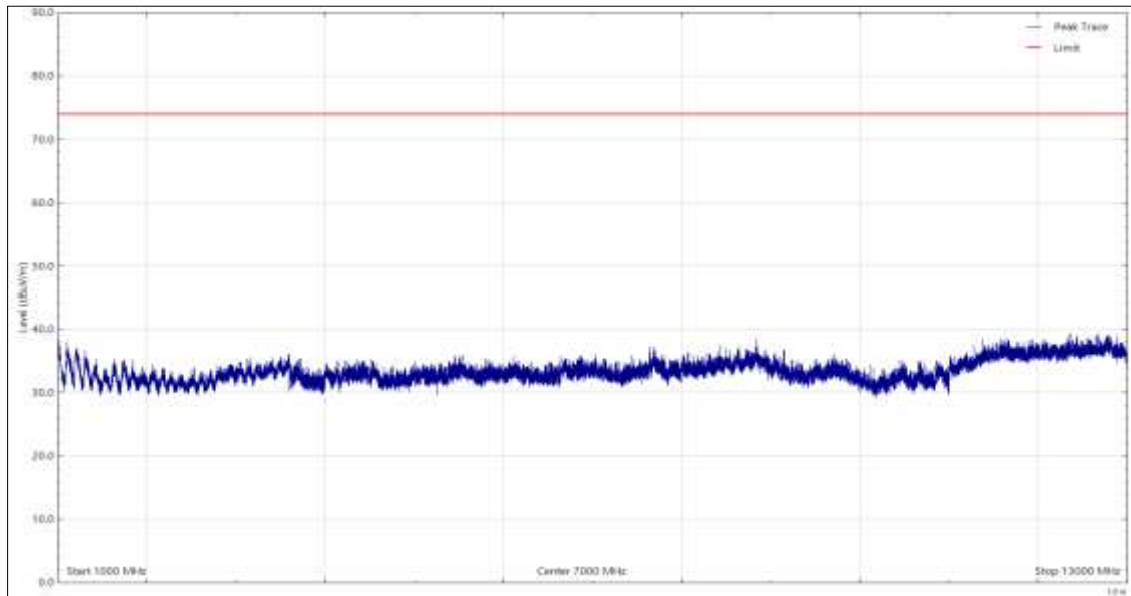

**Figure 9 - 30 MHz to 1 GHz, Quasi-Peak, Horizontal - Y Orientation**

Frequency (MHz)	Level (dBµV/m)	Limit (dBµV/m)	Margin (dB)	Detector	Angle (°)	Height (cm)	Polarisation
*							

**Table 27**

\*No final measurements were made as all peak emissions seen above the measurement system noise floor during the pre-scan were greater than 10 dB below the test limit.

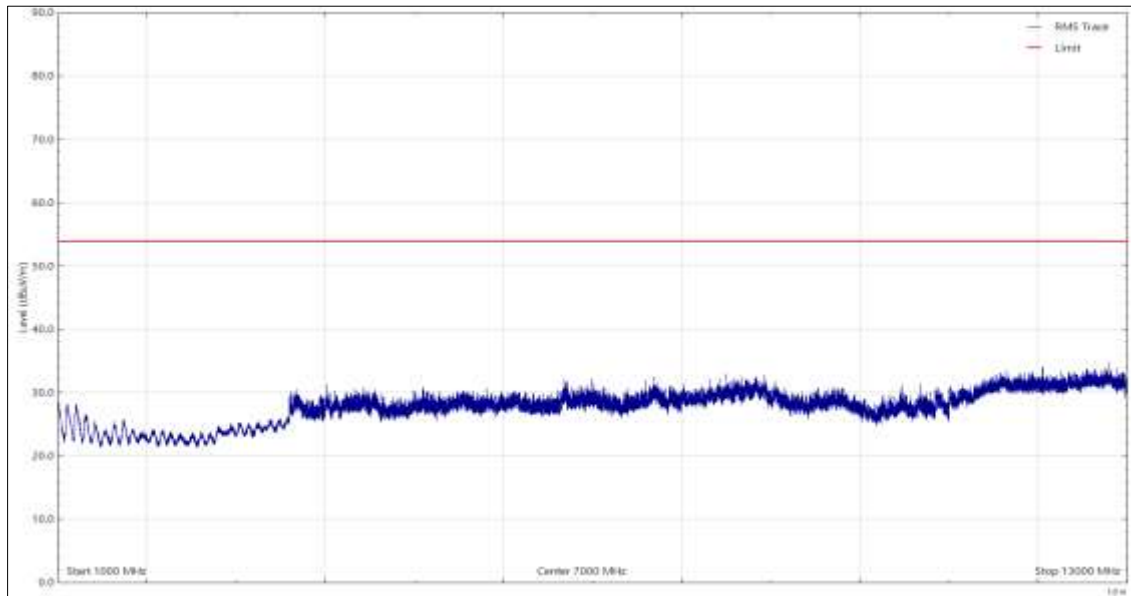

**Figure 10 - 1 GHz to 13 GHz, Peak, Vertical - Y Orientation**

Frequency (MHz)	Level (dBµV/m)	Limit (dBµV/m)	Margin (dB)	Detector	Angle (°)	Height (cm)	Polarisation
*							

**Table 28**

\*No final measurements were made as all peak emissions seen above the measurement system noise floor during the pre-scan were greater than 10 dB below the test limit.

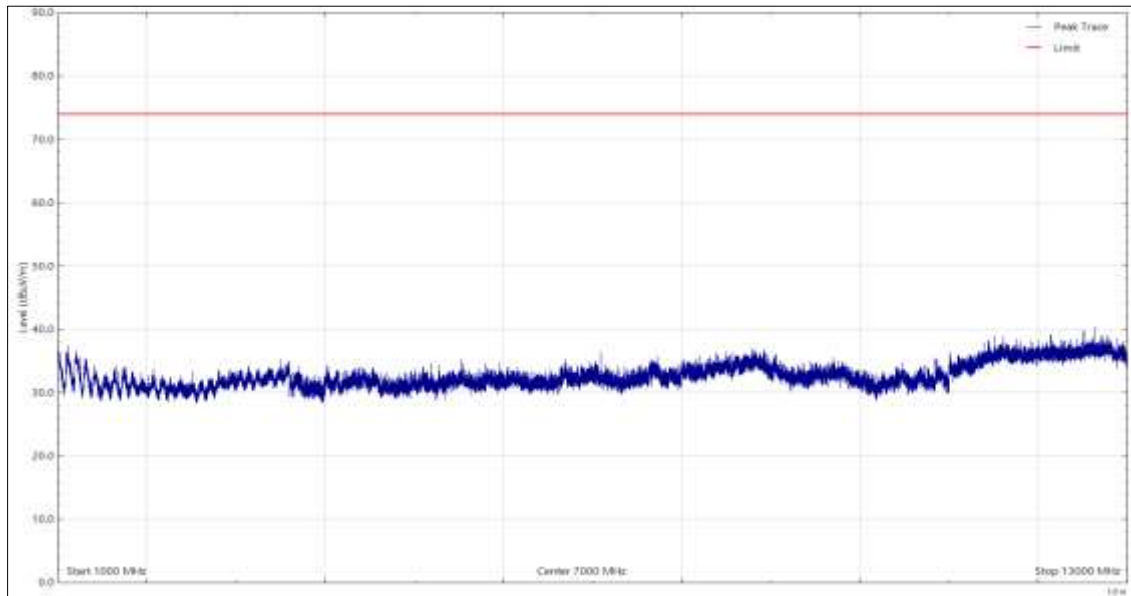

**Figure 11 - 1 GHz to 13 GHz, CISPR Average, Vertical - Y Orientation**

Frequency (MHz)	Level (dBµV/m)	Limit (dBµV/m)	Margin (dB)	Detector	Angle (°)	Height (cm)	Polarisation
*							

**Table 29**

\*No final measurements were made as all peak emissions seen above the measurement system noise floor during the pre-scan were greater than 10 dB below the test limit.

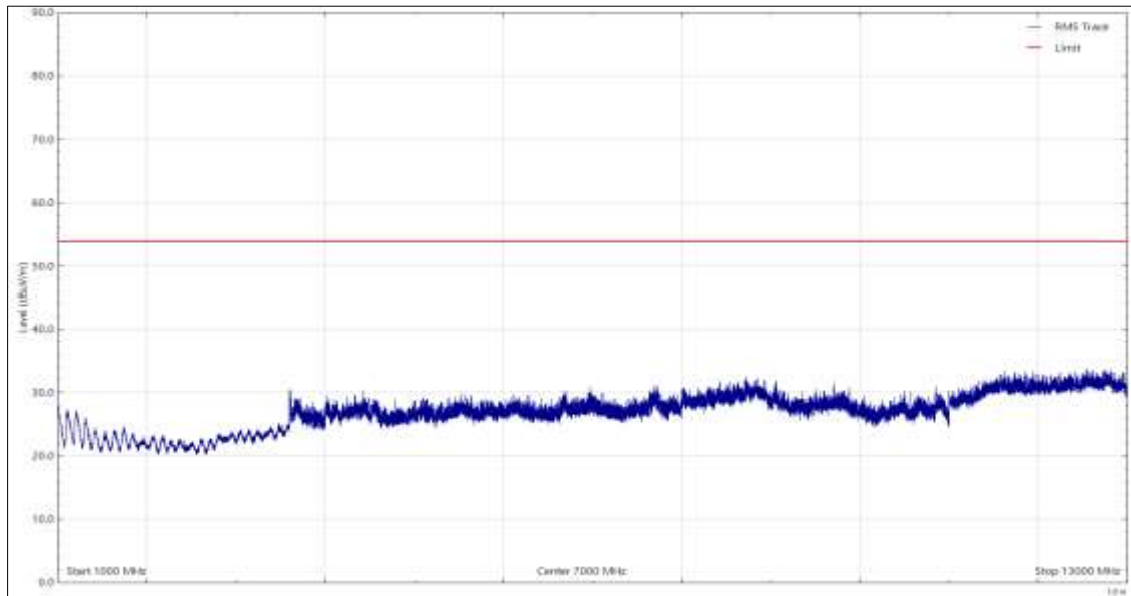

**Figure 12 - 1 GHz to 13 GHz, Peak, Horizontal - Y Orientation**

Frequency (MHz)	Level (dBµV/m)	Limit (dBµV/m)	Margin (dB)	Detector	Angle (°)	Height (cm)	Polarisation
*							

**Table 30**

\*No final measurements were made as all peak emissions seen above the measurement system noise floor during the pre-scan were greater than 10 dB below the test limit.

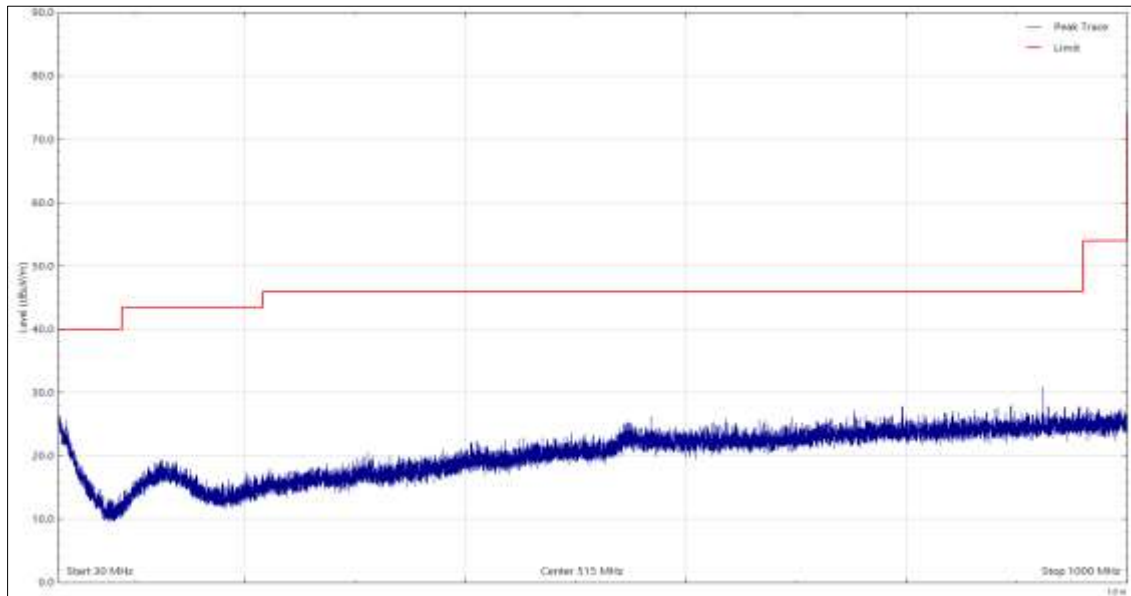

**Figure 13 - 1 GHz to 13 GHz, CISPR Average, Horizontal - Y Orientation**

Frequency (MHz)	Level (dBµV/m)	Limit (dBµV/m)	Margin (dB)	Detector	Angle (°)	Height (cm)	Polarisation
*							

**Table 31**

\*No final measurements were made as all peak emissions seen above the measurement system noise floor during the pre-scan were greater than 10 dB below the test limit.



**Figure 14 - 30 MHz to 1 GHz, Quasi-Peak, Vertical - Z Orientation**

Frequency (MHz)	Level (dBµV/m)	Limit (dBµV/m)	Margin (dB)	Detector	Angle (°)	Height (cm)	Polarisation
*							

**Table 32**

\*No final measurements were made as all peak emissions seen above the measurement system noise floor during the pre-scan were greater than 10 dB below the test limit.



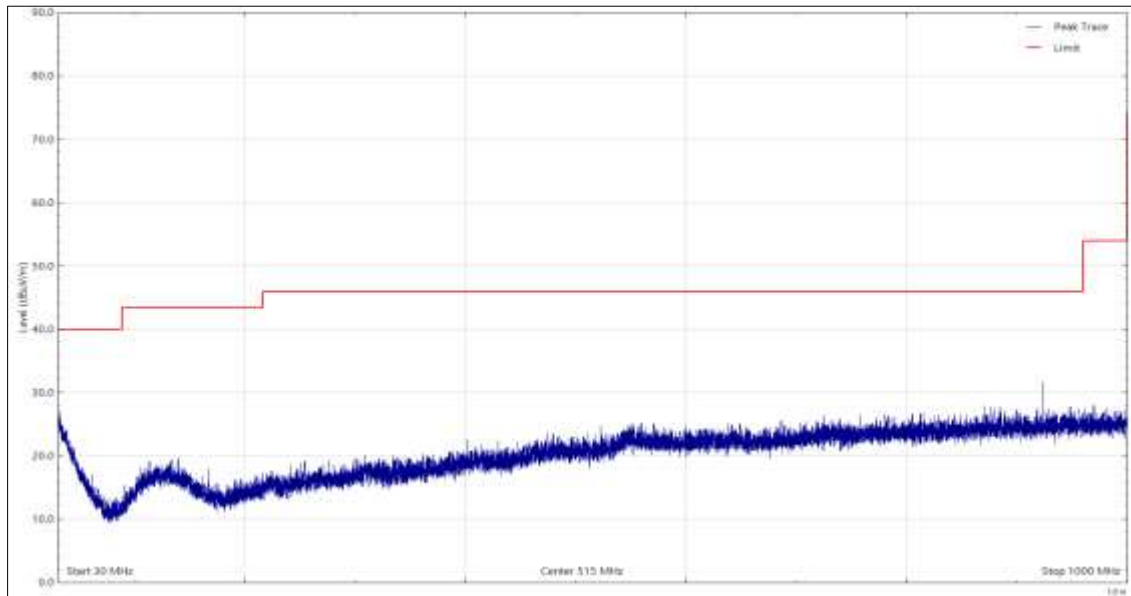
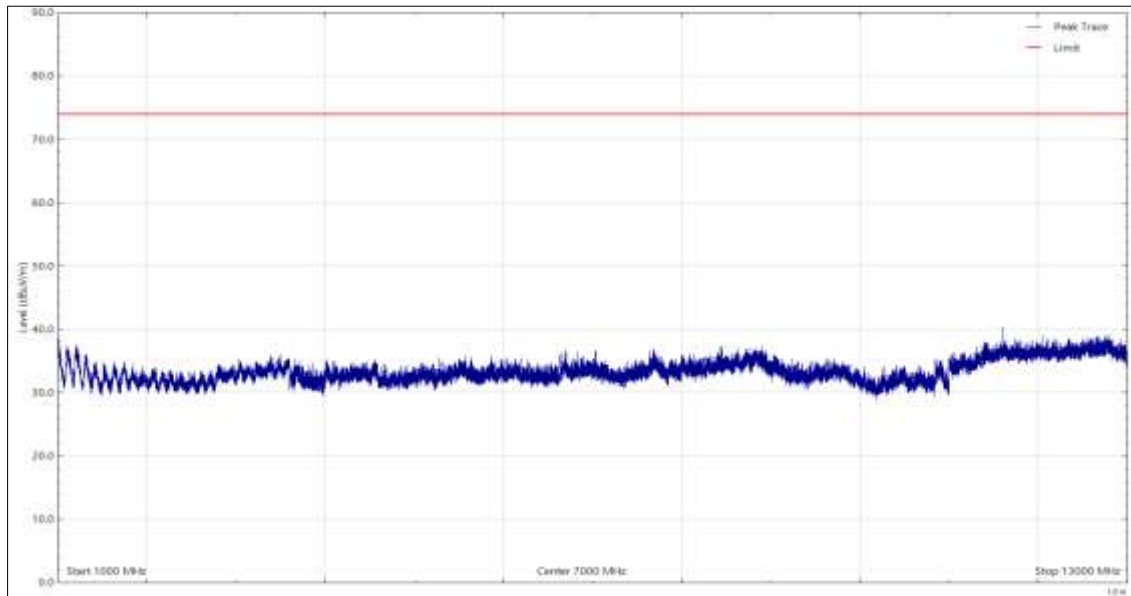

**Figure 15 - 30 MHz to 1 GHz, Quasi-Peak, Horizontal - Z Orientation**

Frequency (MHz)	Level (dBµV/m)	Limit (dBµV/m)	Margin (dB)	Detector	Angle (°)	Height (cm)	Polarisation
*							

**Table 33**

\*No final measurements were made as all peak emissions seen above the measurement system noise floor during the pre-scan were greater than 10 dB below the test limit.

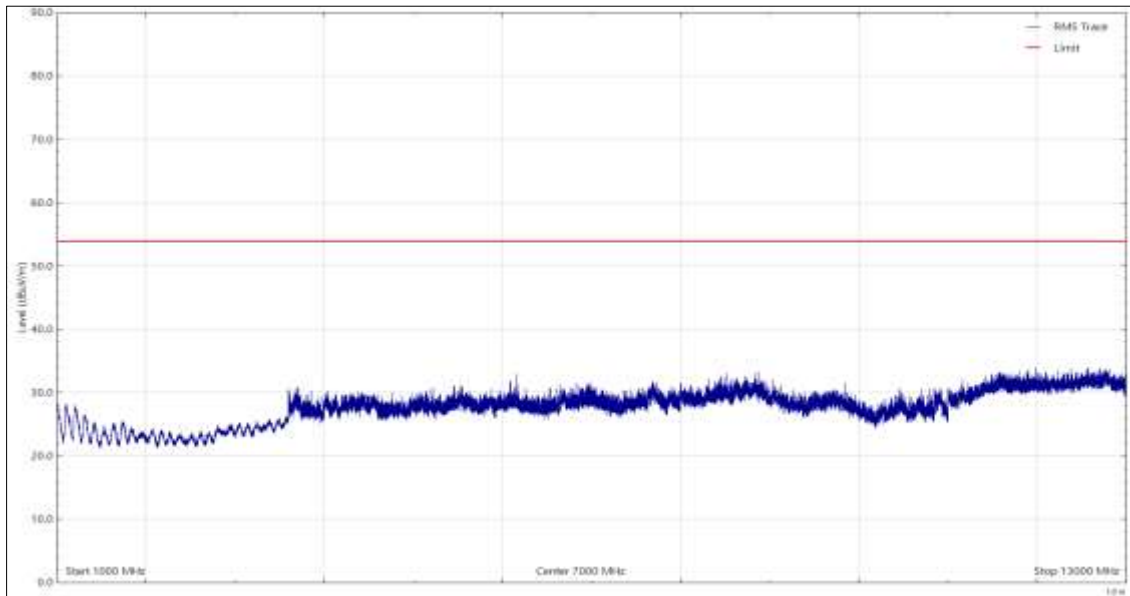

**Figure 16 - 1 GHz to 13 GHz, Peak, Vertical - Z Orientation**

Frequency (MHz)	Level (dBµV/m)	Limit (dBµV/m)	Margin (dB)	Detector	Angle (°)	Height (cm)	Polarisation
*							

**Table 34**

\*No final measurements were made as all peak emissions seen above the measurement system noise floor during the pre-scan were greater than 10 dB below the test limit.

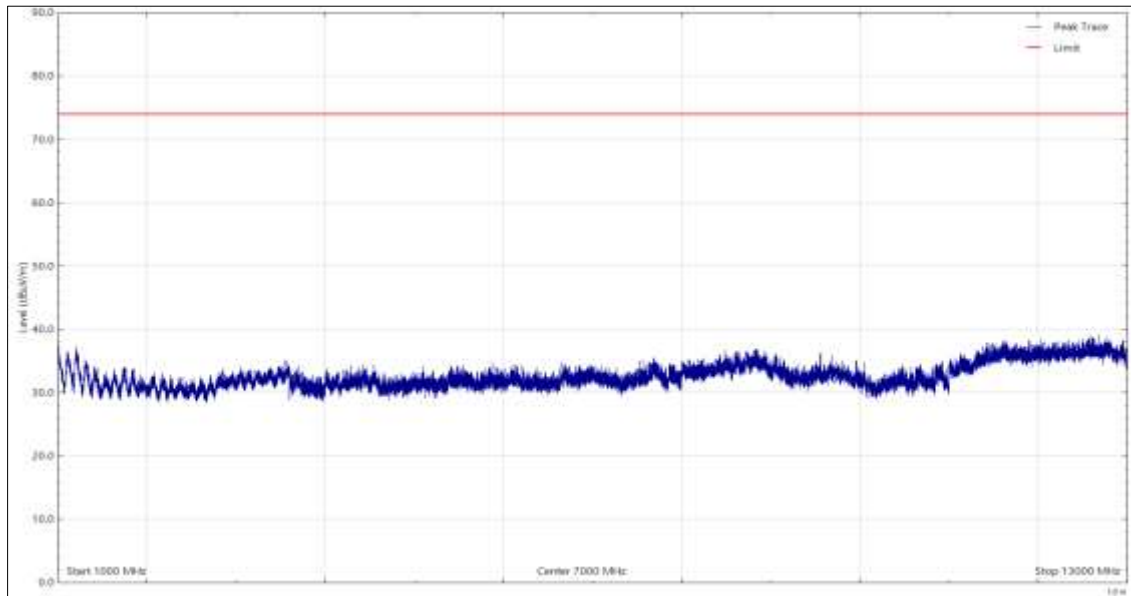

**Figure 17 - 1 GHz to 13 GHz, CISPR Average, Vertical - Z Orientation**

Frequency (MHz)	Level (dBµV/m)	Limit (dBµV/m)	Margin (dB)	Detector	Angle (°)	Height (cm)	Polarisation
*							

**Table 35**

\*No final measurements were made as all peak emissions seen above the measurement system noise floor during the pre-scan were greater than 10 dB below the test limit.

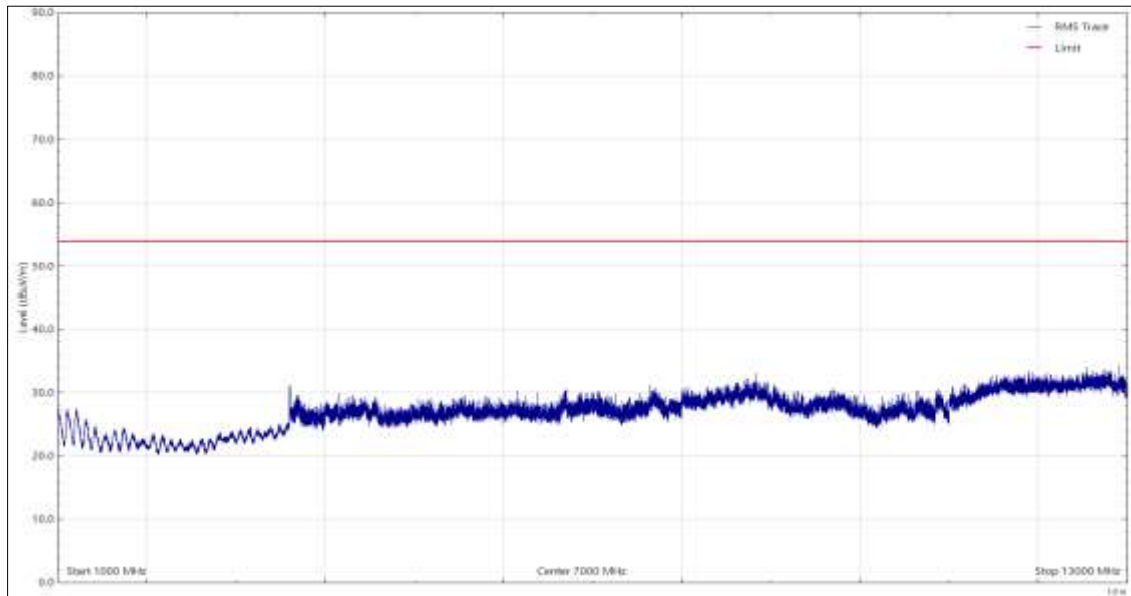

**Figure 18 - 1 GHz to 13 GHz, Peak, Horizontal - Z Orientation**

Frequency (MHz)	Level (dBµV/m)	Limit (dBµV/m)	Margin (dB)	Detector	Angle (°)	Height (cm)	Polarisation
*							

**Table 36**

\*No final measurements were made as all peak emissions seen above the measurement system noise floor during the pre-scan were greater than 10 dB below the test limit.



**Figure 19 - 1 GHz to 13 GHz, CISPR Average, Horizontal - Z Orientation**

Frequency (MHz)	Level (dBµV/m)	Limit (dBµV/m)	Margin (dB)	Detector	Angle (°)	Height (cm)	Polarisation
*							

**Table 37**

\*No final measurements were made as all peak emissions seen above the measurement system noise floor during the pre-scan were greater than 10 dB below the test limit.



**Figure 20 - Test Setup - 30 MHz to 1 GHz - X Orientation**



Figure 21 - Test Setup - 30 MHz to 1 GHz - Y Orientation



**Figure 22 - Test Setup - 30 MHz to 1 GHz - Z Orientation**





Figure 23 - Test Setup - 1 GHz to 13 GHz - X Orientation



Figure 24 - Test Setup - 1 GHz to 13 GHz - Y Orientation



Figure 25 - Test Setup - 1 GHz to 13 GHz - Z Orientation



**2.1.10 Test Location and Test Equipment Used**

This test was carried out in EMC Chamber 12.

Instrument	Manufacturer	Type No	TE No	Calibration Period (months)	Calibration Expires
3m Semi Anechoic Chamber	MVG	EMC-3	5621	36	11-Aug-2023
EmX Emissions Software	TUV SUD	V2.1.11	5125	-	Software
EMI Test Receiver	Rohde & Schwarz	ESU40	3506	12	18-Mar-2022
Test Receiver	Rohde & Schwarz	ESW44	5379	12	15-Dec-2021
Turntable & Mast Controller	Maturo Gmbh	NCD/498/2799.01	5612	-	TU
Tilt Antenna Mast TAM 4.0-P	Maturo Gmbh	TAM 4.0-P	5613	-	TU
Turntable	Maturo Gmbh	Turntable 1.5 SI-2t	5614	-	TU
1m -SMA Cable	Junkosha	MWX221-01000AMSAMS/A	5515	12	01-Apr-2021
8m N Type Cable	Junkosha	MWX221-08000NMSNMS/B	5519	12	24-Mar-2021
Cable Assembly - 18GHz 8m	Junkosha	MWX221-08000NMSNMS/B	5732	6	05-Aug-2021
3.5 mm 2m Cable	Junkosha	MWX221-02000DMS	5428	12	15-Oct-2021
Preamplifier (30dB 1GHz to 18GHz)	Schwarzbeck	BBV 9718 C	5350	12	21-Sep-2021
Antenna with permanent attenuator (Bilog)	Schaffner	CBL6143	287	24	14-Oct-2022
Broadband Horn Antenna (1-10 GHz)	Schwarzbeck	BBHA 9120 B	5611	12	22-Sep-2021
DRG Horn Antenna (7.5-18GHz)	Schwarzbeck	HWRD750	5610	12	22-Sep-2021

**Table 38**

TU - Traceability Unscheduled



### 3 Test Equipment Information

#### 3.1 General Test Equipment Used

Instrument	Manufacturer	Type No	TE No	Calibration Period (months)	Calibration Expires
Comb Generator	Schaffner	RSG1000	3034	-	TU
Antenna (Double Ridge Guide, 1GHz-18GHz)	EMCO	3115	795	12	16-Oct-2021
Spectrum Analyser	Agilent Technologies	E7405A	1410	12	14-Oct-2021
Thermo-Hygro-Barometer	PCE Instruments	PCE-THB-40	5481	12	18-Mar-2021
8 Meter Cable	Teledyne	PR90-088-8MTR	5212	12	03-Sep-2021
Thermo-Hygro-Barometer	PCE Instruments	PCE-THB-40	5482	-	18-Mar-2021

**Table 39**

TU - Traceability Unscheduled



## 4 Incident Reports

No incidents reports were raised.



## 5 Measurement Uncertainty

For a 95% confidence level, the measurement uncertainties for defined systems are:

Test Name	Measurement Uncertainty
Radiated Disturbance	30 MHz to 1 GHz, Bilog Antenna, $\pm 5.2$ dB 1 GHz to 40 GHz, Horn Antenna, $\pm 6.3$ dB

**Table 40**

Worst case error for both Time and Frequency measurement 12 parts in  $10^6$ .

### Measurement Uncertainty Decision Rule

Determination of conformity with the specification limits is based on the decision rule according to IEC Guide 115: 2007, clause 4.4.3 and 4.5.1.