

FCC Test Report

Omni-ID
BLE tag, Model: Sense Shield

In accordance with FCC 47 CFR Part 15C
(2.4 GHz Bluetooth)

Prepared for: Omni-ID
The Enterprise Centre
Coxbridge Business Park
Alton Road
Farnham
Surrey
GU10 5EH
UNITED KINGDOM



FCC ID: 2AYWZ -SENSE-SHIELD

COMMERCIAL-IN-CONFIDENCE

Document 75949856-12 Issue 01

SIGNATURE			
NAME	JOB TITLE	RESPONSIBLE FOR	ISSUE DATE
Steve Marshall	Senior Engineer	Authorised Signatory	20 October 2021

Signatures in this approval box have checked this document in line with the requirements of TÜV SÜD document control rules.

ENGINEERING STATEMENT

The measurements shown in this report were made in accordance with the procedures described on test pages. All reported testing was carried out on a sample equipment to demonstrate limited compliance with FCC 47 CFR Part 15C. The sample tested was found to comply with the requirements defined in the applied rules.

RESPONSIBLE FOR	NAME	DATE	SIGNATURE
Testing	Graeme Lawler	20 October 2021	

FCC Accreditation
90987 Octagon House, Fareham Test Laboratory

EXECUTIVE SUMMARY

A sample of this product was tested and found to be compliant with FCC 47 CFR Part 15C: 2020 for the tests detailed in section 1.3.

		DISCLAIMER AND COPYRIGHT This non-binding report has been prepared by TÜV SÜD with all reasonable skill and care. The document is confidential to the potential Client and TÜV SÜD. No part of this document may be reproduced without the prior written approval of TÜV SÜD. © 2021 TÜV SÜD. This report relates only to the actual item/items tested.
		ACCREDITATION Our UKAS Accreditation does not cover opinions and interpretations and any expressed are outside the scope of our UKAS Accreditation. Results of tests not covered by our UKAS Accreditation Schedule are marked NUA (Not UKAS Accredited).

TÜV SÜD
is a trading name of TÜV SÜD Ltd
Registered in Scotland at East Kilbride,
Glasgow G75 0QF, United Kingdom
Registered number: SC215164

TÜV SÜD Ltd is a
TÜV SÜD Group Company

Phone: +44 (0) 1489 558100
Fax: +44 (0) 1489 558101
www.tuvsud.com/en

TÜV SÜD
Octagon House
Concorde Way
Fareham
Hampshire PO15 5RL
United Kingdom



Contents

1	Report Summary	2
1.1	Report Modification Record.....	2
1.2	Introduction.....	2
1.3	Brief Summary of Results	3
1.4	Application Form	4
1.5	Product Information	7
1.6	Deviations from the Standard.....	7
1.7	EUT Modification Record	7
1.8	Test Location	7
2	Test Details	8
2.1	Authorised Band Edges	8
2.2	Restricted Band Edges.....	12
2.3	Spurious Radiated Emissions	16
3	Measurement Uncertainty	61



1 Report Summary

1.1 Report Modification Record

Alterations and additions to this report will be issued to the holders of each copy in the form of a complete document.

Issue	Description of Change	Date of Issue
1	First Issue	20-October-2021

Table 1

1.2 Introduction

Applicant	Omni-ID
Manufacturer	Omni-ID
Model Number(s)	Sense Shield
Serial Number(s)	Not Serialised (Storix ID 551011-51), Not Serialised (Storix ID 551011-52) and Not Serialised (Storix ID 551011-53)
Hardware Version(s)	K
Software Version(s)	1.7
Number of Samples Tested	3
Test Specification/Issue/Date	FCC 47 CFR Part 15C: 2020
Order Number	20200033
Date	27-August-2020
Date of Receipt of EUT	11-February-2021
Start of Test	23-August-2021
Finish of Test	26-August-2021
Name of Engineer(s)	Graeme Lawler
Related Document(s)	ANSI C63.10 (2013)



1.3 Brief Summary of Results

A brief summary of the tests carried out in accordance with FCC 47 CFR Part 15C is shown below.

Section	Specification Clause	Test Description	Result	Comments/Base Standard
Configuration and Mode: 2.4 GHz Bluetooth Low Energy				
2.1	15.247 (d)	Authorised Band Edges	Pass	ANSI C63.10
2.2	15.205	Restricted Band Edges	Pass	ANSI C63.10
2.3	15.247 (d) and 15.205	Spurious Radiated Emissions	Pass	ANSI C63.10

Table 2



1.4 Application Form

Equipment Description

Technical Description: <i>(Please provide a brief description of the intended use of the equipment including the technologies the product supports)</i>	A BLE tag used to locate personnel and Assets Tag advertises only and does not pair.	
Manufacturer:	Omni Id	
Model:	Sense Shield	
Part Number:	CP14828	
Hardware Version:	K	
Software Version:	1.7	
FCC ID of the product under test – see guidance here	2AYWZ -SENSE-SHIELD	
IC ID of the product under test – see guidance here	Not applicable	

Table 3

Intentional Radiators

Technology	Bluetooth Low Energy					
Frequency Range (MHz to MHz)	2401-2481					
Conducted Declared Output Power (dBm)	8					
Antenna Gain (dBi)	0					
Supported Bandwidth(s) (MHz) (e.g 1 MHz, 20 MHz, 40 MHz)	1 MHz					
Modulation Scheme(s) (e.g GFSK, QPSK etc)	FSK					
ITU Emission Designator (see guidance here) (not mandatory for Part 15 devices)	1M00XD					
Bottom Frequency (MHz)	2401					
Middle Frequency (MHz)	2441					
Top Frequency (MHz)	2481					

Table 4

Un-intentional Radiators

Highest frequency generated or used in the device or on which the device operates or tunes	
Lowest frequency generated or used in the device or on which the device operates or tunes	
Class A Digital Device (Use in commercial, industrial or business environment) <input type="checkbox"/>	
Class B Digital Device (Use in residential environment only) <input type="checkbox"/>	

Table 5



AC Power Source

AC supply frequency:		Hz
Voltage		V
Max current:		A
Single Phase <input type="checkbox"/> Three Phase <input type="checkbox"/>		

Table 6

DC Power Source

Nominal voltage:		V
Extreme upper voltage:		V
Extreme lower voltage:		V
Max current:		A

Table 7

Battery Power Source

Voltage:	3	V
End-point voltage:	1.8	V (Point at which the battery will terminate)
Alkaline <input checked="" type="checkbox"/> Leclanche <input type="checkbox"/> Lithium <input type="checkbox"/> Nickel Cadmium <input type="checkbox"/> Lead Acid* <input type="checkbox"/> *(Vehicle regulated)		
Other <input type="checkbox"/>	Please detail:	

Table 8

Charging

Can the EUT transmit whilst being charged	Yes <input type="checkbox"/> No <input checked="" type="checkbox"/>
---	---

Table 9

Temperature

Minimum temperature:	-20	°C
Maximum temperature:	60	°C

Table 10

Cable Loss

Adapter Cable Loss (Conducted sample)		dB
--	--	----

Table 11



Antenna Characteristics

Antenna connector <input type="checkbox"/>			State impedance		Ohm
Temporary antenna connector <input type="checkbox"/>			State impedance		Ohm
Integral antenna <input checked="" type="checkbox"/>	Type:	PCB Etch	Gain	0	dBi
External antenna <input type="checkbox"/>	Type:		Gain		dBi
For external antenna only: Standard Antenna Jack <input type="checkbox"/> If yes, describe how user is prohibited from changing antenna (if not professional installed): Equipment is only ever professionally installed <input type="checkbox"/> Non-standard Antenna Jack <input type="checkbox"/>					

Table 12

Ancillaries (if applicable)

Manufacturer:		Part Number:	
Model:		Country of Origin:	

Table 13

I hereby declare that the information supplied is correct and complete.

Name: Charles Vilner
 Position held: Engineering Director
 Date: 01 September 2021



1.5 Product Information

1.5.1 Technical Description

A BLE tag used to locate personnel and Assets Tag advertises only and does not pair.

1.6 Deviations from the Standard

No deviations from the applicable test standard were made during testing.

1.7 EUT Modification Record

The table below details modifications made to the EUT during the test programme.

The modifications incorporated during each test are recorded on the appropriate test pages.

Modification State	Description of Modification still fitted to EUT	Modification Fitted By	Date Modification Fitted
Model: Sense Shield, Serial Number: Not Serialised (Storix ID 551011-51)			
0	As supplied by the customer	Not Applicable	Not Applicable
Model: Sense Shield, Serial Number: Not Serialised (Storix ID 551011-52)			
0	As supplied by the customer	Not Applicable	Not Applicable
Model: Sense Shield, Serial Number: Not Serialised (Storix ID 551011-53)			
0	As supplied by the customer	Not Applicable	Not Applicable

Table 14

1.8 Test Location

TÜV SÜD conducted the following tests at our Fareham Test Laboratory.

Test Name	Name of Engineer(s)	Accreditation
Configuration and Mode: 2.4 GHz Bluetooth Low Energy		
Authorised Band Edges	Graeme Lawler	UKAS
Restricted Band Edges	Graeme Lawler	UKAS
Spurious Radiated Emissions	Graeme Lawler	UKAS

Table 15

Office Address:

TÜV SÜD
Octagon House
Concorde Way
Fareham
Hampshire
PO15 5RL
United Kingdom



2 Test Details

2.1 Authorised Band Edges

2.1.1 Specification Reference

FCC 47 CFR Part 15C, Clause 15.247 (d)

2.1.2 Equipment Under Test and Modification State

Sense Shield, S/N: Not Serialised (Storix ID 551011-51) - Modification State 0
Sense Shield, S/N: Not Serialised (Storix ID 551011-52) - Modification State 0

2.1.3 Date of Test

23-August-2021 to 25-August-2021

2.1.4 Test Method

The test was performed in accordance with ANSI C63.10, clause 6.10.4.

2.1.5 Environmental Conditions

Ambient Temperature	17.2 - 17.6 °C
Relative Humidity	60.1 - 61.8 %



2.1.6 Test Results

2.4 GHz Bluetooth Low Energy

Modulation	Frequency (MHz)	Band Edge Frequency (MHz)	Level (dBc)
GFSK	2402	2400.0	-46.58
GFSK	2480	2483.5	-51.18

Table 16

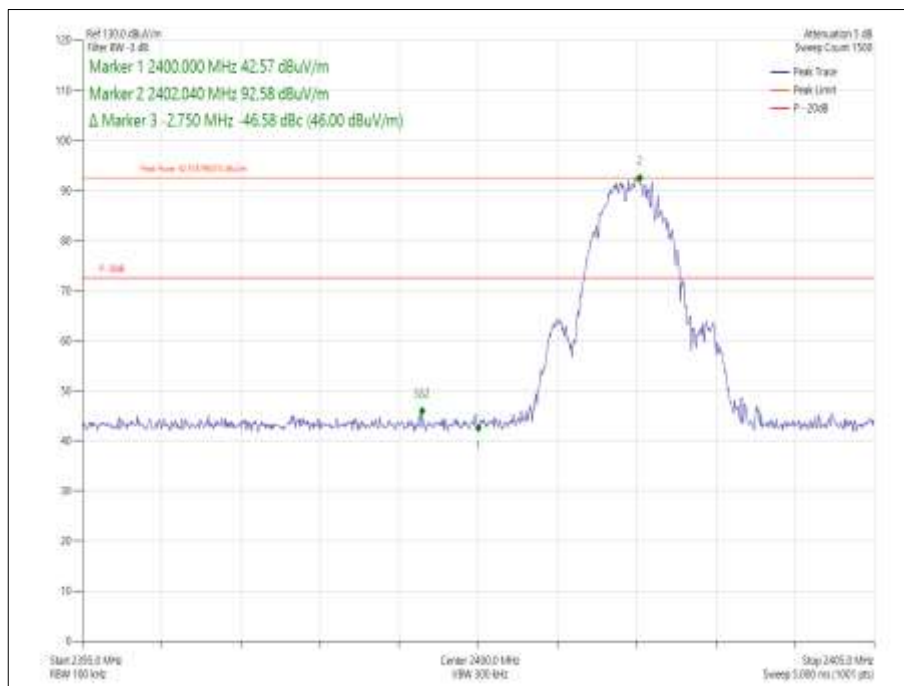

Figure 1 - GFSK - 2402 MHz – Band Edge Frequency 2400.0 MHz

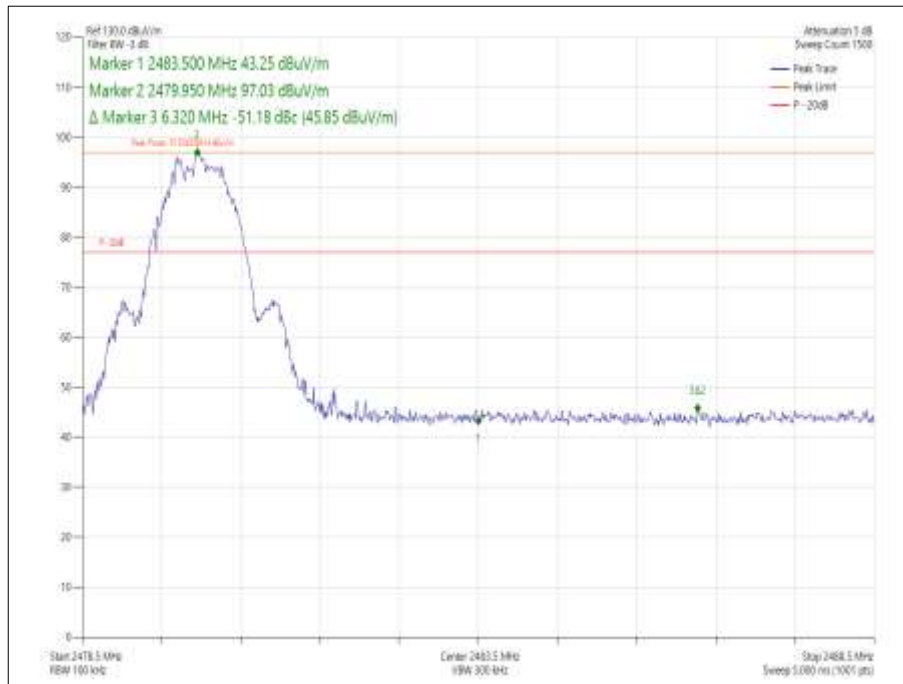

Figure 2 - GFSK - 2480 MHz – Band Edge Frequency 2483.5 MHz

FCC 47 CFR Part 15, Limit Clause 15.247 (d)

20 dB below the fundamental measured in a 100 kHz bandwidth using a peak detector. If the transmitter complies with the conducted power limits, based on the use of RMS averaging over a time interval, the attenuation required shall be 30 dB below the fundamental instead of 20 dB.

2.1.7 Test Location and Test Equipment Used

This test was carried out in EMC Chamber 12.

Instrument	Manufacturer	Type No	TE No	Calibration Period (months)	Calibration Due
Power Supply Unit	Hewlett Packard	6269B	113	-	O/P Mon
EMI Test Receiver	Rohde & Schwarz	ESU40	3506	12	18-Mar-2022
EmX Emissions Software	TUV SUD	V2.1.11 V.V2.1.11	5125	-	N/A - Software
3.5 mm 2m Cable	Junkosha	MWX221-02000DMS	5428	12	15-Oct-2021
8 Meter Cable	Teledyne	PR90-088-8MTR	5450	6	8-Mar-2022
Thermo-Hygro-Barometer	PCE Instruments	PCE-THB-40	5481	12	31-Mar-2022
DVM - Digital Multimeter	Iso-tech	IDM101	5601	12	4-Aug-2022
Broadband Horn Antenna (1-10 GHz)	Schwarzbeck	BBHA 9120 B	5611	12	22-Sep-2021
Turntable & Mast Controller	Maturo Gmbh	NCD/498/2799.01	5612	-	TU



Tilt Antenna Mast TAM 4.0-P	Maturo Gmbh	TAM 4.0-P	5613	-	TU
Turntable	Maturo Gmbh	Turntable 1.5 SI-2t	5614	-	TU
3m Semi Anechoic Chamber	MVG	EMC-3	5621	36	11-Aug-2023

Table 17

TU – Traceability Unscheduled
O/P Mon – Output Monitored using calibrated equipment



2.2 Restricted Band Edges

2.2.1 Specification Reference

FCC 47 CFR Part 15C, Clause 15.205

2.2.2 Equipment Under Test and Modification State

Sense Shield, S/N: Not Serialised (Storix ID 551011-51) - Modification State 0
Sense Shield, S/N: Not Serialised (Storix ID 551011-52) - Modification State 0

2.2.3 Date of Test

23-August-2021 to 25-August-2021

2.2.4 Test Method

This test was performed in accordance with ANSI C63.10, clause 6.10.5.

Plots for average measurements were taken in accordance with ANSI C63.10, clause 4.1.4.2.5. These are shown for information purposes and were used to determine the worst-case measurement point. To determine the final average value, a peak measurement was performed, and the duty cycle correction factor determined from clause 11.12.2.5.2 was subtracted from it to obtain the measurement result recorded in the test results tables.

The following conversion can be applied to convert from dB μ V/m to μ V/m:
 $10^{(\text{Field Strength in dB}\mu\text{V/m}/20)}$.

2.2.5 Environmental Conditions

Ambient Temperature	17.2 °C
Relative Humidity	60.1 %



2.2.6 Test Results

2.4 GHz Bluetooth Low Energy

Modulation	Frequency (MHz)	Band Edge Frequency (MHz)	Peak Level (dB μ V/m)	Average Level (dB μ V/m)
GFSK	2402	2390.0	56.50	37.03
GFSK	2480	2483.5	59.13	39.66

Table 18

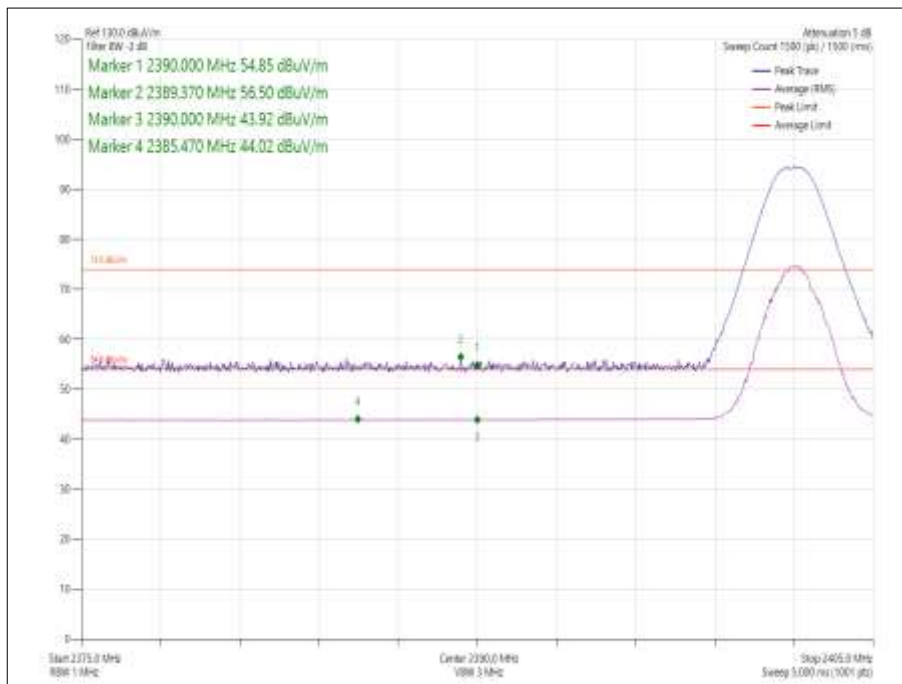

Figure 3 - GFSK - 2402 MHz – Band Edge Frequency 2390.0 MHz

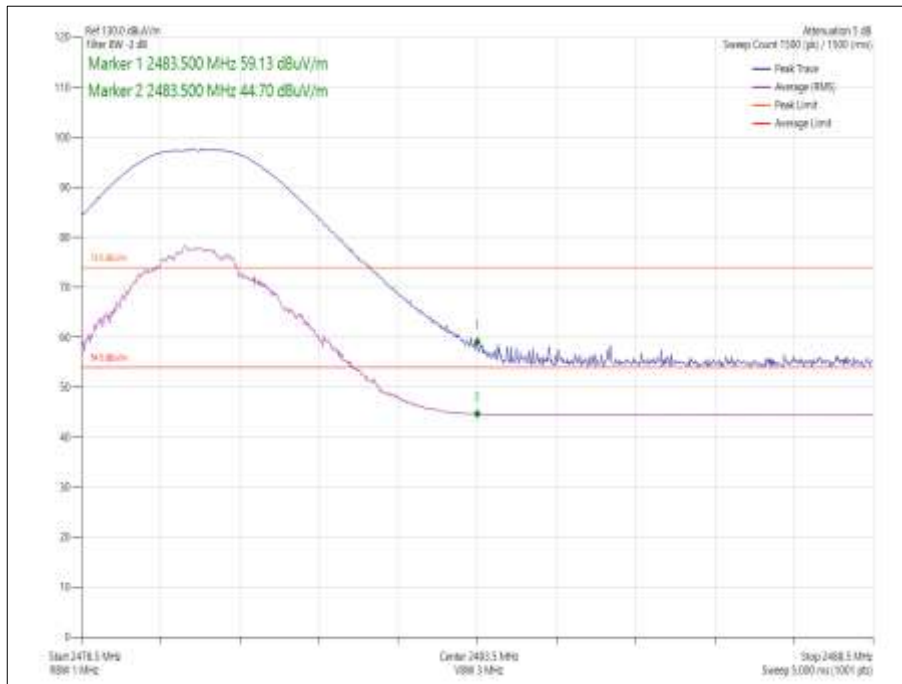

Figure 4 - GFSK - 2480 MHz – Band Edge Frequency 2483.5 MHz

FCC 47 CFR Part 15, Limit Clause 15.209

Frequency (MHz)	Field Strength ($\mu\text{V}/\text{m}$ at 3 m)
30 to 88	100
88 to 216	150
216 to 960	200
Above 960	500

Table 19



2.2.7 Test Location and Test Equipment Used

This test was carried out in EMC Chamber 12.

Instrument	Manufacturer	Type No	TE No	Calibration Period (months)	Calibration Due
Power Supply Unit	Hewlett Packard	6269B	113	-	O/P Mon
EMI Test Receiver	Rohde & Schwarz	ESU40	3506	12	18-Mar-2022
EmX Emissions Software	TUV SUD	V2.1.11 V.V2.1.11	5125	-	Software
3.5 mm 2m Cable	Junkosha	MWX221-02000DMS	5428	12	15-Oct-2021
8 Meter Cable	Teledyne	PR90-088-8MTR	5450	6	8-Mar-2022
Thermo-Hygro-Barometer	PCE Instruments	PCE-THB-40	5481	12	31-Mar-2022
DVM - Digital Multimeter	Iso-tech	IDM101	5601	12	04-Aug-2022
Broadband Horn Antenna (1-10 GHz)	Schwarzbeck	BBHA 9120 B	5611	12	22-Sep-2021
Turntable & Mast Controller	Maturo Gmbh	NCD/498/2799.01	5612	-	TU
Tilt Antenna Mast TAM 4.0-P	Maturo Gmbh	TAM 4.0-P	5613	-	TU
Turntable	Maturo Gmbh	Turntable 1.5 SI-2t	5614	-	TU
3m Semi Anechoic Chamber	MVG	EMC-3	5621	36	11-Aug-2023

Table 20

TU – Traceability Unscheduled
 O/P Mon – Output Monitored using calibrated equipment



2.3 Spurious Radiated Emissions

2.3.1 Specification Reference

FCC 47 CFR Part 15C, Clause 15.247 (d) and 15.205

2.3.2 Equipment Under Test and Modification State

Sense Shield, S/N: Not Serialised (Storix ID 551011-51) - Modification State 0
Sense Shield, S/N: Not Serialised (Storix ID 551011-52) - Modification State 0
Sense Shield, S/N: Not Serialised (Storix ID 551011-53) - Modification State 0

2.3.3 Date of Test

23-August-2021 to 26-August-2021

2.3.4 Test Method

This test was performed in accordance with ANSI C63.10, clause 6.3, 6.5 and 6.6.

The EUT was placed on the non-conducting platform in a manner typical of a normal installation. For an EUT which could reasonable be used in multiple planes, pre-scans were performed with the EUT orientated in X, Y and Z planes with reference to the ground plane.

For frequencies > 1 GHz, plots for average measurements were taken in accordance with ANSI C63.10 clause 4.1.4.2.5 to characterize the EUT. Where emissions were detected, final average measurements were taken in accordance with ANSI C63.10 clause 11.12.2.5.2.

The plots shown are the characterization of the EUT. The limits on the plots represent the most stringent case for restricted bands, (74/54 dBuV/m) when compared to 20 dBc outside restricted bands. The limits shown have been used as a threshold to determine where further measurements are necessary. Where results are within 10 dB of the limits shown on the plots, further investigation was carried out and reported in results tables.

The following conversion can be applied to convert from dBµV/m to µV/m:

$$10^{(\text{Field Strength in dB}\mu\text{V/m}/20)}.$$

To determine the emission characteristic of the EUT above 18 GHz, the test antenna was swept over all faces of the EUT whilst observing a spectral display. The frequency of any emissions of interest was noted for formal measurement at the correct measurement distance of 1m. This procedure was repeated for all relevant transmit operating channels.

At a measurement distance of 1 meter the limit line was increased by $20 \cdot \text{LOG}(3/1) = 9.54 \text{ dB}$.

Where formal measurements have been necessary, the results have been presented in the emissions table.

2.3.1 Example Test Setup Diagram

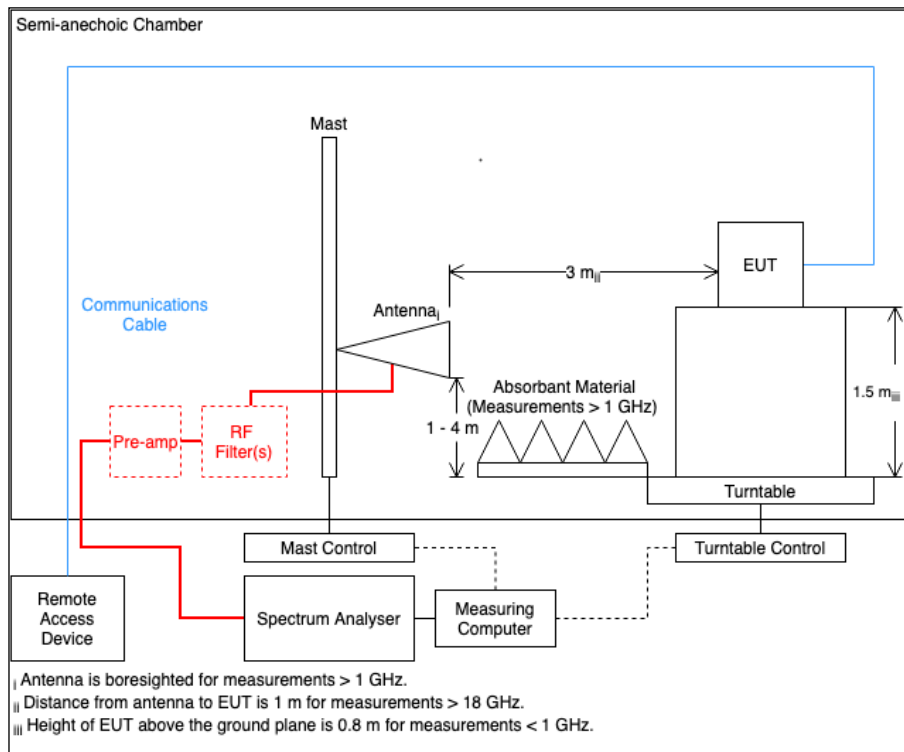

Figure 5

2.3.2 Environmental Conditions

Ambient Temperature	17.2 - 19.1 °C
Relative Humidity	60.1 - 64.9 %



2.3.3 Test Results

2.4 GHz Bluetooth Low Energy

Frequency (MHz)	Level (dBµV/m)	Limit (dBµV/m)	Margin (dB)	Detector	Angle (°)	Height (cm)	Polarisation	Orientation
*								

Table 21 - 2402 MHz, 30 MHz to 1 GHz

*No emissions were detected within 10 dB of the limit.

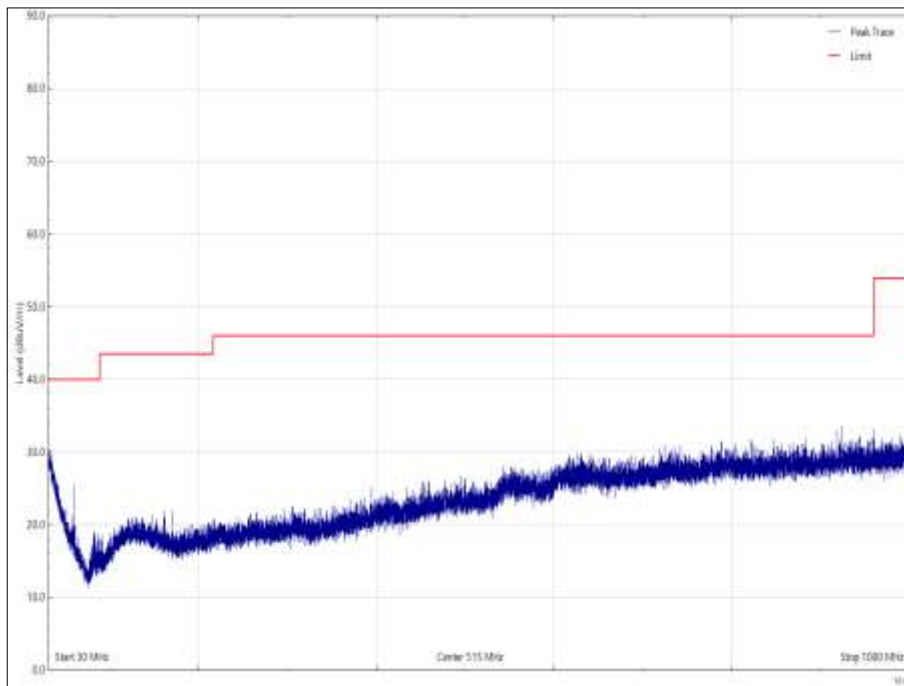

Figure 6 - 30 MHz to 1 GHz, 2402 MHz, Quasi-Peak, Vertical, Orientation X

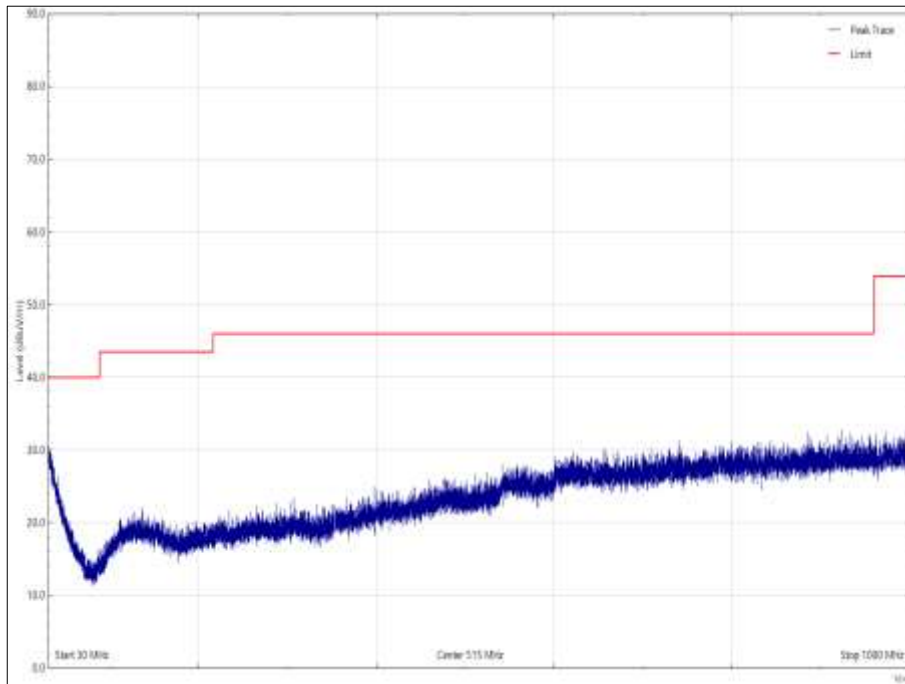

Figure 7 - 30 MHz to 1 GHz, 2402 MHz, Quasi-Peak, Horizontal, Orientation X

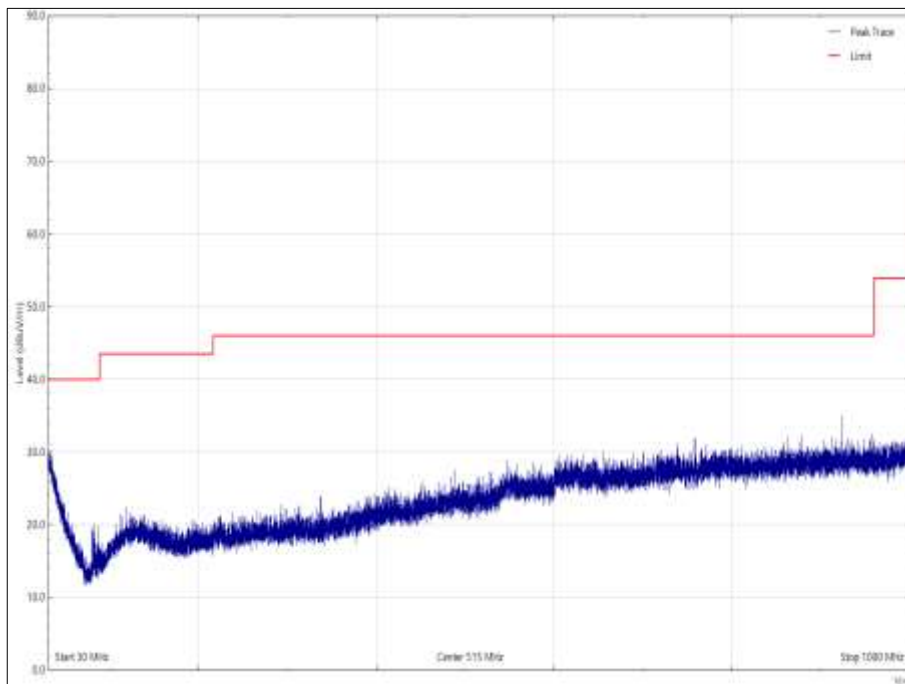

Figure 8 - 30 MHz to 1 GHz, 2402 MHz, Quasi-Peak, Vertical, Orientation Y

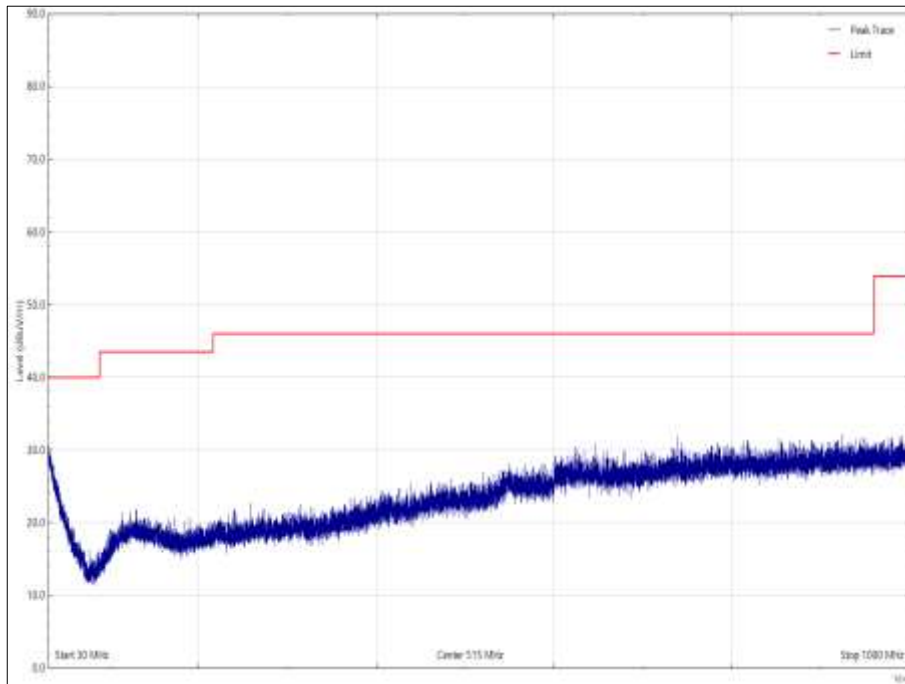

Figure 9 - 30 MHz to 1 GHz, 2402 MHz, Quasi-Peak, Horizontal, Orientation Y

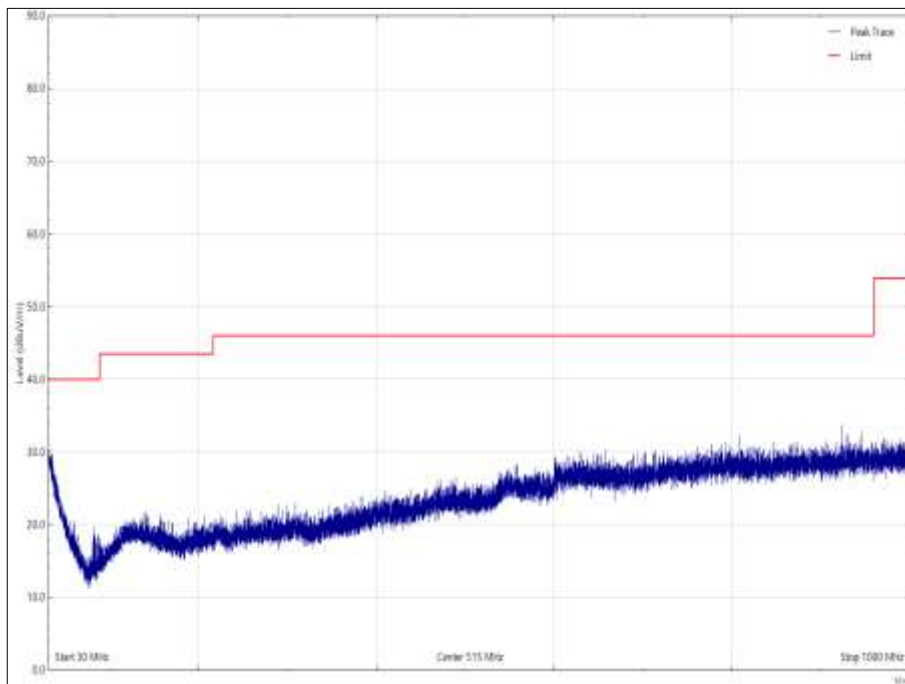

Figure 10 - 30 MHz to 1 GHz, 2402 MHz, Quasi-Peak, Vertical, Orientation Z

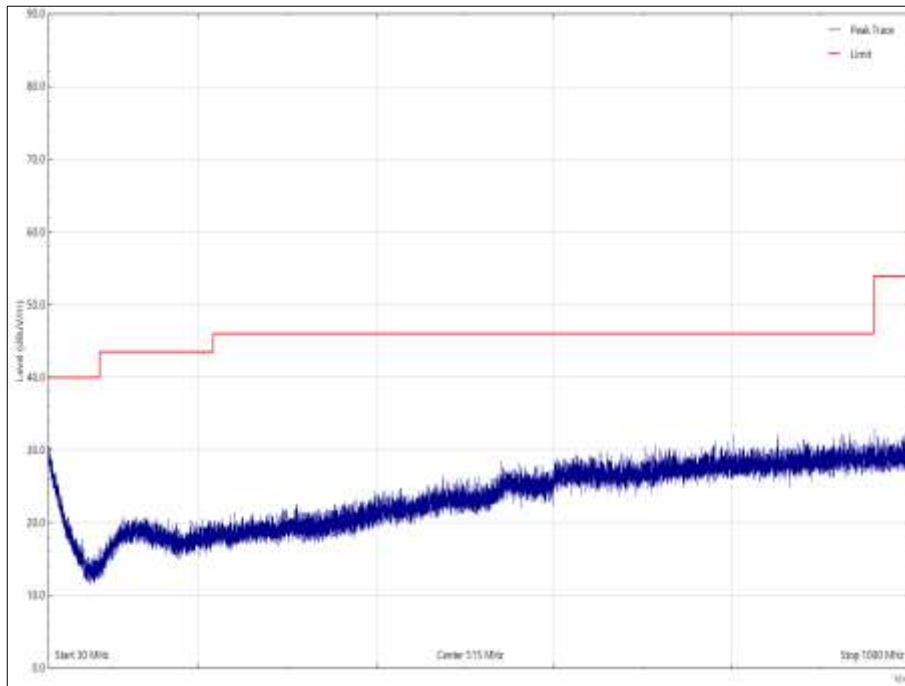

Figure 11 - 30 MHz to 1 GHz, 2402 MHz, Quasi-Peak, Horizontal, Orientation Z



Frequency (MHz)	Level (dB μ V/m)	Limit (dB μ V/m)	Margin (dB)	Detector	Angle (°)	Height (cm)	Polarisation	Orientation
4803.715	48.17	53.98	5.81	Average	317	101	Vertical	Y
4803.923	50.48	53.98	3.50	Average	355	284	Vertical	Z
4803.933	49.12	53.98	4.86	Average	77	100	Horizontal	Z

Table 22 - 2402 MHz, 1 GHz to 25 GHz

No other emissions were detected within 10 dB of the limit.

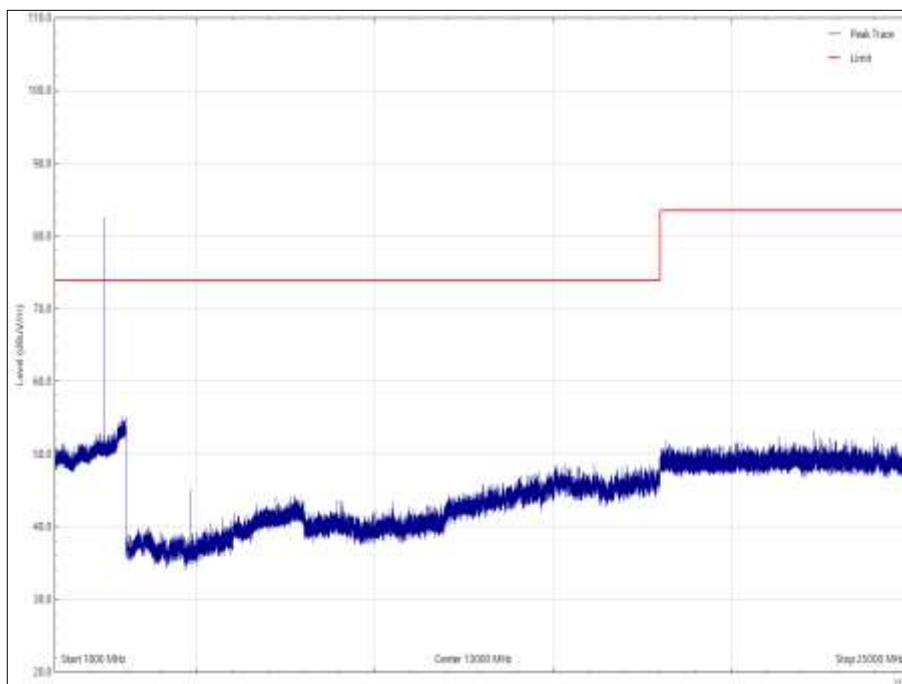

Figure 12 - 2402 MHz, 1 GHz to 25 GHz, Vertical, X Orientation, Peak

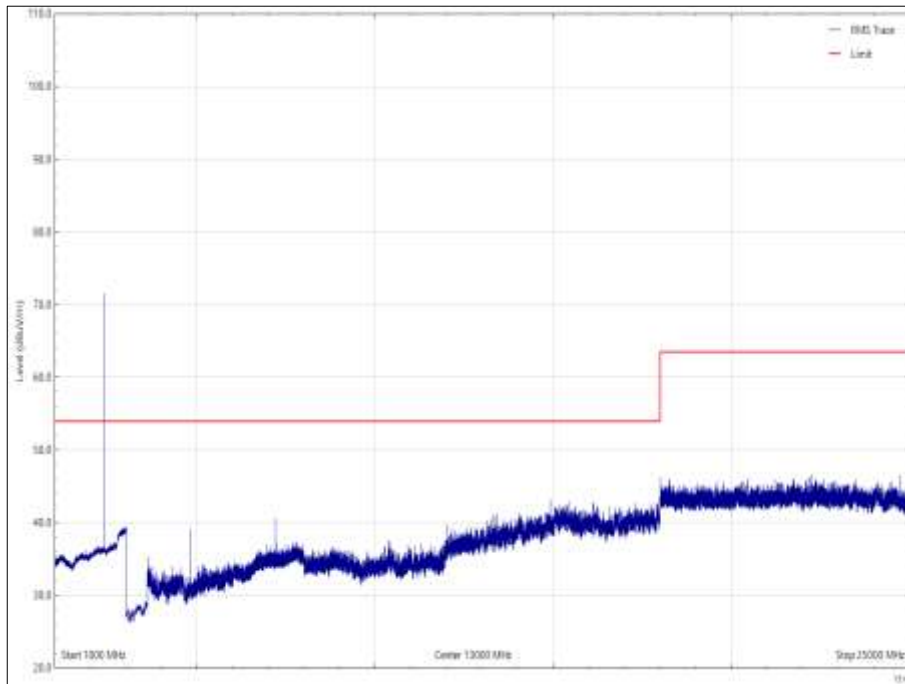

Figure 13 - 2402 MHz, 1 GHz to 25 GHz, Vertical, X Orientation, Average

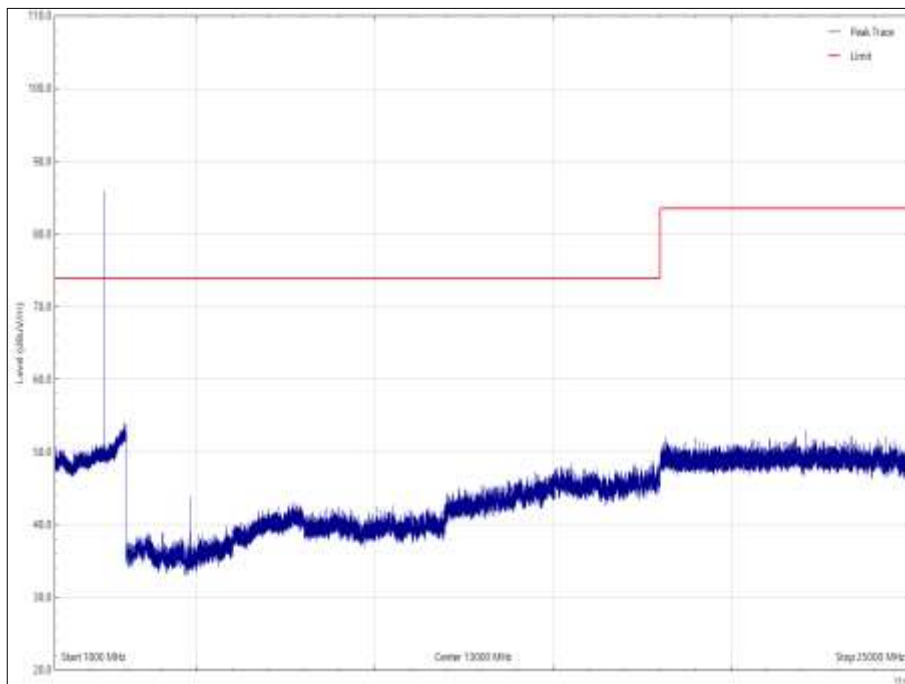

Figure 14 - 2402 MHz, 1 GHz to 25 GHz, Horizontal, X Orientation, Peak

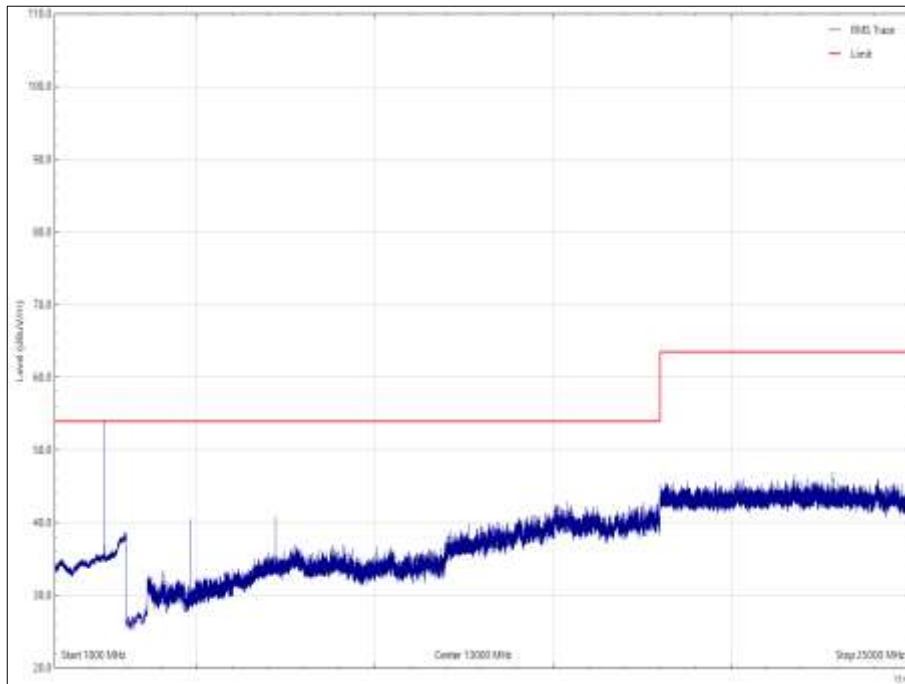

Figure 15 - 2402 MHz, 1 GHz to 25 GHz, Horizontal, X Orientation, Average

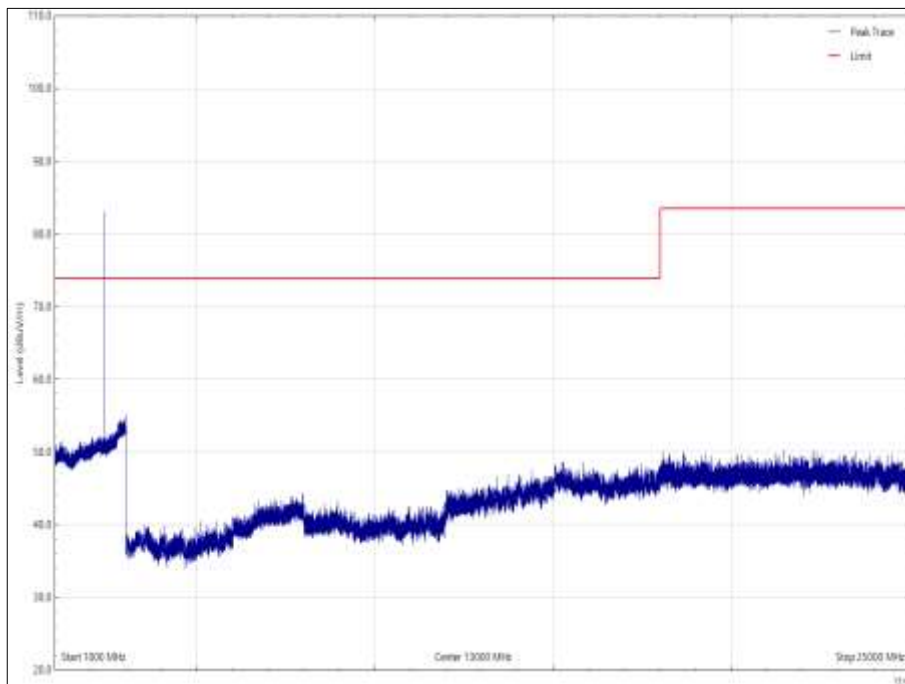

Figure 16 - 2402 MHz, 1 GHz to 25 GHz, Vertical, Y Orientation, Peak

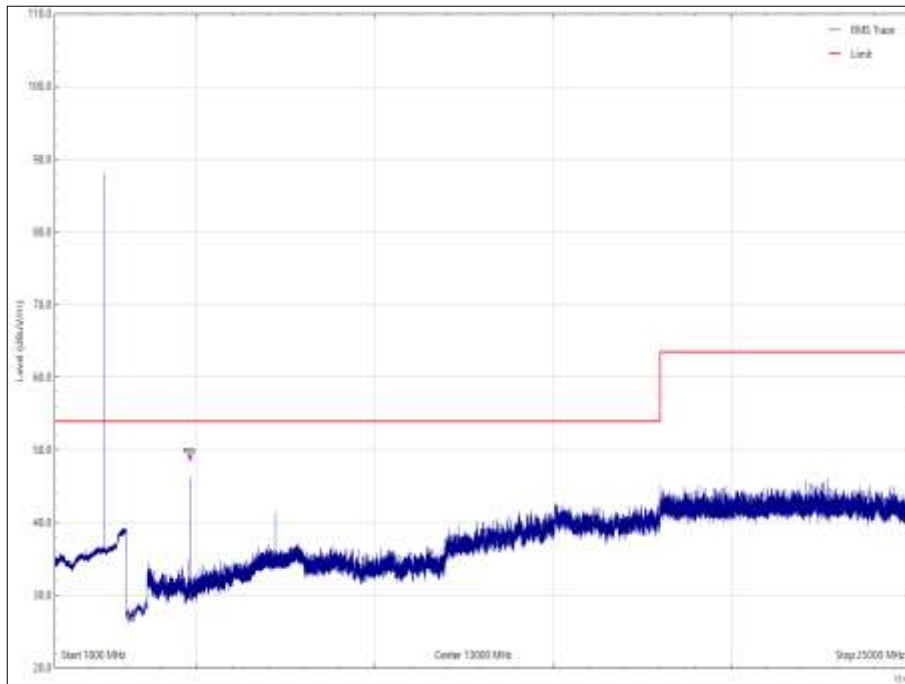

Figure 17 - 2402 MHz, 1 GHz to 25 GHz, Vertical, Y Orientation, Average

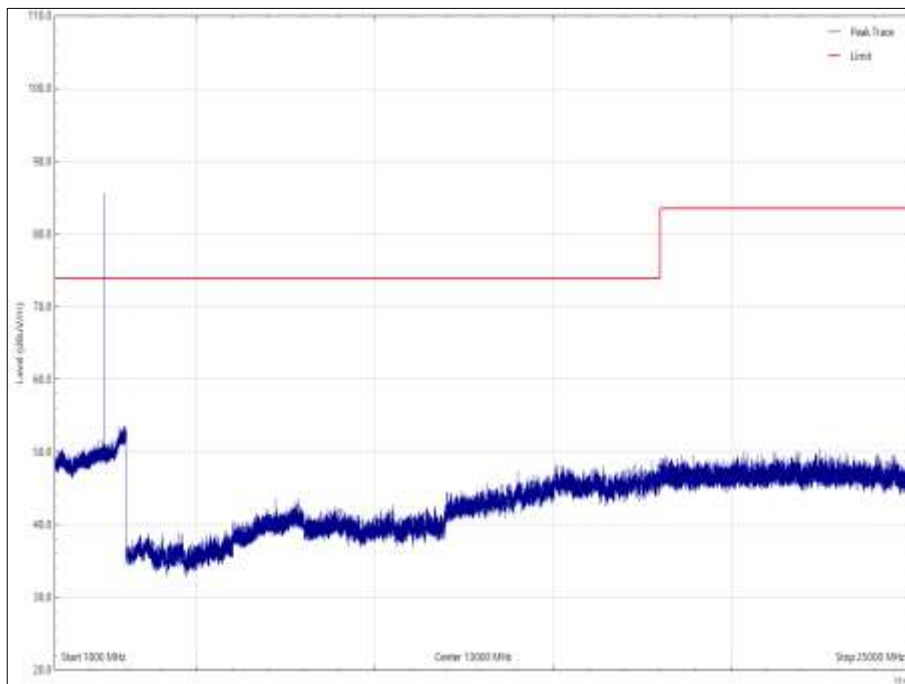

Figure 18 - 2402 MHz, 1 GHz to 25 GHz, Horizontal, Y Orientation, Peak

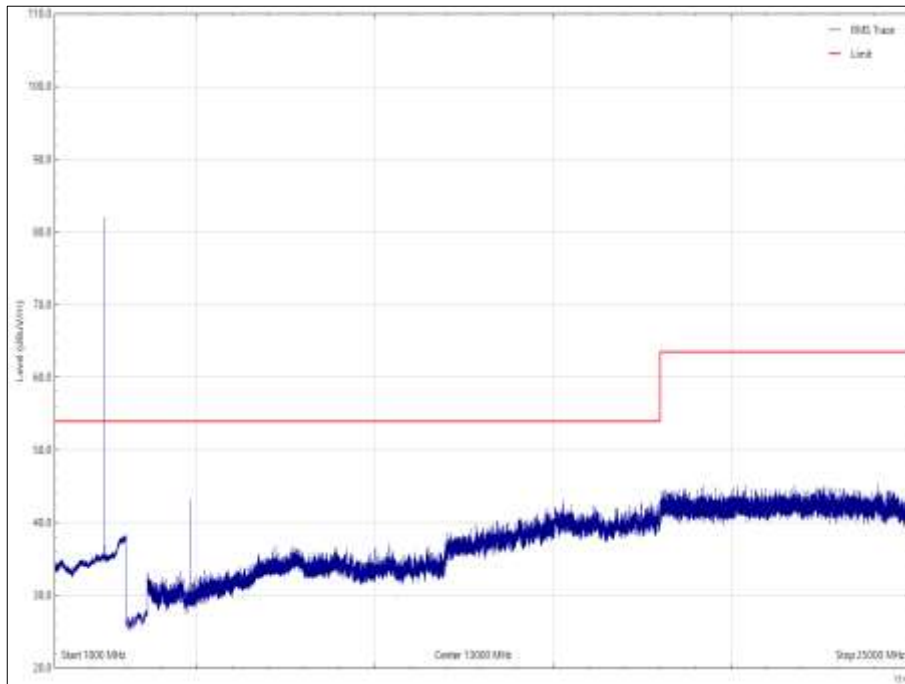

Figure 19 - 2402 MHz, 1 GHz to 25 GHz, Horizontal, Y Orientation, Average

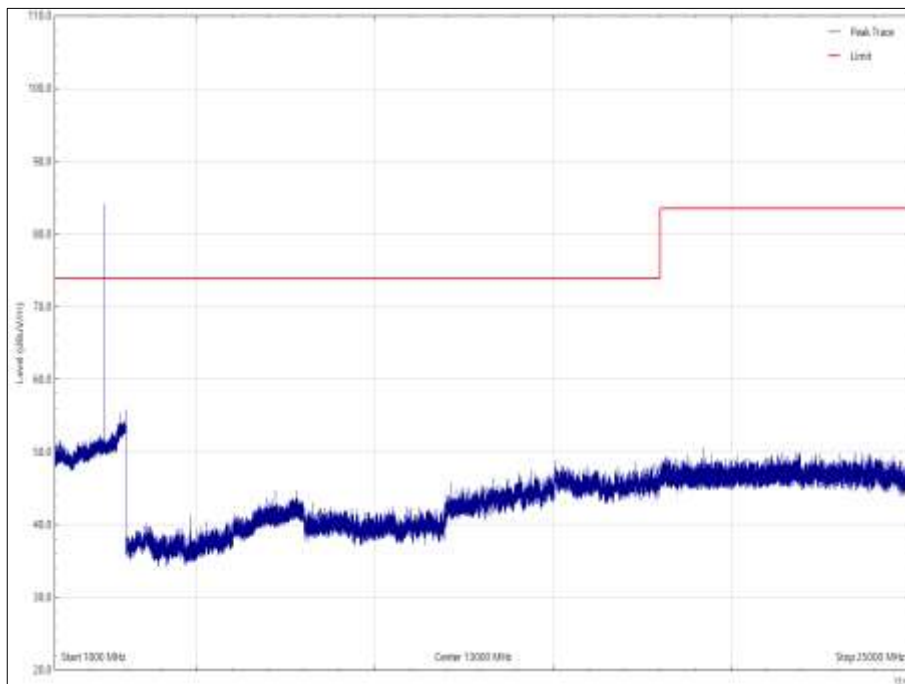

Figure 20 - 2402 MHz, 1 GHz to 25 GHz, Vertical, Z Orientation, Peak

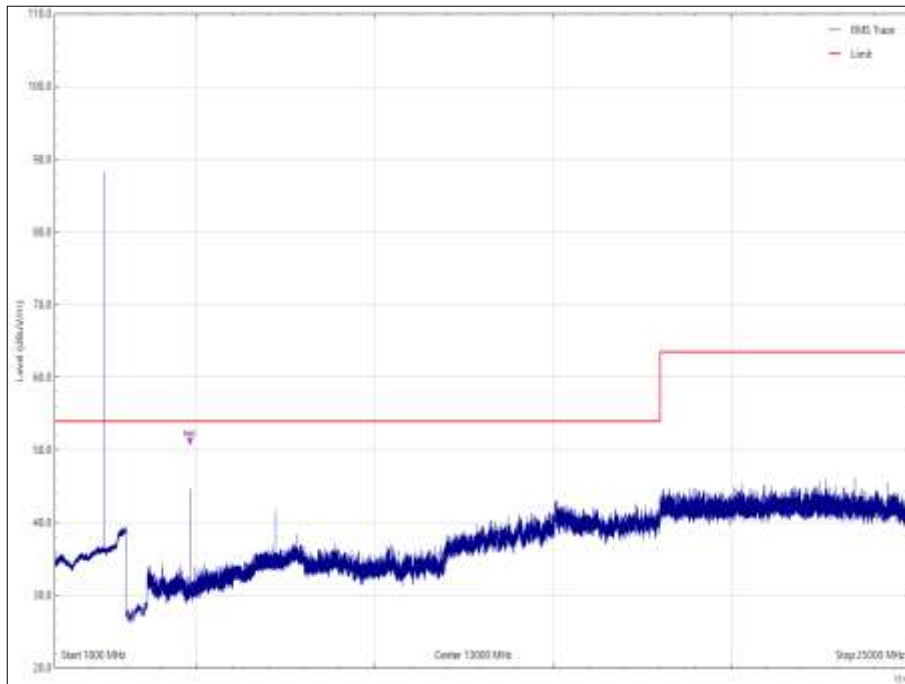

Figure 21 - 2402 MHz, 1 GHz to 25 GHz, Vertical, Z Orientation, Average

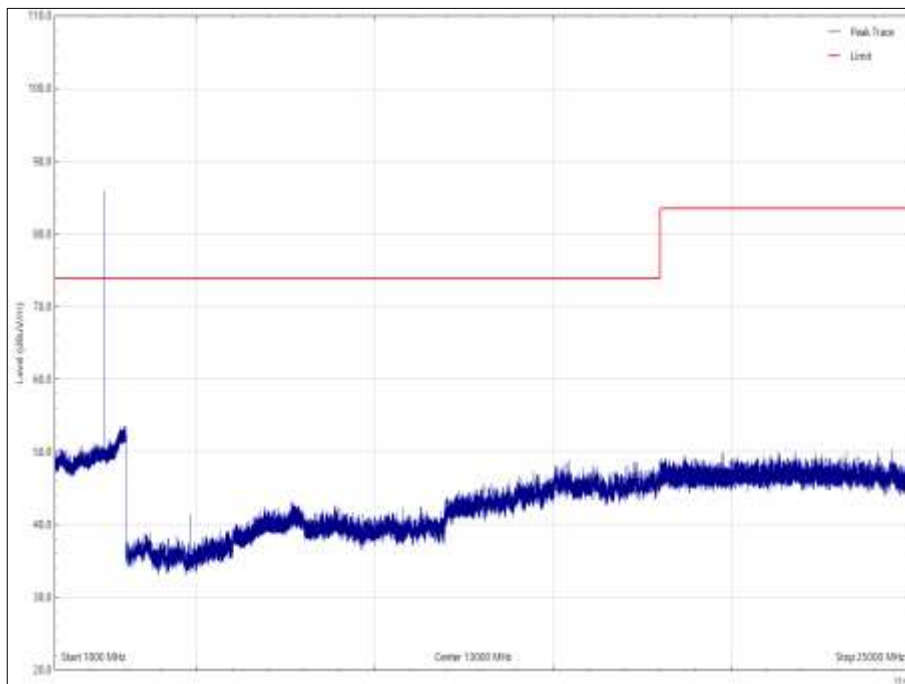

Figure 22 - 2402 MHz, 1 GHz to 25 GHz, Horizontal, Z Orientation, Peak

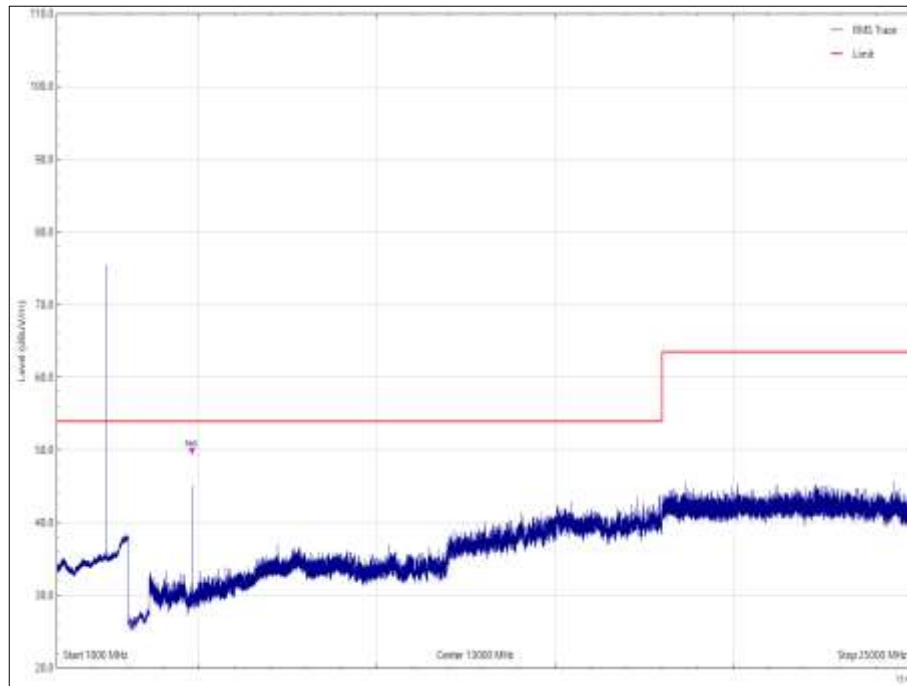

Figure 23 - 2402 MHz, 1 GHz to 25 GHz, Horizontal, Z Orientation, Average



Frequency (MHz)	Level (dBµV/m)	Limit (dBµV/m)	Margin (dB)	Detector	Angle (°)	Height (cm)	Polarisation	Orientation
*								

Table 23 - 2426 MHz, 30 MHz to 1 GHz

*No emissions were detected within 10 dB of the limit.

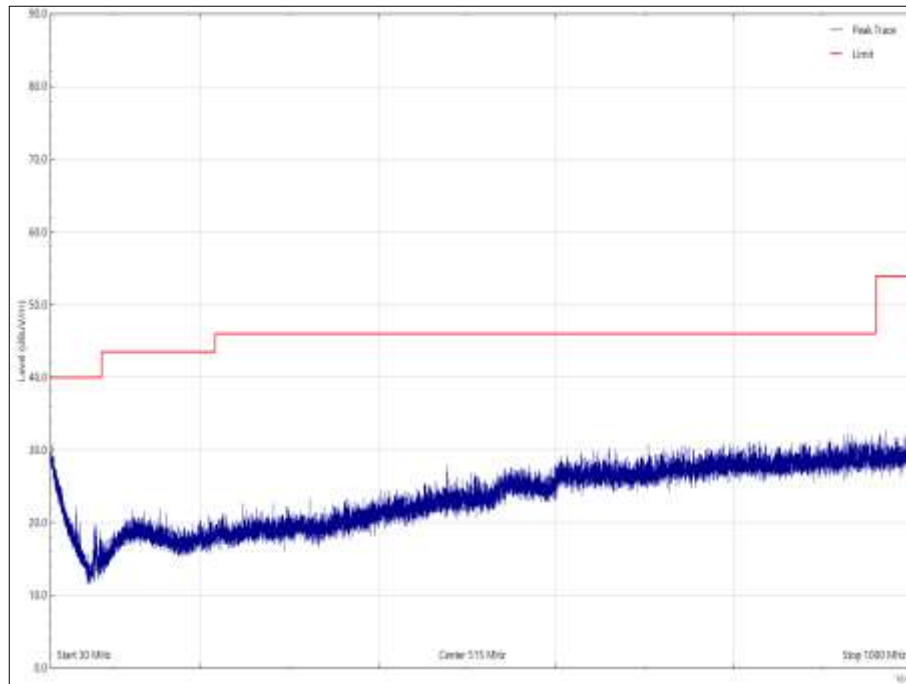

Figure 24 - 30 MHz to 1 GHz, 2426 MHz, Quasi-Peak, Vertical, Orientation X

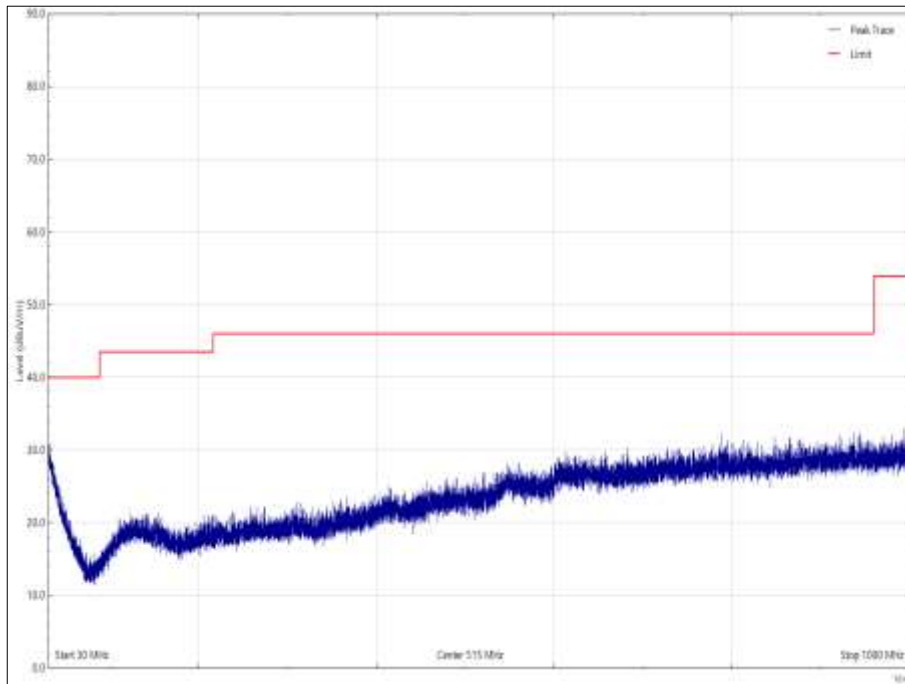

Figure 25 - 30 MHz to 1 GHz, 2426 MHz, Quasi-Peak, Horizontal, Orientation X

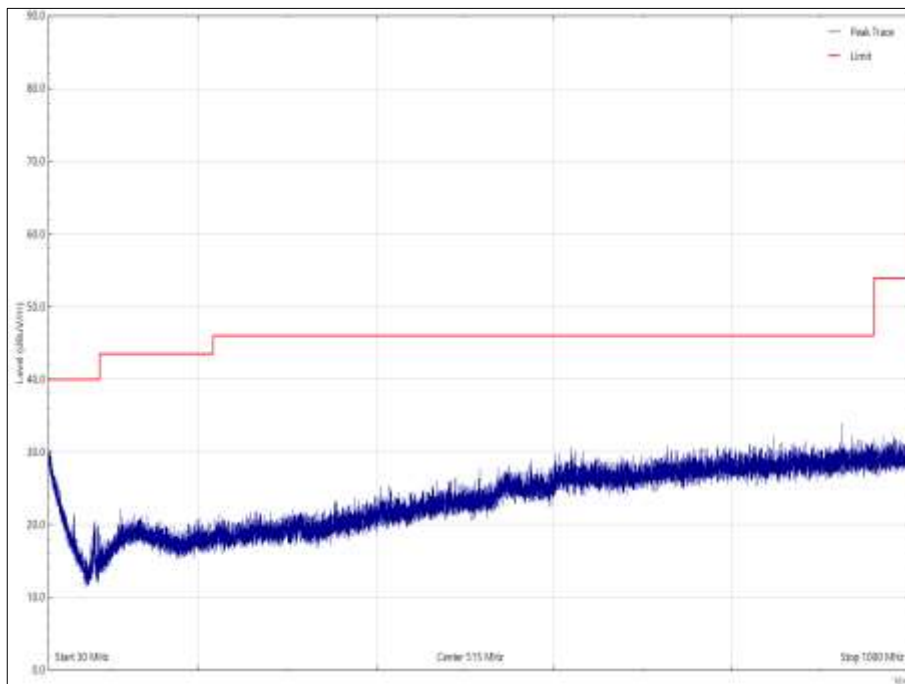

Figure 26 - 30 MHz to 1 GHz, 2426 MHz, Quasi-Peak, Vertical, Orientation Y

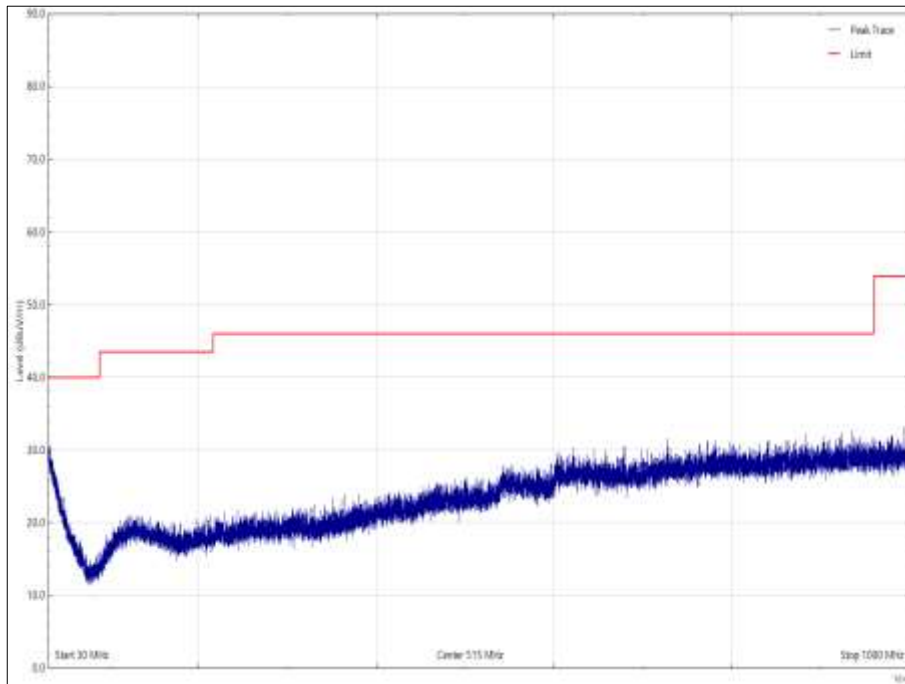

Figure 27 - 30 MHz to 1 GHz, 2426 MHz, Quasi-Peak, Horizontal, Orientation Y

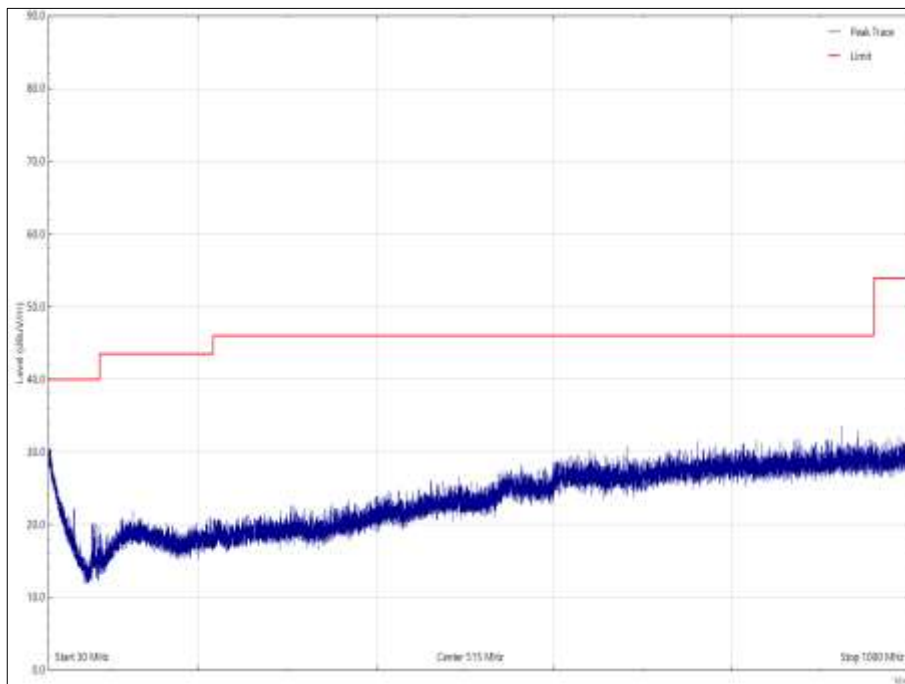

Figure 28 - 30 MHz to 1 GHz, 2426 MHz, Quasi-Peak, Vertical, Orientation Z

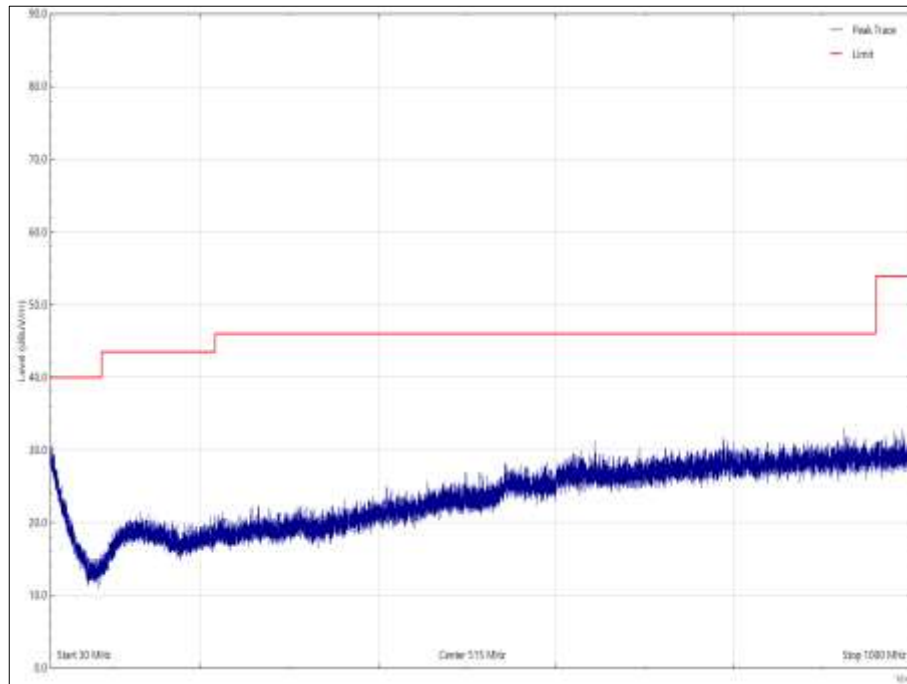

Figure 29 - 30 MHz to 1 GHz, 2426 MHz, Quasi-Peak, Horizontal, Orientation Z



Frequency (MHz)	Level (dBµV/m)	Limit (dBµV/m)	Margin (dB)	Detector	Angle (°)	Height (cm)	Polarisation	Orientation
7277.315	52.36	53.98	1.62	Average	194	180	Vertical	Y

Table 24 - 2426 MHz, 1 GHz to 25 GHz

No other emissions were detected within 10 dB of the limit.

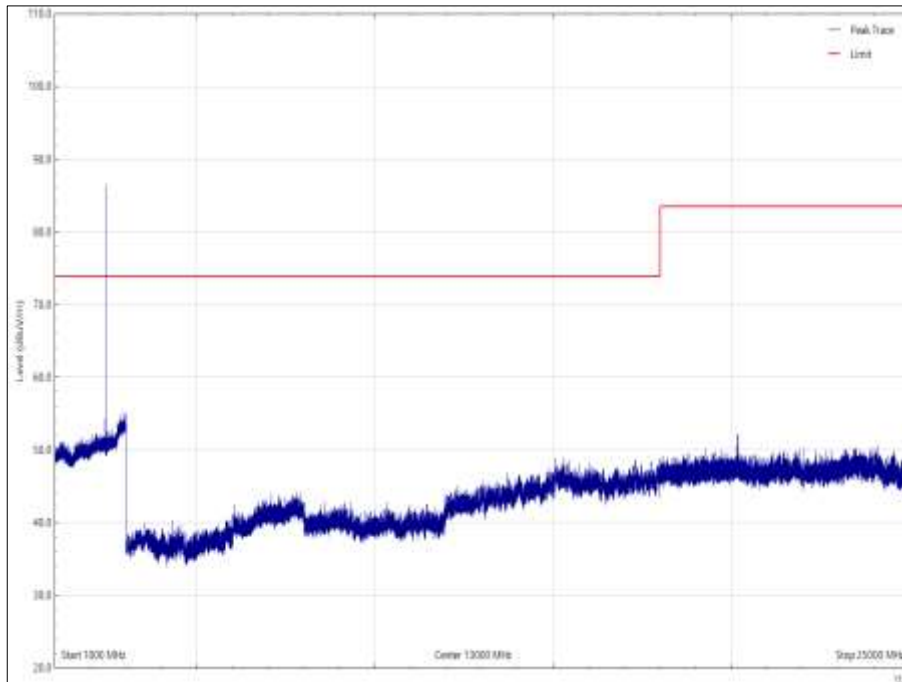

Figure 30 - 2426 MHz, 1 GHz to 25 GHz, Vertical, X Orientation, Peak

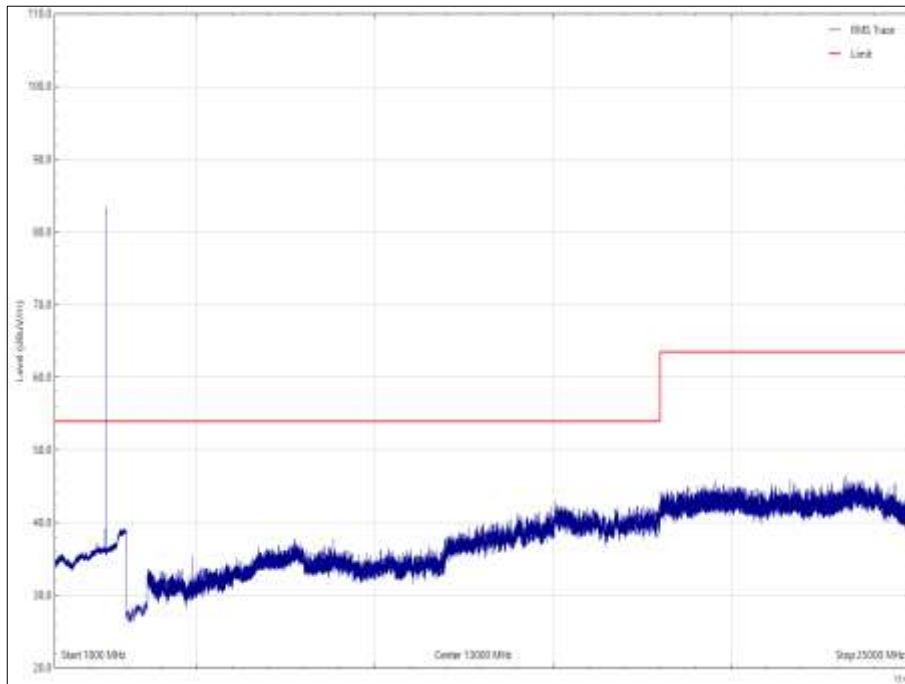

Figure 31 - 2426 MHz, 1 GHz to 25 GHz, Vertical, X Orientation, Average

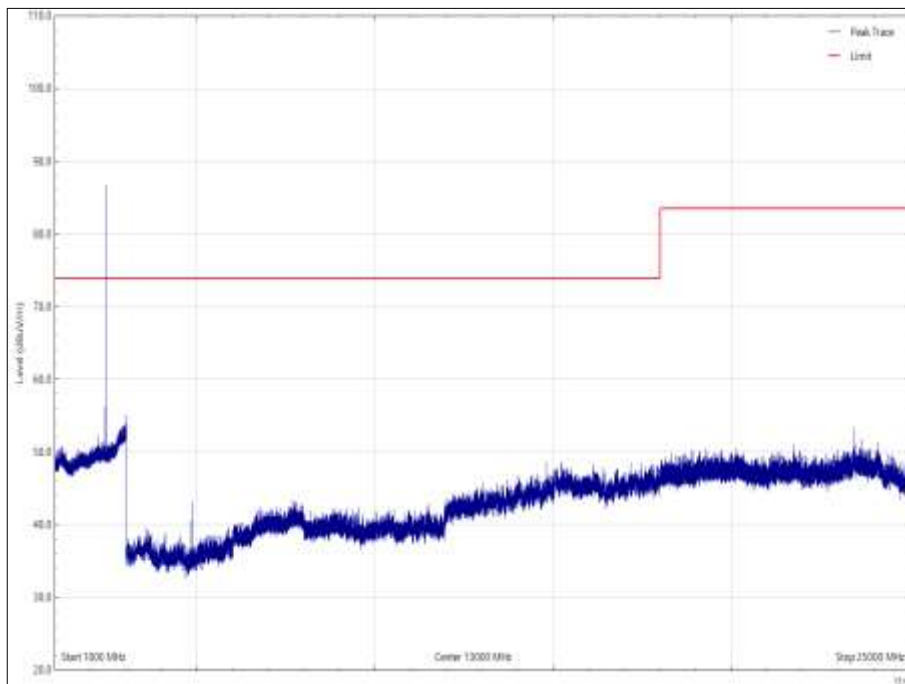

Figure 32 - 2426 MHz, 1 GHz to 25 GHz, Horizontal, X Orientation, Peak

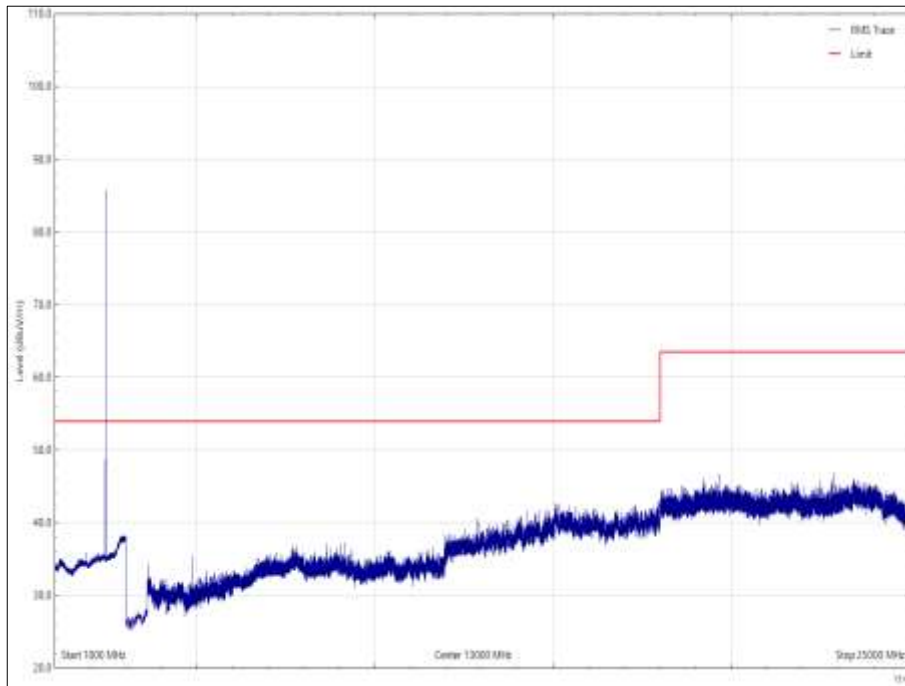

Figure 33 - 2426 MHz, 1 GHz to 25 GHz, Horizontal, X Orientation, Average

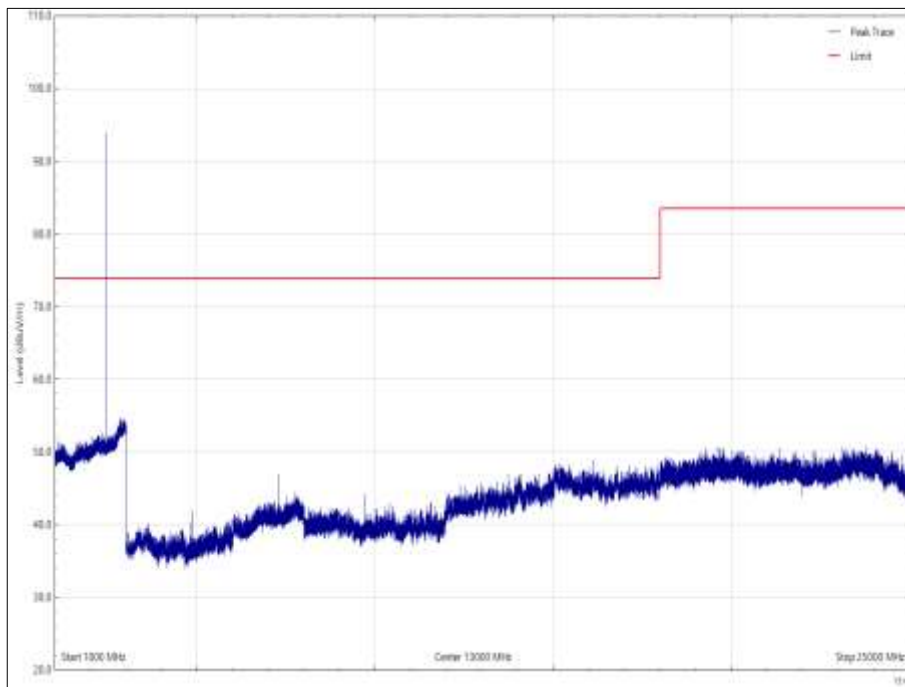

Figure 34 - 2426 MHz, 1 GHz to 25 GHz, Vertical, Y Orientation, Peak

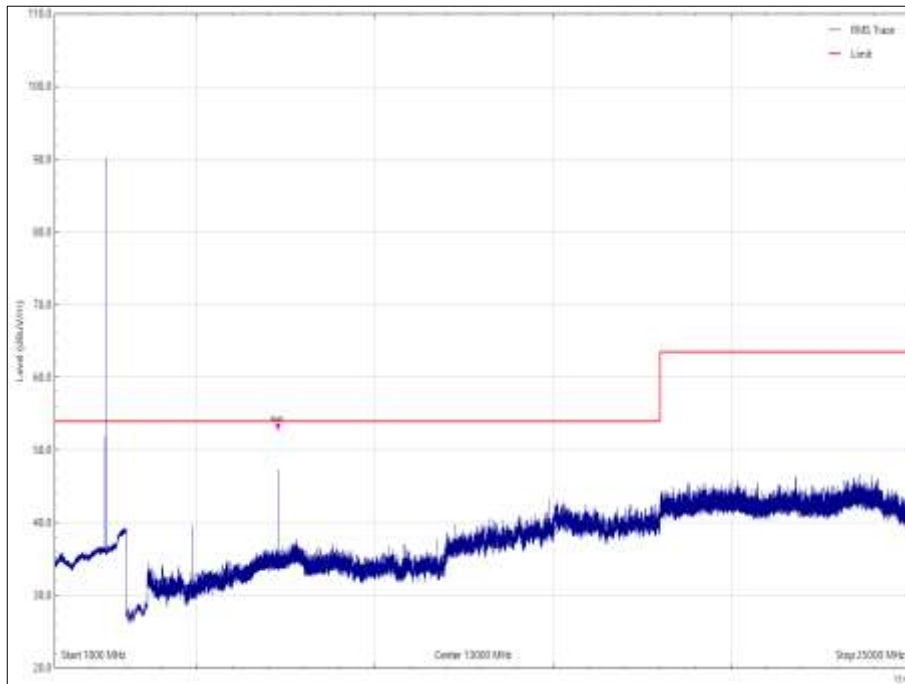

Figure 35 - 2426 MHz, 1 GHz to 25 GHz, Vertical, Y Orientation, Average

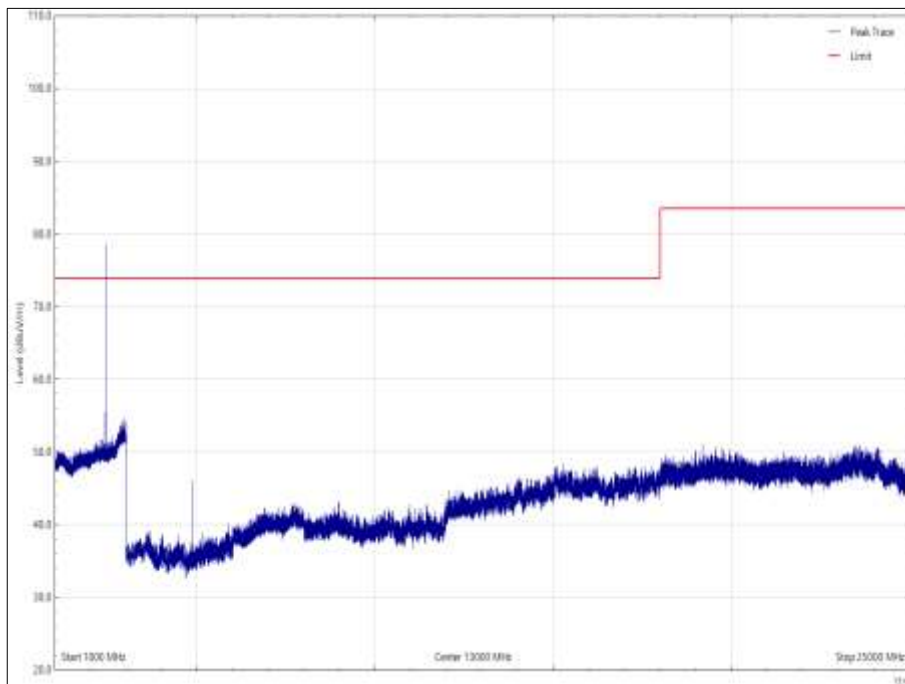

Figure 36 - 2426 MHz, 1 GHz to 25 GHz, Horizontal, Y Orientation, Peak

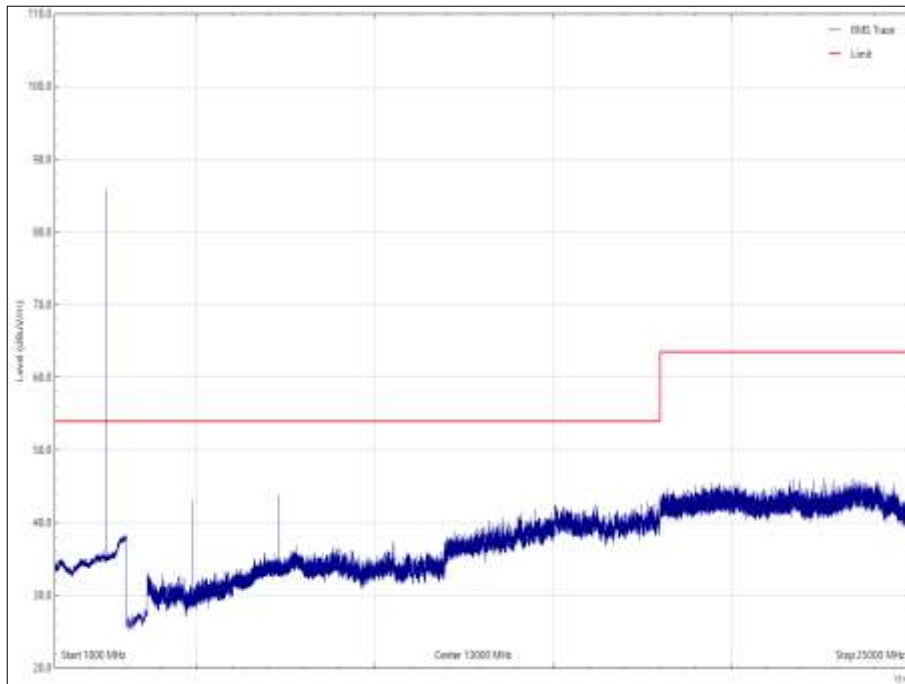

Figure 37 - 2426 MHz, 1 GHz to 25 GHz, Horizontal, Y Orientation, Average

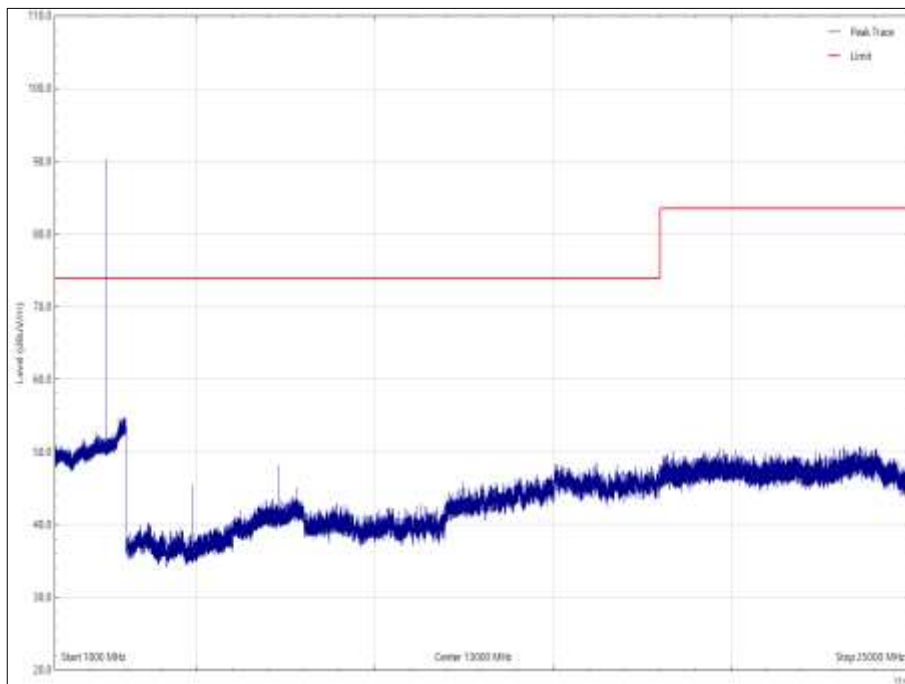

Figure 38 - 2426 MHz, 1 GHz to 25 GHz, Vertical, Z Orientation, Peak

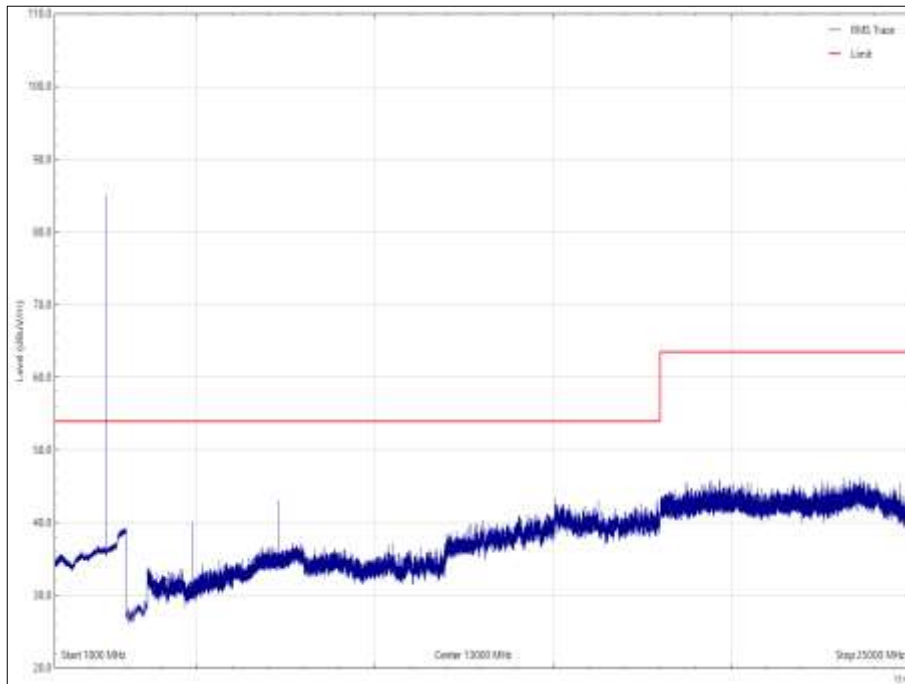

Figure 39 - 2426 MHz, 1 GHz to 25 GHz, Vertical, Z Orientation, Average

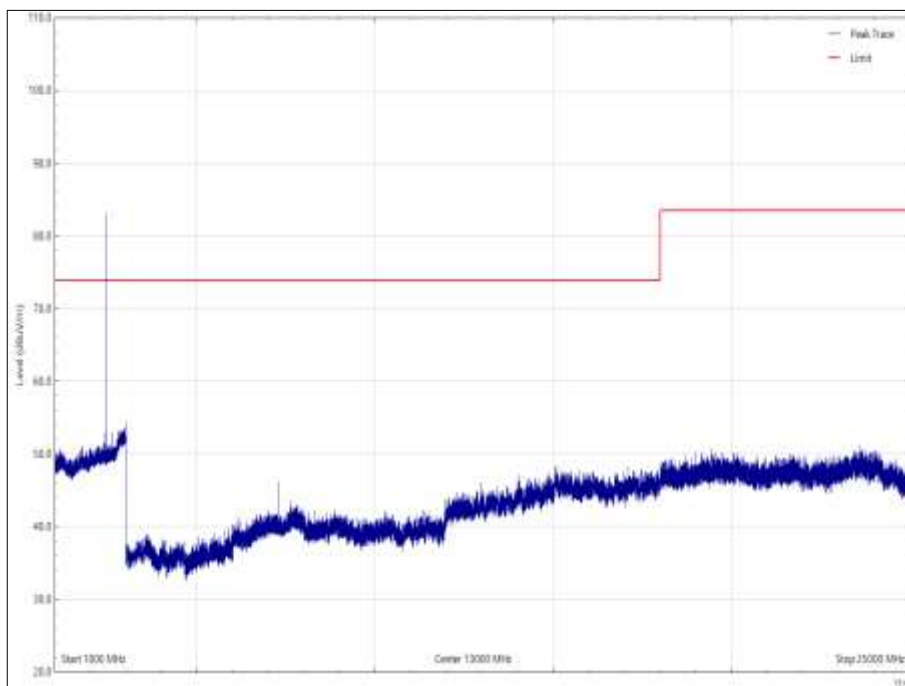

Figure 40 - 2426 MHz, 1 GHz to 25 GHz, Horizontal, Z Orientation, Peak

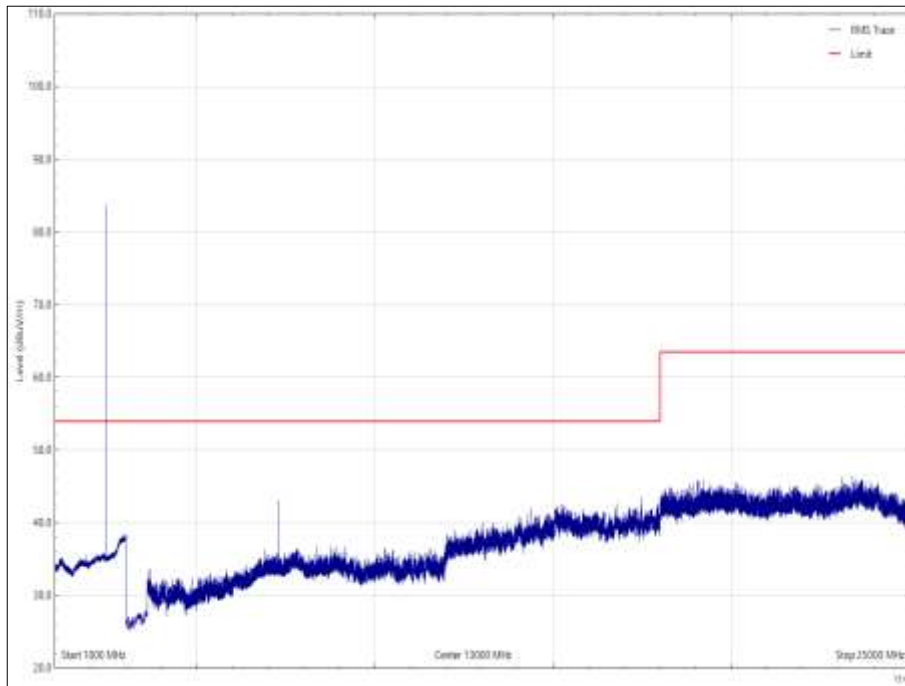

Figure 41 - 2426 MHz, 1 GHz to 25 GHz, Horizontal, Z Orientation, Average



Frequency (MHz)	Level (dBµV/m)	Limit (dBµV/m)	Margin (dB)	Detector	Angle (°)	Height (cm)	Polarisation	Orientation
*								

Table 25 - 2480 MHz, 30 MHz to 1 GHz

*No emissions were detected within 10 dB of the limit.

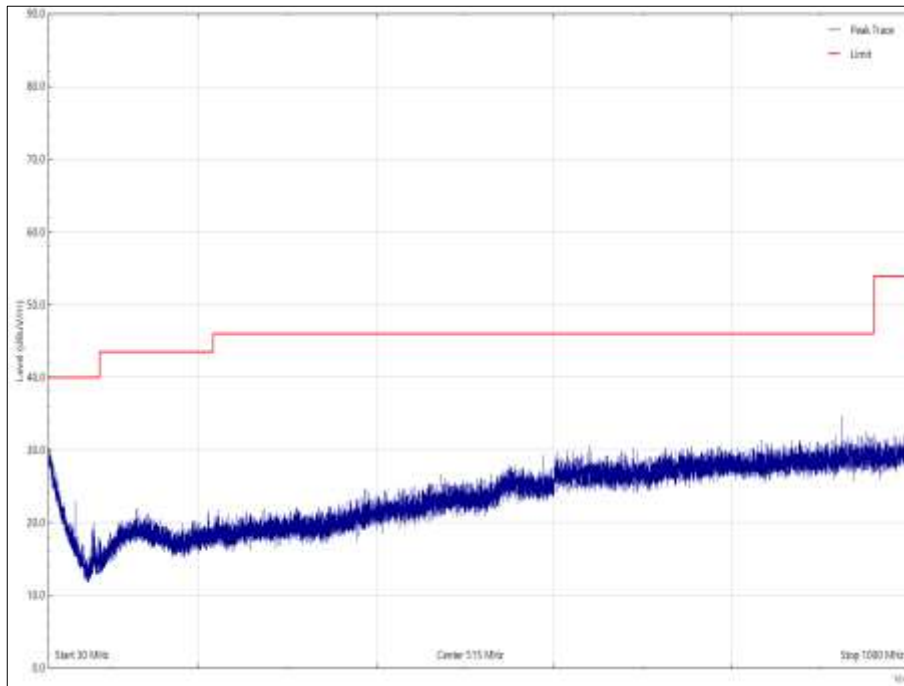

Figure 42 - 30 MHz to 1 GHz, 2480 MHz, Quasi-Peak, Vertical, Orientation X

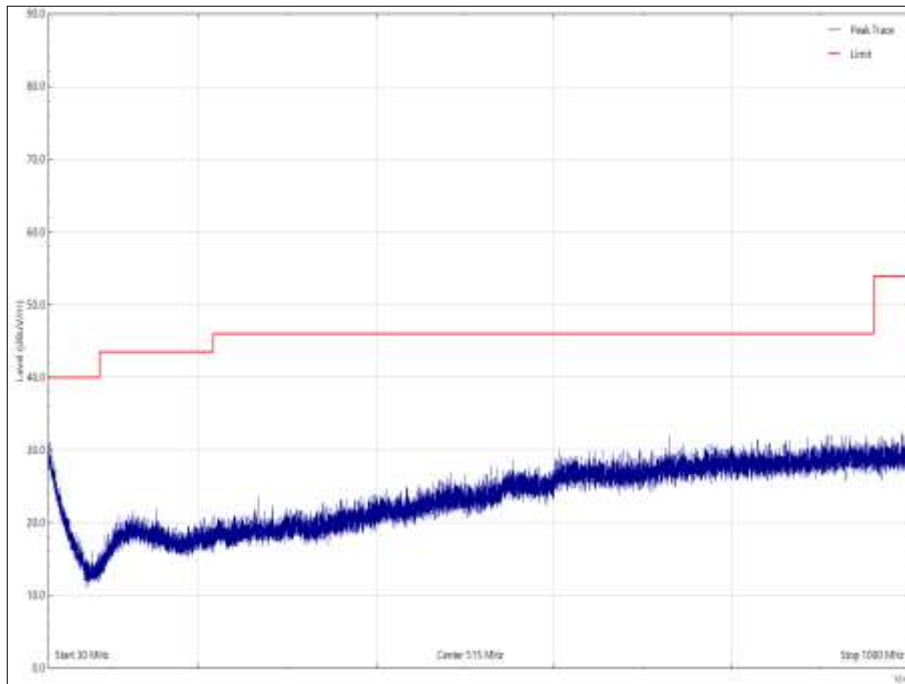

Figure 43 - 30 MHz to 1 GHz, 2480 MHz, Quasi-Peak, Horizontal, Orientation X

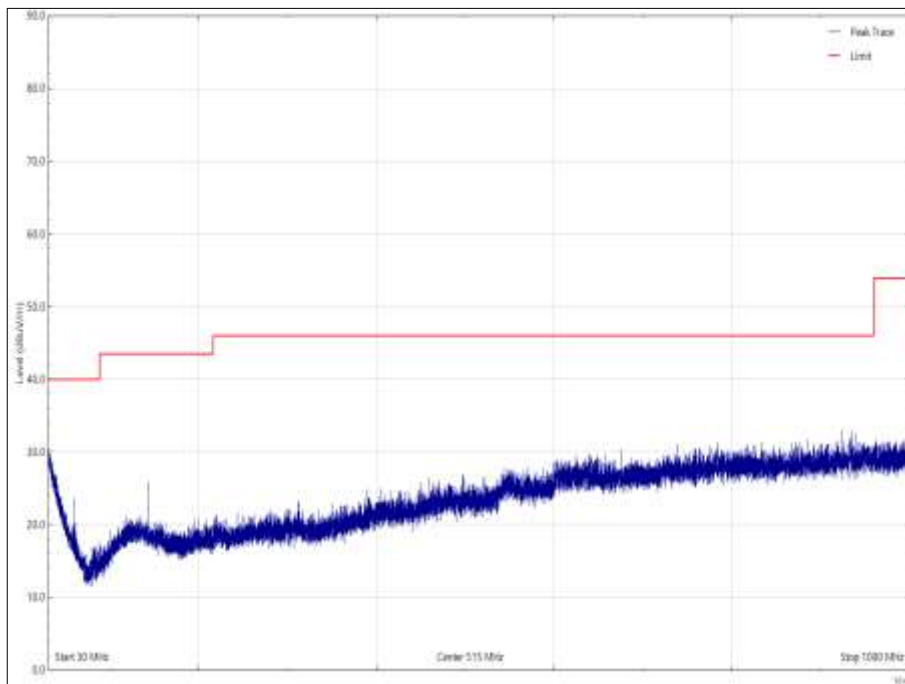

Figure 44 - 30 MHz to 1 GHz, 2480 MHz, Quasi-Peak, Vertical, Orientation Y

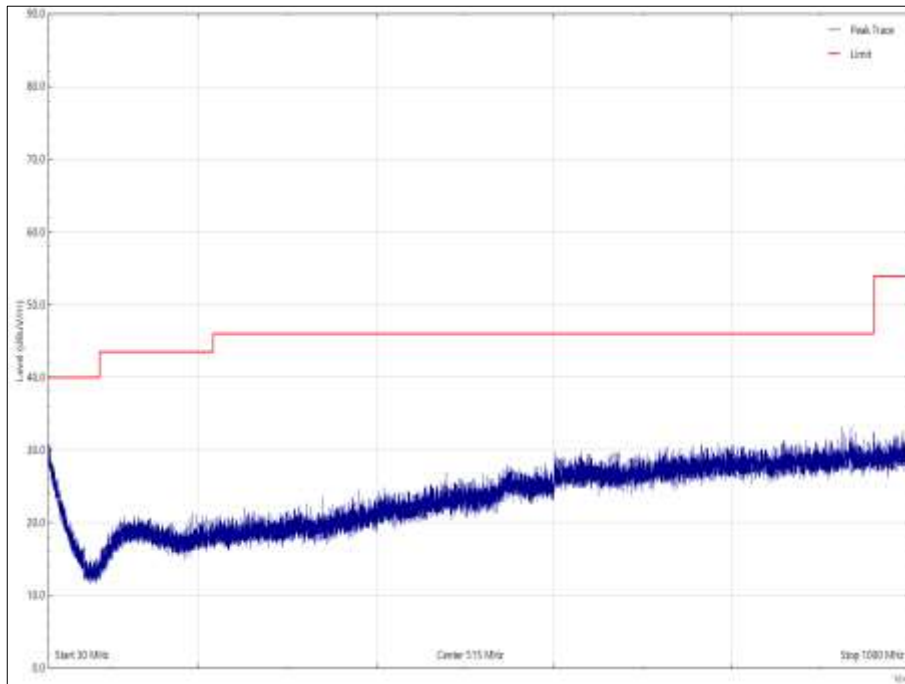

Figure 45 - 30 MHz to 1 GHz, 2480 MHz, Quasi-Peak, Horizontal, Orientation Y

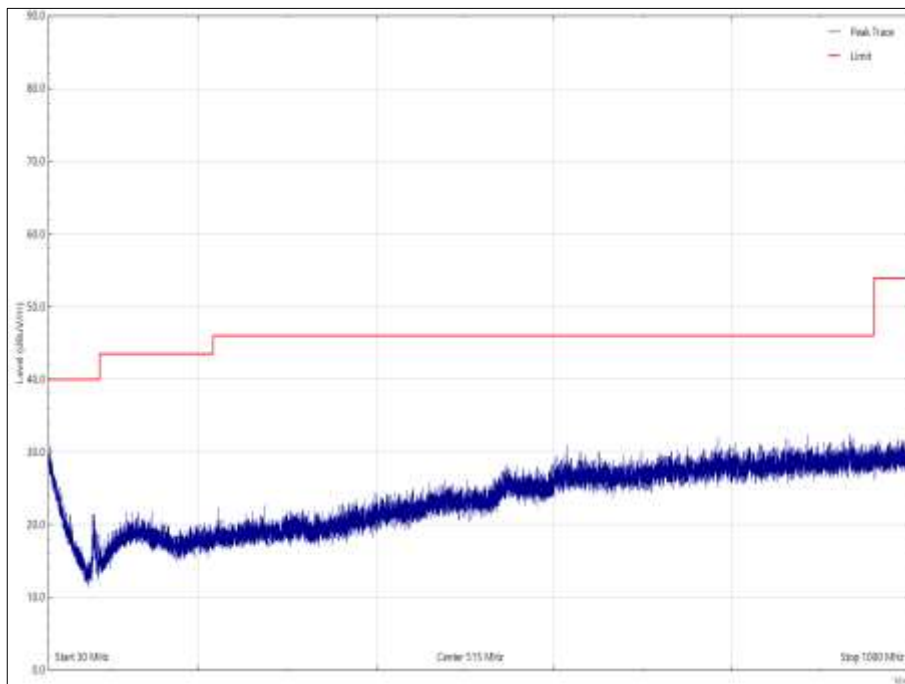

Figure 46 - 30 MHz to 1 GHz, 2480 MHz, Quasi-Peak, Vertical, Orientation Z

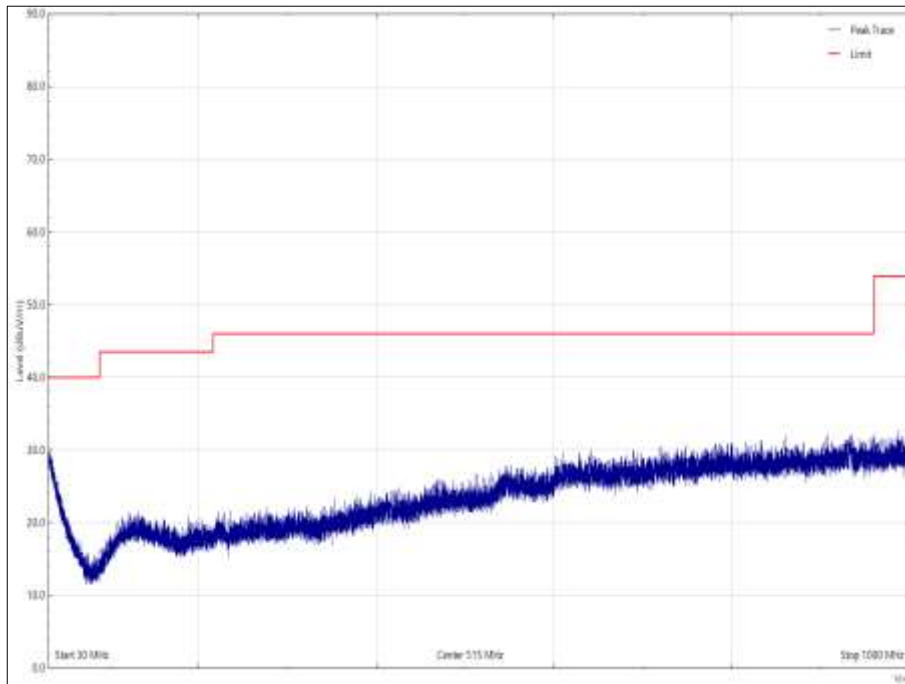

Figure 47 - 30 MHz to 1 GHz, 2480 MHz, Quasi-Peak, Horizontal, Orientation Z



Frequency (MHz)	Level (dBµV/m)	Limit (dBµV/m)	Margin (dB)	Detector	Angle (°)	Height (cm)	Polarisation	Orientation
*							*	

Table 26 - 2480 MHz, 1 GHz to 25 GHz

*No emissions were detected within 10 dB of the limit.

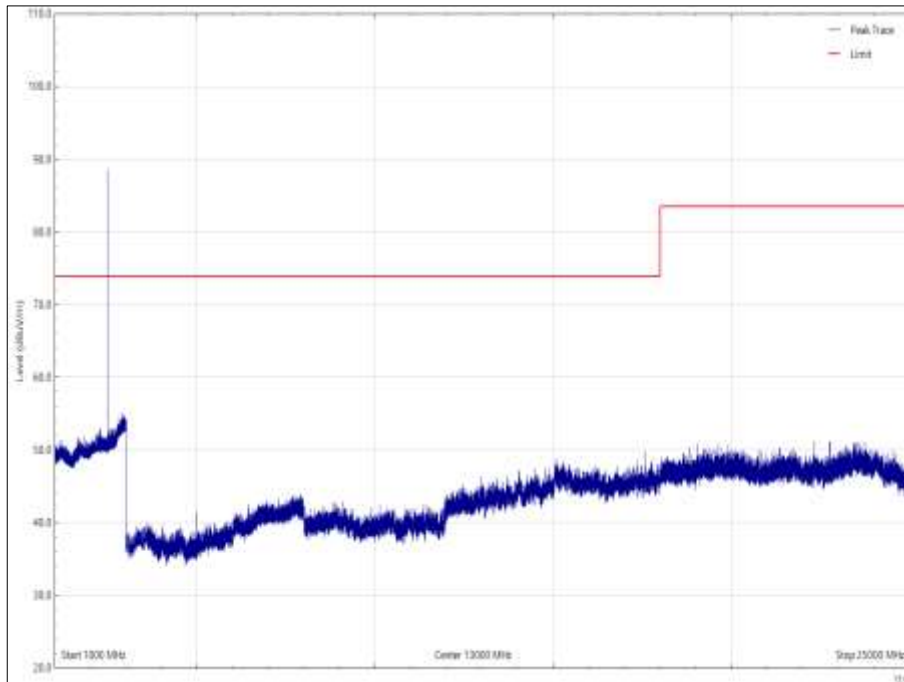

Figure 48 - 2480 MHz, 1 GHz to 25 GHz, Vertical, X Orientation, Peak

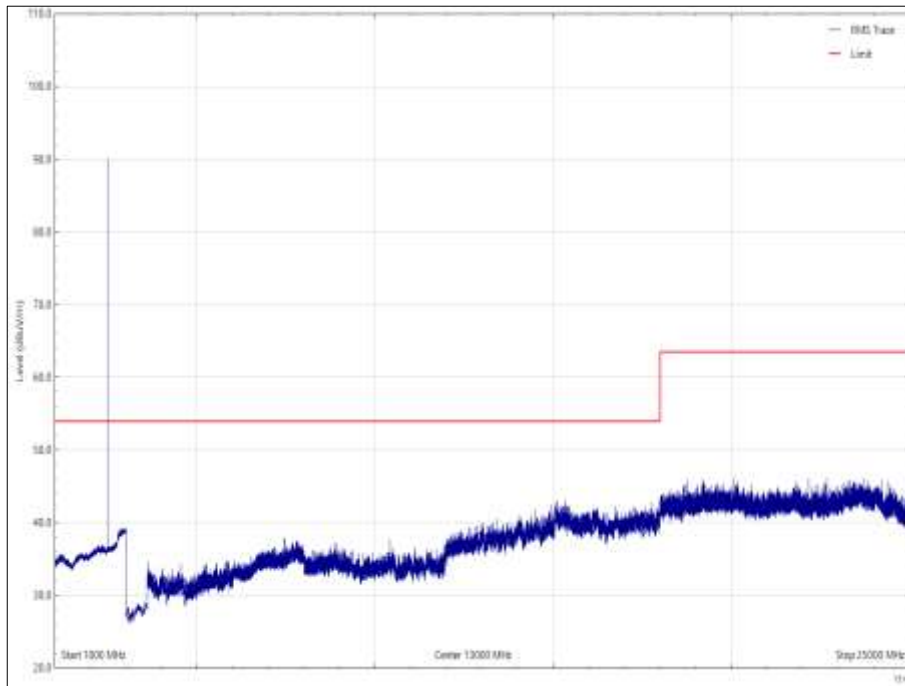

Figure 49 - 2480 MHz, 1 GHz to 25 GHz, Vertical, X Orientation, Average

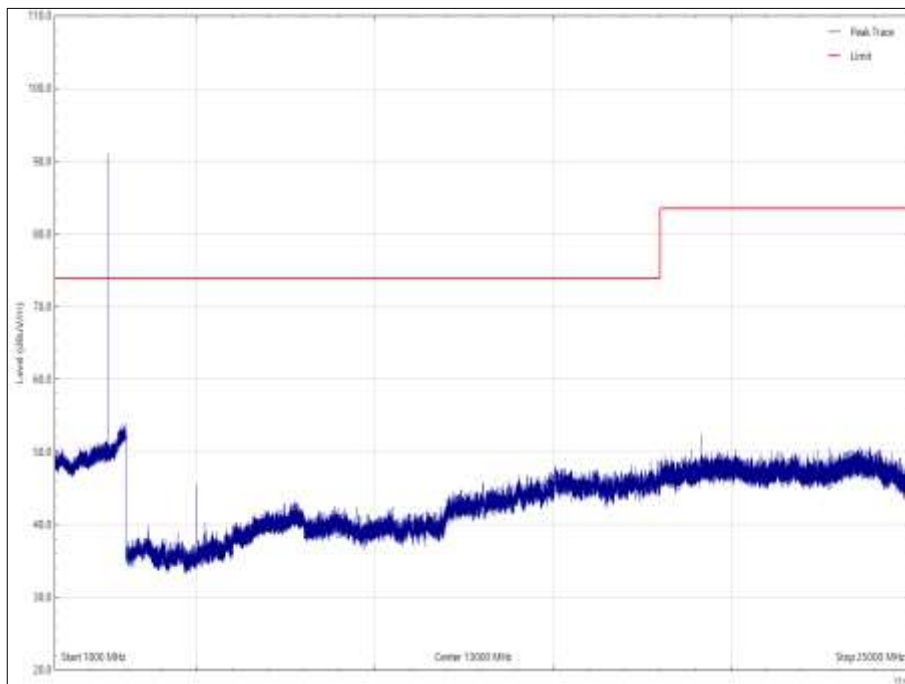

Figure 50 - 2480 MHz, 1 GHz to 25 GHz, Horizontal, X Orientation, Peak

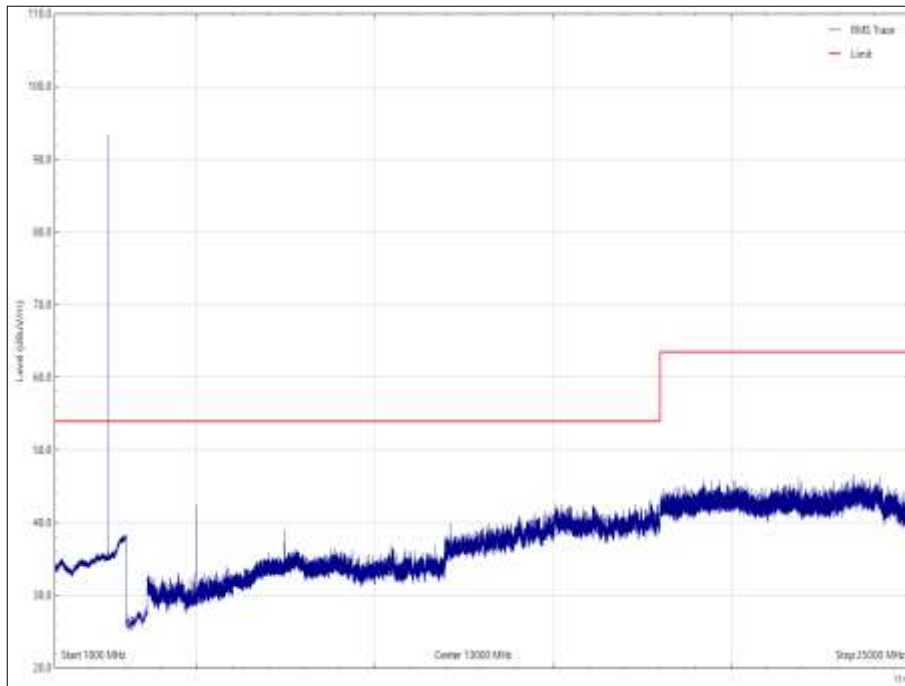

Figure 51 - 2480 MHz, 1 GHz to 25 GHz, Horizontal, X Orientation, Average

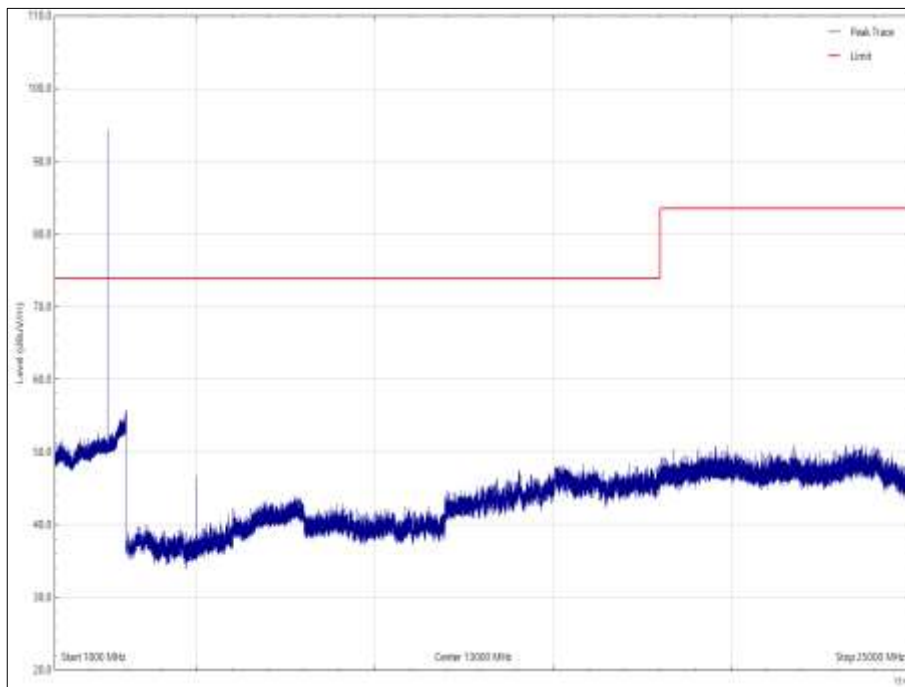

Figure 52 - 2480 MHz, 1 GHz to 25 GHz, Vertical, Y Orientation, Peak

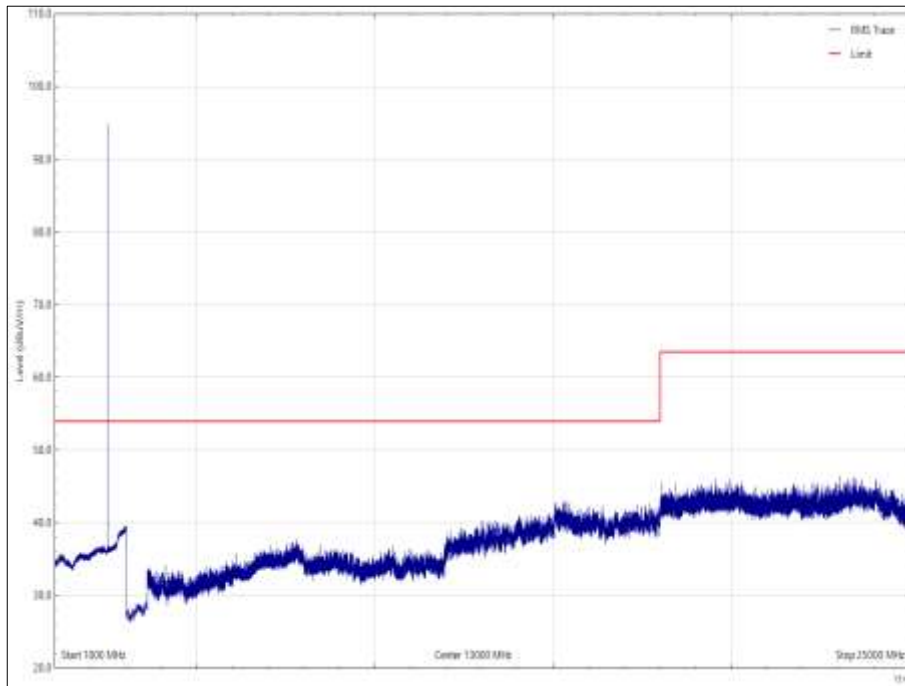

Figure 53 - 2480 MHz, 1 GHz to 25 GHz, Vertical, Y Orientation, Average

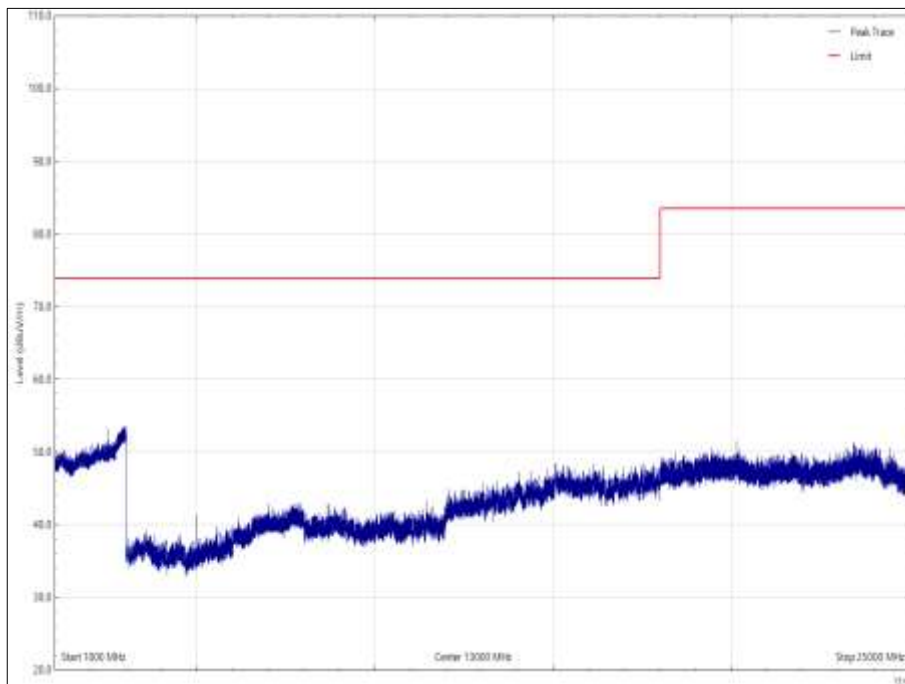

Figure 54 - 2480 MHz, 1 GHz to 25 GHz, Horizontal, Y Orientation, Peak

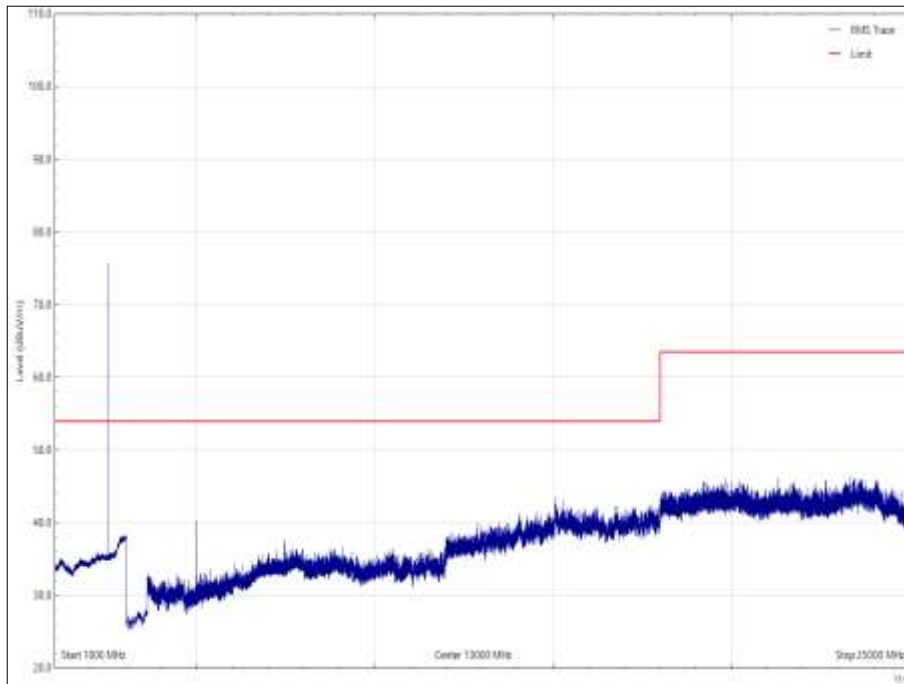

Figure 55 - 2480 MHz, 1 GHz to 25 GHz, Horizontal, Y Orientation, Average

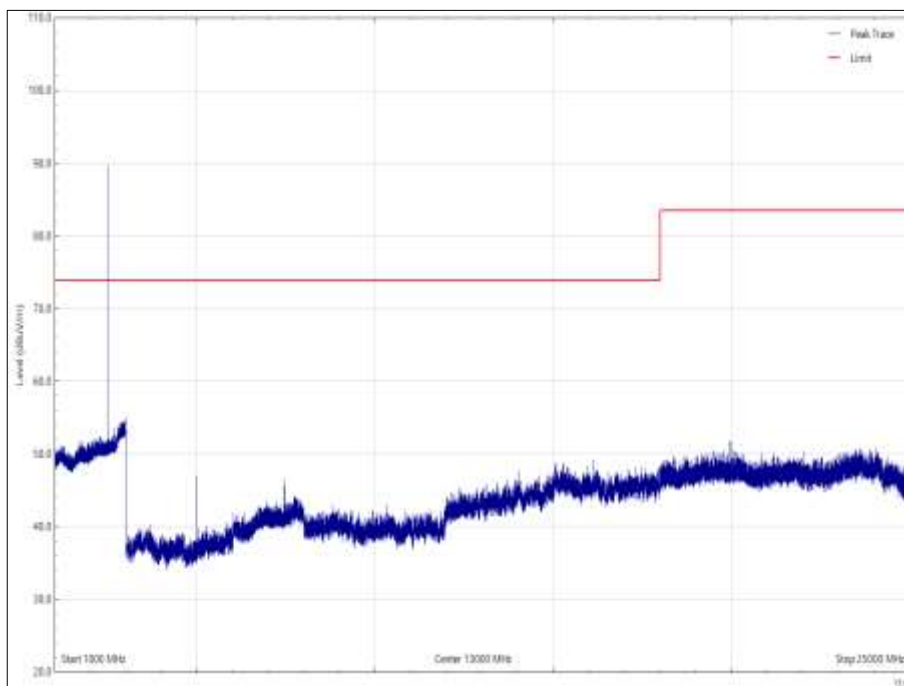

Figure 56 - 2480 MHz, 1 GHz to 25 GHz, Vertical, Z Orientation, Peak

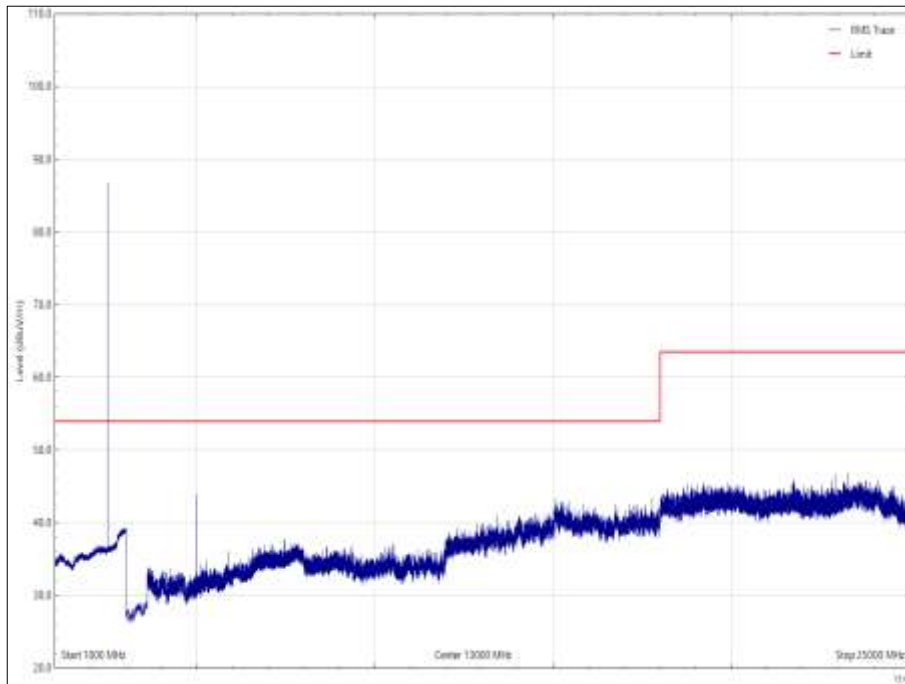

Figure 57 - 2480 MHz, 1 GHz to 25 GHz, Vertical, Z Orientation, Average

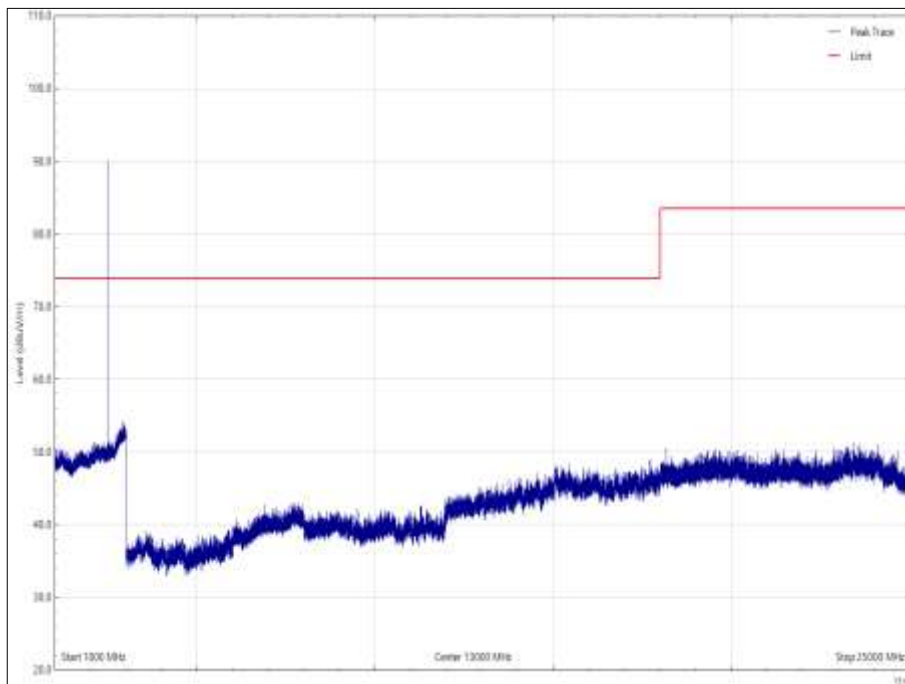

Figure 58 - 2480 MHz, 1 GHz to 25 GHz, Horizontal, Z Orientation, Peak

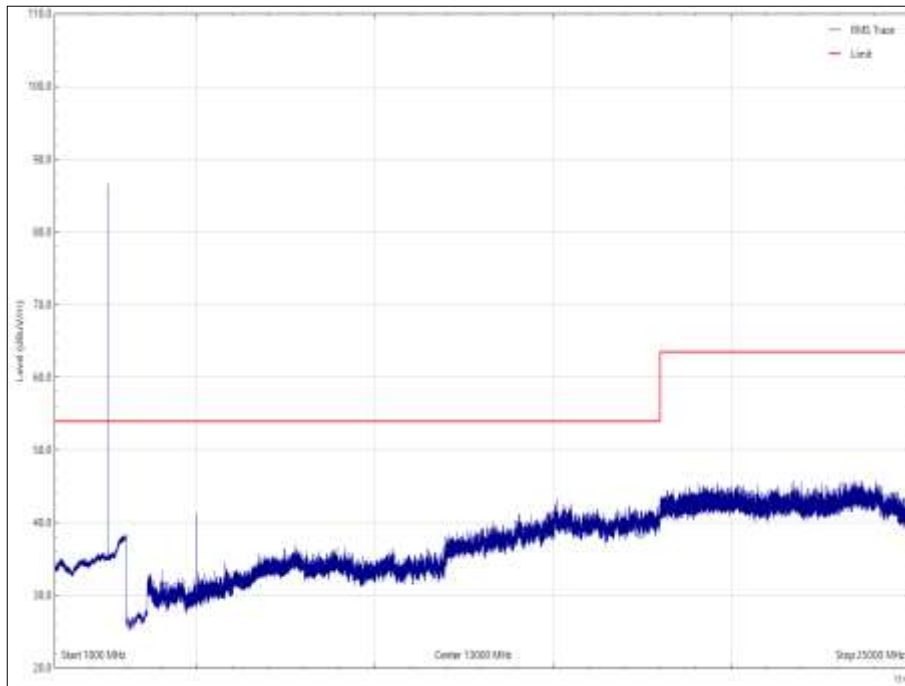

Figure 59 - 2480 MHz, 1 GHz to 25 GHz, Horizontal, Z Orientation, Average



Figure 60 - Test Setup - 30 MHz to 1 GHz - X Orientation



Figure 61 - Test Setup - 30 MHz to 1 GHz - Y Orientation



Figure 62 - Test Setup - 30 MHz to 1 GHz - Z Orientation



Figure 63 - Test Setup - 1 GHz to 18 GHz - X Orientation

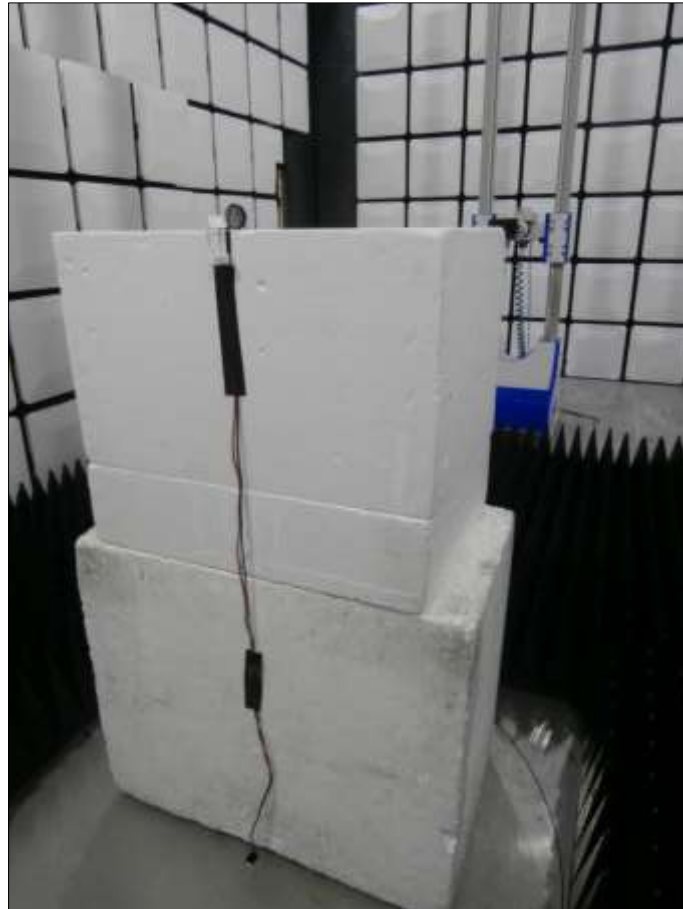

Figure 64 - Test Setup - 1 GHz to 18 GHz - Y Orientation



Figure 65 - Test Setup - 1 GHz to 18 GHz - Z Orientation



Figure 66 - Test Setup - 18 GHz to 25 GHz - X Orientation



Figure 67 - Test Setup - 18 GHz to 25 GHz - Y Orientation



Figure 68 - Test Setup - 18 GHz to 25 GHz - Z Orientation

FCC 47 CFR Part 15, Limit Clause 15.247 (d)

In any 100 kHz bandwidth outside the frequency band in which the spread spectrum or digitally modulated intentional radiator is operating, the radio frequency power that is produced by the intentional radiator shall be at least 20 dB below that in the 100 kHz bandwidth within the band that contains the highest level of the desired power, based on either an RF conducted or a radiated measurement, provided the transmitter demonstrates compliance with the peak conducted power limits. If the transmitter complies with the conducted power limits based on the use of RMS averaging over a time interval, as permitted under paragraph (b)(3) of this section, the attenuation required under this paragraph shall be 30 dB instead of 20 dB.

Attenuation below the general limits specified in § 15.209(a) is not required. In addition, radiated emissions which fall in the restricted bands, as defined in § 15.205(a), must also comply with the radiated emission limits specified in 15.209(a).



2.3.4 Test Location and Test Equipment Used

This test was carried out in EMC Chamber 12.

Instrument	Manufacturer	Type No	TE No	Calibration Period (months)	Calibration Due
Power Supply Unit	Hewlett Packard	6269B	113	-	O/P Mon
Antenna 18-40GHz (Double Ridge Guide)	Link Microtek Ltd	AM180HA-K-TU2	230	24	27-Jul-2022
Antenna with permanent attenuator (Bilog)	Schaffner	CBL6143	287	24	14-Oct-2022
Pre-Amplifier, (8 GHz to 18 GHz)	Phase One	PS04-0086	1533	12	05-Feb-2022
18GHz - 40GHz Pre-Amplifier	Phase One	PSO4-0087	1534	12	02-Aug-2022
Comb Generator	Schaffner	RSG1000	3034	-	TU
EMI Test Receiver	Rohde & Schwarz	ESU40	3506	12	18-Mar-2022
Cable 1503 2M 2.92(P)m 2.92(P)m	Rhophase	KPS-1503A-2000-KPS	4293	12	16-Nov-2021
Cable (Yellow, Rx, Km-Km 2m)	Scott Cables	KPS-1501-2000-KPS	4527	6	24-Sep-2021
Cable (18 GHz)	Rosenberger	LU7-036-1000	5031	12	23-Jul-2022
EmX Emissions Software	TUV SUD	V2.1.11 V.V2.1.11	5125	-	Software
Preamplifier (30dB 1GHz to 18GHz)	Schwarzbeck	BBV 9718 C	5350	12	21-Sep-2021
8 Meter Cable	Teledyne	PR90-088-8MTR	5450	6	08-Mar-2022
Thermo-Hygro-Barometer	PCE Instruments	PCE-THB-40	5481	12	31-Mar-2022
1m K-Type Cable	Junkosha	MWX241-01000KMSKMS/A	5511	12	09-Apr-2022
DVM - Digital Multimeter	Iso-tech	IDM101	5601	12	04-Aug-2022
DRG Horn Antenna (7.5-18GHz)	Schwarzbeck	HWRD750	5610	12	22-Sep-2021
Broadband Horn Antenna (1-10 GHz)	Schwarzbeck	BBHA 9120 B	5611	12	22-Sep-2021
Turntable & Mast Controller	Maturo Gmbh	NCD/498/2799.01	5612	-	TU
Tilt Antenna Mast TAM 4.0-P	Maturo Gmbh	TAM 4.0-P	5613	-	TU
Turntable	Maturo Gmbh	Turntable 1.5 SI-2t	5614	-	TU
3m Semi Anechoic Chamber	MVG	EMC-3	5621	36	11-Aug-2023

TU – Traceability Unscheduled
 O/P Mon – Output Monitored using calibrated equipment



3 Measurement Uncertainty

For a 95% confidence level, the measurement uncertainties for defined systems are:

Test Name	Measurement Uncertainty
Authorised Band Edges	30 MHz to 1 GHz: ± 5.2 dB 1 GHz to 40 GHz: ± 6.3 dB
Restricted Band Edges	30 MHz to 1 GHz: ± 5.2 dB 1 GHz to 40 GHz: ± 6.3 dB
Spurious Radiated Emissions	30 MHz to 1 GHz: ± 5.2 dB 1 GHz to 40 GHz: ± 6.3 dB

Table 27

Measurement Uncertainty Decision Rule

Determination of conformity with the specification limits is based on the decision rule according to IEC Guide 115: 2007, clause 4.4.3 and 4.5.1.