



Shenzhen CTL Testing Technology Co., Ltd.
Tel: +86-755-89486194 E-mail: ctl@ctl-lab.com

TEST REPORT

FCC PART 15.247

Report Reference No. : CTL2012221011-WF

Compiled by:
(position+printed name+signature)

Happy Guo
(File administrators)

Happy Guo

Tested by:
(position+printed name+signature)

Gary Gao
(Test Engineer)

Gary Gao

Approved by:
(position+printed name+signature)

Ivan Xie
(Manager)

Ivan Xie

Product Name : PALM 2 Gimbal Camera

Model/Type reference : YTXJ06FM

List Model(s)..... : N/A

Trade Mark..... : 

FCC ID..... : 2AYVYYTXJ06FM

Applicant's name : **Shenzhen FIMI Robot Technology Co., Ltd**
2nd Floor, East Block, Tianliao Building, 1133 Xueyuan Avenue,
Address of applicant : Taoyuan Street, Nanshan District, Shenzhen City, Guangdong
Province, China

Test Firm..... : **Shenzhen CTL Testing Technology Co., Ltd.**
Address of Test Firm : Floor 1-A, Baisha Technology Park, No.3011, Shahexi Road,
Nanshan District, Shenzhen, China 518055

Test specification..... :
Standard : **47 CFR FCC Part 15 Subpart C 15.247**
TRF Originator : Shenzhen CTL Testing Technology Co., Ltd.
Master TRF..... : Dated 2011-01

Date of receipt of test item : Dec. 23, 2020
Date of sampling : Dec. 23, 2020
Date of Test Date..... : Dec. 23, 2020–Jan. 25, 2021
Date of Issue : Jan. 26, 2021

Result..... : **Pass**

Shenzhen CTL Testing Technology Co., Ltd. All rights reserved.

This publication may be reproduced in whole or in part for non-commercial purposes as long as the Shenzhen CTL Testing Technology Co., Ltd. is acknowledged as copyright owner and source of the material. Shenzhen CTL Testing Technology Co., Ltd. takes no responsibility for and will not assume liability for damages resulting from the reader's interpretation of the reproduced material due to its placement and context.

TEST REPORT

| | | |
|--------------------------|-------------------------|---|
| Test Report No. : | CTL2012221011-WF | Jan. 26, 2021 ----- Date of issue |
|--------------------------|-------------------------|---|

Equipment under Test : PALM 2 Gimbal Camera

Sample No. CTL201222101-1-S001

Model /Type : YTXJ06FM

Listed Models : N/A

Applicant : Shenzhen FIMI Robot Technology Co., Ltd

Address : 2nd Floor, East Block, Tianliao Building, 1133 Xueyuan Avenue, Taoyuan Street, Nanshan District, Shenzhen City, Guangdong Province, China

Manufacturer : Shenzhen FIMI Robot Technology Co., Ltd

Address : 2nd Floor, East Block, Tianliao Building, 1133 Xueyuan Avenue, Taoyuan Street, Nanshan District, Shenzhen City, Guangdong Province, China

| | |
|--------------------|---------------|
| Test result | Pass * |
|--------------------|---------------|

* In the configuration tested, the EUT complied with the standards specified page 5.

The test results presented in this report relate only to the object tested.

This report shall not be reproduced, except in full, without the written approval of the issuing testing laboratory.

Table of Contents

Page

| | |
|---|-----------|
| 1. SUMMARY | 5 |
| 1.1. TEST STANDARDS | 5 |
| 1.2. TEST DESCRIPTION | 5 |
| 1.3. TEST FACILITY | 6 |
| 1.4. STATEMENT OF THE MEASUREMENT UNCERTAINTY | 6 |
| 2. GENERAL INFORMATION | 8 |
| 2.1. ENVIRONMENTAL CONDITIONS | 8 |
| 2.2. GENERAL DESCRIPTION OF EUT | 8 |
| 2.3. DESCRIPTION OF TEST MODES AND TEST FREQUENCY | 8 |
| 2.4. EQUIPMENTS USED DURING THE TEST | 9 |
| 2.5. RELATED SUBMITTAL(S) / GRANT (S) | 10 |
| 2.6. MODIFICATIONS | 10 |
| 3. TEST CONDITIONS AND RESULTS | 11 |
| 3.1. CONDUCTED EMISSIONS TEST | 11 |
| 3.2. RADIATED EMISSIONS AND BAND EDGE | 14 |
| 3.3. MAXIMUM CONDUCTED OUTPUT POWER | 21 |
| 3.4. POWER SPECTRAL DENSITY | 22 |
| 3.5. 6DB BANDWIDTH | 23 |
| 3.6. OUT-OF-BAND EMISSIONS | 24 |
| 3.7. ANTENNA REQUIREMENT | 25 |
| 4. TEST SETUP PHOTOS OF THE EUT | 26 |
| 5. PHOTOS OF THE EUT | 27 |

1. SUMMARY

1.1. TEST STANDARDS

The tests were performed according to following standards:

[FCC Rules Part 15.247](#): Frequency Hopping, Direct Spread Spectrum and Hybrid Systems that are in operation within the bands of 902-928 MHz, 2400-2483.5 MHz, and 5725-5850 MHz

[ANSI C63.10: 2013](#): American National Standard for Testing Unlicensed Wireless Devices

[KDB558074 D01 15.247 Meas Guidance v05r02](#): Guidance for Performing Compliance Measurements on Digital Transmission Systems (DTS) Operating Under §15.247

1.2. Test Description

| FCC PART 15.247 | | |
|----------------------------|--------------------------------|------|
| FCC Part 15.207 | AC Power Conducted Emission | PASS |
| FCC Part 15.247(a)(2) | 6dB Bandwidth | PASS |
| FCC Part 15.247(d) | Spurious RF Conducted Emission | PASS |
| FCC Part 15.247(b) | Maximum Conducted Output Power | PASS |
| FCC Part 15.247(e) | Power Spectral Density | PASS |
| FCC Part 15.205/ 15.209 | Radiated Emissions | PASS |
| FCC Part 15.247(d) | Band Edge | PASS |
| FCC Part 15.203/15.247 (b) | Antenna Requirement | PASS |

1.3. Test Facility

1.3.1 Address of the test laboratory

Shenzhen CTL Testing Technology Co., Ltd.

Floor 1-A, Baisha Technology Park, No. 3011, Shahehexi Road, Nanshan, Shenzhen 518055 China

There is one 3m semi-anechoic chamber and two line conducted labs for final test. The Test Sites meet the requirements in documents ANSI C63.4 and CISPR 22/EN 55022 requirements.

1.3.2 Laboratory accreditation

The test facility is recognized, certified, or accredited by the following organizations:

CNAS-Lab Code: L7497

Shenzhen CTL Testing Technology Co., Ltd. has been assessed and proved to be in compliance with CNAS-CL01 Accreditation Criteria for Testing and Calibration Laboratories (identical to ISO/IEC 17025: 2005 General Requirements) for the Competence of Testing and Calibration Laboratories.

A2LA-Lab Cert. No. 4343.01

Shenzhen CTL Testing Technology Co., Ltd. EMC Laboratory has been accredited by A2LA for technical competence in the field of electrical testing, and proved to be in compliance with ISO/IEC 17025: 2005 General Requirements for the Competence of Testing and Calibration Laboratories and any additional program requirements in the identified field of testing.

IC Registration No.: 9618B

CAB identifier: CN0041

The 3m alternate test site of Shenzhen CTL Testing Technology Co., Ltd. EMC Laboratory has been registered by Innovation, Science and Economic Development Canada to test to Canadian radio equipment requirements with Registration No.: 9618B on Jan. 22, 2019.

FCC-Registration No.: 399832

Designation No.: CN1216

Shenzhen CTL Testing Technology Co., Ltd. EMC Laboratory has been registered and fully described in a report filed with the (FCC) Federal Communications Commission. The acceptance letter from the FCC is maintained in our files. Registration 399832, December 08, 2017.

1.4. Statement of the measurement uncertainty

The data and results referenced in this document are true and accurate. The reader is cautioned that there may be errors within the calibration limits of the equipment and facilities. The measurement uncertainty was calculated for all measurements listed in this test report acc. to CISPR 16 - 4 "Specification for radio disturbance and immunity measuring apparatus and methods – Part 4: Uncertainty in EMC Measurements" and is documented in the Shenzhen CTL Testing Technology Co., Ltd. quality system acc. to DIN EN ISO/IEC 17025. Furthermore, component and process variability of devices similar to that tested may result in additional deviation. The manufacturer has the sole responsibility of continued compliance of the device.

Hereafter the best measurement capability for CTL laboratory is reported:

| Test | Measurement Uncertainty | Notes |
|---|-------------------------|-------|
| Transmitter power conducted | ± 0.57 dB | (1) |
| Transmitter power Radiated | ± 2.20 dB | (1) |
| Conducted spurious emission 9KHz-40 GHz | ± 2.20 dB | (1) |
| Occupied Bandwidth | ± 0.01 ppm | (1) |
| Radiated Emission 30~1000MHz | ± 4.10 dB | (1) |
| Radiated Emission Above 1GHz | ± 4.32 dB | (1) |
| Conducted Disturbance 0.15~30MHz | ± 3.20 dB | (1) |

- (1) This uncertainty represents an expanded uncertainty expressed at approximately the 95% confidence level using a coverage factor of $k=2$.

2. GENERAL INFORMATION

2.1. Environmental conditions

During the measurement the environmental conditions were within the listed ranges:

| | |
|---------------------|---------|
| Normal Temperature: | 25°C |
| Relative Humidity: | 55 % |
| Air Pressure: | 101 kPa |

2.2. General Description of EUT

| | |
|-----------------------|--|
| Product Name: | PALM 2 Gimbal Camera |
| Model/Type reference: | YTXJ06FM |
| Power supply: | DC 3.7V |
| Hardware version: | V02 |
| Software version: | V1.1.27.01 |
| WIFI : | |
| Supported type: | 802.11b/802.11g/802.11n(H20)/802.11n(H40) |
| Modulation: | 802.11b: DSSS 802.11g/802.11n(H20)/802.11n(H40): OFDM |
| Operation frequency: | 802.11b/802.11g/802.11n(H20): 2412MHz~2462MHz 802.11n(H40): 2422MHz~2452MHz |
| Channel number: | 802.11b/802.11g/802.11n(H20): 11 802.11n(H40): 7 |
| Channel separation: | 5MHz |
| Antenna type: | Chip antenna |
| Antenna gain: | 1.0dBi |

Note: For more details, please refer to the user's manual of the EUT.

2.3. Description of Test Modes and Test Frequency

The Applicant provides communication tools software to control the EUT for staying in continuous transmitting (Duty Cycle more than 98%) and receiving mode for testing.

There are 11 channels provided to the EUT and Channel 01/03/06/09/11 were selected for WIFI test.

Operation Frequency WIFI :

| Channel | Frequency(MHz) | Channel | Frequency(MHz) |
|---------|----------------|---------|----------------|
| 1 | 2412 | 8 | 2447 |
| 2 | 2417 | 9 | 2452 |
| 3 | 2422 | 10 | 2457 |
| 4 | 2427 | 11 | 2462 |
| 5 | 2432 | | |
| 6 | 2437 | | |
| 7 | 2442 | | |

Note: The line display in grey were the channel selected for testing

Data Rate Used:

Preliminary tests were performed in different data rate to find the worst radiated emission. The data rate shown in the table below is the worst-case rate with respect to the specific test item. Investigation has been done on all the possible configurations for searching the worst cases. The following table is a list of the test modes shown in this test report.

| Test Items | Mode | Data Rate | Channel |
|---|-----------------|-----------|---------|
| Maximum Conducted Output Power Power Spectral Density 6dB Bandwidth Spurious RF conducted emission Radiated Emission 9kHz~1GHz& Radiated Emission 1GHz~10th Harmonic | 11b/DSSS | 1 Mbps | 1/6/11 |
| | 11g/OFDM | 6 Mbps | 1/6/11 |
| | 11n(20MHz)/OFDM | 6.5Mbps | 1/6/11 |
| | 11n(40MHz)/OFDM | 13.5 Mbps | 3/6/9 |
| Band Edge | 11b/DSSS | 1 Mbps | 1/11 |
| | 11g/OFDM | 6 Mbps | 1/11 |
| | 11n(20MHz)/OFDM | 6.5Mbps | 1/11 |
| | 11n(40MHz)/OFDM | 13.5 Mbps | 3//9 |

2.4. Equipments Used during the Test

| Test Equipment | Manufacturer | Model No. | Serial No. | Calibration Date | Calibration Due Date |
|---------------------------------|----------------------|-----------|--------------|------------------|----------------------|
| LISN | R&S | ESH2-Z5 | 860014/010 | 2020/05/21 | 2021/05/21 |
| Double cone logarithmic antenna | Schwarzbeck | VULB 9168 | 824 | 2020/05/24 | 2021/05/23 |
| Horn Antenna | Ocean Microwave | OBH100400 | 26999002 | 2020/11/29 | 2021/11/28 |
| EMI Test Receiver | R&S | ESCI | 1166.5950.03 | 2020/05/22 | 2021/05/21 |
| Spectrum Analyzer | Agilent | E4407B | MY41440676 | 2020/05/21 | 2021/05/20 |
| Spectrum Analyzer | Agilent | N9020A | US46220290 | 2020/05/21 | 2021/05/20 |
| Spectrum Analyzer | Keysight | N9020A | MY53420874 | 2020/05/21 | 2021/05/20 |
| Controller | EM Electronics | EM 1000 | 060859 | 2020/05/22 | 2021/05/21 |
| Horn Antenna | Sunol Sciences Corp. | DRH-118 | A062013 | 2020/05/24 | 2021/05/23 |
| Active Loop Antenna | Da Ze | ZN30900A | / | 2020/05/24 | 2021/05/23 |
| Amplifier | Agilent | 8449B | 3008A02306 | 2020/05/22 | 2021/05/21 |
| Amplifier | Agilent | 8447D | 2944A10176 | 2020/05/22 | 2021/05/21 |
| Amplifier | Brief&Smart | LNA-4018 | 2104197 | 2020/05/21 | 2021/05/20 |
| Temperature/Humidity Meter | Gangxing | CTH-608 | 02 | 2020/05/23 | 2021/05/22 |
| Power Sensor | Agilent | U2021XA | MY55130004 | 2020/05/21 | 2021/05/20 |
| Power Sensor | Agilent | U2021XA | MY55130006 | 2020/05/21 | 2021/05/20 |

| | | | | | |
|--------------------|---------|---------|--------------|------------|------------|
| Power Sensor | Agilent | U2021XA | MY54510008 | 2020/05/21 | 2021/05/20 |
| Power Sensor | Agilent | U2021XA | MY55060003 | 2020/05/21 | 2021/05/20 |
| Spectrum Analyzer | RS | FSP | 1164.4391.38 | 2020/05/21 | 2021/05/20 |
| Test Software | | | | | |
| Name of Software | | | Version | | |
| TST-PASS: | | | 1.0.2 | | |
| ES-K1(Below 1GHz): | | | V1.71 | | |
| e3(Above 1GHz): | | | 6.111221a | | |

The calibration interval was one year

2.5. Related Submittal(s) / Grant (s)

This submittal(s) (test report) is intended to comply with Section 15.247 of the FCC Part 15, Subpart C Rules.

2.6. Modifications

No modifications were implemented to meet testing criteria.

3. TEST CONDITIONS AND RESULTS

3.1. Conducted Emissions Test

LIMIT

FCC CFR Title 47 Part 15 Subpart C Section 15.207

| Frequency range (MHz) | Limit (dBuV) | |
|-----------------------|--------------|-----------|
| | Quasi-peak | Average |
| 0.15-0.5 | 66 to 56* | 56 to 46* |
| 0.5-5 | 56 | 46 |
| 5-30 | 60 | 50 |

* Decreases with the logarithm of the frequency.

TEST CONFIGURATION



TEST PROCEDURE

1. The equipment was set up as per the test configuration to simulate typical actual usage per the user's manual. The EUT is a tabletop system; a wooden table with a height of 0.8 meters is used and is placed on the ground plane as per ANSI C63.10:2013.
2. Support equipment, if needed, was placed as per ANSI C63.10:2013.
3. All I/O cables were positioned to simulate typical actual usage as per ANSI C63.10:2013.
4. The adapter received AC120V/60Hz power through a Line Impedance Stabilization Network (LISN) which supplied power source and was grounded to the ground plane.
5. All support equipments received AC power from a second LISN, if any.
6. The EUT test program was started. Emissions were measured on each current carrying line of the EUT using a spectrum Analyzer / Receiver connected to the LISN powering the EUT. The LISN has two monitoring points: Line 1 (Hot Side) and Line 2 (Neutral Side). Two scans were taken: one with Line 1 connected to Analyzer / Receiver and Line 2 connected to a 50 ohm load; the second scan had Line 1 connected to a 50 ohm load and Line 2 connected to the Analyzer / Receiver.
7. Analyzer / Receiver scanned from 150 KHz to 30MHz for emissions in each of the test modes.
8. During the above scans, the emissions were maximized by cable manipulation.

TEST RESULTS

Remark:802.11b/802.11g/802.11n (H20)/802.11n(H40) mode all have been tested, only worse case of 802.11b High Channel was reported.

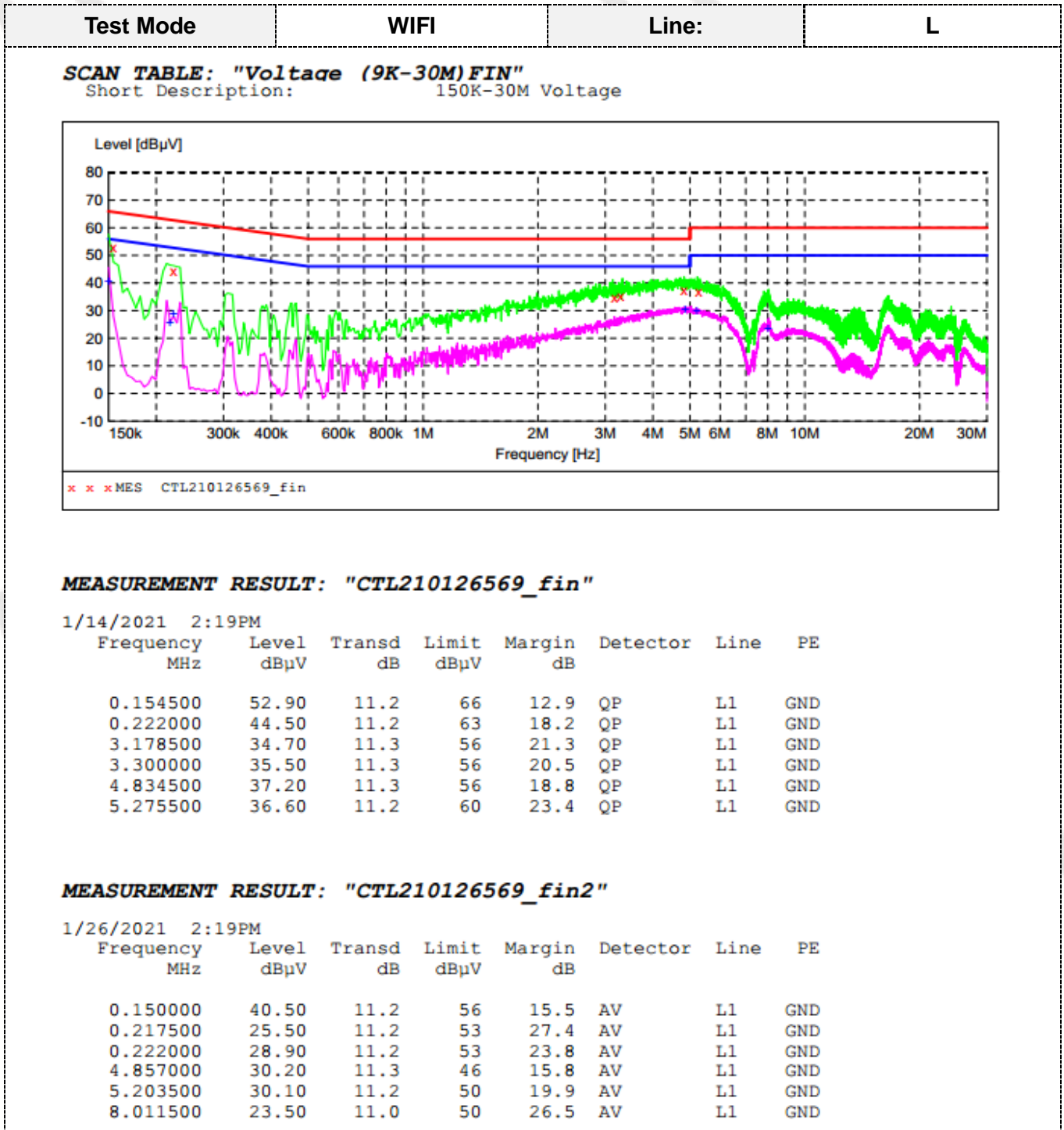

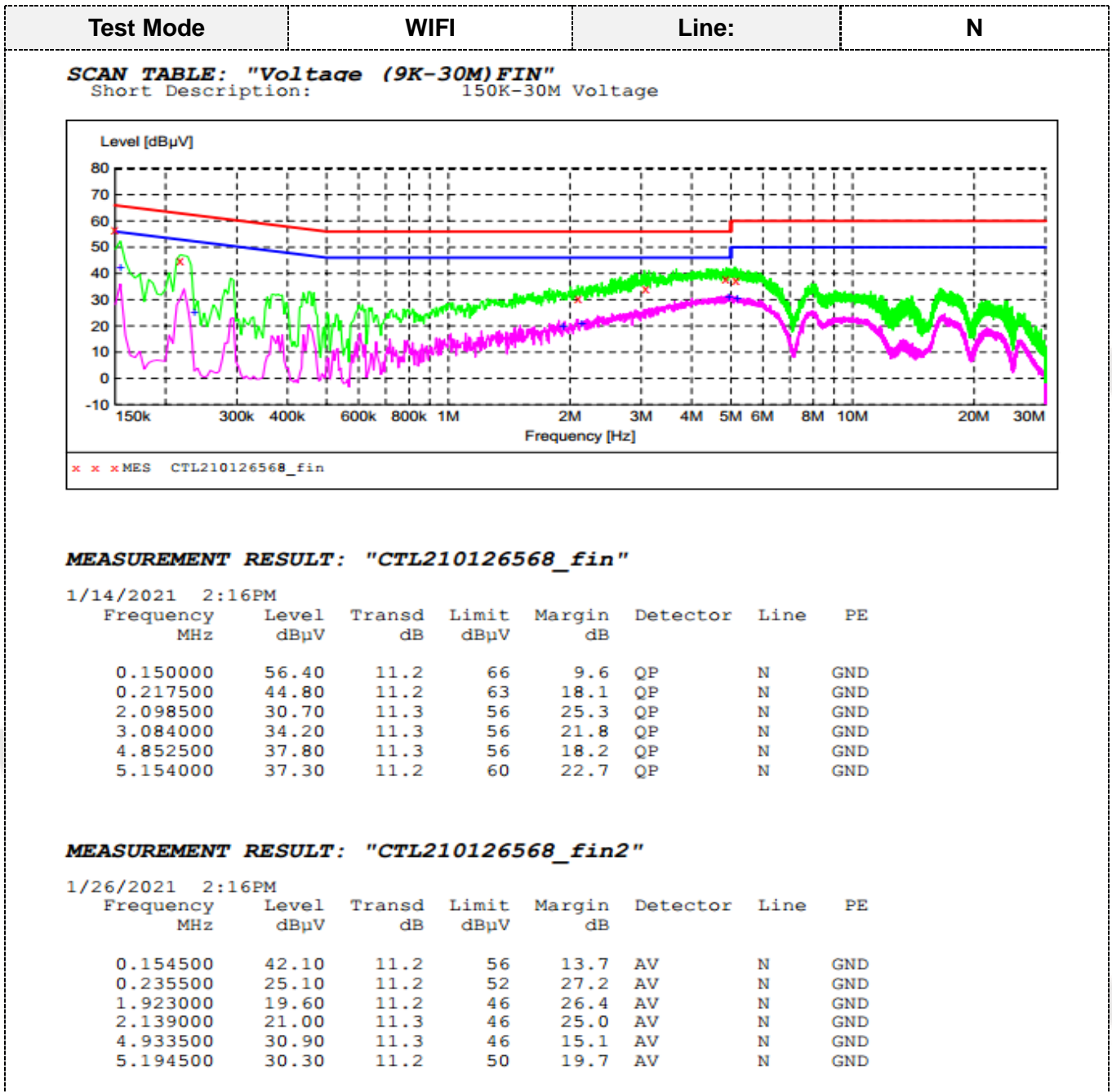

3.2. Radiated Emissions and Band Edge

Limit

For intentional device, according to § 15.209(a), the general requirement of field strength of radiated emission out of authorized band shall not exceed the following table at a 3 meters measurement distance.

In addition, radiated emissions which fall in the restricted bands, as defined in §15.205(a), must also comply with the radiated emission limits specified in §15.209(a)

Radiated emission limits

| Frequency (MHz) | Distance (Meters) | Radiated (dBµV/m) | Radiated (µV/m) |
|-----------------|-------------------|--|-----------------------|
| 0.009-0.49 | 3 | $20\log(2400/F(\text{KHz}))+40\log(300/3)$ | $2400/F(\text{KHz})$ |
| 0.49-1.705 | 3 | $20\log(24000/F(\text{KHz}))+40\log(30/3)$ | $24000/F(\text{KHz})$ |
| 1.705-30 | 3 | $20\log(30)+40\log(30/3)$ | 30 |
| 30-88 | 3 | 40.0 | 100 |
| 88-216 | 3 | 43.5 | 150 |
| 216-960 | 3 | 46.0 | 200 |
| Above 960 | 3 | 54.0 | 500 |

TEST CONFIGURATION

(A) Radiated Emission Test Set-Up, Frequency Below 30MHz

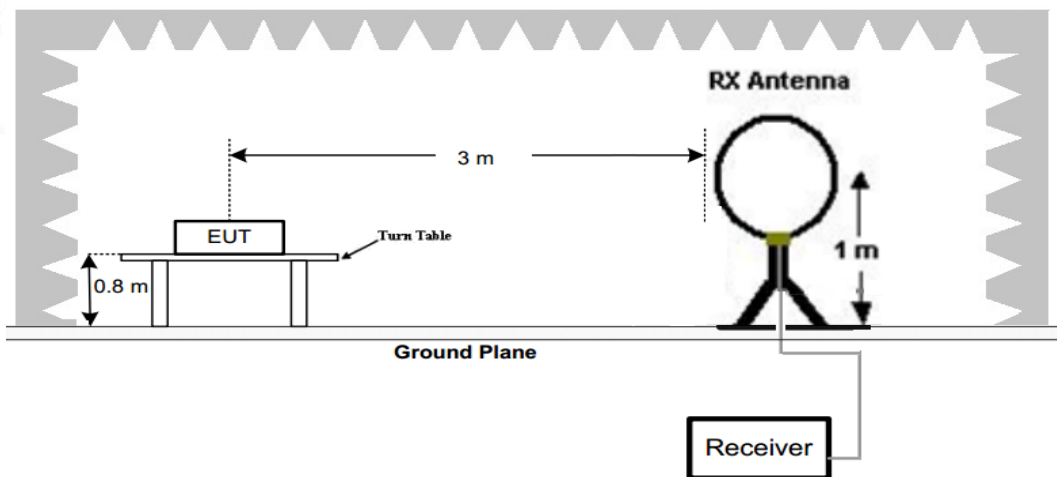

(B) Radiated Emission Test Set-Up, Frequency below 1000MHz

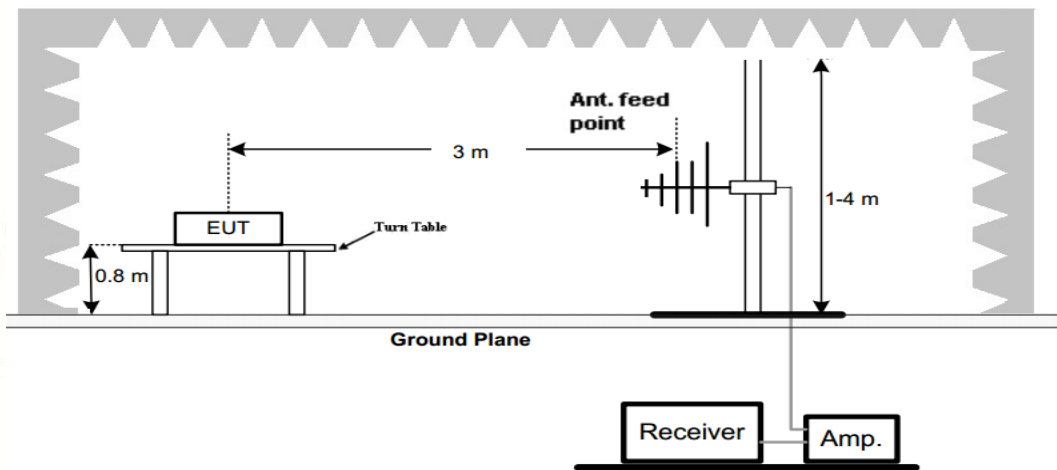

(C) Radiated Emission Test Set-Up, Frequency above 1000MHz

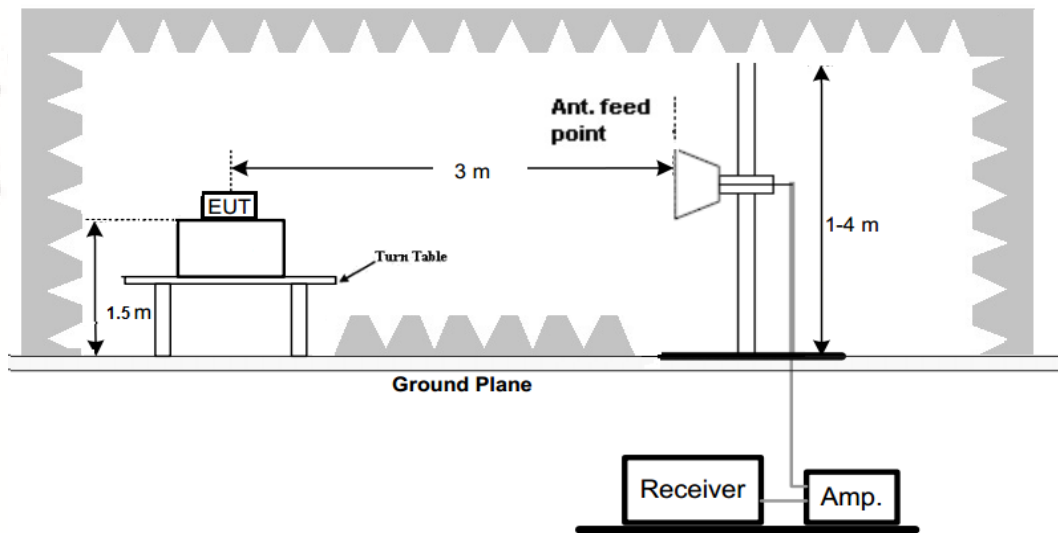

Test Procedure

1. Below 1GHz measurement the EUT is placed on a turntable which is 0.8m above ground plane, and above 1GHz measurement EUT was placed on a low permittivity and low loss tangent turn table which is 1.5m above ground plane.
2. Maximum procedure was performed by raising the receiving antenna from 1m to 4m and rotating the turn table from 0° to 360° to acquire the highest emissions from EUT
3. And also, each emission was to be maximized by changing the polarization of receiving antenna both horizontal and vertical.
4. Repeat above procedures until all frequency measurements have been completed.

TEST RESULTS

Remark:

1. All three channels (lowest/middle/highest) of each mode were measured below 1GHz and recorded worst case at 802.11b low channel.
2. All three channels (lowest/middle/highest) of each mode were measured above 1GHz and recorded worst case at 802.11b mode.
3. Radiated emission test from 9 KHz to 10th harmonic of fundamental was verified, and no emission found except system noise floor in 9 KHz to 30MHz and not recorded in this report.

For 30MHz-1GHz

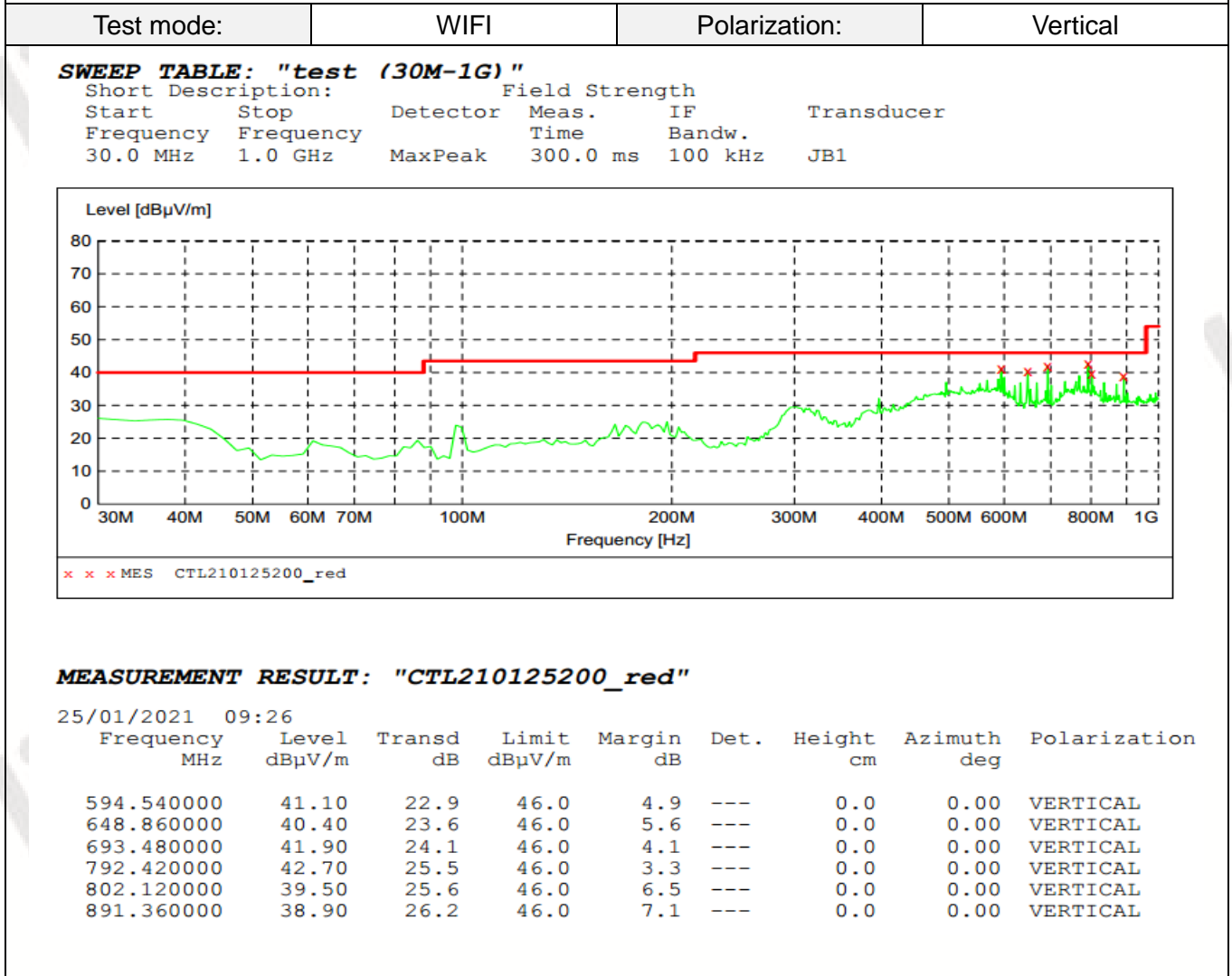
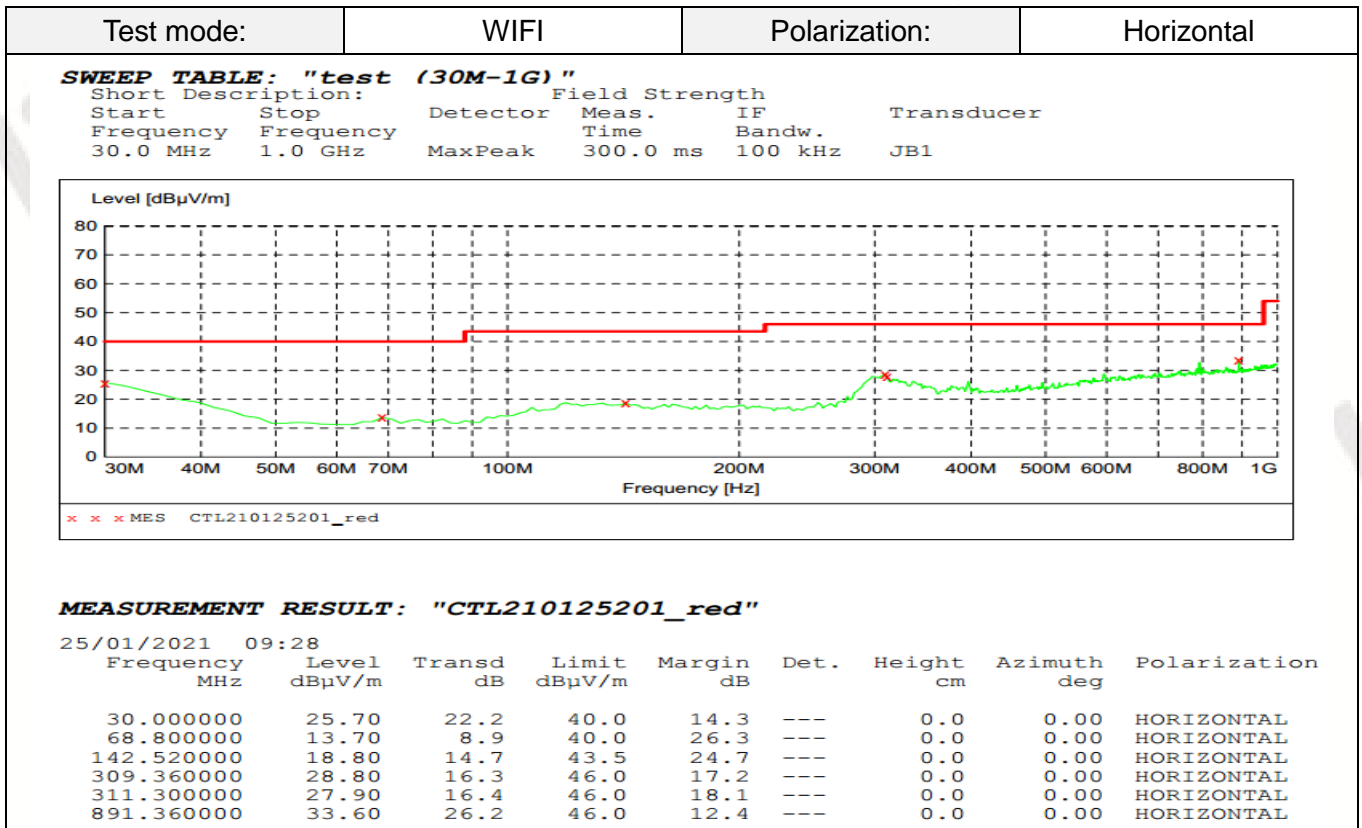

For 1GHz to 25GHz**802.11b Mode (above 1GHz)**

Note: 802.11b/802.11g/802.11n (H20)/802.11n (H40) all have been tested, only worse case 802.11b is reported

| Frequency(MHz): | | | 2412 | | Polarity: | | | HORIZONTAL | |
|-----------------|-------------------------|----|----------------|-------------|------------------|-----------------------|-------------------|--------------------|--------------------------|
| Frequency (MHz) | Emission Level (dBuV/m) | | Limit (dBuV/m) | Margin (dB) | Raw Value (dBuV) | Antenna Factor (dB/m) | Cable Factor (dB) | Pre-amplifier (dB) | Correction Factor (dB/m) |
| 4824.00 | 60.45 | PK | 74 | 13.55 | 55.9 | 33.52 | 6.92 | 35.89 | 4.55 |
| 4824.00 | 51.23 | AV | 54 | 2.77 | 46.68 | 33.52 | 6.92 | 35.89 | 4.55 |
| 5140.75 | 55.42 | PK | 74 | 18.58 | 48.22 | 34.38 | 7.10 | 34.28 | 7.20 |
| 5140.75 | -- | AV | 54 | -- | -- | -- | -- | -- | -- |
| 7236.00 | 47.25 | PK | 74 | 26.75 | 35.98 | 37.1 | 9.19 | 35.02 | 11.27 |
| 7236.00 | -- | AV | 54 | -- | -- | -- | -- | -- | -- |

| Frequency(MHz): | | | 2412 | | Polarity: | | | VERTICAL | |
|-----------------|-------------------------|----|----------------|-------------|------------------|-----------------------|-------------------|--------------------|--------------------------|
| Frequency (MHz) | Emission Level (dBuV/m) | | Limit (dBuV/m) | Margin (dB) | Raw Value (dBuV) | Antenna Factor (dB/m) | Cable Factor (dB) | Pre-amplifier (dB) | Correction Factor (dB/m) |
| 4824.00 | 60.41 | PK | 74 | 13.59 | 55.86 | 33.52 | 6.92 | 35.89 | 4.55 |
| 4824.00 | 50.85 | AV | 54 | 3.15 | 46.3 | 33.52 | 6.92 | 35.89 | 4.55 |
| 5125.75 | 52.35 | PK | 74 | 21.65 | 45.15 | 34.38 | 7.10 | 34.28 | 7.20 |
| 5125.75 | -- | AV | 54 | -- | -- | -- | -- | -- | -- |
| 7236.00 | 50.36 | PK | 74 | 23.64 | 39.09 | 37.1 | 9.19 | 35.02 | 11.27 |
| 7236.00 | -- | AV | 54 | -- | -- | -- | -- | -- | -- |

| Frequency(MHz): | | | 2437 | | Polarity: | | | HORIZONTAL | |
|-----------------|-------------------------|----|----------------|-------------|------------------|-----------------------|-------------------|--------------------|--------------------------|
| Frequency (MHz) | Emission Level (dBuV/m) | | Limit (dBuV/m) | Margin (dB) | Raw Value (dBuV) | Antenna Factor (dB/m) | Cable Factor (dB) | Pre-amplifier (dB) | Correction Factor (dB/m) |
| 4874.00 | 59.77 | PK | 74 | 14.23 | 53.53 | 33.59 | 6.95 | 34.3 | 6.24 |
| 4874.00 | 50.25 | AV | 54 | 3.75 | 44.01 | 33.59 | 6.95 | 34.3 | 6.24 |
| 5230.00 | 47.76 | PK | 74 | 26.24 | 40.16 | 34.56 | 7.15 | 34.11 | 7.60 |
| 5230.00 | -- | AV | 54 | -- | -- | -- | -- | -- | -- |
| 7311.00 | 49.14 | PK | 74 | 24.86 | 37.48 | 37.44 | 9.22 | 35 | 11.66 |
| 7311.00 | -- | AV | 54 | -- | -- | -- | -- | -- | -- |

| Frequency(MHz): | | | 2437 | | Polarity: | | | VERTICAL | |
|-----------------|-------------------------|----|----------------|-------------|------------------|-----------------------|-------------------|--------------------|--------------------------|
| Frequency (MHz) | Emission Level (dBuV/m) | | Limit (dBuV/m) | Margin (dB) | Raw Value (dBuV) | Antenna Factor (dB/m) | Cable Factor (dB) | Pre-amplifier (dB) | Correction Factor (dB/m) |
| 4874.00 | 61.14 | PK | 74 | 12.86 | 54.8 | 33.59 | 6.95 | 34.2 | 6.34 |
| 4874.00 | 51.75 | AV | 54 | 2.25 | 45.41 | 33.59 | 6.95 | 34.2 | 6.34 |
| 5230.00 | 51.36 | PK | 74 | 22.64 | 44.46 | 34.07 | 7.05 | 34.22 | 6.90 |
| 5230.00 | -- | AV | 54 | -- | -- | -- | -- | -- | -- |
| 7311.00 | 49.55 | PK | 74 | 24.45 | 37.89 | 37.44 | 9.22 | 35 | 11.66 |
| 7311.00 | -- | AV | 54 | -- | -- | -- | -- | -- | -- |

| Frequency(MHz): | | | 2462 | | Polarity: | | | HORIZONTAL | |
|-----------------|-------------------------|----|----------------|-------------|------------------|-----------------------|-------------------|--------------------|--------------------------|
| Frequency (MHz) | Emission Level (dBuV/m) | | Limit (dBuV/m) | Margin (dB) | Raw Value (dBuV) | Antenna Factor (dB/m) | Cable Factor (dB) | Pre-amplifier (dB) | Correction Factor (dB/m) |
| 4924.00 | 60.41 | PK | 74 | 13.59 | 53.55 | 33.71 | 6.98 | 35.91 | 4.78 |
| 4924.00 | 51.23 | AV | 54 | 2.77 | 43.73 | 33.71 | 6.98 | 35.91 | 4.78 |
| 5110.50 | 49.24 | PK | 74 | 24.76 | 41.24 | 34.34 | 7.09 | 34.27 | 7.17 |
| 5110.50 | -- | AV | 54 | -- | -- | -- | -- | -- | -- |
| 7386.00 | 49.36 | PK | 74 | 24.64 | 37.4 | 37.61 | 9.25 | 34.98 | 11.88 |
| 7386.00 | -- | AV | 54 | -- | -- | -- | -- | -- | -- |

| Frequency(MHz): | | | 2462 | | Polarity: | | | VERTICAL | |
|-----------------|-------------------------|----|----------------|-------------|------------------|-----------------------|-------------------|--------------------|--------------------------|
| Frequency (MHz) | Emission Level (dBuV/m) | | Limit (dBuV/m) | Margin (dB) | Raw Value (dBuV) | Antenna Factor (dB/m) | Cable Factor (dB) | Pre-amplifier (dB) | Correction Factor (dB/m) |
| 4924.00 | 60.85 | PK | 74 | 13.15 | 56.07 | 33.71 | 6.98 | 35.91 | 4.78 |
| 4924.00 | 51.02 | AV | 54 | 2.98 | 46.24 | 33.71 | 6.98 | 35.91 | 4.78 |
| 5110.50 | 49.43 | PK | 74 | 24.57 | 42.26 | 34.34 | 7.09 | 34.27 | 7.17 |
| 5110.50 | -- | AV | 54 | -- | -- | -- | -- | -- | -- |
| 7386.00 | 48.23 | PK | 74 | 25.77 | 36.35 | 37.61 | 9.25 | 34.98 | 11.88 |
| 7386.00 | -- | AV | 54 | -- | -- | -- | -- | -- | -- |

REMARKS:

1. Emission level (dBuV/m) =Raw Value (dBuV)+Correction Factor (dB/m)
2. Correction Factor (dB/m) = Antenna Factor (dB/m)+Cable Factor (dB)-Pre-amplifier Factor
3. Margin value = Limit value- Emission level.
4. -- Mean the PK detector measured value is below average limit.
5. The other emission levels were very low against the limit.
6. RBW1MHz VBW3MHz Peak detector is for PK value; RBW 1MHz VBW10Hz Peak detector is for AV value.

Results of Band Edges Test (Radiated)

Note: 802.11b/802.11g/802.11n (H20)/802.11n (H40) all have been tested, only worse case 802.11b is reported

| Frequency(MHz): | | | 2412 | | Polarity: | | | HORIZONTAL | |
|-----------------|-------------------------|----|----------------|-------------|------------------|-----------------------|-------------------|--------------------|--------------------------|
| Frequency (MHz) | Emission Level (dBuV/m) | | Limit (dBuV/m) | Margin (dB) | Raw Value (dBuV) | Antenna Factor (dB/m) | Cable Factor (dB) | Pre-amplifier (dB) | Correction Factor (dB/m) |
| 2412.00 | 108.52 | PK | -- | -- | 75.13 | 28.78 | 4.61 | 0 | 33.39 |
| 2412.00 | 99.42 | AV | -- | -- | 66.03 | 28.78 | 4.61 | 0 | 33.39 |
| 2355.45 | 47.35 | PK | 74 | 26.65 | 14.27 | 28.52 | 4.56 | 0 | 33.08 |
| 2355.45 | -- | AV | 54 | -- | -- | -- | -- | -- | -- |
| 2390.00 | 57.74 | PK | 74 | 16.26 | 24.42 | 28.72 | 4.60 | 0 | 33.32 |
| 2390.00 | 49.39 | AV | 54 | 4.61 | 16.07 | 28.72 | 4.60 | 0 | 33.32 |
| 2400.00 | 56.95 | PK | 74 | 17.05 | 23.56 | 28.78 | 4.61 | 0 | 33.39 |
| 2400.00 | 48.41 | AV | 54 | 5.59 | 15.02 | 28.78 | 4.61 | 0 | 33.39 |

| Frequency(MHz): | | | 2412 | | Polarity: | | | VERTICAL | |
|-----------------|-------------------------|----|----------------|-------------|------------------|-----------------------|-------------------|--------------------|--------------------------|
| Frequency (MHz) | Emission Level (dBuV/m) | | Limit (dBuV/m) | Margin (dB) | Raw Value (dBuV) | Antenna Factor (dB/m) | Cable Factor (dB) | Pre-amplifier (dB) | Correction Factor (dB/m) |
| 2412.00 | 108.32 | PK | -- | -- | 74.93 | 28.78 | 4.61 | 0 | 33.39 |
| 2412.00 | 99.12 | AV | -- | -- | 65.73 | 28.78 | 4.61 | 0 | 33.39 |
| 2355.45 | 45.23 | PK | 74 | 28.77 | 12.15 | 28.52 | 4.56 | 0 | 33.08 |
| 2355.45 | -- | AV | 54 | -- | -- | -- | -- | -- | -- |
| 2390.00 | 59.14 | PK | 74 | 14.86 | 25.82 | 28.72 | 4.60 | 0 | 33.32 |
| 2390.00 | 50.85 | AV | 54 | 3.15 | 17.53 | 28.72 | 4.60 | 0 | 33.32 |
| 2400.00 | 60.62 | PK | 74 | 13.38 | 27.23 | 28.78 | 4.61 | 0 | 33.39 |
| 2400.00 | 51.75 | AV | 54 | 2.25 | 18.36 | 28.78 | 4.61 | 0 | 33.39 |

| Frequency(MHz): | | | 2462 | | Polarity: | | | HORIZONTAL | |
|-----------------|-------------------------|----|----------------|-------------|------------------|-----------------------|-------------------|--------------------|--------------------------|
| Frequency (MHz) | Emission Level (dBuV/m) | | Limit (dBuV/m) | Margin (dB) | Raw Value (dBuV) | Antenna Factor (dB/m) | Cable Factor (dB) | Pre-amplifier (dB) | Correction Factor (dB/m) |
| 2462.00 | 110.15 | PK | -- | -- | 76.53 | 28.92 | 4.7 | 0 | 33.62 |
| 2462.00 | 100.95 | AV | -- | -- | 67.33 | 28.92 | 4.7 | 0 | 33.62 |
| 2483.50 | 52.34 | PK | 74 | 21.66 | 18.71 | 28.93 | 4.7 | 0 | 33.63 |
| 2483.50 | -- | AV | 54 | -- | -- | -- | -- | -- | -- |
| 2486.75 | 50.24 | PK | 74 | 23.76 | 16.6 | 28.94 | 4.71 | 0 | 33.64 |
| 2486.75 | -- | AV | 54 | -- | -- | -- | -- | -- | -- |
| 2500.00 | 49.41 | PK | 74 | 24.59 | 15.73 | 28.96 | 4.72 | 0 | 33.68 |
| 2500.00 | -- | AV | 54 | -- | -- | -- | -- | -- | -- |

| Frequency(MHz): | | | 2462 | | Polarity: | | | VERTICAL | |
|-----------------|-------------------------|----|----------------|-------------|------------------|-----------------------|-------------------|--------------------|--------------------------|
| Frequency (MHz) | Emission Level (dBuV/m) | | Limit (dBuV/m) | Margin (dB) | Raw Value (dBuV) | Antenna Factor (dB/m) | Cable Factor (dB) | Pre-amplifier (dB) | Correction Factor (dB/m) |
| 2462.00 | 109.12 | PK | -- | -- | 75.5 | 28.92 | 4.7 | 0 | 33.62 |
| 2462.00 | 99.27 | AV | -- | -- | 65.65 | 28.92 | 4.7 | 0 | 33.62 |
| 2483.50 | 51.39 | PK | 74 | 22.61 | 17.76 | 28.93 | 4.7 | 0 | 33.63 |
| 2483.50 | -- | AV | 54 | -- | -- | -- | -- | -- | -- |
| 2486.75 | 49.32 | PK | 74 | 24.68 | 15.68 | 28.94 | 4.71 | 0 | 33.64 |
| 2486.75 | -- | AV | 54 | -- | -- | -- | -- | -- | -- |
| 2500.00 | 48.93 | PK | 74 | 25.07 | 15.25 | 28.96 | 4.72 | 0 | 33.68 |
| 2500.00 | -- | AV | 54 | -- | -- | -- | -- | -- | -- |

REMARKS:

1. Emission level (dBuV/m) =Raw Value (dBuV)+Correction Factor (dB/m)
2. Correction Factor (dB/m) = Antenna Factor (dB/m)+Cable Factor (dB)-Pre-amplifier Factor
3. Margin value = Limit value- Emission level.
4. -- Mean the PK detector measured value is below average limit.
5. The other emission levels were very low against the limit.
6. RBW1MHz VBW3MHz Peak detector is for PK value; RBW 1MHz VBW10Hz Peak detector is for AV value.
7. For fundamental frequency, RBW 3MHz VBW 3MHz Peak detector is for PK Value; RMS detector is for AV value.

3.3. Maximum Conducted Output Power

Limit

The Maximum Peak Output Power Measurement is 30dBm.

Test Procedure

Remove the antenna from the EUT and then connect a low loss RF cable from the antenna port to the power sensor.

Test Configuration

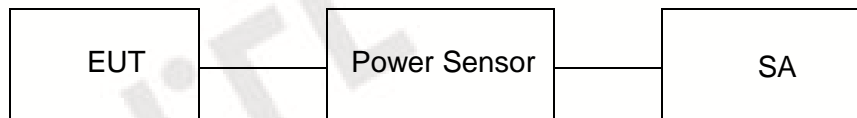

Test Results

See Appendix 2.

3.4. Power Spectral Density

Limit

For digitally modulated systems, the power spectral density conducted from the intentional radiator to the antenna shall not be greater than 8 dBm in any 3 kHz band during any time interval of continuous transmission.

Test Procedure

1. Use this procedure when the maximum peak conducted output power in the fundamental emission is used to demonstrate compliance.
2. Set the RBW \geq 3 kHz.
3. Set the VBW \geq 3 \times RBW.
4. Set the span to 1.5 times the DTS channel bandwidth.
5. Detector = peak.
6. Sweep time = auto couple.
7. Trace mode = max hold.
8. Allow trace to fully stabilize.
9. Use the peak marker function to determine the maximum power level.
10. If measured value exceeds limit, reduce RBW (no less than 3 kHz) and repeat.
11. The resulting peak PSD level must be 8dBm.

Test Configuration

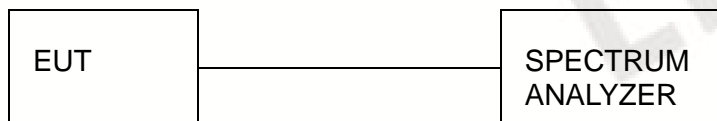

Test Results

See Appendix 3.

3.5. 6dB Bandwidth

Limit

For digital modulation systems, the minimum 6 dB bandwidth shall be at least 500 kHz

Test Procedure

The transmitter output was connected to the spectrum analyzer through an attenuator. The bandwidth of the fundamental frequency was measured by spectrum analyzer with 100 KHz RBW and 300 KHz VBW. The 6dB bandwidth is defined as the total spectrum the power of which is higher than peak power minus 6dB.

Test Configuration

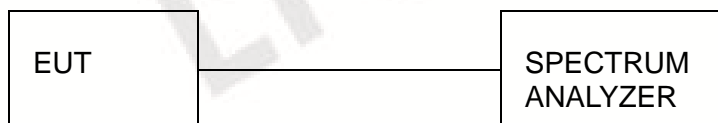

Test Results

See Appendix 1.

3.6. Out-of-band Emissions

Limit

In any 100 kHz bandwidth outside the frequency band in which the spread spectrum or digitally modulated intentional radiator is operating, the radio frequency power that is produced by the intentional radiator shall be at least 20 dB below that in the 100 kHz bandwidth within the band that contains the highest level of the desired power, based on either an RF conducted or a radiated measurement, provided the transmitter demonstrates compliance with the peak conducted power limits. If the transmitter complies with the conducted power limits based on the use of RMS averaging over a time interval, as permitted under paragraph (b)(3) of this section, the attenuation required under this paragraph shall be 30 dB instead of 20 dB. Attenuation below the general limits specified in §15.209(a) is not required.

Test Procedure

Connect the transmitter output to spectrum analyzer using a low loss RF cable, and set the spectrum analyzer to RBW=100 kHz, VBW= 300 kHz, peak detector, and max hold. Measurements utilizing these settings are made of the in-band reference level, band-edge and out-of-band emissions.

Test Configuration

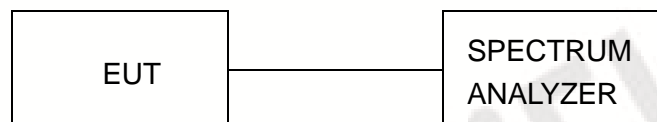

Test Results

See Appendix 4.

3.7. Antenna Requirement

Standard Applicable

For intentional device, according to FCC 47 CFR Section 15.203:

An intentional radiator shall be designed to ensure that no antenna other than that furnished by the responsible party shall be used with the device. The use of a permanently attached antenna or of an antenna that uses a unique coupling to the intentional radiator, the manufacturer may design the unit so that a broken antenna can be replaced by the user, but the use of a standard antenna jack or electrical connector is prohibited

FCC CFR Title 47 Part 15 Subpart C Section 15.247(c) (1) (I):

(i) Systems operating in the 2400-2483.5 MHz band that is used exclusively for fixed. Point-to-point operations may employ transmitting antennas with directional gain greater than 6dBi provided the maximum conducted output power of the intentional radiator is reduced by 1 dB for every 3 dB that the directional gain of the antenna exceeds 6dBi.

Test Result:

The maximum gain of antenna was 1.0dBi.

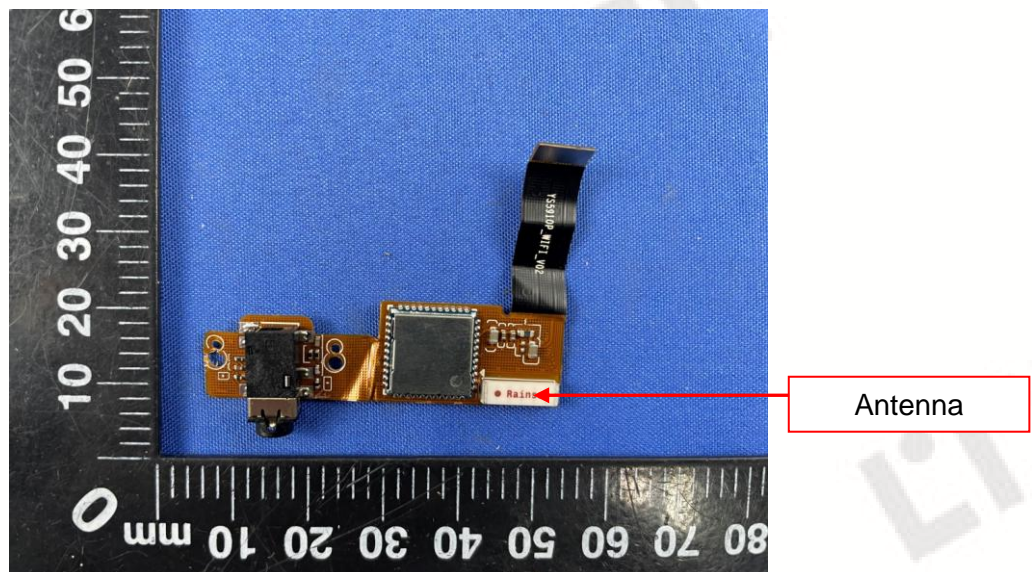

4. Test Setup Photos of the EUT

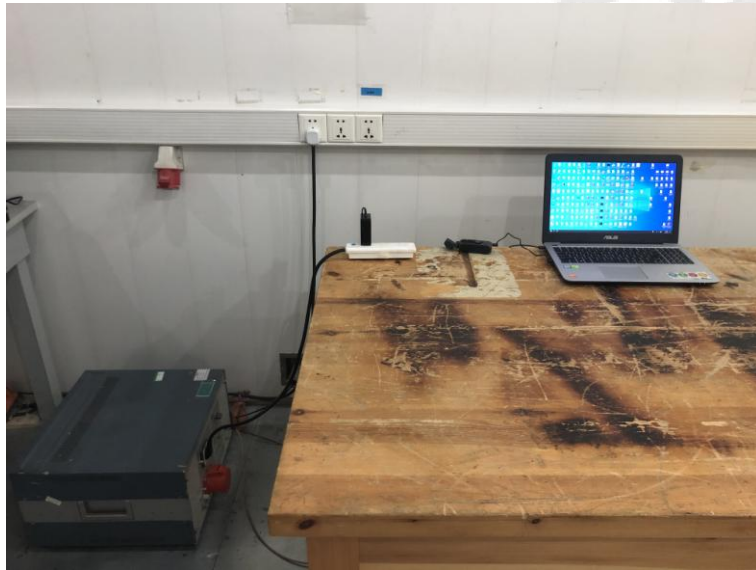

5. Photos of the EUT

External Photos of EUT





Internal Photos of EUT

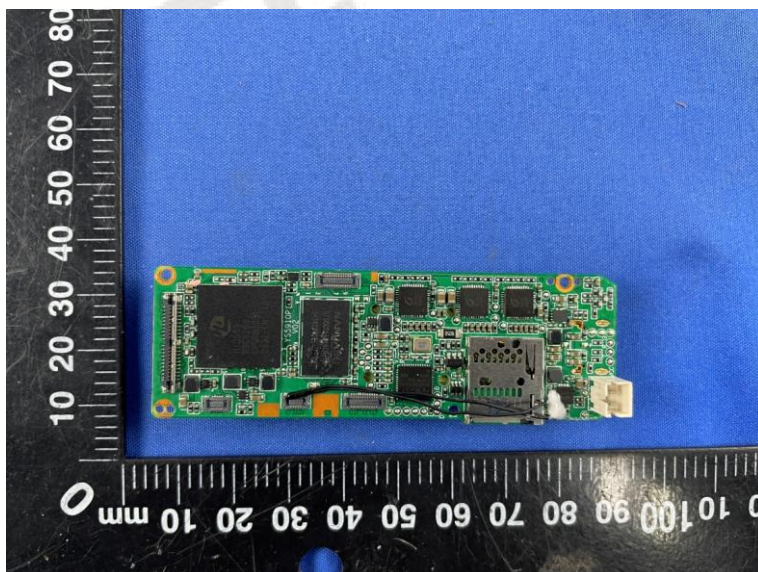
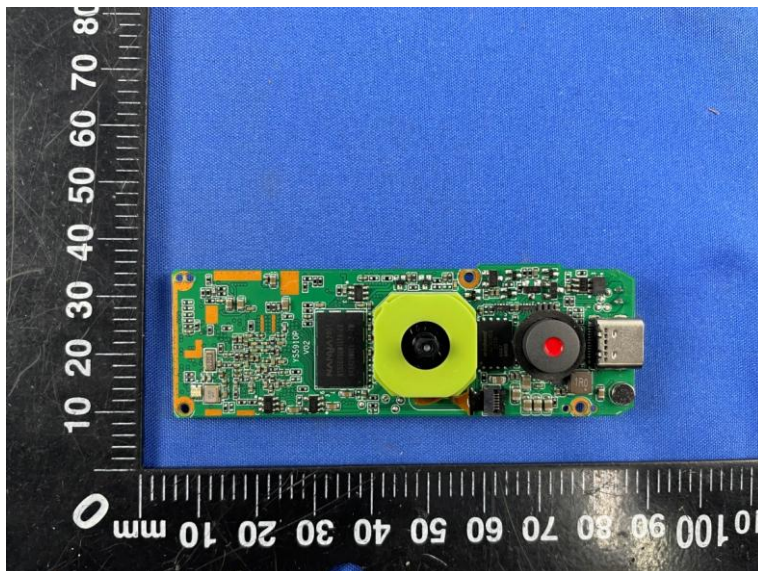

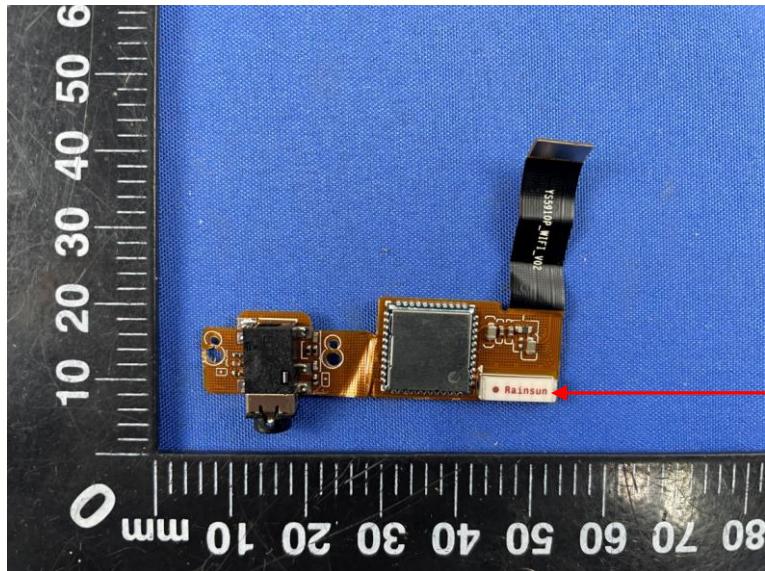
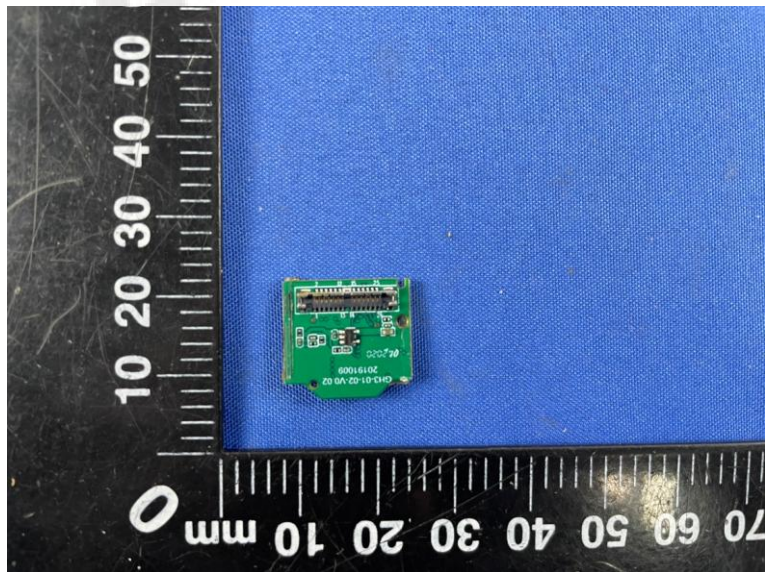
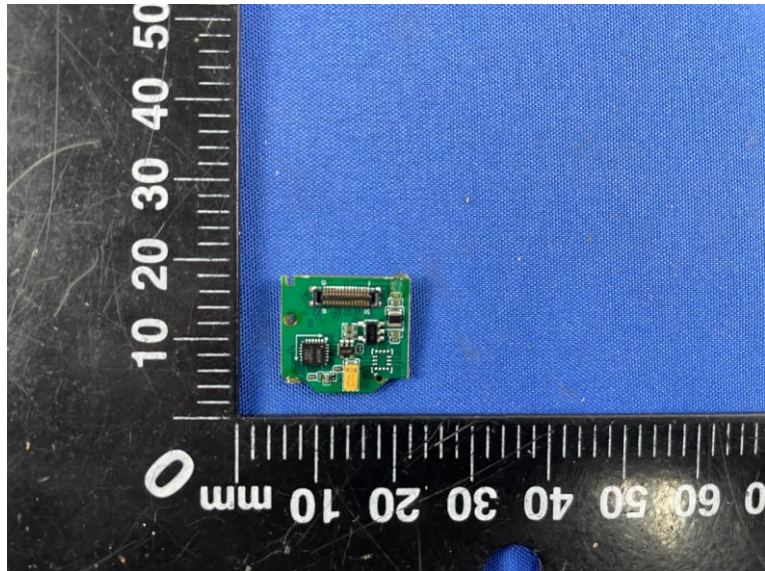

Antenna

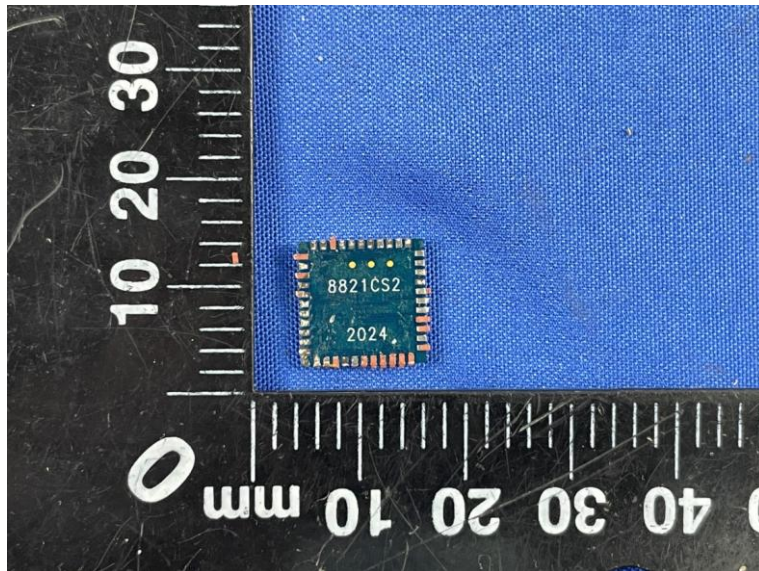
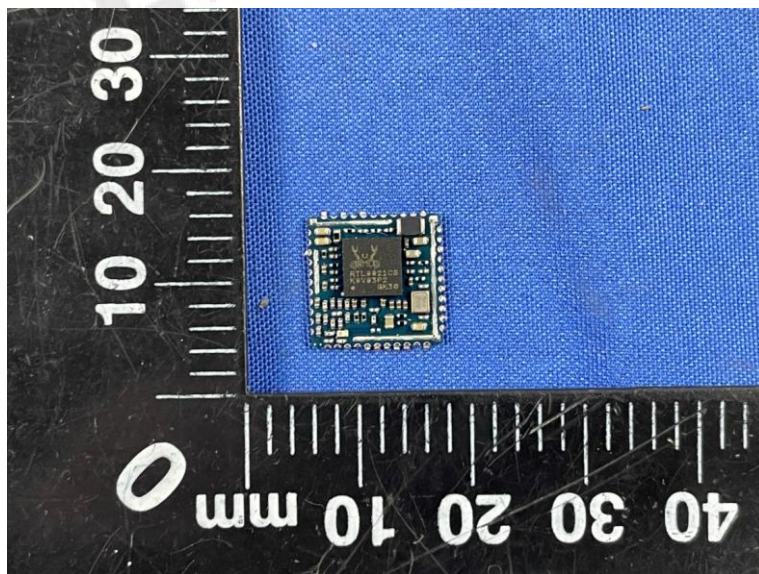
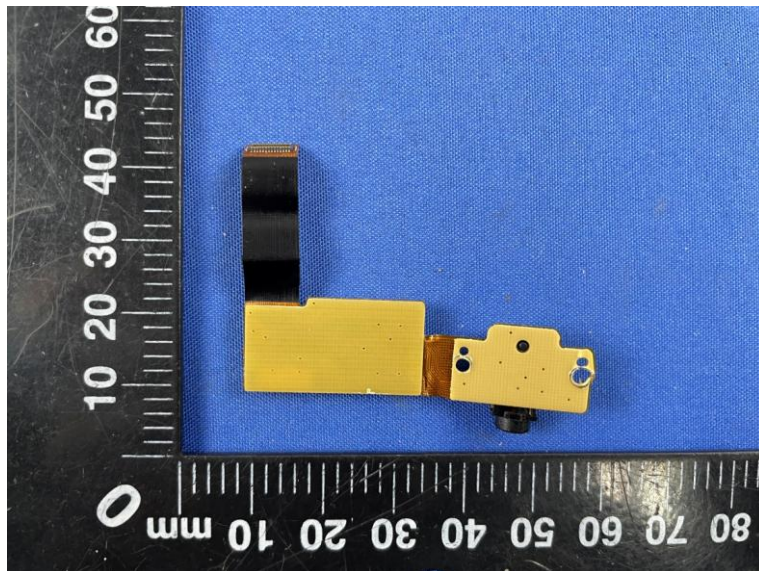



***** End of Report *****