

RF TEST REPORT

FCC / ISED

APPLICANT

Treadly Inc

MODEL NAME

TRB200

FCC ID

2AYVR-TRB200

REPORT NUMBER

HA210106-ESM-001-R03

TEST REPORT

Date of Issue
February 25, 2021

Test Site
Hyundai C-Tech, Inc. dba HCT America, Inc.
1726 Ringwood Ave, San Jose, CA 95131, USA

Applicant	Treadly Inc
Applicant Address	530 Secaucus Rd, Secaucus, NJ 07094, U.S.A.
FCC ID	2AYVR-TRB200
Model Name	TRB200
EUT Type	Wi-Fi/BLE Module
Modulation Type	GFSK
FCC Classification	Digital Transmission System (DTS)
FCC Rule Part(s)	Part 15.247
ISED Rule Part(s)	RSS-247 Issue 2 (February 2017), RSS-Gen Issue 5 (April 2018)
Test Procedure	ANSI C63.10-2013, KDB 558074 D01 v05r02

The device bearing the trade name and model specified above, has been shown to comply with the applicable technical standards as indicated in the measurement report and was tested in accordance with the measurement procedures required. The results of testing in this report apply only to the product which was tested. Other similar equipment will not necessarily produce the same results due to production tolerance and measurement uncertainties.

I attest to the accuracy of data. All measurements reported herein were performed by me or were made under my supervision and are correct to the best of my knowledge and belief. I assume full responsibility for the completeness of these measurements and vouch for the qualifications of all persons taking them.

Hyundai C-Tech, Inc. dba HCT America, Inc. certifies that no party to application has been denied the FCC benefits pursuant to Section 5301 of the Anti-Drug Abuse Act of 1988, 21 U.S.C 862

Tested By

Yongsoo Park

Test Engineer

Reviewed By

Sunwoo Kim

Technical Manager

REVISION HISTORY

The revision history for this document is shown in table.

TEST REPORT NO.	DATE	DESCRIPTION
HA210106-ESM-001-R03	02/17/2021	Initial Issue
HA210106-ESM-001-R03	02/25/2021	Added Test Configuration Setup on page 25.

TABLE OF CONTENTS

1. GENERAL INFORMATION	4
2. METHODOLOGY	6
3. INSTRUMENT CALIBRATION	6
4. FACILITIES AND ACCREDITATIONS	7
5. ANTENNA REQUIREMENTS	8
6. MEASUREMENT UNCERTAINTY	9
7. DESCRIPTION OF TESTS	10
8. SUMMARY OF TEST RESULTS.....	23
9. TEST RESULT	27
9.1. DUTY CYCLE.....	27
9.2. 6 dB BANDWIDTH / 99% BANDWIDTH MEASUREMENT.....	28
9.3. OUTPUT POWER.....	30
9.4. POWER SPECTRAL DENSITY	31
9.5. CONDUCTED BAND EDGE & SPURIOUS EMISSIONS.....	33
9.6. RADIATED SPURIOUS EMISSIONS.....	35
9.7. RADIATED RESTRICTED BAND EDGES.....	41
9.8. RECEIVER SPURIOUS EMISSION	42
9.9. POWERLINE CONDUCTED EMISSIONS	44
10. LIST OF TEST EQUIPMENT	46
APPENDIX A. TEST SETUP PHOTOS	47
APPENDIX B. PHOTOGRAPHS OF EUT	48

1. GENERAL INFORMATION

EUT DESCRIPTION

Model	TRB200
EUT Type	Wi-Fi/BLE Module
Power Supply	3.0 – 3.6 VDC
RF Specification	WIFI 2.4 GHz : IEEE 802.11b/g, 802.11n HT20, 802.11n HT40 (SISO) Bluetooth LE (1Mbps) Bluetooth BDR/EDR
Operating Environment	Indoor and outdoor
Operating Temperature	-40 °C ~ +85 °C

RF SPECIFICATION SUBJECT TO THE REPORT

RF Specification	Bluetooth LE (1 Mbps)
Transmitter Chain	1
Frequency Range	2402 MHz - 2480 MHz
Max. RF Output Power	1.969 dBm (1.574 mW)
Modulation Type	GFSK
Number of Channels	40 Channels
Antenna Specification ¹⁾	Antenna Type : Chip Antenna Peak Gain : 1.5 dBi
Firmware Version ²⁾	3.70.0
Hardware Version ²⁾	v1.1
Date(s) of Tests	January 29, 2021 ~ February 8, 2021

Note :

1. Antenna information is based on the document provided.
2. Firmware and Hardware Versions are provided by the client.

OPERATING FREQUENCY CHANNELS

Bluetooth LE					
Channel	Frequency (MHz)	Channel	Frequency (MHz)	Channel	Frequency (MHz)
0	2402	14	2430	28	2458
1	2404	15	2432	29	2460
2	2406	16	2434	30	2462
3	2408	17	2436	31	2464
4	2410	18	2438	32	2466
5	2412	19	2440	33	2468
6	2414	20	2442	34	2470
7	2416	21	2444	35	2472
8	2418	22	2446	36	2474
9	2420	23	2448	37	2476
10	2422	24	2450	38	2478
11	2424	25	2452	39	2480
12	2426	26	2454	-	-
13	2428	27	2456	-	-

2. METHODOLOGY

FCC KDB 558074 D01 DTS Measurement Guidance v05r02 dated April 2nd, 2019 entitled "Guidance for Performing Compliance Measurements on Digital Transmission Systems (DTS) and the measurement procedure described in ANSI C63.10(Version : 2013) 'the American National Standard of Procedures for Compliance Testing of Unlicensed Wireless Devices'.

EUT CONFIGURATION

The EUT configuration for testing is installed on RF field strength measurement to meet the Commissions requirement and operating in a manner that intends to maximize its emission characteristics in a continuous normal application.

EUT EXERCISE

The EUT was operated in the engineering mode to fix the Tx frequency that was for the purpose of the measurements. According to its specifications, the EUT must comply with the requirements of the Section 15.207, 15.209 and 15.247 under the FCC Rules Part 15 Subpart C / the RSS-GEN issue 5, RSS-247 issue 2.

GENERAL TEST PROCEDURES

Conducted Emissions

The EUT is placed on the turntable, which is 0.8 m above ground plane. According to the requirements in Section 6.2 of ANSI C63.10. (Version :2013) Conducted emissions from the EUT measured in the frequency range between 0.15 MHz and 30MHz using CISPR Quasi-peak and average detector modes.

Radiated Emissions

The EUT is placed on a turn table, which is 0.8 m above ground plane below 1GHz. Above 1GHz with 1.5m using absorbers between the EUT and receive antenna. The turntable shall rotate 360 degrees to determine the position of maximum emission level. EUT is set 3 m away from the receiving antenna, which varied from 1 m to 4 m to find out the highest emission. Also, each emission was to be maximized by changing the polarization of receiving antenna both horizontal and vertical. In order to find out the maximum emission, the relative positions of this hand-held transmitter (EUT) were rotated through three orthogonal axes according to the requirements in Section 8 of ANSI C63.10. (Version: 2013)

Conducted Antenna Terminal

KDB 558074 D01 v05r02

DESCRIPTION OF TEST MODES

The EUT has been tested at BLE test mode. The channels, output power setting, continuous TX and normal RX mode were controlled using ESP tools provided by the wireless chipset manufacturer. The EUT is equipped with Bluetooth V4.2 LE with the data rate 1 Mbps.

3. INSTRUMENT CALIBRATION

The measuring equipment, which was utilized in performing the tests documented herein, has been calibrated in accordance with the manufacturer's recommendations for utilizing calibration equipment's, which is traceable to recognized national standards. Especially, all antenna for measurement is calibrated in accordance with the requirements of C63.5 (Version : 2017).

4. FACILITIES AND ACCREDITATIONS

FACILITIES

The SAC (Semi-Anechoic Chamber) and conducted measurement facility used to collect the radiated data are located at 1726 Ringwood Avenue, San Jose, California 95131, USA.

The site is constructed in conformance with the requirements of ANSI C63.4. (Version :2014) and CISPR Publication 22.



EQUIPMENT

Radiated emissions are measured with one or more of the following types of Linearly polarized antennas: tuned dipole, bi-conical, log periodic, bi-log, and/or ridged waveguide, horn. Spectrum analyzers with pre-selectors and quasi-peak detectors are used to perform radiated measurements.

Conducted emissions are measured with Line Impedance Stabilization Networks and EMI Test Receivers. Calibrated wideband preamplifiers, coaxial cables, and coaxial attenuators are also used for making measurements.

All receiving equipment conforms to CISPR Publication 16-1, "Radio Interference Measuring Apparatus and Measurement Methods."

5. ANTENNA REQUIREMENTS

According to FCC 47 CFR §15.203:

“An intentional radiator antenna shall be designed to ensure that no antenna other than that furnished by the responsible party can be used with the device. The use of a permanently attached antenna or of an antenna that uses a unique coupling to the intentional radiator shall be considered sufficient to comply with the provisions of this section.”

- (1) The antenna of this E.U.T is permanently attached and there is no provision for connection to an external antenna.
- (2) The E.U.T Complies with the requirement of §15.203

According to RSS-Gen Issue 5 (Section 6.8) :

The applicant for equipment certification shall provide a list of all antenna types that may be used with the transmitter, where applicable (i.e. for transmitters with detachable antenna), indicating the maximum permissible antenna gain (in dBi) and the required impedance for each antenna. The test report shall demonstrate the compliance of the transmitter with the limit for maximum equivalent isotropically radiated power (e.i.r.p.) specified in the applicable RSS, when the transmitter is equipped with any antenna type, selected from this list.

For expediting the testing, measurements may be performed using only the antenna with highest gain of each combination of transmitter and antenna type, with the transmitter output power set at the maximum level. However, the transmitter shall comply with the applicable requirements under all operational conditions and when in combination with any type of antenna from the list provided in the test report (and in the notice to be included in the user manual, provided below).

When measurements at the antenna port are used to determine the RF output power, the effective gain of the device's antenna shall be stated, based on a measurement or on data from the antenna's manufacturer.

The test report shall state the RF power, output power setting and spurious emission measurements with each antenna type that is used with the transmitter being tested.

6. MEASUREMENT UNCERTAINTY

The measurement uncertainties shown below were calculated in accordance with the requirements of ANSI C63.10-2013.

All measurement uncertainty values are shown with a coverage factor of $k = 2$ to indicate a 95 % level of confidence. The measurement data shown herein meets or exceeds the U_{CISPR} measurement uncertainty values specified in CISPR 16-4-2 and, thus, can be compared directly to specified limits to determine compliance.

Parameter	Expanded Uncertainty (\pm dB)
Conducted Disturbance (150 kHz ~ 30 MHz)	2.55
Radiated Disturbance (9 kHz ~ 30 MHz)	3.20
Radiated Disturbance (30 MHz ~ 1 GHz)	4.73
Radiated Disturbance (1 GHz ~ 18 GHz)	5.21
Radiated Disturbance (18 GHz ~ 40 GHz)	5.18

7. DESCRIPTION OF TESTS

7.1. DUTY CYCLE

Test Configuration

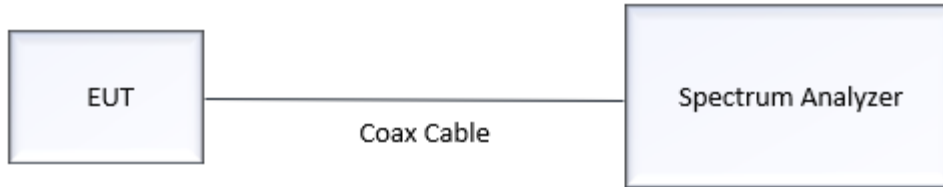

Test Procedure

The transmitter output is connected to the Spectrum Analyzer.

We tested according to the zero-span measurement method, 6 (b) in KDB 558074 D01 v05r02.

The largest available value of RBW is 8 MHz and VBW is 50 MHz.

The zero-span method of measuring duty cycle shall not be used if $T \leq 6.25$ microseconds. ($50/6.25 = 8$)

The zero-span method was used because all measured T data are > 6.25 microseconds and both RBW and VBW are $> 50/T$.

- RBW = 8 MHz (the largest available value)
- VBW = 8 MHz (\geq RBW)
- SPAN = 0 Hz
- Detector = Peak
- Number of points in sweep > 100
- Trace mode = Clear write
- Measure T_{total} and T_{on}
- Calculate Duty Cycle = T_{on} / T_{total} and Duty Cycle Factor = $10 * \log(1 / \text{Duty Cycle})$

7.2. 6 dB BANDWIDTH / 99% OCCUPIED BANDWIDTH

Limit

§15.247(a)(2) / RSS-247(Issue 2) Section 5.2.

The bandwidth at 6 dB down from the highest in-band spectral density is measured with a spectrum analyzer connected to the receive antenna while the EUT is operating in transmission mode at the appropriate frequencies.

The minimum permissible 6 dB bandwidth is 500 kHz.

Test Configuration

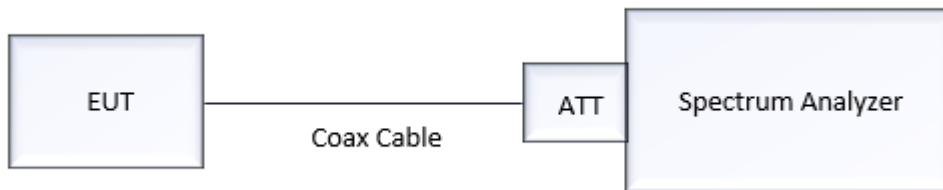

Test Procedure

The transmitter output is connected to the Spectrum Analyzer.

The Spectrum Analyzer is set to (Section 8.2 in KDB 558074 D01 v05r02, Subclause 11.8 in ANSI 63.10-2013)

- RBW = 100 kHz
- VBW $\geq 3 \times$ RBW
- Detector = Peak
- Trace mode = max hold
- Sweep = auto couple
- Allow the trace to stabilize
- We tested 6 dB bandwidth using the automatic bandwidth measurement capability of a spectrum analyzer, setting X dB as 6 dB.

TEST PROCEDURE (99% Bandwidth) for ISED

The transmitter output is connected to the spectrum analyzer.

- RBW = 1% ~ 5% of the occupied bandwidth
- VBW $\approx 3 \times$ RBW
- Detector = Peak
- Trace mode = max hold
- Sweep = auto couple
- Allow the trace to stabilize

Note :

We tested OBW using the automatic bandwidth measurement capability of a spectrum analyzer.

7.3. OUTPUT POWER

Limit

§15.247(b)(3) / RSS-247(Issue2) Section 5.4.4.

The maximum permissible conducted output power is 1 Watt.

Test Configuration

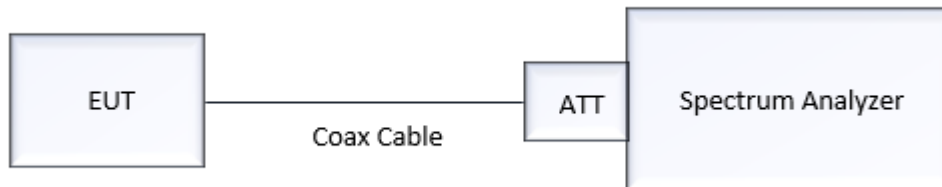

Test Procedure

The transmitter output is connected to the Spectrum Analyzer.
TX condition of the EUT is the actual operating mode by BT LE test program.
The Spectrum Analyzer is set to

Peak Power (Section 8.3.1.1 in KDB 558074 D01 v05r02, Subclause 11.9.1.1 in ANSI 63.10-2013)

- RBW \geq DTS Bandwidth
- VBW \geq 3 x RBW
- SPAN \geq 3 x RBW
- Detector Mode = Peak
- Sweep = auto couple
- Trace Mode = max hold
- Allow trace to fully stabilize.
- Use peak marker function to determine the peak amplitude level

Average Power (Section 8.3.2.2 in KDB 558074 D01 v05r02, Subclause 11.9.2.2 in ANSI 63.10-2013)

- We use the spectrum analyzer's integrated band power measurement function.
- Measure the duty cycle.
- Set span to at least 1.5 times the OBW.
- RBW = 1-5 % of the OBW, not to exceed 1 MHz
- VBW \geq 3 x RBW
- Number of points in sweep \geq 2 x span / RBW. (This gives bin-to-bin spacing \leq RBW/2, so that narrowband signals are not lost between frequency bins.)
- Sweep time = auto.
- Detector = RMS (i.e., power averaging)
- Do not use sweep triggering. Allow the sweep to "free run".
- Trace average at least 100 traces in power averaging (RMS) mode.
- Compute power by integrating the spectrum across the OBW of the signal using the instrument's band power measurement function with band limits set equal to the OBW band edges.
- Add $10 \log(1/x)$, where x is the duty cycle, to the measured power in order to compute the average power during the actual transmission times.

Sample Calculation

- Conducted Output Power (Peak) = Reading Value + ATT loss + Cable loss
- Conducted Output Power (Average) = Reading Value + ATT loss + Cable loss + Duty Cycle Factor

7.4. POWER SPECTRAL DENSITY

Limit

§15.247(e) / RSS-247(Issue 2) Section 5.2.

The transmitter power density average over 1-second interval shall not be greater than 8dBm in any 3kHz BW.

Test Configuration

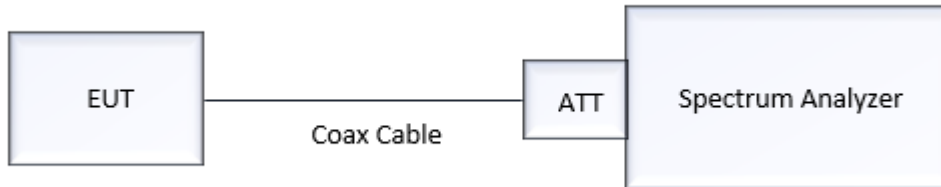

Test Procedure

The transmitter output is connected to the Spectrum Analyzer.

We tested according to Procedure 8.4 in KDB 558074 D01 v05r02, Procedure 11.10 in ANSI 63.10-2013.

The spectrum analyzer is set to :

- Set analyzer center frequency to DTS channel center frequency.
- Set span to at least 1.5 times the OBW.
- $RBW = 3 \text{ kHz} \leq RBW \leq 100 \text{ kHz}$.
- $VBW \geq 3 \times RBW$.
- Sweep = auto couple
- Detector = power averaging (rms) or sample detector (when rms not available).
- Ensure that the number of measurement points in the sweep $\geq [2 \times \text{span} / RBW]$.
- Employ trace averaging (rms) mode over a minimum of 100 traces
- Use the peak marker function to determine the maximum amplitude level.
- Use the peak marker function to determine the maximum amplitude level within the RBW. If measured value exceeds limit, reduce RBW (no less than 3 kHz) and repeat.
- if then duty factor shall be added to adjust the result if the duty cycle is less than 98%

7.5. CONDUCTED BAND EDGE (OUT OF BAND EMISSIONS) / CONDUCTED SPURIOUS EMISSIONS

Limit

§15.247(d) / RSS-247(Issue 2) Section 5.5.

The maximum conducted (peak) output power was used to demonstrate compliance, then the peak power in any 100 kHz bandwidth outside of the authorized frequency band shall be attenuated by at least 20 dB relative to the maximum in-band peak PSD level in 100 kHz.

[Conducted > 20 dBc]

Test Configuration

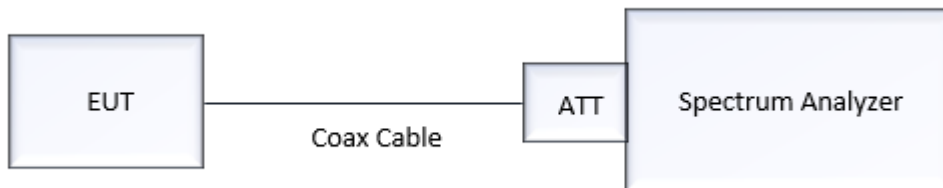

Test Procedure

The transmitter output is connected to the spectrum analyzer.

(Procedure 8.5 in KDB 558074 D01 v05r02, Procedure 11.11 in ANSI 63.10-2013)

- RBW = 100 kHz
- VBW $\geq 3 \times$ RBW
- Set span to encompass the spectrum to be examined
- Detector = Peak
- Trace Mode = max hold
- Sweep time = auto couple
- Ensure that the number of measurement points $\geq 2 \times$ Span/RBW
- Allow trace to fully stabilize.
- Use peak marker function to determine the maximum amplitude level.

Measurements are made over the 30 MHz to 25 GHz range with the transmitter set to the lowest, middle, and highest channels.

7.6. RADIATED EMISSIONS

Radiated Emission Limits

FCC : 47 CFR § 15.209		
Frequency (MHz)	Field Strength (uV/m)	Measurement Distance (m)
0.009 – 0.490	2400/F(kHz)	300
0.490 – 1.705	24000/F(kHz)	30
1.705 – 30	30	30
30-88	100	3
88-216	150	3
216-960	200	3
Above 960	500	3

ISED : RSS-GEN Section 8.9		
Frequency (MHz)	Field Strength (uV/m)	Measurement Distance (m)
0.009 – 0.490	6.37/F(kHz)	300
0.490 – 1.705	63.7/F(kHz)	30
1.705 – 30	0.08	30
30-88	100	3
88-216	150	3
216-960	200	3
Above 960	500	3

Receiver Radiated Emission Limits

ISED : RSS-GEN Section 7.3		
Frequency (MHz)	Field Strength (uV/m)	Measurement Distance (m)
30-88	100	3
88-216	150	3
216-960	200	3
Above 960	500	3

Restricted Bands of Operation

FCC : 47 CFR § 15.205(a)				
Frequency (MHz)	Frequency (MHz)	Frequency (MHz)	Frequency (MHz)	Frequency (MHz)
0.090 – 0.110	12.29-12.293	149.9 - 150.05	1660.0 - 1710.0	8025 – 8500
0.495 - 0.505	12.51975-12.52025	156.52475 - 156.52525	1718.8 - 1722.2	9000 – 9200
2.1735 – 2.1905	12.57675-12.57725	156.7 - 156.9	2200.0 - 2300.0	9300 – 9500
4.125 - 4.128	13.36-13.41	162.0125 - 167.17	2310.0 - 2390.0	10600 - 12700
4.17725-4.17775	16.42-16.423	167.72 - 173.2	2483.5 – 2500.0	13250 – 13400
4.20725-4.20775	16.69475-16.69525	240.0 - 285.0	2690.0 - 2900.0	14470 – 14500
6.215-6.218	16.80425-16.80475	322.0 - 335.4	3260.0 – 3267.0	15350 – 16200
6.26775-6.26825	25.5-25.67	399.9 - 410.0	3332.0 – 3339.0	17700 – 21400
6.31175-6.31225	37.5-38.25	608.0 - 614.0	3345.8 – 3358.0	22010 – 23120
8.291-8.294	73 - 74.6	960.0 - 1240.0	3600.0 – 4400.0	23600 – 24000
8.362-8.366	74.8 - 75.2	1300.0 - 1427.0	4500.0 – 5150.0	31200 – 31800
8.37625-8.38675	108 - 121.94	1435.0 - 1626.5	5350.0 – 5460.0	36430 – 36500
8.41425-8.41475	123 - 138	1645.5 - 1646.5	7250.0 – 7750.0	Above 38600

ISED : RSS-GEN Section 8.10				
Frequency (MHz)	Frequency (MHz)	Frequency (MHz)	Frequency (MHz)	Frequency (MHz)
0.090 - 0.110	8.37625 - 8.38675	108 – 138	1660 - 1710	8025 – 8500
0.495 - 0.505	8.41425 - 8.41475	149.9 - 150.05	1718.8 - 1722.2	9000 - 9200
2.1735 - 2.1905	12.29 - 12.293	156.52475 - 156.52525	2200 - 2300	9300 - 9500
3.020 - 3.026	12.51975 - 12.52025	156.7 - 156.9	2310 - 2390	10600 - 12700
4.125 - 4.128	12.57675 - 12.57725	162.0125 - 167.17	2483.5 - 2500	13250 – 13400
4.17725 - 4.17775	13.36 - 13.41	167.72 - 173.2	2655 - 2900	14470 – 14500
4.20725 - 4.20775	16.42 - 16.423	240 – 285	3260 – 3267	15350 – 16200
5.677 - 5.683	16.69475 - 16.69525	322 - 335.4	3332 - 3339	17700 – 21400
6.215 - 6.218	16.80425 - 16.80475	399.9 - 410	3345.8 - 3358	22010 – 23120
6.26775 - 6.26825	25.5 - 25.67	608 - 614	3500 - 4400	23600 – 24000
6.31175 - 6.31225	37.5 - 38.25	960 - 1427	4500 - 5150	31200 – 31800
8.291 - 8.294	73 - 74.6	1435 - 1626.5	5350 - 5460	36430 – 36500
8.362 - 8.366	74.8 - 75.2	1645.5 - 1646.5	7250 - 7750	Above 38600

Test Configuration

Below 30 MHz

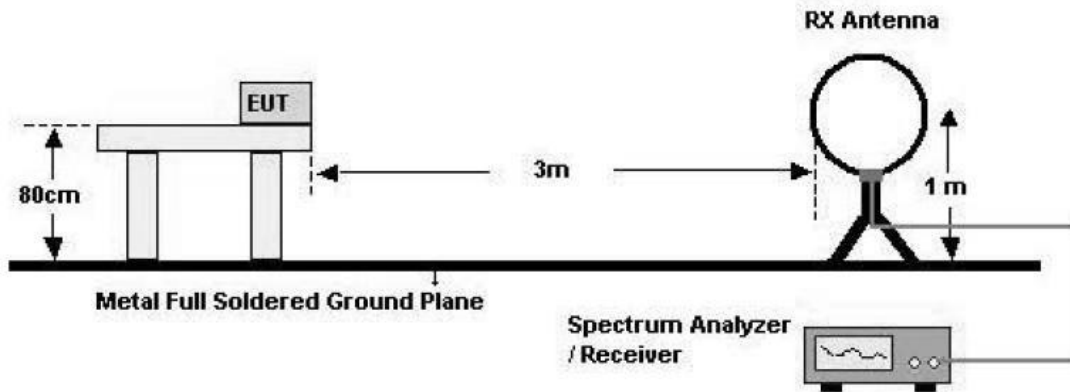

30 MHz - 1 GHz

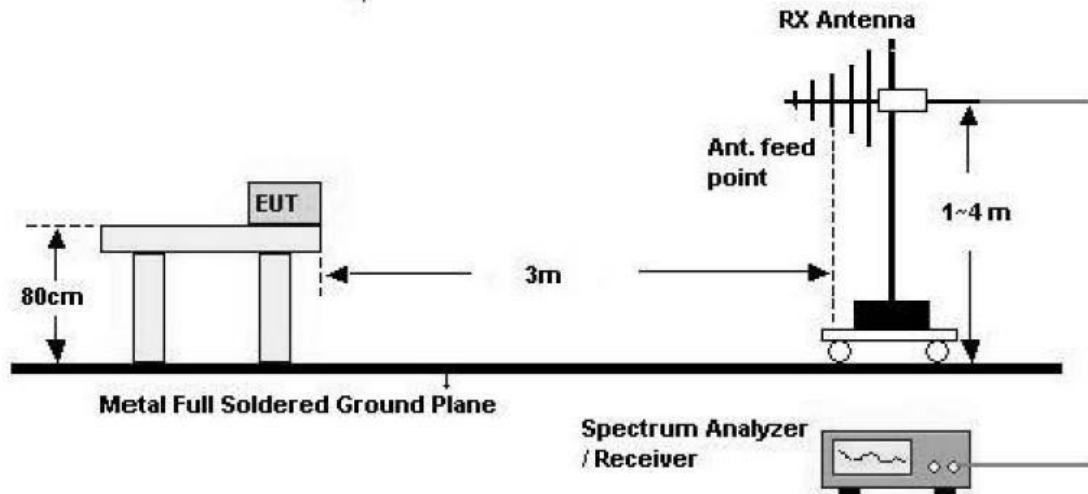

Above 1 GHz

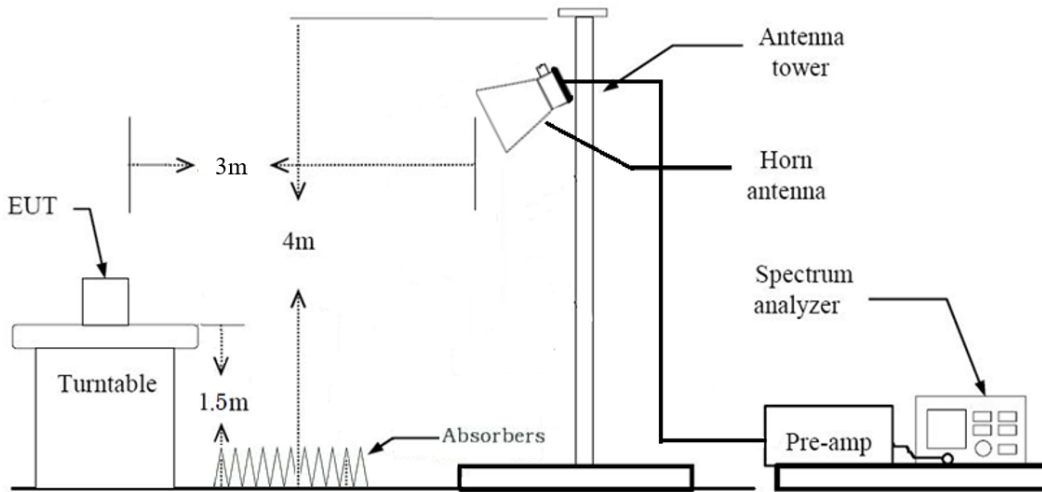

Test Procedure of Radiated spurious emissions (Below 30 MHz)

1. The EUT was placed on a non-conductive table located on semi-anechoic chamber.
2. The loop antenna was placed at a location 3m from the EUT
3. The EUT is placed on a turntable, which is 0.8m above ground plane.
4. We have done x, y, z planes in EUT and horizontal and vertical polarization in detecting antenna.
5. The turntable shall be rotated for 360 degrees to determine the position of maximum emission level.
6. Distance Correction Factor (0.009 MHz – 0.490 MHz) = $40 \cdot \log(3 \text{ m}/300 \text{ m}) = - 80 \text{ dB}$
Measurement Distance: 3 m
7. Distance Correction Factor (0.490 MHz – 30 MHz) = $40 \cdot \log(3 \text{ m}/30 \text{ m}) = - 40 \text{ dB}$
Measurement Distance: 3 m
8. Spectrum Analyzer Setting :
 - Frequency Range = 9 kHz ~ 30 MHz
 - Detector = Peak
 - Trace = Max hold
 - RBW = 9 kHz
 - VBW $\geq 3 \cdot \text{RBW}$
9. Total = Reading Value + Antenna Factor (A.F) + Cable Loss (C.L)
10. There is a comparison data both open-field test site and alternative test site – semi-Anechoic chamber according to 414788 D01. And the results are properly calibrated.

Test Procedure of Radiated spurious emissions (Below 1GHz)

1. The EUT was placed on a non-conductive table located on semi-anechoic chamber.
2. The EUT is placed on a turntable, which is 0.8 m above ground plane.
3. We have done x, y, z planes in EUT and horizontal and vertical polarization in detecting antenna.
4. The turntable shall be rotated for 360 degrees to determine the position of maximum emission level.
5. Spectrum Analyzer Setting :

(1) Measurement Type (Peak):

- Measured Frequency Range: 30 MHz – 1 GHz
- Detector = Peak
- Trace = Max hold
- RBW = 100 kHz
- VBW \geq 3*RBW

(2) Measurement Type(Quasi-peak):

- Measured Frequency Range: 30 MHz – 1 GHz
- Detector = Quasi-Peak
- RBW = 120 kHz

In general, the method (1) is mainly used

6. Total = Reading Value + Antenna Factor (A.F) + Cable Loss (C.L)

Test Procedure of Radiated spurious emissions (Above 1 GHz)

1. The EUT is placed on a turntable, which is 1.5 m above ground plane.
2. We have done x, y, z planes in EUT and horizontal and vertical polarization in detecting antenna.
3. The turntable shall be rotated for 360 degrees to determine the position of maximum emission level.
4. EUT is set 3 m away from the receiving antenna, which is varied from 1m to 4m to find out the highest emissions.
5. Maximum procedure was performed on the six highest emissions to ensure EUT compliance.
6. Each emission was to be maximized by changing the polarization of receiving antenna both horizontal and vertical.
7. The unit was tested with its standard battery.
8. Spectrum Analyzer Setting :

(1) Measurement Type(Peak):

- Measured Frequency Range : 1 GHz – 25 GHz
- Detector = Peak
- Trace = Max hold
- RBW = 1 MHz
- VBW $\geq 3 \times$ RBW

(2) Measurement Type(Average): Duty cycle $\geq 98\%$

- Measured Frequency Range : 1 GHz – 25 GHz
- Detector = RMS
- Averaging type = power (*i.e.*, RMS)
- RBW = 1 MHz
- VBW $\geq 3 \times$ RBW
- Sweep time = auto.
- Trace mode = average (at least 100 traces).

(3) Measurement Type(Average): Duty cycle < 98%, duty cycle variations are less than $\pm 2\%$

- Measured Frequency Range : 1 GHz – 25 GHz
- Detector = RMS
- Averaging type = power (*i.e.*, RMS)
- RBW = 1 MHz
- VBW $\geq 3 \times$ RBW
- Sweep time = auto.
- Trace mode = average (at least 100 traces).
- Correction factor shall be added to the measurement results prior to comparing to the emission limit to compute the emission level that would have been measured had the test been performed at 100 percent duty cycle.
- Duty Cycle Factor (dB) : Please refer to the please refer to section 9.1.

10. Measurement value only up to 6 maximum emissions noted or would be lesser if no specific emissions from the EUT are recorded (*i.e.*: margin > 20 dB from the applicable limit) and considered that is already beyond the background noise floor.

11. Sample Calculation

(1) Total (Peak) = Reading Value + Antenna Factor(A.F) + Cable Loss(C.L) - Amp Gain(G)

(2) Total (Average, Duty $\geq 98\%$) = Reading Value + Antenna Factor(A.F) + Cable Loss(C.L) - Amp Gain(G)

(3) Total (Average, Duty < 98%) = Reading Value + Antenna Factor(A.F) + Cable Loss(C.L) - Amp Gain(G) + Duty Cycle Factor

Test Procedure of Radiated Restricted Band Edge

1. Radiated test is performed with hopping off.
2. The EUT is placed on a turntable, which is 1.5 m above ground plane.
3. We have done x, y, z planes in EUT and horizontal and vertical polarization in detecting antenna.
4. The turntable shall be rotated for 360 degrees to determine the position of maximum emission level.
5. EUT is set 3 m away from the receiving antenna, which is varied from 1m to 4m to find out the highest emissions.
6. Each emission was to be maximized by changing the polarization of receiving antenna both horizontal and vertical.
7. The unit was tested with its standard battery.
8. Spectrum Analyzer Setting :

(1) Measurement Type(Peak):

- Detector = Peak
- Trace = Max hold
- RBW = 1 MHz
- VBW $\geq 3 \times$ RBW

(2) Measurement Type(Average): Duty cycle $\geq 98\%$,

- Measured Frequency Range : 2310 MHz – 2390 MHz / 2483.5 MHz – 2500 MHz
- Detector = RMS
- Averaging type = power (*i.e.*, RMS)
- RBW = 1 MHz
- VBW $\geq 3 \times$ RBW
- Sweep time = auto.
- Trace mode = average (at least 100 traces).

(3) Measurement Type(Average): Duty cycle $< 98\%$, duty cycle variations are less than $\pm 2\%$

- Measured Frequency Range : 2310 MHz – 2390 MHz / 2483.5 MHz – 2500 MHz
- Detector = RMS
- Averaging type = power (*i.e.*, RMS)
- RBW = 1 MHz
- VBW $\geq 3 \times$ RBW
- Sweep time = auto.
- Trace mode = average (at least 100 traces).
- Correction factor shall be added to the measurement results prior to comparing to the emission limit in order to compute the emission level that would have been measured had the test been performed at 100 percent duty cycle.
- Duty Cycle Factor (dB) : Please refer to the please refer to section 9.1.

9. Measurement value only up to 6 maximum emissions noted or would be lesser if no specific emissions from the EUT are recorded (*i.e.*: margin > 20 dB from the applicable limit) and considered that's already beyond the background noise floor.

10. Sample Calculation

(1) Total (Peak) = Reading Value + Antenna Factor(A.F) + Cable Loss(C.L)

(2) Total (Average, Duty $\geq 98\%$) = Reading Value + Antenna Factor(A.F) + Cable Loss(C.L) - Amp Gain(G)

(3) Total (Average, Duty $< 98\%$) = Reading Value + Antenna Factor(A.F) + Cable Loss(C.L) - Amp Gain(G) + Duty Cycle Factor

7.7. AC POWER LINE CONDUCTED EMISSIONS

Limit

47 CFR § 15.207, RSS-GEN Section 8.8

For an intentional radiator that is designed to be connected to the public utility (AC) power line, the radio frequency voltage that is conducted back onto the AC power line on any frequency or frequencies, within the band 150 kHz to 30 MHz, shall not exceed the limits in the following table, as measured using a 50 μ H/50 ohms line impedance stabilization network (LISN).

Frequency Range (MHz)	Limits (dB μ V)	
	Quasi-peak	Average
0.15 to 0.50	66 to 56*	56 to 46*
0.50 to 5	56	46
5 to 30	60	50

*Decreases with the logarithm of the frequency.

Compliance with this provision shall be based on the measurement of the radio frequency voltage between each power line (LINE and NEUTRAL) and ground at the power terminals.

Test Configuration

See test photographs attached in Annex A for the actual connections between EUT and support equipment.

Test Procedure

1. The EUT is placed on a wooden table 80 cm above the reference ground plane.
2. The EUT is connected via LISN to a test power supply.
3. The measurement results are obtained as described below:
4. Detectors : Quasi Peak and Average Detector.

According to FCC KDB 174176 D01 Line Conducted FAQ v01r01 :

Devices Operating Above 30 MHz

For a device with a permanent or detachable antenna operating above 30 MHz, measurements must be performed with the antenna connected as specified in clause 6.2 of ANSI C63.10-2013.

Devices Operating Below 30 MHz

For a device with a permanent or detachable antenna operating at or below 30 MHz, the FCC will accept measurements performed with a suitable dummy load in lieu of the antenna under the following conditions:

- (1) Perform the AC power-line conducted tests with the antenna connected to determine compliance with Section 15.207 limits outside the transmitter's fundamental emission band;
- (2) Retest with a dummy load in lieu of the antenna to determine compliance with Section 15.207 limits within the transmitter's fundamental emission band. For a detachable antenna, remove the antenna and connect a suitable dummy load to the antenna connector. For a permanent antenna, remove the antenna and terminate the RF output with a dummy load or network which simulates the antenna in the fundamental frequency band. All measurements must be performed as specified in clause 6.2 of ANSI C63.10-2013.

Sample Calculation

Quasi-peak(Final Result) = Reading Value + Correction Factor

8. SUMMARY OF TEST RESULTS

Test Description	FCC Part Section(s)	ISED Part Section(s)	Test Limit	Test Condition	Test Result
6 dB Bandwidth	§15.247(a)(2)	RSS-247, 5.2.(a)	≥ 500 kHz	Conducted	PASS
Occupied Bandwidth	-	RSS-GEN, 6.7	-		PASS
Conducted Maximum Peak Output Power	§15.247(b)(3)	RSS-247, 5.4.(d)	≤ 1 W		PASS
Maximum e.i.r.p.	-	RSS-247, 5.4.(d)	≤ 4 W e.i.r.p.		PASS
Power Spectral Density	§15.247(e)	RSS-247, 5.2.(b)	≤ 8 dBm / 3 kHz		PASS
Band Edge (Out of Band missions)	§15.247(d)	RSS-247, 5.5	≥ 20 dBc		PASS
AC Power line Conducted Emissions	§15.207	RSS-GEN, 8.8	cf. Section 7.7		PASS
Radiated Spurious Emissions	§15.247(d) §15.209	RSS-GEN, 8.9	cf. Section 7.6	Radiated	PASS
Radiated Restricted Band Edge	§15.247(d) §15.205(a)	RSS-GEN, 8.10	cf. Section 7.6		PASS
Receiver Spurious Emissions	-	RSS-GEN, 7.3	cf. Section 7.6		PASS

WORST CASE CONFIGURATION

Radiated test

1. EUT Axis

All X, Y, and Z positions for horizontal / vertical antenna polarization were investigated to find the worst-case position. Y position was selected for the final evaluation.

Conducted test

1. AC Line Conducted Emission test was performed at BLE continuous Tx mode.

OUTPUT POWER SETTING

PLS is set to 8 for all the channels.

TEST CONFIGURATION

Radiated Emission

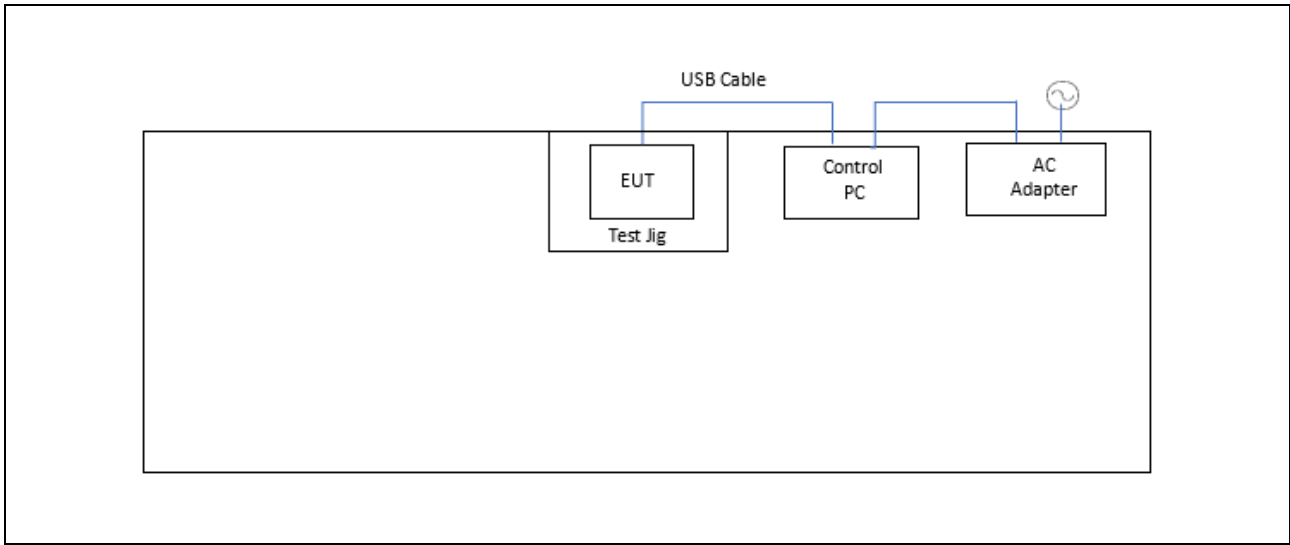

Conducted Emission

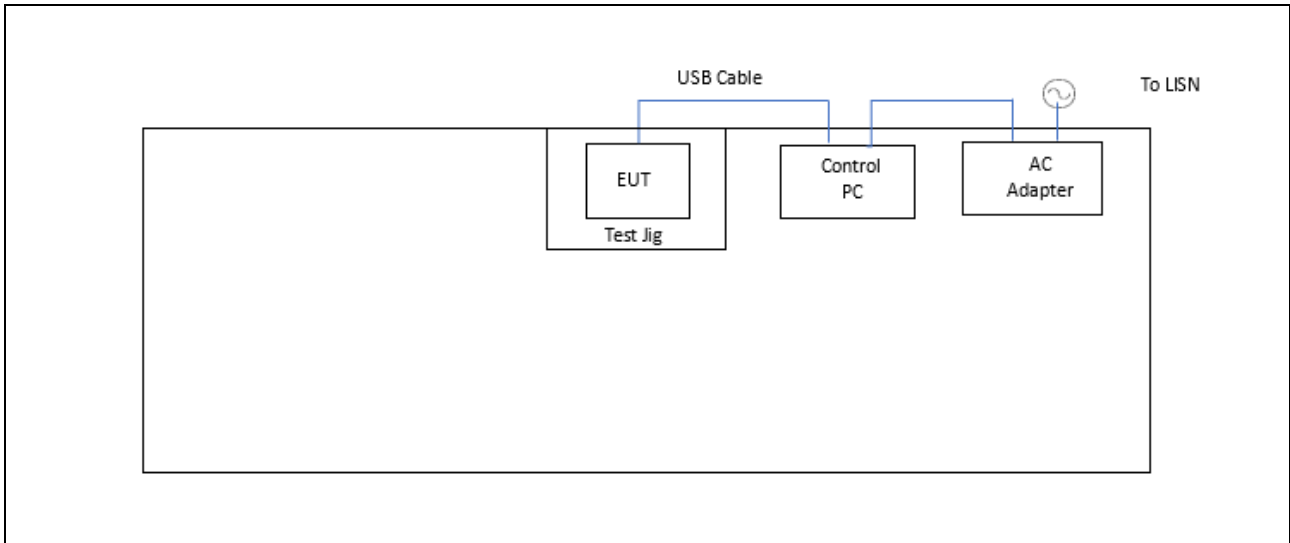

LIST OF SUPPORT EQUIPMENT

Equipment Type	Model No.	Serial Number	Manufacturer	Qty	Note
Laptop	T450	TA181240	Lenovo	1	-
AC Adapter	ADLX65SDC2A	36200350	Delta	1	100-240 VAC, 1.5A 50-60Hz (20 VDC)
USB Cable (mini)	-	-	-	1	0.5 m length
Test Jig Board	FTDI TOOL (w/ F232RL)	-	Crius	1	FTDI board USB-TTL 3.3V 5V

9. TEST RESULT

9.1. DUTY CYCLE

Mode	Data Rate	T _{on} (ms)	T _{total} (ms)	Duty Cycle	Duty Factor (dB)
BLE (GFSK)	1 Mbps	2.10	2.50	0.84	0.77

▣ TEST PLOTS

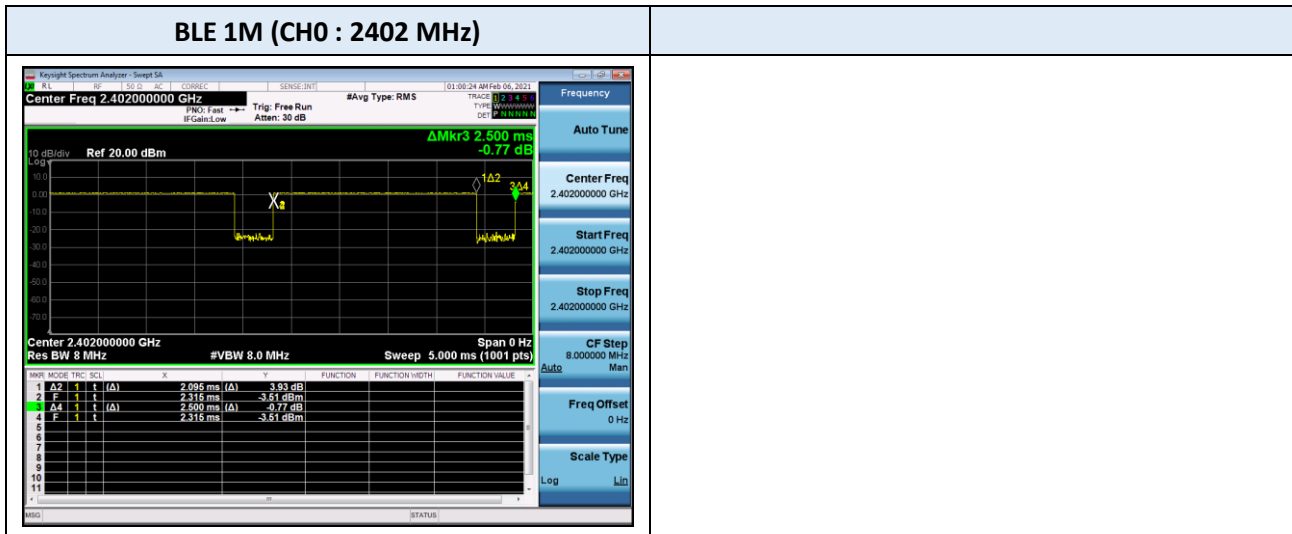

9.2. 6 dB BANDWIDTH / 99% BANDWIDTH MEASUREMENT

BLE 1M (GFSK)		99% Bandwidth (kHz)	6 dB Bandwidth (kHz)	
Frequency (MHz)	Channel	Result	Result	Limit
2402	0	1018.9	650.5	≥ 500
2440	19	1016.5	651.5	
2480	39	1018.1	648.7	

TEST PLOTS

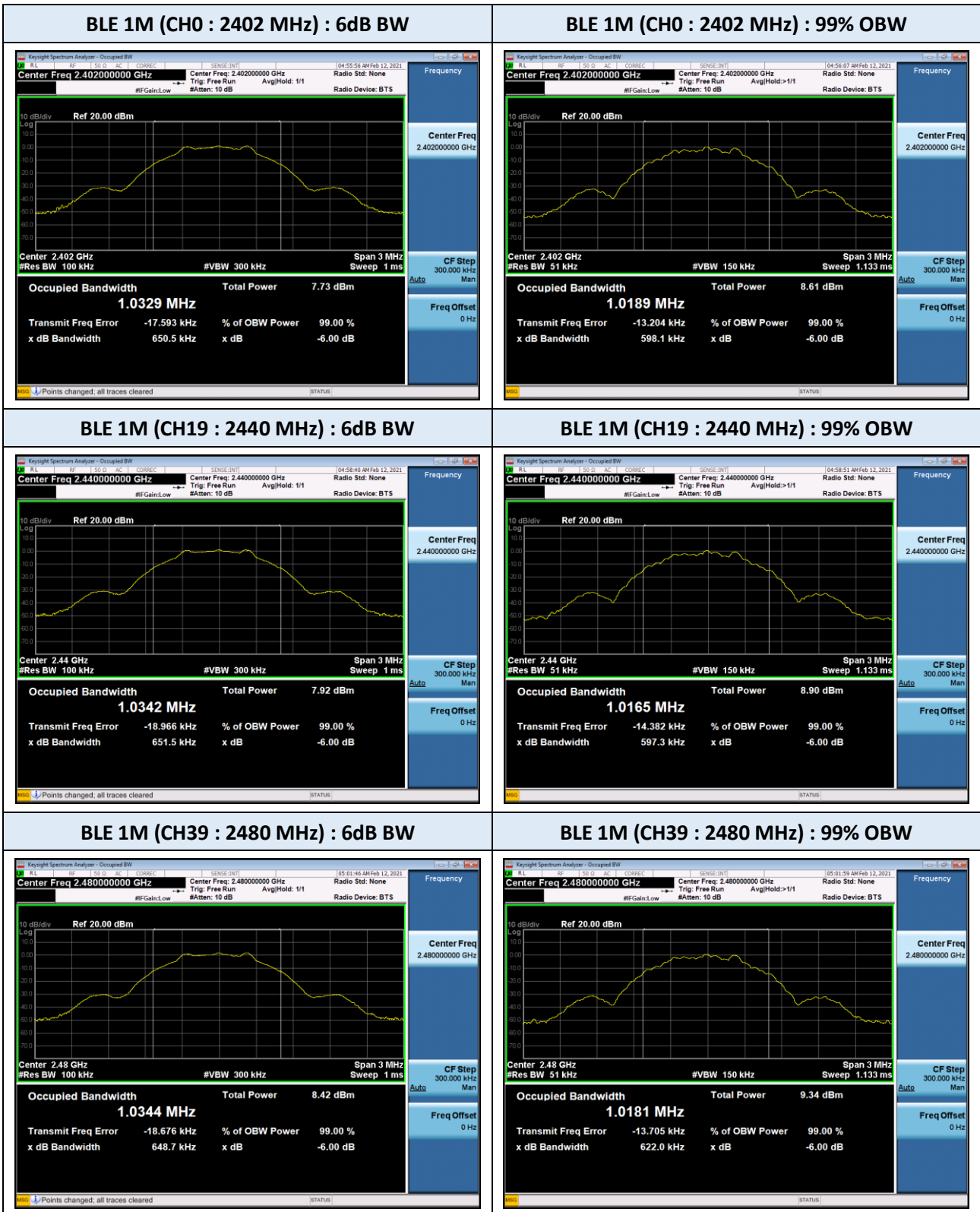

9.3. OUTPUT POWER

Peak Power

BLE 1M (GFSK)		Test Result		
Frequency (MHz)	Channel No.	Measured Power (dBm)	Limit (dBm)	Result
2402	0	1.242	30	Compliant
2440	19	1.493	30	Compliant
2480	39	1.969	30	Compliant

Note :

- The output power results in plot include the spectrum offset, which is a combination loss of the attenuator and the cable used for testing.

TEST PLOTS

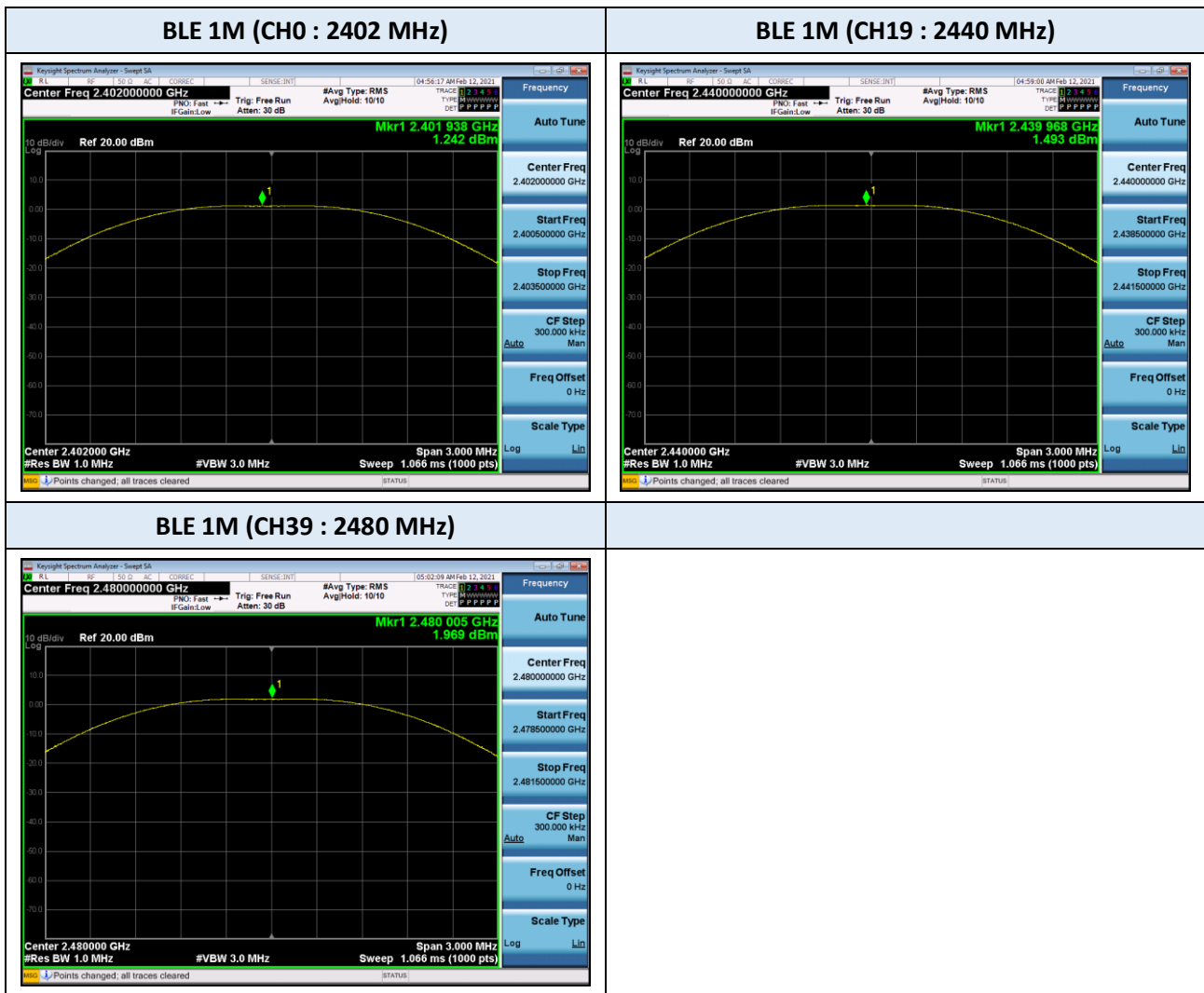

9.4. POWER SPECTRAL DENSITY

BLE 1M (GFSK)		Test Result		
Frequency (MHz)	Channel No.	Measured Level (dBm/3kHz)	Limit (dBm/3kHz)	Result
2402	0	-14.605	≤ 8.000	Compliant
2440	19	-13.995	≤ 8.000	Compliant
2480	39	-13.513	≤ 8.000	Compliant

Note :

1. The output power results in plot include the spectrum offset, which is a combination loss of the attenuator and the cable used for testing

TET PLOTS

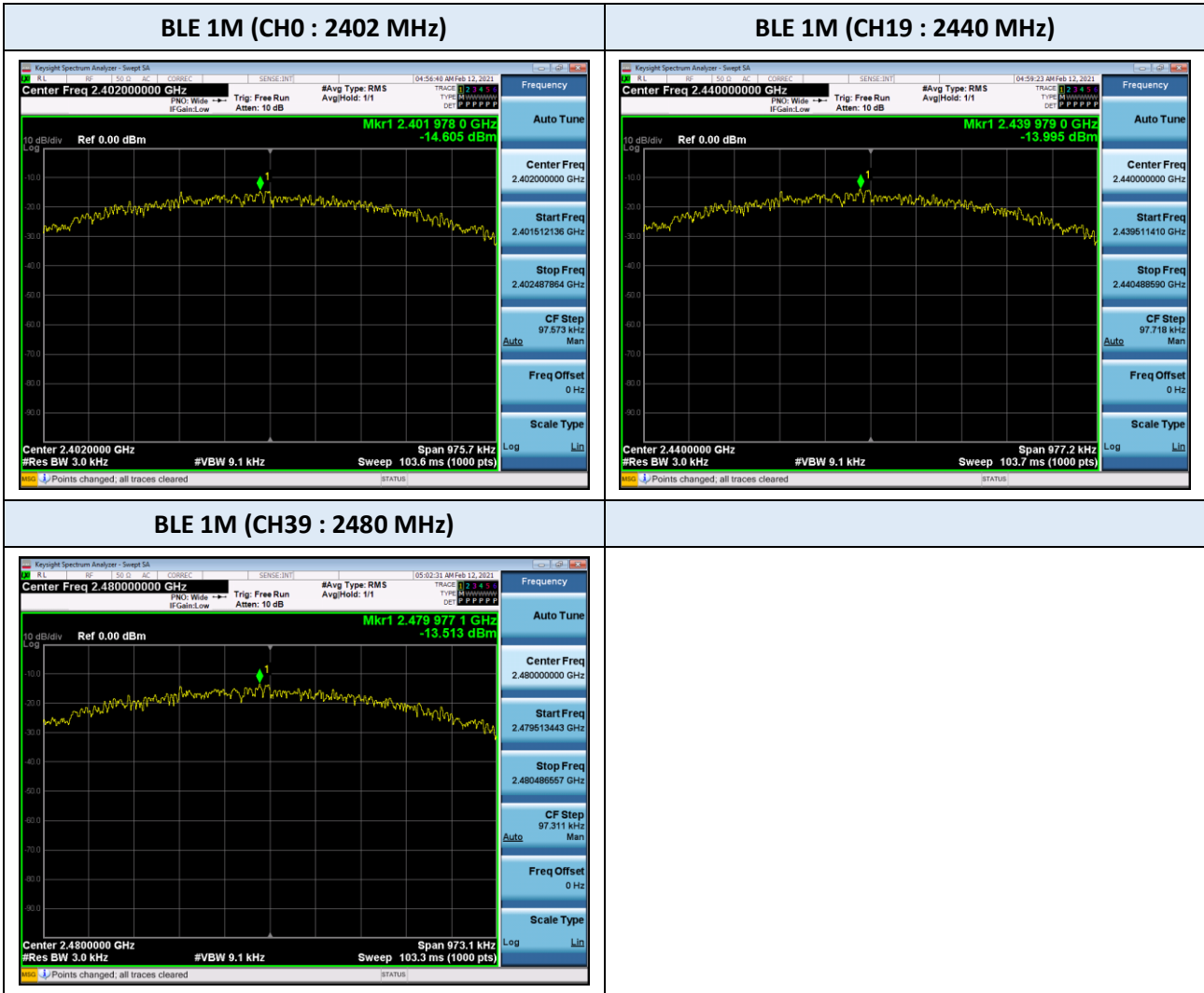

9.5. CONDUCTED BAND EDGE & SPURIOUS EMISSIONS

Out of Band Emissions at the Band Edge

BLE 1M (GFSK)			Test Result		
Frequency [MHz]	Channel No.	Position	Measured Level [dB]	Limit [dBc]	Result
2402	0	Low	38.621	≥ 20	Compliant
2480	39	High	40.845	≥ 20	Compliant

TEST PLOTS

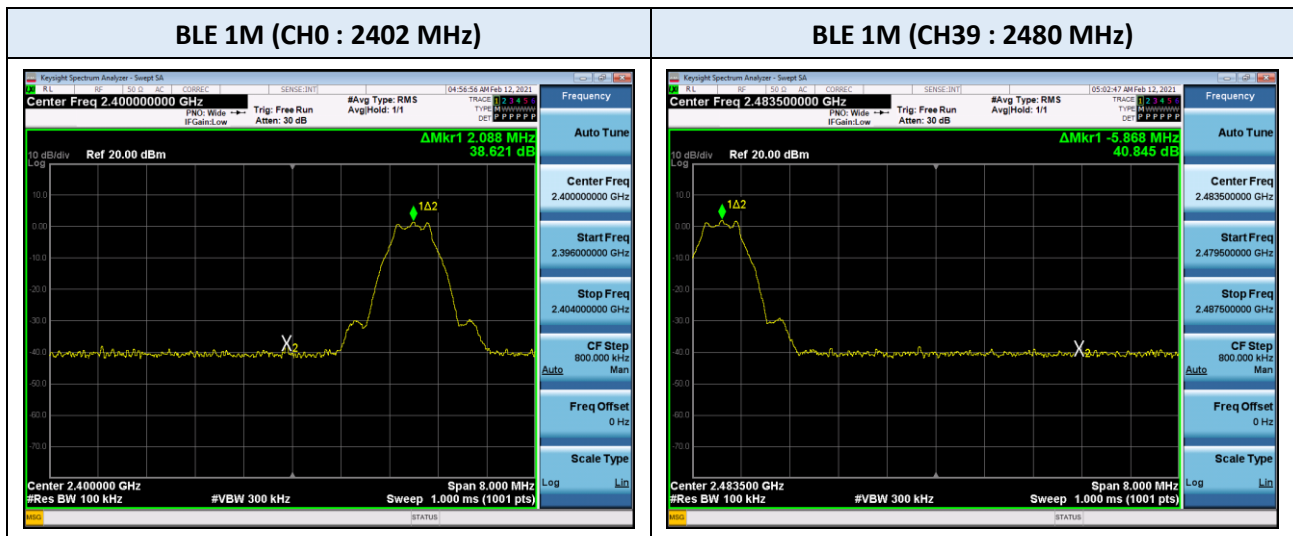

Conducted Spurious Emissions

BLE 1M (GFSK)			Test Result		
Frequency [MHz]	Channel No.	Position	Measured Level [dBc]	Limit [dBc]	Result
2402	0	Low	45.137	≥ 20	Compliant
2440	19	Middle	46.236	≥ 20	Compliant
2480	39	High	47.031	≥ 20	Compliant

TEST PLOTS

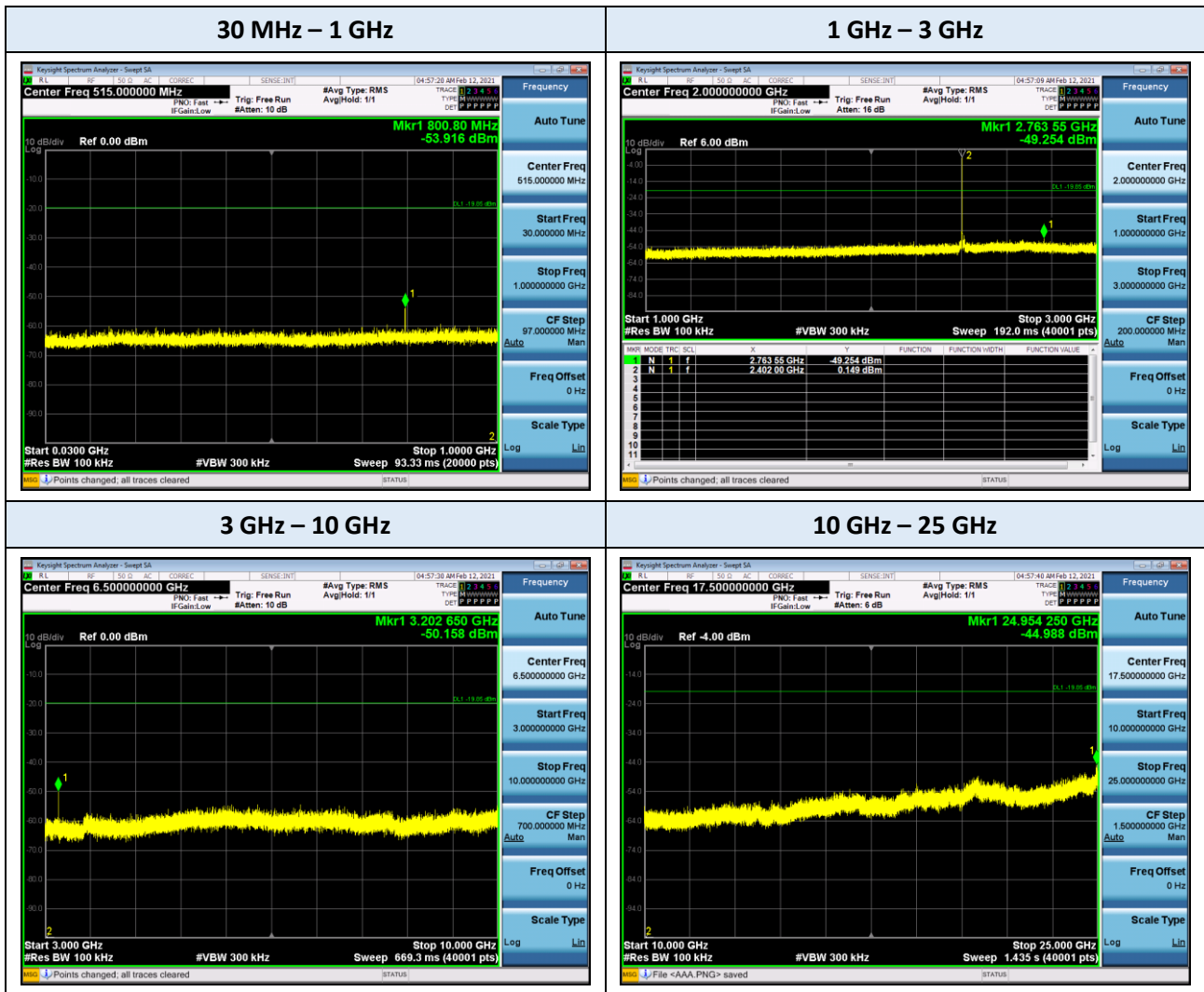

Note:

The plots included in this report are only at the worst-case channel.

9.6. RADIATED SPURIOUS EMISSIONS

Frequency Range : 9 kHz – 30 MHz

Test Mode BLE 1M (GFSK) : TX mode
Operating Frequency 2437 MHz

Frequency (MHz)	Polarization	Reading (dBuV)	Corr. ¹⁾ (dB)	Total (dBuV/m)	Limit (dBuV/m)	Margin (dB)	Measurement Type
0.615	180°	28.0	14.8	42.8	71.8	29.0	QP
0.732	90°	26.5	14.8	41.3	70.3	29.0	QP
11.059	90°	19.1	14.9	34.0	69.5	35.5	QP

Notes:

1. Correction Factor: Antenna Factor + Cable loss
2. Limit line = Specific Limits (dBuV) + Distance extrapolation factor
3. Distance extrapolation factor = $40 \log(\text{specific distance} / \text{test distance})$ (dB)
4. The measurement distance is 3 meters.
5. The other Frequencies are attenuated more than 20 dB below the permissible limits.
The worst-case result is included in this report.

Frequency Range : Below 1 GHz

Test Mode BLE 1M (GFSK) : TX mode
 Operating Frequency 2402 MHz

Frequency (MHz)	Polarization	Reading (dBuV)	Corr. ¹⁾ (dB)	Total (dBuV/m)	Limit (dBuV/m)	Margin (dB)	Measurement Type
62.564	V	36.3	-12.9	23.4	40	16.6	QP
167.714	H	31.0	-8.7	22.3	43.5	21.2	QP

Test Mode BLE 1M (GFSK) : TX mode
 Operating Frequency 2440 MHz

Frequency (MHz)	Polarization	Reading (dBuV)	Corr. ¹⁾ (dB)	Total (dBuV/m)	Limit (dBuV/m)	Margin (dB)	Measurement Type
62.441	V	35.6	-12.9	22.7	40	17.3	QP
165.548	H	31.7	-8.6	23.1	43.5	20.4	QP

Test Mode BLE 1M (GFSK) : TX mode
 Operating Frequency 2480 MHz

Frequency (MHz)	Polarization	Reading (dBuV)	Corr. ¹⁾ (dB)	Total (dBuV/m)	Limit (dBuV/m)	Margin (dB)	Measurement Type
63.056	V	36.3	-12.8	23.5	40	16.5	QP
163.871	H	32.1	-8.5	23.6	43.5	19.9	QP

Notes:

1. Correction Factor: Antenna Factor + Cable loss + Preamplifier Gain

Frequency Range : Above 1 GHz

Test Mode BLE 1M (GFSK) : TX mode
 Operating Frequency 2402 MHz

Frequency (MHz)	Polarization	Reading (dBuV)		Factor (dB)		Level (dBuV/m)		Limit (dBuV/m)		Margin (dB)	
		AV	PK	Corr. ¹⁾	Duty	AV	PK	AV	PK	AV	PK
3202.665	V	56.6	57.6	-9.3	-	47.3	48.3	54	74	6.7	25.7
3202.677	H	55.0	56.1	-9.3	-	45.7	46.8	54	74	8.3	27.2
4803.555	H	40.5	46.7	-6.3	0.77	35.0	40.4	54	74	19.0	33.6
4804.493	V	42.1	48.5	-6.3	0.77	36.6	42.2	54	74	17.4	31.8

Test Mode BLE 1M (GFSK) : TX mode
 Operating Frequency 2440 MHz

Frequency (MHz)	Polarization	Reading (dBuV)		Factor (dB)		Level (dBuV/m)		Limit (dBuV/m)		Margin (dB)	
		AV	PK	Corr. ¹⁾	Duty	AV	PK	AV	PK	AV	PK
3253.299	H	55.0	56.2	-9.0	-	46.0	47.2	54	74	8.0	26.8
3253.353	V	56.3	57.3	-9.0	-	47.3	48.3	54	74	6.7	25.7
4879.487	V	44.9	51.3	-6.1	0.77	39.6	45.2	54	74	14.4	28.8
4879.542	H	43.4	49.4	-6.1	0.77	38.1	43.3	54	74	15.9	30.7
7319.275	H	38.2	45.0	-0.2	0.77	38.8	44.8	54	74	15.2	29.2
7319.384	V	39.4	46.3	-0.2	0.77	40.0	46.1	54	74	14.0	27.9

Test Mode BLE 1M (GFSK) : TX mode
 Operating Frequency 2480 MHz

Frequency (MHz)	Polarization	Reading (dBuV)		Factor (dB)		Level (dBuV/m)		Limit (dBuV/m)		Margin (dB)	
		AV	PK	Corr. ¹⁾	Duty	AV	PK	AV	PK	AV	PK
3306.640	V	54.5	55.7	-8.7	-	45.8	47.0	54	74	8.2	27.0
3306.691	H	52.8	54.5	-8.7	-	44.1	45.8	54	74	9.9	28.2
4959.582	H	43.3	49.2	-5.9	0.77	38.2	43.3	54	74	15.8	30.7
4959.589	V	44.4	50.0	-5.9	0.77	39.3	44.1	54	74	14.7	29.9

Notes:

1. Correction Factor: Antenna Factor + Cable loss + Preamplifier Gain

▣ TEST PLOTS

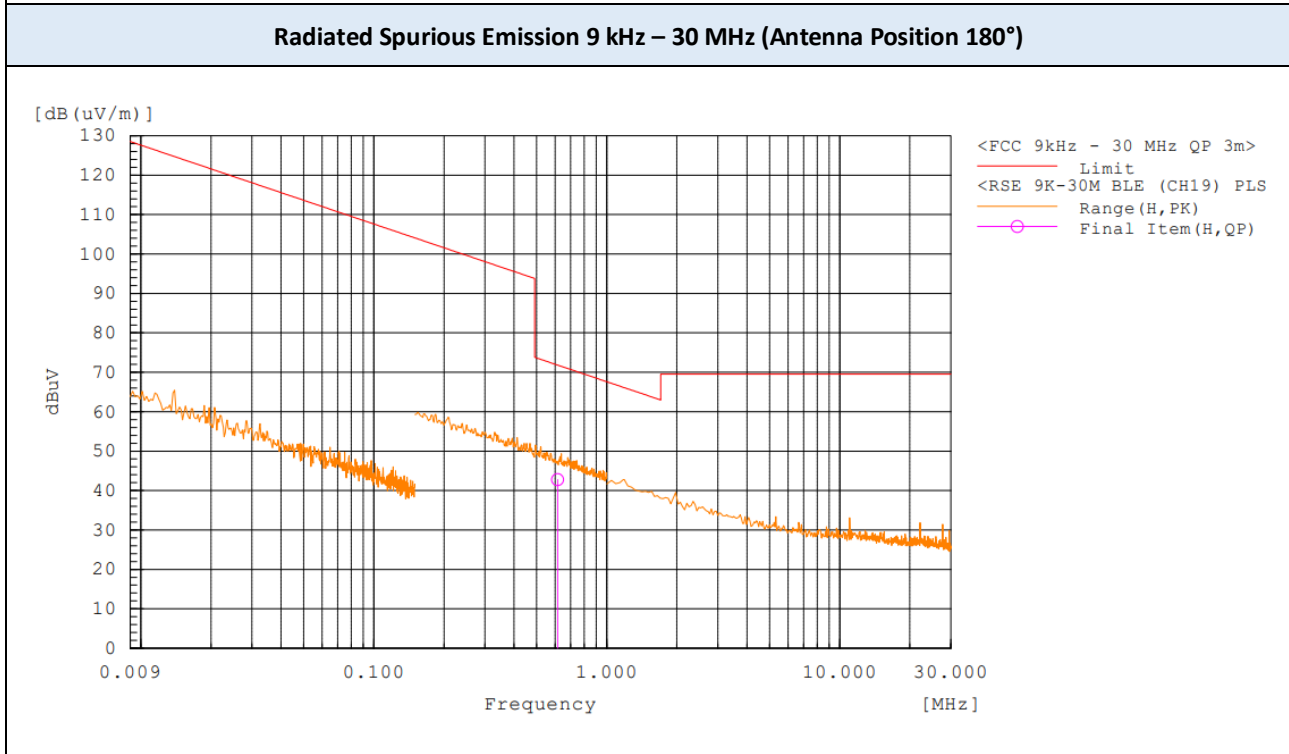
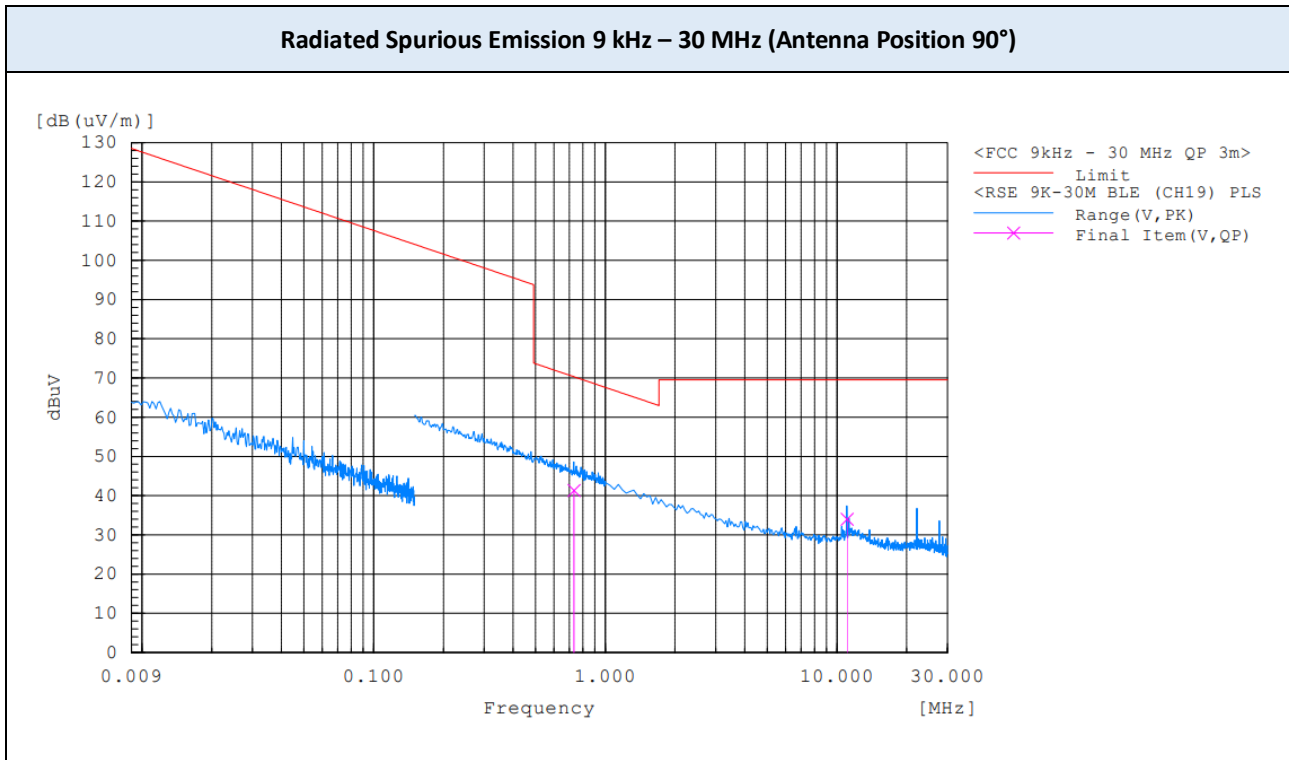

Note:
The worst-case plots are included in this report.

▣ TEST PLOTS

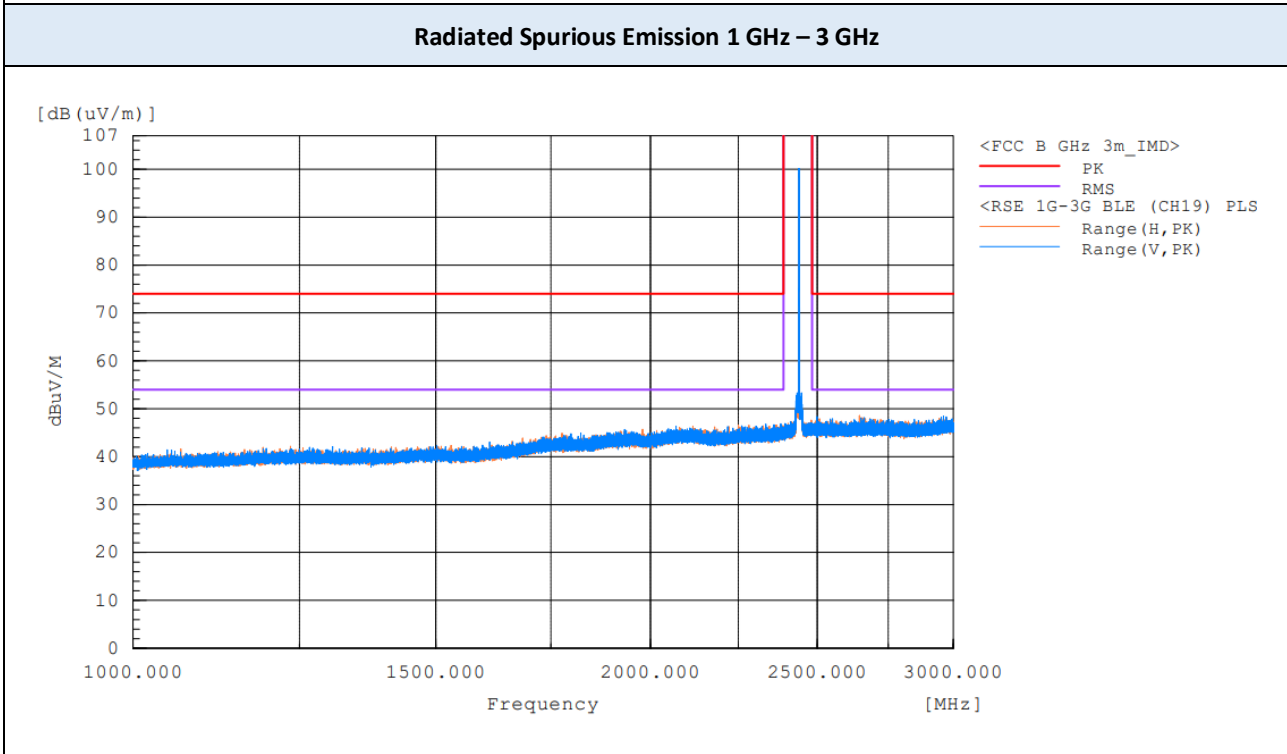
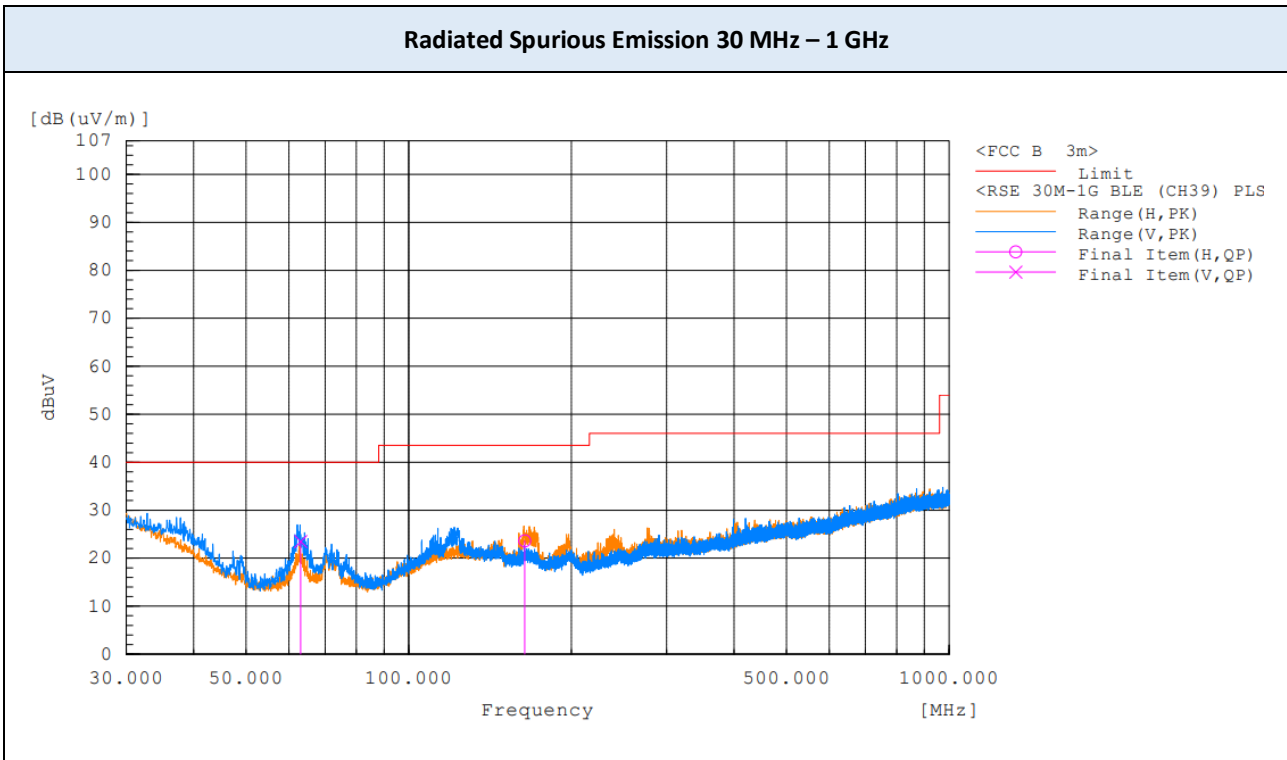

Note:
The worst-case plots are included in this report.

▣ TEST PLOTS

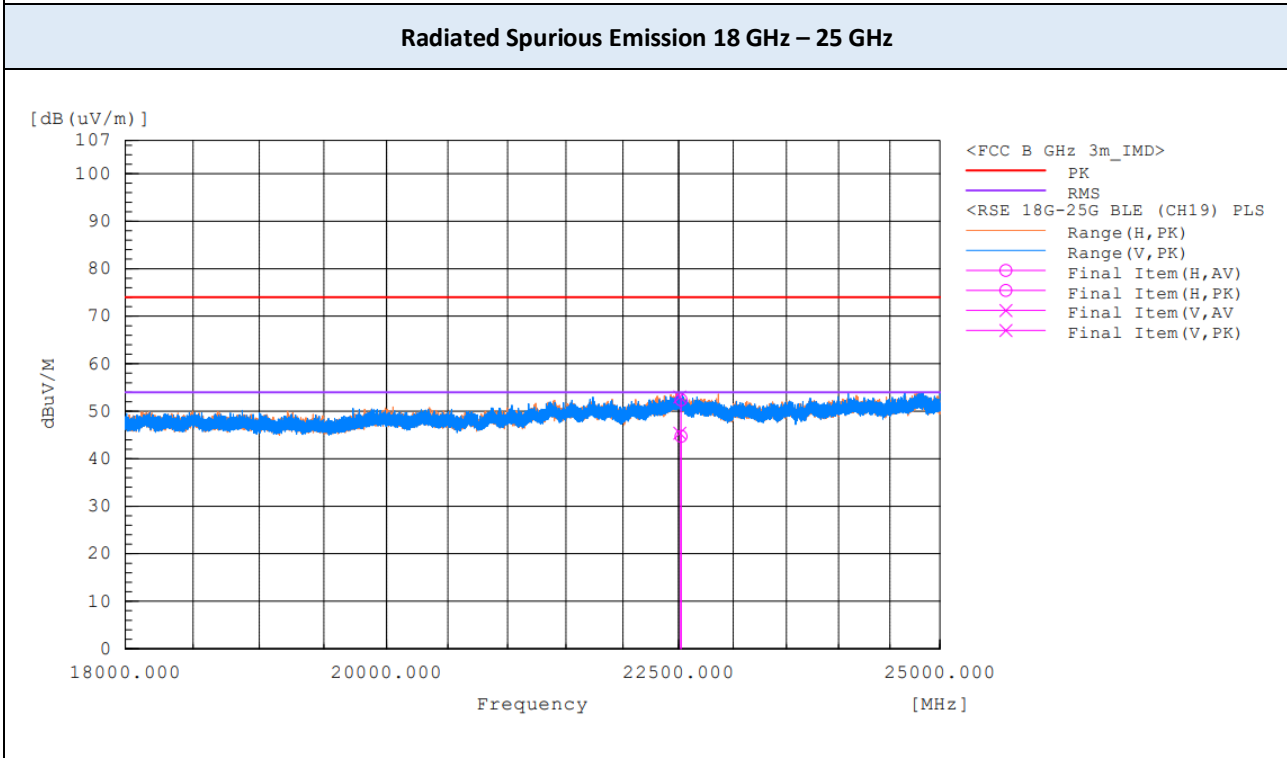
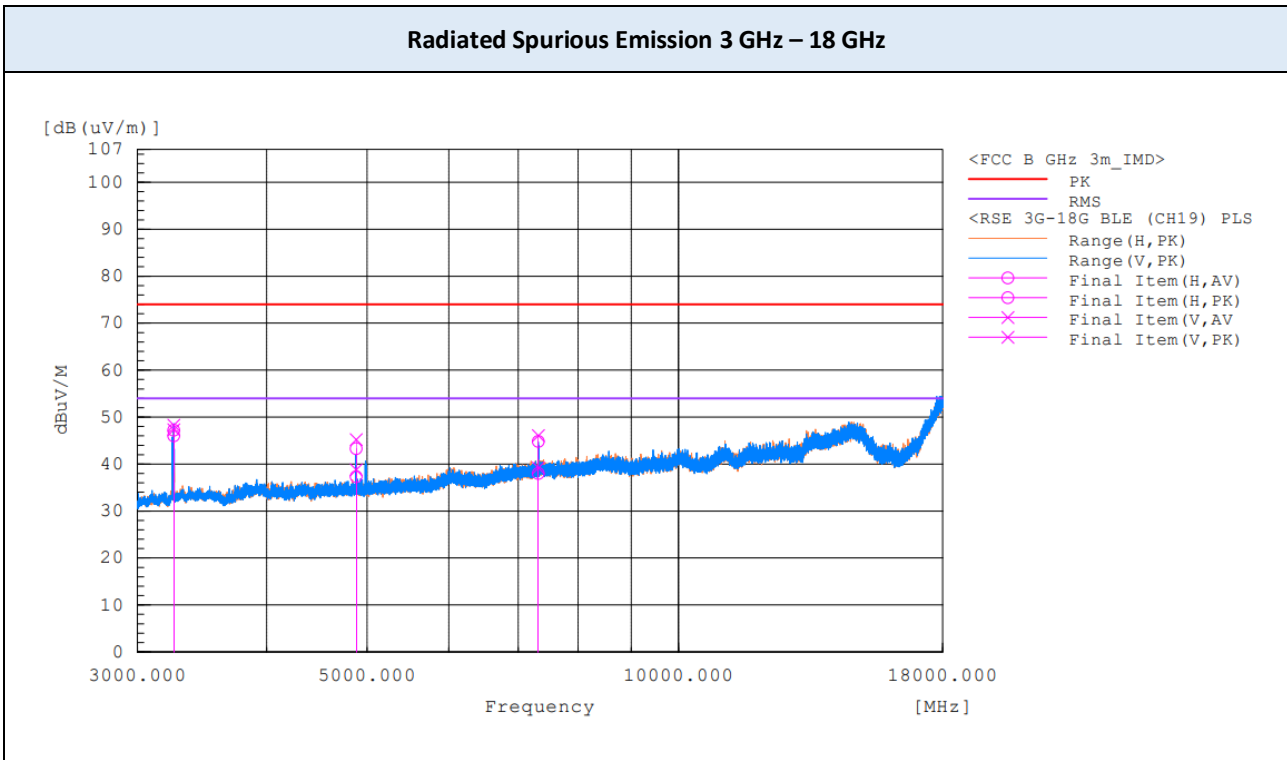

Note:

The worst-case plots are included in this report.

9.7. RADIATED RESTRICTED BAND EDGES

Test Mode BLE 1M (GFSK) : TX mode
 Operating Frequency 2402 MHz
 Channel No. CH 0

Frequency (MHz)	Polarization	Reading (dBuV)		Factor (dB)		Level (dBuV/m)		Limit (dBuV/m)		Margin (dB)	
		AV	PK	Corr. ¹⁾	Duty	AV	PK	AV	PK	AV	PK
2389.944	V	8.8	17.1	31.0	0.77	40.6	48.1	54	74	13.4	25.9
2389.962	H	7.7	16.9	31.0	0.77	39.5	47.9	54	74	14.5	26.1

Test Mode BLE 1M (GFSK) : TX mode
 Operating Frequency 2480 MHz
 Channel No. CH 39

Frequency (MHz)	Polarization	Reading (dBuV)		Factor (dB)		Level (dBuV/m)		Limit (dBuV/m)		Margin (dB)	
		AV	PK	Corr. ¹⁾	Duty	AV	PK	AV	PK	AV	PK
2483.606	V	12.6	21.4	31.6	0.77	45.0	53.0	54	74	9.0	21.0
2483.784	H	10.8	20.0	31.6	0.77	43.2	51.6	54	74	10.8	22.4
2486.891	V	13.2	21.9	31.6	0.77	45.6	53.5	54	74	8.4	20.5
2487.681	H	12.2	20.8	31.6	0.77	44.6	52.4	54	74	9.4	21.6

Notes:

1. Correction Factor: Antenna Factor + Cable loss

TEST PLOTS

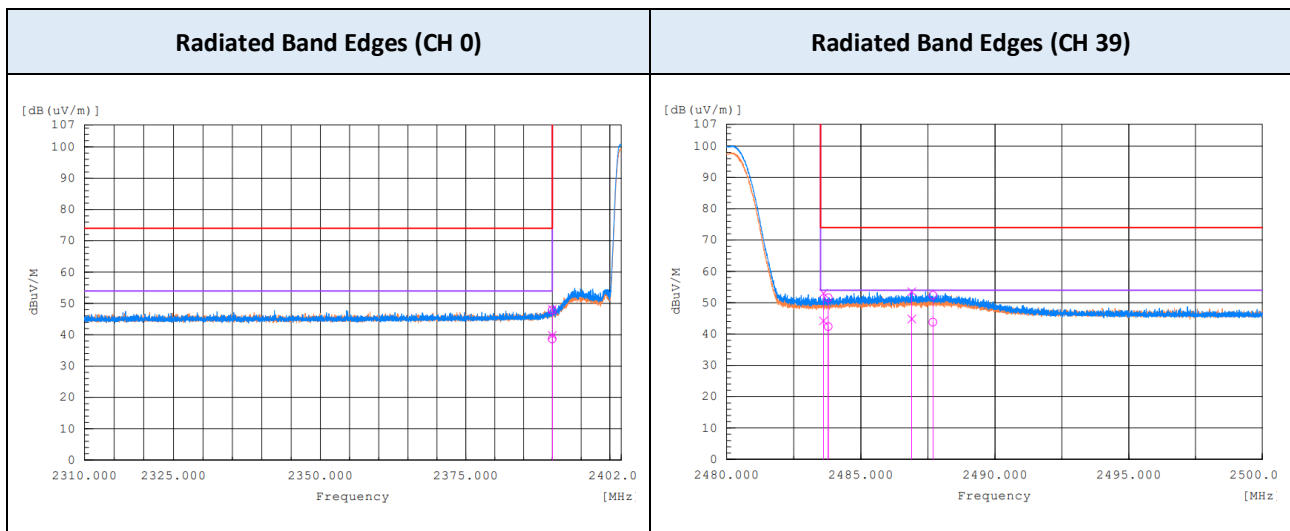

9.8. RECEIVER SPURIOUS EMISSION

Test Mode BLE 1M (GFSK)
 Operating Frequency 2440 MHz

Frequency Range : Below 1 GHz

Frequency (MHz)	Polarization	Reading (dBuV)	Corr. ¹⁾ (dB)	Total (dBuV/m)	Limit (dBuV/m)	Margin (dB)	Measurement Type
62.504	V	36.2	-12.9	23.3	40	16.7	QP
166.501	H	32.2	-8.6	23.6	43.5	19.9	QP

Frequency Range : Above 1 GHz

Frequency (MHz)	Polarization	Reading (dBuV)	Corr. ¹⁾ (dB)	Total (dBuV/m)	Limit (dBuV/m)	Margin (dB)	Measurement Type
1592.891	H	34.7	-14.3	20.4	54	33.6	RMS
1593.167	V	36.2	-14.3	21.9	54	32.1	RMS
3255.978	H	56	-8.9	47.1	54	6.9	RMS
3256.002	V	58	-8.9	49.1	54	4.9	RMS

Notes:

1. Correction Factor: Antenna Factor + Cable loss + Pre-amplifier Gain

▣ TEST PLOTS

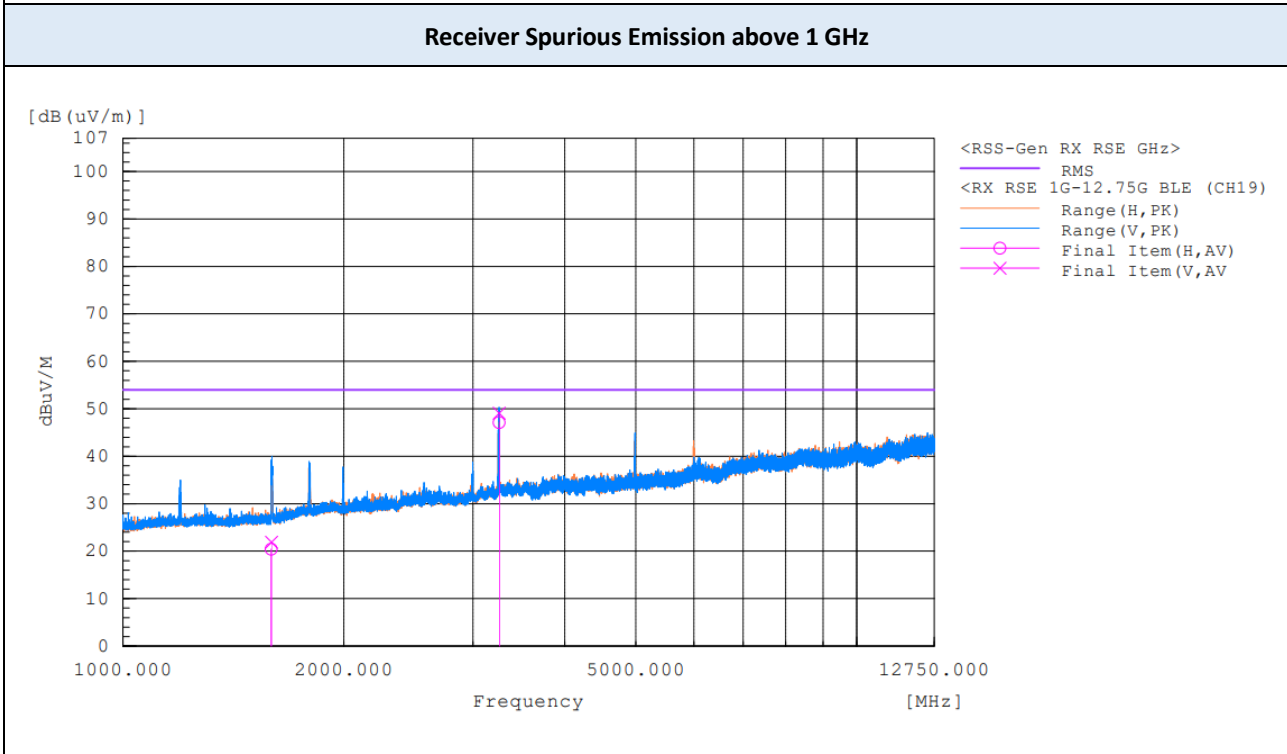
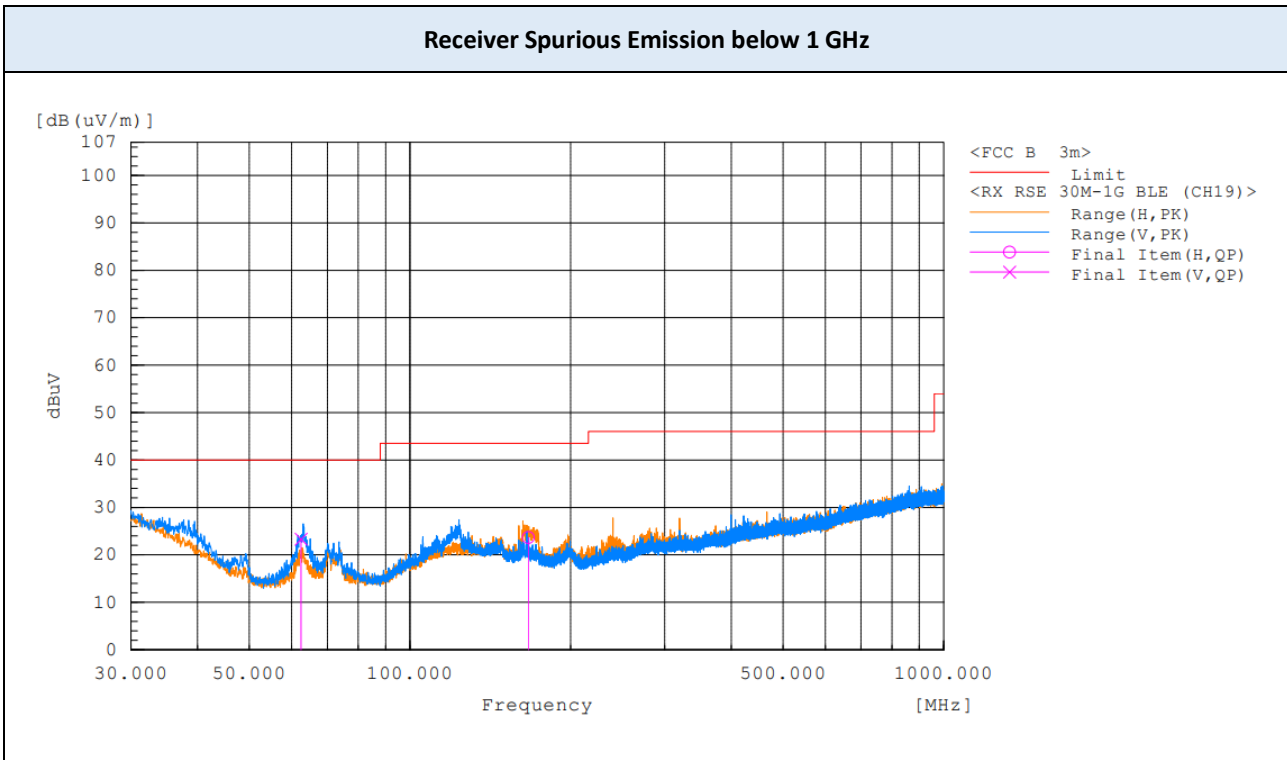

Note:
The worst-case plots are included in this report.

9.9. POWERLINE CONDUCTED EMISSIONS

AC Main

Frequency (MHz)	Line	Reading (dBμV)		Corr. ¹⁾ (dB)	Level (dBμV)		Limit (dBμV)		Margin (dB)	
		QP	CAV		QP	CAV	QP	CAV	QP	CAV
0.151	L1	39.5	19.4	9.8	49.3	29.2	66	56	16.7	26.8
0.221	L1	31.6	14.4	9.7	41.3	24.1	62.8	52.8	21.5	28.7
0.499	L1	29.4	18.2	9.7	39.1	27.9	56	46	16.9	18.1
0.535	L1	34.3	24.9	9.7	44.0	34.6	56	46	12.0	11.4
2.559	L1	22.2	11.3	9.8	32.0	21.1	56	46	24.0	24.9
13.087	L1	25.0	19.6	10.1	35.1	29.7	60	50	24.9	20.3

Frequency (MHz)	Line	Reading (dBμV)		Corr. ¹⁾ (dB)	Level (dBμV)		Limit (dBμV)		Margin (dB)	
		QP	CAV		QP	CAV	QP	CAV	QP	CAV
0.156	N	40.2	19.4	9.8	50.0	29.2	65.7	55.7	15.7	26.5
0.236	N	28.7	12.4	9.7	38.4	22.1	62.2	52.2	23.8	30.1
0.497	N	28.9	16.9	9.7	38.6	26.6	56.1	46.1	17.5	19.5
0.521	N	33.8	23.3	9.7	43.5	33.0	56	46	12.5	13.0
2.598	N	19.6	11.4	9.8	29.4	21.2	56	46	26.6	24.8
13.803	N	24.8	19.5	10.1	34.9	29.6	60	50	25.1	20.4

Note :

1. Quasi-peak(Final Result) = Reading Value + Correction Factor

▣ TEST PLOTS

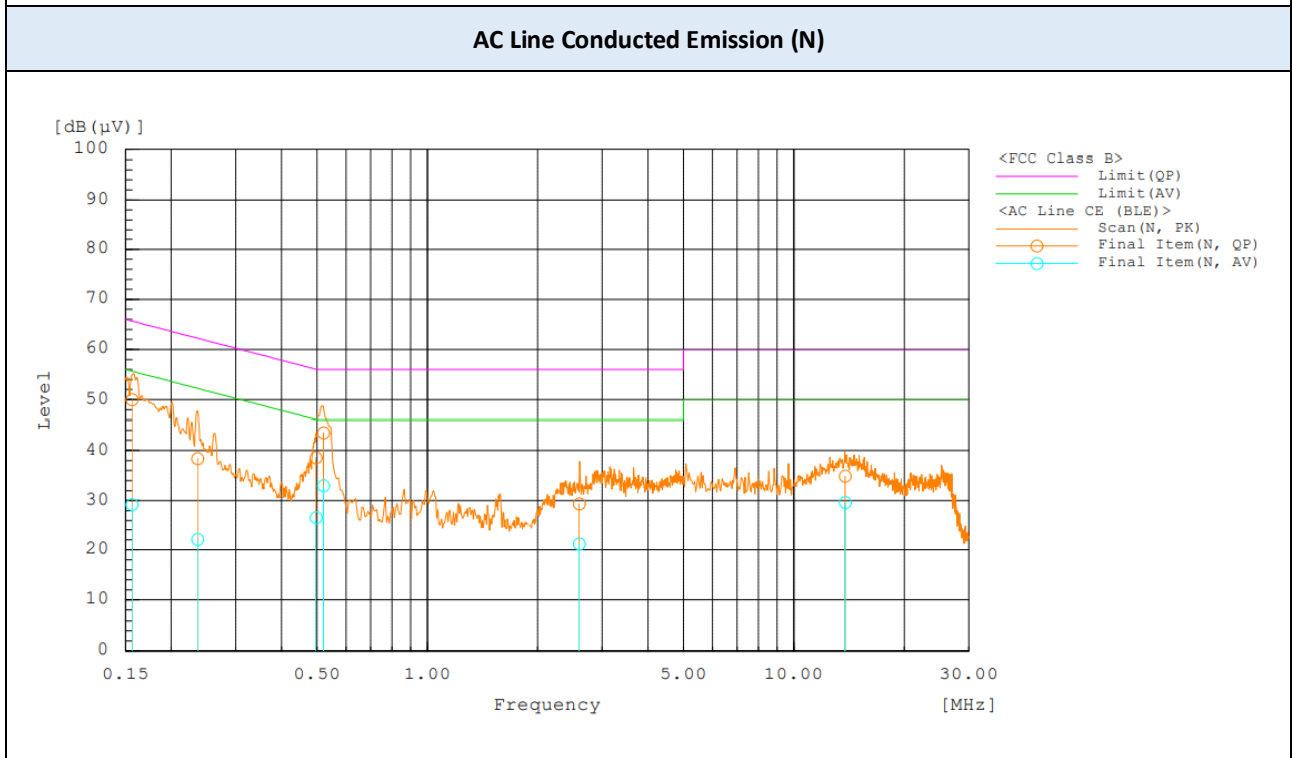
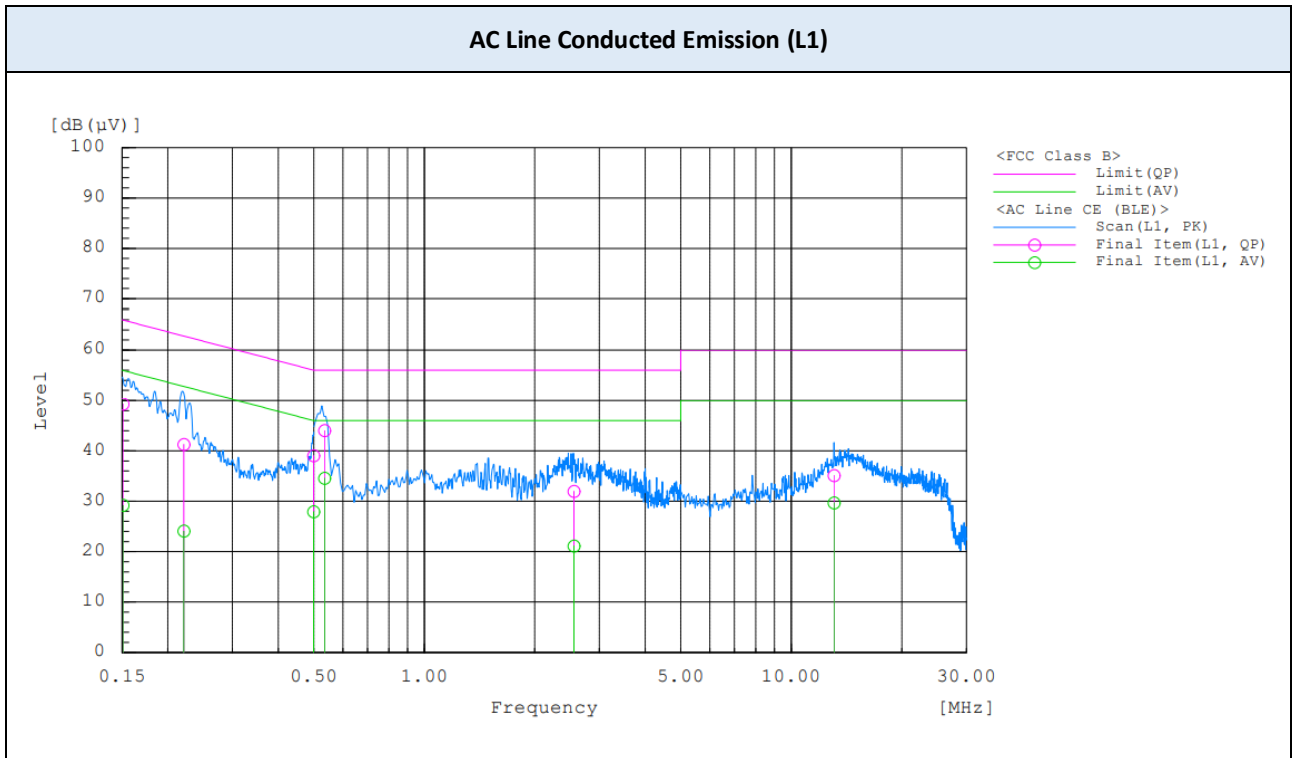

10. LIST OF TEST EQUIPMENT

No.	Instrument	Model No.	Calibration Due (mm/dd/yy)	Manufacture	Serial No.
<input checked="" type="checkbox"/>	Signal Analyzer (20 Hz ~ 40.0 GHz)	ESU40	12/09/2021	Rohde & Schwarz	100529
<input checked="" type="checkbox"/>	Signal Analyzer (10 Hz ~ 40.0 GHz)	FSV40	03/23/2021	Rohde & Schwarz	101424
<input checked="" type="checkbox"/>	Signal Analyzer (10 Hz ~ 26.5 GHz)	N9020A	11/07/2021	Keysight	MY52091291
<input checked="" type="checkbox"/>	Attenuator (20 dB, DC ~ 26.5 GHz)	8493C	12/07/2021	HP	09072
<input type="checkbox"/>	Attenuator (10 dB, DC ~ 26.5 GHz)	CFAD261002	01/07/2022	CERNEX	H0044
<input checked="" type="checkbox"/>	Loop Antenna (0.009 ~ 30 MHz)	AL-130R	04/05/2021	Com-Power	121082
<input checked="" type="checkbox"/>	BI-LOG Antenna (30 MHz ~ 6 GHz)	JB6	10/26/2022	Sunol	A071116
<input checked="" type="checkbox"/>	LNA (30 MHz ~ 1GHz)	8447D	08/06/2021	HP	2443A03587
<input checked="" type="checkbox"/>	Horn Antenna (1 GHz ~ 18 GHz)	DRH-118	10/21/2022	Sunol	A070516
<input checked="" type="checkbox"/>	LNA (1 GHz ~ 18 GHz)	PAM-118A	07/09/2021	Com-Power	18040074
<input checked="" type="checkbox"/>	Horn Antenna (18 GHz ~ 40 GHz)	DRH-1840	02/20/2021	Sunol	17120
<input checked="" type="checkbox"/>	LNA (18 GHz ~ 40 GHz)	CBL184050-45-01	02/04/2022	CERNEX, Inc.	43964
<input type="checkbox"/>	Power Divider-2way (DC ~ 26.5 GHz)	11636B	12/11/2021	HP	50820
<input type="checkbox"/>	Directional Coupler (1-4GHz)	3022	12/15/2021	Narda	72118
<input checked="" type="checkbox"/>	High Pass Filter (2.4 GHz)	WHK10-2520-3000-18000-40EF	01/06/2022	Wainwright	9
<input checked="" type="checkbox"/>	EMI Test Receiver	ESR3	12/17/2021	Rohde & Schwarz	102363
<input checked="" type="checkbox"/>	LISN	ENV216	01/16/2022	Rohde & Schwarz	101349

Note:

1. Equipment listed above that calibrated during the testing period was set for test after the calibration.
2. Equipment listed above that has a calibration due date during the testing period, the testing is completed before equipment expiration date

APPENDIX A. TEST SETUP PHOTOS

The setup photos are provided as a separate document.

APPENDIX B. PHOTOGRAPHS OF EUT

B.1. EXTERNAL PHOTOS

The external photos are provided as a separate document.

B.2. INTERNAL PHOTOS

The internal photos are provided as a separate document.

END OF TEST REPORT