

TEST REPORT

Test report no.: 1-3605_21-01-06

Testing laboratory

CTC advanced GmbH

Untertuerkheimer Strasse 6 – 10
66117 Saarbruecken / Germany
Phone: + 49 681 5 98 - 0
Fax: + 49 681 5 98 - 9075
Internet: <https://www.ctcadvanced.com>
e-mail: mail@ctcadvanced.com

Accredited Testing Laboratory:

The testing laboratory (area of testing) is accredited according to DIN EN ISO/IEC 17025 (2018-03) by the Deutsche Akkreditierungsstelle GmbH (DAkkS)
The accreditation is valid for the scope of testing procedures as stated in the accreditation certificate starting with the registration number: D-PL-12076-01.

Applicant

Linde Material Handling GmbH

Carl-von-Linde-Platz
63743 Aschaffenburg / GERMANY
Phone: +49-231-700996-12
Contact: Volker Koester
e-mail: koester@comnovo.de

Manufacturer

Comnovo GmbH

Emil-Figge-Str. 76
44227 Dortmund / GERMANY

Test standard/s

FCC - Title 47 CFR Part 15 FCC - Title 47 of the Code of Federal Regulations; Chapter I; Part 15 - Radio frequency devices

For further applied test standards please refer to section 3 of this test report.

Test Item

Kind of test item:	Fork lift truck unit
Model name:	Truck Unit Small
FCC ID:	2AYVBD2S0009469010
Frequency:	3100 MHz to 10600 MHz
Technology tested:	UWB
Antenna:	Integrated antenna
Power supply:	12 V/24 V DC by external power supply
Temperature range:	-40°C to +85°C

This test report is electronically signed and valid without handwritten signature. For verification of the electronic signatures, the public keys can be requested at the testing laboratory.

Test report authorized:

Thomas Vogler
Lab Manager
Radio Communications

Test performed:

Frank Heussner
Lab Manager
Radio Communications

1 Table of contents

1	Table of contents	2
2	General information	3
2.1	Notes and disclaimer	3
2.2	Application details	3
2.3	Test laboratories sub-contracted	3
3	Test standard/s, references and accreditations	4
4	Reporting statements of conformity – decision rule	5
5	Test environment.....	6
6	Test item	6
6.1	General description.....	6
6.2	Additional information	6
7	Description of the test setup	7
7.1	Shielded semi anechoic chamber	8
7.2	Shielded fully anechoic chamber	10
7.3	Radiated measurements > 18 GHz.....	13
7.4	AC conducted	15
8	Sequence of testing.....	16
8.1	Sequence of testing radiated spurious 9 kHz to 30 MHz	16
8.2	Sequence of testing radiated spurious 30 MHz to 1 GHz.....	17
8.3	Sequence of testing radiated spurious 1 GHz to 18 GHz	18
8.4	Sequence of testing radiated spurious above 18 GHz	19
8.5	Sequence of testing efficient use of spectrum.....	20
9	Measurement uncertainty	21
10	Summary of measurement results	22
11	Additional comments	22
12	Measurement results.....	24
12.1	10 dB - Bandwidth	24
12.2	TX Radiated Emissions	27
12.3	Efficient use of spectrum acc. to §15.519(a)(1).....	50
12.4	Antenna requirements.....	54
12.5	Conducted emissions < 30MHz	55
13	Glossary.....	58
14	Document history.....	59
15	Accreditation Certificate – D-PL-12076-01-05	59

2 General information

2.1 Notes and disclaimer

The test results of this test report relate exclusively to the test item specified in this test report. CTC advanced GmbH does not assume responsibility for any conclusions and generalizations drawn from the test results with regard to other specimens or samples of the type of the equipment represented by the test item.

The test report may only be reproduced or published in full. Reproduction or publication of extracts from the report requires the prior written approval of CTC advanced GmbH.

The testing service provided by CTC advanced GmbH has been rendered under the current "General Terms and Conditions for CTC advanced GmbH".

CTC advanced GmbH will not be liable for any loss or damage resulting from false, inaccurate, inappropriate or incomplete product information provided by the customer.

Under no circumstances does the CTC advanced GmbH test report include any endorsement or warranty regarding the functionality, quality or performance of any other product or service provided.

Under no circumstances does the CTC advanced GmbH test report include or imply any product or service warranties from CTC advanced GmbH, including, without limitation, any implied warranties of merchantability, fitness for purpose, or non-infringement, all of which are expressly disclaimed by CTC advanced GmbH.

All rights and remedies regarding vendor's products and services for which CTC advanced GmbH has prepared this test report shall be provided by the party offering such products or services and not by CTC advanced GmbH. In no case this test report can be considered as a Letter of Approval.

This test report is electronically signed and valid without handwritten signature. For verification of the electronic signatures, the public keys can be requested at the testing laboratory.

2.2 Application details

Date of receipt of order:	2021-12-11
Date of receipt of test item:	2022-02-03
Start of test:*	2022-05-05
End of test:*	2022-10-25
Person(s) present during the test:	-/-

*Date of each measurement, if not shown in the plot, can be requested. Dates are stored in the measurement software.

2.3 Test laboratories sub-contracted

None

3 Test standard/s, references and accreditations

Test standard	Date	Description
FCC - Title 47 CFR Part 15		FCC - Title 47 of the Code of Federal Regulations; Chapter I; Part 15 - Radio frequency devices

Guidance	Version	Description
ANSI C63.4-2014	-/-	American National Standard for Methods of Measurement of Radio-Noise Emissions from Low-Voltage Electrical and Electronic Equipment in the Range of 9 kHz to 40 GHz
ANSI C63.10-2013	-/-	American National Standard of Procedures for Compliance Testing of Unlicensed Wireless Devices
UWB KDB	v02	393764 D01 UWB FAQ v02: ULTRA-WIDEBAND (UWB) DEVICES FREQUENTLY ASKED QUESTIONS

Accreditation	Description
D-PL-12076-01-05	Telecommunication FCC requirements https://www.dakks.de/files/data/as/pdf/D-PL-12076-01-05e.pdf



4 Reporting statements of conformity – decision rule

Only the measured values related to their corresponding limits will be used to decide whether the equipment under test meets the requirements of the test standards listed in chapter 3. The measurement uncertainty is mentioned in this test report, see chapter 9, but is not taken into account - neither to the limits nor to the measurement results. Measurement results with a smaller margin to the corresponding limits than the measurement uncertainty have a potential risk of more than 5% that the decision might be wrong.

measured value, measurement uncertainty, verdict

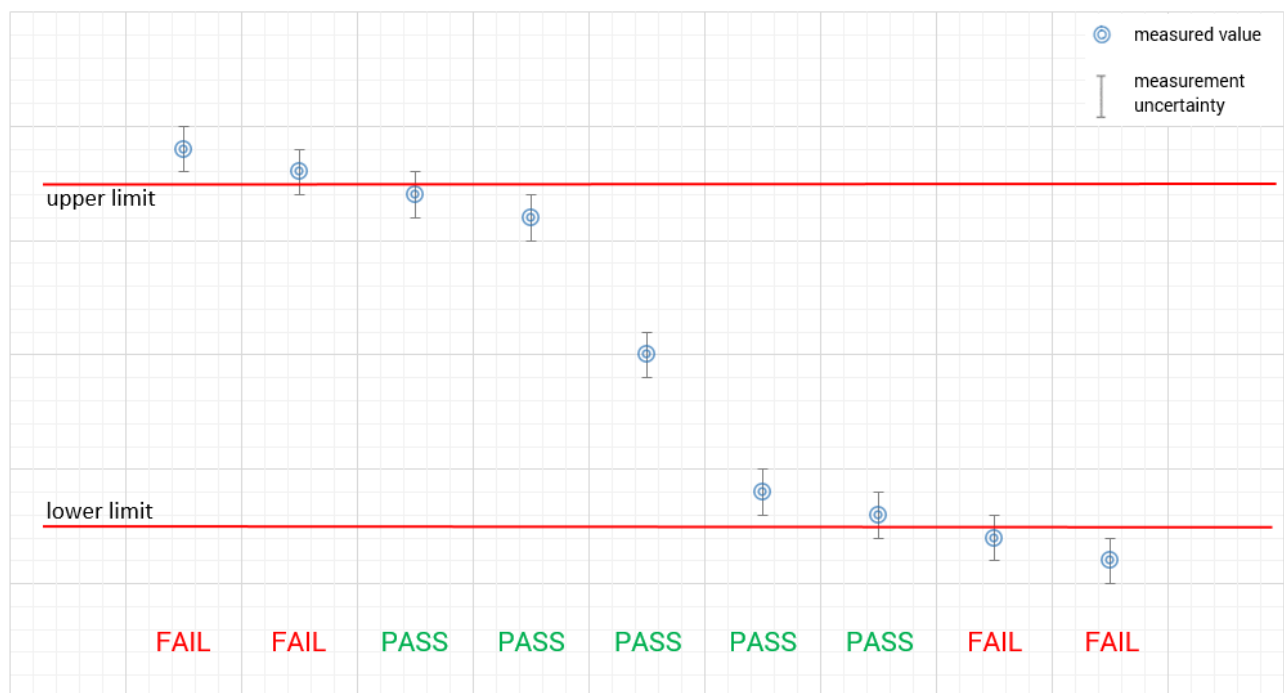

7 Description of the test setup

Typically, the calibrations of the test apparatus are commissioned to and performed by an accredited calibration laboratory. The calibration intervals are determined in accordance with the DIN EN ISO/IEC 17025. In addition to the external calibrations, the laboratory executes comparison measurements with other calibrated test systems or effective verifications. Weekly chamber inspections and range calibrations are performed. Where possible, RF generating and signaling equipment as well as measuring receivers and analyzers are connected to an external high-precision 10 MHz reference (GPS-based or rubidium frequency standard).

In order to simplify the identification of the equipment used at some special tests, some items of test equipment and ancillaries can be provided with an identifier or number in the equipment list below (Lab/Item).

Agenda: Kind of Calibration

k	calibration / calibrated	EK	limited calibration
ne	not required (k, ev, izw, zw not required)	zw	cyclical maintenance (external cyclical maintenance)
ev	periodic self verification	izw	internal cyclical maintenance
Ve	long-term stability recognized	g	blocked for accredited testing
vlk!	Attention: extended calibration interval		
NK!	Attention: not calibrated	*)	next calibration ordered / currently in progress

7.1 Shielded semi anechoic chamber

The radiated measurements are performed in vertical and horizontal plane in the frequency range from 30 MHz to 1 GHz in semi-anechoic chambers. The EUT is positioned on a non-conductive support with a height of 0.80 m above a conductive ground plane that covers the whole chamber. The receiving antennas are conform to specifications ANSI C63. These antennas can be moved over the height range between 1.0 m and 4.0 m in order to search for maximum field strength emitted from EUT. The measurement distances between EUT and receiving antennas are indicated in the test setups for the various frequency ranges. For each measurement, the EUT is rotated in all three axes until the maximum field strength is received. The wanted and unwanted emissions are received by spectrum analyzers where the detector modes and resolution bandwidths over various frequency ranges are set according to requirement ANSI C63.

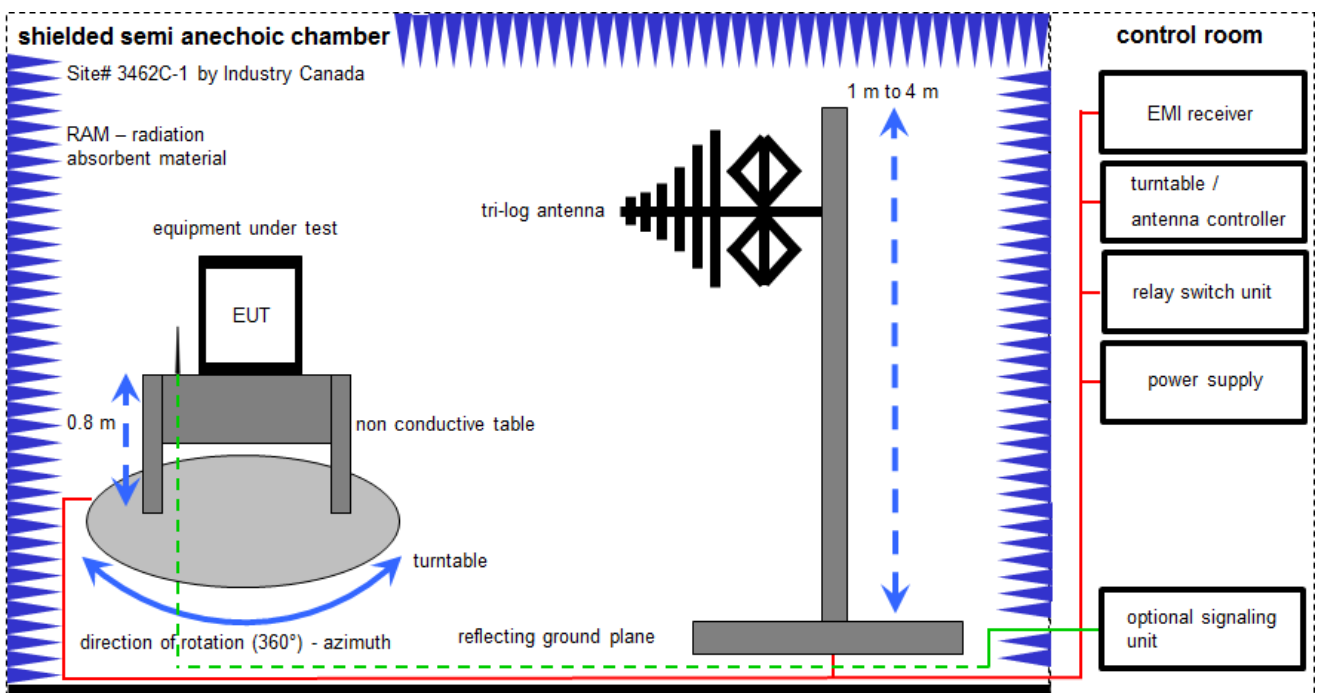

Measurement distance: tri-log antenna 10 meter

$$FS = UR + CL + AF$$

(FS-field strength; UR-voltage at the receiver; CL-loss of the cable; AF-antenna factor)

Example calculation:

$$FS [dB\mu V/m] = 12.35 [dB\mu V/m] + 1.90 [dB] + 16.80 [dB/m] = 31.05 [dB\mu V/m] (35.69 \mu V/m)$$

Equipment table:

No.	Lab / Item	Equipment	Type	Manufacturer	Serial No.	INV. No.	Kind of Calibration	Last Calibration	Next Calibration
1	n. a.	Switch-Unit	3488A	HP	2719A14505	300000368	ev	-/-	-/-
2	n. a.	DC power supply, 60Vdc, 50A, 1200 W	6032A	HP	2920A04466	300000580	ne	-/-	-/-
3	n. a.	Semi anechoic chamber	300023	MWB AG	-/-	300000551	ne	-/-	-/-
4	n. a.	Antenna Tower	Model 2175	ETS-Lindgren	64762	300003745	izw	-/-	-/-
5	n. a.	Positioning Controller	Model 2090	ETS-Lindgren	64672	300003746	izw	-/-	-/-
6	n. a.	Turntable Interface-Box	Model 105637	ETS-Lindgren	44583	300003747	izw	-/-	-/-
7	n. a.	EMI Test Receiver	ESR3	Rohde & Schwarz	102587	300005771	k	08.12.2021 09.12.2022	07.12.2022 31.12.2023
8	n. a.	PC	TecLine	F+W	-/-	300004388	ne	-/-	-/-
9	n. a.	TRILOG Broadband Test-Antenna 30 MHz - 3 GHz	VULB9163	Schwarzbeck Mess - Elektronik	01029	300005379	vIKI!	18.08.2021	30.08.2023

7.2 Shielded fully anechoic chamber

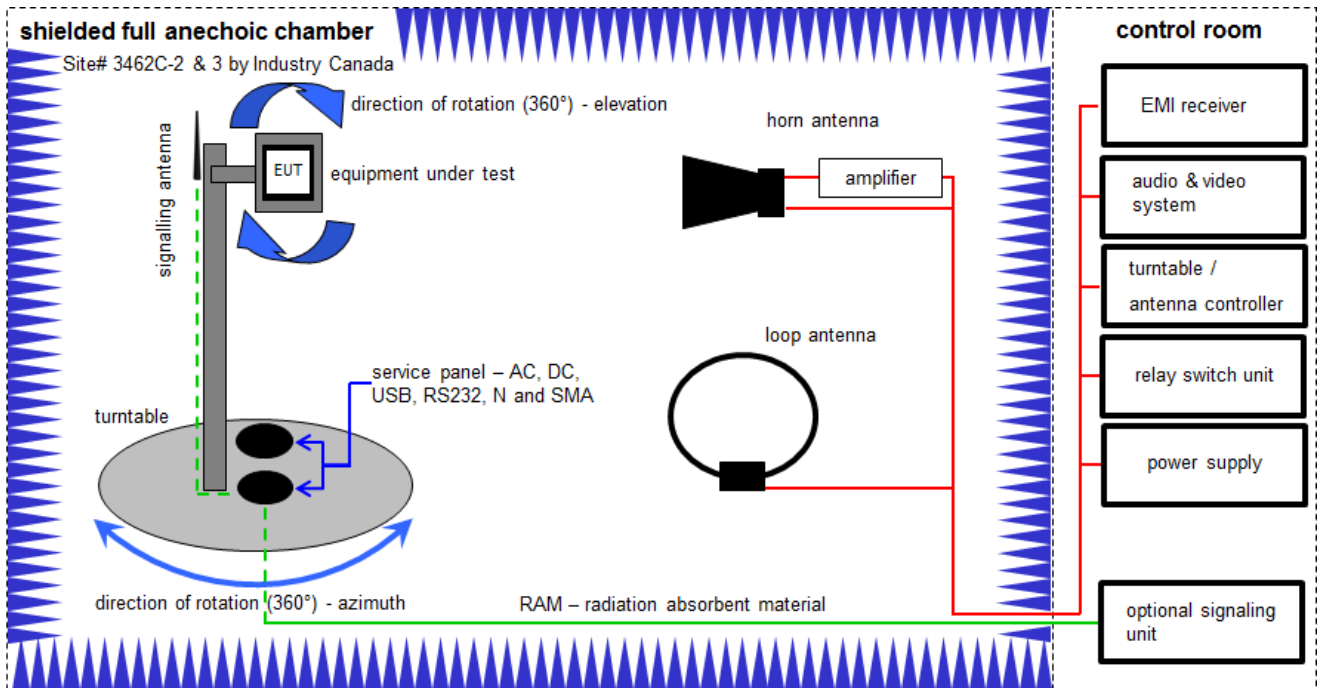

Measurement distance: loop antenna and horn antenna 3 meter;

$$FS = UR + CA + AF$$

(FS-field strength; UR-voltage at the receiver; CA-loss of the signal path; AF-antenna factor)

Example calculation:

$$FS [dB\mu V/m] = 40.0 [dB\mu V/m] + (-35.8) [dB] + 32.9 [dB/m] = 37.1 [dB\mu V/m] (71.61 \mu V/m)$$

$$OP = AV + D - G + CA$$

(OP-radiated output power; AV-analyzer value; D-free field attenuation of measurement distance; G-antenna gain+amplifier gain; CA-loss signal path)

Example calculation:

$$OP [dBm] = -65.0 [dBm] + 50 [dB] - 20 [dBi] + 5 [dB] = -30 [dBm] (1 \mu W)$$

Equipment table (Chamber C):

No.	Lab / Item	Equipment	Type	Manufacturer	Serial No.	INV. No.	Kind of Calibration	Last Calibration	Next Calibration
1	A,B,C	DC power supply, 60Vdc, 50A, 1200 W	6032A	HP	2818A03450	300001040	vKI!	09.12.2020	08.12.2023
2	A,B,C	Anechoic chamber	FAC 3/5m	MWB / TDK	87400/02	300000996	ev	-/-	-/-
3	A,B,C	Switch / Control Unit	3488A	HP	*	300000199	ne	-/-	-/-
4	A,B,C	Variable isolating transformer	MPL IEC625 Bus Variable isolating transformer	Erfi	91350	300001155	ne	-/-	-/-
5	A,B,C	EMI Test Receiver 20Hz- 26,5GHz	ESU26	R&S	100037	300003555	k	09.12.2021 07.12.2022	08.12.2022 31.12.2023
6	A,B,C	4U RF Switch Platform	L4491A	Agilent Technologies	MY50000037	300004509	ne	-/-	-/-
7	A,B,C	NEXIO EMV-Software	BAT EMC V3.21.0.32	EMCO		300004682	ne	-/-	-/-
8	A,B,C	PC	ExOne	F+W		300004703	ne	-/-	-/-
9	B,C	MXG Microwave Analog Signal Generator	N5183A	Agilent Technologies	MY47420220	300003813	vKI!	12.12.2019 07.12.2022	11.12.2022 31.12.2025
10	B	Highpass Filter	WHKX7.0/18G-8SS	Wainwright	19	300003790	ne	-/-	-/-
11	B	Broadband Amplifier 0.5-18 GHz	CBLU5184540	CERNEX	22049	300004481	ev	-/-	-/-
12	B	RF-Amplifier	AMF-6F06001800-30-10P-R	NARDA-MITEQ Inc	2011572	300005241	ev	-/-	-/-
13	B	Double-Ridged Waveguide Horn Antenna 1-18.0GHz	3115	EMCO	8812-3089	30000307	vKI!	11.02.2022	29.02.2024
14	A	Active Loop Antenna 9 kHz to 30 MHz	6502	EMCO	2210	300001015	vKI!	01.07.2021	31.07.2023

Equipment table (OTA):

No.	Lab / Item	Equipment	Type	Manufacturer	Serial No.	INV. No.	Kind of Calibration	Last Calibration	Next Calibration
1	A,B,C	Power supply GPIB dc power supply, 0-50 Vdc, 0-2 A	6633A	HP	2851A01222	300001530	vIKI!	10.12.2019 15.12.2022	09.12.2022 31.12.2025
2	A,B,C,D	CTIA-Chamber	CTIA-Chamber AMS 8500	ETS-Lindgren Finland		300003327	ne	-/-	-/-
3	A,B,C,D	CTIA-Chamber - Positioning Equipment	CTIA-Chamber - Positioning Equipment	EMCO/2		300003328	ne	-/-	-/-
4	A,B,C,D	Signal- and Spectrum Analyzer	FSW26	R&S	101371	300005697	k	09.12.2021 08.12.2022	08.12.2022 31.12.2023
5	A,B,C,D	PC	Precision M4800	DELL	19414201934	300004957	-/-	-/-	-/-
6	A,B,C,D	EMC Software	EMC32-MEB	R&S	n.a.	300005477	ne	-/-	-/-
7	A,B,C,D	RF Amplifier	AMF-7D-01001800-22-10P	NARDA-MITEQ Inc	2089864	300005633	ev	-/-	-/-
8	B, C,D	Lowpass Filter (Chebyshev)	WLKX14-4700-4900-21000-30SS	Wainwright Instruments GmbH	1	300005655	ev	-/-	-/-
9	A,D	High Pass Filter (Chebyshev)	WHNX6-8374-10600-26500-40CC	Wainwright Instruments GmbH	1	300005656	ev	-/-	-/-
10	A,B,D	Double-Ridged Waveguide Horn Antenna 1-18.0GHz	3115	EMCO	9709-5290	300000212	ev	-/-	-/-
11	D	Double-Ridged Waveguide Horn Antenna 1-18.0GHz	3115	EMCO	9709-5289	300000213	vIKI!	14.07.2020 26.07.2022	25.07.2024
12	D	MXG Microwave Analog Signal Generator	N5183A	Agilent Technologies	MY47420220	300003813	vIKI!	12.12.2019 07.12.2022	11.12.2022 31.12.2025
13	A,D	Std. Gain Horn Antenna 11.90-18.00 GHz	1824-20	Flann	263	300002471	ne	-/-	-/-
14	A,D	Std. Gain Horn Antenna 11.90-18.00 GHz	1824-20	Flann	286	300001200-0001	vIKI!	26.07.2022	25.07.2024

7.3 Radiated measurements > 18 GHz

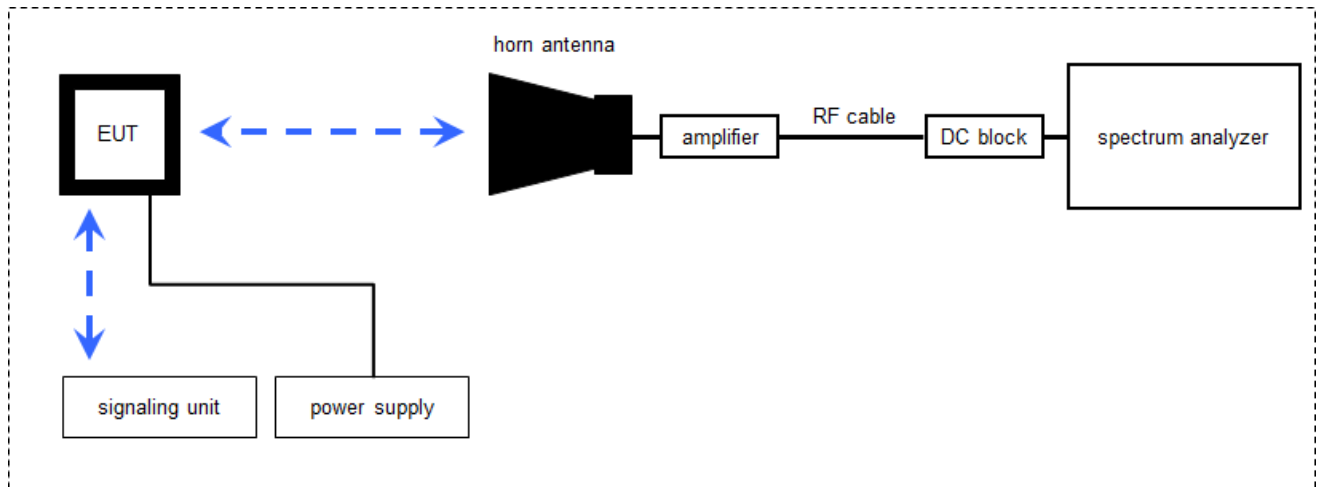

Measurement distance: horn antenna e.g. 75 cm

$$FS = UR + CA + AF$$

(FS-field strength; UR-voltage at the receiver; CA-loss signal path & distance correction; AF-antenna factor)

Example calculation:

$$FS \text{ [dB}\mu\text{V/m]} = 40.0 \text{ [dB}\mu\text{V/m]} + (-60.1) \text{ [dB]} + 36.74 \text{ [dB/m]} = 16.64 \text{ [dB}\mu\text{V/m]} \text{ (} 6.79 \mu\text{V/m)}$$

$$OP = AV + D - G + CA$$

(OP-radiated output power; AV-analyzer value; D-free field attenuation of measurement distance; G-antenna gain+amplifier gain; CA-loss signal path)

Example calculation:

$$OP \text{ [dBm]} = -59.0 \text{ [dBm]} + 44.0 \text{ [dB]} - 20.0 \text{ [dBi]} + 5.0 \text{ [dB]} = -30 \text{ [dBm]} \text{ (} 1 \mu\text{W)}$$

Note: conversion loss of mixer is already included in analyzer value.

Equipment table:

No.	Lab / Item	Equipment	Type	Manufacturer	Serial No.	INV. No.	Kind of Calibration	Last Calibration	Next Calibration
1	n. a.	Spectrum Analyzer	FSW50	Rohde & Schwarz	101332	300005935	k	20.01.2022	31.01.2023
2	n. a.	Spectrum Analyzer	FSW50	Rohde & Schwarz	101560	300006179	k	19.03.2021 07.03.2022	18.03.2022 31.03.2023
3	n. a.	Broadband LNA 18-50 GHz	CBL18503070PN	CERNEX	25240	300004948	ev	29.10.2021	28.10.2023
4	n.a.	DC Power Supply, 60V, 10A	6038A	HP	2848A07027	300001174	vIKI!	08.12.2020	07.12.2023
5	n.a.	Horn Antenna 18,0- 40,0 GHz	LHAF180	Microw.Devel	39180-103-021	300001747	vIKI!	17.01.2022	31.01.2024
6	n. a.	Std. Gain Horn Antenna 18.0-26.5 GHz	638	Narda		300000486	vIKI!	17.01.2022	31.01.2024
7	n. a.	Std. Gain Horn Antenna 26.5-40.0 GHz	V637	Narda	82-16	300000510	vIKI!	17.01.2022	31.01.2024
8	n.a.	Std. Gain Horn Antenna 33.0-50.1 GHz	2324-20	Flann	57	400000683	ne	-/-	-/-
9	n. a.	Double-Ridged Waveguide Horn Antenna 1-18.0GHz	3115	EMCO	9709-5289	300000213	vIKI!	14.07.2020 26.07.2022	25.07.2024

7.4 AC conducted

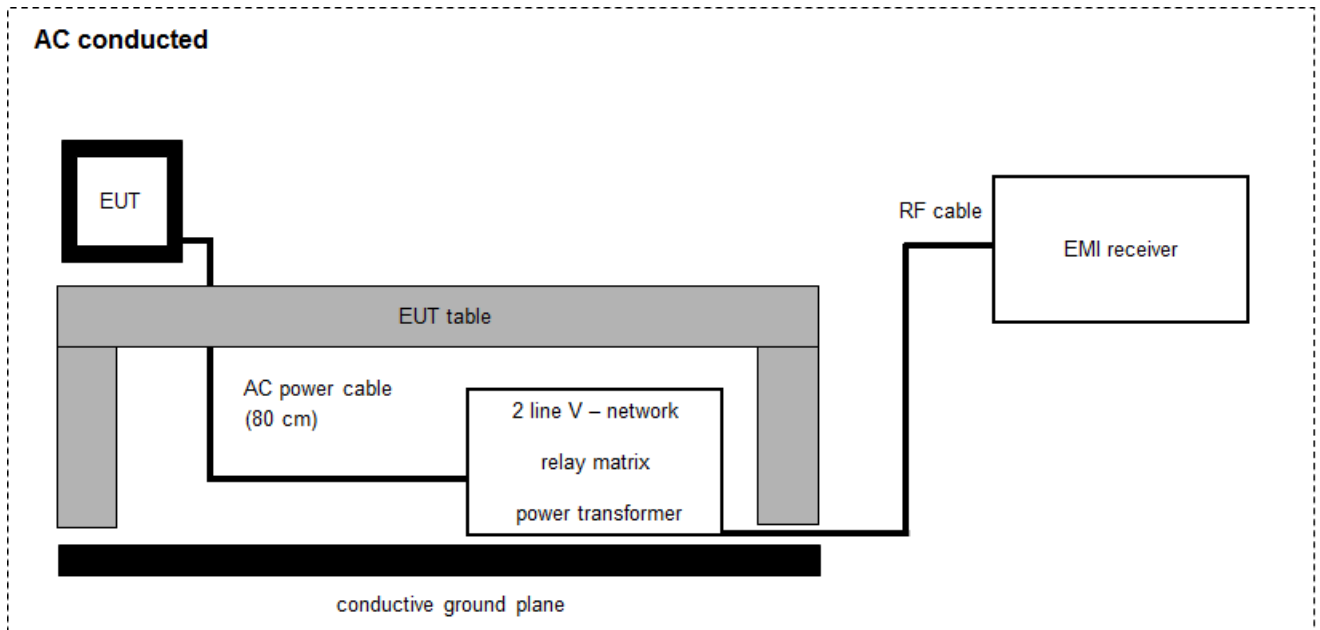

$$FS = UR + CF + VC$$

(FS-field strength; UR-voltage at the receiver; CR-loss of the cable and filter; VC-correction factor of the ISN)

Example calculation:

$$FS [dB\mu V/m] = 37.62 [dB\mu V/m] + 9.90 [dB] + 0.23 [dB] = 47.75 [dB\mu V/m] (244.06 \mu V/m)$$

Equipment table:

No.	Lab / Item	Equipment	Type	Manufacturer	Serial No.	INV. No.	Kind of Calibration	Last Calibration	Next Calibration
1	n. a.	Two-line V-Network (LISN) 9 kHz to 30 MHz	ESH3-Z5	R&S	892475/017	300002209	vIKI!	14.12.2021	31.12.2023
2	n. a.	Analyzer-Reference-System (Harmonics and Flicker)	ARS 16/1	SPS	A3509 07/0 0205	300003314	vIKI!	29.12.2021	31.12.2023
3	n. a.	Hochpass 150 kHz	EZ-25	R&S	100010	300003798	ev	-/-	-/-
4	n. a.	PC	TecLine	F+W	-/-	300003532	ne	-/-	-/-
5	n. a.	EMI Test Receiver 3.6 GHz	ESR3	Rohde & Schwarz	102981	300006318	k	09.12.2022	31.12.2023

8 Sequence of testing

8.1 Sequence of testing radiated spurious 9 kHz to 30 MHz

Setup

- The equipment is set up to simulate normal operation mode as described in the user manual or defined by the manufacturer.
- If the EUT is a tabletop system, it is placed on a table with 0.8 m height.
- If the EUT is a floor standing device, it is placed directly on the turn table.
- Auxiliary equipment and cables are positioned to simulate normal operation conditions as described in ANSI C 63.4.
- The AC power port of the EUT (if available) is connected to a power outlet below the turntable.
- Measurement distance is 3 m (see ANSI C 63.4) – see test details.
- EUT is set into operation.

Premeasurement*

- The turntable rotates from 0° to 315° using 45° steps.
- The antenna height is 1 m.
- At each turntable position the analyzer sweeps with positive-peak detector to find the maximum of all emissions.

Final measurement

- Identified emissions during the pre-measurement are maximized by the software by rotating the turntable from 0° to 360°.
- Loop antenna is rotated about its vertical axis for maximum response at each azimuth about the EUT. (For certain applications, the loop antenna plane may also need to be positioned horizontally at the specified distance from the EUT)
- The final measurement is done in the position (turntable and elevation) causing the highest emissions with quasi-peak (as described in ANSI C 63.4).
- Final levels, frequency, measuring time, bandwidth, turntable position, correction factor, margin to the limit and limit will be recorded. A plot with the graph of the premeasurement and the limit is stored.

*Note: The sequence will be repeated three times with different EUT orientations.

8.2 Sequence of testing radiated spurious 30 MHz to 1 GHz

Setup

- The equipment is set up to simulate normal operation mode as described in the user manual or defined by the manufacturer.
- If the EUT is a tabletop system, a table with 0.8 m height is used, which is placed on the ground plane.
- If the EUT is a floor standing device, it is placed on the ground plane with insulation between both.
- Auxiliary equipment and cables are positioned to simulate normal operation conditions as described in ANSI C 63.4.
- The AC power port of the EUT (if available) is connected to a power outlet below the turntable.
- Measurement distance is 10 m or 3 m (see ANSI C 63.4) – see test details.
- EUT is set into operation.

Premeasurement

- The turntable rotates from 0° to 315° using 45° steps.
- The antenna is polarized vertical and horizontal.
- The antenna height changes from 1 m to 3 m.
- At each turntable position, antenna polarization and height the analyzer sweeps three times in peak to find the maximum of all emissions.

Final measurement

- The final measurement is performed for at least six highest peaks according to the requirements of the ANSI C63.4.
- Based on antenna and turntable positions at which the peak values are measured the software maximize the peaks by changing turntable position $\pm 45^\circ$ and antenna height between 1 and 4 m.
- The final measurement is done with quasi-peak detector (as described in ANSI C 63.4).
- Final levels, frequency, measuring time, bandwidth, antenna height, antenna polarization, turntable angle, correction factor, margin to the limit and limit are recorded. A plot with the graph of the premeasurement with marked maximum final results and the limit is stored.

8.3 Sequence of testing radiated spurious 1 GHz to 18 GHz

Setup

- The equipment is set up to simulate normal operation mode as described in the user manual or defined by the manufacturer.
- If the EUT is a tabletop system, a 2-axis positioner with 1.5 m height is used.
- If the EUT is a floor standing device, it is placed directly on the turn table.
- Auxiliary equipment and cables are positioned to simulate normal operation conditions as described in ANSI C 63.4.
- The AC power port of the EUT (if available) is connected to a power outlet below the turntable.
- Measurement distance is 3 m (see ANSI C 63.4) – see test details.
- EUT is set into operation.

Premeasurement

- The turntable rotates from 0° to 315° using 45° steps.
- The antenna is polarized vertical and horizontal.
- The antenna height is 1.5 m.
- At each turntable position and antenna polarization the analyzer sweeps with positive peak detector to find the maximum of all emissions.

Final measurement

- The final measurement is performed for at least six highest peaks according to the requirements of the ANSI C63.4.
- Based on antenna and turntable positions at which the peak values are measured the software maximizes the peaks by rotating the turntable from 0° to 360°. This measurement is repeated for different EUT-table positions (0° to 150° in 30°-steps) and for both antenna polarizations.
- The final measurement is done in the position (turntable, EUT-table and antenna polarization) causing the highest emissions with Peak and RMS detector (as described in ANSI C 63.4).
- Final levels, frequency, measuring time, bandwidth, turntable position, EUT-table position, antenna polarization, correction factor, margin to the limit and limit are recorded. A plot with the graph of the premeasurement with marked maximum final results and the limit is stored.

8.4 Sequence of testing radiated spurious above 18 GHz

Setup

- The equipment is set up to simulate normal operation mode as described in the user manual or defined by the manufacturer.
- Auxiliary equipment and cables are positioned to simulate normal operation conditions as described in ANSI C 63.4.
- The AC power port of the EUT (if available) is connected to a power outlet.
- The measurement distance is as appropriate (e.g. 0.5 m).
- The EUT is set into operation.

Premeasurement

- The test antenna is handheld and moved carefully over the EUT to cover the EUT's whole sphere and different polarizations of the antenna.

Final measurement

- The final measurement is performed at the position and antenna orientation causing the highest emissions with Peak and RMS detector (as described in ANSI C 63.4).
- Final levels, frequency, measuring time, bandwidth, correction factor, margin to the limit and limit are recorded. A plot with the graph of the premeasurement and the limit is stored.

8.5 Sequence of testing efficient use of spectrum

Setup

- The equipment is set up to simulate normal operation mode as described in the user manual or defined by the manufacturer.
- The EUT positioned at a distance of approx. 0.5m to the horn antenna used for the measurement.
- The associated receiver is positioned between the EUT the horn antenna to assure that the received signal level of the associated receiver at the spectrum analyzer is higher than the level of the EUT.

Measurement:

- Switch on EUT and associated receiver and wait until the connection is established.
- Start Analyzer sweep in Zerospan with a sweep time of 15 s.
- Switch of the associated receiver.
- When switching of the associated receiver, a drop in the received signal level at the spectrum analyzer can be observed. → position marker 1
- Position marker two at the point where the transmission of the EUT stops.
- Measure time difference between marker 1 and marker 2.

9 Measurement uncertainty

Test case	Uncertainty
Equivalent isotropically radiated power (e.i.r.p.)	Conducted value ± 1 dB Radiated value ± 3 dB
Permitted range of operating frequencies	± 100 kHz
Conducted unwanted emissions in the spurious domain (up to 18 GHz)	± 1 dB
Radiated unwanted emissions in the spurious domain (up to 18 GHz)	± 3 dB
Conducted unwanted emissions in the spurious domain (18 to 40 GHz)	± 4 dB
Radiated unwanted emissions in the spurious domain (18 to 40 GHz)	± 4 dB
Conducted unwanted emissions in the spurious domain (40 to 50 GHz)	± 4.5 dB
Radiated unwanted emissions in the spurious domain (40 to 50 GHz)	± 4.5 dB
Conducted unwanted emissions in the spurious domain (above 50 GHz)	± 5 dB
Radiated unwanted emissions in the spurious domain (above 50 GHz)	± 5 dB
DC and low frequency voltages	± 3 %
Temperature	± 1 °C
Humidity	± 3 %

10 Summary of measurement results

<input checked="" type="checkbox"/>	No deviations from the technical specifications were ascertained
<input type="checkbox"/>	There were deviations from the technical specifications ascertained
<input type="checkbox"/>	This test report is only a partial test report. The content and verdict of the performed test cases are listed below.

TC Identifier	Description	Verdict	Date	Remark
RF-Testing	CFR47 §15.207, §15.209, §15.503, §15.519, §15.521	see table	2023-02-03	-/-

Test specification clause	Test case	Temperature conditions	Power source	Pass	Fail	NA	NP	Remark
§15.503 §15.519(b)	10 dB Bandwidth	Nominal	Nominal	<input checked="" type="checkbox"/>	<input type="checkbox"/>	<input type="checkbox"/>	<input type="checkbox"/>	complies
§15.209 §15.519 §15.521	TX Radiated Emissions	Nominal	Nominal	<input checked="" type="checkbox"/>	<input type="checkbox"/>	<input type="checkbox"/>	<input type="checkbox"/>	complies
§15.519(a)(1)	Efficient use of spectrum	Nominal	Nominal	<input checked="" type="checkbox"/>	<input type="checkbox"/>	<input type="checkbox"/>	<input type="checkbox"/>	complies
§15.519(a)(2) §15.521 (b) §§15.203 & 15.204	Antenna requirement	-/-	-/-	<input checked="" type="checkbox"/>	<input type="checkbox"/>	<input type="checkbox"/>	<input type="checkbox"/>	complies
§15.521(j) §15.207	Conducted emissions < 30 MHz	Nominal	Nominal	<input checked="" type="checkbox"/>	<input type="checkbox"/>	<input type="checkbox"/>	<input type="checkbox"/>	complies

Note: NA = Not Applicable; NP = Not Performed

11 Additional comments

Reference documents: None

Special test descriptions: None

Configuration descriptions: None

Test mode: No test mode available.
 Special test mode/software is used.

Test device (EUT):

- EUT 1: UWB emissions are turned on and the below described test mode is used ("21_DB_ANCHOR_WFL.bin"(Channel 1), "24_DB_ANCHOR_WFL"(Channel 2)).
- EUT 2: Spare
- EUT 3: UWB emissions are turned on and the normal mode (intended use) is used ("ANCHOR_wfl.bin").

Description of test modes as declared by customer:

- UWB test mode (Test mode 1):
 - Cycle time 1 ms
 - Remaining transmission parameters as in case of normal operation mode
 - Parameters (e.g. payload) selected so that the maximum average and peak output power is obtained

12 Measurement results

12.1 10 dB - Bandwidth

Description:

Measurement of the -10 dB bandwidth of the wanted signal.

§15.503(a)

UWB bandwidth. For the purpose of this subpart, the UWB bandwidth is the frequency band bounded by the points that are 10 dB below the highest radiated emission, as based on the complete transmission system including the antenna. The upper boundary is designated f_H and the lower boundary is designated f_L . The frequency at which the highest radiated emission occurs is designated f_M .

§15.503(b)

Center frequency. The center frequency, f_C , equals $(f_H + f_L)/2$.

§15.503(c)

Fractional bandwidth. The fractional bandwidth equals $2(f_H - f_L) / (f_H + f_L)$.

Measurement:

Measurement parameter	
Detector:	Pos-Peak
Resolution bandwidth:	1 MHz
Video bandwidth:	3 MHz
Trace-Mode:	Max Hold

Limits:

§15.503(d)

Ultra-wideband (UWB) transmitter. An intentional radiator that, at any point in time, has a fractional bandwidth equal to or greater than 0.20 or has a UWB bandwidth equal to or greater than 500 MHz, regardless of the fractional bandwidth.

§15.519(b)

The UWB bandwidth of a device operating under the provisions of this section must be contained between 3100 MHz and 10,600 MHz.

Lower -10 dB point > 3.1 GHz
Upper -10 dB point < 10.6 GHz

-10 dB bandwidth ≥ 500 MHz
or
-10 dB fractional bandwidth > 0.2

Results:

UWB Channel 1

EUT	Lower -10 dB point [GHz]	Higher -10 dB point [GHz]	UWB bandwidth [MHz]	Plot
1	3.166	3.816	650	1

UWB Channel 2

EUT	Lower -10 dB point [GHz]	Higher -10 dB point [GHz]	UWB bandwidth [MHz]	Plot
1	3.663	4.381	718	2

Verdict: Compliant

Plot 1: 10 dB bandwidth, UWB test mode, Channel 1

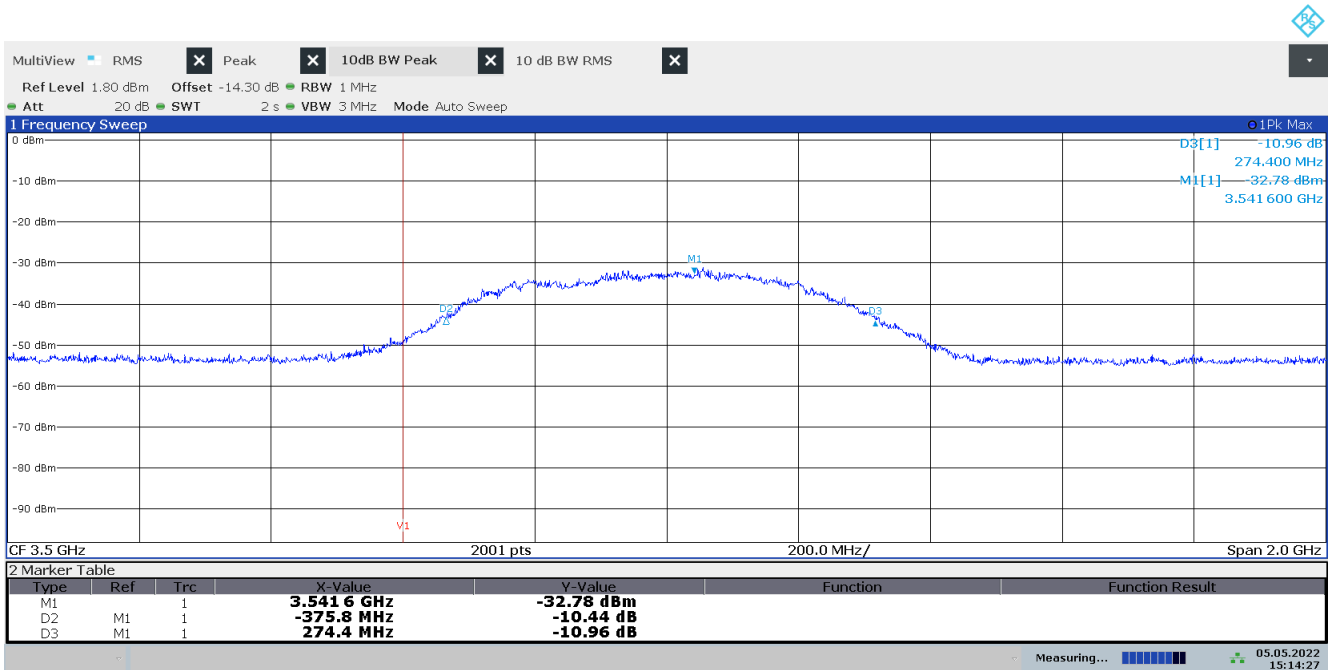

15:14:27 05.05.2022

Plot 2: 10 dB bandwidth, UWB test mode, Channel 2

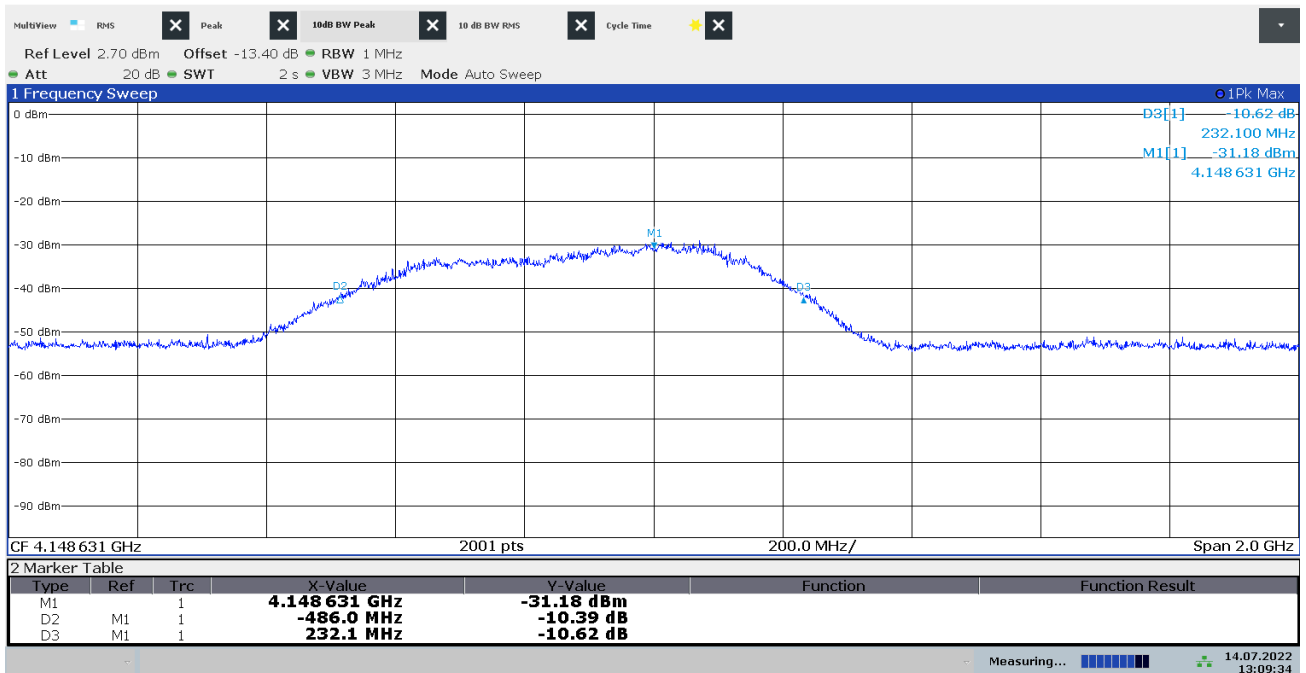

13:09:35 14.07.2022

12.2 TX Radiated Emissions

Description:

Measurement of the radiated emissions in transmit mode.

Measurement:

§15.209:

Measurement parameter	
Detector:	Peak/QPeak
Sweep time:	1 s
Resolution bandwidth:	120kHz
Video bandwidth:	≥ RBW
Trace-Mode:	Max Hold

§15.519(c):

Measurement parameter	
Detector:	RMS
Sweep time:	1 ms/pt
Resolution bandwidth:	1 MHz
Video bandwidth:	3 MHz
Trace-Mode:	Max Hold

§15.519(d):

Measurement parameter	
Detector:	RMS
Sweep time:	1 ms/pt
Resolution bandwidth:	30 kHz / 1 kHz
Video bandwidth:	300 kHz / 3 kHz
Trace-Mode:	Max Hold

§15.519(e):

Measurement parameter	
Detector:	Pos-Peak
Resolution bandwidth:	50 MHz
Video bandwidth:	80 MHz
Span:	Zero span
Trace-Mode:	Max Hold

Limits:**Radiated emissions at or below 960 MHz (§15.209):**

Frequency (MHz)	Field strength ($\mu\text{V}/\text{m}$)	Measurement distance (m)
0.009 – 0.490	2400/F(kHz)	300
0.490 – 1.705	24000/F(kHz)	30
1.705 – 30	30 (29.5 dB $\mu\text{V}/\text{m}$)	30
30 – 88	100 (40 dB $\mu\text{V}/\text{m}$)	3
88 – 216	150 (43.5 dB $\mu\text{V}/\text{m}$)	3
216 – 960	200 (46 dB $\mu\text{V}/\text{m}$)	3
> 960	500 (54 dB $\mu\text{V}/\text{m}$)	3

§15.519 (c)

The radiated emissions at or below 960 MHz from a device operating under the provisions of this section shall not exceed the emission levels in §15.209.

The radiated emissions above 960 MHz from a device operating under the provisions of this section shall not exceed the following average limits based on measurements using a resolution bandwidth of 1 MHz:

Frequency in MHz	EIRP in dBm
960 to 1610	-75.3
1610 to 1990	-63.3
1990 to 3100	-61.3
3100 to 10600	-41.3
Above 10600	-61.3

§15.519 (d)

In addition to the radiated emission limits specified in the table in paragraph of §15.519 (c), UWB transmitters operating under the provisions of this section shall not exceed the following average limits when measured using a resolution bandwidth of no less than 1 kHz:

Frequency in MHz	EIRP in dBm
1164 to 1240	-85.3
1559 to 1610	-85.3

§15.519 (e)

There is a limit on the peak level of the emissions contained within a 50 MHz bandwidth centered on the frequency at which the highest radiated emission occurs, f_m . That limit is 0 dBm EIRP. It is acceptable to employ a different resolution bandwidth, and a correspondingly different peak emission limit, following the procedures described in §15.521.

Further provisions of CFR 47 Part 15 Subpart F:

§15.521 (c)

Emissions from digital circuitry used to enable the operation of the UWB transmitter shall comply with the limits in §15.209, rather than the limits specified in this subpart, provided it can be clearly demonstrated that those emissions from the UWB device are due solely to emissions from digital circuitry contained within the transmitter and that the emissions are not intended to be radiated from the transmitter's antenna. Emissions from associated digital devices, as defined in §15.3(k), e.g., emissions from digital circuitry used to control additional functions or capabilities other than the UWB transmission, are subject to the limits contained in Subpart B of this part.

§15.521 (d)

Within the tables in §§15.509, 15.511, 15.513, 15.515, 15.517, and 15.519, the tighter emission limit applies at the band edges. Radiated emission levels at and below 960 MHz are based on measurements employing a CISPR quasi-peak detector. Radiated emission levels above 960 MHz are based on RMS average measurements over a 1 MHz resolution bandwidth. The RMS average measurement is based on the use of a spectrum analyzer with a resolution bandwidth of 1 MHz, an RMS detector, and a 1 millisecond or less averaging time. Unless otherwise stated, if pulse gating is employed where the transmitter is quiescent for intervals that are long compared to the nominal pulse repetition interval, measurements shall be made with the pulse train gated on. Alternative measurement procedures may be considered by the Commission.

§15.521(e)

The frequency at which the highest radiated emission occurs, f_M , must be contained within the UWB bandwidth.

§15.521(g)

When a peak measurement is required, it is acceptable to use a resolution bandwidth other than the 50 MHz specified in this subpart. This resolution bandwidth shall not be lower than 1 MHz or greater than 50 MHz, and the measurement shall be centered on the frequency at which the highest radiated emission occurs, f_M . If a resolution bandwidth other than 50 MHz is employed, the peak EIRP limit shall be $20 \log(RBW/50)$ dBm where RBW is the resolution bandwidth in megahertz that is employed. This may be converted to a peak field strength level at 3 meters using $E(\text{dBuV/m}) = P(\text{dBm EIRP}) + 95.2$. If RBW is greater than 3 MHz, the application for certification filed with the Commission must contain a detailed description of the test procedure, calibration of the test setup, and the instrumentation employed in the testing.

§15.521(h)

The highest frequency employed in §15.33 to determine the frequency range over which radiated measurements are made shall be based on the center frequency, f_C , unless a higher frequency is generated within the UWB device. For measuring emission levels, the spectrum shall be investigated from the lowest frequency generated in the UWB transmitter, without going below 9 kHz, up to the frequency range shown in §15.33(a) or up to $f_C + 3/(\text{pulse width in seconds})$, whichever is higher. There is no requirement to measure emissions beyond 40 GHz provided f_C is less than 10 GHz; beyond 100 GHz if f_C is at or above 10 GHz and below 30 GHz; or beyond 200 GHz if f_C is at or above 30 GHz.

Results:Measurements of the fundamental emission:**UWB Channel 1**

EUT	Frequency [GHz]	Max e.i.r.p. [dBm/MHz]	Applicable limit [dBm/MHz]	Margin [dB]	Plot
		average value			
1	3.542	-46.3	-41.3	5.0	3

EUT	Frequency [GHz]	Max e.i.r.p. [dBm/50 MHz]	Applicable limit [dBm/50 MHz]	Margin [dB]	Plot
		peak value			
1	3.542	-8.2	0	8.2	5

UWB Channel 2

EUT	Frequency [GHz]	Max e.i.r.p. [dBm/MHz]	Applicable limit [dBm/MHz]	Margin [dB]	Plot
		average value			
1	4.149	-43.6	-41.3	2.3	4

EUT	Frequency [GHz]	Max e.i.r.p. [dBm/50 MHz]	Applicable limit [dBm/50 MHz]	Margin [dB]	Plot
		peak value			
1	4.149	-2.0	0	-2.0	6

Emissions outside the band:

Frequency f [MHz]	Detector	Measured level [dB μ V/m]	Limit [dB μ V/m]	Margin [dB]
No critical peaks found. For details, please refer to plots.				
-/-	-/-	-/-	-/-	-/-
-/-	-/-	-/-	-/-	-/-
-/-	-/-	-/-	-/-	-/-

Frequency f [MHz]	Detector	Measured level [dBm]	Limit [dBm]	Margin [dB]
No critical peaks found. For details, please refer to plots.				
-/-	-/-	-/-	-/-	-/-
-/-	-/-	-/-	-/-	-/-
-/-	-/-	-/-	-/-	-/-

Verdict: Compliant

Plot 3: Fundamental emission (UWB test mode): RMS, Channel 1

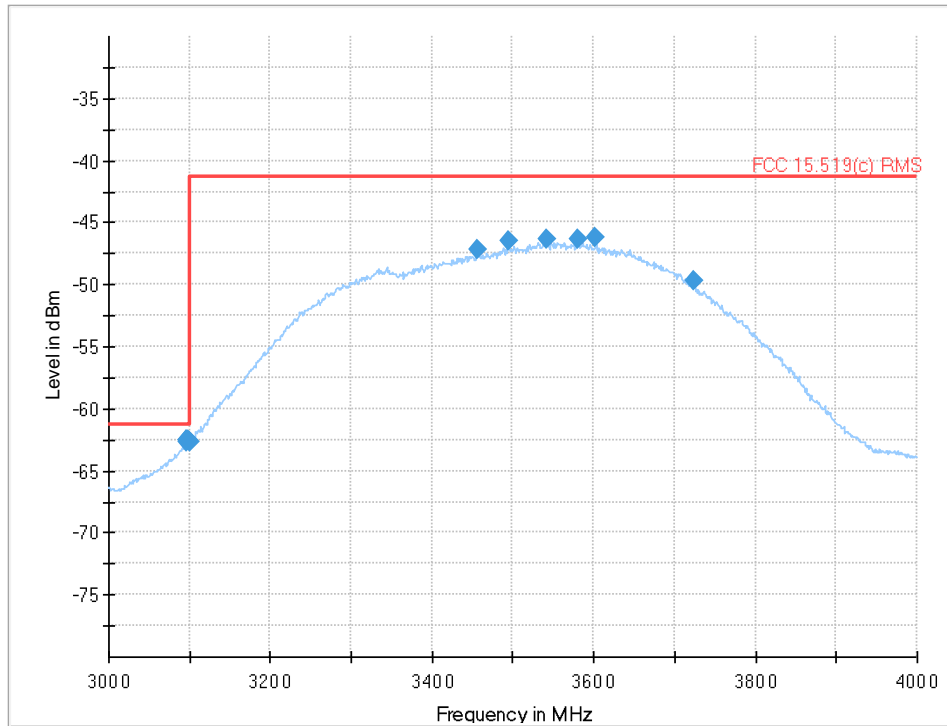

Frequency (MHz)	RMS (dBm)	Limit (dBm)	Margin (dB)	Bandwidth (kHz)	Pol	Azimuth (deg)	Elevation (deg)	Corr. (dB)
3095.850000	-62.57	-61.30	1.27	1000.000	H	17.0	180.0	-122.4
3095.871000	-62.51	-61.30	1.21	1000.000	H	323.0	1.0	-122.4
3096.686000	-62.73	-61.30	1.43	1000.000	H	21.0	159.0	-122.3
3098.922000	-62.53	-61.30	1.23	1000.000	H	16.0	169.0	-122.3
3099.759000	-62.63	-61.30	1.33	1000.000	H	20.0	165.0	-122.3
3457.091000	-47.23	-41.30	5.93	1000.000	H	307.0	22.0	-121.7
3494.334000	-46.43	-41.30	5.13	1000.000	H	306.0	20.0	-121.5
3541.668000	-46.31	-41.30	5.01	1000.000	H	317.0	24.0	-121.3
3579.998000	-46.40	-41.30	5.10	1000.000	H	314.0	20.0	-121.2
3723.933000	-49.69	-41.30	8.39	1000.000	H	311.0	6.0	-120.6

Plot 4: Fundamental emission (UWB test mode): RMS, Channel 2

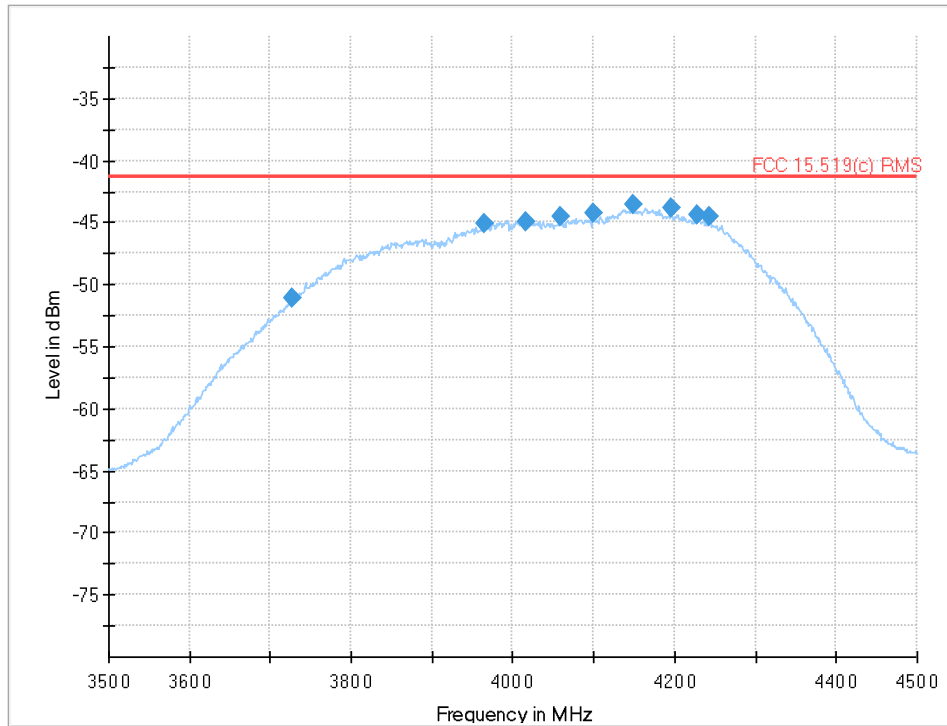

Frequency (MHz)	RMS (dBm)	Limit (dBm)	Margin (dB)	Bandwidth (kHz)	Pol	Azimuth (deg)	Elevation (deg)	Corr. (dB)
3726.835000	-51.02	-41.30	9.72	1000.000	H	315.0	95.0	-120.7
3965.501000	-45.13	-41.30	3.83	1000.000	V	199.0	13.0	-119.9
4016.711000	-44.89	-41.30	3.59	1000.000	V	198.0	14.0	-120.4
4058.966000	-44.56	-41.30	3.26	1000.000	H	309.0	116.0	-120.4
4099.218000	-44.20	-41.30	2.90	1000.000	H	306.0	114.0	-120.7
4148.631000	-43.58	-41.30	2.28	1000.000	H	305.0	113.0	-120.4
4195.833000	-43.86	-41.30	2.57	1000.000	H	302.0	112.0	-119.6
4228.105000	-44.39	-41.30	3.09	1000.000	V	208.0	25.0	-120.9
4243.226000	-44.46	-41.30	3.16	1000.000	V	208.0	26.0	-121.0

Plot 5: Fundamental emission (UWB test mode): Max Peak, Channel 1

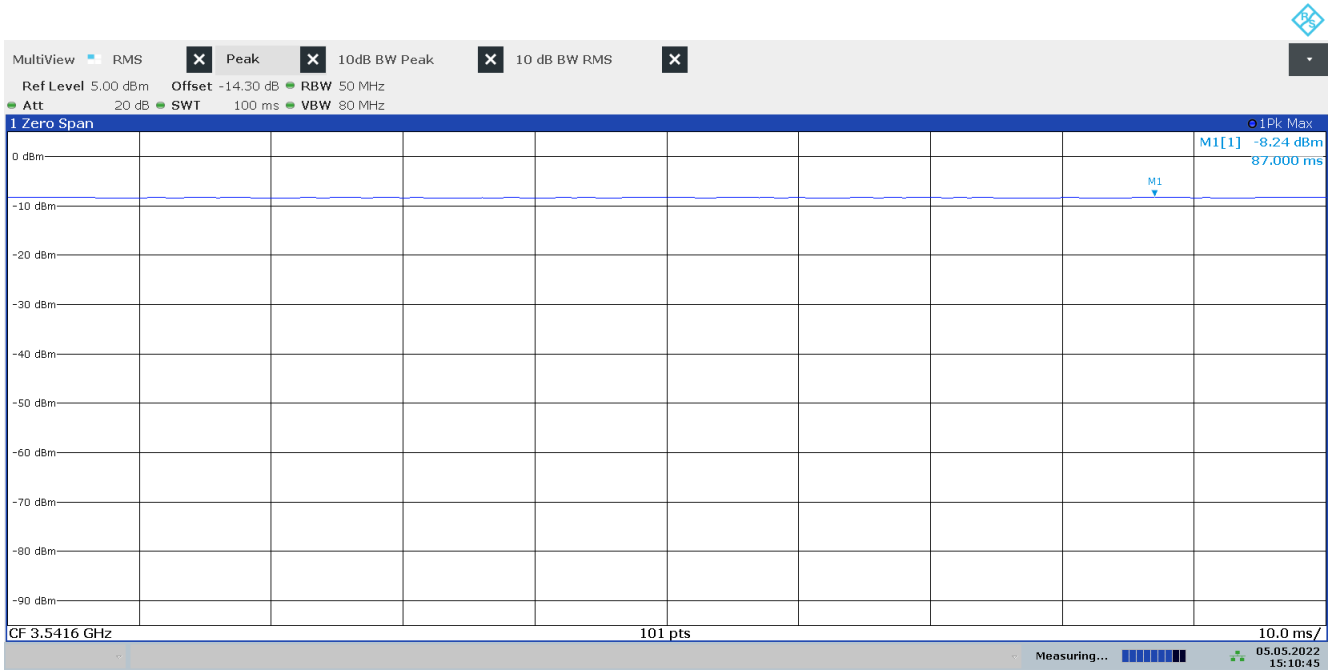

15:10:46 05.05.2022

Plot 6: Fundamental emission (UWB test mode): Max Peak, Channel 2

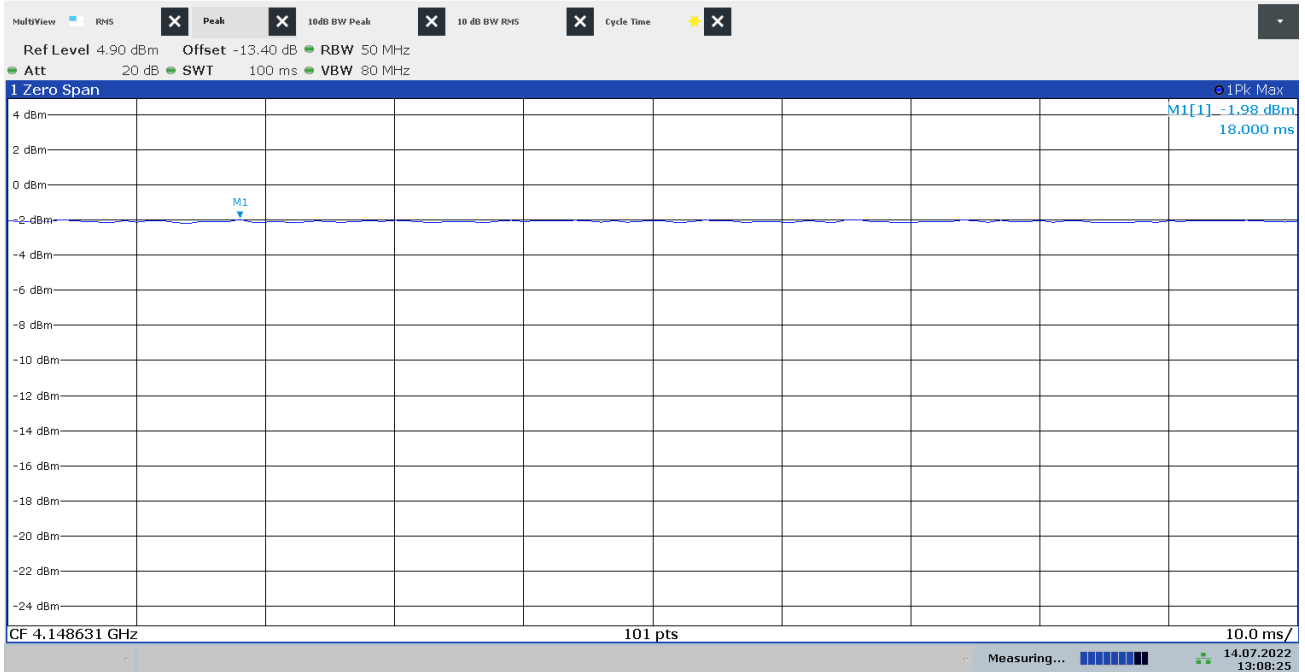

13:08:25 14.07.2022

Plot 7: 9 kHz to 30 MHz, UWB test mode, Channel 1

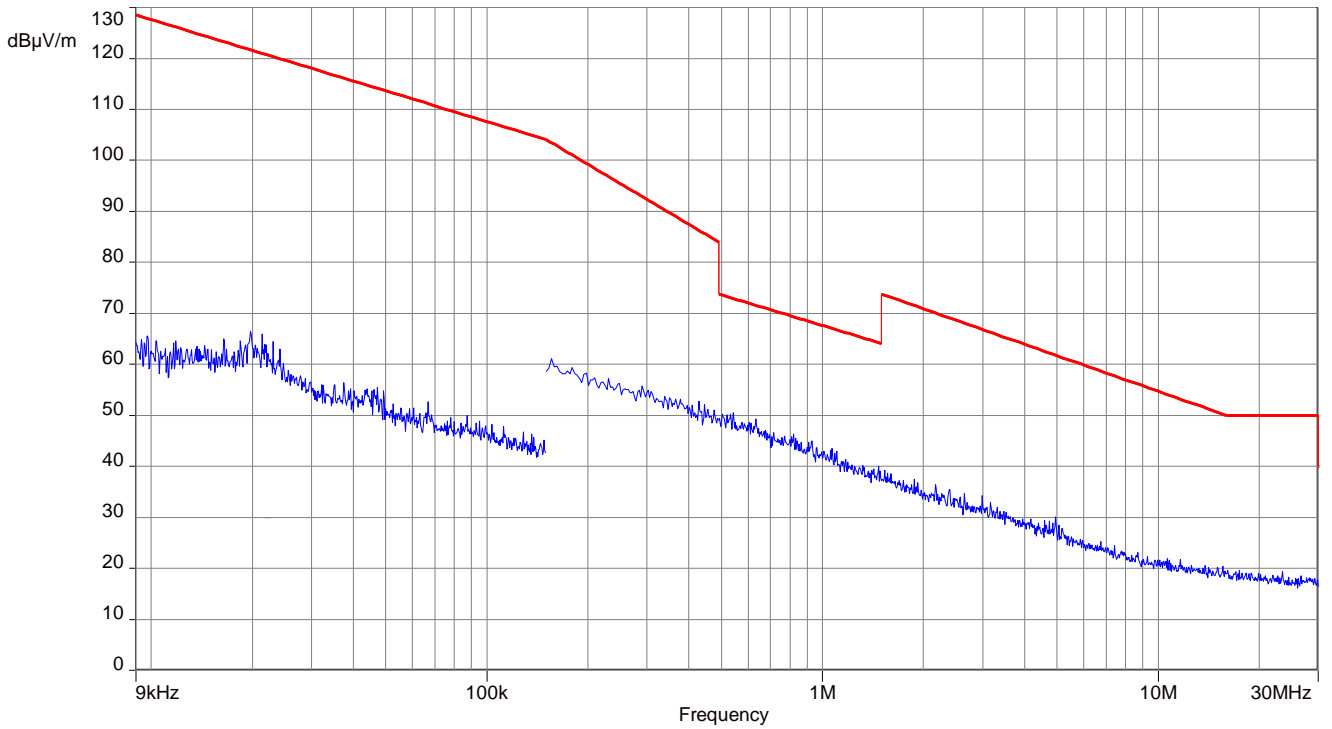

Plot 8: 9 kHz to 30 MHz, UWB test mode, Channel 2

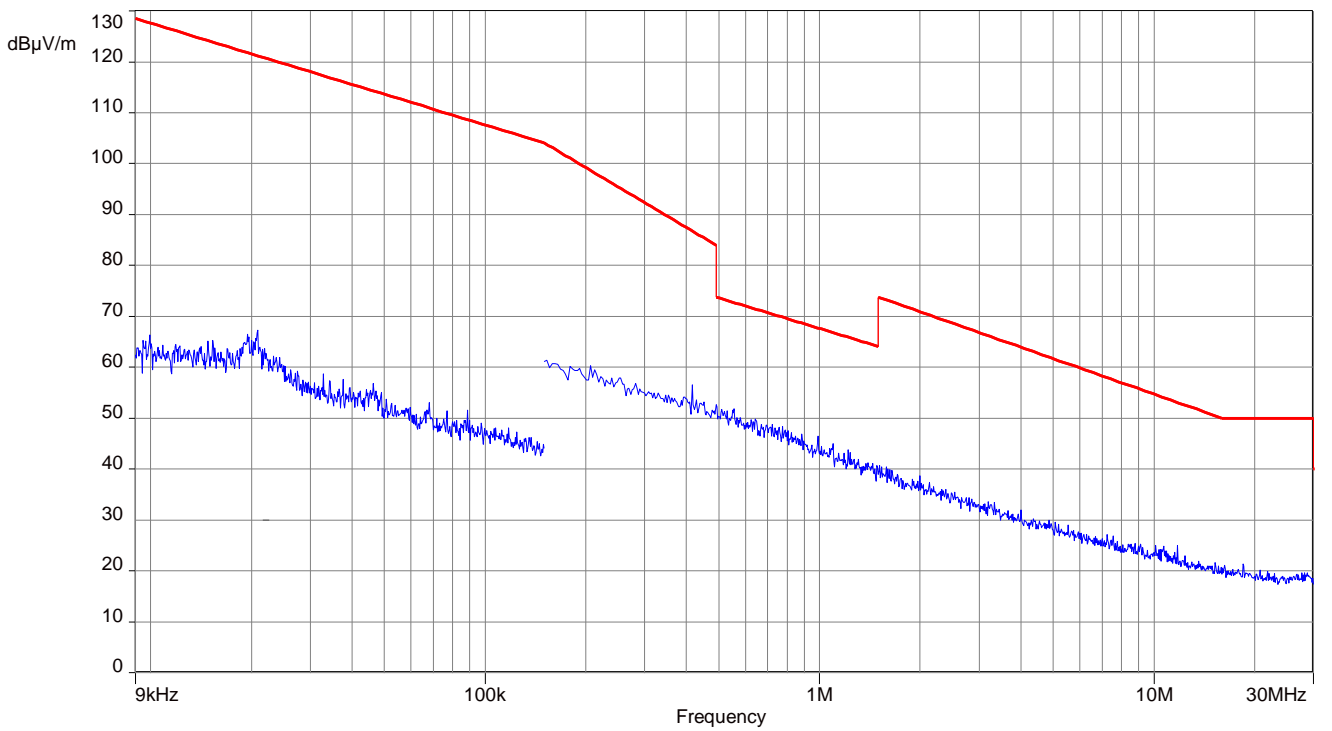

Plot 9: 30 MHz to 1 GHz, UWB test mode, Channel 1

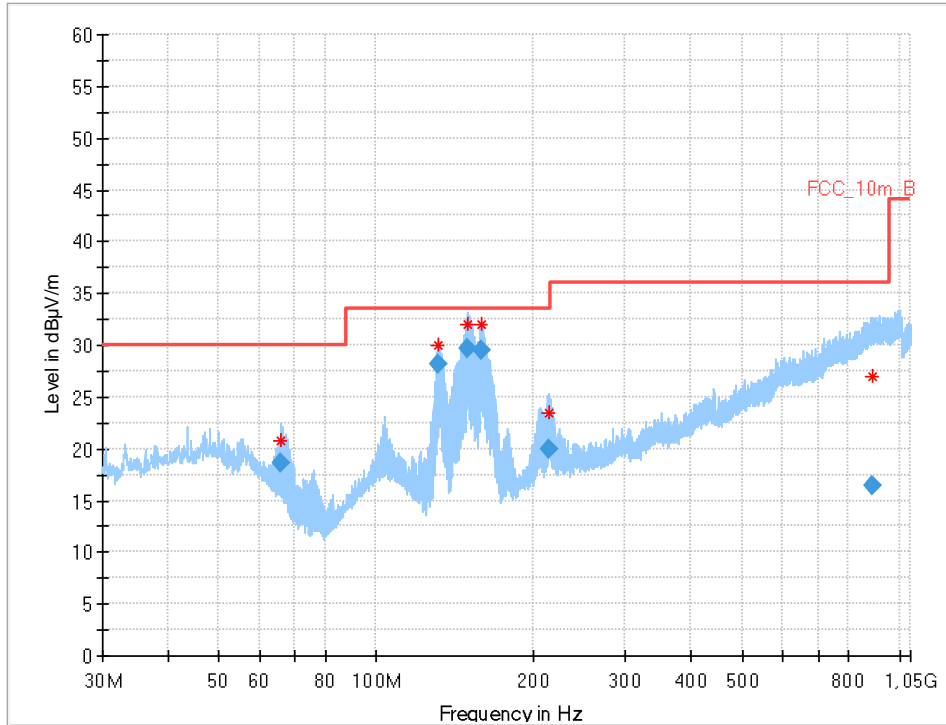

Frequency (MHz)	QuasiPeak (dBµV/m)	Limit (dBµV/m)	Margin (dB)	Meas. Time (ms)	Bandwidth (kHz)	Height (cm)	Pol	Azimuth (deg)	Corr. (dB/m)
65.818	18.53	30.0	11.5	1000	120.0	293.0	V	295	12
131.636	28.18	33.5	5.3	1000	120.0	112.0	V	283	10
149.371	29.68	33.5	3.8	1000	120.0	103.0	V	0	10
158.863	29.43	33.5	4.1	1000	120.0	114.0	V	0	10
213.939	19.92	33.5	13.6	1000	120.0	200.0	V	135	13
888.130	16.46	36.0	19.5	1000	120.0	200.0	H	57	25

Plot 10: 30 MHz to 1 GHz, UWB test mode, Channel 2

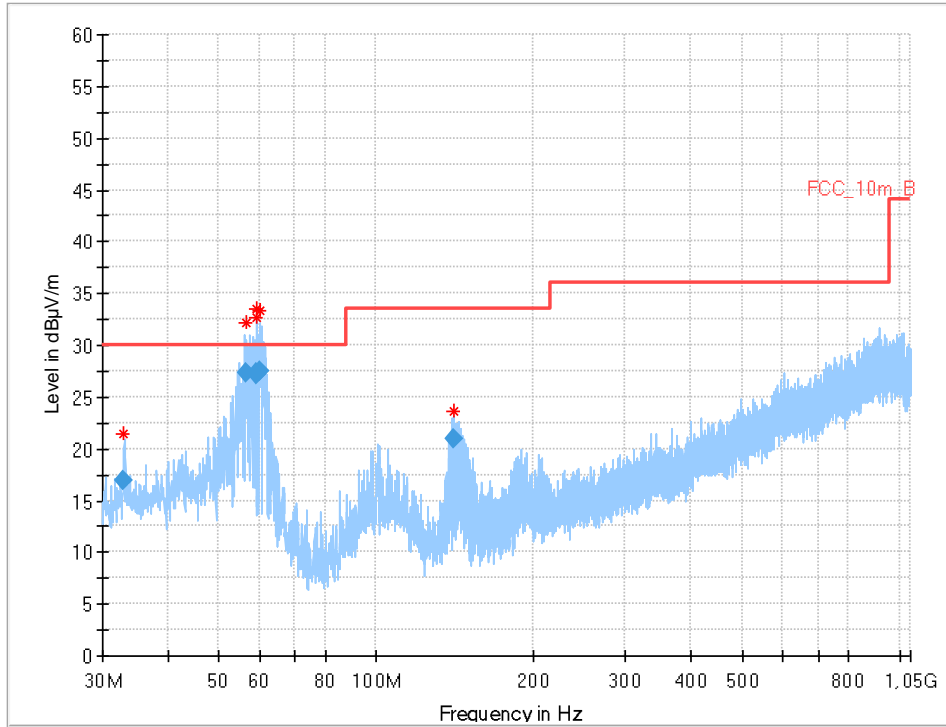

Frequency (MHz)	QuasiPeak (dBµV/m)	Limit (dBµV/m)	Margin (dB)	Meas. Time (ms)	Bandwidth (kHz)	Height (cm)	Pol	Azimuth (deg)	Corr. (dB/m)
32.974	16.94	30.0	13.1	1000	120.0	170.0	H	264	14
56.552	27.37	30.0	2.6	1000	120.0	98.0	V	286	16
58.923	27.08	30.0	2.9	1000	120.0	195.0	V	237	15
59.184	27.25	30.0	2.8	1000	120.0	195.0	V	107	15
60.126	27.41	30.0	2.6	1000	120.0	195.0	V	217	14
140.632	20.97	33.5	12.5	1000	120.0	115.0	V	-13	10

Plot 11: 960 MHz to 3.2 GHz (Limit acc. to §15.519 (c)), UWB test mode, Channel 1

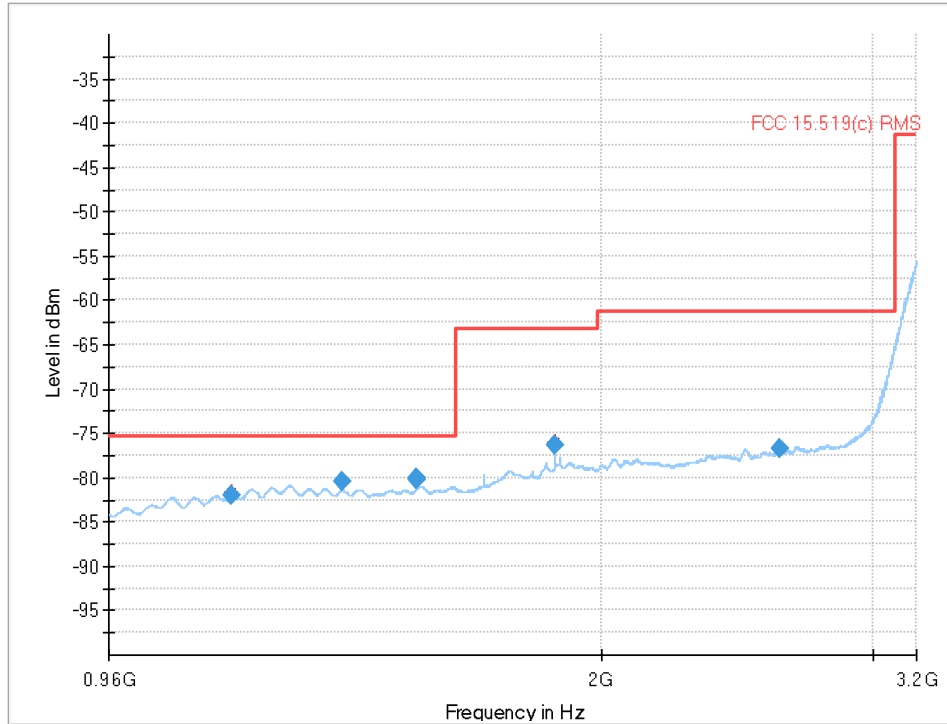

Frequency (MHz)	RMS (dBm)	Limit (dBm)	Margin (dB)	Bandwidth (kHz)	Pol	Azimuth (deg)	Elevation (deg)	Corr. (dB)
1152.112800	-81.93	-75.30	6.63	1000.000	H	338.0	121.0	-139.4
1360.164200	-80.35	-75.30	5.05	1000.000	H	347.0	105.0	-138.2
1520.022200	-80.01	-75.30	4.71	1000.000	V	224.0	127.0	-138.1
1520.346200	-80.17	-75.30	4.87	1000.000	V	219.0	118.0	-138.1
1866.693800	-76.30	-63.30	13.00	1000.000	H	140.0	30.0	-135.6
2609.459000	-76.82	-61.30	15.52	1000.000	H	-4.0	40.0	-133.0

Plot 12: 960 MHz to 3.2 GHz (Limit acc. to §15.519 (c)), UWB test mode, Channel 2

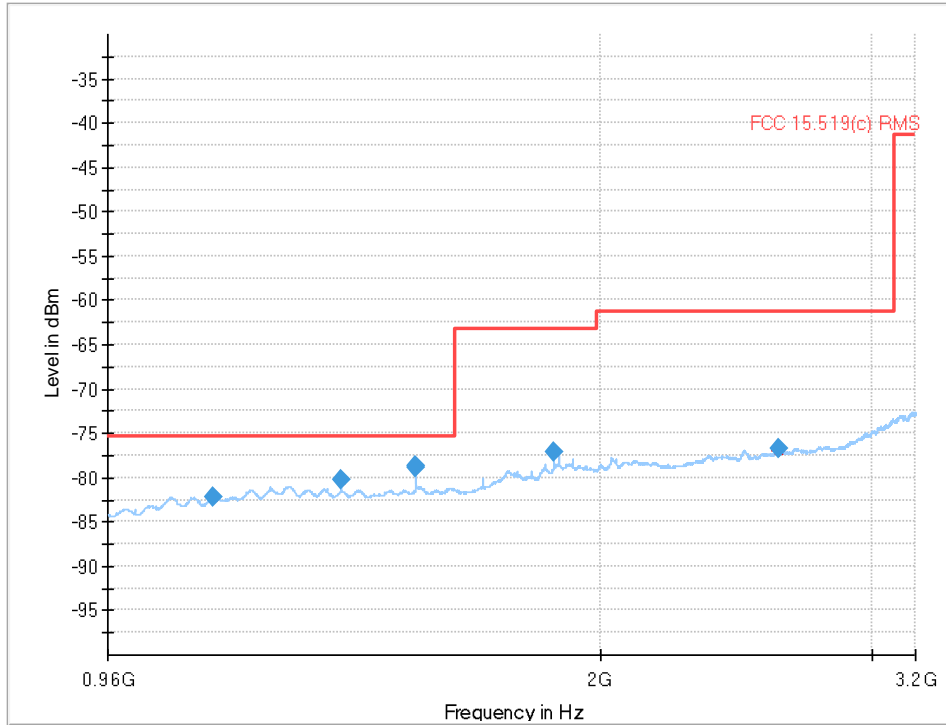

Frequency (MHz)	RMS (dBm)	Limit (dBm)	Margin (dB)	Bandwidth (kHz)	Pol	Azimuth (deg)	Elevation (deg)	Corr. (dB)
1124.931600	-82.18	-75.30	6.88	1000.000	H	207.0	195.0	-138.8
1360.200200	-80.26	-75.30	4.96	1000.000	H	205.0	170.0	-138.2
1520.141600	-78.85	-75.30	3.55	1000.000	H	190.0	140.0	-138.0
1520.252600	-78.76	-75.30	3.46	1000.000	H	189.0	141.0	-138.0
1866.720800	-77.17	-63.30	13.87	1000.000	H	197.0	53.0	-135.6
2608.506800	-76.81	-61.30	15.51	1000.000	H	234.0	144.0	-133.0

Plot 13: 3 GHz to 10 GHz, UWB test mode, Channel 1

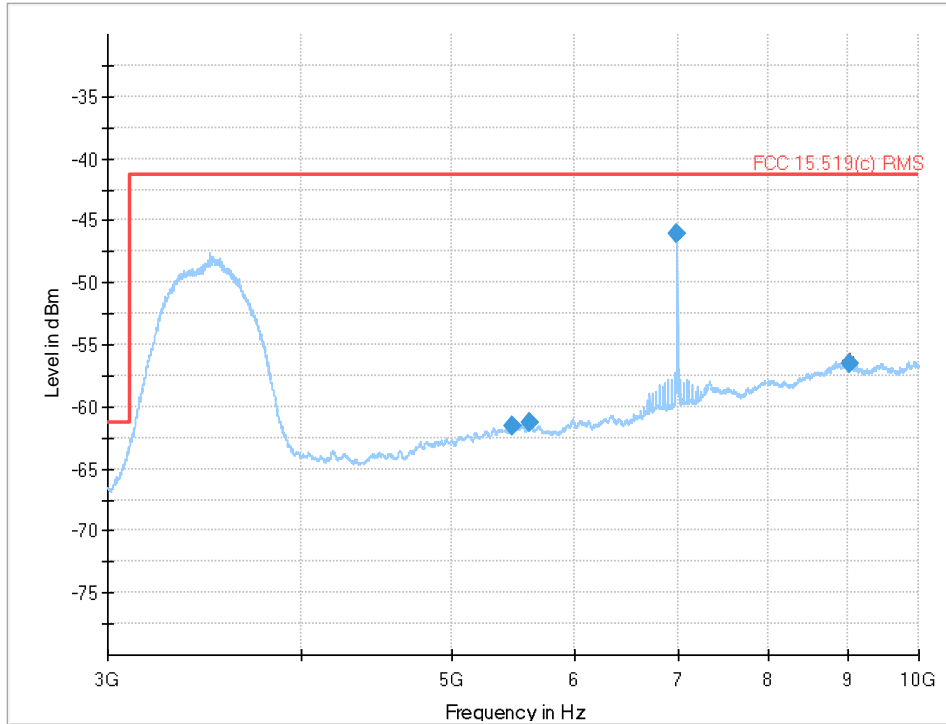

Frequency (MHz)	RMS (dBm)	Limit (dBm)	Margin (dB)	Bandwidth (kHz)	Pol	Azimuth (deg)	Elevation (deg)	Corr. (dB)
5467.910571	-61.61	-41.30	20.31	1000.000	H	0.0	111.0	-117.3
5607.646714	-61.33	-41.30	20.03	1000.000	H	293.0	1.0	-116.8
6988.731714	-46.00	-41.30	4.70	1000.000	V	296.0	126.0	-116.7
9029.626000	-56.52	-41.30	15.22	1000.000	H	235.0	77.0	-111.9

Plot 14: 3 GHz to 10 GHz, UWB test mode, Channel 2

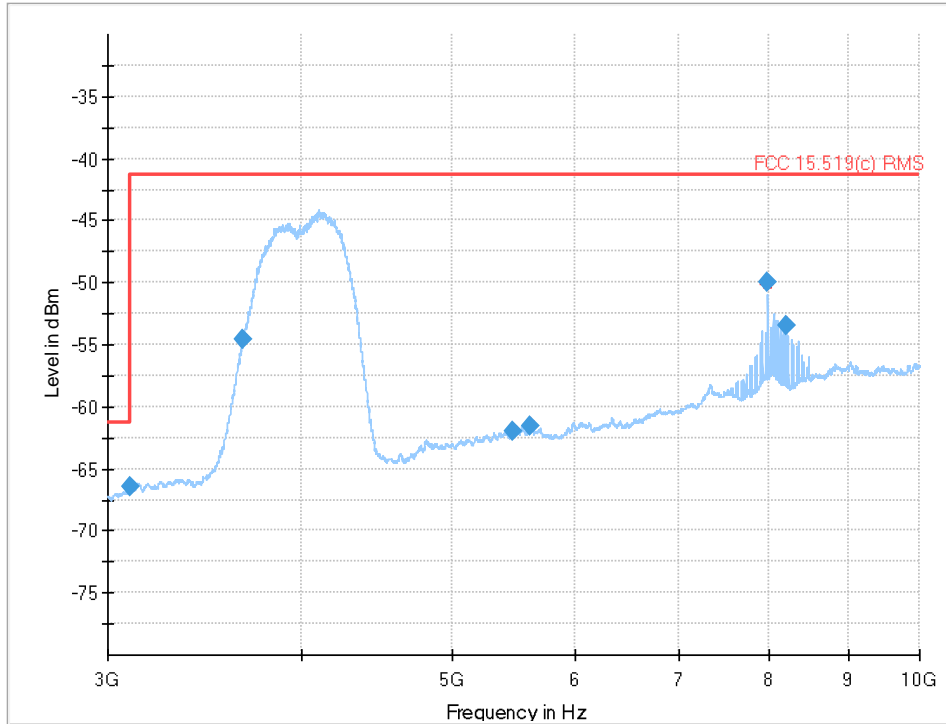

Frequency (MHz)	RMS (dBm)	Limit (dBm)	Margin (dB)	Bandwidth (kHz)	Pol	Azimuth (deg)	Elevation (deg)	Corr. (dB)
3099.997714	-66.50	-61.30	5.20	1000.000	H	-8.0	68.0	-122.3
3665.487286	-54.57	-41.30	13.27	1000.000	H	330.0	108.0	-121.7
5465.947714	-62.01	-41.30	20.71	1000.000	H	236.0	131.0	-117.2
5616.642000	-61.54	-41.30	20.24	1000.000	H	40.0	175.0	-117.1
7987.175286	-50.04	-41.30	8.74	1000.000	V	233.0	170.0	-114.7
8205.554286	-53.45	-41.30	12.15	1000.000	V	90.0	164.0	-114.9

Plot 15: 10 GHz to 18 GHz, UWB test mode, Channel 1

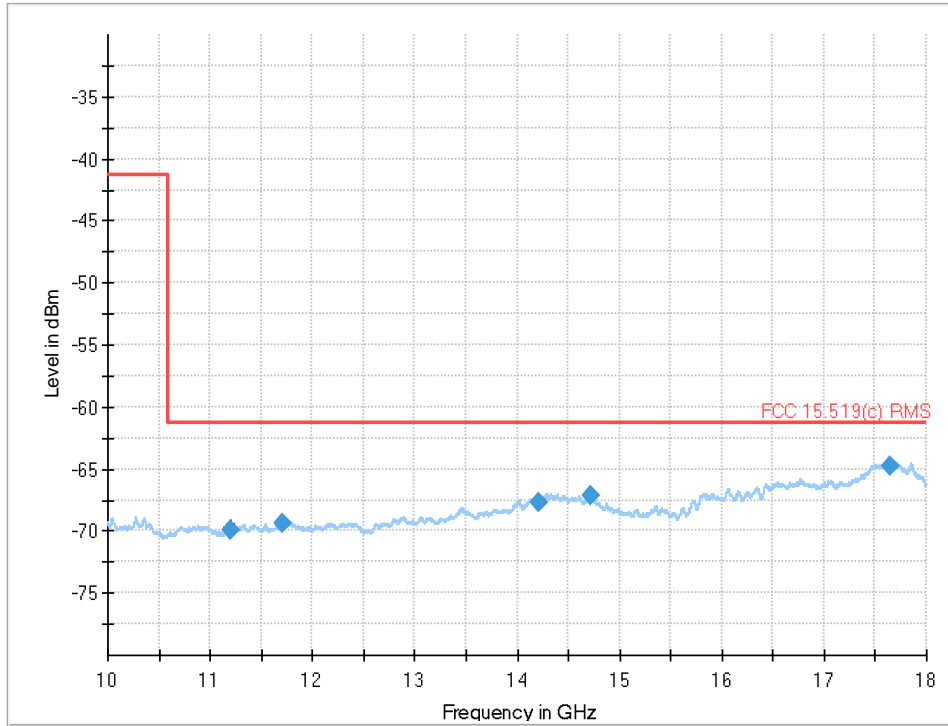

Frequency (MHz)	RMS (dBm)	Limit (dBm)	Margin (dB)	Bandwidth (kHz)	Pol	Azimuth (deg)	Elevation (deg)	Corr. (dB)
11206.746000	-69.90	-61.30	8.60	1000.000	V	19.0	119.0	-125.7
11699.912000	-69.37	-61.30	8.07	1000.000	V	275.0	46.0	-126.1
14205.041000	-67.74	-61.30	6.44	1000.000	V	324.0	33.0	-122.4
14725.355000	-67.19	-61.30	5.89	1000.000	V	49.0	0.0	-121.3
17642.021000	-64.73	-61.30	3.43	1000.000	V	82.0	4.0	-116.4

Plot 16: 10 GHz to 18 GHz, UWB test mode, Channel 2

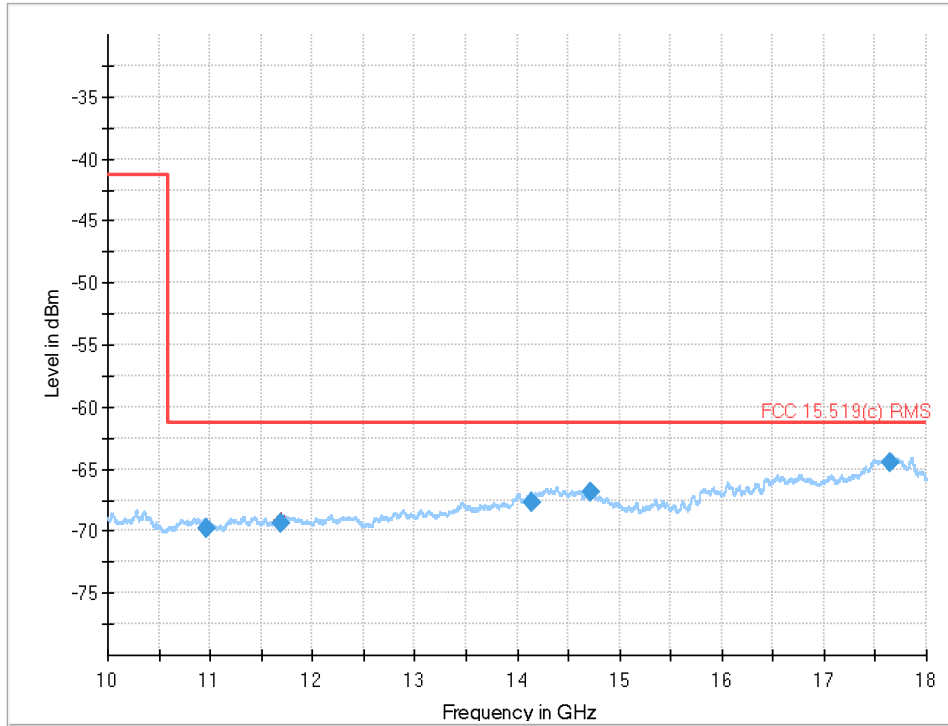

Frequency (MHz)	RMS (dBm)	Limit (dBm)	Margin (dB)	Bandwidth (kHz)	Pol	Azimuth (deg)	Elevation (deg)	Corr. (dB)
10956.643000	-69.84	-61.30	8.54	1000.000	V	15.0	2.0	-126.3
11699.152000	-69.34	-61.30	8.04	1000.000	V	66.0	1.0	-126.0
14136.845000	-67.65	-61.30	6.35	1000.000	V	80.0	10.0	-121.7
14723.419000	-66.82	-61.30	5.52	1000.000	V	125.0	8.0	-121.2
17648.276000	-64.47	-61.30	3.17	1000.000	V	-5.0	13.0	-116.4

Plot 17: 18 GHz to 26.5 GHz, UWB test mode, Channel 1

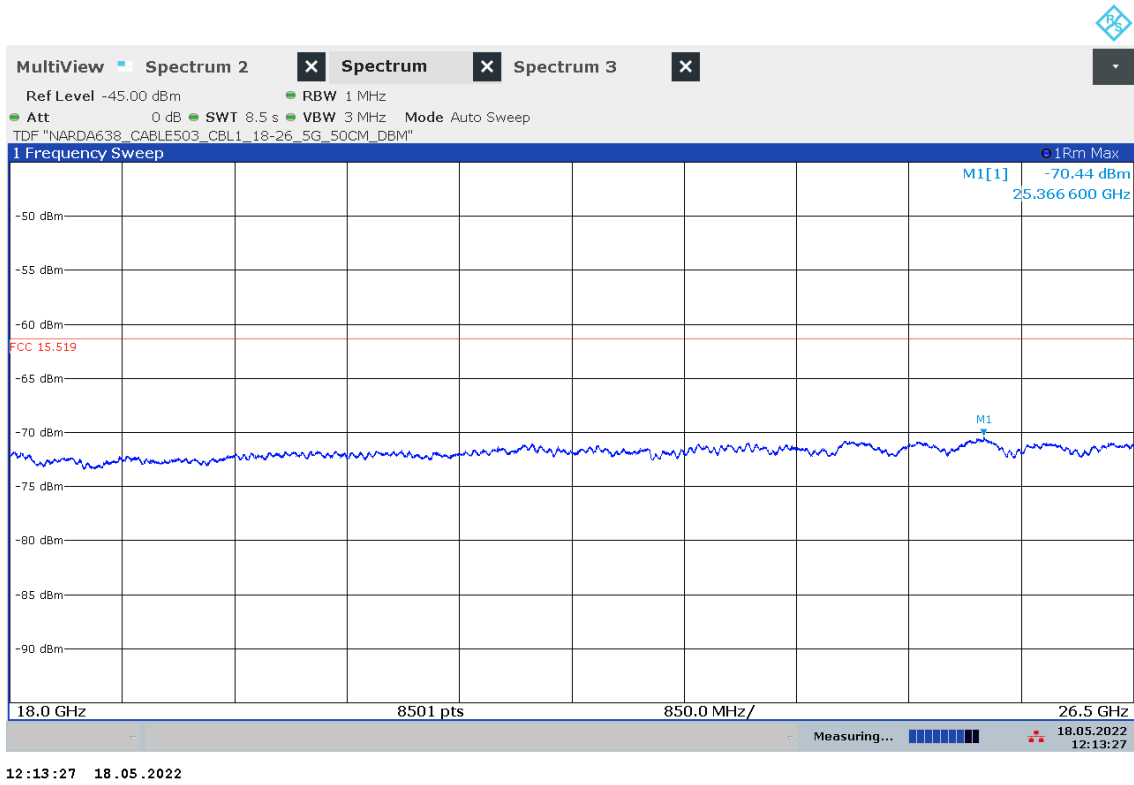

Plot 18: 18 GHz to 26.5 GHz, UWB test mode, Channel 2

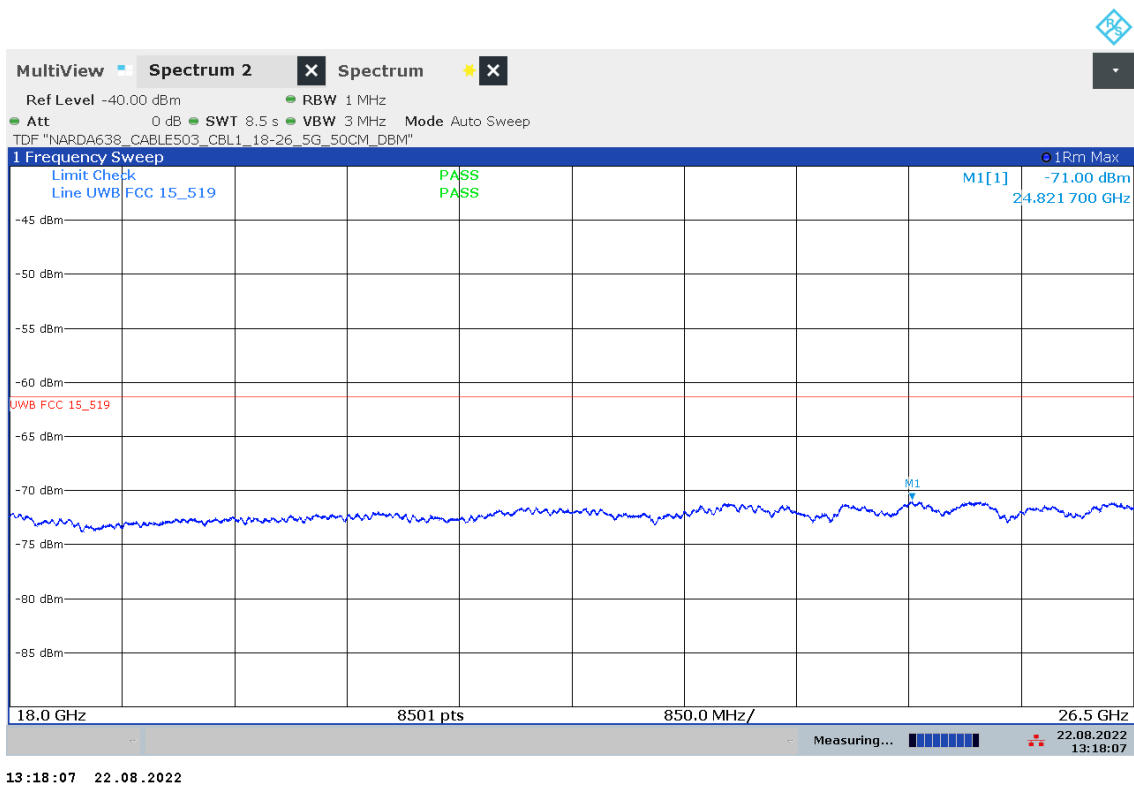

Plot 19: 26.5 GHz to 40.0 GHz, UWB test mode, Channel 1

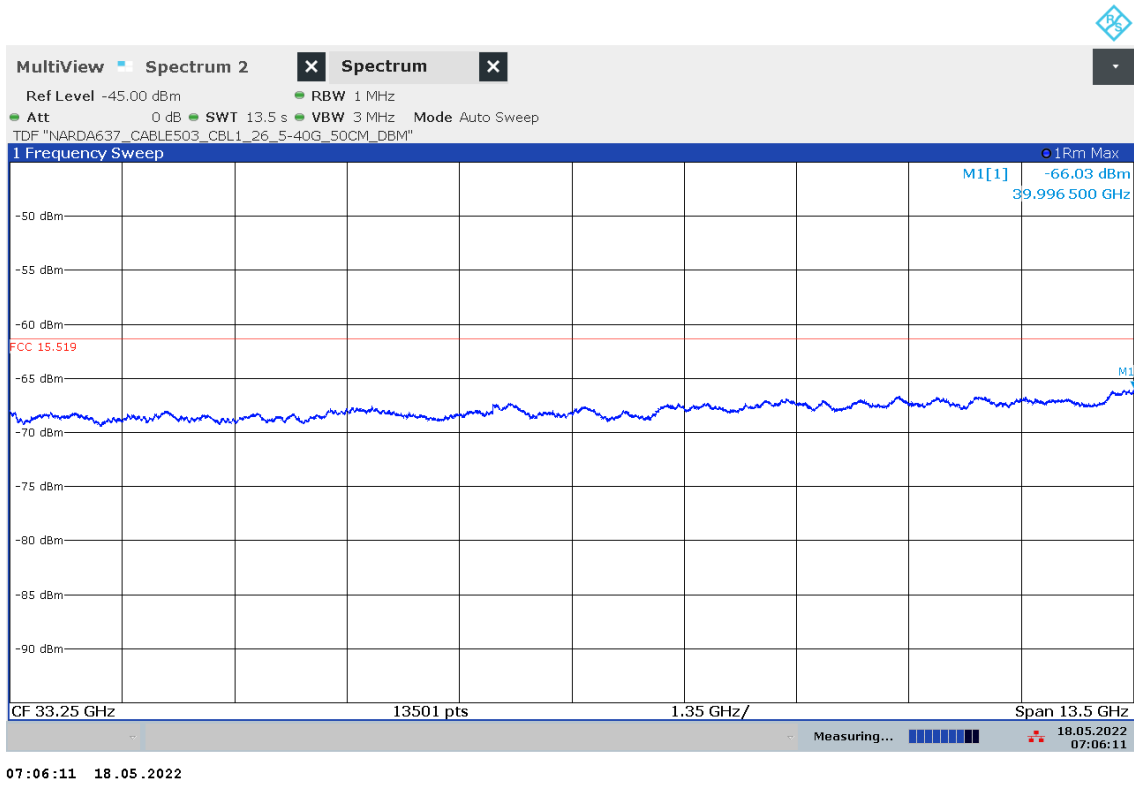

Plot 20: 26.5 GHz to 40.0 GHz, UWB test mode, Channel 2

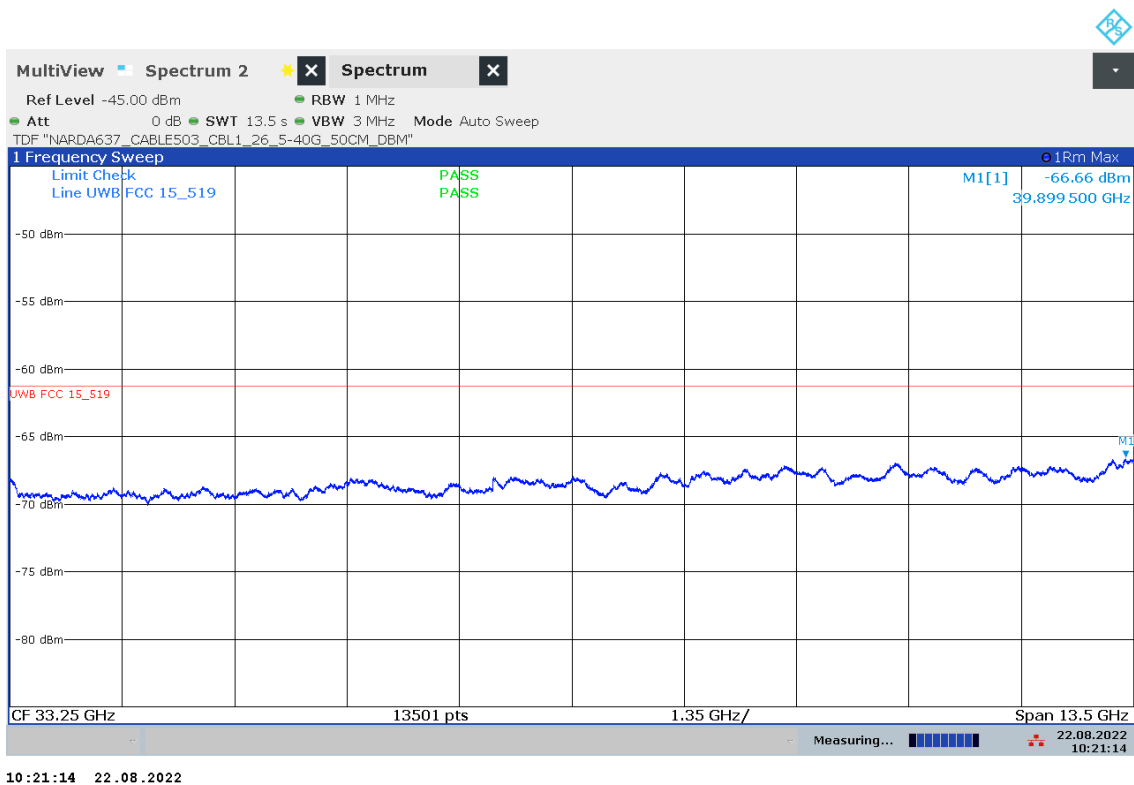

Plot 21: 1164 MHz to 1240 MHz (§15.519 (d)), UWB test mode, Channel 1

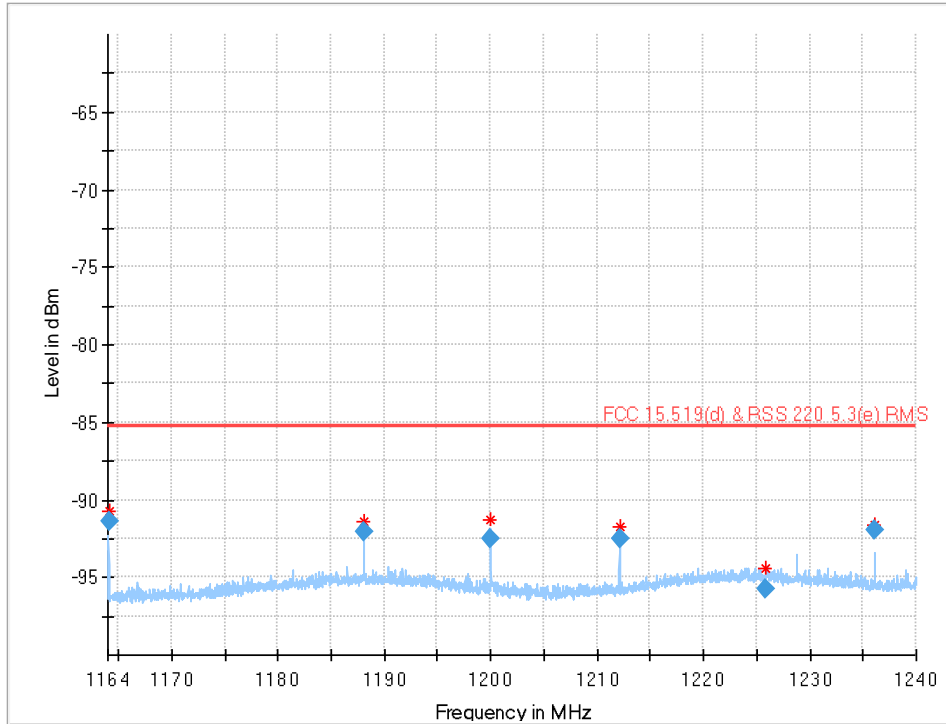

Frequency (MHz)	RMS (dBm)	Limit (dBm)	Margin (dB)	Bandwidth (kHz)	Pol	Azimuth (deg)	Elevation (deg)	Corr. (dB)
1164.092950	-91.38	-85.30	6.08	30.000	H	5.0	96.0	-139.8
1188.094130	-92.11	-85.30	6.81	30.000	V	-1.0	15.0	-138.3
1200.000137	-92.53	-85.30	7.23	30.000	V	352.0	23.0	-139.5
1212.099450	-92.56	-85.30	7.26	30.000	V	345.0	23.0	-139.3
1225.850773	-95.78	-85.30	10.48	30.000	V	147.0	177.0	-138.1
1236.097300	-91.91	-85.30	6.61	30.000	H	-6.0	107.0	-139.3

Plot 22: 1164 MHz to 1240 MHz (§15.519 (d)), UWB test mode, Channel 2

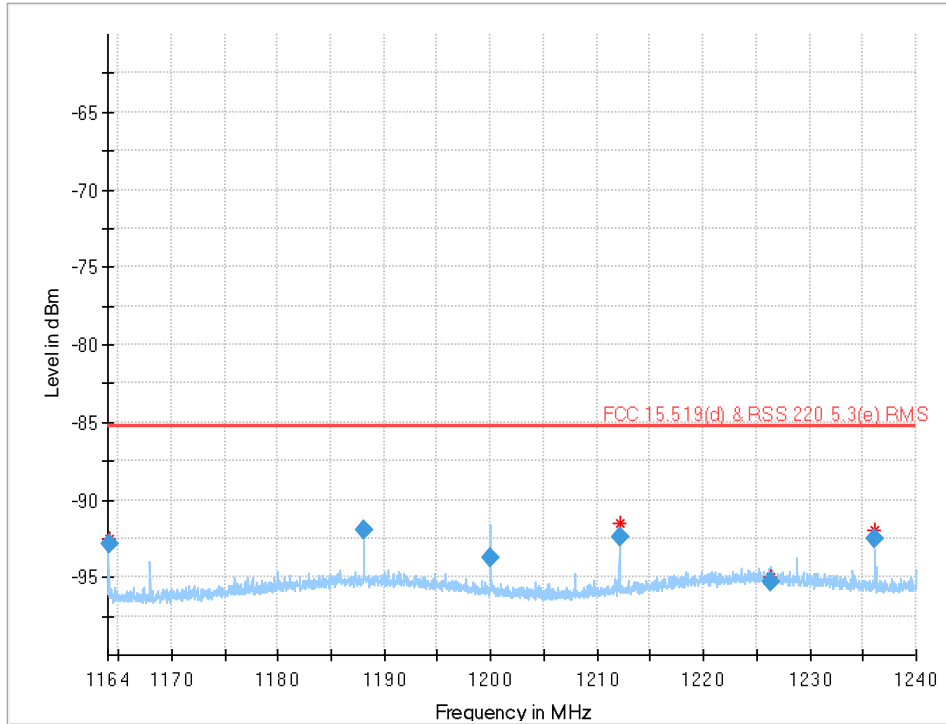

Frequency (MHz)	RMS (dBm)	Limit (dBm)	Margin (dB)	Bandwidth (kHz)	Pol	Azimuth (deg)	Elevation (deg)	Corr. (dB)
1164.093220	-92.86	-85.30	7.56	30.000	H	349.0	31.0	-139.8
1188.094100	-91.98	-85.30	6.68	30.000	V	14.0	133.0	-138.3
1199.995577	-93.72	-85.30	8.42	30.000	V	113.0	37.0	-139.5
1212.099540	-92.45	-85.30	7.15	30.000	V	3.0	114.0	-139.3
1226.344253	-95.34	-85.30	10.04	30.000	V	56.0	72.0	-138.1
1236.106960	-92.55	-85.30	7.25	30.000	H	-4.0	30.0	-139.3

Plot 23: 1559 MHz to 1610 MHz (§15.519 (d)), UWB test mode, Channel 1

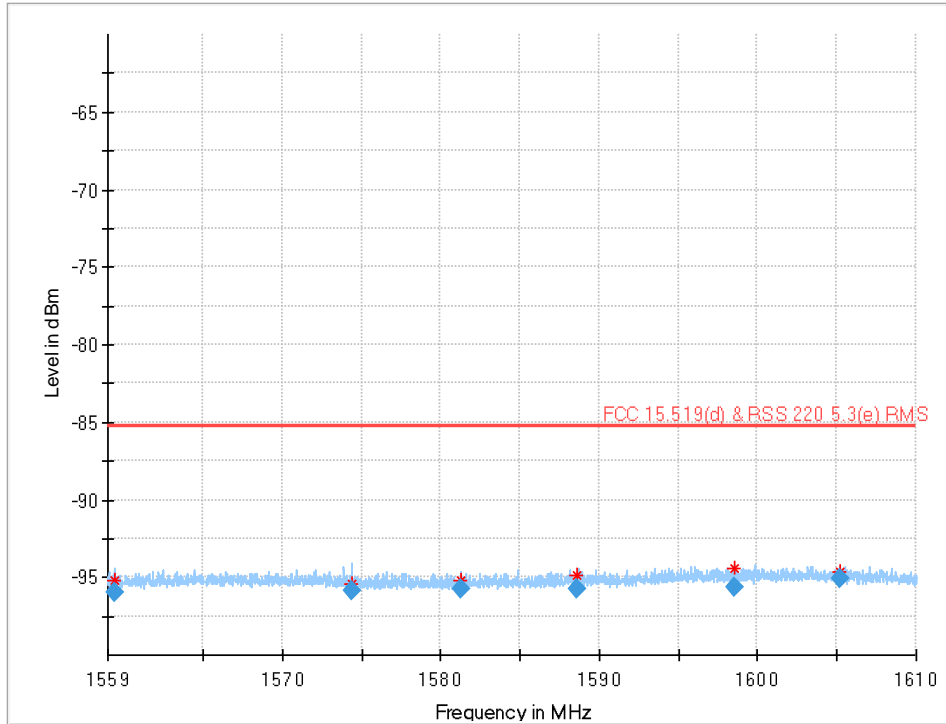

Frequency (MHz)	RMS (dBm)	Limit (dBm)	Margin (dB)	Bandwidth (kHz)	Pol	Azimuth (deg)	Elevation (deg)	Corr. (dB)
1559.452830	-95.94	-85.30	10.64	30.000	H	215.0	14.0	-138.3
1574.418380	-95.85	-85.30	10.55	30.000	V	109.0	4.0	-138.7
1581.300150	-95.73	-85.30	10.43	30.000	H	214.0	156.0	-138.8
1588.625310	-95.71	-85.30	10.41	30.000	H	196.0	177.0	-138.4
1598.501590	-95.69	-85.30	10.39	30.000	H	49.0	114.0	-137.8
1605.239070	-95.06	-85.30	9.76	30.000	H	205.0	25.0	-138.0

Plot 24: 1559 MHz to 1610 MHz (§15.519 (d)), UWB test mode, Channel 2

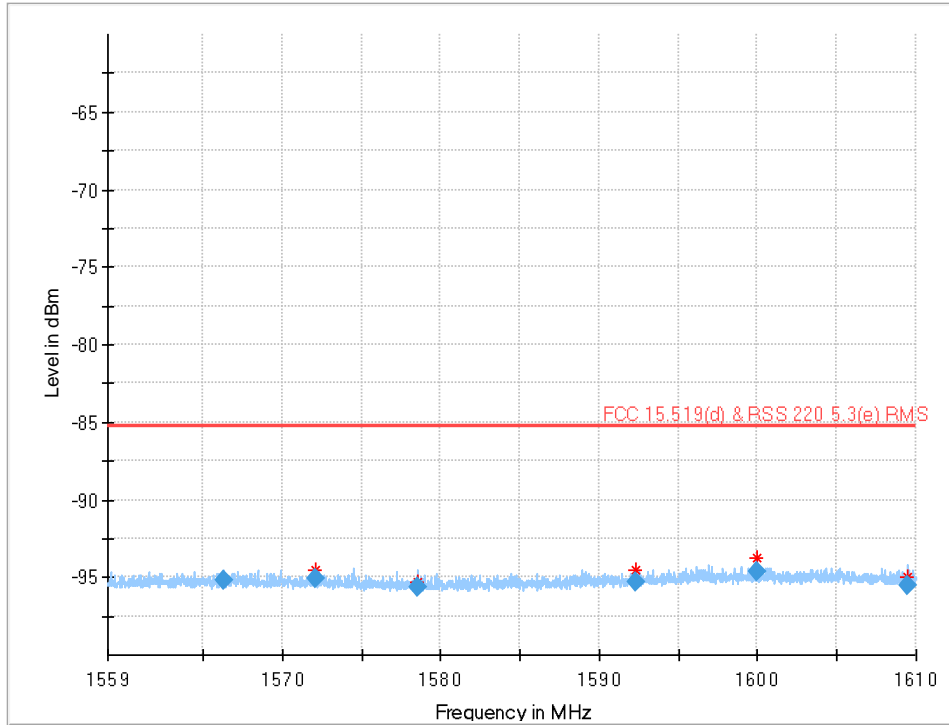

Frequency (MHz)	RMS (dBm)	Limit (dBm)	Margin (dB)	Bandwidth (kHz)	Pol	Azimuth (deg)	Elevation (deg)	Corr. (dB)
1566.349840	-95.18	-85.30	9.88	30.000	H	311.0	5.0	-138.2
1572.120460	-95.03	-85.30	9.73	30.000	V	122.0	109.0	-138.6
1578.590750	-95.64	-85.30	10.34	30.000	H	258.0	45.0	-138.7
1592.267820	-95.28	-85.30	9.98	30.000	H	209.0	163.0	-138.1
1600.003790	-94.60	-85.30	9.30	30.000	H	91.0	157.0	-137.8
1609.449460	-95.58	-85.30	10.28	30.000	H	290.0	6.0	-138.3

12.3 Efficient use of spectrum acc. to §15.519(a)(1)

Description:

§15.519(a)(1)

A UWB device operating under the provisions of this section shall transmit only when it is sending information to an associated receiver. The UWB intentional radiator shall cease transmission within 10 seconds unless it receives an acknowledgement from the associated receiver that its transmission is being received. An acknowledgment of reception must continue to be received by the UWB intentional radiator at least every 10 seconds or the UWB device must cease transmitting.

KDB 393764 D01 UWB FAQ v02r01 Answer 4

An acknowledgement of reception must continue to be received by the UWB device at least once every 10 seconds, or else the device shall cease transmission of any information other than periodic signals for use in the establishment or re-establishment of a communications link with an associated receiver.

Measurement:

Measurement parameter	
Detector:	Pos-Peak
Resolution bandwidth:	10 MHz
Video bandwidth:	20 MHz
Span	Zero

Limits:

§15.519(a)(1), KDB 393764, RSS-220 5.3.1(b)

EUT shall cease transmission of information within 10 seconds unless it receives an acknowledgement from the associated receiver.

However, periodic signals used for the establishment or re-establishment of a communication link with an associated receiver may be transmitted.

Results:

Plot 25: Emissions of the EUT, only at the beginning with associated receiver (Normal mode), Channel 1

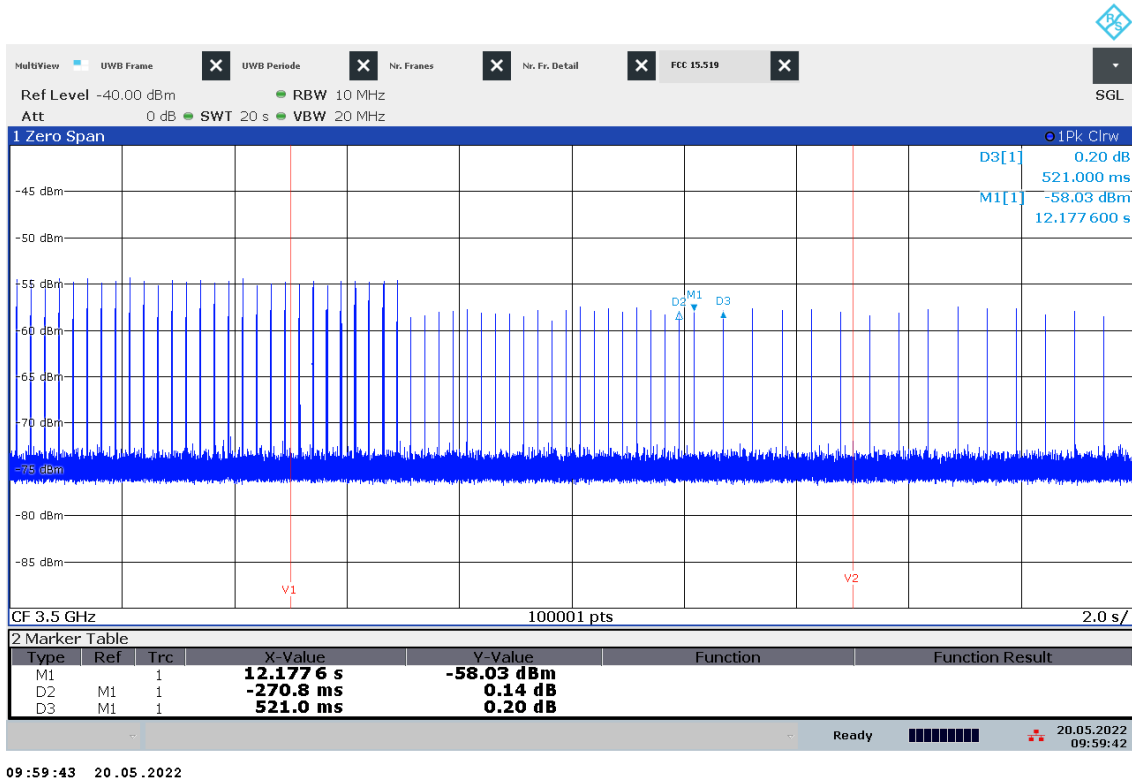

Vertical line V1 indicates the time when the associated receiver is switched off.
Vertical line V2 indicates 10 s after the associated receiver is switched off.

→ Approximately 7 seconds after the associated receiver is switched off, the EUT ceases transmission of information and only sends periodic signals used for the establishment or re-establishment of a communication link.

Plot 26: Emission of EUT without associated receiver (for comparison), normal mode, Channel 1

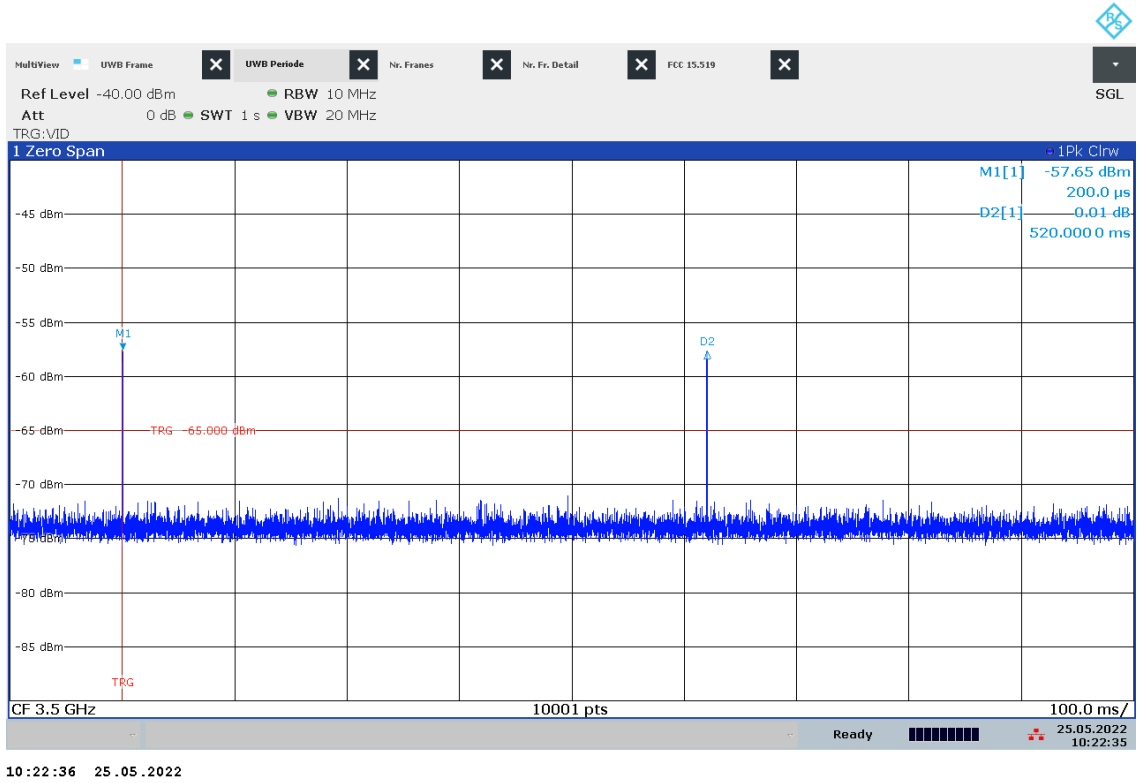

→ Signals are used for the establishment or re-establishment of a communication link.

Plot 27: Emissions of the EUT, only at the beginning with associated receiver (Normal mode), Channel 2



04:30:13 17.08.2022

Vertical line V1 indicates the time when the associated receiver is switched off.

Vertical line V2 indicates 10 s after the associated receiver is switched off.

→ Approximately 7 seconds after the associated receiver is switched off, the EUT ceases transmission of information and only sends periodic signals used for the establishment or re-establishment of a communication link.

Note:

Period of periodic signals for the establishment or re-establishment of a communication link are equal for channel 1 and channel 2, see Plot 26.

Verdict: Compliant

12.4 Antenna requirements

Description:

§15.519(a)(2)

The use of antennas mounted on outdoor structures, e.g., antennas mounted on the outside of a building or on a telephone pole, or any fixed outdoors infrastructure is prohibited. Antennas may be mounted only on the hand held UWB device.

§15.521(b)

Manufacturers and users are reminded of the provisions of §§15.203 and 15.204.

Results:

Integrated antenna.

Verdict: Compliant

12.5 Conducted emissions < 30MHz

Description:

Measurement of the conducted spurious emissions in transmit mode below 30 MHz. Both power lines, phase and neutral line, are measured. Found peaks are re-measured with average and quasi peak detection to show compliance to the limits.

Measurement:

Parameter	
Detector:	Peak - Quasi Peak / Average
Sweep time:	Auto
Video bandwidth:	F < 150 kHz: 200 Hz F > 150 kHz: 9 kHz
Resolution bandwidth:	F < 150 kHz: 1 kHz F > 150 kHz: 100 kHz
Span:	9 kHz to 30 MHz
Trace-Mode:	Max Hold

Limits:

FCC		IC	
CFR Part 15.207(a)		RSS-Gen 8.8	
Conducted Spurious Emissions < 30 MHz			
Frequency (MHz)	Quasi-Peak (dB μ V)	Average (dB μ V)	
0.15 – 0.5	66 to 56*	56 to 46*	
0.5 – 5	56	46	
5 – 30.0	60	50	

*Decreases with the logarithm of the frequency

§15.521(j)

Responsible parties are reminded of the other standards and requirements cross referenced in §15.505, such as a limit on emissions conducted onto the AC power lines.

§15.207(c)

Measurements to demonstrate compliance with the conducted limits are not required for devices which only employ battery power for operation and which do not operate from the AC power lines or contain provisions for operation while connected to the AC power lines. Devices that include, or make provisions for, the use of battery chargers which permit operating while charging, AC adapters or battery eliminators or that connect to the AC power lines indirectly, obtaining their power through another device which is connected to the AC power lines, shall be tested to demonstrate compliance with the conducted limits.

Results:

Plot 28: Phase line

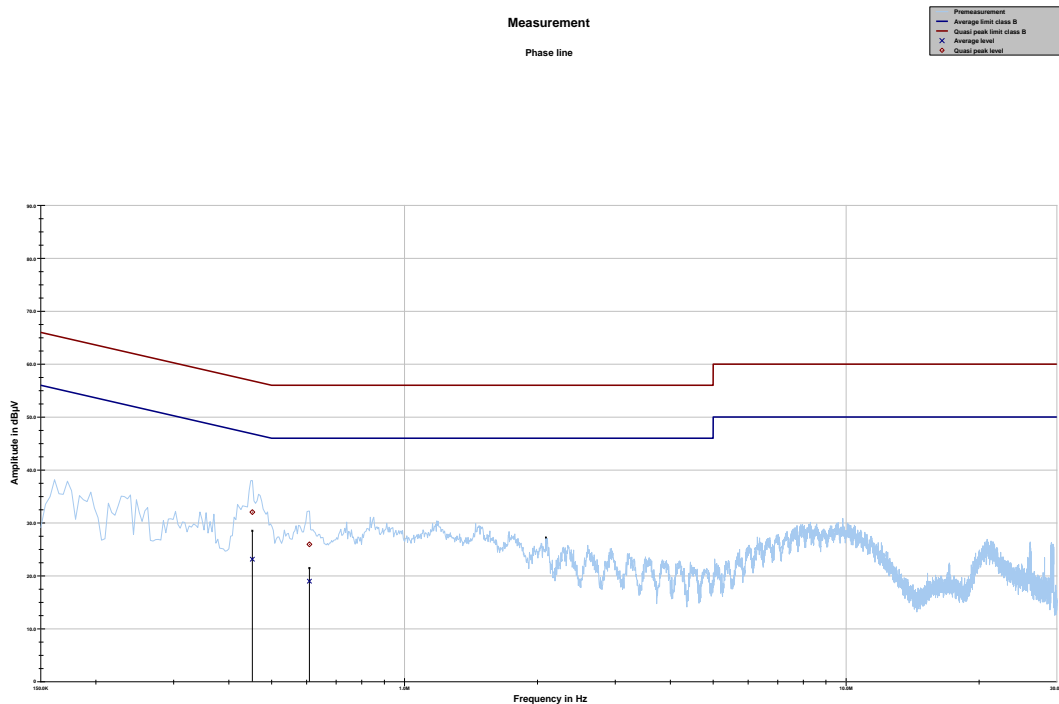

Project ID: truck unit small

Frequency	Quasi peak level	Margin quasi peak	Limit QP	Average level	Margin average	Limit AV
MHz	dBµV	dB	dBµV	dBµV	dB	dBµV
0.452231	32.05	24.79	56.834	23.15	24.22	47.365
0.608944	25.94	30.06	56.000	19.00	27.00	46.000

Plot 29: Neutral line

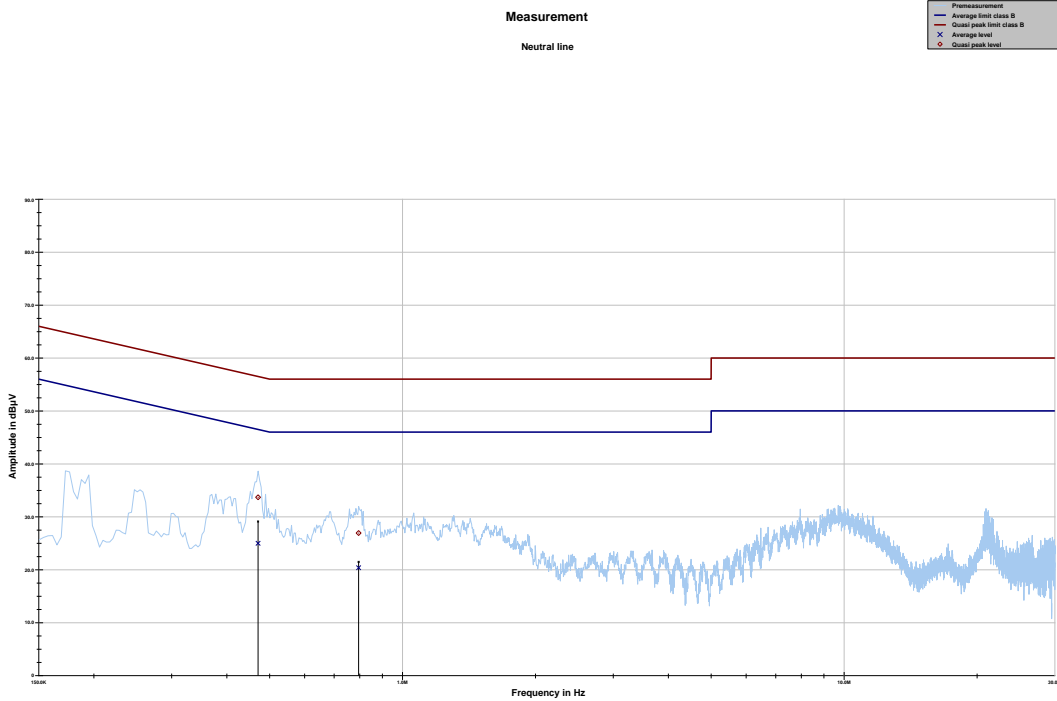

Project ID: truck unit small

Frequency	Quasi peak level	Margin quasi peak	Limit QP	Average level	Margin Average	Limit AV
MHz	dBµV	dB	dBµV	dBµV	dB	dBµV
0.470888	33.68	22.81	56.498	24.99	21.85	46.832
0.795506	26.92	29.08	56.000	20.37	25.63	46.000

Verdict: Compliant

13 Glossary

EUT	Equipment under test
DUT	Device under test
UUT	Unit under test
GUE	GNSS User Equipment
ETSI	European Telecommunications Standards Institute
EN	European Standard
FCC	Federal Communications Commission
FCC ID	Company Identifier at FCC
IC	Industry Canada
PMN	Product marketing name
HMN	Host marketing name
HVIN	Hardware version identification number
FVIN	Firmware version identification number
EMC	Electromagnetic Compatibility
HW	Hardware
SW	Software
Inv. No.	Inventory number
S/N or SN	Serial number
C	Compliant
NC	Not compliant
NA	Not applicable
NP	Not performed
PP	Positive peak
QP	Quasi peak
AVG	Average
OC	Operating channel
OCW	Operating channel bandwidth
OBW	Occupied bandwidth
OOB	Out of band
DFS	Dynamic frequency selection
CAC	Channel availability check
OP	Occupancy period
NOP	Non occupancy period
DC	Duty cycle
PER	Packet error rate
CW	Clean wave
MC	Modulated carrier
WLAN	Wireless local area network
RLAN	Radio local area network
DSSS	Dynamic sequence spread spectrum
OFDM	Orthogonal frequency division multiplexing
FHSS	Frequency hopping spread spectrum
GNSS	Global Navigation Satellite System
C/N₀	Carrier to noise-density ratio, expressed in dB-Hz

14 Document history

Version	Applied changes	Date of release
-/-	Initial release	2023-02-03

15 Accreditation Certificate – D-PL-12076-01-05

first page	last page
 <p>Deutsche Akkreditierungsstelle GmbH</p> <p>Entrusted according to Section 8 subsection 1 AkkStelleG in connection with Section 1 subsection 1 AkkStelleGBV Signatory to the Multilateral Agreements of EA, ILAC and IAF for Mutual Recognition</p> <p>Accreditation </p> <p>The Deutsche Akkreditierungsstelle GmbH attests that the testing laboratory CTC advanced GmbH Untertürkheimer Straße 6-10, 66117 Saarbrücken is competent under the terms of DIN EN ISO/IEC 17025:2018 to carry out tests in the following fields: Telecommunication (FCC Requirements)</p> <p>The accreditation certificate shall only apply in connection with the notice of accreditation of 09.06.2020 with the accreditation number D-PL-12076-01. It comprises the cover sheet, the reverse side of the cover sheet and the following annex with a total of 05 pages. Registration number of the certificate: D-PL-12076-01-05</p> <p>Frankfurt am Main, 09.06.2020  by Jörg Ostling, (F19) Head of Division</p> <p><small>The certificate together with its annex reflects the status at the time of the date of issue. The current status of the scope of accreditation can be found in the database of accredited bodies of Deutsche Akkreditierungsstelle GmbH. https://www.dakks.de/en/content/accredited-bodies-dakks See annex 01/001/01</small></p>	<p>Deutsche Akkreditierungsstelle GmbH</p> <p>Office Berlin Spittelmarkt 10 10117 Berlin</p> <p>Office Frankfurt am Main Europa-Allee 52 60327 Frankfurt am Main</p> <p>Office Braunschweig Bundesallee 100 38116 Braunschweig</p> <p>The publication of extracts of the accreditation certificate is subject to the prior written approval by Deutsche Akkreditierungsstelle GmbH (DAKKS). Exempted is the unchanged form of separate disseminations of the cover sheet by the conformity assessment body mentioned overleaf.</p> <p>No impression shall be made that the accreditation also extends to fields beyond the scope of accreditation attested by DAKKS.</p> <p>The accreditation was granted pursuant to the Act on the Accreditation Body (AkkStelleG) of 31 July 2009 (Federal Law Gazette I p. 2525) and the Regulation (EC) No 765/2008 of the European Parliament and of the Council of 9 July 2008 setting out the requirements for accreditation and market surveillance relating to the marketing of products (Official Journal of the European Union L 218 of 9 July 2008, p. 30). DAKKS is a signatory to the Multilateral Agreements for Mutual Recognition of the European co-operation for Accreditation (EA), International Accreditation Forum (IAF) and International Laboratory Accreditation Cooperation (ILAC). The signatories to these agreements recognise each other's accreditations.</p> <p>The up-to-date state of membership can be retrieved from the following websites: EA: www.european-accreditation.org ILAC: www.ilac.org IAF: www.iaf.nu</p>

Note: The current certificate annex is published on the websites (link see below).

<https://www.dakks.de/files/data/as/pdf/D-PL-12076-01-05e.pdf>

or

https://ctcadvanced.com/app/uploads/2020/06/D-PL-12076-01-05_TCB_USA.pdf

END OF TEST REPORT