

TEST REPORT

Applicant: Shenzhen yizhongge Electronic Co., Ltd

Address: 401, building D, No.28, Xinyuan Industrial Zone, Xinmu community, Pinghu street, Longgang District, Shenzhen, China

Product Name: Walkie Talkies

FCC ID: 2AYV7XF-638

Standard(s): 47 CFR Part 95 Subpart B
ANSI C63.26-2015

Report Number: SZNS1240104-00948E-RF-00

Report Date: 2024/2/7

The above device has been tested and found compliant with the requirement of the relative standards by Bay Area Compliance Laboratories Corp. (Dongguan).

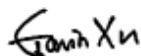

Reviewed By: Gavin Xu
Title: RF Engineer



Approved By: Ivan Cao
Title: EMC Manager

Bay Area Compliance Laboratories Corp. (Dongguan)
No.12, Pulong East 1st Road, Tangxia Town, Dongguan, Guangdong, China

Tel: +86-769-86858888

Fax: +86-769-86858891

www.baclcorp.com.cn

Note: The information marked ▲ is provided by the applicant, the laboratory is not responsible for its authenticity and this information can affect the validity of the result in the test report. Unless otherwise stated the results shown in this test report refer only to the sample(s) tested. This report cannot be reproduced except in full, without prior written approval of the Company. This report is valid only with a valid digital signature. The digital signature may be available only under the Adobe software above version 7.0. This report may contain data that are not covered by the accreditation scope and shall be marked with ★. This report must not be used by the client to claim product certification, approval, or endorsement by NVLAP, NIST, or any agency of the U.S. Government.

CONTENTS

DOCUMENT REVISION HISTORY 4

1. GENERAL INFORMATION 5

1.1 PRODUCT DESCRIPTION FOR EQUIPMENT UNDER TEST (EUT) 5

1.2 ACCESSORY INFORMATION: 5

1.3 ANTENNA INFORMATION DETAIL▲: 5

1.4 EQUIPMENT MODIFICATIONS 5

2. DESCRIPTION OF TEST CONFIGURATION 6

2.1 OPERATION FREQUENCY DETAIL: 6

2.2 EUT OPERATION CONDITION: 6

2.3 EUT EXERCISE SOFTWARE..... 6

2.4 SUPPORT EQUIPMENT LIST AND DETAILS 6

2.5 SUPPORT CABLE LIST AND DETAILS 6

2.6 BLOCK DIAGRAM OF TEST SETUP 7

2.7 TEST FACILITY..... 8

2.8 MEASUREMENT UNCERTAINTY 8

3. SUMMARY OF TEST RESULTS 9

4. TEST RESULTS 10

4.1 FRS FREQUENCY ACCURACY 10

 4.1.1 Applicable Standard..... 10

 4.1.2 EUT Setup Block Diagram 10

 4.1.3 Test Procedure 10

 4.1.4 Test Result 11

4.2 FRS TRANSMIT POWER..... 13

 4.2.1 Applicable Standard..... 13

 4.2.2 EUT Setup Block Diagram 13

 4.2.3 Test Procedure 13

 4.2.4 Test Result 14

4.3 FRS EMISSION TYPES..... 15

 4.3.1 Applicable Standard..... 15

 4.3.2 Judgment..... 15

4.4 FRS AUTHORIZED BANDWIDTH AND EMISSION MASK 16

 4.4.1 Applicable Standard..... 16

 4.4.2 EUT Setup Block Diagram 16

 4.4.3 Test Procedure 17

 4.4.4 Test Result 18

4.5 FRS MODULATION LIMITS 20

 4.5.1 Applicable Standard..... 20

4.5.2 EUT Setup Block Diagram20

4.5.3 Test Procedure20

4.5.4 Test Result21

4.6 FRS UNWANTED EMISSIONS LIMITS24

4.6.1 Applicable Standard24

4.6.2 Test setup:25

4.6.3 Test Procedure:26

4.6.4 Test Result27

4.7 FRS ADDITIONAL REQUIREMENTS29

4.7.1 Applicable Standard29

4.7.2 Judgment29

5. EUT PHOTOGRAPHS 30

6. TEST SETUP PHOTOGRAPHS 31

DOCUMENT REVISION HISTORY

Revision Number	Report Number	Description of Revision	Date of Revision
1.0	SZNS1240104-00948E-RF-00	Original Report	2024/2/7

1. GENERAL INFORMATION

1.1 Product Description for Equipment under Test (EUT)

EUT Name:	Walkie Talkies
EUT Model:	XF-638
Multiple Models:	YG-817, YG-819
Modulation Mode:	FM
Emission Designator:	11K0F3E
Maximum Output Power: (ERP)	(462.5500-462.7250MHz) 22.03dBm (467.5625-467.7125MHz) 22.17dBm
Rated Input Voltage:	DC 3.7V from battery or DC 5V from USB port
Serial Number:	Radiated emission test: 2G7Z-1 RF Conducted test: 2G7Z-2
EUT Received Date:	2024/1/11
EUT Received Status:	Good
<p>Note: The Multiple models are electrically identical with the test model. Please refer to the declaration letter for more detail, which was provided by manufacturer.</p>	

1.2 Accessory Information:

Accessory Description	Manufacturer	Model	Parameters
/	/	/	/

1.3 Antenna Information Detail ▲:

Antenna Manufacturer	Antenna Connector	Antenna Type	input impedance (Ohm)	Antenna Gain /Frequency Range
Shenzhen Yu Sheng Electronics Co., LTD	integral	Monopole	50	-2 dBi(-4.15dBd) 462~468MHz

1.4 Equipment Modifications

No modifications are made to the EUT during all test items.

2. DESCRIPTION OF TEST CONFIGURATION

2.1 Operation Frequency Detail:

Channel Number	Frequency (MHz)	Channel Number	Frequency (MHz)
1	462.5625	12	467.6625
2	462.5875	13	467.6875
3	462.6125	14	467.7125
4	462.6375	15	462.5500
5	462.6625	16	462.5750
6	462.6875	17	462.6000
7	462.7125	18	462.6250
8	467.5625	19	462.6500
9	467.5875	20	462.6750
10	467.6125	21	462.7000
11	467.6375	22	462.7250

2.2 EUT Operation Condition:

The system was configured for testing in Engineering Mode, which was provided by the manufacturer. The following summary table is showing all test modes to demonstrate in compliance with the standard:

Test Items	Test Modes
Radiated Spurious Emission:	Mode 1: Transmitting
RF Conducted Test:	Mode 1: Transmitting
Note: Mode 1 was tested with the frequencies in bold in section 2.1.	

2.3 EUT Exercise Software

No software was used during test.

2.4 Support Equipment List and Details

Manufacturer	Description	Model	Serial Number
\	\	\	\

2.5 Support Cable List and Details

Cable Description	Shielding Type	Ferrite Core	Length(m)	From Port	To
\	\	\	\	\	\

2.6 Block Diagram of Test Setup

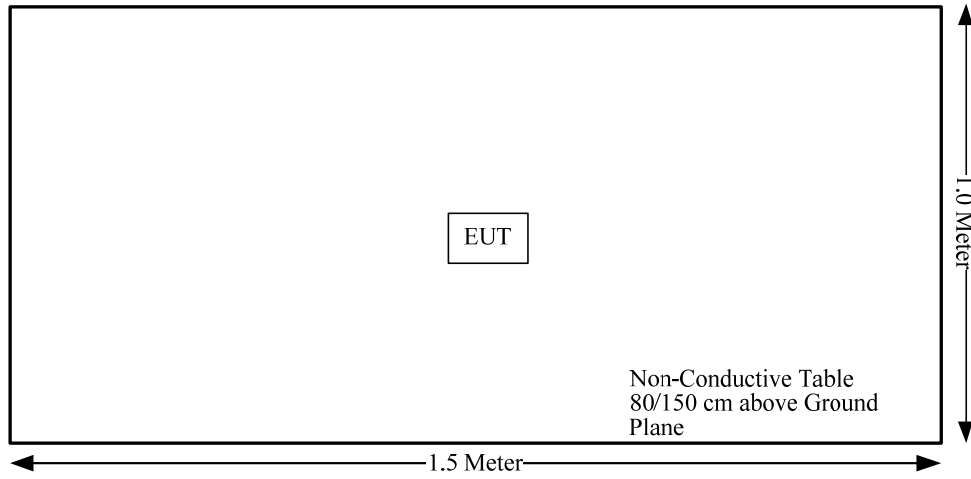

2.7 Test Facility

The Test site used by Bay Area Compliance Laboratories Corp. (Dongguan) to collect test data is located on the No.12, Pulong East 1st Road, Tangxia Town, Dongguan, Guangdong, China.

The lab has been recognized as the FCC accredited lab under the KDB 974614 D01 and is listed in the FCC Public Access Link (PAL) database, FCC Registration No. : 829273, the FCC Designation No. : CN5044.

The lab has been recognized by Innovation, Science and Economic Development Canada to test to Canadian radio equipment requirements, the CAB identifier: CN0022.

2.8 Measurement Uncertainty

Otherwise required by the applicant or Product Regulations, Decision Rule in this report did not consider the uncertainty. The extended uncertainty given in this report is obtained by combining the standard uncertainty times the coverage factor K with the 95% confidence interval.

Parameter	Measurement Uncertainty
Occupied Channel Bandwidth	±5 %
RF output power, conducted	±0.61dB
Unwanted Emissions, radiated	9kHz~30MHz: 3.3dB, 30MHz~200MHz: 4.55 dB, 200MHz~1GHz: 5.92 dB, 1GHz~6GHz: 4.98 dB, 6GHz~18GHz: 5.89 dB, 18GHz~26.5GHz:5.47 dB, 26.5GHz~40GHz:5.63 dB
Unwanted Emissions, conducted	±2.47 dB
Temperature	±1 °C
Humidity	±5%
DC and low frequency voltages	±0.4%
Duty Cycle	1%
RF Frequency	±0.082×10 ⁶
Audio Frequency	3.98%
Modulation Limiting	1.11%

3. SUMMARY OF TEST RESULTS

Standard/Rule(s)	Description of Test	Results
§2.1055(d), §95.565	FRS Frequency Accuracy	Compliant
FCC§2.1046, FCC§95.567	FRS transmit Power	Compliant
§95.571	FRS Emission Types	Compliant
§2.1049, §95.573	FRS Authorized Bandwidth	Compliant
§95.579	Emission Mask	Compliant
§2.1047, §95.575	FRS Modulation Limits	Compliant
§2.1053, §95.579	FRS Unwanted Emissions Limits	Compliant
§95.587	FRS Additional Requirements	Compliant

4. TEST RESULTS

4.1 FRS Frequency Accuracy

4.1.1 Applicable Standard

FCC §95.565

Each FRS transmitter type must be designed such that the carrier frequencies remain within ± 2.5 parts-per-million of the channel center frequencies specified in § 95.563 during normal operating conditions.

4.1.2 EUT Setup Block Diagram

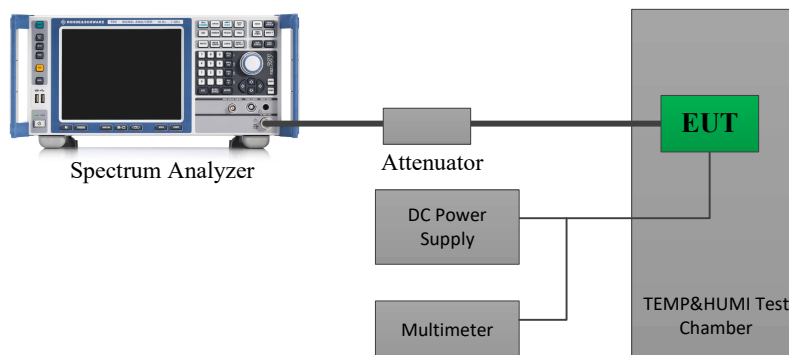

4.1.3 Test Procedure

C63.26-2015, Clause 5.6

Frequency stability is a measure of the frequency drift due to temperature and supply voltage variations, with reference to the frequency measured at +20 °C and rated supply voltage. The operating carrier frequency shall be set up in accordance with the manufacturer's published operation and instruction manual prior to the commencement of these tests. No adjustment of any frequency determining circuit element shall be made subsequent to this initial set-up. Frequency stability is tested:

- a) At 10 °C intervals of temperatures between -30 °C and +50 °C at the manufacturer's rated supply voltage, and
- b) At +20 °C temperature and $\pm 15\%$ supply voltage variations. If a product is specified to operate over a range of input voltage then the -15% variation is applied to the lowermost voltage and the +15% is applied to the uppermost voltage. During the test all necessary settings, adjustments and control of the EUT have to be performed without disturbing the test environment, i.e., without opening the environmental chamber. The frequency stabilities can be maintained to a lesser temperature range provided that the transmitter is automatically inhibited from operating outside the lesser temperature range. For handheld equipment that is only capable of operating from internal batteries and the supply voltage cannot be varied, the frequency stability tests shall be performed at the nominal battery voltage and the battery end point voltage specified by the manufacturer. An external supply voltage can be used and set at the internal battery nominal voltage, and again at the battery operating end point voltage which shall be specified by the equipment manufacturer.

If an unmodulated carrier is not available, the mean frequency of a modulated carrier can be obtained by using a frequency counter with gating time set to an appropriately large multiple of bit periods (gating time depending on the required accuracy). Full details on the choice of values shall be included in the test report.

4.1.4 Test Result

Serial Number:	2G7Z-2	Test Date:	2024/1/31
Test Site:	RF	Test Mode:	Transmitting
Tester:	Stu Song	Test Result:	Pass

Environmental Conditions:					
Temperature: (°C)	21.8	Relative Humidity: (%)	67	ATM Pressure: (kPa)	101.3

Test Equipment List and Details:

Manufacturer	Description	Model	Serial Number	Calibration Date	Calibration Due Date
R&S	Spectrum Analyzer	FSU 26	200160/026	2023/10/18	2024/10/17
yzjingcheng	Coaxial Cable	KTRFBU-141-50	41010012	2023/9/1	2024/8/31
E-Microwave	Coaxial Attenuators	EMCA10-5RN-6	OE01203239	2023/9/1	2024/8/31
Weinschel	Coaxial Attenuators	53-20-34	LN749	2023/9/1	2024/8/31
BACL	TEMP&HUMI Test Chamber	BTH-150-40	30173	2023/10/18	2024/10/17
All-sun	Clamp Meter	EM305A	8348897	2023/8/3	2024/8/2
TDK-Lambda	DC Power Supply	Z+60-14	F-08-EM038-1	N/A	N/A

* Statement of Traceability: Bay Area Compliance Laboratories Corp. (Dongguan) attests that all calibrations have been performed, traceable to National Primary Standards and International System of Units (SI).

Test Data:

Test Frequency (MHz)	Temperature (°C)	Voltage (V)	Measured Frequency (MHz)	Frequency Error (ppm)	limit (ppm)
462.6375	-30	3.7	462.6370292	-1.02	≤2.5
	-20	3.7	462.6370053	-1.07	≤2.5
	-10	3.7	462.6369756	-1.13	≤2.5
	0	3.7	462.6369504	-1.19	≤2.5
	10	3.7	462.6369257	-1.24	≤2.5
	20	3.7	462.6369000	-1.30	≤2.5
	30	3.7	462.6368748	-1.35	≤2.5
	40	3.7	462.6368481	-1.41	≤2.5
	50	3.7	462.6368189	-1.47	≤2.5
	20	3.3	462.6369416	-1.21	≤2.5
	20	4.5	462.6368543	-1.40	≤2.5

Test Frequency (MHz)	Temperature (°C)	Voltage (V)	Measured Frequency (MHz)	Frequency Error (ppm)	limit (ppm)
467.6375	-30	3.7	467.6369316	-1.22	≤2.5
	-20	3.7	467.6369055	-1.27	≤2.5
	-10	3.7	467.6368772	-1.33	≤2.5
	0	3.7	467.6368534	-1.38	≤2.5
	10	3.7	467.6368267	-1.44	≤2.5
	20	3.7	467.6368000	-1.50	≤2.5
	30	3.7	467.6367758	-1.55	≤2.5
	40	3.7	467.6367483	-1.61	≤2.5
	50	3.7	467.6367169	-1.67	≤2.5
	20	3.3	467.6368455	-1.40	≤2.5
	20	4.5	467.6367488	-1.61	≤2.5

4.2 FRS Transmit Power

4.2.1 Applicable Standard

FCC §95.567

Each FRS transmitter type must be designed such that the effective radiated power (ERP) on channels 8 through 14 does not exceed 0.5 Watts and the ERP on channels 1 through 7 and 15 through 22 does not exceed 2.0 Watts.

4.2.2 EUT Setup Block Diagram

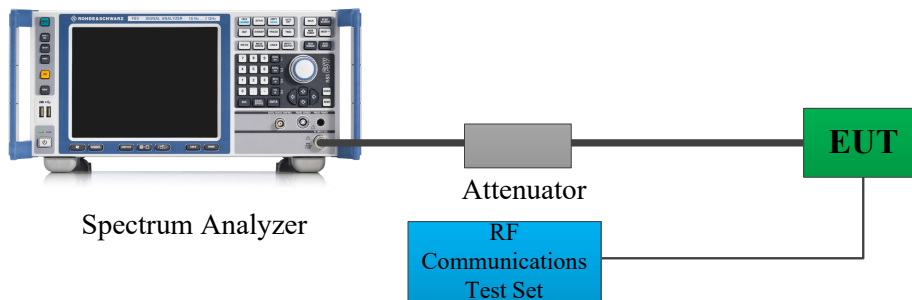

Note: The Insertion loss of the RF cable, Attenuators was offset into the Spectrum Analyzer.

4.2.3 Test Procedure

C63.26-2015, Clause 5.2.3.3

This procedure can be used to measure the peak power in either a CW-like or noise-like narrowband RF signal. The measurement instrument must have a RBW that is greater than or equal to the OBW of the signal to be measured and a $VBW \geq 3 \times RBW$.

- Set the $RBW \geq OBW$.
- Set $VBW \geq 3 \times RBW$.
- Set span $\geq 2 \times OBW$.
- Sweep time $\geq 10 \times (\text{number of points in sweep}) \times (\text{transmission symbol period})$.
- Detector = peak.
- Trace mode = max hold.
- Allow trace to fully stabilize.
- Use the peak marker function to determine the peak amplitude level

$ERP = \text{Conducted Output Power} + \text{Antenna Gain (dBd)}$

4.2.4 Test Result

Serial Number:	2G7Z-2	Test Date:	2024/1/31
Test Site:	RF	Test Mode:	Transmitting
Tester:	Stu Song	Test Result:	Pass

Environmental Conditions:					
Temperature: (°C)	21.8	Relative Humidity: (%)	67	ATM Pressure: (kPa)	101.3

Test Equipment List and Details:

Manufacturer	Description	Model	Serial Number	Calibration Date	Calibration Due Date
R&S	Spectrum Analyzer	FSU 26	200160/026	2023/10/18	2024/10/17
yzjingcheng	Coaxial Cable	KTRFBU-141-50	41010012	2023/9/1	2024/8/31
E-Microwave	Coaxial Attenuators	EMCA10-5RN-6	OE01203239	2023/9/1	2024/8/31
Weinschel	Coaxial Attenuators	53-20-34	LN749	2023/9/1	2024/8/31
HP	RF Communications Test Set	8920A	3438A05201	2023/10/18	2024/10/17

* Statement of Traceability: Bay Area Compliance Laboratories Corp. (Dongguan) attests that all calibrations have been performed, traceable to National Primary Standards and International System of Units (SI).

Test Data:

Test Frequency (MHz)	Conducted Output power (dBm)	Antenna Gain (dBd)	ERP (dBm)	ERP Limit (dBm)
462.6375	26.18	-4.15	22.03	≤33
467.6375	26.32	-4.15	22.17	≤27

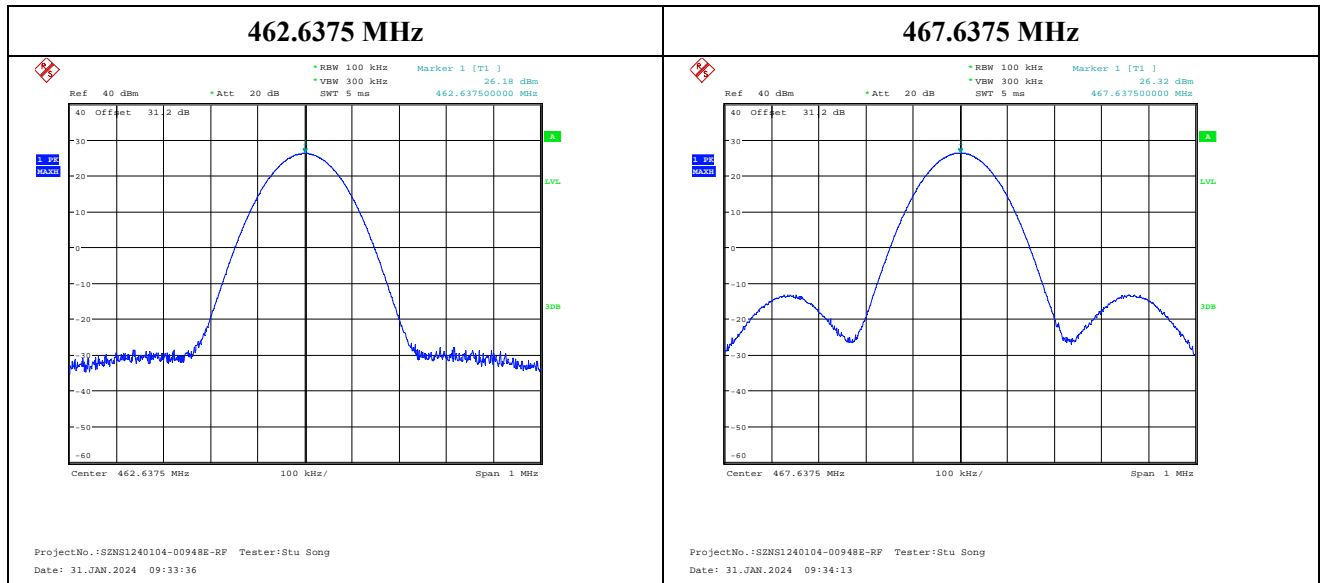

4.3 FRS Emission Types

4.3.1 Applicable Standard

FCC §95.571

Each FRS transmitter type must be designed such that it can transmit only the following emission types: F3E, G3E, F2D, and G2D.

4.3.2 Judgment

The emission type is F3E Only.

4.4 FRS Authorized Bandwidth And Emission Mask

4.4.1 Applicable Standard

FCC §95.573

Each FRS transmitter type must be designed such that the occupied bandwidth does not exceed 12.5 kHz.

FCC §95.579

Each FRS transmitter type must be designed to satisfy the applicable unwanted emissions limits in this paragraph.

(a) *Attenuation requirements.* The power of unwanted emissions must be attenuated below the carrier power output in Watts (P) by at least:

- (1) 25 dB (decibels) in the frequency band 6.25 kHz to 12.5 kHz removed from the channel center frequency.
- (2) 35 dB in the frequency band 12.5 kHz to 31.25 kHz removed from the channel center frequency.
- (3) $43 + 10 \log (P)$ dB in any frequency band removed from the channel center frequency by more than 31.25 kHz.

(b) *Measurement bandwidths.* The power of unwanted emissions in the frequency bands specified in paragraphs (a)(1) and (2) of this section is measured with a reference bandwidth of 300 Hz. The power of unwanted emissions in the frequency range specified in paragraph (a)(3) is measured with a reference bandwidth of at least 30 kHz.

(c) *Measurement conditions.* The requirements in this section apply to each FRS transmitter type both with and without the connection of permitted attachments, such as an external speaker, microphone and/or power cord.

4.4.2 EUT Setup Block Diagram

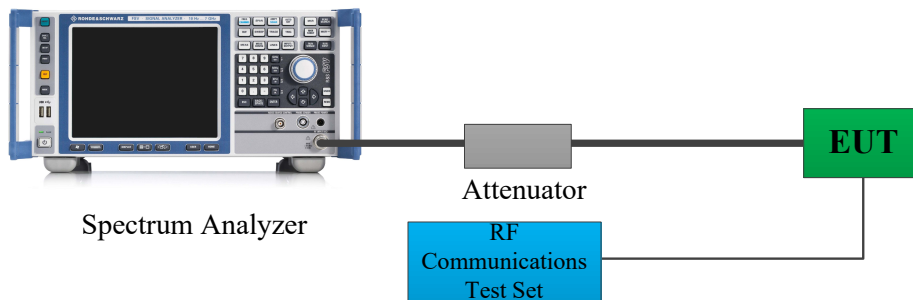

Note: The Insertion loss of the RF cable, Attenuators was offset into the Spectrum Analyzer.

4.4.3 Test Procedure

C63.26-2015, Clause 5.4.4

The OBW is the frequency bandwidth such that, below its lower and above its upper frequency limits, the mean powers are each equal to 0.5% of the total mean power of the given emission.

The following procedure shall be used for measuring (99%) power bandwidth:

- a) The spectrum analyzer center frequency is set to the nominal EUT channel center frequency. The frequency span for the spectrum analyzer shall be set wide enough to capture all modulation products including the emission skirts (typically a span of $1.5 \times \text{OBW}$ is sufficient).
- b) The nominal IF filter 3 dB bandwidth (RBW) shall be in the range of 1% to 5% of the anticipated OBW, and the VBW shall be set $\geq 3 \times \text{RBW}$.
- c) Set the reference level of the instrument as required to prevent the signal amplitude from exceeding the maximum spectrum analyzer input mixer level for linear operation. See guidance provided in 4.2.3. NOTE—Step a), step b), and step c) may require iteration to adjust within the specified tolerances.
- d) Set the detection mode to peak, and the trace mode to max-hold.
- e) If the instrument does not have a 99% OBW function, recover the trace data points and sum directly in linear power terms. Place the recovered amplitude data points, beginning at the lowest frequency, in a running sum until 0.5% of the total is reached. Record that frequency as the lower OBW frequency. Repeat the process until 99.5% of the total is reached and record that frequency as the upper OBW frequency. The 99% power OBW can be determined by computing the difference these two frequencies.
- f) The OBW shall be reported and plot(s) of the measuring instrument display shall be provided with the test report. The frequency and amplitude axis and scale shall be clearly labeled. Tabular data can be reported in addition to the plot(s).

According to ANSI C63.26-2015 Section 5.7.3:

- f) See Annex I for example emission mask plots.

4.4.4 Test Result

Serial Number:	2G7Z-2	Test Date:	2024/2/2
Test Site:	RF	Test Mode:	Transmitting
Tester:	Stu Song	Test Result:	Pass

Environmental Conditions:					
Temperature: (°C)	23.2	Relative Humidity: (%)	59	ATM Pressure: (kPa)	101.1

Test Equipment List and Details:

Manufacturer	Description	Model	Serial Number	Calibration Date	Calibration Due Date
R&S	Spectrum Analyzer	FSU 26	200160/026	2023/10/18	2024/10/17
yzjingcheng	Coaxial Cable	KTRFBU-141-50	41010012	2023/9/1	2024/8/31
E-Microwave	Coaxial Attenuators	EMCA10-5RN-6	OE01203239	2023/9/1	2024/8/31
Weinschel	Coaxial Attenuators	53-20-34	LN749	2023/9/1	2024/8/31
HP	RF Communications Test Set	8920A	3438A05201	2023/10/18	2024/10/17

* Statement of Traceability: Bay Area Compliance Laboratories Corp. (Dongguan) attests that all calibrations have been performed, traceable to National Primary Standards and International System of Units (SI).

Test Data:

Test Frequency (MHz)	99% Occupied Bandwidth (kHz)	20 dB Bandwidth (kHz)	Limit (kHz)
462.6375	10.096	10.801	≤12.5
467.6375	10.096	10.865	≤12.5

Note:

Emission bandwidth was based on calculation method instead of measurement.

Emission Designator

Per CFR 47 §2.201& §2.202, $BW = 2M + 2D$

For FM Mode (Channel Spacing: 12.5 kHz)

Emission Designator 11K0F3E

In this case, the maximum modulating frequency is 3.0 kHz with a 2.5 kHz deviation.

$BW = 2(M+D) = 2*(3.0 \text{ kHz} + 2.5 \text{ kHz}) = 11 \text{ kHz} = 11K0$

F3E portion of the designator represents an FM voice transmission

Therefore, the entire designator for 12.5 kHz channel spacing FM mode is 11K0F3E.

Test Items	99% Occupied Bandwidth	Emission Mask																																																								
<p>462.6375 MHz</p>	<p>ProjectNo.:SZNS1240104-00948E-RF Tester:Stu Song Date: 2.FEB.2024 13:54:17</p>	<table border="1"> <thead> <tr> <th>Start</th> <th>Stop</th> <th>RBW</th> <th>Freq</th> <th>PwrAbs</th> <th>PwrRel</th> <th>Limit</th> </tr> <tr> <th>[Hz]</th> <th>[Hz]</th> <th>[Hz]</th> <th>[MHz]</th> <th>[dBm]</th> <th>[dBc]</th> <th>[dB]</th> </tr> </thead> <tbody> <tr> <td>-62.500 k</td> <td>-31.250 k</td> <td>30.00 k</td> <td>462.605048 M</td> <td>-24.02</td> <td>-52.83</td> <td>-11.02</td> </tr> <tr> <td>-31.250 k</td> <td>-12.500 k</td> <td>300.00 k</td> <td>462.621474 M</td> <td>-20.68</td> <td>-49.49</td> <td>-11.86</td> </tr> <tr> <td>-12.500 k</td> <td>-6.250 k</td> <td>300.00 k</td> <td>462.626683 M</td> <td>-8.78</td> <td>-37.60</td> <td>-9.96</td> </tr> <tr> <td>6.250 k</td> <td>12.500 k</td> <td>300.00 k</td> <td>462.646514 M</td> <td>-8.78</td> <td>-37.59</td> <td>-9.96</td> </tr> <tr> <td>12.500 k</td> <td>31.250 k</td> <td>300.00 k</td> <td>462.651522 M</td> <td>-20.76</td> <td>-49.57</td> <td>-11.94</td> </tr> <tr> <td>31.250 k</td> <td>62.500 k</td> <td>30.00 k</td> <td>462.669752 M</td> <td>-22.08</td> <td>-50.89</td> <td>-9.08</td> </tr> </tbody> </table> <p>ProjectNo.:SZNS1240104-00948E-RF Tester:Stu Song Date: 2.FEB.2024 14:15:24</p>	Start	Stop	RBW	Freq	PwrAbs	PwrRel	Limit	[Hz]	[Hz]	[Hz]	[MHz]	[dBm]	[dBc]	[dB]	-62.500 k	-31.250 k	30.00 k	462.605048 M	-24.02	-52.83	-11.02	-31.250 k	-12.500 k	300.00 k	462.621474 M	-20.68	-49.49	-11.86	-12.500 k	-6.250 k	300.00 k	462.626683 M	-8.78	-37.60	-9.96	6.250 k	12.500 k	300.00 k	462.646514 M	-8.78	-37.59	-9.96	12.500 k	31.250 k	300.00 k	462.651522 M	-20.76	-49.57	-11.94	31.250 k	62.500 k	30.00 k	462.669752 M	-22.08	-50.89	-9.08
Start	Stop	RBW	Freq	PwrAbs	PwrRel	Limit																																																				
[Hz]	[Hz]	[Hz]	[MHz]	[dBm]	[dBc]	[dB]																																																				
-62.500 k	-31.250 k	30.00 k	462.605048 M	-24.02	-52.83	-11.02																																																				
-31.250 k	-12.500 k	300.00 k	462.621474 M	-20.68	-49.49	-11.86																																																				
-12.500 k	-6.250 k	300.00 k	462.626683 M	-8.78	-37.60	-9.96																																																				
6.250 k	12.500 k	300.00 k	462.646514 M	-8.78	-37.59	-9.96																																																				
12.500 k	31.250 k	300.00 k	462.651522 M	-20.76	-49.57	-11.94																																																				
31.250 k	62.500 k	30.00 k	462.669752 M	-22.08	-50.89	-9.08																																																				
<p>467.6375 MHz</p>	<p>ProjectNo.:SZNS1240104-00948E-RF Tester:Stu Song Date: 2.FEB.2024 13:58:36</p>	<table border="1"> <thead> <tr> <th>Start</th> <th>Stop</th> <th>RBW</th> <th>Freq</th> <th>PwrAbs</th> <th>PwrRel</th> <th>Limit</th> </tr> <tr> <th>[Hz]</th> <th>[Hz]</th> <th>[Hz]</th> <th>[MHz]</th> <th>[dBm]</th> <th>[dBc]</th> <th>[dB]</th> </tr> </thead> <tbody> <tr> <td>-62.500 k</td> <td>-31.250 k</td> <td>30.00 k</td> <td>467.605049 M</td> <td>-23.30</td> <td>-52.39</td> <td>-10.30</td> </tr> <tr> <td>-31.250 k</td> <td>-12.500 k</td> <td>300.00 k</td> <td>467.621474 M</td> <td>-20.66</td> <td>-49.75</td> <td>-11.98</td> </tr> <tr> <td>-12.500 k</td> <td>-6.250 k</td> <td>300.00 k</td> <td>467.626683 M</td> <td>-8.69</td> <td>-37.78</td> <td>-10.01</td> </tr> <tr> <td>6.250 k</td> <td>12.500 k</td> <td>300.00 k</td> <td>467.646715 M</td> <td>-8.72</td> <td>-37.81</td> <td>-10.04</td> </tr> <tr> <td>12.500 k</td> <td>31.250 k</td> <td>300.00 k</td> <td>467.651522 M</td> <td>-20.67</td> <td>-49.76</td> <td>-11.99</td> </tr> <tr> <td>31.250 k</td> <td>62.500 k</td> <td>30.00 k</td> <td>467.668950 M</td> <td>-22.94</td> <td>-52.03</td> <td>-9.94</td> </tr> </tbody> </table> <p>ProjectNo.:SZNS1240104-00948E-RF Tester:Stu Song Date: 2.FEB.2024 14:17:27</p>	Start	Stop	RBW	Freq	PwrAbs	PwrRel	Limit	[Hz]	[Hz]	[Hz]	[MHz]	[dBm]	[dBc]	[dB]	-62.500 k	-31.250 k	30.00 k	467.605049 M	-23.30	-52.39	-10.30	-31.250 k	-12.500 k	300.00 k	467.621474 M	-20.66	-49.75	-11.98	-12.500 k	-6.250 k	300.00 k	467.626683 M	-8.69	-37.78	-10.01	6.250 k	12.500 k	300.00 k	467.646715 M	-8.72	-37.81	-10.04	12.500 k	31.250 k	300.00 k	467.651522 M	-20.67	-49.76	-11.99	31.250 k	62.500 k	30.00 k	467.668950 M	-22.94	-52.03	-9.94
Start	Stop	RBW	Freq	PwrAbs	PwrRel	Limit																																																				
[Hz]	[Hz]	[Hz]	[MHz]	[dBm]	[dBc]	[dB]																																																				
-62.500 k	-31.250 k	30.00 k	467.605049 M	-23.30	-52.39	-10.30																																																				
-31.250 k	-12.500 k	300.00 k	467.621474 M	-20.66	-49.75	-11.98																																																				
-12.500 k	-6.250 k	300.00 k	467.626683 M	-8.69	-37.78	-10.01																																																				
6.250 k	12.500 k	300.00 k	467.646715 M	-8.72	-37.81	-10.04																																																				
12.500 k	31.250 k	300.00 k	467.651522 M	-20.67	-49.76	-11.99																																																				
31.250 k	62.500 k	30.00 k	467.668950 M	-22.94	-52.03	-9.94																																																				

4.5 FRS Modulation Limits

4.5.1 Applicable Standard

FCC §95.575

Each FRS transmitter type must be designed such that the peak frequency deviation does not exceed 2.5 kHz, and the highest audio frequency contributing substantially to modulation must not exceed 3.125 kHz.

4.5.2 EUT Setup Block Diagram

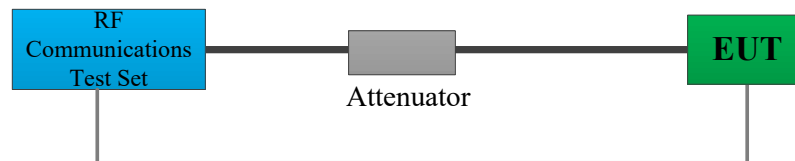

Modulation limiting Test and Audio frequency response Test

4.5.3 Test Procedure

C63.26-2015, Clause 5.3.2 Modulation limiting test methodology

Modulation limiting is the ability of a transmitter circuit to limit the transmitter from producing deviations in excess of a rated system deviation.

- Connect the equipment as illustrated in Figure 1.
- Adjust the transmitter per the manufacturer's procedure for full rated system deviation.
- Set the test receiver to measure peak positive deviation. Set the audio bandwidth for ≤ 0.25 Hz to ≥ 15000 Hz. Turn the de-emphasis function off.
- Apply a 1000 Hz modulating signal to the transmitter from the audio frequency generator, and adjust the level to obtain 60% of full rated system deviation. This is the 0 dB reference level.
- Increase the level from the audio generator by 20 dB in 5 dB increments recording the deviation as measured from the test receiver in each step. Verify that the audio level used to make the OBW measurement is included in the sweep.
- Repeat for step e) at 300 Hz, 2500 Hz and 3000 Hz at a minimum using the 0 dB reference level obtained in step d).
- Set the test receiver to measure peak negative deviation and repeat step d) through step f).
- The values recorded in step f) and step g) are the modulation limiting.
- Plot the data set as a percentage of deviation relative to the 0 dB reference point versus input voltage.

C63.26-2015, Clause 5.3.3.2 Audio frequency response test methodology—Constant Input

- Connect the equipment as illustrated in Figure 3.
- Set the test receiver to measure peak positive deviation. Set the audio bandwidth for ≤ 50 Hz to ≥ 15000 Hz. Turn the de-emphasis function off.
- Adjust the transmitter per the manufacturer's procedure for full rated system deviation.
- Apply a 1000 Hz tone and adjust the audio frequency generator to produce 20% of the rated system deviation.
- Set the test receiver to measure rms deviation and record the deviation reading as DEVREF.
- Set the audio frequency generator to the desired test frequency between 300 Hz and 3000 Hz.

4.5.4 Test Result

Serial Number:	2G7Z-2	Test Date:	2024/2/2
Test Site:	RF	Test Mode:	Transmitting
Tester:	Stu Song	Test Result:	Pass

Environmental Conditions:					
Temperature: (°C)	23.2	Relative Humidity: (%)	59	ATM Pressure: (kPa)	101.1

Test Equipment List and Details:

Manufacturer	Description	Model	Serial Number	Calibration Date	Calibration Due Date
yzjingcheng	Coaxial Cable	KTRFBU-141-50	41010012	2023/9/1	2024/8/31
E-Microwave	Coaxial Attenuators	EMCA10-5RN-6	OE01203239	2023/9/1	2024/8/31
Weinschel	Coaxial Attenuators	53-20-34	LN749	2023/9/1	2024/8/31
HP	RF Communications Test Set	8920A	3438A05201	2023/10/18	2024/10/17

** Statement of Traceability: Bay Area Compliance Laboratories Corp. (Dongguan) attests that all calibrations have been performed, traceable to National Primary Standards and International System of Units (SI).*

Test Data:

**Test Data:
MODULATION LIMITING**

Carrier Frequency: 462.6375 MHz					
Audio Frequency (Hz)	Instantaneous		Steady-state		Limit [kHz]
	Deviation (@+20dB) [kHz]	Deviation (@-20dB) [kHz]	Deviation (@+20dB) [kHz]	Deviation (@-20dB) [kHz]	
300	2.218	0.061	2.175	0.032	2.5
400	2.207	0.082	2.162	0.044	2.5
500	2.169	0.098	2.127	0.057	2.5
600	2.184	0.115	2.141	0.073	2.5
700	2.223	0.131	2.178	0.081	2.5
800	2.247	0.144	2.206	0.094	2.5
900	2.244	0.159	2.202	0.108	2.5
1000	2.249	0.174	2.207	0.123	2.5
1200	2.228	0.206	2.184	0.155	2.5
1400	2.214	0.237	2.171	0.174	2.5
1600	2.211	0.265	2.159	0.201	2.5
1800	2.196	0.296	2.156	0.242	2.5
2000	2.184	0.327	2.141	0.275	2.5
2200	2.191	0.356	2.147	0.304	2.5
2400	2.188	0.385	2.144	0.331	2.5
2600	2.183	0.413	2.139	0.368	2.5
2800	2.172	0.436	2.128	0.382	2.5
3000	2.164	0.447	2.117	0.403	2.5

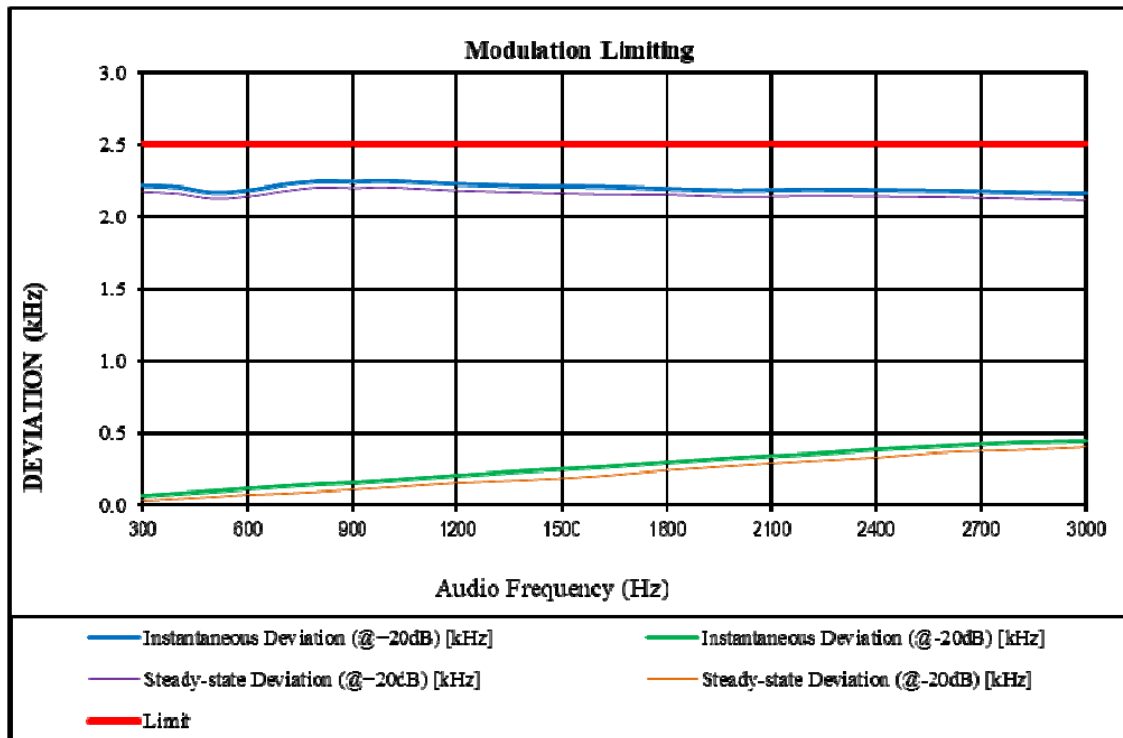

Audio Frequency Response
Carrier Frequency: 462.6375 MHz

Audio Frequency (Hz)	Response Attenuation (dB)
300	-11.86
400	-8.11
500	-6.05
600	-4.42
700	-3.09
800	-1.93
900	-0.91
1000	0.00
1200	1.60
1400	2.95
1600	4.20
1800	5.22
2000	6.13
2200	6.93
2400	7.63
2600	8.29
2800	8.75
3000	8.90
3125	8.82

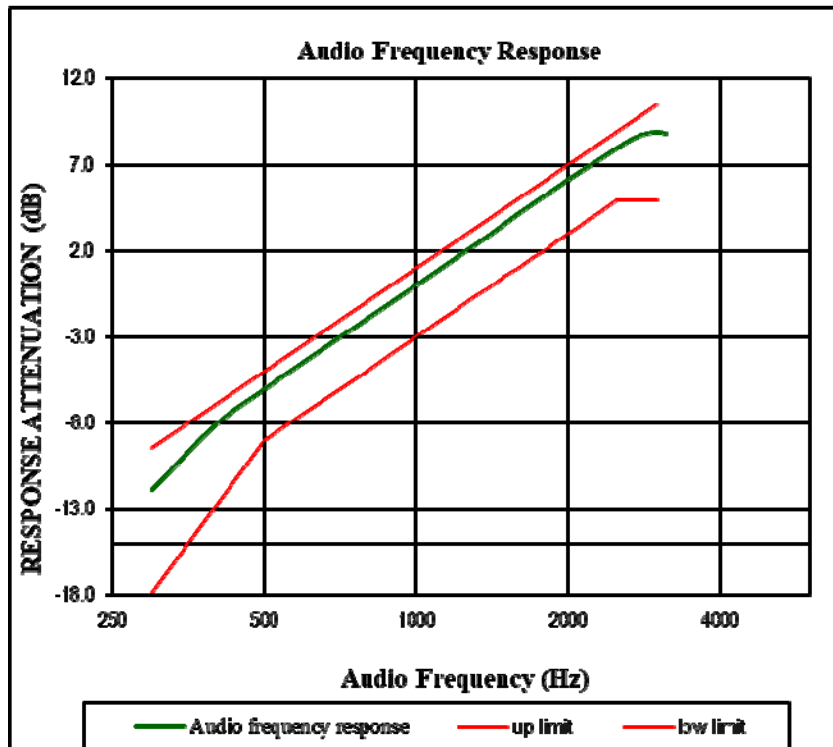

4.6 FRS Unwanted Emissions Limits

4.6.1 Applicable Standard

FCC §95.579

Each FRS transmitter type must be designed to satisfy the applicable unwanted emissions limits in this paragraph.

(a) *Attenuation requirements.* The power of unwanted emissions must be attenuated below the carrier power output in Watts (P) by at least:

(1) 25 dB (decibels) in the frequency band 6.25 kHz to 12.5 kHz removed from the channel center frequency.

(2) 35 dB in the frequency band 12.5 kHz to 31.25 kHz removed from the channel center frequency.

(3) $43 + 10 \log (P)$ dB in any frequency band removed from the channel center frequency by more than 31.25 kHz.

(b) *Measurement bandwidths.* The power of unwanted emissions in the frequency bands specified in paragraphs (a)(1) and (2) of this section is measured with a reference bandwidth of 300 Hz. The power of unwanted emissions in the frequency range specified in paragraph (a)(3) is measured with a reference bandwidth of at least 30 kHz.

(c) *Measurement conditions.* The requirements in this section apply to each FRS transmitter type both with and without the connection of permitted attachments, such as an external speaker, microphone and/or power cord.

4.6.2 Test setup:

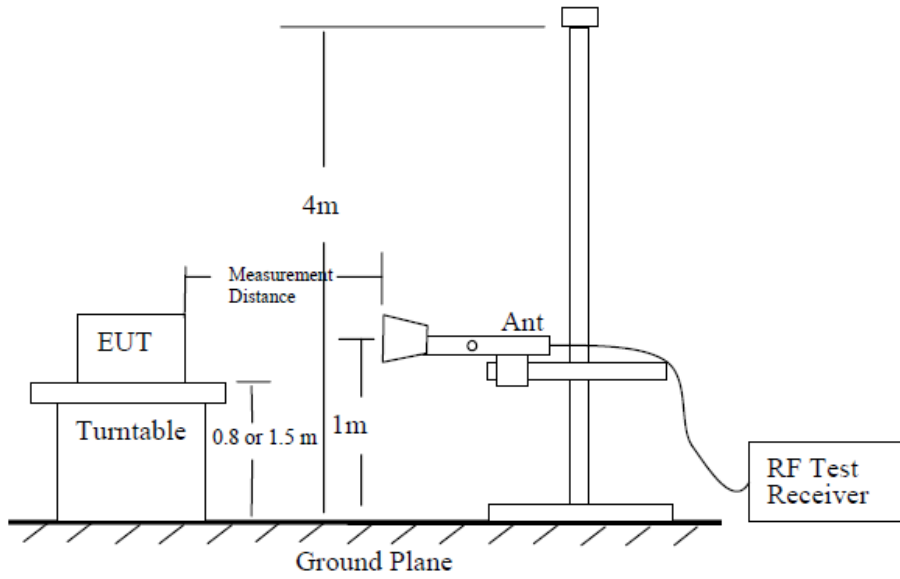

Figure 6—Test site-up for radiated ERP and/or EIRP measurements

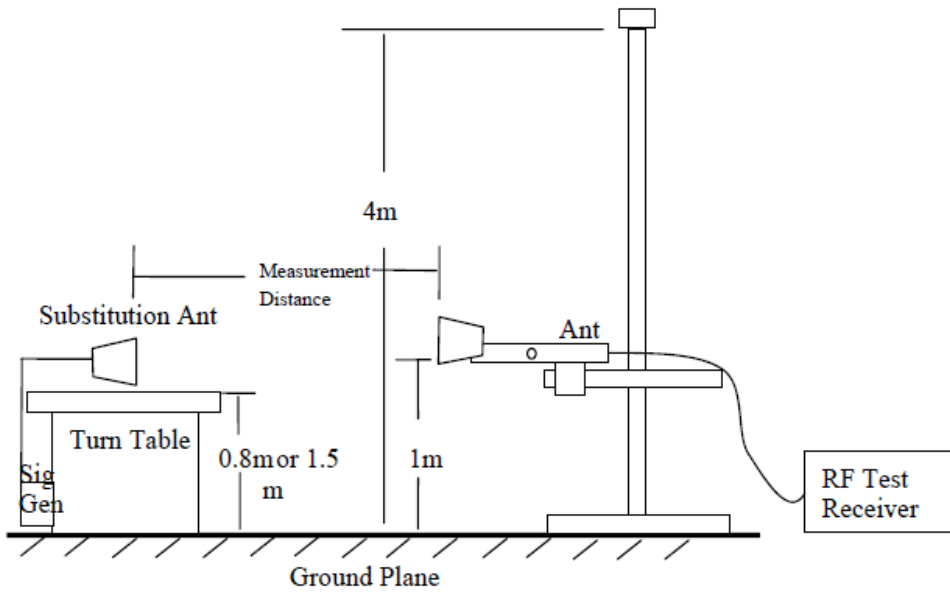

Figure 7—Substitution method set-up for radiated emission

4.6.3 Test Procedure:

ANSI C63.26-2015 Section 5.5.3

- a) Place the EUT in the center of the turntable. The EUT shall be configured to transmit into the standard non-radiating load (for measuring radiated spurious emissions), connected with cables of minimal length unless specified otherwise. If the EUT uses an adjustable antenna, the antenna shall be positioned to the length that produces the worst case emission at the fundamental operating frequency.
- b) Each emission under consideration shall be evaluated:
 - 1) Raise and lower the measurement antenna in accordance 5.5.2, as necessary to enable detection of the maximum emission amplitude relative to measurement antenna height.
 - 2) Rotate the EUT through 360° to determine the maximum emission level relative to the axial position.
 - 3) Return the turntable to the azimuth where the highest emission amplitude level was observed.
 - 4) Vary the measurement antenna height again through 1 m to 4 m again to find the height associated with the maximum emission amplitude.
 - 5) Record the measured emission amplitude level and frequency using the appropriate RBW.
- c) Repeat step b) for each emission frequency with the measurement antenna oriented in both the horizontal and vertical polarizations to determine the orientation that gives the maximum emissions amplitude.
- d) Set-up the substitution measurement with the reference point of the substitution antenna located as near as possible to where the center of the EUT radiating element was located during the initial EUT measurement.
- e) Maintain the previous measurement instrument settings and test set-up, with the exception that the EUT is removed and replaced by the substitution antenna.
- f) Connect a signal generator to the substitution antenna; locate the signal generator so as to minimize any potential influences on the measurement results. Set the signal generator to the frequency where emissions are detected, and set an output power level such that the radiated signal can be detected by the measurement instrument, with sufficient dynamic range relative to the noise floor.
- g) For each emission that was detected and measured in the initial test [i.e., in step b) and step c)]:
 - 1) Vary the measurement antenna height between 1 m to 4 m to maximize the received (measured) signal amplitude.
 - 2) Adjust the signal generator output power level until the amplitude detected by the measurement instrument equals the amplitude level of the emission previously measured directly in step b) and step c).
 - 3) Record the output power level of the signal generator when equivalence is achieved in step 2).
- h) Repeat step e) through step g) with the measurement antenna oriented in the opposite polarization.
- i) Calculate the emission power in dBm referenced to a half-wave dipole using the following equation:

$$P_e = P_s(\text{dBm}) - \text{cable loss (dB)} + \text{antenna gain (dBd)}$$
 where
 - P_e = equivalent emission power in dBm
 - P_s = source (signal generator) power in dBm
 NOTE—dBd refers to the measured antenna gain in decibels relative to a half-wave dipole.
- j) Correct the antenna gain of the substitution antenna if necessary to reference the emission power to a half-wave dipole. When using measurement antennas with the gain specified in dBi, the equivalent dipole-referenced gain can be determined from: $\text{gain (dBd)} = \text{gain (dBi)} - 2.15 \text{ dB}$. If necessary, the antenna gain can be calculated from calibrated antenna factor information
- k) Provide the complete measurement results as a part of the test report.

4.6.4 Test Result

Serial Number:	2G7Z-1	Test Date:	2024/1/26~2024/1/31
Test Site:	Chamber 10m Chamber A	Test Mode:	Transmitting
Tester:	Zoo Zou, Alan Xie	Test Result:	Pass

Environmental Conditions:					
Temperature: (°C)	16.9~19.8	Relative Humidity: (%)	40~52	ATM Pressure: (kPa)	101.3~102.2

Test Equipment List and Details:

Manufacturer	Description	Model	Serial Number	Calibration Date	Calibration Due Date
Sunol Sciences	Hybrid Antenna	JB3	A060611-1	2023/9/6	2024/9/5
Narda	Attenuator	779-6dB	04269	2023/9/6	2024/9/5
Unknown	Coaxial Cable	C-NJNJ-50	C-1000-01	2023/8/1	2024/7/31
Unknown	Coaxial Cable	C-NJNJ-50	C-0400-04	2023/8/1	2024/7/31
Unknown	Coaxial Cable	C-NJNJ-50	C-0530-01	2023/8/1	2024/7/31
R&S	EMI Test Receiver	ESCI	100224	2023/8/18	2024/8/17
EMCO	Adjustable Dipole Antenna	3121C	9109-753	N/A	N/A
Unknown	Coaxial Cable	C-NJNJ-50	C-0200-02	2023/9/4	2024/9/3
Agilent	Signal Generator	E8247C	MY43321350	2023/10/18	2024/10/17
AH	Horn Antenna	SAS-571	1394	2023/2/22	2026/2/22
ETS-Lindgren	Horn Antenna	3115	000 527 35	2023/9/7	2024/9/6
HUBER+SUHNER	Coaxial Cable	SUCOFLEX 126EA	MY369/26/26EA	2023/9/6	2024/9/5
AH	Preamplifier	PAM-0118P	530	2023/9/1	2024/8/31
R&S	Spectrum Analyzer	FSP 38	100478	2023/10/18	2024/10/17
Mini-Circuits	High Pass Filter	VHF-1200+	31102	2023/8/1	2024/7/31

* Statement of Traceability: Bay Area Compliance Laboratories Corp. (Dongguan) attests that all calibrations have been performed, traceable to National Primary Standards and International System of Units (SI).

Frequency (MHz)	Polar (H/V)	Receiver Reading (dBµV)	Substituted Method			Absolute Level (dBm)	Limit (dBm)	Margin (dB)
			Substituted Level (dBm)	Antenna Gain (dBd/dBi)	Cable Loss (dB)			
frequency:462.6375MHz								
925.28	H	35.55	-37.03	0.00	0.36	-37.39	-13.00	24.39
925.28	V	37.45	-31.93	0.00	0.36	-32.29	-13.00	19.29
1387.91	H	69.42	-50.05	9.53	1.12	-41.64	-13.00	28.64
1387.91	V	82.49	-36.75	9.53	1.12	-28.34	-13.00	15.34
1850.55	H	62.50	-54.53	11.05	2.82	-46.30	-13.00	33.30
1850.55	V	71.14	-46.88	11.05	2.82	-38.65	-13.00	25.65
2313.19	H	66.15	-50.02	11.94	2.10	-40.18	-13.00	27.18
2313.19	V	66.01	-49.65	11.94	2.10	-39.81	-13.00	26.81
2775.83	H	67.50	-49.07	12.31	1.30	-38.06	-13.00	25.06
2775.83	V	74.36	-40.48	12.31	1.30	-29.47	-13.00	16.47
3238.46	H	73.58	-42.62	12.30	1.33	-31.65	-13.00	18.65
3238.46	V	75.08	-39.28	12.30	1.33	-28.31	-13.00	15.31
3701.10	H	86.60	-28.09	12.24	1.33	-17.18	-13.00	4.18
3701.10	V	85.15	-27.49	12.24	1.33	-16.58	-13.00	3.58
4163.74	H	73.27	-41.01	12.66	1.32	-29.67	-13.00	16.67
4163.74	V	73.05	-39.03	12.66	1.32	-27.69	-13.00	14.69
4626.38	H	60.88	-54.29	13.30	1.30	-42.29	-13.00	29.29
4626.38	V	62.30	-50.37	13.30	1.30	-38.37	-13.00	25.37
frequency:467.6375MHz								
935.28	H	37.97	-34.35	0.00	0.36	-34.71	-13.00	21.71
935.28	V	39.22	-29.91	0.00	0.36	-30.27	-13.00	17.27
1402.91	H	71.67	-47.85	9.59	1.14	-39.40	-13.00	26.40
1402.91	V	83.17	-36.08	9.59	1.14	-27.63	-13.00	14.63
1870.55	H	63.88	-52.99	11.11	2.91	-44.79	-13.00	31.79
1870.55	V	69.76	-48.19	11.11	2.91	-39.99	-13.00	26.99
2338.19	H	65.67	-50.53	11.97	1.99	-40.55	-13.00	27.55
2338.19	V	67.96	-47.56	11.97	1.99	-37.58	-13.00	24.58
2805.83	H	67.32	-49.27	12.32	1.30	-38.25	-13.00	25.25
2805.83	V	73.50	-41.37	12.32	1.30	-30.35	-13.00	17.35
3273.46	H	73.38	-42.74	12.29	1.33	-31.78	-13.00	18.78
3273.46	V	73.07	-41.19	12.29	1.33	-30.23	-13.00	17.23
3741.10	H	83.54	-30.97	12.25	1.33	-20.05	-13.00	7.05
3741.10	V	82.53	-29.92	12.25	1.33	-19.00	-13.00	6.00
4208.74	H	68.24	-46.31	12.76	1.32	-34.87	-13.00	21.87
4208.74	V	68.20	-44.12	12.76	1.32	-32.68	-13.00	19.68
4676.38	H	59.46	-55.27	13.26	1.29	-43.30	-13.00	30.30
4676.38	V	60.77	-51.42	13.26	1.29	-39.45	-13.00	26.45

Note 1: The unit of antenna gain is dBd for frequency below 1GHz and is dBi for frequency above 1GHz.

Note 2:

Absolute Level = Substituted Level - Cable loss + Antenna Gain

Margin = Limit- Absolute Level

4.7 FRS Additional Requirements

4.7.1 Applicable Standard

FCC §95.587

Each FRS transmitter type must be designed to meet the following additional requirements.

- (a) *Transmit frequency capability.* FRS transmitter types must not be capable of transmitting on any frequency or channel other than those listed in § 95.563.
- (b) *Antenna.* The antenna of each FRS transmitter type must meet the following requirements.
- (1) The antenna must be a non-removable integral part of the FRS transmitter type.
 - (2) The gain of the antenna must not exceed that of a half-wave dipole antenna.
 - (3) The antenna must be designed such that the electric field of the emitted waves is vertically polarized when the unit is operated in the normal orientation.
- (c) *Digital data transmissions.* FRS transmitter types having the capability to transmit digital data must be designed to meet the following requirements.
- (1) FRS units may transmit digital data containing location information, or requesting location information from one or more other FRS or GMRS units, or containing a brief text message to another specific FRS or GMRS unit or units.
 - (2) Digital data transmissions may be initiated by a manual action or command of the operator or on an automatic or periodic basis, and FRS units may be designed to automatically respond with location data upon receiving an interrogation request from another
 - (3) Digital data transmissions must not exceed one second in duration.
 - (4) Digital data transmissions must not be sent more frequently than one digital data transmission within a thirty-second period, except that an FRS unit may automatically respond to more than one interrogation request received within a thirty-second period.
- (d) *Packet mode.* FRS transmitter types must not be capable of transmitting data in the store-and-forward packet operation mode.
- (e) Effective September 30, 2019, no person shall manufacture or import hand-held portable radio equipment capable of operating under this subpart (FRS) and other licensed or licensed-by-rule services in this chapter (part 15 unlicensed equipment authorizations are permitted if consistent with part 15 rules).

4.7.2 Judgment

Transmit frequency capability: Compliance, please refer to section 2.1.

Antenna: Compliant, please refer to section 1.3.

Digital Data transmissions: Not Applicable, no digital modulation function.

Packet mode: Not Applicable, no digital modulation function.

No capable of FRS combined other licensed: Compliance, Only FRS function

5. EUT PHOTOGRAPHS

Please refer to the attachment SZNS1240104-00948E-RF-EXP EUT EXTERNAL PHOTOGRAPHS and SZNS1240104-00948E-RF-INP EUT INTERNAL PHOTOGRAPHS

6. TEST SETUP PHOTOGRAPHS

Please refer to the attachment SZNS1240104-00948E-RF-00-TSP TEST SETUP PHOTOGRAPHS.

===== END OF REPORT =====