

Potensic ATOM **SE**

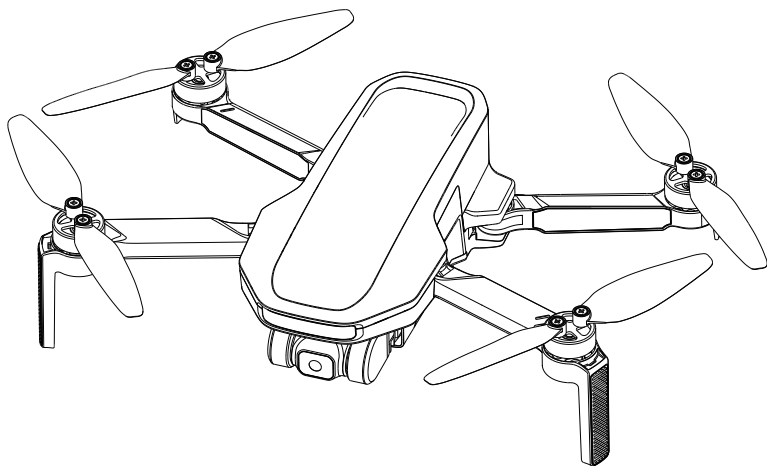

DANGER
Only suitable
for age 14+



User Manual

Email: support@potensic.com
Email: support.uk@potensic.com
Email: support.de@potensic.com

Email: support.fr@potensic.com
Email: support.it@potensic.com
Email: support.es@potensic.com

Email: support.jp@potensic.com
Web: www.potensic.com
FB: www.facebook.com/Potensic

» 1.1 Disclaimer

Please follow the Manual's operation instructions and precautions strictly, in order to use the product safely and correctly. Users aged under 14 must be accompanied by an adult while using the product. Please keep the product out of children's reach.

For any direct or indirect loss (including but not limited to property loss and personal injury) due to user's failure in following the Manual's safety operation, the Company does not bear any liability or offer warranty services.

Do not dismantle any part except for propeller blades, or refit the product and attach other items on it; otherwise, user should undertake the consequences arising therefrom.

For any problem in use, handling and maintenance, please feel free to contact our local dealer or the Company.

» 1.2 Safety Precautions

Keep away from obstacles and crowds

Keep the product away from crowds, high-rise buildings and high-voltage cables, and avoid using it in severe weather such as wind, rain and thunder, in order to keep safety of user and the crowds, for the product may have uncertain flying speed, status and potential hazards.

Keep off moisture

Keep the product off moisture to avoid an anomaly or damage due to humidity of precise electronic components and mechanical parts inside it.

Safe operation

The product may be exposed to higher risk when user feels tired or lacks of energy and experience. Please refit or repair the product with the original parts to keep safety. Please operate and use the product within the allowed range and make sure to follow the local safety rules.

Keep away from high-speed revolving parts

While the product's propellers are revolving at a high speed, keep it away from the crowds and animals to avoid scratch or disturbance. Do not touch the revolving propellers with hands.

Keep away from heat source

Keep the product away from heat and high-temperature exposure to avoid the anomaly, deformation and even damage, for it is made of metal, fiber, plastic and electronic elements.

» 1.3 Warning & Prompts

01. Please properly keep the package and manual which contain important information.
02. User should avoid personal and property losses when using the product.
03. Neither the Company nor our dealers bear any liability for the proper losses and personal injuries due to users.
04. Debug and install the product in strict accordance with the Manual's steps. Keep a distance over 1~2m with others while using the product, to avoid injury when the product crashes into people's head, face and body.
05. The product should be assembled by an adult. Users aged below 14 should not handle the product alone. The battery should be charged under the supervision of an adult and by avoiding inflammables.
06. Keep the product out of children's reach to avoid eating it by mistake, for it contains small parts.
07. Do not use the product on the road or water to avoid an accident.
08. It is forbidden to dismantle or refit the product, except for the propellers; otherwise, an anomaly may occur.
09. Please recharge the intelligent battery with USB charger that conforms to FCC/CE standard.
10. The remote controller has a built-in 3.7V lithium battery which needs no replacement.
11. Do not short circuit or squeeze the battery to avoid explosion.
12. Do not short circuit, break down or throw battery in fire or place it in hot place (in fire or near electric heater).
13. Keep a safe distance to the propellers which are revolving at a high speed; do not use the product in the crowds to avoid scratch or injury.
14. Do not use the product in places with strong magnetic field, such as near high-voltage cable, buildings which contain metals, automobiles and trains; otherwise, the product can be disturbed.
15. Please do master local laws and regulations, to avoid violation of regulations.
16. Stop using the remote control within the radio control period and region of national departments as specified, in order to conform to the requirements for magnetic environment of aeradio.
17. Avoid low-altitude flight above water surface.
18. Keep it away from airport, airline and other no-fly zone.

2. Reading Tips

» 2.1 Symbols

 Prohibited  Important  Operation & use prompts  Vocabulary explanation and reference information

» 2.2 Suggestions of Use

1. User is highly suggested to watch the teaching video and **Quick Operation Guide** before consulting the **Manual**.
2. Make sure to read **Disclaimer & Precautions** first when consulting the **Manual**.

» 2.3 Teaching Video / PotensicPro APP

Scan the QR Code at the right side to view **Potensic Atom SE** (Atom SE) teaching video and download **PotensicPro APP** (APP)

Please do watch the teaching video in order to use the product correctly and safely.

User can also view the teaching video of Atom SE in the menu column of APP homepage.



» 2.4 Registration & Help

Make sure to register personal account in APP before the first flight, in order to get better use experience.

Steps of Registration

Please fill your E-mail, password, check the protocol and click "Register". You can login the system after registration.

(Note: Keep the mobile phone online during registration)

Help

Thanks for purchasing Atom SE drone. Please read the Manual carefully.













Please contact our support team (support@potensic.com), and show us your product order number of Amazon or official website, if any help is needed.

» 2.5 Vocabulary Explanation

IMU	IMU (inertial measurement unit), the most important core sensor of the drone.
TOF (Time of Flight)	TOF (time of flight), the period from transmission and receiving of detection infrared signal, in order to determine the target distance.
Lower visual system	The sensor system, which lies at the bottom of the drone and consists of camera and TOF module.
Visual orientation	High-accuracy positioning, which is realized through lower visual system.
Compass	Identify direction for geomagnetic sensor and the drone.
Barometer	Atmospheric pressure sensor, which enables the drone to determine the altitude through atmospheric pressure.
Lock/unlock	Switch the drone motor from static status to idle running.
Idling	Once unlocked, the motor will start revolving at a fixed speed, but it has insufficient lifting force to take off.
Auto return	The drone will return to HOME point automatically based on GPS positioning.
EIS	Electronic stabilization; the camera will detect the data of high-frequency vibration and eliminate picture flutter through algorithm.
Drone head	Position of the drone camera.
Throttle control stick	Ascend or descend the drone.
Pitch control stick	Fly the drone to front or back.
Roll control stick	Fly the drone to left or right.
Yaw control stick	Enable self-rotation of the drone to left or right.

» 2.6 Packing List

Please check if your package contains the following items before using the product:

Picture	Description	Single Battery Version	Double Battery Version	Fly Expansion Kit
	Drone (including propeller blades and camera)	1	1	/
	Remote control	1	1	/
	Smart battery	1	2	2
	Spare propellers	8	8	8
	Screw driver of propeller blades	1	1	/
	Specific screws of propeller blades	8	8	8
	Data cable (for charging the battery and the remote control)	1	1	/
	Adapter cable of the remote control	3	3	/
	Parallel Charging HUB	/	/	1
	Parallel Charging HUB Specific adapter	/	/	1
	Portable handbag	/	1	1
	User's manual	1	1	/
	Parallel Charging HUB User's manual	/	/	1

01 Disclaimer & Precautions

- Disclaimer
- Safety & Precautions
- Warning & Prompts

02 Reading Tips

- Symbols
- Suggestions of Use
- Teaching Video/Download APP
- Registration & Help
- Vocabulary Explanation
- Packing List

04 Contents

05 Overview

- Introduction
- Name of the Drone Parts
- Name of the the Remote Control
- Preparation of the Drone
- Preparation of the Remote Control
- Charging/Startup and Shutdown

09 Drone

- Positioning
- Lower Visual System
- Drone Status Indicator
- Smart Battery
- Propeller
- Flight Data
- Steering Engine Camera

14 Remote Control

- Overview
- Control Stick Mode
- Function Introduction
- Antenna Angle

18 PotensicPro APP

- APP Homepage
- Flight Interface

21 Flight

- Requirements of Flight Environment
- Flight Precautions
- Connection
- Flight Level
- Compass Calibration
- Beginner Mode
- Takeoff/Landing/Hovering
- Smart Flight
- Auto Return
- Emergency Stop

26 Appendix

- Specification & Parameters
- Authentication Introduction

This chapter introduces the functional characteristics of Atom SE, as well as the component name of the drone and the remote control.

» 3.1 Introduction

With foldable arms and a weight below 250g, the product is portable, which can also be used without real-name registration in most countries. The product is fitted with a visual positioning system, to realize precise hovering at low altitude indoor and outdoor environment. Meanwhile, the product is fitted with a GPS sensor to realize positioning and auto return. Based on 1/3 " Sony CMOS image sensor, the product can shoot 4K/30FPS HD video and 1.2-megapixel pictures.

By using the brand new PixSync 2.0 2.4G digital image transmission technique, the Atom SE remote control can realize 4 km communication distance and 720P HD image transmission maximally at ideal conditions. Open the pull-type and the foldable remote control to contain your mobile device. Connect the remote control and mobile device with USB data cable, to operate and set the product through APP and display HD image transmission picture. The built-in lithium battery of the remote control can work for approx. 2h maximally. The max. horizontal travelling speed of Atom SE can reach 16m/s and the max. flight period is approx. 31min; it can resist the Scale 5 wind.

- ⚠ Test method of the max. flight period: Fly at an even speed of 5m/s at 25°C and breezeless condition.**
Test method of the max. distance: Measured at an open and no-interference environment, with a flight height of 120m, and without considering the return of the drone.

Necessary tools for one flight:

1. Drone 2. Fully-charged smart battery 3. Remote control 4. Smart phone 5. Adaptive data cable of mobile phone

» 3.2 Name of the Drone Parts

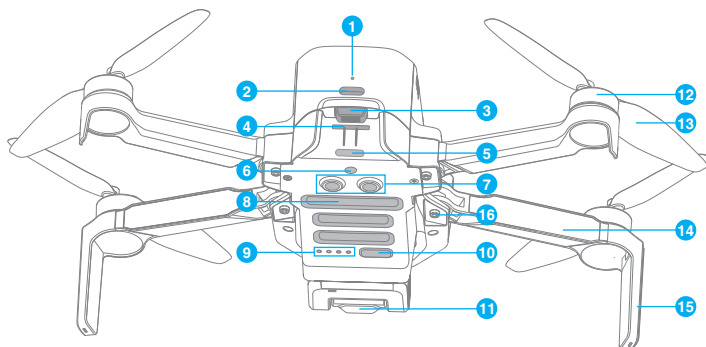

- | | | |
|----------------------------|--|--------------------|
| 1. Charging indicator | 7. TOF module | 13. Propeller |
| 2. TYPE-C charging port | 8. Bottom cooling hole | 14. Arm |
| 3. Battery buckle | 9. Power indicator | 15. Antenna tripod |
| 4. SD card slot | 10. Power/frequency pairing button | 16. Arm shaft |
| 5. Tail indicator | 11. Integrated camera of steering engine | |
| 6. Monocular visual module | 12. Brushless motor | |

» 3.3 Name of the the Remote Control

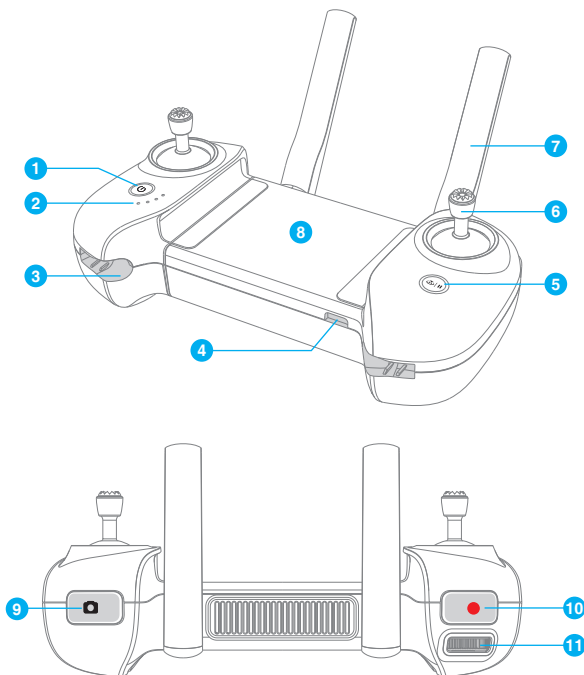

1. Power button

Long press it for 2s to power on/off.

2. Power indicator

Indicate the electric quantity or other status of the remote control

3. Control stick slot

One slot respectively at the left and right side, which are used to contain control stick.

4. TYPE-C interface

To charge the remote control/connect mobile device

5. Return / Pause button

Long press for 1s to return to HOME point automatically

Short press it to pause auto flight

6. Control stick

7. Foldable double antennas

8. Installation position of mobile device

To place mobile device.

9. Shoot button

Short press it to shoot one picture

10. Record button

Short press it to start/stop recording

11. Left thumbwheel

Dial the left/right thumbwheel to adjust the pitch shooting angle of camera

» 3.4 Preparation of the Drone

The product is delivered under folded status. Please unfold it as follows:

1. Remove the propeller belt.

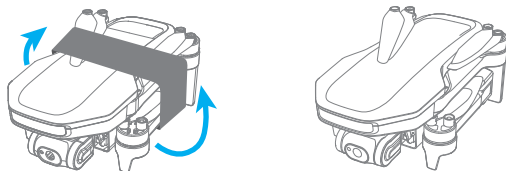

2. Unfold the front arm before the rear arm, and unfold the propeller blades.

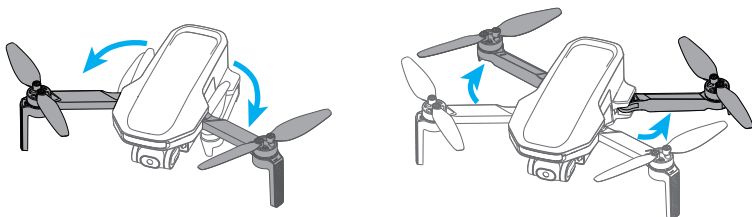

⚠ User is suggested to fold the arms and fix the propeller blades with belt when carrying the product.

» 3.5 Preparation of the Remote Control

Installation of mobile phone and control stick

1. Open the antenna.
2. Insert the mobile phone to the bent side of USB cable.
3. Push the data cable side of mobile phone into the card slot of the remote control.
4. Pull and open the remote control with both hands, fix both ends of mobile phone stably.
5. Insert the other end of data cable to the remote control.
6. Remove control stick.
7. Screw in control stick screw hole clockwise
8. Installation completed.

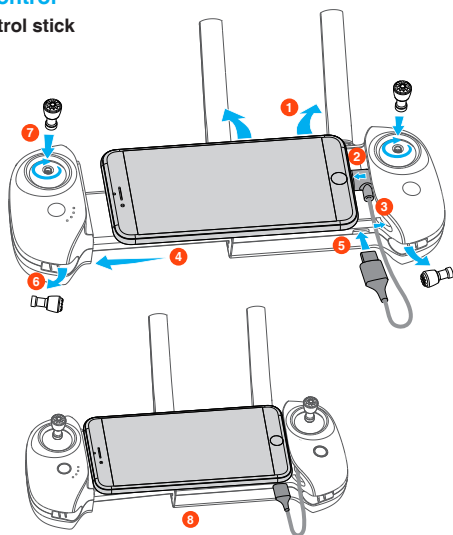



» 3.6 Charging / Startup and Shutdown

Wake up battery prior to the first flight; Otherwise, it cannot be started. Connect the TYPE-C charging port of battery and USB charger to the AC power supply to finish one-time charging (USB charger is not included in the product. User can use the charger that conforms to FCC/CE specification to charge the product).

The red indicator will be on during charging, and turn off automatically after charging is done.

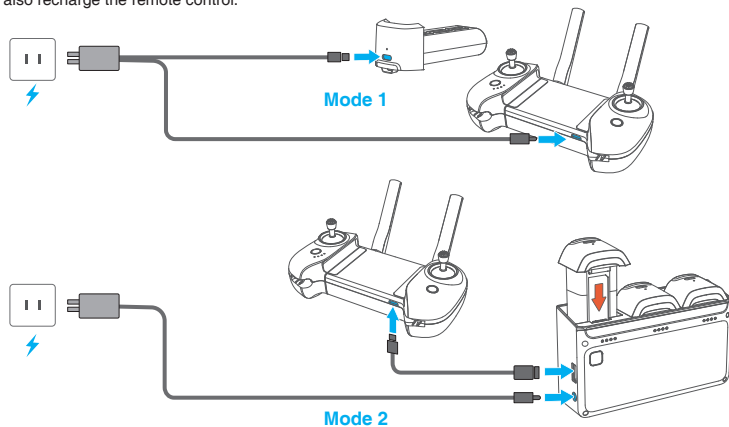
User can recharge the battery with Parallel Charging HUB if fly expansion kit is purchased. For details, please refer to **User's Manual of Parallel Charging HUB**. Meanwhile, the Parallel Charging HUB can also recharge the remote control.



-  The shortest charging period is approx. 1h 25min through TYPE-C charging port. Make sure your charger supports 5V/3A output in order to realize this charging speed.
User is suggested to charge battery through Parallel Charging HUB, in order to charge 3 batteries quickly at the same time.
-  It is suggested to take out battery for charging for the sake of safety; otherwise, the product fails to be started if the battery is inside the product when being charged.
When the charging wire is inserted while the product is powered on, the product will shut down automatically and then continue with charging.
The battery may become too hot after use; do not charge it until it cools down; otherwise, charging can be rejected by smart battery. Recharge the battery on a trimonthly basis, to guarantee the activity of cell.
Please connect the original data cable or the cable that supports over 3A current to the TYPE-C interface; otherwise, it may have charging failure or battery damage.

Startup

Drone: Make sure the battery is inserted in battery bin, short press and then long press the power button until all indicators are on, and then release the button to start up.

Remote control: Long press the "Power" button until all indicators are on, and then release the button to finish startup.

Shutdown

Drone: Short press and then long press the power button of the drone until all indicators are on, and then release the button to shut down.

Remote control: Long press the power button until all indicators are off, and then release the button to shut down.

The product consists of a flight control system, a communication system, a positioning system, a power system and a smart flight battery. This chapter sets down the functions of all parts of the drone.

» 4.1 Positioning

The new generation flight control of Potensic is adopted in Atom SE. The following two positioning modes below are supported by this flight control:

GPS positioning: Realize precise positioning through GPS module; support precise hovering, smart flight and auto return.

Visual positioning: It can realize high-precision positioning at a low altitude based on the lower visual system. The visual positioning can be realized without GPS signal, so that the product can be used indoors.

How to switch: The flight control system will switch automatically according to the environment of the drone. If both GPS and lower visual system fail, the flight control will be switched to attitude mode, under which, the drone fails to realize stable hovering and user needs to correct the flight gesture manually through the control stick.

The difficulty of drone handling will be increased greatly in the attitude mode; make sure to master the behaviors and operation of the drone in this mode before using this mode; avoid flying the drone at a long distance, to avoid risks due to failed judgment of drone gesture.



User can also switch to attitude mode in APP.



In visual positioning, smart flight is not supported and flight speed will be restricted.



Make sure to master the operation characteristics of the drone in this mode, for the difficulty of drone handling will be increased greatly in attitude mode. Always keep the drone within sight in order to avoid hazards due to failed judgment of drone gesture and direction.

» 4.2 Lower Visual System

Atom SE is fitted with a lower visual system that is installed at bottom of the drone and consists of monocular camera and TOF module. Furthermore, the TOF module is divided into transmission tube and receiving tube, to calculate the height of the drone relative to ground accurately by measuring the period from transmission to receiving of infrared signals. With the help of monocular camera, it can calculate low-altitude accurate position of the drone and then realize high-precision positioning.

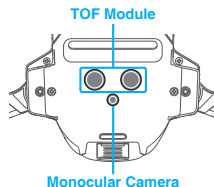

Observation range

The working altitude range of lower visual system: Available at 0.3-30m, realize precise positioning at 0.3-5m.

Application scenario

The visual positioning function realized by the lower visual system applies to the scenario which has no GPS signal or poor GPS signal, rich surface texture, enough light condition and the relative height of the drone is 0.3-5m. When this range is exceeded, please use the product with caution for the positioning accuracy can be reduced.

Use method

It will be enabled automatically when visual positioning conditions are satisfied. In visual positioning mode, the tail indicator of the drone will flicker slowly in cyan.

Speed limit: The flight speed will be restricted at 1m/s when visual positioning and flight is entered, in order to ensure positioning accuracy and flight safety.



Visual positioning is an auxiliary flight function only. Please pay attention to the changes of flight environment and positioning mode, instead of excessively relying on self-judgment of the drone. User needs to handle the remote control in the full process, and always gets ready for manually operating the drone.

Visual positioning may fail in the following surface texture

1. Pure-color surface
2. Surface with strong reflection, such as smooth metal surface
3. Transparent object surface, such as water surface and glass

4. The moving texture, such as running pets and moving vehicles.
5. Scenarios with drastic change of light; For example, the drone flies to outdoor space with strong light from indoor space.
6. Places with weak or strong light.
7. The surface with highly repetitive texture, such as floor tile with the same texture and small size, and highly consistent strip pattern.

For the sake of safety, please check the camera and TOF receiving tube prior to flight to remove dirt. Please feel free to contact the after-sales department for repairing if there's damage.

» 4.3 Drone Status Indicator

Start-up/Shut-down	Startup / Shutdown in progress: Green indicator is normally on			
Flight status	GPS positioning	Visual positioning	Attitude mode	Return
	Indicator flickers slowly in green	Indicator flickers slowly in cyan	Indicator flickers slowly in blue	Indicator flickers slowly in red
Warning & Error	Remote control has no connection with the drone (communication lost)	Low battery	Sensor error	Emergency stop of propeller
	Indicator is normally on in blue	Indicator flickers quickly in red	Indicator is normally on in red	Indicator has long-extinguishing and short-illumination
Upgrade & calibration	Compass calibration (horizontal)	Compass calibration (vertical)	Frequency pairing mode	Upgrade mode
	Indicator has alternative flickering between red and green	Indicator has alternative flickering between blue and green	Indicator flickers quickly in green	Indicator flickers quickly in blue

» 4.4 Smart Battery

4.4.1 Function Introduction

Atom SE smart battery is mounted with high-energy cell and advanced BMS. The details are as follows:

Basic Parameters			
Model: DSBT02A			
Cell Qty.	2 series	Battery Capacity	2500mAh
Rated Voltage	7.2V	Charge Completion Voltage	8.4V
Charging Mode	TYPE-C/Parallel Charging HUB	Max. Charge Current	TYPE-C: 5V/3A Parallel Charging HUB: 8V/2.2A x 3

Function	Introduction
Balance protection	Balance cell voltage automatically to guarantee battery health.
Self-discharge protection	Fully charged battery can be used for 5 days; if there's no operation in this period, the battery will be discharged slowly to around 70%, in order to protect the cell.
Overcharge protection	Charging will stop once battery is fully charged, for the battery can be damaged by overcharge.
Temperature protection	Please pay attention to your charging environment, for charging will be stopped automatically when battery temperature is below 0°C or above 50°C.
Intelligent current limiting of charging	When charging current is too high, the battery will restrict current automatically in order to protect the battery.
Overdischarge protection	In non-flight status, the battery will cut off power supply automatically to avoid over-discharge when battery is discharged to a certain level; at this time, the battery will enter sleep status. It is suggested to charge the battery ASAP.
Short-circuit protection	When the drone short-circuit is detected by the battery, the power supply will be cut off automatically to protect the battery and the drone.
Battery health monitoring	The BMS will monitor the battery health condition, prompt battery damage in APP in case of cell damage, cell voltage unbalance or other battery errors, to remind user to replace the battery in time.
Communication function	The battery can communicate with the the drone in real time. User can view the information in APP, such as battery circulation times and real-time electric quantity.

⚠ Read and follow the Manual's disclaimer and requirements on battery sticker before using the smart battery; otherwise, user should undertake the consequences arising therefrom.

4.4.2 Battery Installation & Removal

Installation:

Push the battery into the product's battery bin horizontally as shown in picture below, the battery buckle is bounced and locked when hearing "click" sound.

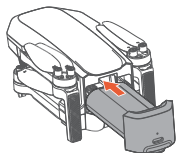

Removal:

Firstly, press the buckle of smart battery, hold the upper cover of battery to pull out the battery.

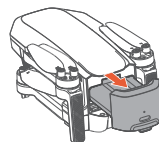

⚠ Once the battery is inserted, make sure the battery buckle is bounced properly. This step is highly important and related to flight safety.

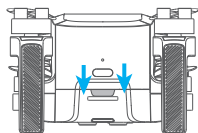

Make sure to power off the product before removing the battery.



Buckle is in position, safe



Buckle is not in position, which may make battery fall during flight

4.4.3 Charging

See 3.6 for charging method

4.4.4 View Electric Quantity

Once the battery is inserted in the drone, short press the power button to view the electric quantity of smart battery, as shown in the picture below:

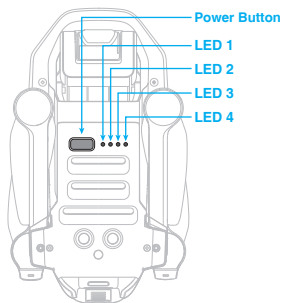

LED 1	LED 2	LED 3	LED 4	Current electric quantity
☀	●	●	●	0%~25%
☀	●	●	●	25%~30%
☀	☀	●	●	30%~50%
☀	☀	●	●	50%~55%
☀	☀	☀	●	55%~75%
☀	☀	☀	●	75%~80%
☀	☀	☀	☀	80%~97%
☀	☀	☀	☀	97%~100%
☀	☀	☀	☀	97%~100%

☀ Indicator is normally on ☀ Indicator is flickering ● Indicator is off

4.4.5 Operation Instructions of Smart Battery at High/low Temperature





When battery temperature is $<10^{\circ}\text{C}$, the APP will prompt battery low temperature and the battery needs preheat before use.

When battery temperature is $>53^{\circ}\text{C}$, the APP will prompt battery high temperature and the drone may fail to take off.

⚠ The discharge capacity will be weakened greatly and flight duration will reduce at a low temperature, which is normal. Avoid long-term running at a low temperature, otherwise, the battery life can be shortened.

» 4.5 Propellers

The propellers of Atom SE are divided into forward and reverse propellers. The marked propeller blades are forward propeller blades, rotate clockwise and corresponding arms have the same marks; the unmarked propellers are reverse propellers, rotate anticlockwise and the corresponding arms have no mark.

	Propeller	Installation Instructions	Schematic Diagram of Installation
Marked propeller		Install the marked propeller blades on marked arm	
Unmarked propeller		Install the unmarked propeller blades on unmarked arm	

 The components include specific screwdriver, spare propeller blades and screws.

Hold the motor to remove the propeller blades easily.

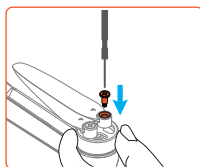

 Make sure to replace propeller blades with the original screws and fasten screws.

While installing the propeller blades, make sure the side with characteristic faces upwards; otherwise, the product may fail to take off.

For any damage of propeller blades, it is recommended to replace all propeller blades and screws on this motor. The new propeller blades installed must be from the same pack.

While removing and using the propeller blades, avoid scratch and deformation due to squeezing of hard objects, for the propeller edge is thin.

The propellers are quick-wear parts, which should be purchased separately.

Keep off the revolving propellers to avoid injury.

For any jitter, reduced speed and duration in flight, please inspect the propeller blades in time, or timely replace the propellers which are damaged or deformed.

Make sure the motor has no foreign matters, can rotate freely and be free from noise. For any anomaly of motor, do not unlock it, but contact the after-sales department for troubleshooting. Make sure to inspect the propeller blades and motor and timely replace the damaged propeller blades prior to flight.

 While removing propeller blades, do not insert the screwdriver or other sharp objects into the ventilation holes of motor; otherwise, the power motor can be damaged severely.



» 4.6 Flight Data

Atom SE supports recording of flight data. User can view the data in APP.

"Flight record" can display the basic data for each flight of user.

"Flight log" can record the detailed flight data of user. For any anomaly in flight, user can report it in APP and, if necessary, upload the flight log to seek for assistance.

 All flight data are stored in user's mobile device. No flight data will be acquired by the Company, except for the data uploaded by user to the cloud platform.

» 4.7 Steering Engine Camera

4.7.1 Steering Engine

The Atom SE camera is mounted with a steering engine platform, to adjust pitch angle freely from +20° to -90° (horizontal direction is 0°).

The angle of steering engine can be adjusted by dialing the left thumbwheel of the remote control.

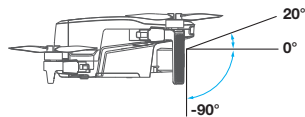

☀ The steering engine will be recovered to -9° automatically after each startup.

⚠ Avoid collision and moving the lens by force, for the steering engine contains precise parts. Make sure the steering engine has no foreign matters and lens is free from dirt before takeoff. The steering engine is connected to the drone through elastic and shock absorption support, to eliminate camera vibration. Do not pull the steering engine by force. For any damage of shock absorption support, please timely contact the after-sales department for repairing.

⊘ Do not bind or paste any object on the steering engine. Otherwise, it may damage the drone.

4.7.2 Camera

Basic Parameters	
Sensor brand: SONY	Sensor size: 1/3"
Effective pixel: 1300W	Aperture: F2.2
FOV: 118°	Focus range: 3m ~ ∞
ISO range: 100-6400	Shutter range: 1/30-1/25,000s
Memory: Micro SD card	Shooting distortion: < 1% (after calibration)

Shooting Ability	
Picture size: 12M (4,608*2,592)	Picture format: JPG/JPG+RAW(DNG)
Video specification: 4K30 2.7K30 1080P60 1080P30	
Video format: MP4	Code: H.264

⚠ Do not touch the lens that will become hot after long-term recording to avoid scald. Do not record video when the product has no flight; otherwise, the drone can enter overheat protection. In 1080P60 format, the image mode is middle cutting, FOV is approx. 66°.

4.7.3 Image Storage

The videos and pictures recorded by Atom SE will be stored in SD card, instead of APP or user's album. Make sure to insert SD card prior to flight. Otherwise, it is unable to record and shoot. (SD card is not included in the product's pack list!)

User can preview and download the videos and pictures (the drone and the remote control should be connected) in APP.

Introduction to SD Card

File format: FAT32

Capacity: 4G-256G

Speed requirements: It is suggested to use SD card above U1 (UHS Speed Class 1) or C10 (Class 10)

☀ The video downloaded from APP is just 720P image used in image transmission. Please read SD card with computer or other device in order to acquire videos of higher definition.

⚠ The recording can be terminated due to slow write-in when using the U1/C10 SD cards of certain brands. The product does not support exFAT files. When SD card formatted exFAT is inserted by user, the APP will prompt formatting; otherwise, the product cannot be used.

If important data are stored in your card, please backup them properly to keep safety.

Do not insert or unplug the SD card when the product is powered on. It may lead to data damage or loss, or even SD card damage when inserting or unplugging SD card during video recording.

Potensic does not bear responsibility for any loss due to user's misoperation of SD card.

5. Remote Control

» 5.1 Overview

DSRC02A remote control is designed exclusively by Potensic for Atom SE based on PixSync 2.0 image transmission technique. It can realize operation and setting of the drone within the max. straight-line distance of 4 km at a flight height of 120m in unblocked environment; besides, it can display the real-time shooting HD image of the drone on the mobile device through the APP.

Based on 2.4G band double high-gain antenna, PixSync 2.0 can ensure smooth transmission of 720P HD pictures in undisturbed and unblocked environment.

With built-in 2,200mAh polymer battery, the remote control can work for approx. 2h maximally. The remote control has one TYPE-C interface for charging and connecting the mobile device; besides, it can recharge the mobile device (5V/500mA).

» 5.2 Control Stick Mode

Mode 1 (Left Hand Throttle)

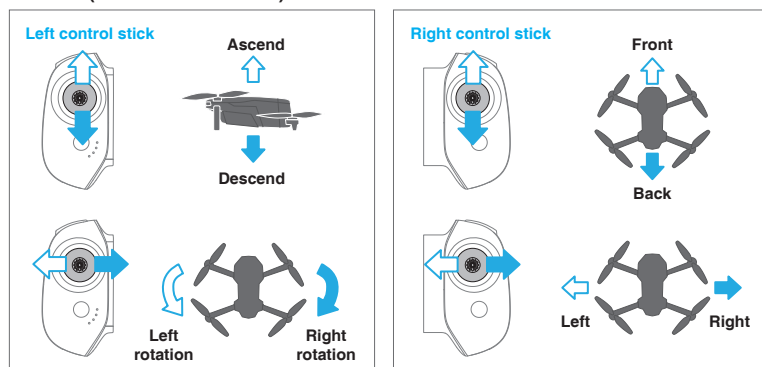

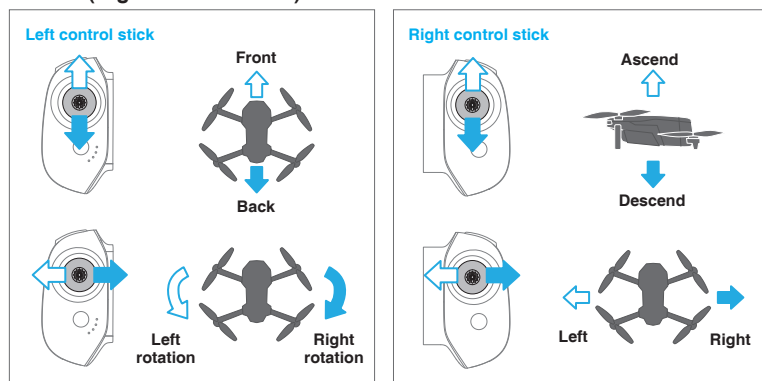

Mode 2 (Right Hand Throttle)



» 5.3 Function Introduction

EN

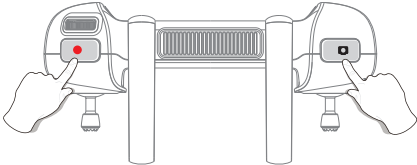
5.3.1 Function List

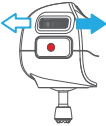
Charge	<ol style="list-style-type: none"> 1. Connect TYPE-C charging port to USB charger. 2. The battery is being charged when power indicator starts flickering. 3. Charging is completed when 4 LED indicators are on and data cable can be removed.
Recharge mobile phone	When a mobile device is connected, it will be recharged automatically by the remote control (5V/500mA)
Indicator function	See 5.3.2
Flight control	See 5.2
Low battery prompt	When electric quantity of the remote control is lower than 10%, the remote control will have long "beep" sound at an interval of 1s.
Auto shutdown	The product will shut down automatically if the remote control has no connection and operation for 20min.
One-key return	See 7.9
Pause	When the drone is under auto flight (such as auto return and circle flight), short press return/pause button to pause the current light, then the drone will hover at the current position; then short press it again to continue with flight.
Emergency stop	<p>For any accident in the flight, press "Shoot" and "Record" button for 2s at the same time and when there's "beep" sound, the product will stop immediately and fall on the ground freely.</p> 
Shoot	<p>Short press it to shoot one picture</p> <p>When camera is in video recording mode, short press it to switch to shoot mode</p> 
Record video	<p>Short press it to start/stop video recording</p> <p>When camera is in shooting mode, short press it to switch to video recording mode</p> 
Camera pitch control	<p>Dial it to the right to increase the pitch angle (head up)</p> <p>Dial it to the left to decrease the pitch angle (head down)</p> 
Remote control frequency pairing	See 5.3.3

5.3.2 Indicator

As shown in the picture below, the remote control is fitted with 4 white LED indicators to indicate the electric quantity and other status.

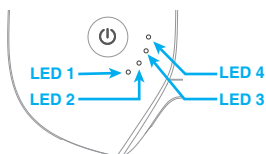

Indicator is normally on

Indicator flickers

Indicator is off

Charging indication

LED 1	LED 2	LED 3	LED 4	Current electric quantity of battery
				0%~25%
				25%~50%
				50%~75%
				75%~99%
				99%~100%

Power indication (in use)

LED 1	LED 2	LED 3	LED 4	Current electric quantity of battery
				0%~10%
				10%~25%
				25%~50%
				50%~75%
				75%~100%

Status indication

	LED 1	LED 2	LED 3	LED 4
Frequency pairing				
	Flickers slowly at the same time			
Upgrade mode				
	Waterflow light			
Start calibration				
	Flickers slowly at the same time			

5.3.3 Remote Control Frequency Pairing

The Atom SE remote control and the drone can be used immediately after startup, for they have passed frequency pairing before leaving factory. Where the remote control or the drone is replaced, make sure to conduct frequency pairing for them as follows prior to use:

Method 1:

1. Shut down the remote control, hold the "Record" and "Power" button at the same time and do not release them until hearing two "beep" sounds; the remote control enters frequency pairing status when power indicators flicker quickly at the same time.
2. After powering on the drone, long press "Power" button and do not release it until the indicator flickers quickly in green; at this time, the drone has entered frequency pairing status.
3. Wait for about 30s, and frequency pairing will succeed when hearing one "beep" sound of the remote control. Connect the mobile device, open the App and the interface will show the image transmission image of the drone.

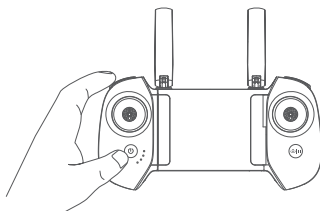

Method 2:



1. Turn on the remote control and connect mobile device, enter APP setting, click "Rematch the drone" to enter the frequency pairing interface.
2. After powering on the drone, long press the "Power" button and do not release it until the drone indicator flickers quickly in green; At this time, the drone has entered frequency pairing status.
3. Wait for about 7s, frequency pairing succeeds when you hear one "beep" sound, the flight interface of APP will show the image transmission image of the drone.

 **Keep the remote control closer to the drone during frequency pairing. Method 2 is recommended to have faster frequency pairing.**

 **If frequency pairing fails, check if there are interferences nearby, or other drones are also in frequency pairing mode, or the remote control is too far away or blocked. Eliminate the problems above and try again.
Do not relocate or handle the remote control and the drone during frequency pairing.**

» 5.4 Antenna Angle

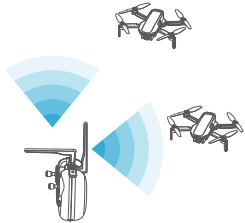
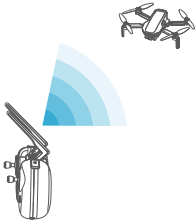
Adjust the antenna angle along with the changes of drone height and distance, to ensure the best communication status of the remote control.

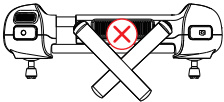
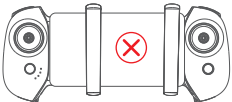
<p>Wider communication angle is ensured at a close distance in this mode.</p> 	<p>Keep two antennas dead against the drone, to acquire the best directivity, i.e. longer operation distance.</p> 	<p>If the drone is right above user, this angle can ensure best communication effect.</p> 
<p>Do not cross the antenna in any case.</p> 	<p>Do not press the antenna on your mobile device in any case.</p> 	

6. PotensicPro APP

» 6.1 APP Homepage



Click it to view the teaching video, instruction, flight record, flight log

Click it to switch the model. Model will be switched automatically if user has connected the remote control

Display connection status



Enter Device >

Click it to enter flight interface



Me: Report the problem, modify account, browse user agreement, close account and find the missing drone.

Photo album in APP (Connect the drone to see the contents in the drone SD card)

Homepage of APP

» 6.2 Flight Interface



1. Return button:

 Click it to return to the homepage



2. Navigation prompt bar:

Display drone status and flight mode

3. Flight mode:

-  Video
-  Normal
-  Sport

4. Head / Headless mode:

-  Head mode
-  Headless mode

9. Set button

Including main controller setting, calibration setting, remote control setting, smart battery information and general setting.

Main controller setting

Beginner mode: New user will enter beginner mode by default. In this mode, speed will be limited at "video" mode, while the height and distance will be restricted within 30m.

It also includes height limit, distance limit, speed setting and circle parameter setting

Calibration setting

User can calibrate the compass and the remote control manually in this interface

Remote control setting

Control stick mode: Mode 1 (Left Hand Throttle), Mode 2 (Right Hand Throttle)

Rematch the drone: Rematch is required after the drone or the remote control is replaced



Smart battery information

User can view the status and health condition of smart battery in this interface

General setting

User can set measurement unit, decoding mode, view device SN code, firmware version and upgrade firmware in this interface

5. Positioning mode:

-  GPS GPS positioning
-  OPTI Visual positioning
-  Atti Attitude mode, no positioning

6. GPS status:

Display GPS signal status and quantity of satellites searched

7. Signal quality of HD image transmission:

 HD Display the strength of image transmission connection signal between the drone and the remote control

8. Electric quantity of smart battery:

 16:47 Predicted Flight Duration

10. Display Shooting Information

In shooting mode, it will display picture size, exposure compensation and remaining shooting number

In video recording mode, it will display display resolution, exposure compensation and remaining video recording time

11. Shoot/record switch button:

to switch from shooting to video recording to switch from video recording to shooting.

12. Shoot/record button:

- Video recording mode, click it to start video recording
- Video recording in progress, click it to cancel
- Shooting mode, press it to shoot picture

13. Shooting setting menu

Shooting mode: Set grid switch, exposure compensation, picture format and SD card formatting.

Video recording mode: Set grid switch, flight data watermark, exposure compensation, video segmentation, video format and SD card formatting.

14. Album:

Preview or download shot videos or pictures in SD card.

15. Display flight speed and distance

Horizontal distance from the drone to takeoff point

Relative height from the drone to takeoff point

Horizontal speed from the drone to takeoff point

Vertical speed from the drone to takeoff point

16. Attitude sphere/thumbnailed map

Click attitude sphere to switch to thumbnail map

Click thumbnail map to switch to full-screen map



17. Smart flight



Smart Mode:

Head/headless mode, One-key lock/unlock, Attitude mode

Smart Flight:

Circle flight, waypoint flight and follow flight

18. One-key takeoff, landing/return

The APP will display different buttons based on drone status. Click the button to realize one-key takeoff, landing and return.

Click it to unlock, take off and hover at a height of 1.2m

Click it for direct fall or auto return.

Make sure to fully recharge the mobile device prior to flight, for the power of mobile device can be consumed even if it is recharged by the remote control.

The cellular mobile data will be consumed when using the APP. Please contact your supplier of mobile device data to know the latest rates of data traffic.

While using the APP, make sure to read and master the pop-up prompts and warning information of APP to know the current status of the drone.

It is recommended to replace the old device, which may affect use experience of APP and lead to hidden dangers. For any poor use experience and safety problem due to the old device, Potensic does not bear any liability.

This chapter introduces the requirements of flight environment, precautions and operation steps of flight.

» 7.1 Requirements of Flight Environment



1. Do not use the product in severe weather, such as gale, rain, snow and fog.
2. Please use the product in open places without high buildings, for the buildings with masses of rebars may affect compass, block GPS signals, lead to poor positioning and even positioning failure of the drone.
3. Control the product within your sight and keep away from the obstacles and crowds.
4. Do not use the product in places with high-voltage power lines, telecommunication base station or launching tower, to avoid interference of the remote control.
5. Please use the product with caution when altitude is over 3,000m for the flight performance can be affected when the performance of drone battery and power system is weakened due to environment factor.

» 7.2 Precautions of Flight

1. Check if the remote control, intelligent flight battery and mobile device are fully recharged.
2. Check if the drone is intact and propellers are installed correctly.
3. Check if the camera is working normally after power-on.
4. Check if APP is running normally.
5. Check if SD card is inserted and make sure camera is clean.
6. Make sure the drone takes off on flat and hard surface, instead of sandstone or bush; the drone may fail to be unlocked if it has major vibration.
7. Please be careful when the drone takes off on surface of moving objects, such as running vehicle and ship.
8. GPS positioning and waypoint flight will be disabled in the south and north polar.
9. Do not use the product in extreme cold or hot place to avoid hazards.

» 7.3 Connection

Please follow the steps below:

1. Please finish the steps in "3.5 Preparation of remote control" and turn on the remote control.
2. Please finish the steps in "3.4 Preparation of the drone" and turn on the remote control.
3. Open APP to view the connection status. Connection is finished when it shows .
4. Click  to enter the flight interface.

 It is suggested to click

 In the first use and follow the guidance of animation

» 7.4 Flight Mode

Atom SE supports video, normal and sport mode, which can be switched in APP.

Video

Ascending: 2m/s, descending: 1.5m/s, horizontal movement: 8m/s

The system will enter beginner mode by default when using the drone for the first time, and the flight mode will be limited at beginner mode.

Normal

Ascending: 4m/s, descending: 3m/s, horizontal movement: 12m/s

The beginner mode can be quit after the flight operation is mastered, and the normal mode will be entered by default. This is the common mode.

Sport

Ascending: 5m/s, descending: 4m/s, horizontal movement: 16m/s

Video mode is recommended in aerial photography. Sport mode can be used to enjoy better flight experience; please use this mode with caution, for the drone may have the max. maneuvering.

 Please reserve enough brake distance to avoid hazards, for the brake distance can be increased due to high flight speed of the drone at sport mode.

» 7.5 Compass Calibration

7.5.1 Scenarios Requiring Compass Calibration

1. Compass calibration is required before the first flight.
2. The flight distance is over 50km from the previous calibration location.

 **Avoid calibration near high-intensity magnetic field or big metal, such as metallic mineral deposit, parking lot, large reinforced concrete buildings and high-voltage cables. Keep away from other electronic products during calibration.**

Keep the the drone height over 1m during calibration.

No calibration is required during indoor flight.

7.5.2 Steps of Calibration

1. When calibration is required, the APP will pop up calibration interface automatically, click "Start calibration" and the tail indicator will have alternative flickering of red and green.
2. Rotate the drone horizontally for 2~3 circles, when it succeeds, the interface will become vertical calibration and the tail indicator will have alternative flickering of blue and green.
3. Keep the drone head upwards, rotate it horizontally for 2~3 circles, until the calibration interface prompts calibration completion.

User can also trigger compass calibration manually in APP setting.

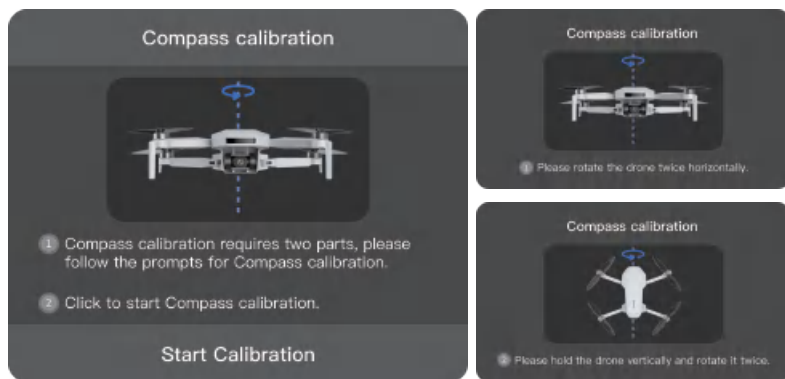

 **If compass calibration fails, the APP will remind user to replace the calibration location. Please pay attention to the instructions of magnetic field environment in calibration interface.**

 **Do not calibrate compass while arms are folded.**

» 7.6 Beginner Mode

The beginner mode will be entered when using the drone for the first time. In this mode:

1. The flight distance and height will be restricted at: 0~30m
2. The speed level will be restricted at Video mode
3. The beginners are suggested to learn and master the drone in beginner mode

» 7.7 Takeoff/Landing/Hovering

7.7.1 Manual Takeoff/Landing

Takeoff

Step 1: Unlock motor (America Sign Language/Mode 1)

Pull the control stick for about 1s as shown in the right picture, release the control stick when motor enters idle speed.

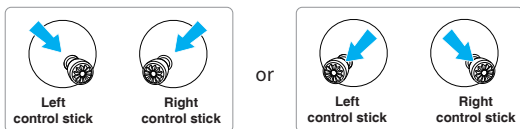

Step 2: Push throttle control stick for takeoff (America Sign Language/Mode 1)

Push the throttle control stick upwards slowly as shown in the right picture, release the control stick when the drone leaves ground and the drone will maintain hovering.



Landing

Pull down the throttle control stick, until the drone is landed on ground. When motor is locked automatically, release the control stick to finish landing.

⚠ It is not suggested to take off at low battery, for it may affect the battery service life. Please handle it with caution and undertake the corresponding consequences if compulsory takeoff is required.

Keep the distance over 0.5m between the drone and ground, for it may fail to enter good hovering status due to air flow when it is close to the ground.

If the drone fails to be locked after landing due to anomaly, pull down the throttle control stick to the limit position for 3s and the drone will be locked by force.

7.7.2 One-key Takeoff / Landing

One-key takeoff

Click one-key take-off button  in App, then slip to the right in pop-up window to unlock the drone automatically, ascend to the height of 1.2m and maintain hovering.

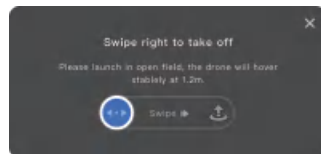

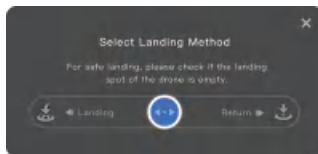

One-key landing

Click one-key landing button  in App, then slip to the left in pop-up window to have direct landing, or slip to the right to start returning.







» 7.8 Smart Flight

7.8.1 Headless Mode

Function description	Drone head direction is not considered in headless mode, pull the pitch control stick to make the drone leave or approach the HOME point; pull the roll control stick to make the drone have clockwise or anticlockwise circle flight along with HOME point; the functions of throttle control stick and yaw control stick are not changed.
Switch mode	When GPS signals are normal and horizontal flight distance is over 3m, click  in App.  Head mode  Headless mode



7.8.2 Circle Flight

Function description	Start circle flight, the drone will fly forwards by taking the current position as circle center until it reaches the starting point of circle flight; When user clicks  in APP, the drone will fly around the circle at a set speed and direction.
Adjustable parameter	User can set the flight radius, speed and direction of circle flight in setting menu.
How to start	When GPS signal is normal and flight height is $\geq 5\text{m}$, click  and select  in APP.
How to cancel	1. Quit flight automatically after finish circle flight. 2. In process of circle flight, click the left  button of APP to quit flight.

 When circle flight is enabled, the drone will ascend to 5m automatically if its height is less than 5m.

 Make sure there's no obstacle in the radius of circle flight and use the product with caution, for the drone does not support obstacle avoidance function.

7.8.3 Follow Me Flight





Function description	Once follow me flight is enabled, the drone will follow User's mobile device at the current distance; The flight height and yaw can be adjusted during follow me flight.
How to start	When GPS signal is normal and horizontal flight distance is 5-50m, click  and select  in APP.
How to cancel	Click the left  of APP to quit follow me flight.

 When follow me flight is enabled, the drone will ascend to 5m automatically if its height is less than 5m.

The follow accuracy depends on the quality of the drone GPS signal and positioning accuracy of user's mobile device.

 The follow me flight depends on the positioning of user's mobile device. The positioning authority of APP is required, or this function is disabled.

7.8.4 Waypoint Flight



Function description	When waypoint flight function is enabled, User can freely set 1 or multiple waypoint coordinates in APP map, and the drone will fly over the corresponding coordinates according to the sequence of set waypoint coordinates.
How to start	<p>When GPS signal is normal, click  and choose  in App, then click point in map and set it as waypoint, then click  to start waypoint flight.</p> <p>User can set 1-30 waypoints freely; The figure in waypoint icon indicates the flight sequence. Meanwhile, User can delete certain waypoint, save the data of current waypoint, or call the saved waypoints.</p> 
How to cancel	Click the left  of APP to quit waypoint flight.

» 7.9 Auto Return

The Atom SE drone supports auto return function, which is divided into one-key return, low-power return, communication-loss return and return in case of other anomalies.

Return condition: The drone takes off at GPS positioning mode and records HOME point successfully. Enable return when GPS signal is good, the drone will return to HOME point automatically from the current position and fall.

HOME point: When the drone takes off, the APP prompts "Waypoint is refreshed" and the GPS coordinate of the drone is the HOME point.

One key return	Start	Method 1: Press return/pause button of the remote control for 1s and one-key return will be triggered when you hear two "beep" sounds. Method 2: Click  in APP to pop up the menu, then slip to the right to start return (see 7.7.2).
	Cancel	Method 1: Press return/pause button of the remote control for 1s and one-key return is canceled when you hear two "beep" sounds. Method 2: Click the left  of APP to quit One key return. Method 3: In process of return, pull the pitch control stick backwards to the limit position.
Low power return	Start	The drone will determine whether start low power return automatically according to the factors, such as flight distance, height and residual electric quantity.
	Cancel	It cannot be canceled.
Communication loss return	Start	Communication loss return will be enabled automatically when the drone has lost communication with the remote control.
	Cancel	It cannot be canceled in the process of communication loss. It can be cancelled when the remote control is reconnected in the same method of one-key return.
Auto return in case of other anomalies	Start	When GPS signal is normal, auto return will be enabled when smart battery or other sensors have anomaly. Please pay attention to APP prompts.
	Cancel	It cannot be canceled.

 The default height of return is 30m. The drone will ascend to 30m automatically and then start return if the drone height is less than 30m in return, or the drone will start return immediately when its height is over 30m. In process of return, User can also adjust the flight height through the throttle control stick.

When the drone starts return at a distance within 20m from HOME point, it will fly to the HOME point at the current height and then fall. Please pay attention to safety.

 Please pay attention to return safety, for Atom SE does not support obstacle avoidance function and may crash when colliding with obstacles in return process.

For any GPS signal anomaly in communication loss return, the drone will maintain hovering at attitude mode, until GPS signal becomes normal and return is continued.

» 7.10 Emergency Stop

See 5.3.1 Emergency stop for the detailed operation method.

 Emergency stop function is designed for preventing injuring pedestrians or damaging the valuables by propeller blades in case of drone failure. Please use it with caution, for the drone may be damaged after falling.

8. Appendix

» 8.1 Specification & Parameters

Drone

Takeoff weight: < 249 g (the takeoff weight includes battery and propeller blades)

Fold size: 88x143x58 mm

Unfold size (propeller blades included): 300x242x58 mm

Unfold size (propeller blades excluded): 210x152x58 mm

Diagonal wheel base: 219 mm

Max. flight speed (sport mode): Ascending: 5m/s;

Descending: 4 m/s; Horizontal flight: 16 m/s

Max. flight period: 31 min (measured at breezeless condition and even speed of 5m/s)

Ambient temperature: 0 °C ~ 40 °C

Satellite positioning system: GPS + GLONASS

Working frequency: 2.400 ~ 2.4835 GHz

Transmission power: 2.4 GHz: < 24 dBm

Hovering accuracy: Vertical: ± 0.1 m (when visual positioning is running normally), ± 0.5 m (while GPS positioning is running normally)

Horizontal flight: ± 0.3 m (when visual positioning is running normally), ± 1.5 m (while GPS positioning is running normally)

Low visual system

Height range of precise hovering: 0.3 ~ 5m (ideal condition) effective height: 0.3 ~ 30m

Unavailable scenarios of visual positioning:

1. Pure-color surface
2. Surface with strong reflection, such as smooth metal surface
3. Transparent object surface, such as water surface and glass
4. Moving texture, such as running pets
5. Scenarios with drastic change of light; for example, the drone flies to outdoor space with strong light from indoor space
6. The places with weak or strong light
7. The surface with highly repetitive texture, such as floor tile with the same texture and small size
8. The highly consistent strip pattern

Camera

Lens rotation range: $+20^{\circ}$ ~ -90°

CMOS: 1/3"

Effective pixel: 1,300 W

ISO range: 100 ~ 6400

Electronic shutter speed: 1/30 s ~ 1/25000 s

FOV: 118°

Aperture: F2.2

Photo resolution: 4,608*2,592

Image format: JPG/JPG+RAW(DNG)

Video resolution: 4K @ 30fps; 2.7K @ 30fps; 1,080P @ 60fps; 1,080P @ 30fps;

Video format: MP4 (H.264)

Max. code stream of video storage: 40 Mbps

Supported file system: FAT 32

Type of supported storage card: Micro SD card; 4 ~ 256GB

SD card transmission speed \geq class10 or U1 standard

Remote control

Working frequency: 2.402 ~ 2.483 GHz

Max. effective distance of signal: 4 KM (undisturbed and unblocked)

Working temperature: 0 °C ~ 40 °C

Battery: 2,200 mAh, lithium battery, 1 S

EIRP (equivalent isotropic radiated power): 2.4 GHz: ≤ 20 dBm

Charging interface: TYPE-C

Charging specification: 5 V/1 A

Image transmission plan: PixSync 2.0

Image transmission quality: 720 P

Image transmission delay: 200 ms

Smart flight battery

Model: DSBT02A

Capacity: 2,500 mAh

Voltage: 7.2 V

Battery type: Li-ion 2S

Energy: 18 Wh

Battery weight: 103 g

Working temperature: 0 °C ~ 40 °C



WARNING

**DANGER**Only suitable
for age 14+

Warning: The product should only be used by adults and children over 14 years. Adult supervision is required for children under 14 years.

Hinweis: Dieses Produkt ist für die Erwachsene und die Kinder ab 14 Jahren. Die Kinder unter 14 Jahren müssen von Erwachsenen beaufsichtigt werden.

Avertissement: Ce produit est destiné aux adultes et aux enfants de plus de 14 ans. Les enfants de moins de 14 ans doivent être surveillés par des adultes.

Avvertimento: Questo prodotto è destinato all'uso per i adulti e bambini di età superiore ai 14 anni. I bambini di età inferiore ai 14 anni devono essere sorvegliati da un adulto.

Advertencia: Este producto es para adultos y niños mayores de 14 años. Los niños menores de 14 años deben ser supervisados por adultos.

警告: この製品は、大人と14歳以上の子供には使用対象です。14歳未満の子供は大人の監視が必要です。



صنعت وفقاً للمواصفات والمعايير العالمية

Tested according to international standards**WARNING:**NOT SUITABLE FOR
CHILDREN UNDER 3 YEARS
DUE TO SMALL PARTS

هشدار برای کودکان زیر ۳ سال

مناسب نیست، دارای قطعات کوچک است

تذکره: غیر مناسب برای کودکان تحت ۳ (۳) سال به سبب

قطعات کوچک

COUNTRY OF ORIGIN: CHINA

بلد المنشأ: الصين

**WARNING:****CHOKING HAZARD—Small parts.**
Not for children under 3 years.**Drone FCC ID: 2AYUO-DSDR04B****Remote control FCC ID: 2AYUO-DSRC02A**

Changes or modifications not expressly approved by the party responsible for compliance could void the user's authority to operate the equipment.

This device complies with Part 15 of the FCC Rules. Operation is subject to the following two conditions:

- (1) This device may not cause harmful interference, and
- (2) This device must accept any interference received, including interference that may cause undesired operation.

Note: This equipment has been tested and found to comply with the limits for a Class B digital device, pursuant to Part 15 of the FCC Rules. These limits are designed to provide reasonable protection against harmful interference in a residential installation. This equipment generates, uses, and can radiate radio frequency energy, and if not installed and used in accordance with the instructions, may cause harmful interference to radio communications. However, there is no guarantee that interference will not occur in a particular installation. If this equipment does cause harmful interference to radio or television reception, which can be determined by turning the equipment off and on, the user is encouraged to try to correct the interference by one or more of the following measures:

- Reorient or relocate the receiving antenna.
- Increase the separation between the equipment and receiver.
- Connect the equipment into an outlet on a circuit different from that to which the receiver is connected.
- Consult the dealer or an experienced radio/TV technician for help.

Remote control : SAR Max. Values:0.304 W/Kg (10g) for body-worn device.

The back of the device kept 0mm from the body.

Manufacturer: Shenzhen Deepsea Excellence Technology Co., Ltd.

Address: 5th Floor, Building 7, Hongfa High-tech Park, Keji 4th Road, Shiyan Street, Baoan District, Shenzhen

EC REP: E-CrossStu GmbH. Mainzer Landstr.69,60329 Frankfurt am Main

UK REP: DST Co.,Ltd. Fifth Floor 3 Gower Street, London, WC1E 6HA, UK



R 214-113197



V1.0 2022.11

MADE IN CHINA