



**CFR 47 FCC PART 15 SUBPART E
ISED RSS-247 ISSUE 2**

CERTIFICATION TEST REPORT

For

**IEEE 802.11a/b/g/n 2T2R USB Wi-Fi Module
Integrated Bluetooth 2.1+EDR/4.2/5.0**

MODEL NUMBER: SKI.WB7638U.1_MT7638BUB

FCC ID: 2AR82-SKIWB7638U2

IC: 24728-SKIWB7638U2

REPORT NUMBER: 4789787344.1-4

ISSUE DATE: January 21, 2021

Prepared for

**Guangzhou Shikun Electronics Co., Ltd
NO.6 Liankun Road,Huangpu District,Guangzhou,China**

Prepared by

UL Verification Services (Guangzhou) Co., Ltd, Song Shan Lake Branch

Building 10, Innovation Technology Park, No. 1, Li Bin Road, Song Shan Lake Hi-Tech Development Zone Dongguan, 523808, People's Republic of China

Tel: +86 769 22038881

Fax: +86 769 33244054

Website: www.ul.com



Revision History

Rev.	Issue Date	Revisions	Revised By
V0	01/21/2021	Initial Issue	

Note: This is a spot check report base on FCC ID report SEDL2001042 (ISED report SEDM2001042) which is issued by CERPASS TECHNOLOGY (SUZHOU) CO., LTD on January 03, 2020. The module SKI.WB7638U.1_MT7638BU had already applied for the single module and the FCC ID is 2AR82-SKIWB7638U1 (IC: 24728-SKIWB7638U1), the new module SKI.WB7638U.1_MT7638BUB is identical with SKI.WB7638U.1_MT7638BU except adding Bluetooth function (Bluetooth function was shielded for SKI.WB7638U.1_MT7638BU), according to general guidance of KDB KDB484596 D01 (please refer to clause 1. a) b) c)), we used all the original WiFi test data to apply the new FCC ID for SKI.WB7638U.1_MT7638BUB, but added the conducted output power and radiated spurious emission as spot check in this report to demonstrate that the referenced test data remains valid for the new device. For other data, please refer to the original report.

The applicant takes full responsibility that the test data referenced below represents compliance for this FCC ID.

Parent Model: SKI.WB7638U.1_MT7638BU
FCC ID: 2AR82-SKIWB7638U1, IC: 24728-SKIWB7638U1

Variant Model: SKI.WB7638U.1_MT7638BUB
FCC ID: 2AR82-SKIWB7638U2, IC: 24728-SKIWB7638U2

Reference Details

Equipment Class	Application Type	Reference Test Report Number	Exhibit Type	Spot Check Report Number	Data Re-used	FCC / ISED
DTS	Original Grant	SEFI2001042	Test Report	4789787344.1-3	All	FCC
	Original Grant	SEDL2001042	Test Report	4789787344.1-3	All	ISED
NII	Original Grant	SEDL2001042	Test Report	4789787344.1-4	All	FCC
	Original Grant	SEDM2001042	Test Report	4789787344.1-4	All	ISED



Summary of Test Results			
Clause	Test Items	FCC/IC Rules	Test Results
1	Conducted Output Power	FCC 15.407 (a) RSS-247 Clause 6.2	PASS
2	Radiated Bandedge and Spurious Emission Spot Check	FCC 15.407 (b) FCC 15.209 FCC 15.205 RSS-247 Clause 6.2 RSS-GEN Clause 8.9	PASS
3	Antenna Requirement	FCC 15.203 RSS-GEN Clause 6.8	PASS
<p>Note:</p> <p>1. This test report is only published to and used by the applicant, and it is not for evidence purpose in China.</p> <p>2. The measurement result for the sample received is <Pass> according to < CFR 47 FCC PART 15 SUBPART C >> ISED RSS-247 > when <Accuracy Method> decision rule is applied.</p>			



TABLE OF CONTENTS

1. ATTESTATION OF TEST RESULTS	5
2. TEST METHODOLOGY	6
3. FACILITIES AND ACCREDITATION	6
4. CALIBRATION AND UNCERTAINTY	7
4.1. <i>MEASURING INSTRUMENT CALIBRATION</i>	<i>7</i>
4.2. <i>MEASUREMENT UNCERTAINTY.....</i>	<i>7</i>
5. EQUIPMENT UNDER TEST	8
5.1. <i>DESCRIPTION OF EUT</i>	<i>8</i>
5.2. <i>CHANNEL LIST</i>	<i>9</i>
5.3. <i>DESCRIPTION OF AVAILABLE ANTENNAS</i>	<i>10</i>
5.4. <i>DESCRIPTION OF TEST SETUP.....</i>	<i>11</i>
6. MEASURING INSTRUMENT AND SOFTWARE USED	12
7. ANTENNA PORT TEST RESULTS.....	14
7.1. <i>CONDUCTED OUTPUT POWER.....</i>	<i>14</i>
8. RADIATED TEST RESULTS.....	19
8.1. <i>SPOT CHECK SUMMERY</i>	<i>26</i>
8.2. <i>SPURIOUS EMISSIONS (1 GHz ~ 7 GHz).....</i>	<i>27</i>
8.2.1. <i>802.11a MODE AND BT MODE WORST CASE</i>	<i>27</i>
8.3. <i>SPURIOUS EMISSIONS (7 GHz ~ 18 GHz).....</i>	<i>29</i>
8.3.1. <i>802.11a MODE AND BT MODE WORST CASE</i>	<i>29</i>
8.4. <i>SPURIOUS EMISSIONS (18 GHz ~ 26 GHz).....</i>	<i>31</i>
8.4.1. <i>802.11a MODE AND BT MODE WORST CASE</i>	<i>31</i>
8.5. <i>SPURIOUS EMISSIONS (26 GHz ~ 40 GHz).....</i>	<i>33</i>
8.5.1. <i>802.11a MODE AND BT MODE WORST CASE</i>	<i>33</i>
8.6. <i>SPURIOUS EMISSIONS (30 MHz ~ 1 GHz).....</i>	<i>35</i>
8.6.1. <i>802.11a MODE AND BT MODE WORST CASE</i>	<i>35</i>
8.7. <i>SPURIOUS EMISSIONS BELOW 30 MHz</i>	<i>37</i>
8.7.1. <i>802.11a MODE AND BT MODE WORST CASE</i>	<i>37</i>
9. ANTENNA REQUIREMENTS.....	40



1. ATTESTATION OF TEST RESULTS

Applicant Information

Company Name: Guangzhou Shikun Electronics Co., Ltd
 Address: NO.6 Liankun Road,Huangpu District,Guangzhou,China

Manufacturer Information

Company Name: Guangzhou Shikun Electronics Co., Ltd
 Address: NO.6 Liankun Road,Huangpu District,Guangzhou,China

EUT Information

EUT Name: IEEE 802.11a/b/g/n 2T2R USB Wi-Fi Module
 Integrated Bluetooth 2.1+EDR/4.2/5.0
 Model: SKI.WB7638U.1_MT7638BUB
 Brand: /
 Serial Model: /
 Sample Received Date: January 7, 2021
 Sample Status: Normal
 Sample ID: 3576248
 Date of Tested: January 11, 2021 ~ January 21, 2021

APPLICABLE STANDARDS	
STANDARD	TEST RESULTS
CFR 47 FCC PART 15 SUBPART E	PASS
ISED RSS-247 Issue 2	PASS
ISED RSS-GEN Issue 5	PASS

Prepared By:

Denny Huang
 Project Engineer
 Approved By:

Stephen Guo
 Laboratory Manager

Checked By:

Shawn Wen
 Laboratory Leader



2. TEST METHODOLOGY

The tests documented in this report were performed in accordance with ANSI C63.10-2013, CFR 47 FCC Part 2, CFR 47 FCC Part 15, KDB 789033 D02 v02r01, RSS-GEN Issue 5, RSS-247 Issue 2, KDB414788 D01 Radiated Test Site v01, KDB 662911 D01 Multiple Transmitter Output v02r01, KDB484596 D01 Referencing Test Data v01.

3. FACILITIES AND ACCREDITATION

Accreditation Certificate	<p>A2LA (Certificate No.: 4102.01) UL Verification Services (Guangzhou) Co., Ltd. Song Shan Lake Branch. has been assessed and proved to be in compliance with A2LA.</p> <p>FCC (FCC Designation No.: CN1187) UL Verification Services (Guangzhou) Co., Ltd. Song Shan Lake Branch. Has been recognized to perform compliance testing on equipment subject to the Commission's Declaration of Conformity (DoC) and Certification rules</p> <p>ISED (Company No.: 21320) UL Verification Services (Guangzhou) Co., Ltd. Song Shan Lake Branch. has been registered and fully described in a report filed with ISED. The Company Number is 21320 and the test lab Conformity Assessment Body Identifier (CABID) is CN0046.</p> <p>VCCI (Registration No.: G-20019, R-20004, C-20012 and T-20011) UL Verification Services (Guangzhou) Co., Ltd. Song Shan Lake Branch. has been assessed and proved to be in compliance with VCCI, the Membership No. is 3793. Facility Name: Chamber D, the VCCI registration No. is G-20019 and R-20004 Shielding Room B , the VCCI registration No. is C-20012 and T-20011</p>
---------------------------	---

Note 1: All tests measurement facilities use to collect the measurement data are located at Building 10, Innovation Technology Park, Song Shan Lake Hi tech Development Zone, Dongguan, 523808, China

Note 2: The test anechoic chamber in UL Verification Services (Guangzhou) Co., Ltd. Song Shan Lake Branch had been calibrated and compared to the open field sites and the test anechoic chamber is shown to be equivalent to or worst case from the open field site.

Note 3: For below 30 MHz, lab had performed measurements at test anechoic chamber and comparing to measurements obtained on an open field site. And these measurements below 30 MHz had been correlated to measurements performed on an OFS.



4. CALIBRATION AND UNCERTAINTY

4.1. MEASURING INSTRUMENT CALIBRATION

The measuring equipment utilized to perform the tests documented in this report has been calibrated in accordance with the manufacturer's recommendations and is traceable to recognize national standards.

4.2. MEASUREMENT UNCERTAINTY

Where relevant, the following measurement uncertainty levels have been estimated for tests performed on the apparatus:

Test Item	Uncertainty
Conduction emission	3.62 dB
Radiated Emission (Included Fundamental Emission) (9 kHz ~ 30 MHz)	2.2 dB
Radiated Emission (Included Fundamental Emission) (30 MHz ~ 1 GHz)	4.00 dB
Radiated Emission (Included Fundamental Emission) (1 GHz to 26 GHz)	5.78 dB (1 GHz ~ 18 GHz)
	5.23 dB (18 GHz ~ 26 GHz)
Duty Cycle	±0.028%
Emission Bandwidth and 99% Occupied Bandwidth	±0.0196%
Maximum Conducted Output Power	±0.766 dB
Maximum Power Spectral Density Level	±1.22 dB
Frequency Stability	±2.76%
Conducted Band-edge Compliance	±1.328 dB
Conducted Unwanted Emissions In Non-restricted Frequency Bands	±0.746 dB (9 kHz ~ 1 GHz)
	±1.328dB (1 GHz ~ 26 GHz)
Note: This uncertainty represents an expanded uncertainty expressed at approximately the 95% confidence level using a coverage factor of k=2.	



5. EQUIPMENT UNDER TEST

5.1. DESCRIPTION OF EUT

EUT Name	IEEE 802.11a/b/g/n 2T2R USB Wi-Fi Module Integrated Bluetooth 2.1+EDR/4.2/5.0
Model	SKI.WB7638U.1_MT7638BUB
Radio Technology	WLAN (IEEE 802.11a/n HT20/n HT40)
Operation frequency	UNII-1: 5150 ~ 5250 MHz UNII-2A: 5250 ~ 5350 MHz UNII-2C: 5470 ~ 5725 MHz UNII-3: 5725 ~ 5850 MHz
Modulation	IEEE 802.11a: OFDM (64QAM, 16QAM, QPSK, BPSK) IEEE 802.11n HT20: OFDM (64QAM, 16QAM, QPSK, BPSK) IEEE 802.11n HT40: OFDM (64QAM, 16QAM, QPSK, BPSK)
Ratings	DC 3.3 V

**5.2. CHANNEL LIST**

UNII-1 (For Bandwidth = 20 MHz)		UNII-1 (For Bandwidth = 40 MHz)	
Channel	Frequency (MHz)	Channel	Frequency (MHz)
36	5180	38	5190
40	5200	46	5230
44	5220		
48	5240		

UNII-2A (For Bandwidth = 20 MHz)		UNII-2A (For Bandwidth = 40 MHz)	
Channel	Frequency (MHz)	Channel	Frequency (MHz)
52	5260	54	5270
56	5280	62	5310
60	5300		
64	5320		

UNII-2C (For Bandwidth = 20 MHz)		UNII-2C (For Bandwidth = 40 MHz)	
Channel	Frequency (MHz)	Channel	Frequency (MHz)
100	5500	102	5510
104	5520	110	5550
108	5540	118	5590
112	5560	126	5630
116	5580	134	5670
120	5600	/	/
124	5620		
128	5640		
132	5660		
136	5680		
140	5700		

UNII-3 (For Bandwidth = 20 MHz)		UNII-3 (For Bandwidth = 40 MHz)	
Channel	Frequency (MHz)	Channel	Frequency (MHz)
149	5745	151	5755
153	5765	159	5795
157	5785		
161	5805		
165	5825		

Note: All channels in the 5600-5650MHz band was not operational in Canada.

5.3. DESCRIPTION OF AVAILABLE ANTENNAS

Antenna	Frequency Band	Antenna Type	Maximum Antenna Gain
			(dBi)
0	UNII-1	PIFA	1.5
1	UNII-1	PIFA	1.5
0	UNII-2A	PIFA	1.5
1	UNII-2A	PIFA	1.5
0	UNII-2C	PIFA	1.5
1	UNII-2C	PIFA	1.5
0	UNII-3	PIFA	1.5
1	UNII-3	PIFA	1.5

IEEE Std. 802.11	Transmit and Receive Mode	Description
a	☒2TX, 2RX	ANT 1, 2 can be used as transmitting/receiving antenna.
n HT20	☒2TX, 2RX	ANT 1, 2 can be used as transmitting/receiving antenna.
n HT40	☒2TX, 2RX	ANT 1, 2 can be used as transmitting/receiving antenna.

Note: 1. Only 802.11n HT20/HT40 support MIMO mode.
2. BT & 2.4 GHz WLAN, BT & 5 GHz WLAN can transmit simultaneously. (Declared by customer.)

Note: The value of the antenna gain was declared by customer.

5.4. DESCRIPTION OF TEST SETUP

SUPPORT EQUIPMENT

Item	Equipment	Brand Name	Model Name	Remarks
1	laptop	Dell	Vostro 3902	/
2	Test fixture	/	/	/
3	Switching Adapter	FLYPOWER	PS65IBCAY5000H	Input: AC 100-240 V, 50/60 Hz, 1.5A Output: DC 12.0 V, 5000 mA

I/O CABLES

Cable No	Port	Connector Type	Cable Type	Cable Length(m)	Remarks
1	USB	USB	Unshielded	1	/

ACCESSORIES

Item	Accessory	Brand Name	Model Name	Description
/	/	/	/	/

TEST SETUP

The EUT can work in engineering mode with a software through a Laptop.

SETUP DIAGRAM FOR TESTS

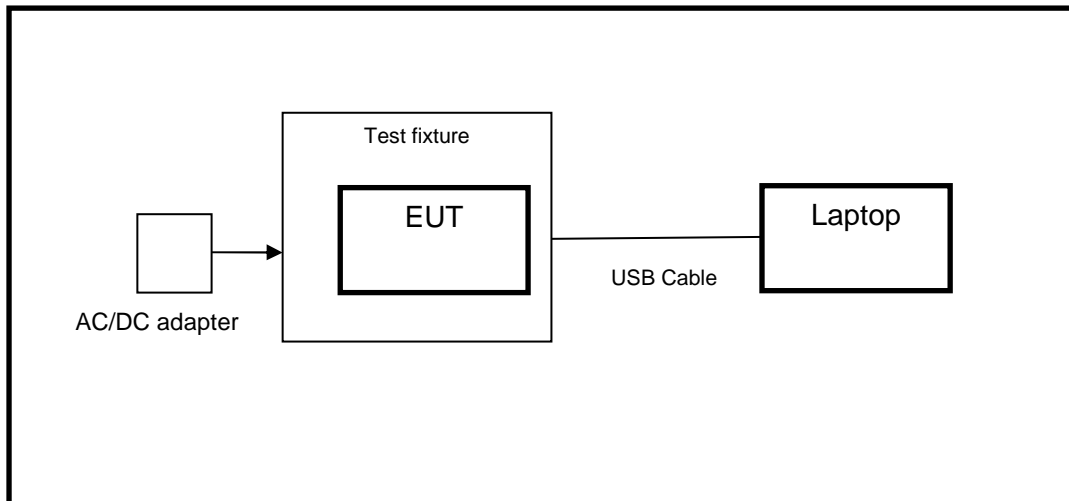

**6. MEASURING INSTRUMENT AND SOFTWARE USED**

Radiated Emissions					
Equipment	Manufacturer	Model No.	Serial No.	Last Cal.	Due Date
MXE EMI Receiver	KESIGHT	N9038A	MY56400036	Nov. 12, 2020	Nov. 11, 2021
Hybrid Log Periodic Antenna	TDK	HLP-3003C	130960	Aug. 11, 2018	Aug. 10, 2021
Preamplifier	HP	8447D	2944A09099	Nov. 12, 2020	Nov. 11, 2021
EMI Measurement Receiver	R&S	ESR26	101377	Nov. 12, 2020	Nov. 11, 2021
Horn Antenna	TDK	HRN-0118	130939	Sept. 17, 2018	Sept. 17, 2021
Preamplifier	TDK	PA-02-0118	TRS-305-00067	Nov. 20, 2020	Nov. 19, 2021
Horn Antenna	Schwarzbeck	BBHA9170	#691	Aug. 11, 2018	Aug. 11, 2021
Preamplifier	TDK	PA-02-2	TRS-307-00003	Nov. 12, 2020	Nov. 11, 2021
Preamplifier	TDK	PA-02-3	TRS-308-00002	Nov. 12, 2020	Nov. 11, 2021
Loop antenna	Schwarzbeck	1519B	00008	Jan.17, 2019	Jan.17,2022
Preamplifier	TDK	PA-02-001-3000	TRS-302-00050	Nov. 12, 2020	Nov. 11, 2021
Preamplifier	Mini-Circuits	ZX60-83LN-S+	SUP01201941	Nov. 20, 2020	Nov. 19, 2021
Highpass Filter	Wainwright	WHKX10-5850-6500-1800-40SS	4	Nov. 12, 2020	Nov. 11, 2021
Band Reject Filter	Wainwright	WRCJV12-5695-5725-5850-5880-40SS	4	Nov. 12, 2020	Nov. 11, 2021
Band Reject Filter	Wainwright	WRCJV20-5120-5150-5350-5380-60SS	2	Nov. 12, 2020	Nov. 11, 2021
Band Reject Filter	Wainwright	WRCJV20-5440-5470-5725-5755-60SS	1	Nov. 12, 2020	Nov. 11, 2021
Software					
Description			Manufacturer	Name	Version
Test Software for Radiated Emissions			Farad	EZ-EMC	Ver. UL-3A1



Other Instruments					
Equipment	Manufacturer	Model No.	Serial No.	Last Cal.	Next Cal.
Dual Channel Power Meter	Keysight	N1912A	MY55416024	Nov. 20, 2020	Nov. 19, 2021
Power Sensor	Keysight	USB Wideband Power Sensor	MY5100022	Nov. 20, 2020	Nov. 19, 2021



7. ANTENNA PORT TEST RESULTS

7.1. CONDUCTED OUTPUT POWER

LIMITS

CFR 47 FCC Part15, Subpart E		
Test Item	Limit	Frequency Range (MHz)
Conducted Output Power	<input type="checkbox"/> Outdoor Access Point: 1 W (30 dBm) <input type="checkbox"/> Indoor Access Point: 1 W (30 dBm) <input type="checkbox"/> Fixed Point-To-Point Access Points: 1 W (30 dBm) <input checked="" type="checkbox"/> Client Devices: 250 mW (24 dBm)	5150 ~ 5250
	Shall not exceed the lesser of 250 mW (24dBm) or 11 dBm + 10 log B, where B is the 26 dB emission bandwidth in megahertz.	5250 ~ 5350 5470 ~ 5725
	Shall not exceed 1 Watt (30 dBm).	5725 ~ 5850

ISED RSS-247 ISSUE 2		
Test Item	Limit	Frequency Range (MHz)
Conducted Output Power or e.i.r.p.	The maximum e.i.r.p. shall not exceed 200 mW (23 dBm) or 10 + 10 log ₁₀ B, dBm, whichever power is less. B is the 99 % emission bandwidth in megahertz.	5150 ~ 5250
	a. The maximum conducted output power shall not exceed 250 mW (24 dBm) or 11 + 10 log ₁₀ B dBm, whichever is less. b. The maximum e.i.r.p. shall not exceed 1.0 W (30 dBm) or 17 + 10 log ₁₀ B dBm, whichever is less. B is the 99 % emission bandwidth in megahertz. Note that devices with a maximum e.i.r.p. greater than 500 mW shall implement TPC in order to have the capability to operate at least 6 dB below the maximum permitted e.i.r.p. of 1 W.	5250 ~ 5350 5470 ~ 5600 5650 ~ 5725
	Shall not exceed 1 Watt (30 dBm). The e.i.r.p. shall not exceed 4 W	5725 ~ 5850

Note:

The above limits are based upon the maximum antenna gain does not exceed 6 dBi.
If transmitting antennas of directional gain greater than 6 dBi are used, the maximum conducted output power shall be reduced by the amount in dB that the directional gain of the antenna exceeds 6 dBi.

TEST PROCEDURE

Refer to KDB 789033 D02 General U-NII Test Procedures New Rules v02r01 section II.E.

Method SA-1 (trace averaging with the EUT transmitting at full power throughout each sweep):

- (i) Set span to encompass the entire emission bandwidth (EBW) (or, alternatively, the entire 99% occupied bandwidth) of the signal.
- (ii) Set RBW = 1 MHz.
- (iii) Set VBW \geq 3 MHz.
- (iv) Number of points in sweep $\geq 2 \times$ span / RBW. (This ensures that bin-to-bin spacing is \leq RBW/2, so that narrowband signals are not lost between frequency bins.)
- (v) Sweep time = auto.
- (vi) Detector = power averaging (rms), if available. Otherwise, use sample detector mode.
- (vii) If transmit duty cycle $<$ 98 %, use a video trigger with the trigger level set to enable triggering only on full power pulses. Transmitter must operate at maximum power control level for the entire duration of every sweep. If the EUT transmits continuously (i.e., with no off intervals) or at duty cycle \geq 98 %, and if each transmission is entirely at the maximum power control level, then the trigger shall be set to "free run."
- (viii) Trace average at least 100 traces in power averaging (rms) mode.
- (ix) Compute power by integrating the spectrum across the EBW (or, alternatively, the entire 99% occupied bandwidth) of the signal using the instrument's band power measurement function with band limits set equal to the EBW (or occupied bandwidth) band edges. If the instrument does not have a band power function, sum the spectrum levels (in power units) at 1 MHz intervals extending across the EBW (or, alternatively, the entire 99% occupied bandwidth) of the spectrum.

Method PM (Measurement using an RF average power meter):

- (i) Measurements may be performed using a wideband RF power meter with a thermocouple detector or equivalent if all of the following conditions are satisfied:
 - a. The EUT is configured to transmit continuously or to transmit with a constant duty cycle.
 - b. At all times when the EUT is transmitting, it must be transmitting at its maximum power control level.
 - c. The integration period of the power meter exceeds the repetition period of the transmitted signal by at least a factor of five.
- (ii) If the transmitter does not transmit continuously, measure the duty cycle, x , of the transmitter output signal as described in II.B.
- (iii) Measure the average power of the transmitter. This measurement is an average over both the on and off periods of the transmitter.
- (iv) Adjust the measurement in dBm by adding $10 \log (1/x)$ where x is the duty cycle (e.g., $10 \log (1/0.25)$ if the duty cycle is 25 %).

Method PM-G (Measurement using a gated RF average power meter):

Measurements may be performed using a wideband gated RF power meter provided that the gate parameters are adjusted such that the power is measured only when the EUT is transmitting at its maximum power control level. Since the measurement is made only during the ON time of the transmitter, no duty cycle correction factor is required.

Straddle channel power was measured using spectrum analyzer.

TEST SETUP

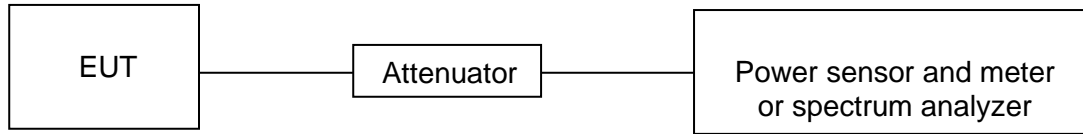

TEST ENVIRONMENT

Temperature	24.4 °C	Relative Humidity	34.4 %
Atmosphere Pressure	101 kPa	Test Voltage	DC 3.3 V

RESULTS

Spot Check Verification Summary:

Test Item	Test Mode	Frequency	Antenna	Worst Case Test Result	
				Original Model	Spot Check Model
Conducted AV Power	802.11a	5700 MHz	0	14.21 dBm	14.14 dBm
			1	13.46 dBm	13.96 dBm
	802.11n HT20	5580 MHz	0	13.73 dBm	13.42 dBm
			1	12.36 dBm	12.68 dBm
	802.11n HT40	5550 MHz	0	13.71 dBm	13.68 dBm
			1	13.22 dBm	12.67 dBm

Conclusion:

The spot check test result show that the new devices still comply with the standard and the new test result was close to the original test result, so it can demonstrate that the referenced test data remains valid for the new device.



Test Data:

Mode	Frequency (MHz)	Antenna	Conducted AV Power		Total		Limit
			(dBm)	(mW)	(mW)	(dBm)	(dBm)
802.11a	5180	0	13.11	20.46	38.04	15.80	24
		1	12.45	17.58			24
	5200	0	13.46	22.18	41.82	16.21	24
		1	12.93	19.63			24
	5240	0	13.55	22.65	42.19	16.25	24
		1	12.91	19.54			24
	5260	0	13.33	21.53	40.94	16.12	24
		1	12.88	19.41			24
	5300	0	13.33	21.53	43.51	16.39	24
		1	13.42	21.98			24
	5320	0	13.34	21.58	46.07	16.63	24
		1	13.89	24.49			24
	5500	0	13.85	24.27	47.33	16.75	24
		1	13.63	23.07			24
	5580	0	14.13	25.88	50.20	17.01	24
		1	13.86	24.32			24
	5700	0	14.14	25.94	50.83	17.06	24
		1	13.96	24.89			24
	5745	0	14.14	25.94	46.98	16.72	30
		1	13.23	21.04			30
5785	0	13.98	25.00	48.23	16.83	30	
	1	13.66	23.23			30	
5825	0	13.26	21.18	43.11	16.35	30	
	1	13.41	21.93			30	
802.11n HT20	5180	0	11.95	15.67	28.73	14.58	24
		1	11.16	13.06			24
	5200	0	12.54	17.95	34.28	15.35	24
		1	12.13	16.33			24
	5240	0	12.83	19.19	35.94	15.56	24
		1	12.24	16.75			24
	5260	0	12.76	18.88	35.25	15.47	24
		1	12.14	16.37			24
	5300	0	12.02	15.92	32.56	15.13	24
		1	12.21	16.63			24
	5320	0	12.41	17.42	32.73	15.15	24
		1	11.85	15.31			24



	5500	0	12.76	18.88	36.79	15.66	24	
		1	12.53	17.91			24	
	5580	0	13.42	21.98	40.51	16.08	24	
		1	12.68	18.54			24	
	5700	0	12.28	16.90	33.35	15.23	24	
		1	12.16	16.44			24	
	5745	0	13.47	22.23	40.35	16.06	30	
		1	12.58	18.11			30	
	5785	0	13.04	20.14	38.29	15.83	30	
		1	12.59	18.16			30	
	5825	0	13.05	20.18	39.50	15.97	30	
		1	12.86	19.32			30	
	802.11n HT40	5190	0	12.21	16.63	31.02	14.92	24
			1	11.58	14.39			24
5230		0	12.15	16.41	30.96	14.91	24	
		1	11.63	14.55			24	
5270		0	12.95	19.72	38.52	15.86	24	
		1	12.74	18.79			24	
5310		0	13.21	20.94	40.62	16.09	24	
		1	12.94	19.68			24	
5510		0	12.67	18.49	35.75	15.53	24	
		1	12.37	17.26			24	
5550		0	13.68	23.33	41.83	16.21	24	
		1	12.67	18.49			24	
5670		0	13.16	20.70	38.24	15.83	24	
		1	12.44	17.54			24	
5755		0	13.31	21.43	38.61	15.87	30	
		1	12.35	17.18			30	
5795		0	13.15	20.65	39.75	15.99	30	
		1	12.81	19.10			30	

8. RADIATED TEST RESULTS

LIMITS

Refer to CFR 47 FCC §15.205, §15.209 and §15.407 (b).

Refer to ISED RSS-GEN Clause 8.9, Clause 8.10 and ISED RSS-247 6.2.

Radiation Disturbance Test Limit for FCC (Class B) (9 kHz ~ 1 GHz)

Emissions radiated outside of the specified frequency bands above 30 MHz			
Frequency Range (MHz)	Field Strength Limit (uV/m) at 3 m	Field Strength Limit (dBuV/m) at 3 m	
		Quasi-Peak	
30 - 88	100	40	
88 - 216	150	43.5	
216 - 960	200	46	
Above 960	500	54	
Above 1000	500	Peak	Average
		74	54

FCC Emissions radiated outside of the specified frequency bands below 30 MHz		
Frequency (MHz)	Field strength (microvolts/meter)	Measurement distance (meters)
0.009-0.490	2400/F(kHz)	300
0.490-1.705	24000/F(kHz)	30
1.705-30.0	30	30

ISED General field strength limits at frequencies below 30 MHz

Table 6 – General field strength limits at frequencies below 30 MHz		
Frequency	Magnetic field strength (H-Field) (µA/m)	Measurement distance (m)
9 - 490 kHz ^{Note 1}	6.37/F (F in kHz)	300
490 - 1705 kHz	63.7/F (F in kHz)	30
1.705 - 30 MHz	0.08	30

Note 1: The emission limits for the ranges 9-90 kHz and 110-490 kHz are based on measurements employing a linear average detector.

ISED Restricted bands refer to ISED RSS-GEN Clause 8.10

Table 7 – Restricted frequency bands^{Note 1}

MHz	MHz	GHz
0.090 - 0.110	149.9 - 150.05	9.0 - 9.2
0.495 - 0.505	156.52475 - 156.52525	9.3 - 9.5
2.1735 - 2.1905	156.7 - 156.9	10.6 - 12.7
3.020 - 3.026	162.0125 - 167.17	13.25 - 13.4
4.125 - 4.128	167.72 - 173.2	14.47 - 14.5
4.17725 - 4.17775	240 - 285	15.35 - 16.2
4.20725 - 4.20775	322 - 335.4	17.7 - 21.4
5.677 - 5.683	399.9 - 410	22.01 - 23.12
6.215 - 6.218	608 - 614	23.6 - 24.0
6.26775 - 6.26825	960 - 1427	31.2 - 31.8
6.31175 - 6.31225	1435 - 1626.5	36.43 - 36.5
8.291 - 8.294	1645.5 - 1646.5	Above 38.6
8.362 - 8.366	1660 - 1710	
8.37625 - 8.38675	1718.8 - 1722.2	
8.41425 - 8.41475	2200 - 2300	
12.29 - 12.293	2310 - 2390	
12.51975 - 12.52025	2483.5 - 2500	
12.57675 - 12.57725	2655 - 2900	
13.36 - 13.41	3260 - 3267	
16.42 - 16.423	3332 - 3339	
16.89475 - 16.89525	3345.8 - 3358	
16.80425 - 16.80475	3500 - 4400	
25.5 - 25.67	4500 - 5150	
37.5 - 38.25	5350 - 5480	
73 - 74.6	7250 - 7750	
74.8 - 75.2	8025 - 8500	
108 - 138		

Note 1: Certain frequency bands listed in table 7 and in bands above 38.6 GHz are designated for licence-exempt applications. These frequency bands and the requirements that apply to related devices are set out in the 200 and 300 series of RSSs.

FCC Restricted bands of operation refer to FCC §15.205 (a):

MHz	MHz	MHz	GHz
0.090-0.110	16.42-16.423	399.9-410	4.5-5.15
¹ 0.495-0.505	16.69475-16.69525	608-614	5.35-5.46
2.1735-2.1905	16.80425-16.80475	960-1240	7.25-7.75
4.125-4.128	25.5-25.67	1300-1427	8.025-8.5
4.17725-4.17775	37.5-38.25	1435-1626.5	9.0-9.2
4.20725-4.20775	73-74.6	1645.5-1646.5	9.3-9.5
6.215-6.218	74.8-75.2	1660-1710	10.6-12.7
6.26775-6.26825	108-121.94	1718.8-1722.2	13.25-13.4
6.31175-6.31225	123-138	2200-2300	14.47-14.5
8.291-8.294	149.9-150.05	2310-2390	15.35-16.2
8.362-8.366	156.52475-156.52525	2483.5-2500	17.7-21.4
8.37625-8.38675	156.7-156.9	2690-2900	22.01-23.12
8.41425-8.41475	162.0125-167.17	3260-3267	23.6-24.0
12.29-12.293	167.72-173.2	3332-3339	31.2-31.8
12.51975-12.52025	240-285	3345.8-3358	36.43-36.5
12.57675-12.57725	322-335.4	3600-4400	(²)
13.36-13.41			

Note: ¹Until February 1, 1999, this restricted band shall be 0.490-0.510 MHz.

²Above 38.6c



Limits of unwanted/undesirable emission out of the restricted bands refer to CFR 47 FCC §15.407 (b) and ISED RSS-247 6.2.

LIMITS OF RADIATED EMISSION MEASUREMENT (Above 1GHz)		
Frequency Range (MHz)	EIRP Limit	Field Strength Limit (dBuV/m) at 3 m
5150~5250 MHz	PK: -27 (dBm/MHz)	PK:68.2(dBμV/m)
5250~5350 MHz		
5470~5725 MHz		
5725~5850 MHz	PK: -27 (dBm/MHz) *1 PK: 10 (dBm/MHz) *2 PK: 15.6 (dBm/MHz) *3 PK: 27 (dBm/MHz) *4	PK: 68.2(dBμV/m) *1 PK: 105.2 (dBμV/m) *2 PK: 110.8(dBμV/m) *3 PK: 122.2 (dBμV/m) *4
<p>Note:</p> <p>*1 beyond 75 MHz or more above of the band edge.</p> <p>*2 below the band edge increasing linearly to 10 dBm/MHz at 25 MHz above.</p> <p>*3 below the band edge increasing linearly to a level of 15.6 dBm/MHz at 5 MHz above.</p> <p>*4 from 5 MHz above or below the band edge increasing linearly to a level of 27 dBm/MHz at the band edge.</p>		

TEST SETUP AND PROCEDURE

Below 30 MHz

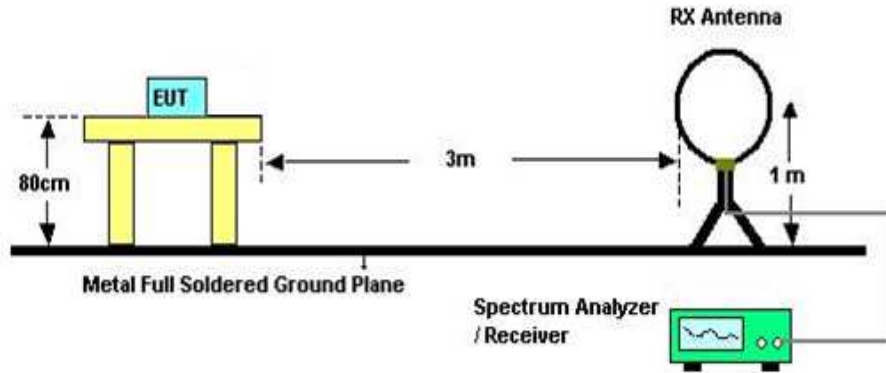

The setting of the spectrum analyser

RBW	200 Hz (From 9 kHz to 0.15 MHz)/ 9 kHz (From 0.15 MHz to 30 MHz)
VBW	200 Hz (From 9 kHz to 0.15 MHz)/ 9 kHz (From 0.15 MHz to 30 MHz)
Sweep	Auto
Trace	Max hold

1. The testing follows the guidelines in ANSI C63.10-2013 clause 11.11.
2. The EUT was arranged to its worst case and then turntable (from 0 degree to 360 degrees) to find the maximum reading. A pre-amp and a high pass filter are used for the test in order to get better signal level. Both Horizontal, Face-on and Face-off polarizations of the antenna are set to make the measurement.
3. The EUT was placed on a turntable with 80 cm above ground.
4. The EUT was set 3 meters from the interference receiving antenna, which was mounted on the top of a 1 m height antenna tower.
5. The radiated emission limits are based on measurements employing a CISPR quasi-peak detector except for the frequency bands 9-90 kHz, 110-490 kHz and above 1000 MHz. Radiated emission limits in these three bands are based on measurements employing an average detector.
6. For measurement below 1 GHz, the initial step in collecting conducted emission data is a spectrum analyzer peak detector mode pre-scanning the measurement frequency range. Significant peaks are then marked and then Quasi Peak and average detector mode re-measured. If the emission level of the EUT measured by the peak detector is 3 dB lower than the applicable limit, the peak emission level will be reported. Otherwise, the emission measurement will be repeated using the quasi-peak and average detector and reported.
7. Although these tests were performed other than open field site, adequate comparison measurements were confirmed against 30 m open field site. Therefore sufficient tests were made to demonstrate that the alternative site produces results that correlate with the ones of tests made in an open field site based on KDB 414788.

Below 1 GHz and above 30 MHz

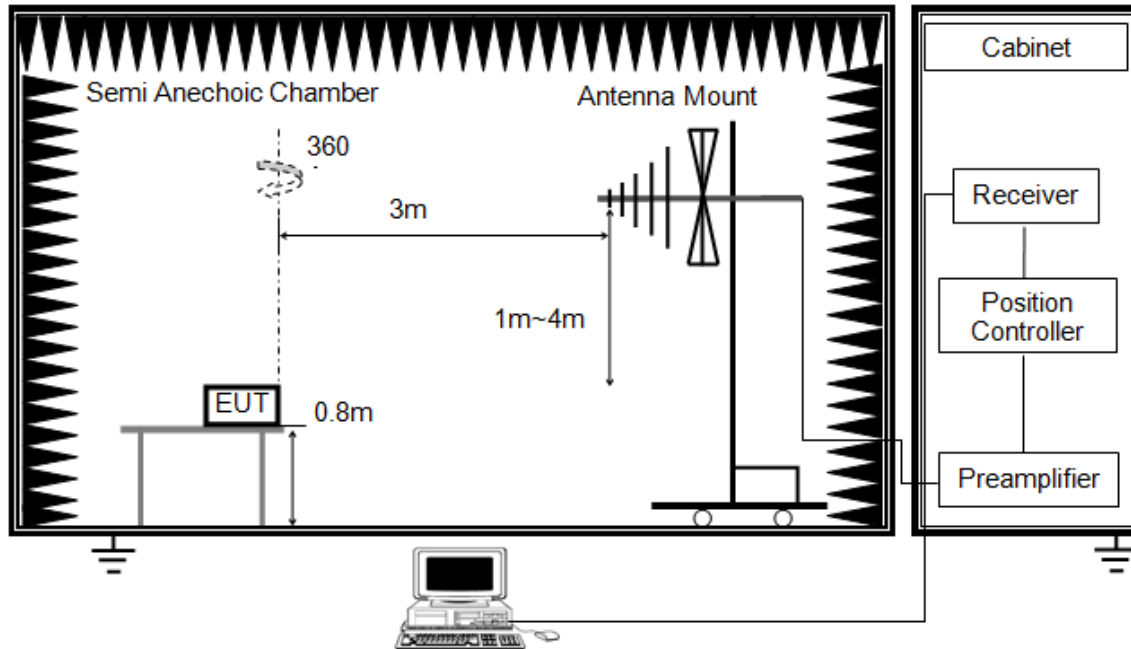

The setting of the spectrum analyser

RBW	120 kHz
VBW	300 kHz
Sweep	Auto
Detector	Peak/QP
Trace	Max hold

1. The testing follows the guidelines in ANSI C63.10-2013 clause 11.11.
2. The EUT was arranged to its worst case and then tune the antenna tower (from 1 m to 4 m) and turntable (from 0 degree to 360 degrees) to find the maximum reading. A pre-amp and a high pass filter are used for the test in order to get better signal level. Both horizontal and vertical polarizations of the antenna are set to make the measurement.
3. The EUT was placed on a turntable with 80 cm above ground.
4. The EUT was set 3 meters from the interference receiving antenna, which was mounted on the top of a variable height antenna tower.
5. For measurement below 1 GHz, the initial step in collecting conducted emission data is a spectrum analyzer peak detector mode pre-scanning the measurement frequency range. Significant peaks are then marked and then Quasi Peak detector mode re-measured. If the emission level of the EUT measured by the peak detector is 3 dB lower than the applicable limit, the peak emission level will be reported. Otherwise, the emission measurement will be repeated using the quasi-peak detector and reported.

Above 1 GHz

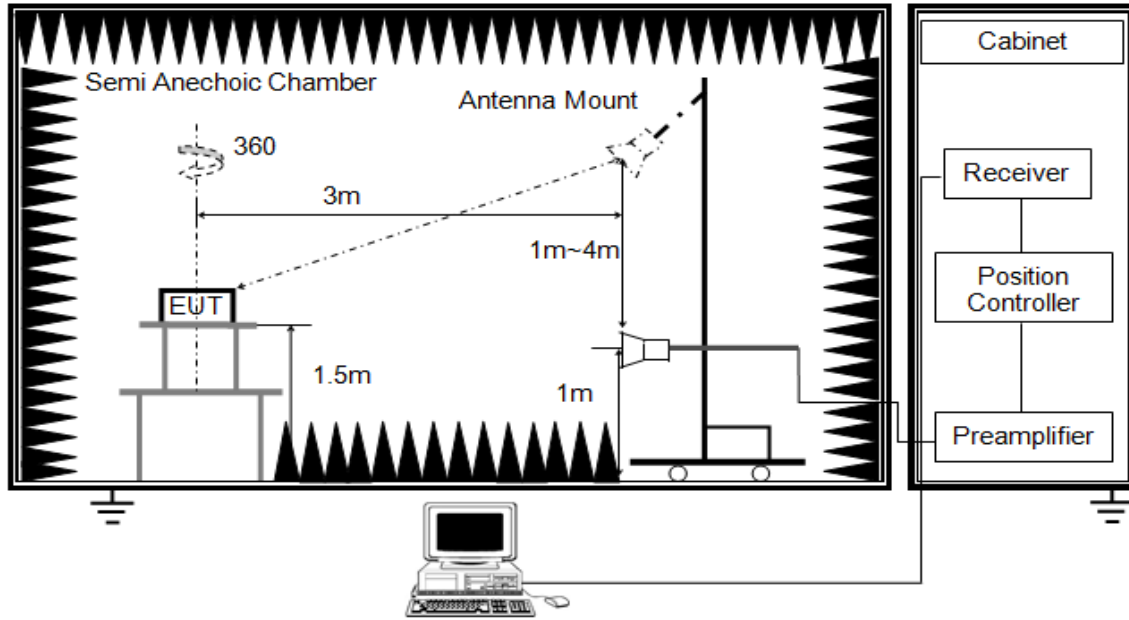

The setting of the spectrum analyser

RBW	1 MHz
VBW	PEAK: 3 MHz AVG: see note 6
Sweep	Auto
Detector	Peak
Trace	Max hold

1. The testing follows the guidelines in KDB 789033 D02 General U-NII Test Procedures New Rules v02r01 section II.G.3 ~ II.G.6.
2. The EUT was arranged to its worst case and then tune the antenna tower (1.5 m) and turntable (from 0 degree to 360 degrees) to find the maximum reading. A pre-amp and a high pass filter are used for the test in order to get better signal level. Both horizontal and vertical polarizations of the antenna are set to make the measurement.
3. The EUT was placed on a turntable with 1.5 m above ground.
4. The EUT was set 3 meters from the interference receiving antenna, which was mounted on the top of a variable height antenna tower.
5. For measurement above 1 GHz, the emission measurement will be measured by the peak detector. This peak level, once corrected, must comply with the limit specified in Section 15.209.
6. For measurements above 1 GHz the resolution bandwidth is set to 1 MHz, then the video bandwidth is set to 3 MHz for peak measurements and 1 MHz resolution bandwidth with 1/T video bandwidth with peak detector for average measurements. For the Duty Cycle please refer to clause 7.1.ON TIME AND DUTY CYCLE.

X axis, Y axis, Z axis positions:

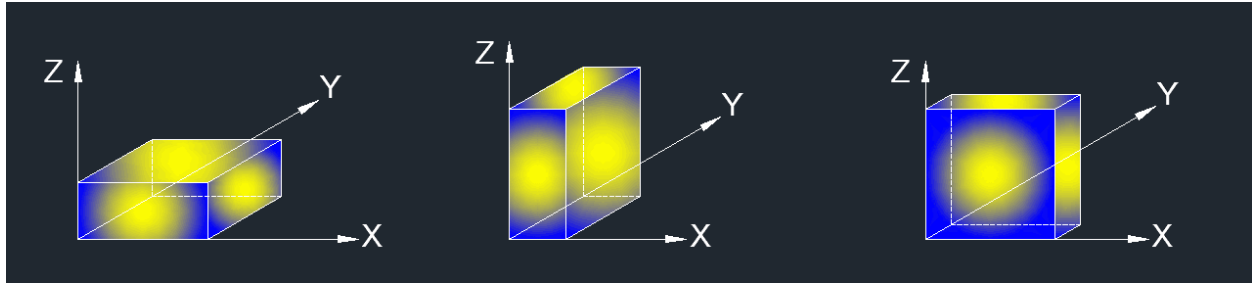

Note 1: For all radiated test, EUT in each of three orthogonal axis emissions had been tested, but only the worst case (X axis) data recorded in the report.

Note 2: The EUT was fully exercised with external accessories during the test. In the case of multiple accessory external ports, an external accessory shall be connected to one of each type of port.

Note 3: Simultaneous transmission had been evaluated with the 5 GHz WLAN / 2.4 GHz WLAN and BT / BLE transmitter and has no additional or worse emissions found. Only the worst data was recorded in the test report.

TEST ENVIRONMENT

Temperature	19.3 °C	Relative Humidity	50.6 %
Atmosphere Pressure	101 kPa	Test Voltage	DC 3.3 V

RESULTS



8.1. SPOT CHECK VERIFICATION SUMMERY

Test Item	Test Mode	Test Channel	Frequency	Worst Case Test Result	
				Original Model	Spot Check Model
		MHz	MHz	dBuV/m	
Spurious Emission	802.11a	5320 MHz	15960 (3 th harmonic)	41.62	44.58

Conclusion:

The spot check test result show that the new devices still comply with the standard and the new test result was close to the original test result, so it can demonstrate that the referenced test data remains valid for the new device.

8.2. SPURIOUS EMISSIONS (1 GHz ~ 7 GHz)

8.2.1. 802.11a MODE AND BT MODE WORST CASE

HARMONICS AND SPURIOUS EMISSIONS (802.11a MODE UNII-2C MIDDLE CHANNEL, BT 8DQPSK MIDDLE, HORIZONTAL)

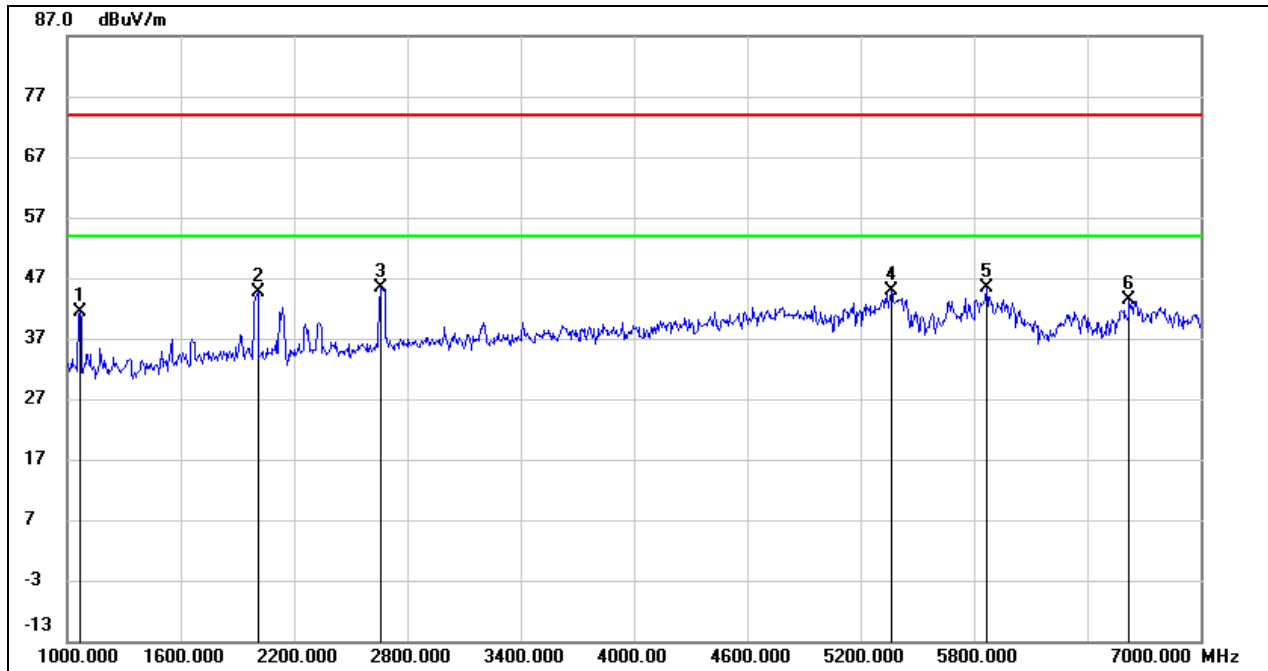

No.	Frequency (MHz)	Reading (dBuV)	Correct (dB/m)	Result (dBuV/m)	Limit (dBuV/m)	Margin (dB)	Remark
1	1066.000	54.92	-13.65	41.27	74.00	-32.73	peak
2	2008.000	54.81	-10.15	44.66	74.00	-29.34	peak
3	2662.000	52.76	-7.46	45.30	74.00	-28.70	peak
4	5362.000	43.00	1.91	44.91	74.00	-29.09	peak
5	5866.000	42.62	2.77	45.39	74.00	-28.61	peak
6	6622.000	37.88	5.51	43.39	74.00	-30.61	peak

Note: 1. Measurement = Reading Level + Correct Factor.

2. If Peak Result complies with AV limit, AV Result is deemed to comply with AV limit.

3. Peak: Peak detector.

4. AVG: $VBW=1/Ton$, where: Ton is the transmitting duration.

5. For the transmitting duration, please refer to clause 7.1.

6. Filter losses were only considered in the spurious frequency bands and the authorized band was not corrected for Band reject filter losses.

7. Proper operation of the transmitter prior to adding the filter to the measurement chain.

8. Since non-restricted band peak emissions are less than the average limit, they also comply with the -27dBm/MHz (68.2dBuV/m) limit.



**HARMONICS AND SPURIOUS EMISSIONS (802.11a MODE UNII-2C MIDDLE CHANNEL, BT
8DQPSK MIDDLE, VERTICAL)**

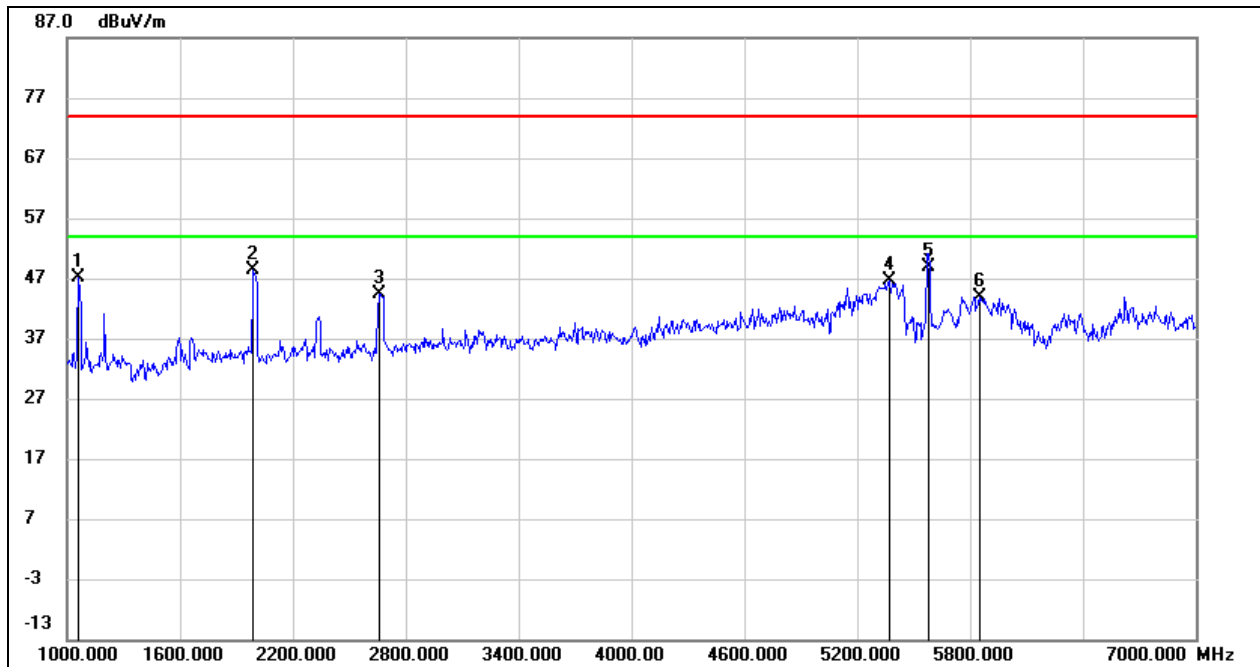

No.	Frequency (MHz)	Reading (dBuV)	Correct (dB/m)	Result (dBuV/m)	Limit (dBuV/m)	Margin (dB)	Remark
1	1060.000	60.76	-13.68	47.08	74.00	-26.92	peak
2	1990.000	58.59	-10.19	48.40	74.00	-25.60	peak
3	2662.000	51.91	-7.46	44.45	74.00	-29.55	peak
4	5368.000	44.76	1.90	46.66	74.00	-27.34	peak
5	5580.000	46.45	2.40	48.85	74.00	-25.15	peak
6	5848.000	41.10	2.70	43.80	74.00	-30.20	peak

Note: 1. Measurement = Reading Level + Correct Factor.

2. If Peak Result complies with AV limit, AV Result is deemed to comply with AV limit.

3. Peak: Peak detector.

4. AVG: $VBW=1/Ton$, where: Ton is the transmitting duration.

5. For the transmitting duration, please refer to clause 7.1.

6. Filter losses were only considered in the spurious frequency bands and the authorized band was not corrected for Band reject filter losses.

7. Proper operation of the transmitter prior to adding the filter to the measurement chain.

8. Since non-restricted band peak emissions are less than the average limit, they also comply with the -27dBm/MHz (68.2dBuV/m) limit.

Note: All the modes and antennas had been tested, but only the worst data was recorded in the report.

8.3. SPURIOUS EMISSIONS (7 GHz ~ 18 GHz)

8.3.1. 802.11a MODE AND BT MODE WORST CASE

HARMONICS AND SPURIOUS EMISSIONS (802.11a MODE UNII-2C MIDDLE CHANNEL, BT 8DQPSK MIDDLE, HORIZONTAL)

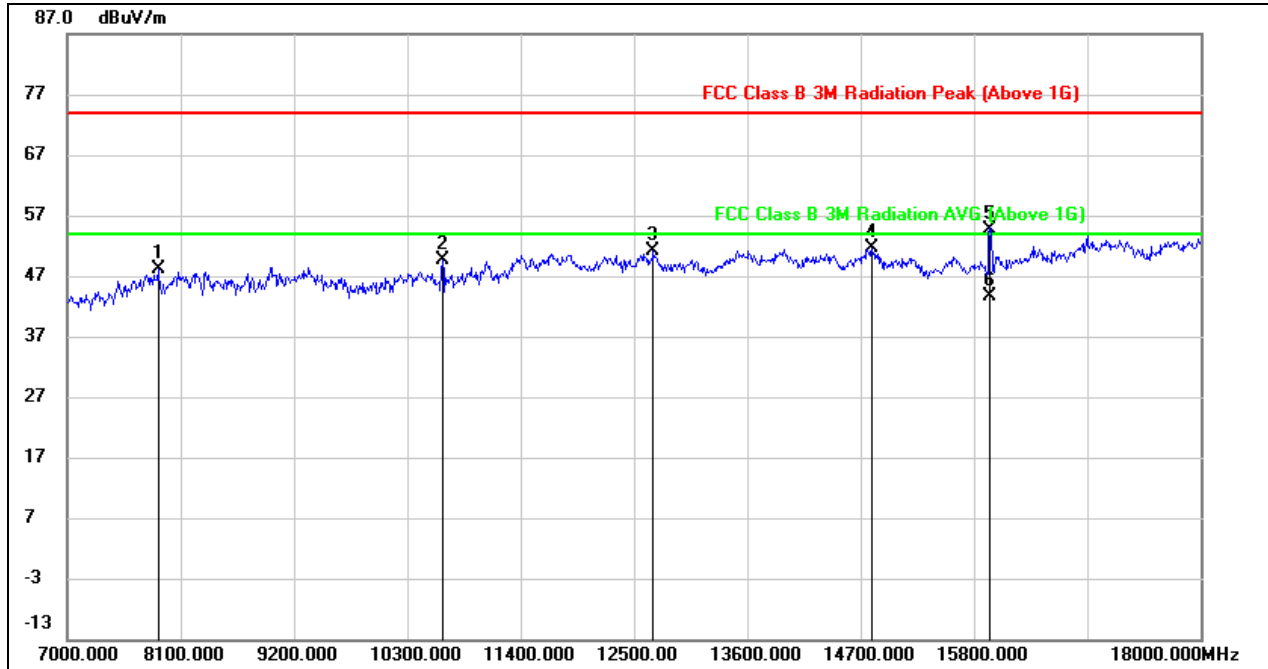

No.	Frequency (MHz)	Reading (dBuV)	Correct (dB/m)	Result (dBuV/m)	Limit (dBuV/m)	Margin (dB)	Remark
1	7880.000	39.29	8.95	48.24	74.00	-25.76	peak
2	10641.000	36.92	12.77	49.69	74.00	-24.31	peak
3	12687.000	35.50	15.64	51.14	74.00	-22.86	peak
4	14810.000	33.73	17.97	51.70	74.00	-22.30	peak
5	15960.000	36.42	18.27	54.69	74.00	-19.31	peak
6	15960.000	25.31	18.27	43.58	54.00	-10.42	AVG

Note: 1. Measurement = Reading Level + Correct Factor.

2. If Peak Result complies with AV limit, AV Result is deemed to comply with AV limit.

3. Peak: Peak detector.

4. AVG: $VBW=1/Ton$, where: Ton is the transmitting duration.

5. For the transmitting duration, please refer to clause 7.1.

6. Filter losses were only considered in the spurious frequency bands and the authorized band was not corrected for High Pass Filter losses.

7. Proper operation of the transmitter prior to adding the filter to the measurement chain.

8. Since non-restricted band peak emissions are less than the average limit, they also comply with the -27dBm/MHz (68.2dBuV/m) limit.

HARMONICS AND SPURIOUS EMISSIONS (802.11a MODE UNII-2C MIDDLE CHANNEL, BT 8DQPSK MIDDLE, VERTICAL)

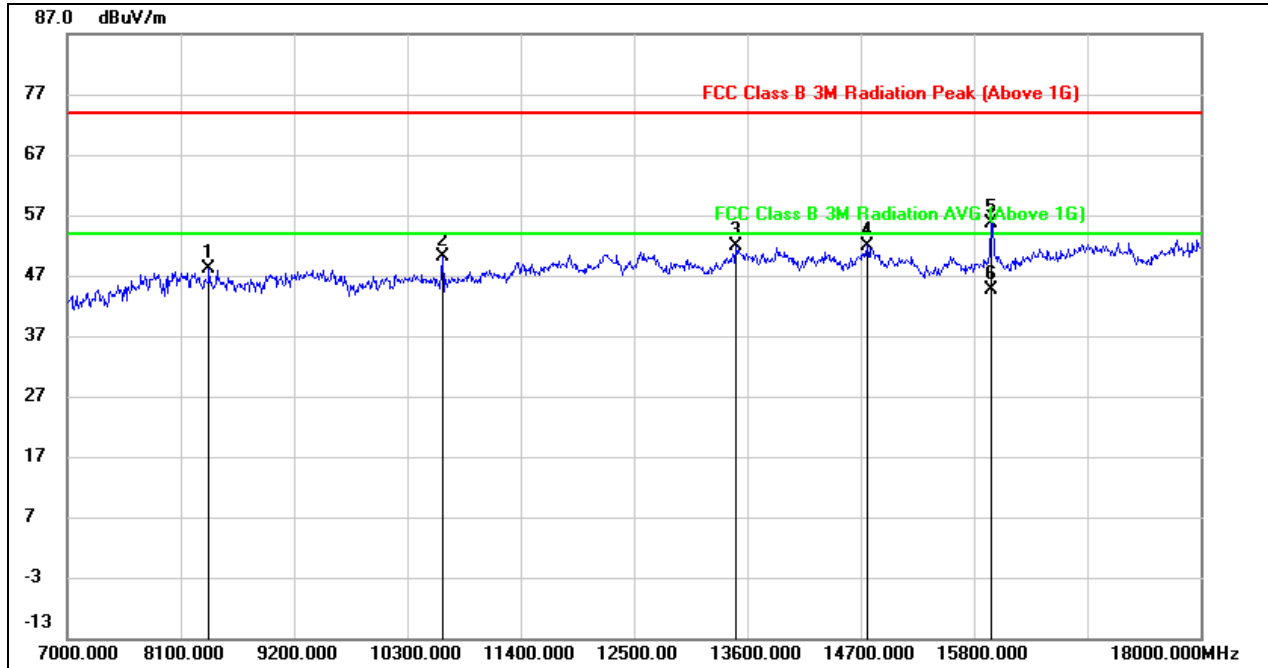

No.	Frequency (MHz)	Reading (dBuV)	Correct (dB/m)	Result (dBuV/m)	Limit (dBuV/m)	Margin (dB)	Remark
1	8375.000	38.62	9.42	48.04	74.00	-25.96	peak
2	10641.000	37.32	12.77	50.09	74.00	-23.91	peak
3	13490.000	34.56	17.20	51.76	74.00	-22.24	peak
4	14766.000	34.08	17.92	52.00	74.00	-22.00	peak
5	15960.000	37.34	18.27	55.61	74.00	-18.39	peak
6	15960.000	26.31	18.27	44.58	54.00	-9.42	AVG

- Note:
1. Measurement = Reading Level + Correct Factor.
 2. If Peak Result complies with AV limit, AV Result is deemed to comply with AV limit.
 3. Peak: Peak detector.
 4. AVG: $VBW=1/Ton$, where: Ton is the transmitting duration.
 5. For the transmitting duration, please refer to clause 7.1.
 6. Filter losses were only considered in the spurious frequency bands and the authorized band was not corrected for High Pass Filter losses.
 7. Proper operation of the transmitter prior to adding the filter to the measurement chain.
 8. Since non-restricted band peak emissions are less than the average limit, they also comply with the -27dBm/MHz (68.2dBuV/m) limit.

Note: All the modes and antennas had been tested, but only the worst data was recorded in the report.

8.4. SPURIOUS EMISSIONS (18 GHz ~ 26 GHz)

8.4.1. 802.11a MODE AND BT MODE WORST CASE

HARMONICS AND SPURIOUS EMISSIONS (802.11a MODE UNII-2C MIDDLE CHANNEL, BT 8DQPSK MIDDLE, HORIZONTAL)

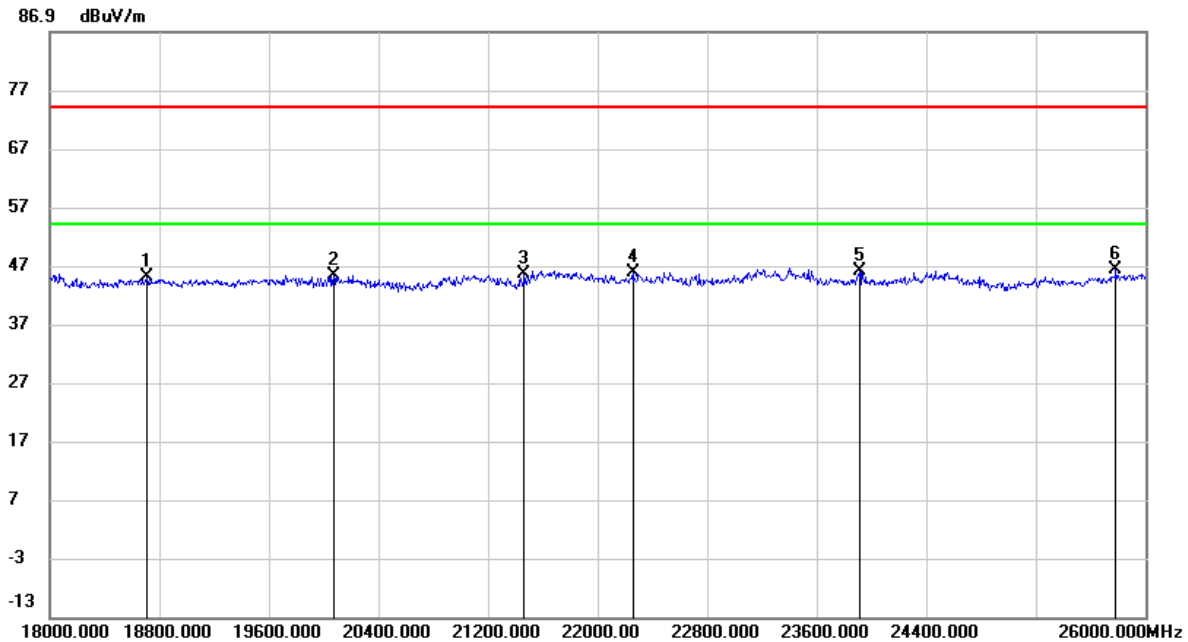

No.	Frequency (MHz)	Reading (dBuV)	Correct (dB/m)	Result (dBuV/m)	Limit (dBuV/m)	Margin (dB)	Remark
1	18712.000	49.73	-4.76	44.97	74.00	-29.03	peak
2	20072.000	49.84	-4.51	45.33	74.00	-28.67	peak
3	21464.000	51.25	-5.73	45.52	74.00	-28.48	peak
4	22256.000	51.95	-6.06	45.89	74.00	-28.11	peak
5	23912.000	50.32	-4.23	46.09	74.00	-27.91	peak
6	25784.000	47.73	-1.49	46.24	74.00	-27.76	peak

- Note: 1. Measurement = Reading Level + Correct Factor.
 2. If Peak Result complies with AV limit, AV Result is deemed to comply with AV limit.
 3. Peak: Peak detector.
 4. Proper operation of the transmitter prior to adding the filter to the measurement chain.



HARMONICS AND SPURIOUS EMISSIONS (802.11a MODE UNII-2C MIDDLE CHANNEL, BT 8DQPSK MIDDLE, VERTICAL)

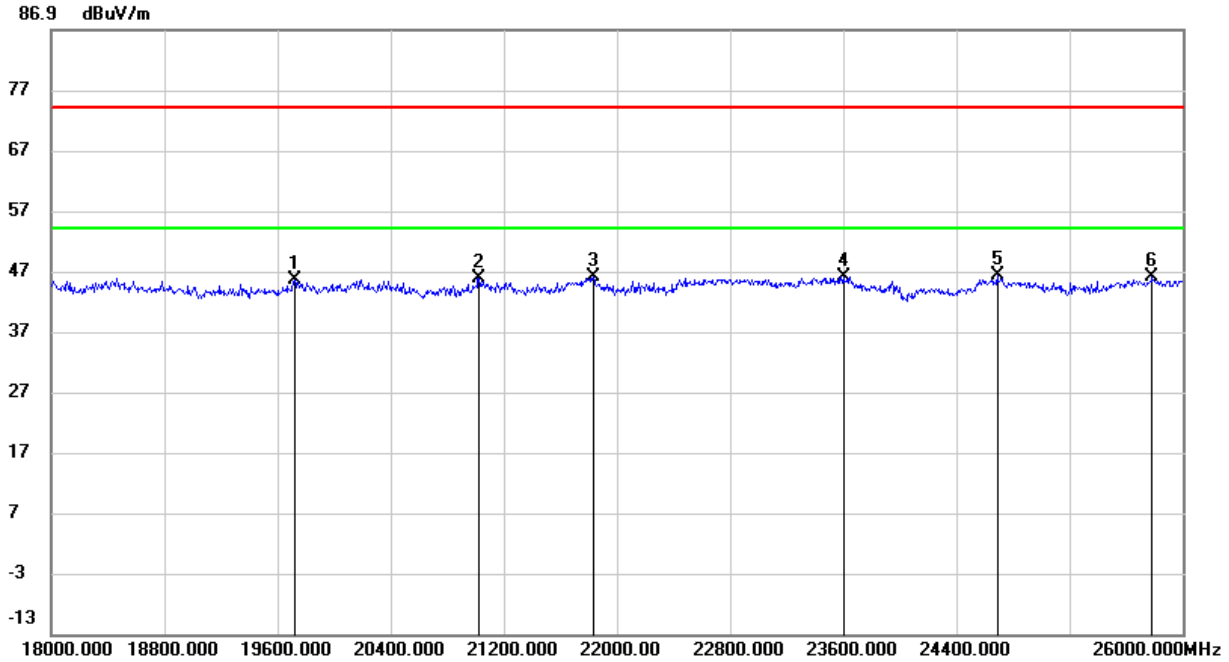

No.	Frequency (MHz)	Reading (dBuV)	Correct (dB/m)	Result (dBuV/m)	Limit (dBuV/m)	Margin (dB)	Remark
1	19720.000	50.00	-4.39	45.61	74.00	-28.39	peak
2	21024.000	51.14	-5.30	45.84	74.00	-28.16	peak
3	21832.000	52.03	-5.92	46.11	74.00	-27.89	peak
4	23600.000	50.72	-4.70	46.02	74.00	-27.98	peak
5	24688.000	48.39	-2.11	46.28	74.00	-27.72	peak
6	25784.000	47.58	-1.49	46.09	74.00	-27.91	peak

- Note: 1. Measurement = Reading Level + Correct Factor.
 2. If Peak Result complies with AV limit, AV Result is deemed to comply with AV limit.
 3. Peak: Peak detector.
 4. Proper operation of the transmitter prior to adding the filter to the measurement chain.

Note: All the modes and antennas had been tested, but only the worst data was recorded in the report.

8.5. SPURIOUS EMISSIONS (26 GHz ~ 40 GHz)

8.5.1. 802.11a MODE AND BT MODE WORST CASE

HARMONICS AND SPURIOUS EMISSIONS (802.11a MODE UNII-2C MIDDLE CHANNEL, BT 8DQPSK MIDDLE, HORIZONTAL)

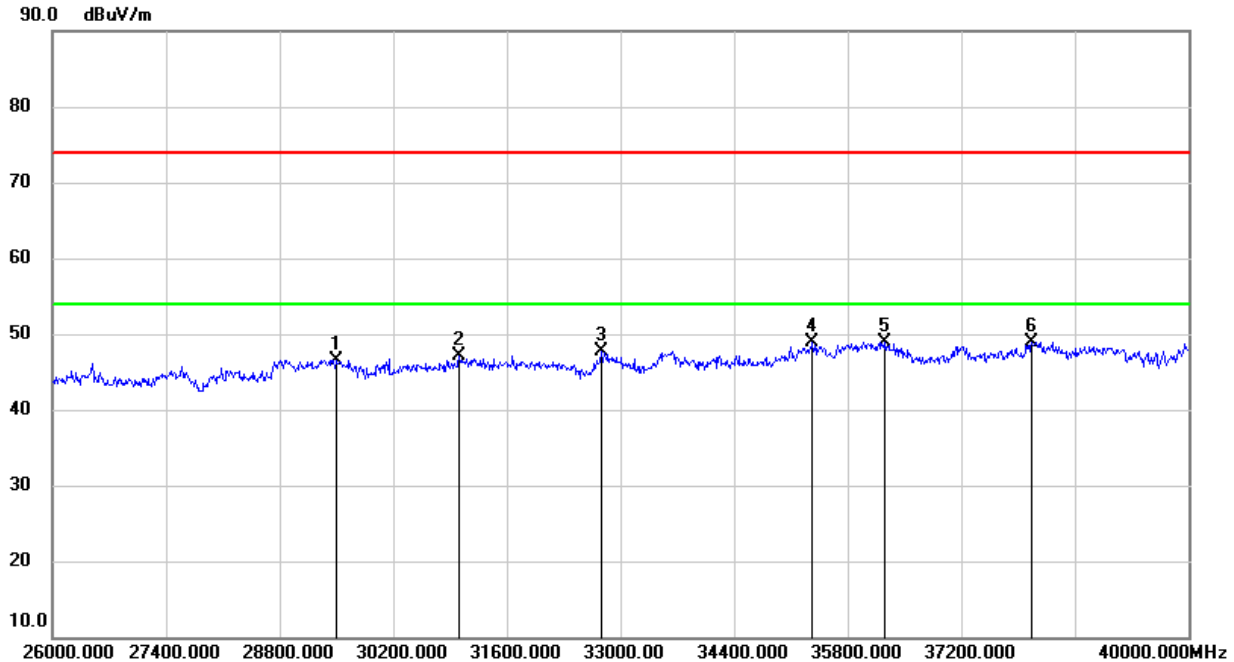

No.	Frequency (MHz)	Reading (dBuV)	Correct (dB/m)	Result (dBuV/m)	Limit (dBuV/m)	Margin (dB)	Remark
1	29500.000	47.16	-0.67	46.49	74.00	-27.51	peak
2	31012.000	47.83	-0.71	47.12	74.00	-26.88	peak
3	32762.000	48.95	-1.21	47.74	74.00	-26.26	peak
4	35366.000	46.40	2.59	48.99	74.00	-25.01	peak
5	36262.000	45.60	3.28	48.88	74.00	-25.12	peak
6	38068.000	45.56	3.42	48.98	74.00	-25.02	peak

Note: 1. Measurement = Reading Level + Correct Factor.

2. If Peak Result complies with AV limit, AV Result is deemed to comply with AV limit.

3. Peak: Peak detector.

4. Proper operation of the transmitter prior to adding the filter to the measurement chain.



**HARMONICS AND SPURIOUS EMISSIONS (802.11a MODE UNII-2C MIDDLE CHANNEL, BT
8DQPSK MIDDLE, VERTICAL)**

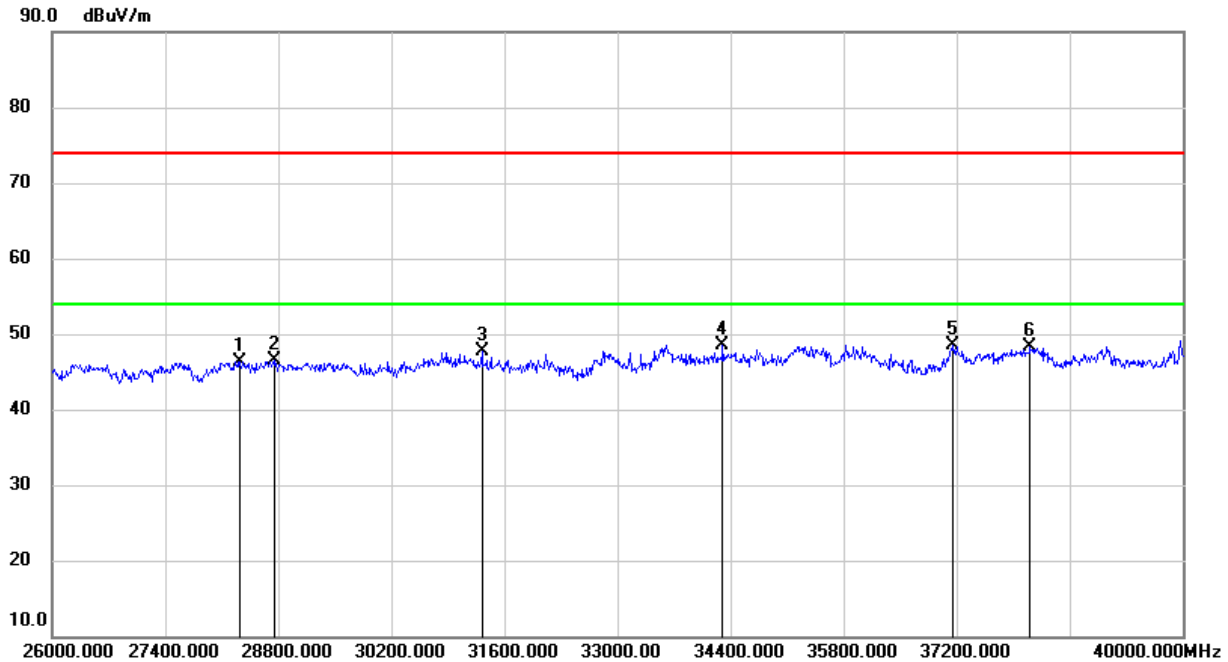

No.	Frequency (MHz)	Reading (dBuV)	Correct (dB/m)	Result (dBuV/m)	Limit (dBuV/m)	Margin (dB)	Remark
1	28324.000	48.86	-2.48	46.38	74.00	-27.62	peak
2	28744.000	46.99	-0.56	46.43	74.00	-27.57	peak
3	31320.000	48.61	-0.93	47.68	74.00	-26.32	peak
4	34302.000	47.45	1.10	48.55	74.00	-25.45	peak
5	37158.000	45.34	3.17	48.51	74.00	-25.49	peak
6	38110.000	44.83	3.53	48.36	74.00	-25.64	peak

- Note: 1. Measurement = Reading Level + Correct Factor.
 2. If Peak Result complies with AV limit, AV Result is deemed to comply with AV limit.
 3. Peak: Peak detector.
 4. Proper operation of the transmitter prior to adding the filter to the measurement chain.

Note: All the modes and antennas had been tested, but only the worst data was recorded in the report.

8.6. SPURIOUS EMISSIONS (30 MHz ~ 1 GHz)

8.6.1. 802.11a MODE AND BT MODE WORST CASE

HARMONICS AND SPURIOUS EMISSIONS (802.11a MODE UNII-2C MIDDLE CHANNEL, BT 8DQPSK MIDDLE, HORIZONTAL)

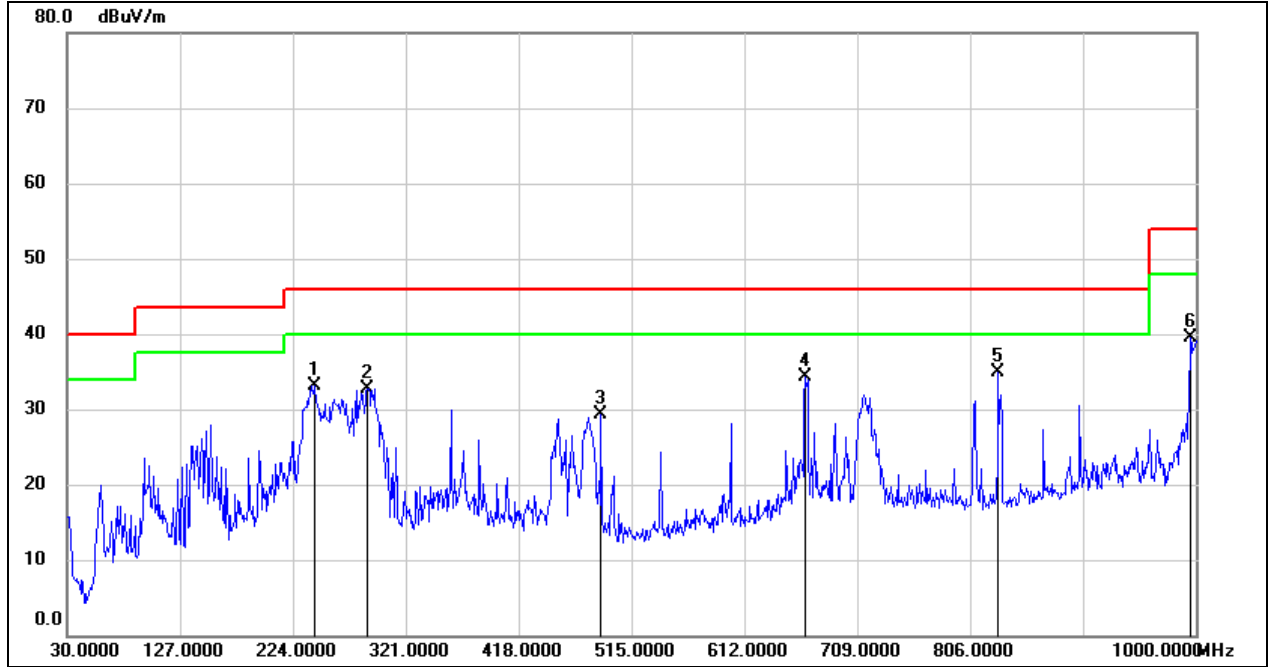

No.	Frequency (MHz)	Reading (dBuV)	Correct (dB/m)	Result (dBuV/m)	Limit (dBuV/m)	Margin (dB)	Remark
1	242.4300	52.26	-19.12	33.14	46.00	-12.86	QP
2	288.0200	48.75	-16.06	32.69	46.00	-13.31	QP
3	488.8100	41.08	-11.72	29.36	46.00	-16.64	QP
4	664.3800	42.95	-8.66	34.29	46.00	-11.71	QP
5	830.2500	41.53	-6.68	34.85	46.00	-11.15	QP
6	995.1500	43.69	-4.20	39.49	54.00	-14.51	QP

- Note: 1. Result Level = Read Level + Correct Factor.
 2. If Peak Result complies with QP limit, QP Result is deemed to comply with QP limit.
 3. Test setup: RBW: 120 kHz, VBW: 300 kHz, Sweep time: auto.

HARMONICS AND SPURIOUS EMISSIONS (802.11a MODE UNII-2C MIDDLE CHANNEL, BT 8DQPSK MIDDLE, VERTICAL)

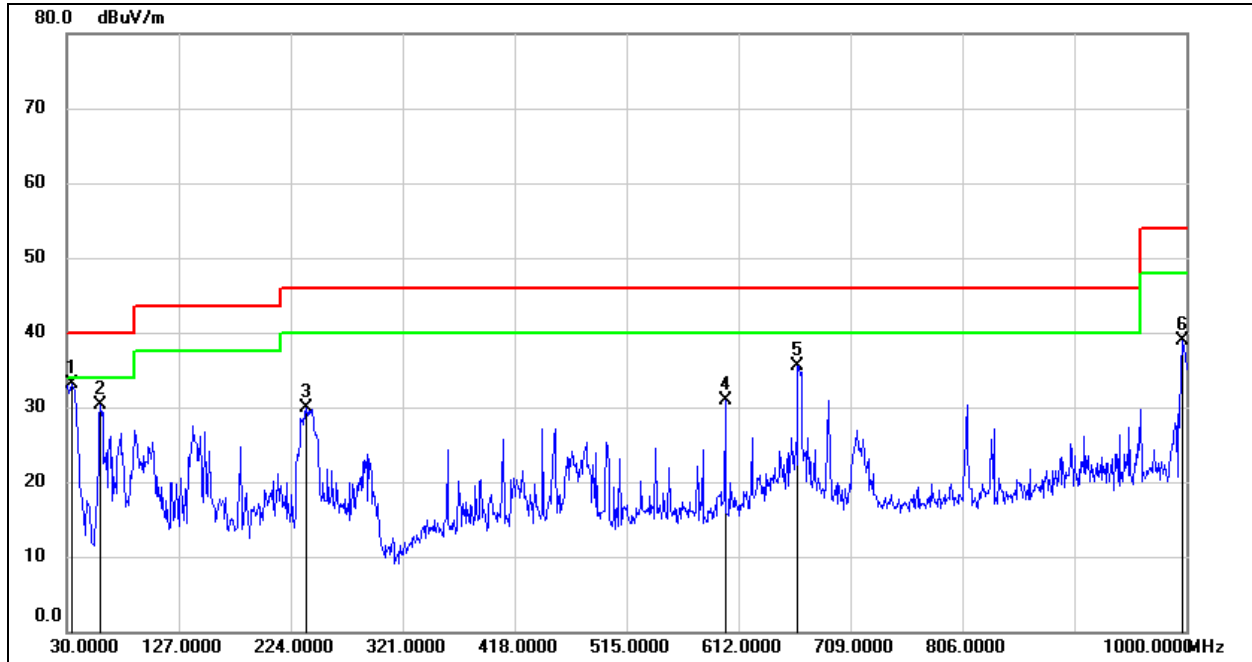

No.	Frequency (MHz)	Reading (dBuV)	Correct (dB/m)	Result (dBuV/m)	Limit (dBuV/m)	Margin (dB)	Remark
1	33.8800	52.40	-19.31	33.09	40.00	-6.91	QP
2	59.1000	50.83	-20.52	30.31	40.00	-9.69	QP
3	237.5800	48.90	-19.05	29.85	46.00	-16.15	QP
4	600.3600	40.50	-9.54	30.96	46.00	-15.04	QP
5	663.4099	44.18	-8.66	35.52	46.00	-10.48	QP
6	997.0900	43.09	-4.18	38.91	54.00	-15.09	QP

- Note: 1. Result Level = Read Level + Correct Factor.
 2. If Peak Result complies with QP limit, QP Result is deemed to comply with QP limit.
 3. Test setup: RBW: 120 kHz, VBW: 300 kHz, Sweep time: auto

Note: All the modes and antennas had been tested, but only the worst data was recorded in the report.

8.7. SPURIOUS EMISSIONS BELOW 30 MHz

8.7.1. 802.11a MODE AND BT MODE WORST CASE

HARMONICS AND SPURIOUS EMISSIONS (802.11a MODE UNII-2C MIDDLE CHANNEL, BT 8DQPSK MIDDLE, LOOP ANTENNA FACE ON TO THE EUT)

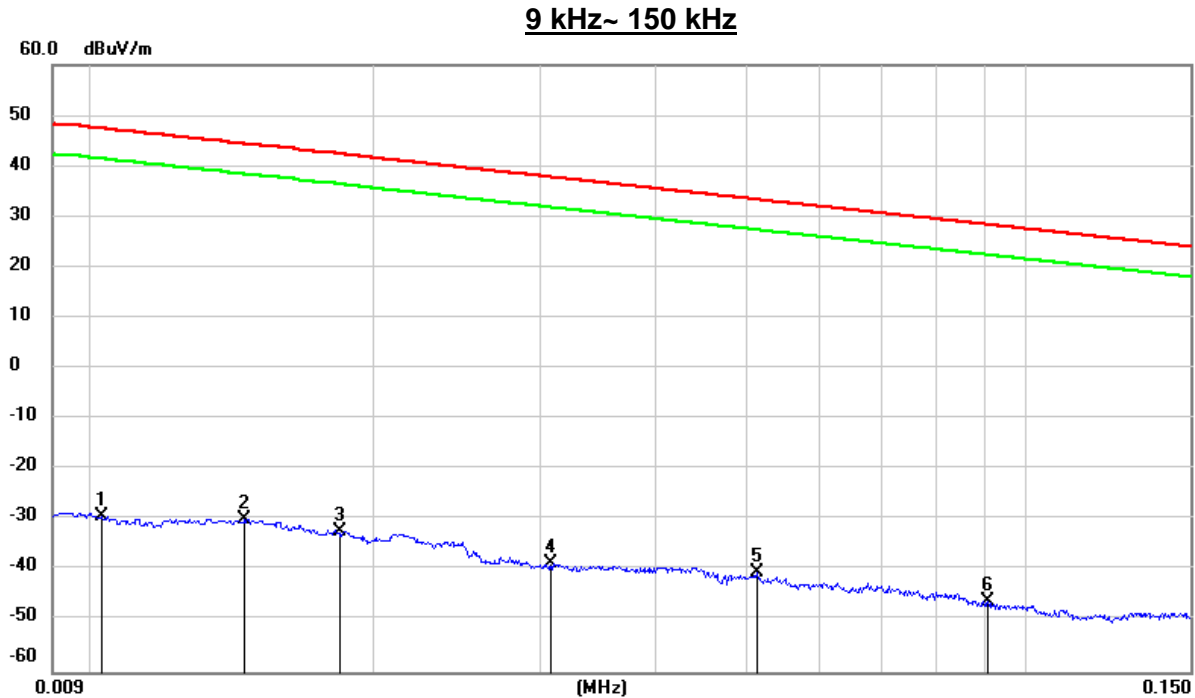

No.	Frequency (MHz)	Reading (dBuV)	Correct (dB/m)	FCC Result (dBuV/m)	FCC Limit (dBuV/m)	ISED Result (dBuA/m)	ISED Limit (dBuA/m)	Margin (dB)	Remark
1	0.0102	72.05	-101.40	-29.35	47.43	-80.85	-4.07	-76.78	peak
2	0.0145	71.55	-101.38	-29.83	44.37	-81.33	-7.13	-74.20	peak
3	0.0183	69.06	-101.36	-32.30	42.35	-83.8	-9.15	-74.65	peak
4	0.0309	62.71	-101.39	-38.68	37.80	-90.18	-13.7	-76.48	peak
5	0.0514	61.18	-101.48	-40.30	33.38	-91.8	-18.12	-73.68	peak
6	0.0911	55.61	-101.72	-46.11	28.41	-97.61	-23.09	-74.52	peak

Note: 1. Measurement = Reading Level + Correct Factor.

2. If Peak Result complies with AV and QP limit, AV and QP Result are deemed to comply with AV limit.

3. All 3 polarizations (Horizontal, Face-on and Face-off) of the loop antenna had been tested, but only the worst data recorded in the report.

4. $\text{dBuA/m} = \text{dBuV/m} - 20\log_{10}(120\pi) = \text{dBuV/m} - 51.5$.

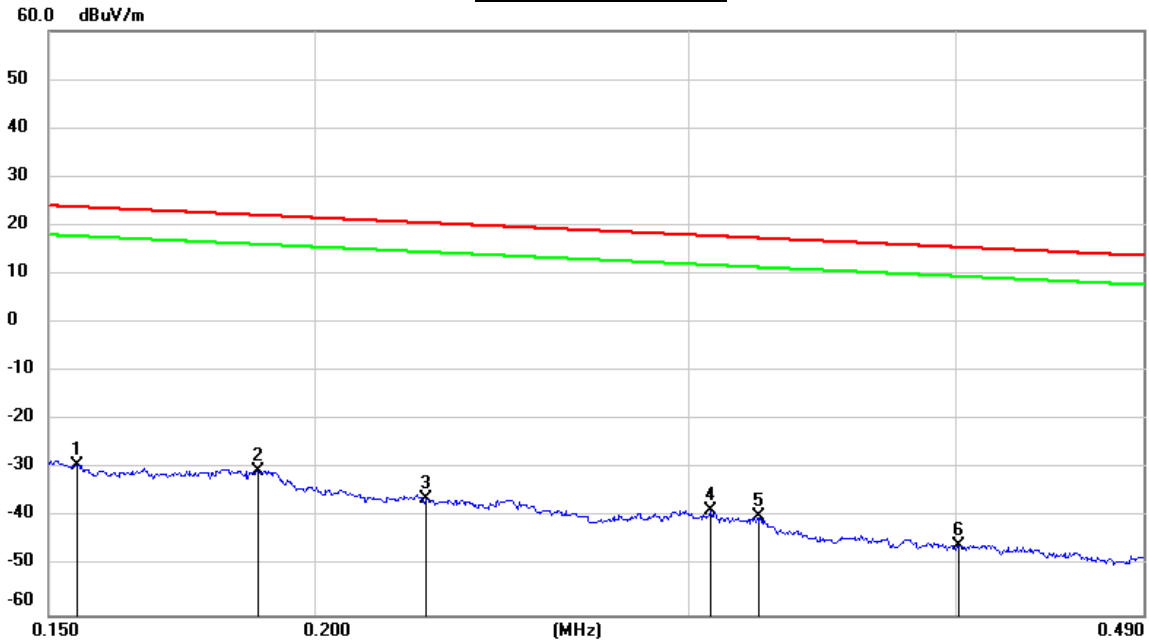
**150 kHz ~ 490 kHz**

No.	Frequency (MHz)	Reading (dBuV)	Correct (dB/m)	FCC Result (dBuV/m)	FCC Limit (dBuV/m)	ISED Result (dBuA/m)	ISED Limit (dBuA/m)	Margin (dB)	Remark
1	0.1547	72.31	-101.65	-29.34	23.81	-80.84	-27.69	-53.15	peak
2	0.1880	71.25	-101.70	-30.45	22.12	-81.95	-29.38	-52.57	peak
3	0.2255	65.75	-101.76	-36.01	20.54	-87.51	-30.96	-56.55	peak
4	0.3069	63.43	-101.86	-38.43	17.86	-89.93	-33.64	-56.29	peak
5	0.3234	61.98	-101.88	-39.90	17.41	-91.4	-34.09	-57.31	peak
6	0.4012	56.31	-101.96	-45.65	15.53	-97.15	-35.97	-61.18	peak

Note: 1. Measurement = Reading Level + Correct Factor.

2. If Peak Result complies with AV and QP limit, AV and QP Result are deemed to comply with AV limit.

3. All 3 polarizations (Horizontal, Face-on and Face-off) of the loop antenna had been tested, but only the worst data recorded in the report.

4. $\text{dBuA/m} = \text{dBuV/m} - 20\log_{10}(120\pi) = \text{dBuV/m} - 51.5$.

490 kHz ~ 30 MHz

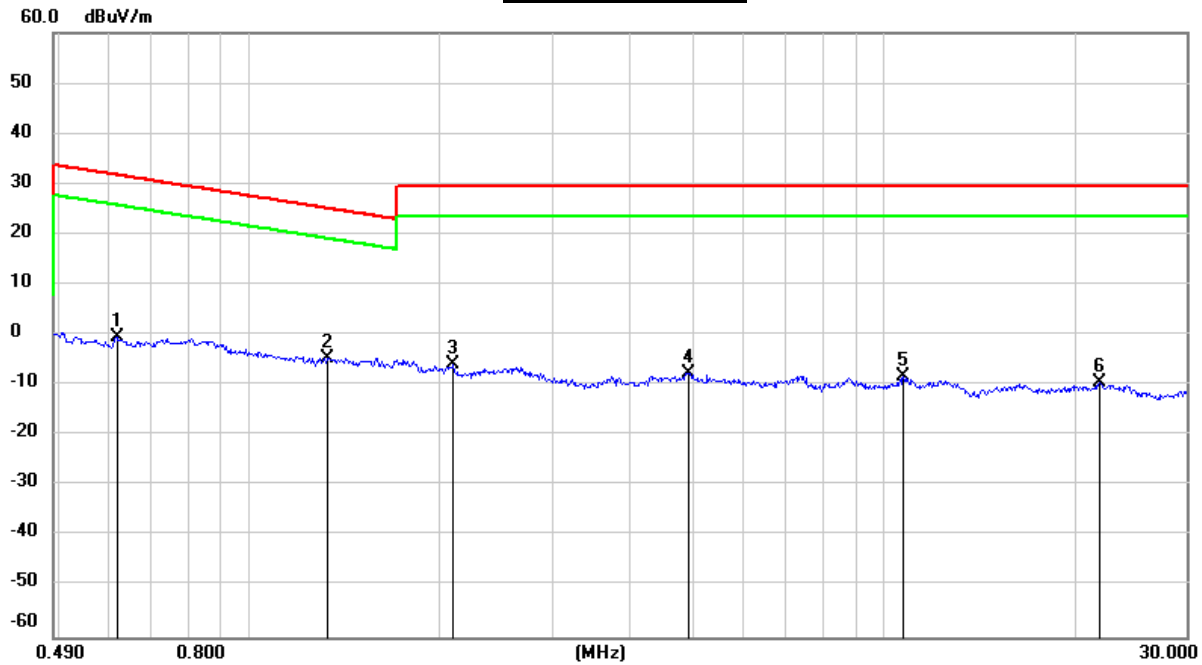

No.	Frequency (MHz)	Reading (dBuV)	Correct (dB/m)	FCC Result (dBuV/m)	FCC Limit (dBuV/m)	ISED Result (dBuA/m)	ISED Limit (dBuA/m)	Margin (dB)	Remark
1	0.6169	61.55	-62.08	-0.53	31.80	-52.03	-19.7	-32.33	peak
2	1.3263	57.48	-62.11	-4.63	25.15	-56.13	-26.35	-29.78	peak
3	2.0939	55.89	-61.79	-5.90	29.54	-57.4	-21.96	-35.44	peak
4	4.9165	53.88	-61.48	-7.60	29.54	-59.1	-21.96	-37.14	peak
5	10.7299	52.48	-60.83	-8.35	29.54	-59.85	-21.96	-37.89	peak
6	21.9143	51.22	-60.69	-9.47	29.54	-60.97	-21.96	-39.01	peak

Note: 1. Measurement = Reading Level + Correct Factor.

2. If Peak Result complies with AV and QP limit, AV and QP Result are deemed to comply with AV limit.

3. All 3 polarizations (Horizontal, Face-on and Face-off) of the loop antenna had been tested, but only the worst data recorded in the report.

4. $\text{dBuA/m} = \text{dBuV/m} - 20\log_{10}(120\pi) = \text{dBuV/m} - 51.5$.

Note: All the modes and antennas had been tested, but only the worst data was recorded in the report.



9. ANTENNA REQUIREMENTS

APPLICABLE REQUIREMENTS

Please refer to FCC §15.203

An intentional radiator shall be designed to ensure that no antenna other than that furnished by the responsible party shall be used with the device. The use of a permanently attached antenna or of an antenna that uses a unique coupling to the intentional radiator shall be considered sufficient to comply with the provisions of this section. The manufacturer may design the unit so that a broken antenna can be replaced by the user, but the use of a standard antenna jack or electrical connector is prohibited.

Please refer to FCC §15.407(a)(1)(2)(3)

If transmitting antennas of directional gain greater than 6 dBi are used, both the maximum conducted output power and the maximum power spectral density shall be reduced by the amount in dB that the directional gain of the antenna exceeds 6 dBi..

RESULTS

Complies

END OF REPORT