



**CFR 47 FCC PART 15 SUBPART E
ISED RSS-247 ISSUE 2**

CERTIFICATION TEST REPORT

For

Television

MODEL NUMBER: V655-J04

FCC ID: 2AYT5-V655J04

IC: 26954-V655J04

REPORT NUMBER: 4789898884.1-4

ISSUE DATE: May 6, 2021

Prepared for

**Hefei BOE Vision-electronic Technology Co.,Ltd.
NO.2177 Dongfang RD, Xinzhan General Pilot Zone HeFei, Anhui, 230012,
P.R.China**

Prepared by

UL Verification Services (Guangzhou) Co., Ltd, Song Shan Lake Branch

Building 10, Innovation Technology Park, No. 1, Li Bin Road, Song Shan Lake Hi-Tech Development Zone Dongguan, 523808, People's Republic of China

Tel: +86 769 22038881

Fax: +86 769 33244054

Website: www.ul.com



Revision History

Rev.	Issue Date	Revisions	Revised By
V0	05/06/2021	Initial Issue	

Note: The host product television installed the module SKI.WB7638U.1_MT7638BUB which had already applied for the limited single module and the FCC ID is 2AYT5-SKIWB7638U2 (IC: 26954-SKIWB7638U2). Since the installation of the module in the host does not change those parameters, full radiated testing was conducted and the original conducted data from the module is being leveraged. The conducted data contained within is taken directly from the module reports. The module reports were listed as followed. For other data, please refer to the original module reports.

Module Reports Details:

Equipment Class	Application Type	Test Report Number	Exhibit Type	FCC / ISED
DTS	Limited Single Module	SEFI2001042	Test Report	FCC
	Limited Single Module	SEDL2001042	Test Report	ISED
	Limited Single Module	4789787344.1-3	Test Report	FCC / ISED
NII	Limited Single Module	SEDL2001042	Test Report	FCC
	Limited Single Module	SEDM2001042	Test Report	ISED
	Limited Single Module	4789787344.1-4	Test Report	FCC / ISED
BLE	Limited Single Module	4789787344.1-1	Test Report	FCC / ISED
BT	Limited Single Module	4789787344.1-2	Test Report	FCC / ISED



Summary of Test Results			
Clause	Test Items	FCC/IC Rules	Test Results
1	Conducted Output Power Spot Check	FCC 15.407 (a) RSS-247 Clause 6.2	PASS
2	Radiated Bandedge and Spurious Emission	FCC 15.407 (b) FCC 15.209 FCC 15.205 RSS-247 Clause 6.2 RSS-GEN Clause 8.9	PASS
3	Conducted Emission Test for AC Power Port	FCC Part 15.207 RSS-GEN Clause 8.8	Pass
4	Antenna Requirement	FCC 15.203 RSS-GEN Clause 6.8	PASS
<p>Note:</p> <p>1. This test report is only published to and used by the applicant, and it is not for evidence purpose in China.</p> <p>2. The measurement result for the sample received is <Pass> according to < CFR 47 FCC PART 15 SUBPART C >> ISED RSS-247 > when <Accuracy Method> decision rule is applied.</p>			



TABLE OF CONTENTS

1. ATTESTATION OF TEST RESULTS	6
2. TEST METHODOLOGY	7
3. FACILITIES AND ACCREDITATION	7
4. CALIBRATION AND UNCERTAINTY	8
4.1. <i>MEASURING INSTRUMENT CALIBRATION</i>	8
4.2. <i>MEASUREMENT UNCERTAINTY</i>	8
5. EQUIPMENT UNDER TEST	9
5.1. <i>DESCRIPTION OF EUT</i>	9
5.2. <i>CHANNEL LIST</i>	10
5.3. <i>DESCRIPTION OF AVAILABLE ANTENNAS</i>	11
5.4. <i>THE WORSE CASE CONFIGURATIONS</i>	11
5.5. <i>DESCRIPTION OF TEST SETUP</i>	12
6. MEASURING INSTRUMENT AND SOFTWARE USED	14
7. ANTENNA PORT TEST RESULTS	16
7.1. <i>ON TIME AND DUTY CYCLE</i>	16
7.2. <i>CONDUCTED OUTPUT POWER</i>	19
8. RADIATED TEST RESULTS	22
8.1. <i>RESTRICTED BANDEDGE</i>	29
8.1.1. 802.11a20 SISO MODE	29
UNII-1 BAND	29
UNII-2A BAND	31
UNII-2C BAND.....	33
UNII-3 BAND	36
8.1.2. 802.11n HT20 MIMO MODE	38
UNII-1 BAND	38
UNII-2A BAND	40
UNII-2C BAND.....	42
UNII-3 BAND	45
8.1.3. 802.11n HT40 MIMO MODE	47
UNII-1 BAND	47
UNII-2A BAND	49
UNII-2C BAND.....	51
UNII-3 BAND	54
8.2. <i>SPURIOUS EMISSIONS (1 GHz ~ 7 GHz)</i>	56
8.2.1. 802.11a20 SISO MODE	56
UNII-1 BAND	56
UNII-2A BAND	62
UNII-2C BAND.....	68



UNII-3 BAND	74
8.3. SPURIOUS EMISSIONS (7 GHz ~ 18 GHz)	80
8.3.1. 802.11a SISO MODE	80
UNII-1 BAND	80
UNII-2A BAND	86
UNII-2C BAND	92
UNII-3 BAND	98
8.3.2. 802.11n HT20 MIMO MODE	104
UNII-1 BAND	104
UNII-2A BAND	110
UNII-2C BAND	116
UNII-3 BAND	122
8.3.3. 802.11n HT40 MIMO MODE	128
UNII-1 BAND	128
UNII-2A BAND	132
UNII-2C BAND	136
UNII-3 BAND	142
8.4. SPURIOUS EMISSIONS FOR SIMULTANEOUS TRANSMISSION	146
8.4.1. 802.11a MODE AND BT MODE WORST CASE	146
8.4.2. 802.11a MODE AND BT MODE WORST CASE	148
8.5. SPURIOUS EMISSIONS (18 GHz ~ 26 GHz)	150
8.5.1. 802.11a MODE AND BT MODE WORST CASE	150
8.6. SPURIOUS EMISSIONS (26 GHz ~ 40 GHz)	152
8.6.1. 802.11a MODE AND BT MODE WORST CASE	152
8.7. SPURIOUS EMISSIONS (30 MHz ~ 1 GHz)	154
8.7.1. 802.11a MODE AND BT MODE WORST CASE	154
8.8. SPURIOUS EMISSIONS BELOW 30 MHz	156
8.8.1. 802.11a MODE AND BT MODE WORST CASE	156
9. AC POWER LINE CONDUCTED EMISSIONS	159
10. ANTENNA REQUIREMENTS	162



1. ATTESTATION OF TEST RESULTS

Applicant Information

Company Name: Hefei BOE Vision-electronic Technology Co.,Ltd.
Address: NO.2177 Dongfang RD, Xinzhan General Pilot Zone HeFei, Anhui, 230012, P.R.China

Manufacturer Information

Company Name: Hefei BOE Vision-electronic Technology Co.,Ltd.
Address: NO.2177 Dongfang RD, Xinzhan General Pilot Zone HeFei, Anhui, 230012, P.R.China

EUT Information

EUT Name: Television
Model: V655-J04
Brand: VIZIO
Sample Received Date: February 25, 2021
Sample Status: Normal
Date of Tested: March 1, 2021 ~ May 6, 2021

APPLICABLE STANDARDS	
STANDARD	TEST RESULTS
CFR 47 FCC PART 15 SUBPART E	PASS
ISED RSS-247 Issue 2	PASS
ISED RSS-GEN Issue 5	PASS

Prepared By:

Denny Huang
Project Engineer
Approved By:

Stephen Guo
Laboratory Manager

Checked By:

Shawn Wen
Laboratory Leader



2. TEST METHODOLOGY

The tests documented in this report were performed in accordance with ANSI C63.10-2013, CFR 47 FCC Part 2, CFR 47 FCC Part 15, KDB 789033 D02 v02r01, RSS-GEN Issue 5, RSS-247 Issue 2, KDB414788 D01 Radiated Test Site v01, KDB 662911 D01 Multiple Transmitter Output v02r01, KDB 484596 D01 Referencing Test Data v01.

3. FACILITIES AND ACCREDITATION

Accreditation Certificate	<p>A2LA (Certificate No.: 4102.01) UL Verification Services (Guangzhou) Co., Ltd. Song Shan Lake Branch. has been assessed and proved to be in compliance with A2LA.</p> <p>FCC (FCC Designation No.: CN1187) UL Verification Services (Guangzhou) Co., Ltd. Song Shan Lake Branch. Has been recognized to perform compliance testing on equipment subject to the Commission's Declaration of Conformity (DoC) and Certification rules</p> <p>ISED (Company No.: 21320) UL Verification Services (Guangzhou) Co., Ltd. Song Shan Lake Branch. has been registered and fully described in a report filed with ISED. The Company Number is 21320 and the test lab Conformity Assessment Body Identifier (CABID) is CN0046.</p> <p>VCCI (Registration No.: G-20019, R-20004, C-20012 and T-20011) UL Verification Services (Guangzhou) Co., Ltd. Song Shan Lake Branch. has been assessed and proved to be in compliance with VCCI, the Membership No. is 3793. Facility Name: Chamber D, the VCCI registration No. is G-20019 and R-20004 Shielding Room B, the VCCI registration No. is C-20012 and T-20011</p>
---------------------------	--

Note 1: All tests measurement facilities use to collect the measurement data are located at Building 10, Innovation Technology Park, Song Shan Lake Hi tech Development Zone, Dongguan, 523808, China

Note 2: The test anechoic chamber in UL Verification Services (Guangzhou) Co., Ltd. Song Shan Lake Branch had been calibrated and compared to the open field sites and the test anechoic chamber is shown to be equivalent to or worst case from the open field site.

Note 3: For below 30 MHz, lab had performed measurements at test anechoic chamber and comparing to measurements obtained on an open field site. And these measurements below 30 MHz had been correlated to measurements performed on an OFS.



4. CALIBRATION AND UNCERTAINTY

4.1. MEASURING INSTRUMENT CALIBRATION

The measuring equipment utilized to perform the tests documented in this report has been calibrated in accordance with the manufacturer's recommendations and is traceable to recognize national standards.

4.2. MEASUREMENT UNCERTAINTY

Where relevant, the following measurement uncertainty levels have been estimated for tests performed on the apparatus:

Test Item	Uncertainty
Conduction Emission	3.62 dB
Radiated Emission (Included Fundamental Emission) (9 kHz ~ 30 MHz)	2.2 dB
Radiated Emission (Included Fundamental Emission) (30 MHz ~ 1 GHz)	4.00 dB
Radiated Emission (Included Fundamental Emission) (1 GHz to 26 GHz)	5.78 dB (1 GHz ~ 18 GHz)
	5.23 dB (18 GHz ~ 26 GHz)
Maximum Conducted Output Power	±0.766 dB

Note: This uncertainty represents an expanded uncertainty expressed at approximately the 95% confidence level using a coverage factor of k=2.



5. EQUIPMENT UNDER TEST

5.1. DESCRIPTION OF EUT

EUT Name	Television
Model	V655-J04
Radio Technology	WLAN (IEEE 802.11a/n HT20/n HT40)
Operation frequency	UNII-1: 5150 ~ 5250 MHz UNII-2A: 5250 ~ 5350 MHz UNII-2C: 5470 ~ 5725 MHz UNII-3: 5725 ~ 5850 MHz
Modulation	IEEE 802.11a: OFDM (64QAM, 16QAM, QPSK, BPSK) IEEE 802.11n HT20: OFDM (64QAM, 16QAM, QPSK, BPSK) IEEE 802.11n HT40: OFDM (64QAM, 16QAM, QPSK, BPSK)
Ratings	AC 120 V, 60 Hz

**5.2. CHANNEL LIST**

UNII-1 (For Bandwidth = 20 MHz)		UNII-1 (For Bandwidth = 40 MHz)	
Channel	Frequency (MHz)	Channel	Frequency (MHz)
36	5180	38	5190
40	5200	46	5230
44	5220		
48	5240		

UNII-2A (For Bandwidth = 20 MHz)		UNII-2A (For Bandwidth = 40 MHz)	
Channel	Frequency (MHz)	Channel	Frequency (MHz)
52	5260	54	5270
56	5280	62	5310
60	5300		
64	5320		

UNII-2C (For Bandwidth = 20 MHz)		UNII-2C (For Bandwidth = 40 MHz)	
Channel	Frequency (MHz)	Channel	Frequency (MHz)
100	5500	102	5510
104	5520	110	5550
108	5540	118	5590
112	5560	126	5630
116	5580	134	5670
120	5600	/	/
124	5620		
128	5640		
132	5660		
136	5680		
140	5700		

UNII-3 (For Bandwidth = 20 MHz)		UNII-3 (For Bandwidth = 40 MHz)	
Channel	Frequency (MHz)	Channel	Frequency (MHz)
149	5745	151	5755
153	5765	159	5795
157	5785		
161	5805		
165	5825		

Note: All channels in the 5600-5650MHz band was not operational in Canada.



5.3. DESCRIPTION OF AVAILABLE ANTENNAS

Antenna	Frequency Band	Antenna Type	Maximum Antenna Gain
			(dBi)
1	UNII-1	PIFA	1.5
2	UNII-1	PIFA	1.5
1	UNII-2A	PIFA	1.5
2	UNII-2A	PIFA	1.5
1	UNII-2C	PIFA	1.5
2	UNII-2C	PIFA	1.5
1	UNII-3	PIFA	1.5
2	UNII-3	PIFA	1.5

IEEE Std. 802.11	Transmit and Receive Mode	Description
a	☒2TX, 2RX	ANT 1, 2 can be used as transmitting/receiving antenna.
n HT20	☒2TX, 2RX	ANT 1, 2 can be used as transmitting/receiving antenna.
n HT40	☒2TX, 2RX	ANT 1, 2 can be used as transmitting/receiving antenna.
Note: 1. Only 802.11n HT20/HT40 support MIMO mode. 2. BT & 2.4 GHz WLAN, BT & 5 GHz WLAN can transmit simultaneously. (Declared by customer.)		

Note: The value of the antenna gain was declared by customer.

5.4. THE WORSE CASE CONFIGURATIONS

For SISO modes, there are two transmission antennas. The antenna used in any given time can be either ANTENNA 1 or ANTENNA 2. The output power measurement for SISO modes on both antennas are reported.

For 2TX MIMO modes, ANTENNA 1 and ANTENNA 2, used at the same time.

SISO mode and MIMO mode have the same power setting, so only the worst-case MIMO mode will be record in the report.

Worst-case data rates as provided by the client were:

802.11a mode: 6 Mbps

802.11n HT20 mode: MCS0

802.11n HT40 mode: MCS0

802.11n HT20/HT40 SISO mode and MIMO mode have the same power setting, so only the worst case MIMO mode will be record in the report.

802.11a support SISO mode, two antennas have the same power setting, so only the worst data for antenna 1 are recorded in the report.



5.5. DESCRIPTION OF TEST SETUP

SUPPORT EQUIPMENT

Item	Equipment	Brand Name	Model Name	Remarks
1	Laptop	Dell	Vostro 3902	/
2	USB Disk	/	/	/
3	DVD	/	DV-410V-K	/
4	Laptop	Lenovo	E42-80	/
5	Laptop	Lenovo	E42-80	/
6	Speaker	/	MS20	/
7	50 Ω Load	/	MS20	/
8	Test fixture	/	/	/
9	Switching Adapter	FLYPOWER	PS65IBCAY5000H	Input: AC 100-240 V, 50/60 Hz, 1.5A Output: DC 12.0 V, 5000 mA

I/O CABLES

Cable No	Port	Cable Type	Cable Length(m)	Remarks
1	USB	Unshielded	1	/
2	HDMI 1	Shielded	1.5	/
3	HDMI 2	Shielded	1.5	/
4	HDMI 3	Shielded	1.5	/
5	OPTICAL	Unshielded	1	/
6	COMPOSITE INPUT	Unshielded	2	/
7	AUDIO OUT	Unshielded	2	/
8	ANTENNA	Unshielded	1	/
9	ETHERNET	Unshielded	1	/

ACCESSORIES

Item	Accessory	Brand Name	Model Name	Description
1	Remote Controller	/	/	/

TEST SETUP

The EUT can work in engineering mode with a software through a Laptop.

SETUP DIAGRAM FOR TESTS

For Conducted Test:

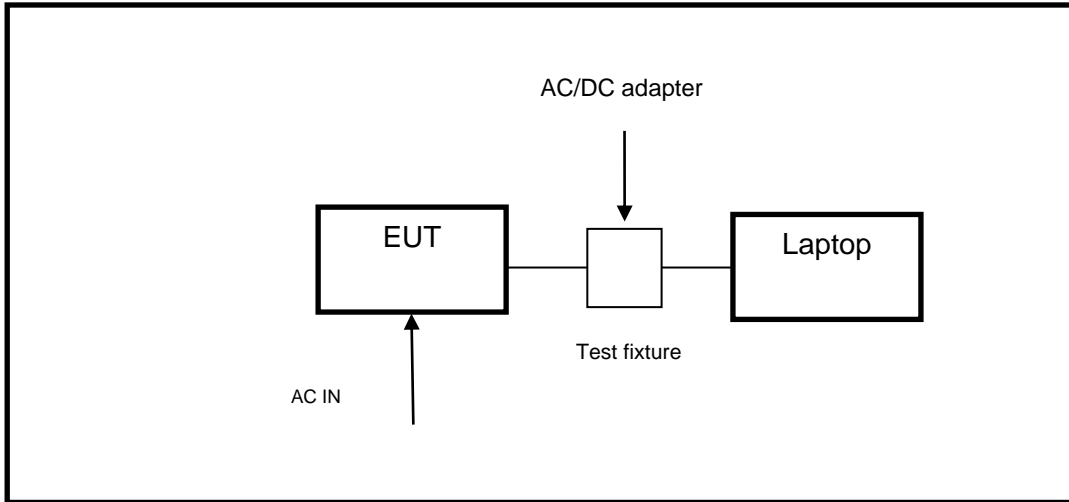

For Radiated Test:

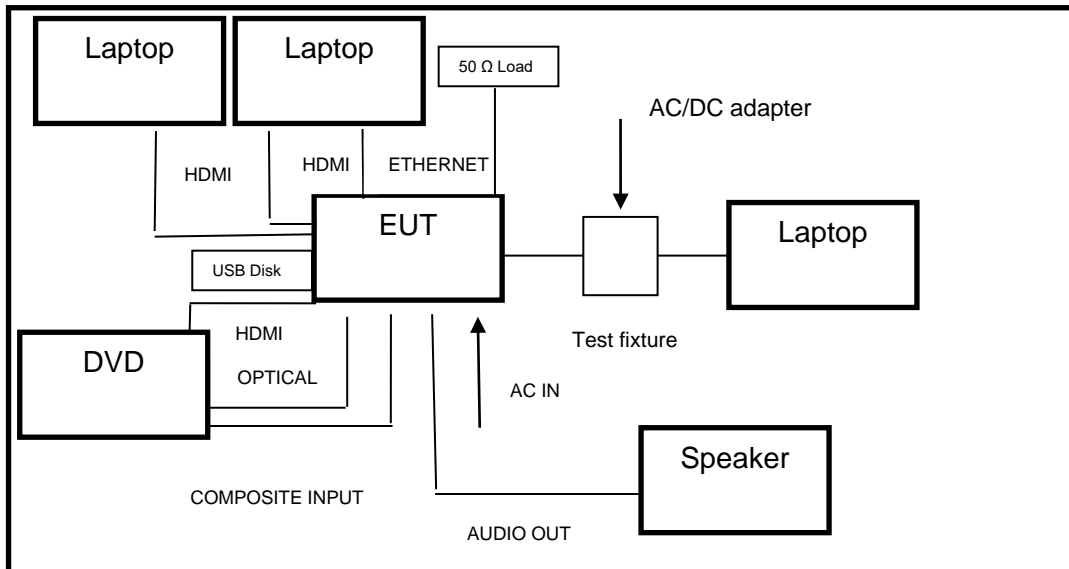

**6. MEASURING INSTRUMENT AND SOFTWARE USED**

Conducted Emissions					
Equipment	Manufacturer	Model No.	Serial No.	Last Cal.	Due Date
EMI Test Receiver	R&S	ESR3	101961	Nov. 12, 2020	Nov. 11, 2021
Two-Line V-Network	R&S	ENV216	101983	Nov. 12, 2020	Nov. 11, 2021
Software					
Description		Manufacturer	Name	Version	
Test Software for Conducted Emissions		Farad	EZ-EMC	Ver. UL-3A1	
Radiated Emissions					
Equipment	Manufacturer	Model No.	Serial No.	Last Cal.	Due Date
MXE EMI Receiver	KESIGHT	N9038A	MY56400036	Nov. 12, 2020	Nov. 11, 2021
Hybrid Log Periodic Antenna	TDK	HLP-3003C	130960	Aug. 11, 2018	Aug. 10, 2021
Preamplifier	HP	8447D	2944A09099	Nov. 12, 2020	Nov. 11, 2021
EMI Measurement Receiver	R&S	ESR26	101377	Nov. 12, 2020	Nov. 11, 2021
Horn Antenna	TDK	HRN-0118	130939	Sept. 17, 2018	Sept. 17, 2021
Preamplifier	TDK	PA-02-0118	TRS-305-00067	Nov. 20, 2020	Nov. 19, 2021
Horn Antenna	Schwarzbeck	BBHA9170	#691	Aug. 11, 2018	Aug. 11, 2021
Preamplifier	TDK	PA-02-2	TRS-307-00003	Nov. 12, 2020	Nov. 11, 2021
Loop antenna	Schwarzbeck	1519B	00008	Jan.17, 2019	Jan.17,2022
Preamplifier	Mini-Circuits	ZX60-83LN-S+	SUP01201941	Nov. 20, 2020	Nov. 19, 2021
High Pass Filter	Wi	WHKX10-2700-3000-18000-40SS	23	Nov. 12, 2020	Nov. 11, 2021
Band Reject Filter	Wainwright	WRCJV8-2350-2400-2483.5-2533.5-40SS	4	Nov. 12, 2020	Nov. 11, 2021
Software					
Description		Manufacturer	Name	Version	
Test Software for Radiated Emissions		Farad	EZ-EMC	Ver. UL-3A1	



Other Instruments					
Equipment	Manufacturer	Model No.	Serial No.	Last Cal.	Next Cal.
Dual Channel Power Meter	Keysight	N1912A	MY55416024	Nov. 20, 2020	Nov. 19, 2021
Power Sensor	Keysight	USB Wideband Power Sensor	MY5100022	Nov. 20, 2020	Nov. 19, 2021

7. ANTENNA PORT TEST RESULTS

7.1. ON TIME AND DUTY CYCLE

LIMITS

None; for reporting purposes only.

PROCEDURE

Refer to KDB 789033 D02 General U-NII Test Procedures New Rules v02r01 section II.B.

The zero-span mode on a spectrum analyzer or EMI receiver, if the response time and spacing between bins on the sweep are sufficient to permit accurate measurements of the on and off times of the transmitted signal. Set the center frequency of the instrument to the center frequency of the transmission. Set $RBW \geq EBW$ if possible; otherwise, set RBW to the largest available value. Set $VBW \geq RBW$. Set detector = peak or average. The zero-span measurement method shall not be used unless both RBW and VBW are $> 50/T$, where T is defined in II.B.1.a), and the number of sweep points across duration T exceeds 100. (For example, if VBW and/or RBW are limited to 3 MHz, then the zero-span method of measuring duty cycle shall not be used if $T \leq 16.7$ microseconds.)

TEST SETUP

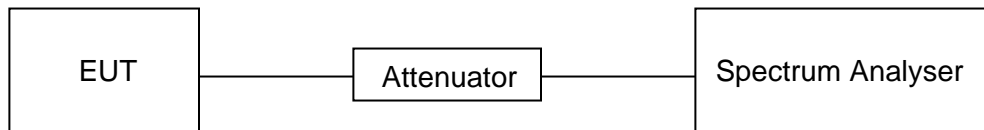

TEST ENVIRONMENT

Temperature	22.8 °C	Relative Humidity	64.3 %
Atmosphere Pressure	101 kPa	Test Voltage	AC 120 V

RESULTS



Mode	On Time (msec)	Period (msec)	Duty Cycle x (Linear)	Duty Cycle (%)	Duty Cycle Correction Factor (db)	1/T Minimum VBW (kHz)	Final setting For VBW (Hz)
11a	100	100	1	100	0	0.01	10
11n HT20	100	100	1	100	0	0.01	10
11n HT40	100	100	1	100	0	0.01	10

Note:
 Duty Cycle Correction Factor=10log(1/x).
 Where: x is Duty Cycle (Linear)
 Where: T is On Time (transmit duration)
 If that calculated VBW is not available on the analyzer then the next higher value should be used.

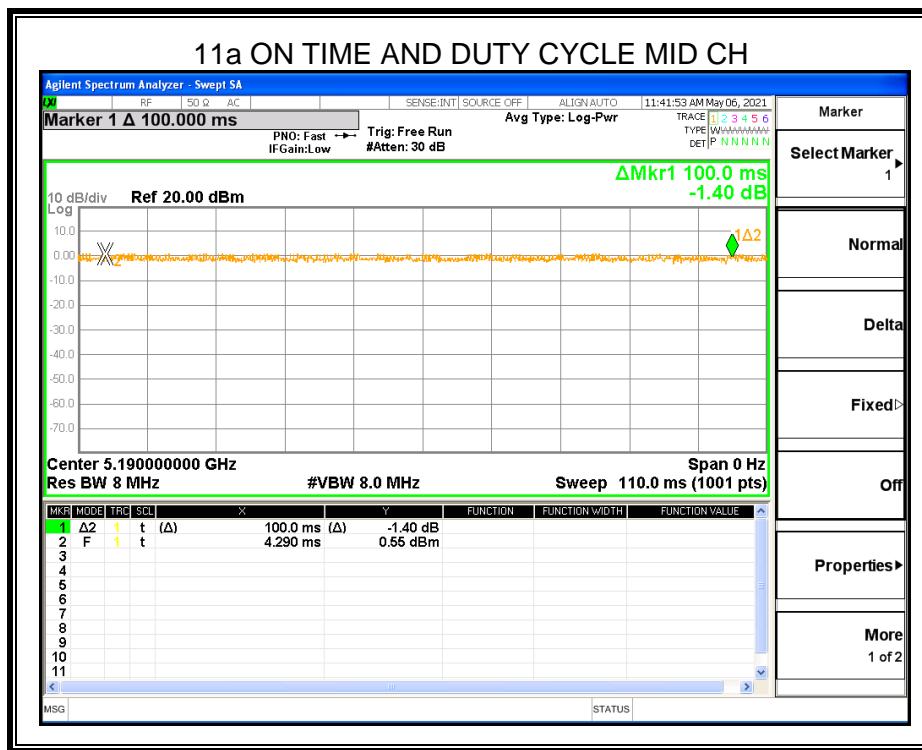

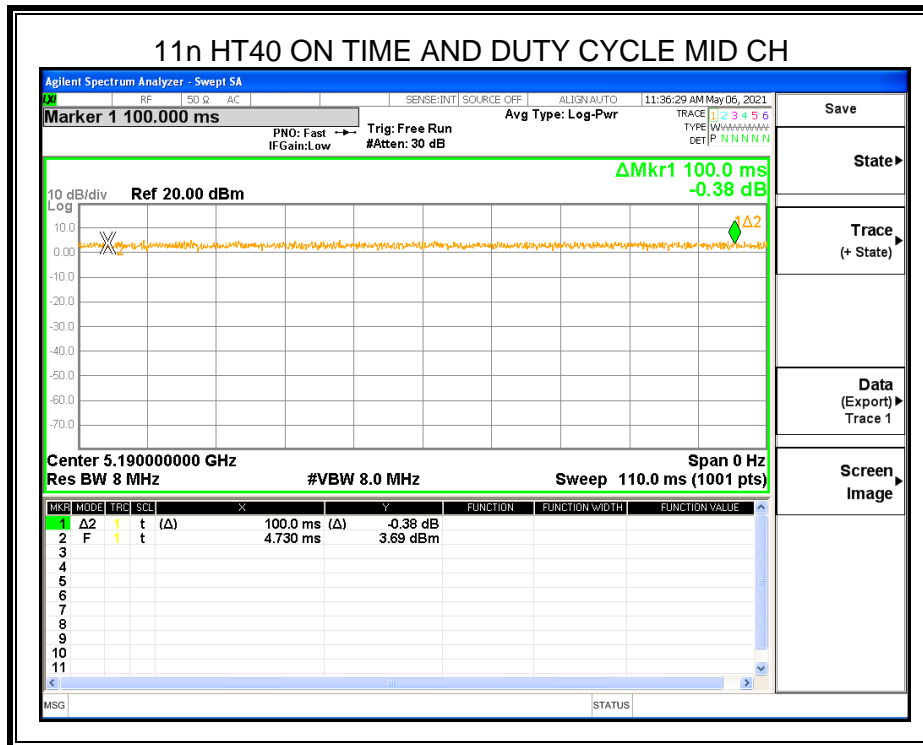
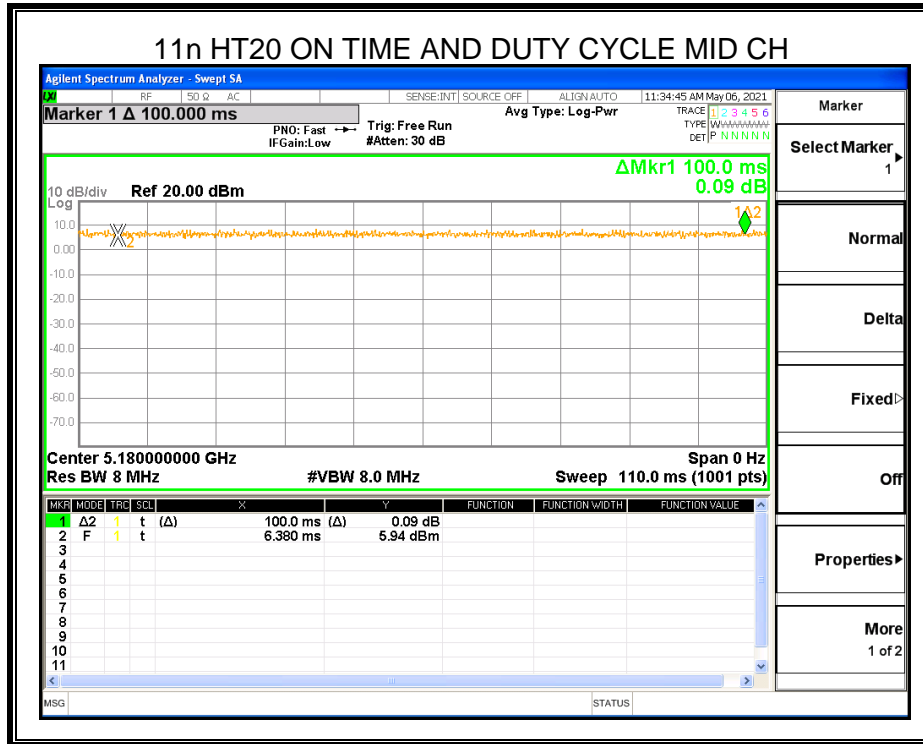



7.2. CONDUCTED OUTPUT POWER

LIMITS

CFR 47 FCC Part15, Subpart E		
Test Item	Limit	Frequency Range (MHz)
Conducted Output Power	<input type="checkbox"/> Outdoor Access Point: 1 W (30 dBm) <input type="checkbox"/> Indoor Access Point: 1 W (30 dBm) <input type="checkbox"/> Fixed Point-To-Point Access Points: 1 W (30 dBm) <input checked="" type="checkbox"/> Client Devices: 250 mW (24 dBm)	5150 ~ 5250
	Shall not exceed the lesser of 250 mW (24dBm) or 11 dBm + 10 log B, where B is the 26 dB emission bandwidth in megahertz.	5250 ~ 5350 5470 ~ 5725
	Shall not exceed 1 Watt (30 dBm).	5725 ~ 5850

ISED RSS-247 ISSUE 2		
Test Item	Limit	Frequency Range (MHz)
Conducted Output Power or e.i.r.p.	The maximum e.i.r.p. shall not exceed 200 mW (23 dBm) or 10 + 10 log ₁₀ B, dBm, whichever power is less. B is the 99 % emission bandwidth in megahertz.	5150 ~ 5250
	a. The maximum conducted output power shall not exceed 250 mW (24 dBm) or 11 + 10 log ₁₀ B dBm, whichever is less. b. The maximum e.i.r.p. shall not exceed 1.0 W (30 dBm) or 17 + 10 log ₁₀ B dBm, whichever is less. B is the 99 % emission bandwidth in megahertz. Note that devices with a maximum e.i.r.p. greater than 500 mW shall implement TPC in order to have the capability to operate at least 6 dB below the maximum permitted e.i.r.p. of 1 W.	5250 ~ 5350 5470 ~ 5600 5650 ~ 5725
	Shall not exceed 1 Watt (30 dBm). The e.i.r.p. shall not exceed 4 W	5725 ~ 5850

Note:

The above limits are based upon the maximum antenna gain does not exceed 6 dBi. If transmitting antennas of directional gain greater than 6 dBi are used, the maximum conducted output power shall be reduced by the amount in dB that the directional gain of the antenna exceeds 6 dBi.

TEST PROCEDURE

Refer to KDB 789033 D02 General U-NII Test Procedures New Rules v02r01 section II.E.

Method SA-1 (trace averaging with the EUT transmitting at full power throughout each sweep):

- (i) Set span to encompass the entire emission bandwidth (EBW) (or, alternatively, the entire 99% occupied bandwidth) of the signal.
- (ii) Set RBW = 1 MHz.
- (iii) Set VBW \geq 3 MHz.
- (iv) Number of points in sweep $\geq 2 \times \text{span} / \text{RBW}$. (This ensures that bin-to-bin spacing is $\leq \text{RBW}/2$, so that narrowband signals are not lost between frequency bins.)
- (v) Sweep time = auto.
- (vi) Detector = power averaging (rms), if available. Otherwise, use sample detector mode.
- (vii) If transmit duty cycle $< 98\%$, use a video trigger with the trigger level set to enable triggering only on full power pulses. Transmitter must operate at maximum power control level for the entire duration of every sweep. If the EUT transmits continuously (i.e., with no off intervals) or at duty cycle $\geq 98\%$, and if each transmission is entirely at the maximum power control level, then the trigger shall be set to "free run."
- (viii) Trace average at least 100 traces in power averaging (rms) mode.
- (ix) Compute power by integrating the spectrum across the EBW (or, alternatively, the entire 99% occupied bandwidth) of the signal using the instrument's band power measurement function with band limits set equal to the EBW (or occupied bandwidth) band edges. If the instrument does not have a band power function, sum the spectrum levels (in power units) at 1 MHz intervals extending across the EBW (or, alternatively, the entire 99% occupied bandwidth) of the spectrum.

Method PM (Measurement using an RF average power meter):

- (i) Measurements may be performed using a wideband RF power meter with a thermocouple detector or equivalent if all of the following conditions are satisfied:
 - a. The EUT is configured to transmit continuously or to transmit with a constant duty cycle.
 - b. At all times when the EUT is transmitting, it must be transmitting at its maximum power control level.
 - c. The integration period of the power meter exceeds the repetition period of the transmitted signal by at least a factor of five.
- (ii) If the transmitter does not transmit continuously, measure the duty cycle, x , of the transmitter output signal as described in II.B.
- (iii) Measure the average power of the transmitter. This measurement is an average over both the on and off periods of the transmitter.
- (iv) Adjust the measurement in dBm by adding $10 \log (1/x)$ where x is the duty cycle (e.g., $10 \log (1/0.25)$ if the duty cycle is 25 %).

Method PM-G (Measurement using a gated RF average power meter):

Measurements may be performed using a wideband gated RF power meter provided that the gate parameters are adjusted such that the power is measured only when the EUT is transmitting at its maximum power control level. Since the measurement is made only during the ON time of the transmitter, no duty cycle correction factor is required.

Straddle channel power was measured using spectrum analyzer.

TEST SETUP

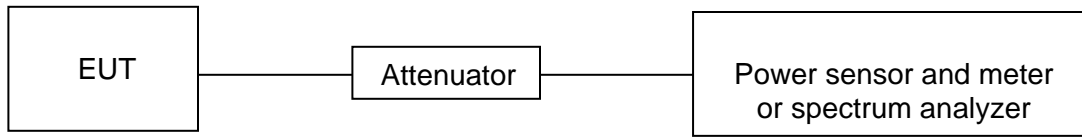

TEST ENVIRONMENT

Temperature	23.6 °C	Relative Humidity	67.2 %
Atmosphere Pressure	101 kPa	Test Voltage	AC 120 V

RESULTS

Spot Check Verification Result:

Test Item	Test Mode	Frequency	Antenna	Worst Case Test Result	
				Original Model	Spot Check Model
Conducted AV Power	802.11g	5700 MHz	0	14.14 dBm	14.13 dBm
			1	13.96 dBm	13.94 dBm
	802.11n HT20	5580 MHz	0	13.42 dBm	13.37 dBm
			1	12.68 dBm	12.64 dBm
	802.11n HT40	5550 MHz	0	13.68 dBm	13.64 dBm
			1	12.67 dBm	12.64 dBm

Conclusion:

The spot check test result show that the new devices still comply with the standard and the new test result was close to the original test result, so it can demonstrate that the referenced test data remains valid for the new device.

8. RADIATED TEST RESULTS

LIMITS

Refer to CFR 47 FCC §15.205, §15.209 and §15.407 (b).

Refer to ISED RSS-GEN Clause 8.9, Clause 8.10 and ISED RSS-247 6.2.

Radiation Disturbance Test Limit for FCC (Class B) (9 kHz ~ 1 GHz)

Emissions radiated outside of the specified frequency bands above 30 MHz			
Frequency Range (MHz)	Field Strength Limit (uV/m) at 3 m	Field Strength Limit (dBuV/m) at 3 m	
		Quasi-Peak	
30 - 88	100	40	
88 - 216	150	43.5	
216 - 960	200	46	
Above 960	500	54	
Above 1000	500	Peak	Average
		74	54

FCC Emissions radiated outside of the specified frequency bands below 30 MHz		
Frequency (MHz)	Field strength (microvolts/meter)	Measurement distance (meters)
0.009-0.490	2400/F(kHz)	300
0.490-1.705	24000/F(kHz)	30
1.705-30.0	30	30

ISED General field strength limits at frequencies below 30 MHz

Table 6 – General field strength limits at frequencies below 30 MHz		
Frequency	Magnetic field strength (H-Field) (µA/m)	Measurement distance (m)
9 - 490 kHz ^{Note 1}	6.37/F (F in kHz)	300
490 - 1705 kHz	63.7/F (F in kHz)	30
1.705 - 30 MHz	0.08	30

Note 1: The emission limits for the ranges 9-90 kHz and 110-490 kHz are based on measurements employing a linear average detector.



ISED Restricted bands refer to ISED RSS-GEN Clause 8.10

Table 7 – Restricted frequency bands ^{Note 1}		
MHz	MHz	GHz
0.090 - 0.110	149.9 - 150.05	9.0 - 9.2
0.495 - 0.505	156.52475 - 156.52525	9.3 - 9.5
2.1735 - 2.1905	156.7 - 156.9	10.8 - 12.7
3.020 - 3.028	162.0125 - 167.17	13.25 - 13.4
4.125 - 4.128	167.72 - 173.2	14.47 - 14.5
4.17725 - 4.17775	240 - 285	15.35 - 16.2
4.20725 - 4.20775	322 - 335.4	17.7 - 21.4
5.677 - 5.683	399.9 - 410	22.01 - 23.12
6.215 - 6.218	608 - 614	23.6 - 24.0
6.26775 - 6.26825	960 - 1427	31.2 - 31.8
6.31175 - 6.31225	1435 - 1626.5	36.43 - 36.5
8.291 - 8.294	1645.5 - 1646.5	Above 38.6
8.362 - 8.366	1660 - 1710	
8.37625 - 8.38675	1718.8 - 1722.2	
8.41425 - 8.41475	2200 - 2300	
12.29 - 12.293	2310 - 2390	
12.51975 - 12.52025	2483.5 - 2500	
12.57675 - 12.57725	2655 - 2900	
13.36 - 13.41	3260 - 3267	
16.42 - 16.423	3332 - 3339	
16.69475 - 16.69525	3345.8 - 3358	
16.80425 - 16.80475	3600 - 4400	
25.5 - 25.67	4500 - 5150	
37.5 - 38.25	5350 - 5460	
73 - 74.6	7250 - 7750	
74.8 - 75.2	8025 - 8500	
108 - 138		

Note 1: Certain frequency bands listed in table 7 and in bands above 38.6 GHz are designated for licence-exempt applications. These frequency bands and the requirements that apply to related devices are set out in the 200 and 300 series of RSSs.

FCC Restricted bands of operation refer to FCC §15.205 (a):

MHz	MHz	MHz	GHz
0.090-0.110	16.42-16.423	399.9-410	4.5-5.15
¹ 0.495-0.505	16.69475-16.69525	608-614	5.35-5.46
2.1735-2.1905	16.80425-16.80475	960-1240	7.25-7.75
4.125-4.128	25.5-25.67	1300-1427	8.025-8.5
4.17725-4.17775	37.5-38.25	1435-1626.5	9.0-9.2
4.20725-4.20775	73-74.6	1645.5-1646.5	9.3-9.5
6.215-6.218	74.8-75.2	1660-1710	10.6-12.7
6.26775-6.26825	108-121.94	1718.8-1722.2	13.25-13.4
6.31175-6.31225	123-138	2200-2300	14.47-14.5
8.291-8.294	149.9-150.05	2310-2390	15.35-16.2
8.362-8.366	156.52475-156.52525	2483.5-2500	17.7-21.4
8.37625-8.38675	156.7-156.9	2690-2900	22.01-23.12
8.41425-8.41475	162.0125-167.17	3260-3267	23.6-24.0
12.29-12.293	167.72-173.2	3332-3339	31.2-31.8
12.51975-12.52025	240-285	3345.8-3358	36.43-36.5
12.57675-12.57725	322-335.4	3600-4400	(²)
13.36-13.41			

Note: ¹Until February 1, 1999, this restricted band shall be 0.490-0.510 MHz.

²Above 38.6c



Limits of unwanted/undesirable emission out of the restricted bands refer to CFR 47 FCC §15.407 (b) and ISED RSS-247 6.2.

LIMITS OF RADIATED EMISSION MEASUREMENT (Above 1GHz)		
Frequency Range (MHz)	EIRP Limit	Field Strength Limit (dBuV/m) at 3 m
5150~5250 MHz	PK: -27 (dBm/MHz)	PK:68.2(dBμV/m)
5250~5350 MHz		
5470~5725 MHz		
5725~5850 MHz	PK: -27 (dBm/MHz) *1 PK: 10 (dBm/MHz) *2 PK: 15.6 (dBm/MHz) *3 PK: 27 (dBm/MHz) *4	PK: 68.2(dBμV/m) *1 PK: 105.2 (dBμV/m) *2 PK: 110.8(dBμV/m) *3 PK: 122.2 (dBμV/m) *4
<p>Note:</p> <p>*1 beyond 75 MHz or more above of the band edge.</p> <p>*2 below the band edge increasing linearly to 10 dBm/MHz at 25 MHz above.</p> <p>*3 below the band edge increasing linearly to a level of 15.6 dBm/MHz at 5 MHz above.</p> <p>*4 from 5 MHz above or below the band edge increasing linearly to a level of 27 dBm/MHz at the band edge.</p>		

TEST SETUP AND PROCEDURE

Below 30 MHz

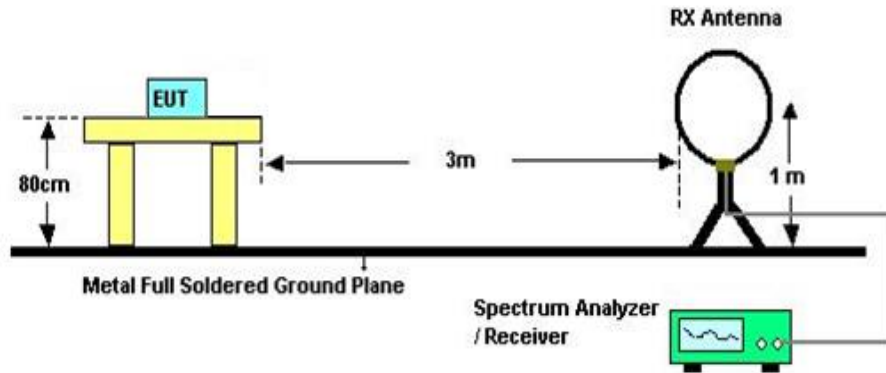

The setting of the spectrum analyser

RBW	200 Hz (From 9 kHz to 0.15 MHz)/ 9 kHz (From 0.15 MHz to 30 MHz)
VBW	200 Hz (From 9 kHz to 0.15 MHz)/ 9 kHz (From 0.15 MHz to 30 MHz)
Sweep	Auto
Trace	Max hold

1. The testing follows the guidelines in ANSI C63.10-2013 clause 11.11 & 11.12.
2. The EUT was arranged to its worst case and then turntable (from 0 degree to 360 degrees) to find the maximum reading. A pre-amp and a high pass filter are used for the test in order to get better signal level. Both Horizontal, Face-on and Face-off polarizations of the antenna are set to make the measurement.
3. The EUT was placed on a turntable with 80 cm above ground.
4. The EUT was set 3 meters from the interference receiving antenna, which was mounted on the top of a 1 m height antenna tower.
5. The radiated emission limits are based on measurements employing a CISPR quasi-peak detector except for the frequency bands 9-90 kHz, 110-490 kHz and above 1000 MHz. Radiated emission limits in these three bands are based on measurements employing an average detector.
6. For measurement below 1 GHz, the initial step in collecting conducted emission data is a spectrum analyzer peak detector mode pre-scanning the measurement frequency range. Significant peaks are then marked and then Quasi Peak and average detector mode re-measured. If the emission level of the EUT measured by the peak detector is 3 dB lower than the applicable limit, the peak emission level will be reported. Otherwise, the emission measurement will be repeated using the quasi-peak and average detector and reported.
7. Although these tests were performed other than open field site, adequate comparison measurements were confirmed against 30 m open field site. Therefore sufficient tests were made to demonstrate that the alternative site produces results that correlate with the ones of tests made in an open field site based on KDB 414788.

Below 1 GHz and above 30 MHz

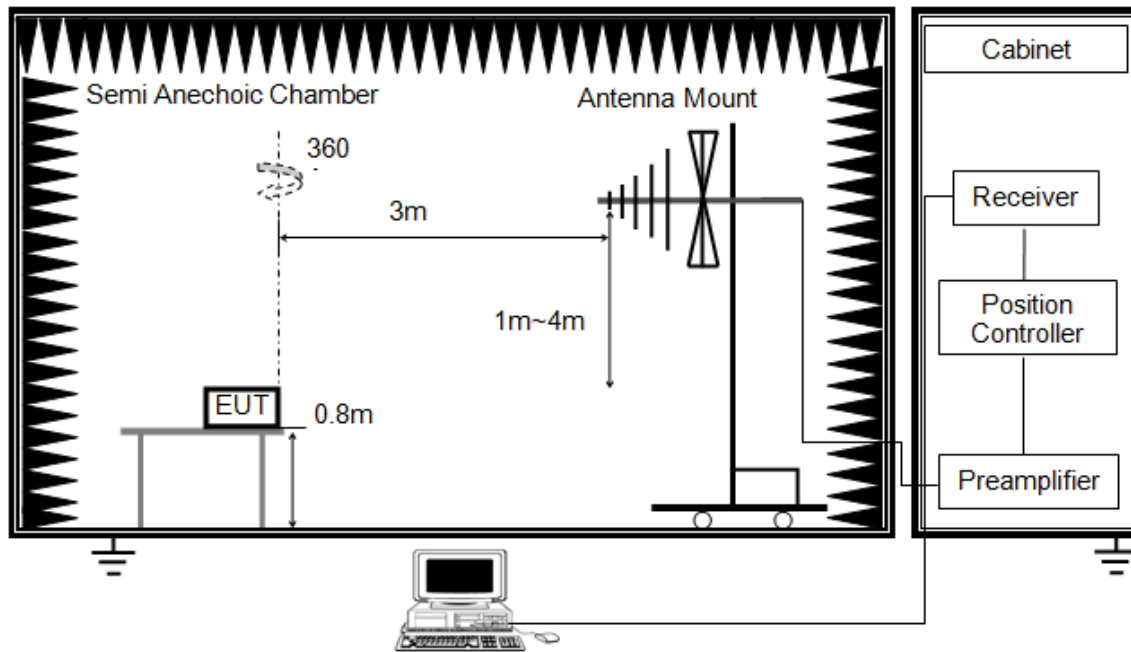

The setting of the spectrum analyser

RBW	120 kHz
VBW	300 kHz
Sweep	Auto
Detector	Peak/QP
Trace	Max hold

1. The testing follows the guidelines in ANSI C63.10-2013 clause 11.11 & 11.12.
2. The EUT was arranged to its worst case and then tune the antenna tower (from 1 m to 4 m) and turntable (from 0 degree to 360 degrees) to find the maximum reading. A pre-amp and a high pass filter are used for the test in order to get better signal level. Both horizontal and vertical polarizations of the antenna are set to make the measurement.
3. The EUT was placed on a turntable with 80 cm above ground.
4. The EUT was set 3 meters from the interference receiving antenna, which was mounted on the top of a variable height antenna tower.
5. For measurement below 1 GHz, the initial step in collecting conducted emission data is a spectrum analyzer peak detector mode pre-scanning the measurement frequency range. Significant peaks are then marked and then Quasi Peak detector mode re-measured. If the emission level of the EUT measured by the peak detector is 3 dB lower than the applicable limit, the peak emission level will be reported. Otherwise, the emission measurement will be repeated using the quasi-peak detector and reported.

Above 1 GHz

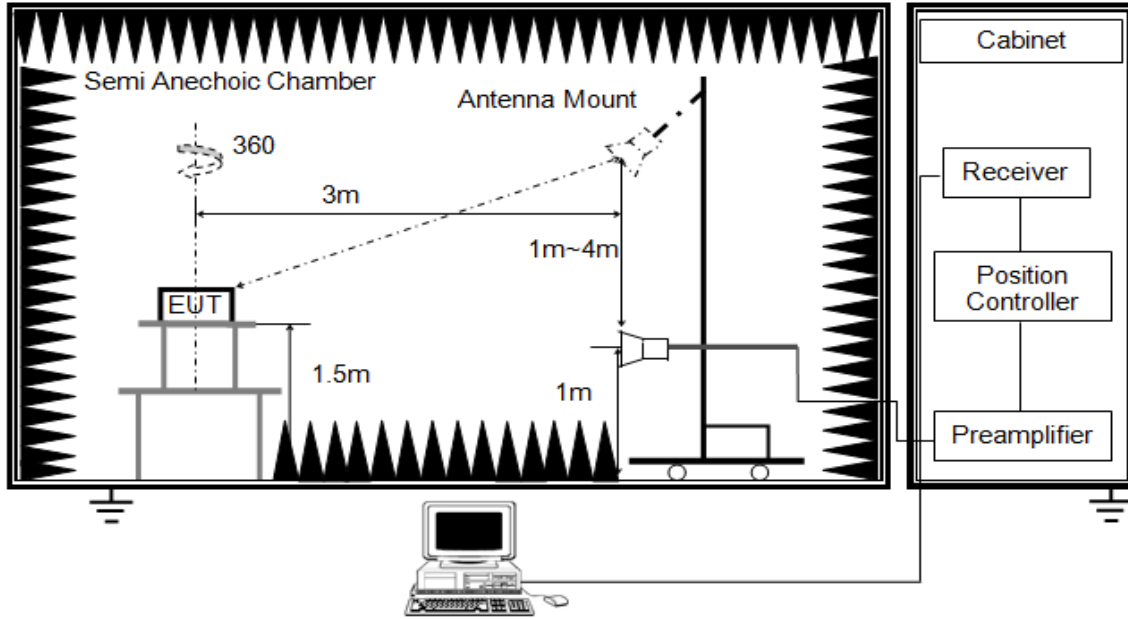

The setting of the spectrum analyser

RBW	1 MHz
VBW	PEAK: 3 MHz AVG: see note 6
Sweep	Auto
Detector	Peak
Trace	Max hold

1. The testing follows the guidelines in KDB 789033 D02 General U-NII Test Procedures New Rules v02r01 section II.G.3 ~ II.G.6.
2. The EUT was arranged to its worst case and then tune the antenna tower (1.5 m) and turntable (from 0 degree to 360 degrees) to find the maximum reading. A pre-amp and a high pass filter are used for the test in order to get better signal level. Both horizontal and vertical polarizations of the antenna are set to make the measurement.
3. The EUT was placed on a turntable with 1.5 m above ground.
4. The EUT was set 3 meters from the interference receiving antenna, which was mounted on the top of a variable height antenna tower.
5. For measurement above 1 GHz, the emission measurement will be measured by the peak detector. This peak level, once corrected, must comply with the limit specified in Section 15.209.
6. For measurements above 1 GHz the resolution bandwidth is set to 1 MHz, then the video bandwidth is set to 3 MHz for peak measurements and 1 MHz resolution bandwidth with 1/T video bandwidth with peak detector for average measurements. For the Duty Cycle please refer to clause 7.1.ON TIME AND DUTY CYCLE.



Note 1: The EUT was fully exercised with external accessories during the test. In the case of multiple accessory external ports, an external accessory shall be connected to one of each type of port.

Note 2: Simultaneous transmission had been evaluated with the 5 GHz WLAN / 2.4 GHz WLAN and BT / BLE transmitter and has no additional or worse emissions found. Only the worst data was recorded in the test report.

TEST ENVIRONMENT

Temperature	22.6 °C	Relative Humidity	64.4 %
Atmosphere Pressure	101 kPa	Test Voltage	AC 120 V

RESULTS



8.1. RESTRICTED BANDEDGE

8.1.1. 802.11a20 SISO MODE

ANTENNA 1 TEST RESULTS (WORST CASE)

UNII-1 BAND

RESTRICTED BANDEDGE (LOW CHANNEL, HORIZONTAL)

PEAK

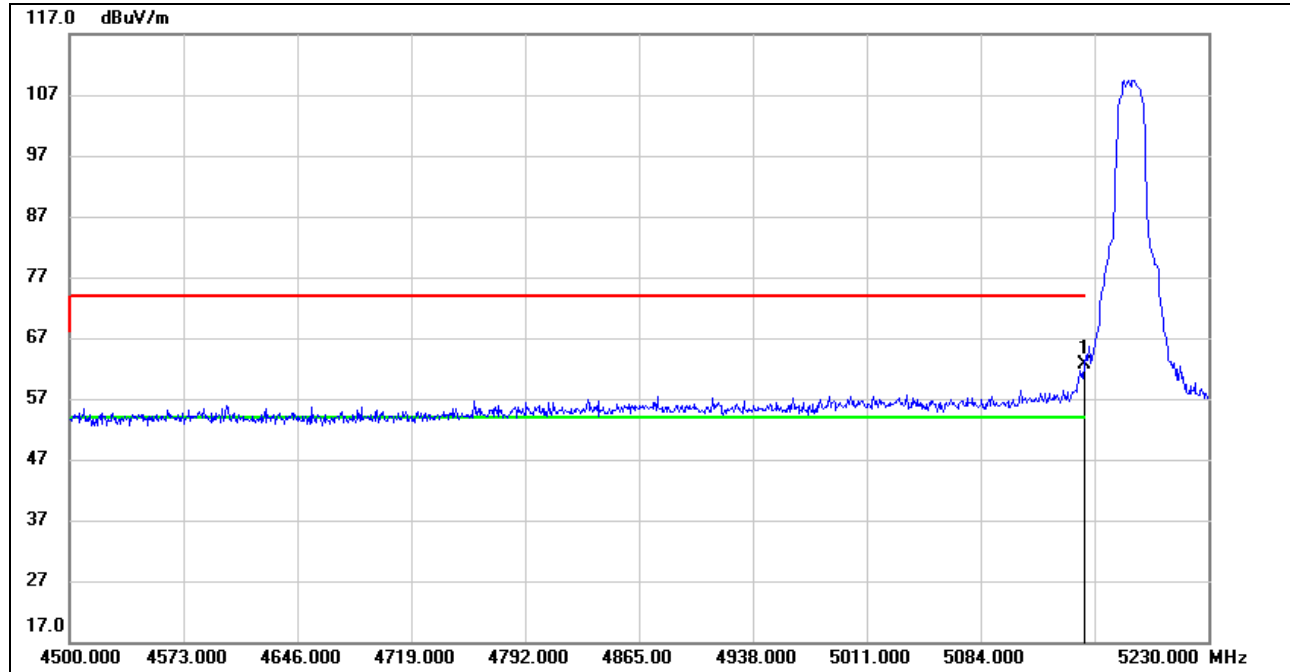

No.	Frequency (MHz)	Reading (dBuV)	Correct (dB/m)	Result (dBuV/m)	Limit (dBuV/m)	Margin (dB)	Remark
1	5150.000	21.53	41.19	62.72	74.00	-11.28	peak

- Note:
1. Measurement = Reading Level + Correct Factor.
 2. If Peak Result complies with AV limit, AV Result is deemed to comply with AV limit.
 3. Peak: Peak detector.
 4. Only the worst data was recorded, if it complies with the limit, the other emissions deemed to comply with the limit.



AVG

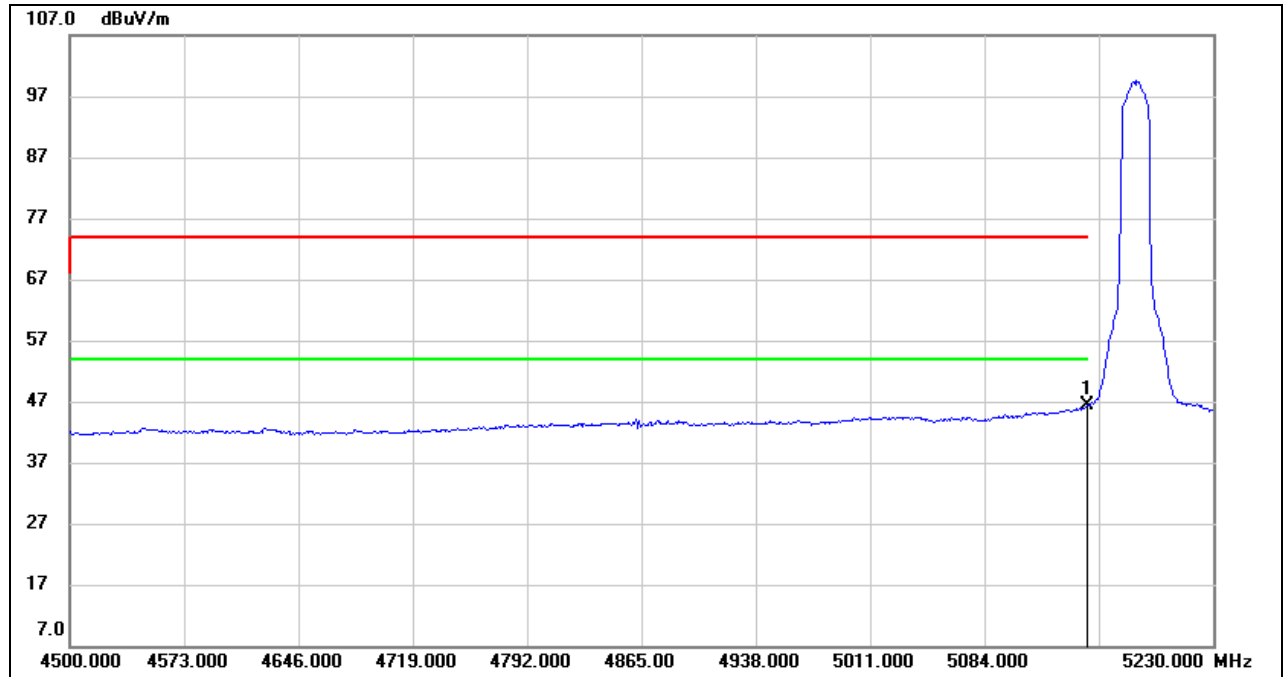

No.	Frequency (MHz)	Reading (dBuV)	Correct (dB/m)	Result (dBuV/m)	Limit (dBuV/m)	Margin (dB)	Remark
1	5150.000	5.08	41.19	46.27	54.00	-7.73	AVG

- Note:
1. Measurement = Reading Level + Correct Factor.
 2. If Peak Result complies with AV limit, AV Result is deemed to comply with AV limit.
 3. AVG: $VBW=1/Ton$, where: Ton is the transmitting duration.
 4. For the transmitting duration, please refer to clause 7.1.
 5. Only the worst data was recorded, if it complies with the limit, the other emissions deemed to comply with the limit.

UNII-2A BAND

RESTRICTED BANDEDGE (HIGH CHANNEL, HORIZONTAL)

PEAK

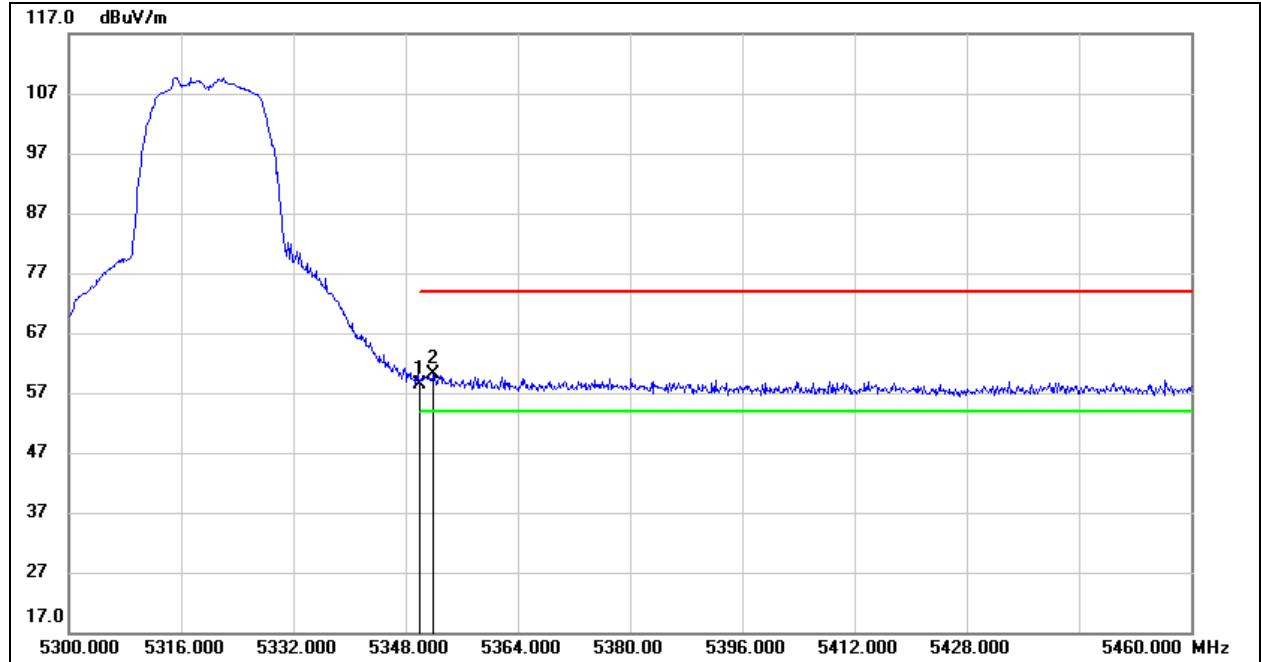

No.	Frequency (MHz)	Reading (dBuV)	Correct (dB/m)	Result (dBuV/m)	Limit (dBuV/m)	Margin (dB)	Remark
1	5350.000	17.15	41.20	58.35	74.00	-15.65	peak
2	5352.000	18.81	41.21	60.02	74.00	-13.98	peak

Note: 1. Measurement = Reading Level + Correct Factor.
 2. If Peak Result complies with AV limit, AV Result is deemed to comply with AV limit.
 3. Peak: Peak detector.
 4. Only the worst data was recorded, if it complies with the limit, the other emissions deemed to comply with the limit.



AVG

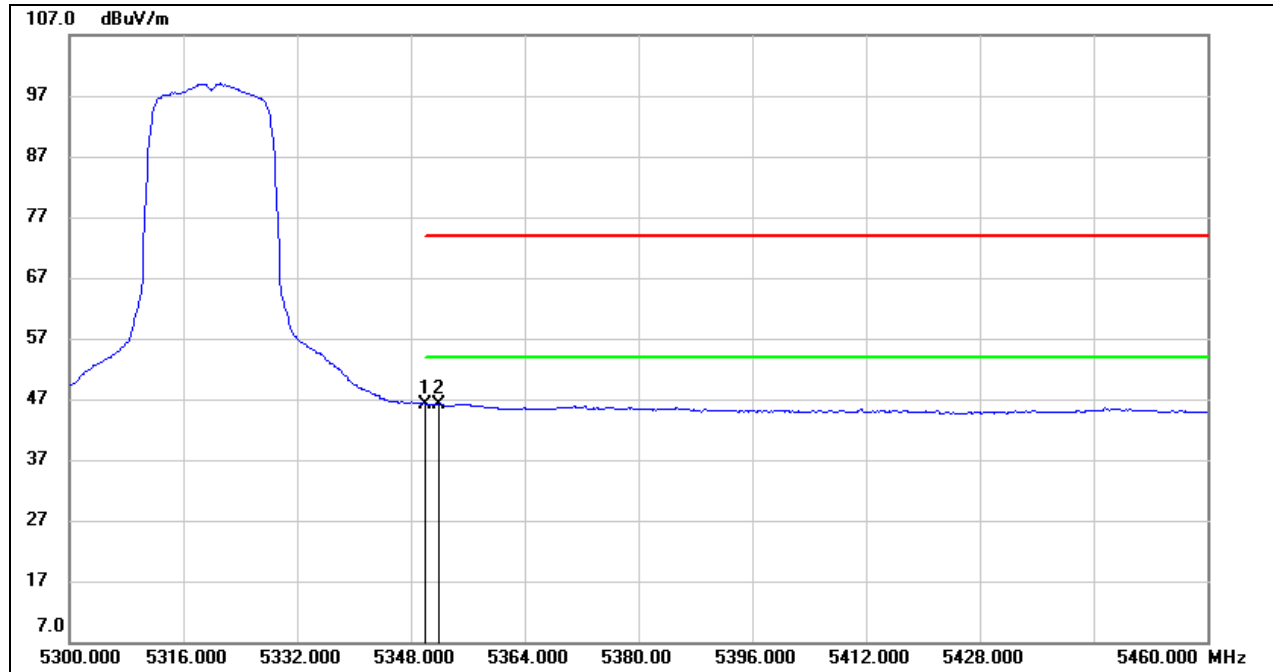

No.	Frequency (MHz)	Reading (dBuV)	Correct (dB/m)	Result (dBuV/m)	Limit (dBuV/m)	Margin (dB)	Remark
1	5350.000	4.99	41.20	46.19	54.00	-7.81	AVG
2	5352.000	4.97	41.21	46.18	54.00	-7.82	AVG

- Note:
1. Measurement = Reading Level + Correct Factor.
 2. If Peak Result complies with AV limit, AV Result is deemed to comply with AV limit.
 3. AVG: $VBW=1/Ton$, where: Ton is the transmitting duration.
 4. For the transmitting duration, please refer to clause 7.1.
 5. Only the worst data was recorded, if it complies with the limit, the other emissions deemed to comply with the limit.

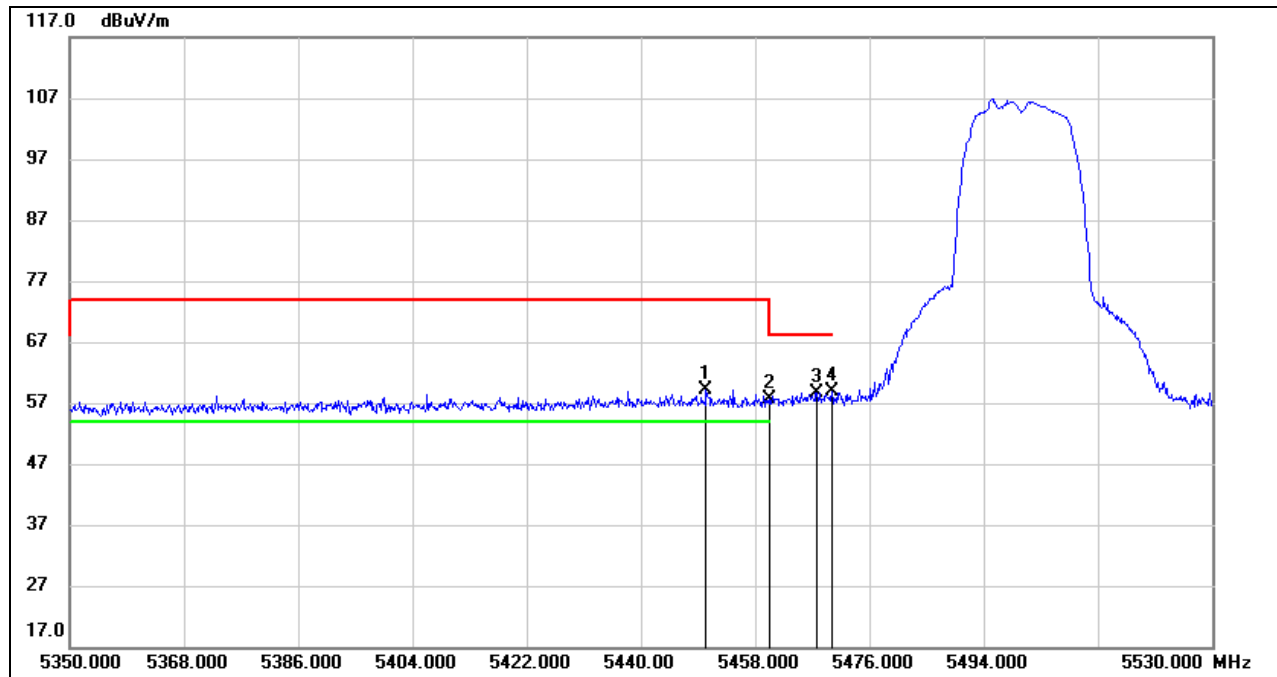
UNII-2C BAND
RESTRICTED BANDEDGE (LOW CHANNEL, HORIZONTAL)
PEAK

No.	Frequency (MHz)	Reading (dBuV)	Correct (dB/m)	Result (dBuV/m)	Limit (dBuV/m)	Margin (dB)	Remark
1	5450.260	17.44	41.77	59.21	74.00	-14.79	peak
2	5460.000	15.79	41.82	57.61	74.00	-16.39	peak
3	5467.720	16.81	41.86	58.67	68.20	-9.53	peak
4	5470.000	16.99	41.87	58.86	68.20	-9.34	peak

Note: 1. Measurement = Reading Level + Correct Factor.

2. If Peak Result complies with AV limit, AV Result is deemed to comply with AV limit.

3. Peak: Peak detector.

4. Only the worst data was recorded, if it complies with the limit, the other emissions deemed to comply with the limit.

AVG

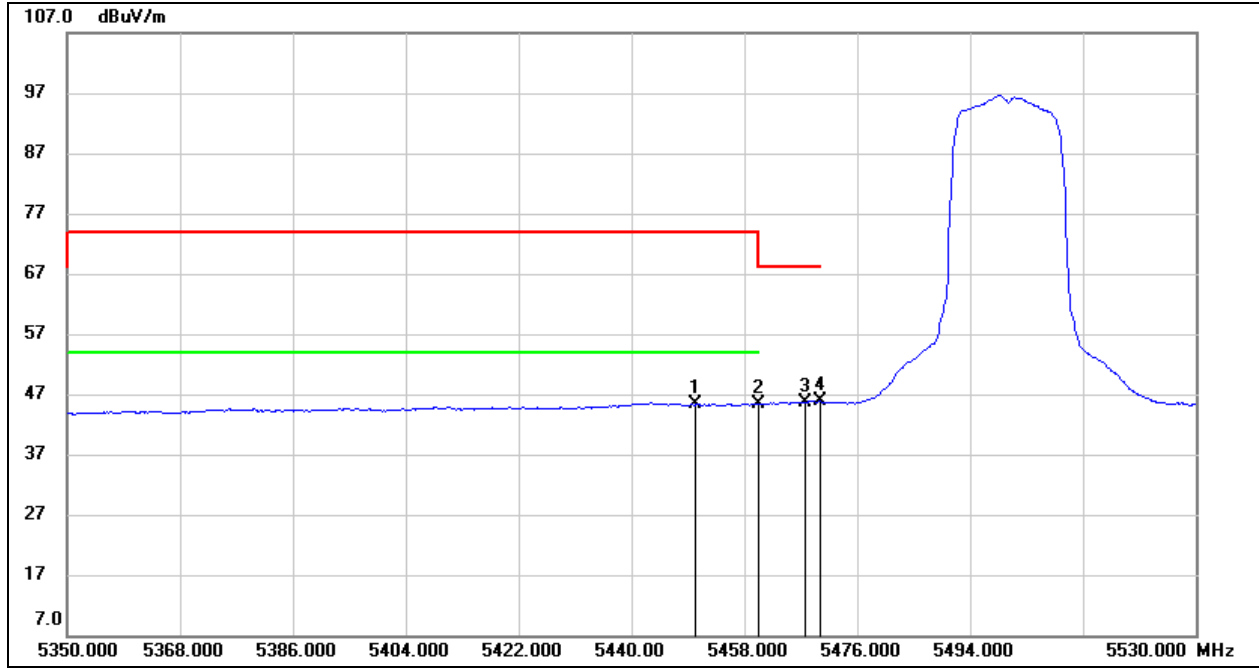

No.	Frequency (MHz)	Reading (dBuV)	Correct (dB/m)	Result (dBuV/m)	Limit (dBuV/m)	Margin (dB)	Remark
1	5450.260	3.55	41.77	45.32	54.00	-8.68	AVG
2	5460.000	3.50	41.82	45.32	54.00	-8.68	AVG
3	5467.720	3.80	41.86	45.66	/	/	AVG
4	5470.000	3.95	41.87	45.82	/	/	AVG

Note: 1. Measurement = Reading Level + Correct Factor.
 2. If Peak Result complies with AV limit, AV Result is deemed to comply with AV limit.
 3. AVG: VBW=1/Ton, where: Ton is the transmitting duration.
 4. For the transmitting duration, please refer to clause 7.1.
 5. Only the worst data was recorded, if it complies with the limit, the other emissions deemed to comply with the limit.

RESTRICTED BANDEDGE (HIGH CHANNEL, HORIZONTAL)

PEAK

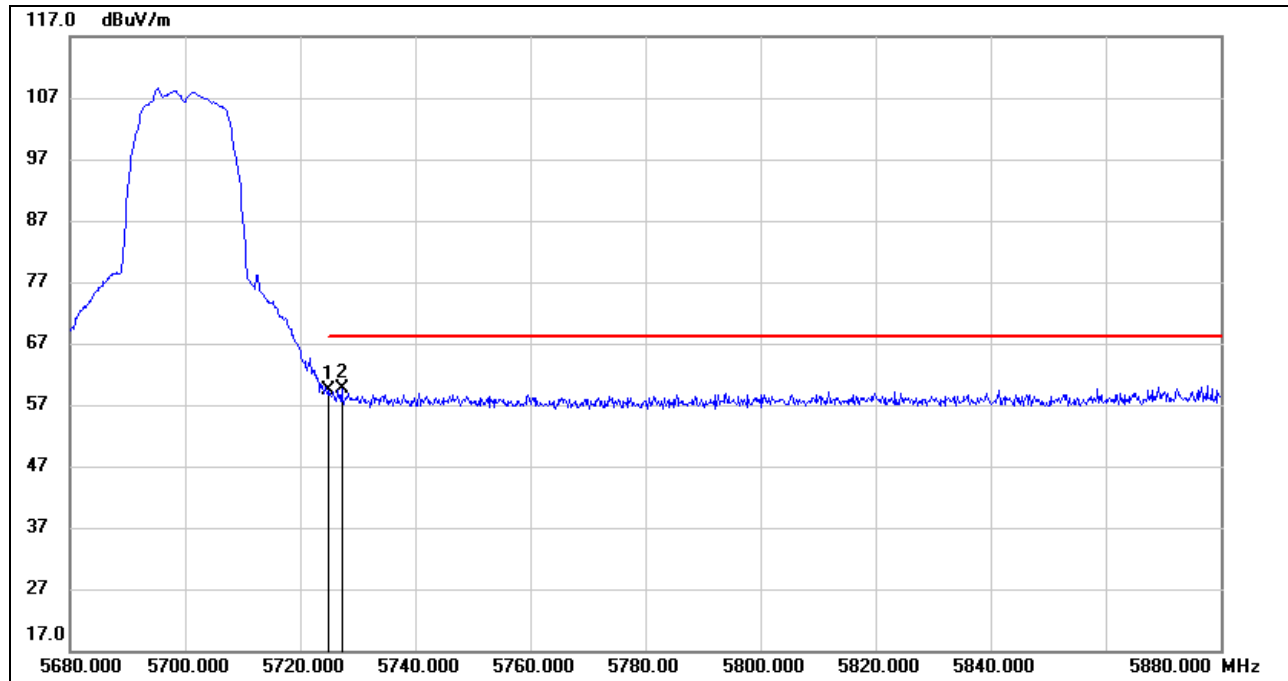

No.	Frequency (MHz)	Reading (dBuV)	Correct (dB/m)	Result (dBuV/m)	Limit (dBuV/m)	Margin (dB)	Remark
1	5725.000	17.62	41.67	59.29	68.20	-8.91	peak
2	5727.200	17.93	41.68	59.61	68.20	-8.59	peak

- Note: 1. Measurement = Reading Level + Correct Factor.
 2. If Peak Result complies with AV limit, AV Result is deemed to comply with AV limit.
 3. Peak: Peak detector.
 4. Only the worst data was recorded, if it complies with the limit, the other emissions deemed to comply with the limit.

UNII-3 BAND

RESTRICTED BANDEDGE (LOW CHANNEL, HORIZONTAL)

PEAK

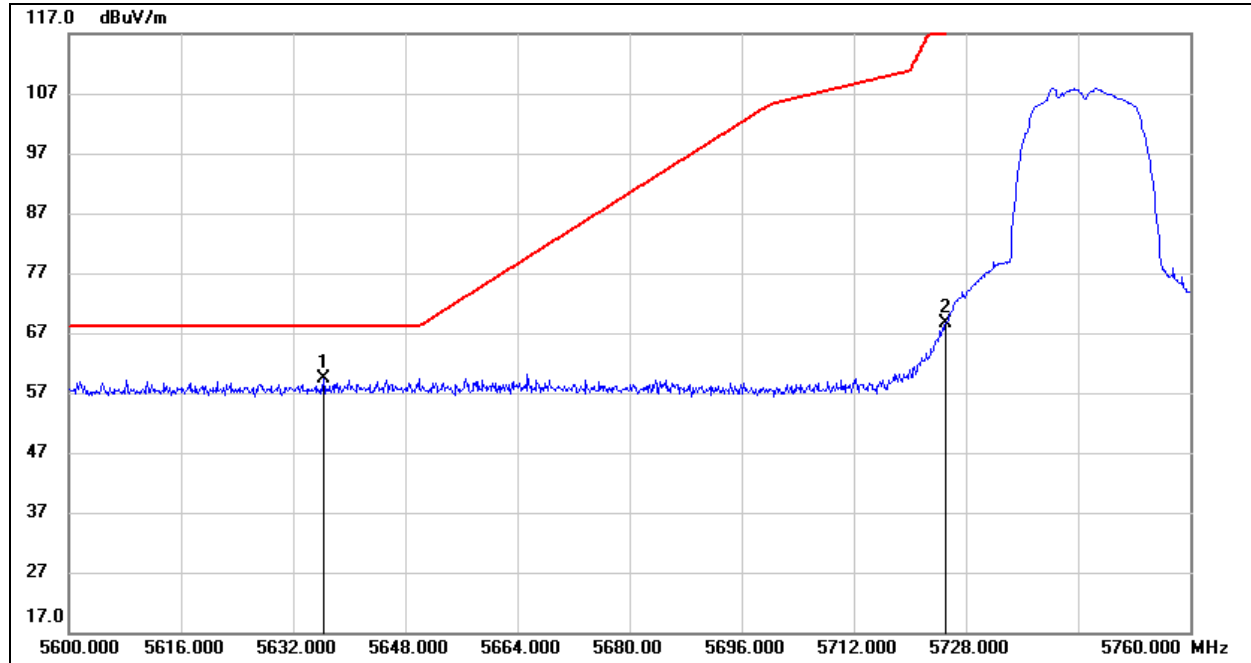

No.	Frequency (MHz)	Reading (dBuV)	Correct (dB/m)	Result (dBuV/m)	Limit (dBuV/m)	Margin (dB)	Remark
1	5636.320	17.76	41.66	59.42	68.20	-8.78	peak
2	5725.000	26.86	41.67	68.53	122.20	-53.67	peak

- Note:
1. Measurement = Reading Level + Correct Factor.
 2. If Peak Result complies with AV limit, AV Result is deemed to comply with AV limit.
 3. Peak: Peak detector.
 4. Only the worst data was recorded, if it complies with the limit, the other emissions deemed to comply with the limit.

RESTRICTED BANDEDGE (HIGH CHANNEL, HORIZONTAL)

PEAK

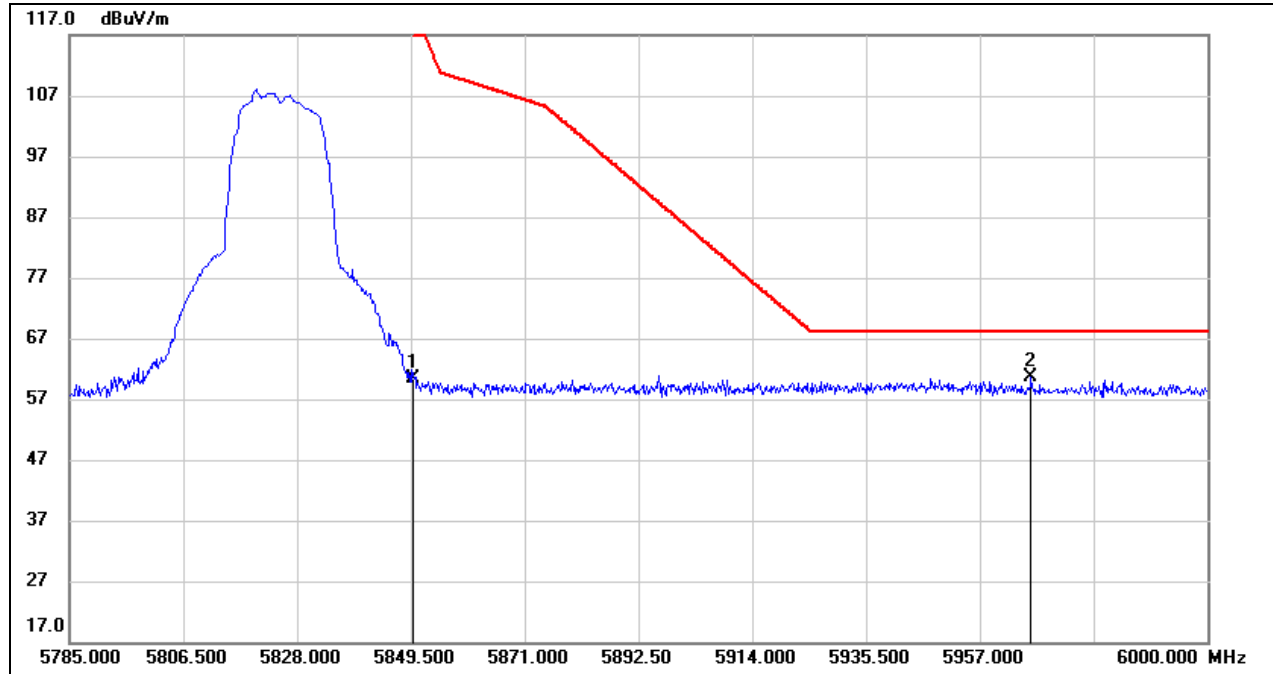

No.	Frequency (MHz)	Reading (dBuV)	Correct (dB/m)	Result (dBuV/m)	Limit (dBuV/m)	Margin (dB)	Remark
1	5850.000	17.89	42.52	60.41	122.20	-61.79	peak
2	5966.675	17.82	42.72	60.54	68.20	-7.66	peak

Note: 1. Measurement = Reading Level + Correct Factor.
 2. If Peak Result complies with AV limit, AV Result is deemed to comply with AV limit.
 3. Peak: Peak detector.
 4. Only the worst data was recorded, if it complies with the limit, the other emissions deemed to comply with the limit.

Note: Both the two antennas had been tested, but only the worst data was recorded in the report.

Note: Horizontal and Vertical have been tested, only the worst data was recorded in the report.



8.1.2. 802.11n HT20 MIMO MODE

UNII-1 BAND

RESTRICTED BANDEDGE (LOW CHANNEL, HORIZONTAL)

PEAK

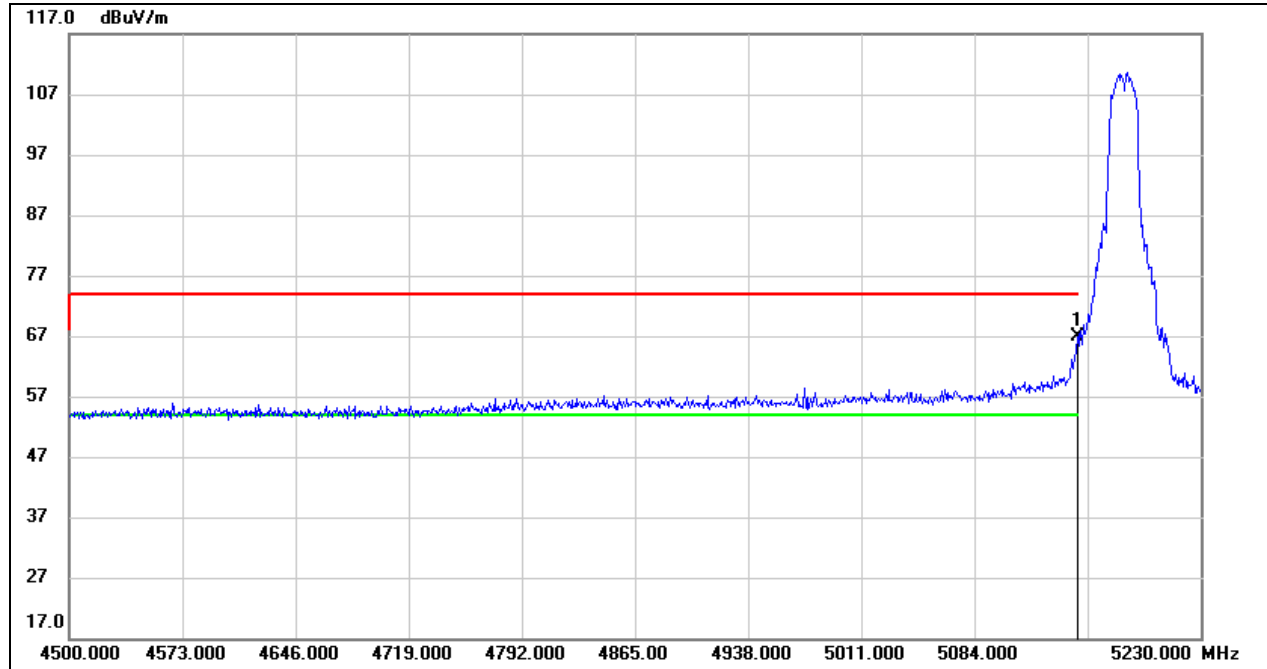

No.	Frequency (MHz)	Reading (dBuV)	Correct (dB/m)	Result (dBuV/m)	Limit (dBuV/m)	Margin (dB)	Remark
1	5150.000	25.65	41.19	66.84	74.00	-7.16	peak

- Note: 1. Measurement = Reading Level + Correct Factor.
 2. If Peak Result complies with AV limit, AV Result is deemed to comply with AV limit.
 3. Peak: Peak detector.
 4. Only the worst data was recorded, if it complies with the limit, the other emissions deemed to comply with the limit.

AVG

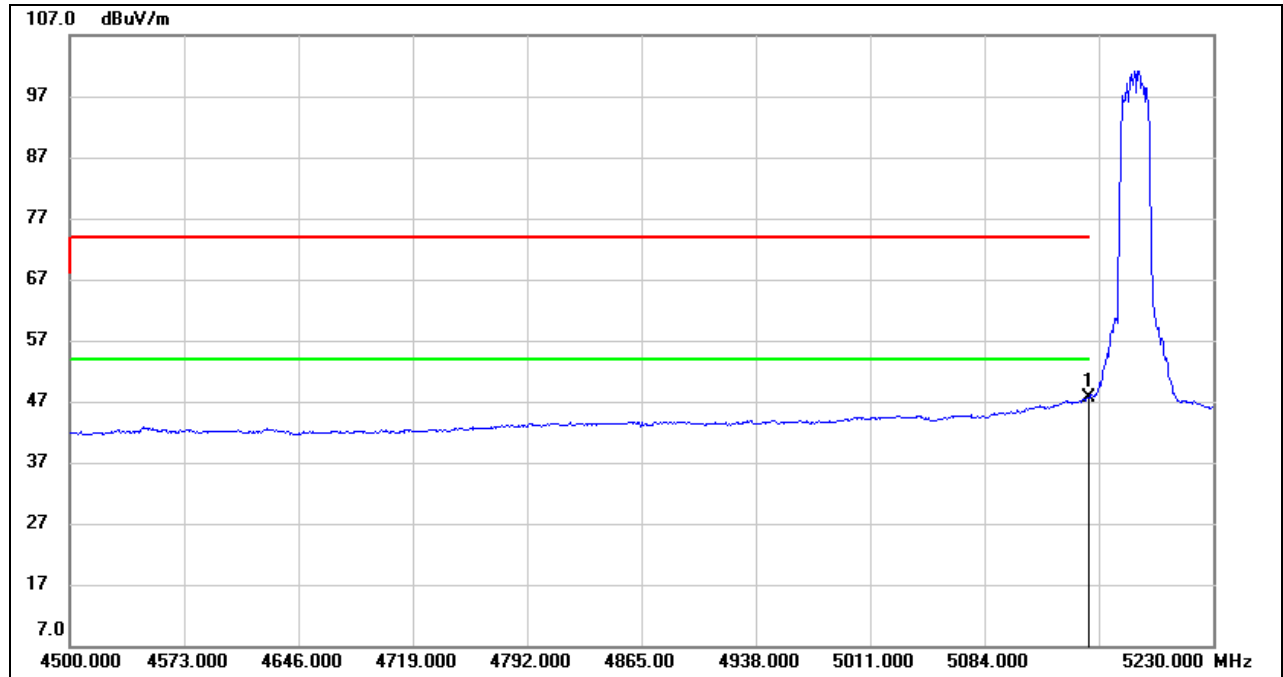

No.	Frequency (MHz)	Reading (dBuV)	Correct (dB/m)	Result (dBuV/m)	Limit (dBuV/m)	Margin (dB)	Remark
1	5150.000	6.42	41.19	47.61	54.00	-6.39	AVG

- Note:
1. Measurement = Reading Level + Correct Factor.
 2. If Peak Result complies with AV limit, AV Result is deemed to comply with AV limit.
 3. AVG: $VBW=1/T_{on}$, where: T_{on} is the transmitting duration.
 4. For the transmitting duration, please refer to clause 7.1.
 5. Only the worst data was recorded, if it complies with the limit, the other emissions deemed to comply with the limit.



UNII-2A BAND

RESTRICTED BANDEDGE (HIGH CHANNEL, HORIZONTAL)

PEAK

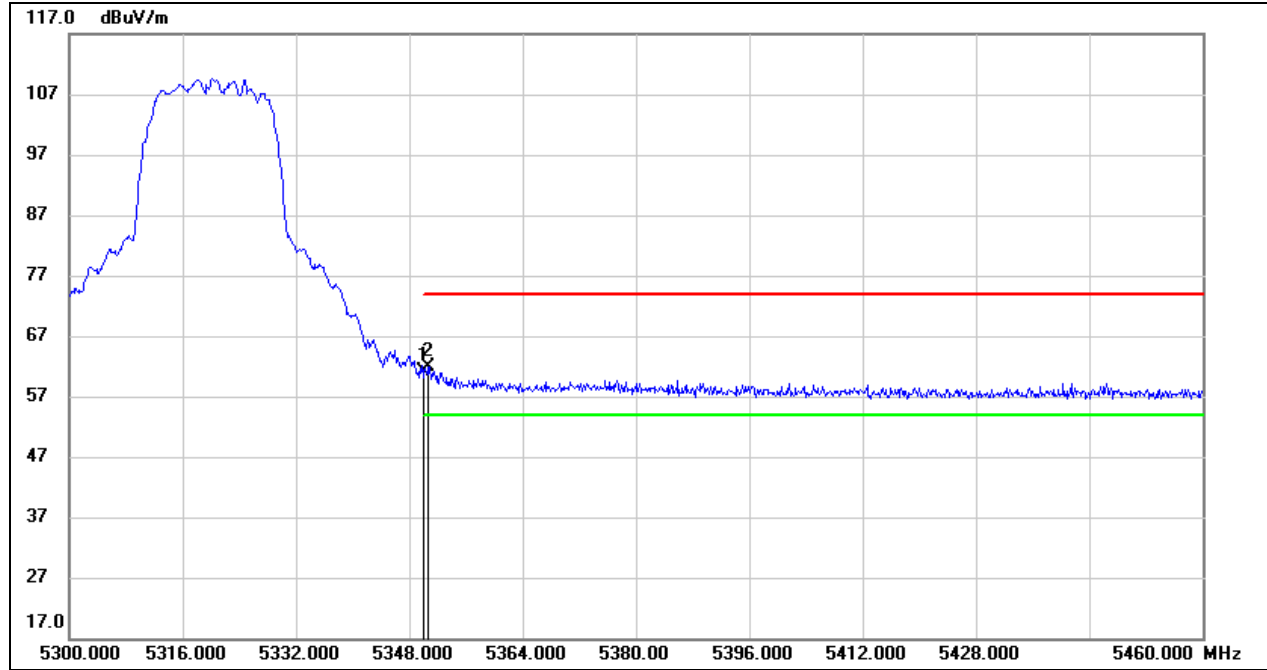

No.	Frequency (MHz)	Reading (dBuV)	Correct (dB/m)	Result (dBuV/m)	Limit (dBuV/m)	Margin (dB)	Remark
1	5350.000	19.86	41.20	61.06	74.00	-12.94	peak
2	5350.720	20.70	41.21	61.91	74.00	-12.09	peak

- Note: 1. Measurement = Reading Level + Correct Factor.
 2. If Peak Result complies with AV limit, AV Result is deemed to comply with AV limit.
 3. Peak: Peak detector.
 4. Only the worst data was recorded, if it complies with the limit, the other emissions deemed to comply with the limit.



AVG

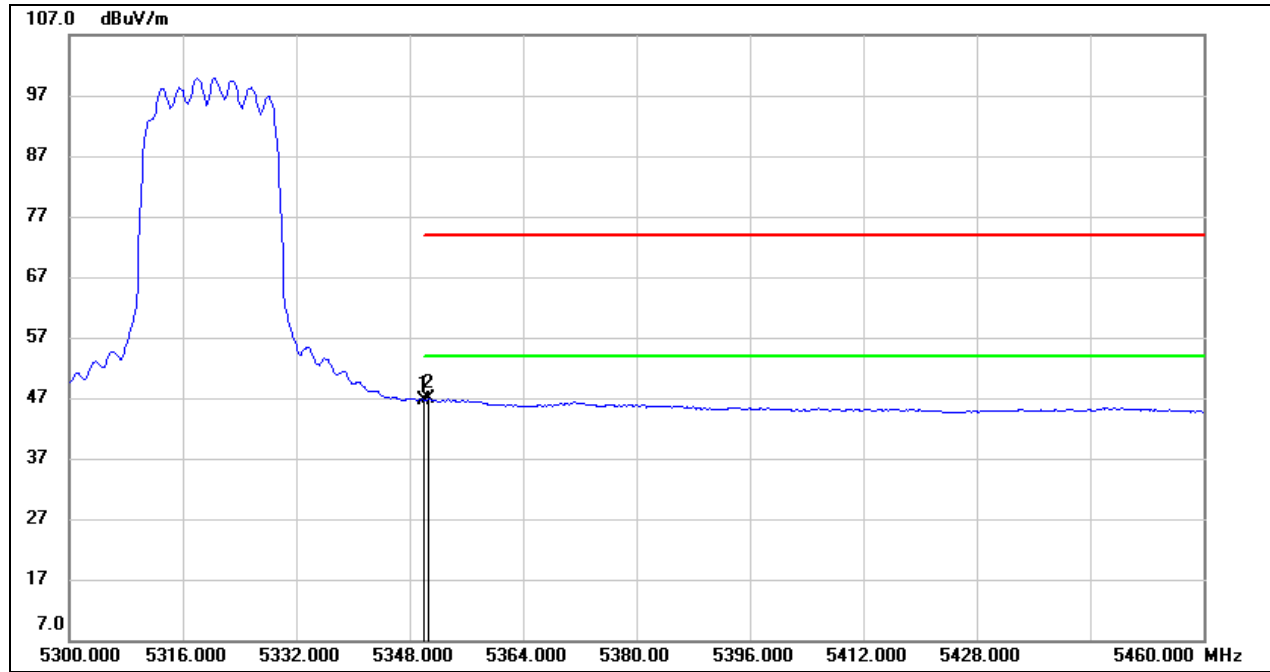

No.	Frequency (MHz)	Reading (dBuV)	Correct (dB/m)	Result (dBuV/m)	Limit (dBuV/m)	Margin (dB)	Remark
1	5350.000	5.36	41.20	46.56	54.00	-7.44	AVG
2	5350.720	5.62	41.21	46.83	54.00	-7.17	AVG

- Note:
1. Measurement = Reading Level + Correct Factor.
 2. If Peak Result complies with AV limit, AV Result is deemed to comply with AV limit.
 3. AVG: $VBW=1/Ton$, where: Ton is the transmitting duration.
 4. For the transmitting duration, please refer to clause 7.1.
 5. Only the worst data was recorded, if it complies with the limit, the other emissions deemed to comply with the limit.



UNII-2C BAND

RESTRICTED BANDEDGE (LOW CHANNEL, HORIZONTAL)

PEAK

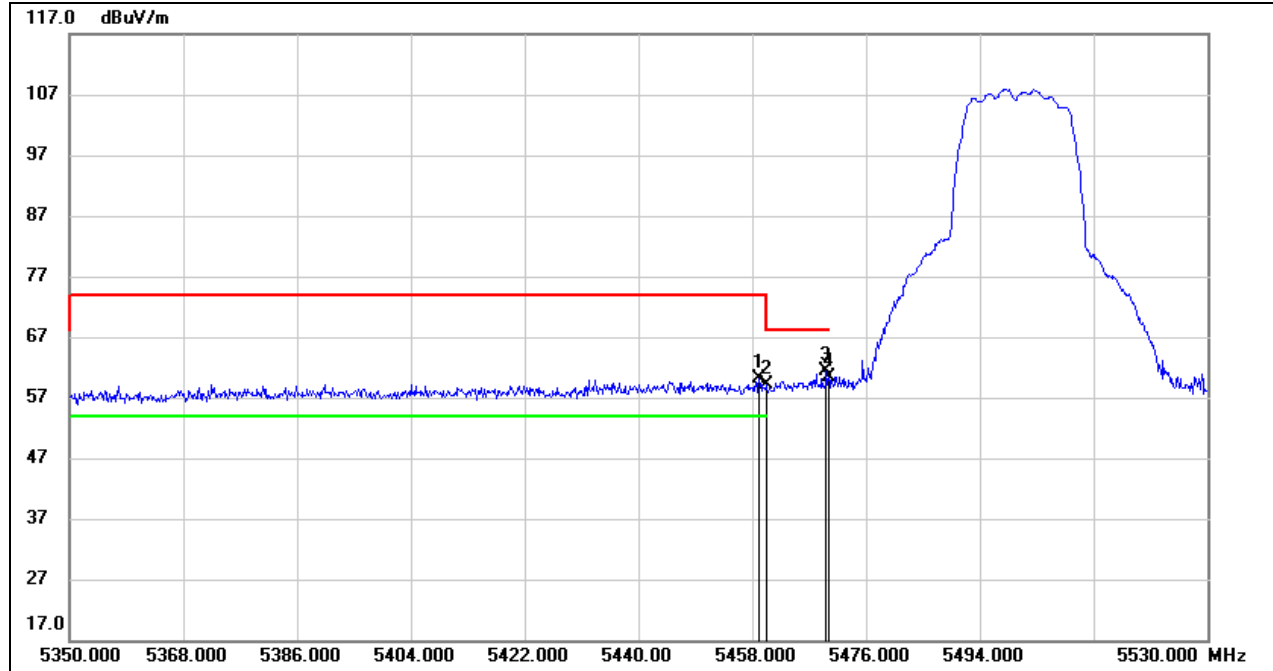

No.	Frequency (MHz)	Reading (dBuV)	Correct (dB/m)	Result (dBuV/m)	Limit (dBuV/m)	Margin (dB)	Remark
1	5459.080	18.23	41.82	60.05	74.00	-13.95	peak
2	5460.000	17.23	41.82	59.05	74.00	-14.95	peak
3	5469.700	19.47	41.87	61.34	68.20	-6.86	peak
4	5470.000	18.47	41.87	60.34	68.20	-7.86	peak

Note: 1. Measurement = Reading Level + Correct Factor.
 2. If Peak Result complies with AV limit, AV Result is deemed to comply with AV limit.
 3. Peak: Peak detector.
 4. Only the worst data was recorded, if it complies with the limit, the other emissions deemed to comply with the limit.

AVG

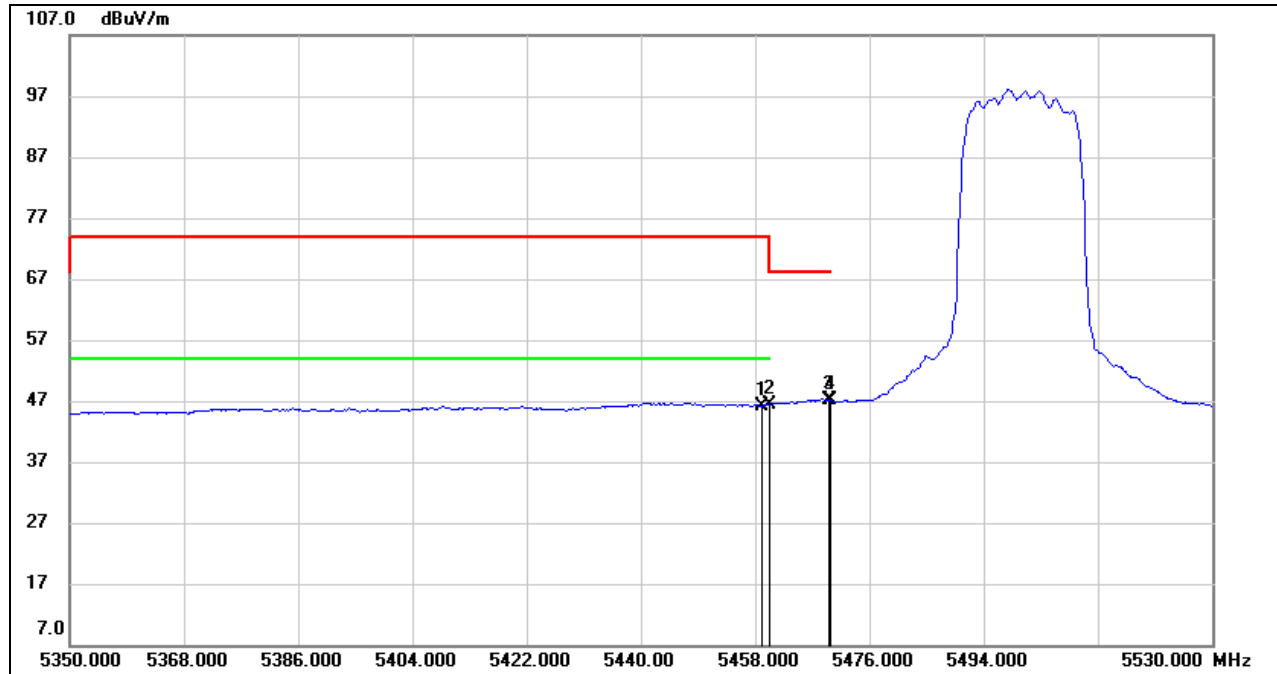

No.	Frequency (MHz)	Reading (dBuV)	Correct (dB/m)	Result (dBuV/m)	Limit (dBuV/m)	Margin (dB)	Remark
1	5459.080	4.38	41.82	46.20	54.00	-7.80	AVG
2	5460.000	4.47	41.82	46.29	54.00	-7.71	AVG
3	5469.700	5.25	41.87	47.12	/	/	AVG
4	5470.000	5.24	41.87	47.11	/	/	AVG

- Note:
1. Measurement = Reading Level + Correct Factor.
 2. If Peak Result complies with AV limit, AV Result is deemed to comply with AV limit.
 3. AVG: $VBW=1/Ton$, where: Ton is the transmitting duration.
 4. For the transmitting duration, please refer to clause 7.1.
 5. Only the worst data was recorded, if it complies with the limit, the other emissions deemed to comply with the limit.



RESTRICTED BANDEDGE (HIGH CHANNEL, HORIZONTAL)

PEAK

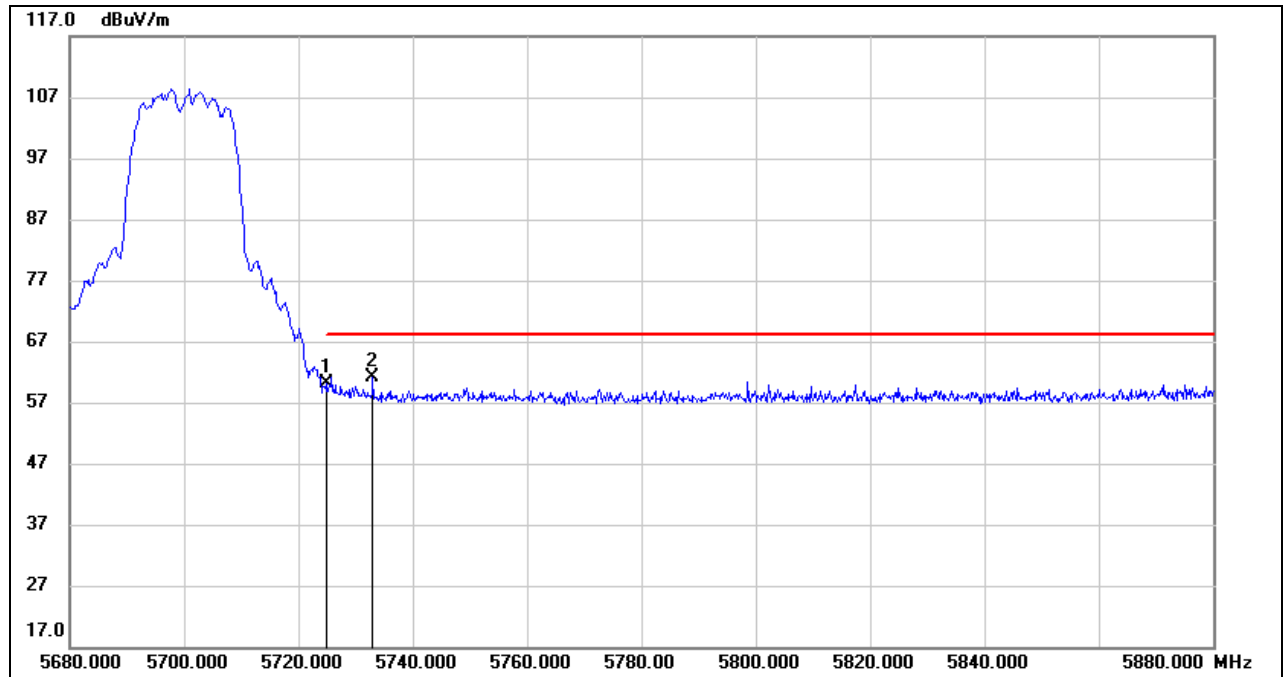

No.	Frequency (MHz)	Reading (dBuV)	Correct (dB/m)	Result (dBuV/m)	Limit (dBuV/m)	Margin (dB)	Remark
1	5725.000	18.48	41.67	60.15	68.20	-8.05	peak
2	5733.000	19.37	41.71	61.08	68.20	-7.12	peak

- Note: 1. Measurement = Reading Level + Correct Factor.
 2. If Peak Result complies with AV limit, AV Result is deemed to comply with AV limit.
 3. Peak: Peak detector.
 4. Only the worst data was recorded, if it complies with the limit, the other emissions deemed to comply with the limit.

UNII-3 BAND

RESTRICTED BANDEDGE (LOW CHANNEL, HORIZONTAL)

PEAK

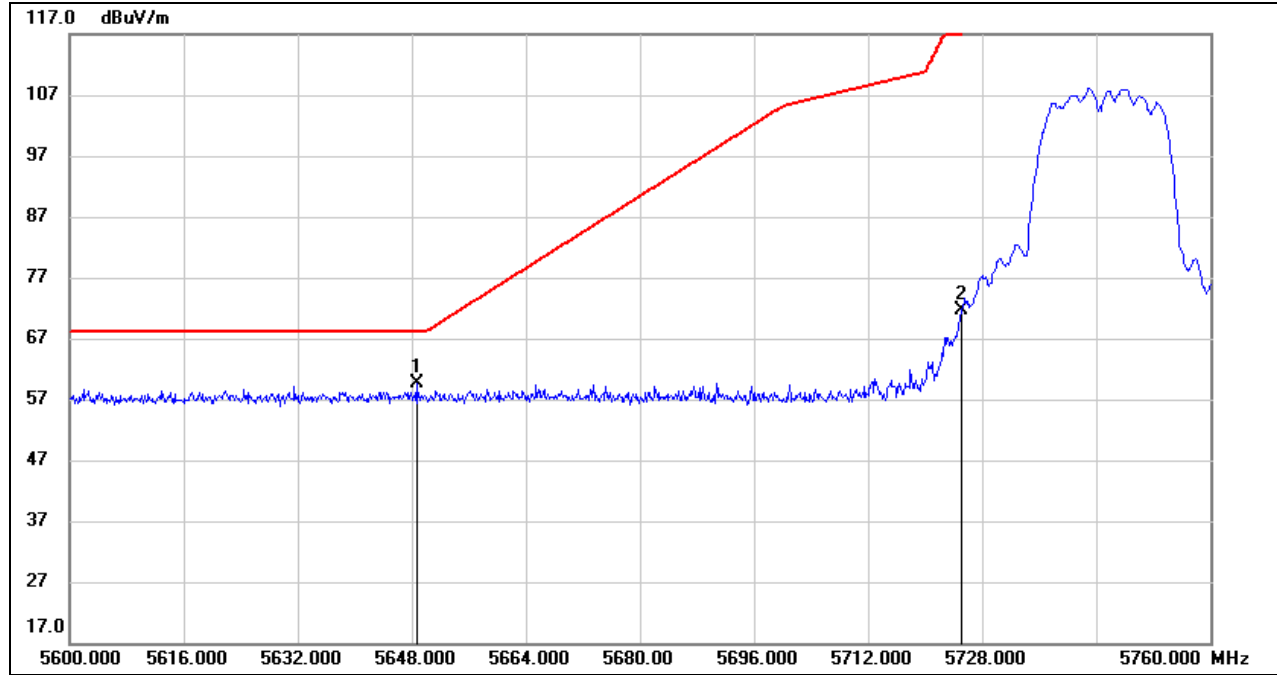

No.	Frequency (MHz)	Reading (dBuV)	Correct (dB/m)	Result (dBuV/m)	Limit (dBuV/m)	Margin (dB)	Remark
1	5648.640	17.88	41.64	59.52	68.20	-8.68	peak
2	5725.000	29.85	41.67	71.52	122.20	-50.68	peak

Note: 1. Measurement = Reading Level + Correct Factor.
 2. If Peak Result complies with AV limit, AV Result is deemed to comply with AV limit.
 3. Peak: Peak detector.
 4. Only the worst data was recorded, if it complies with the limit, the other emissions deemed to comply with the limit.

RESTRICTED BANDEDGE (HIGH CHANNEL, HORIZONTAL)

PEAK

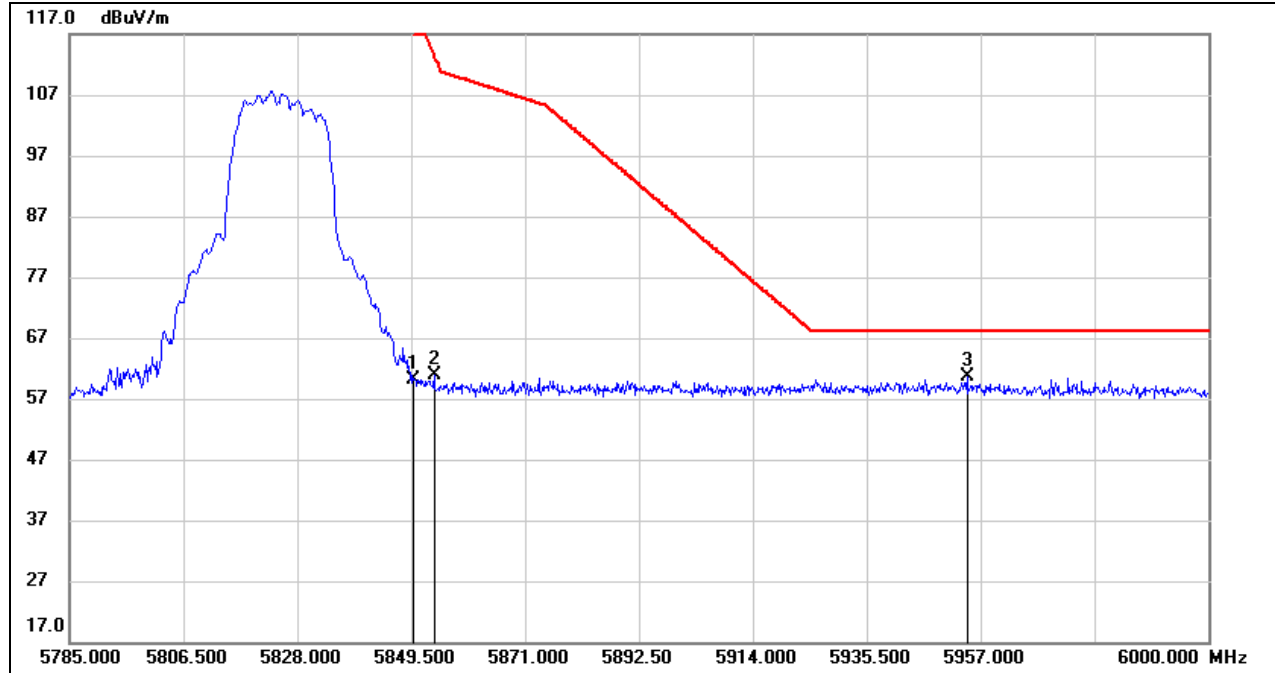

No.	Frequency (MHz)	Reading (dBuV)	Correct (dB/m)	Result (dBuV/m)	Limit (dBuV/m)	Margin (dB)	Remark
1	5850.000	17.51	42.52	60.03	122.20	-62.17	peak
2	5853.800	18.30	42.56	60.86	113.54	-52.68	peak
3	5954.420	17.81	42.78	60.59	68.20	-7.61	peak

- Note: 1. Measurement = Reading Level + Correct Factor.
 2. If Peak Result complies with AV limit, AV Result is deemed to comply with AV limit.
 3. Peak: Peak detector.
 4. Only the worst data was recorded, if it complies with the limit, the other emissions deemed to comply with the limit.

Note: Both the two antennas had been tested, but only the worst data was recorded in the report.

Note: Horizontal and Vertical have been tested, only the worst data was recorded in the report.



8.1.3. 802.11n HT40 MIMO MODE

UNII-1 BAND

RESTRICTED BANDEDGE (LOW CHANNEL, HORIZONTAL)

PEAK

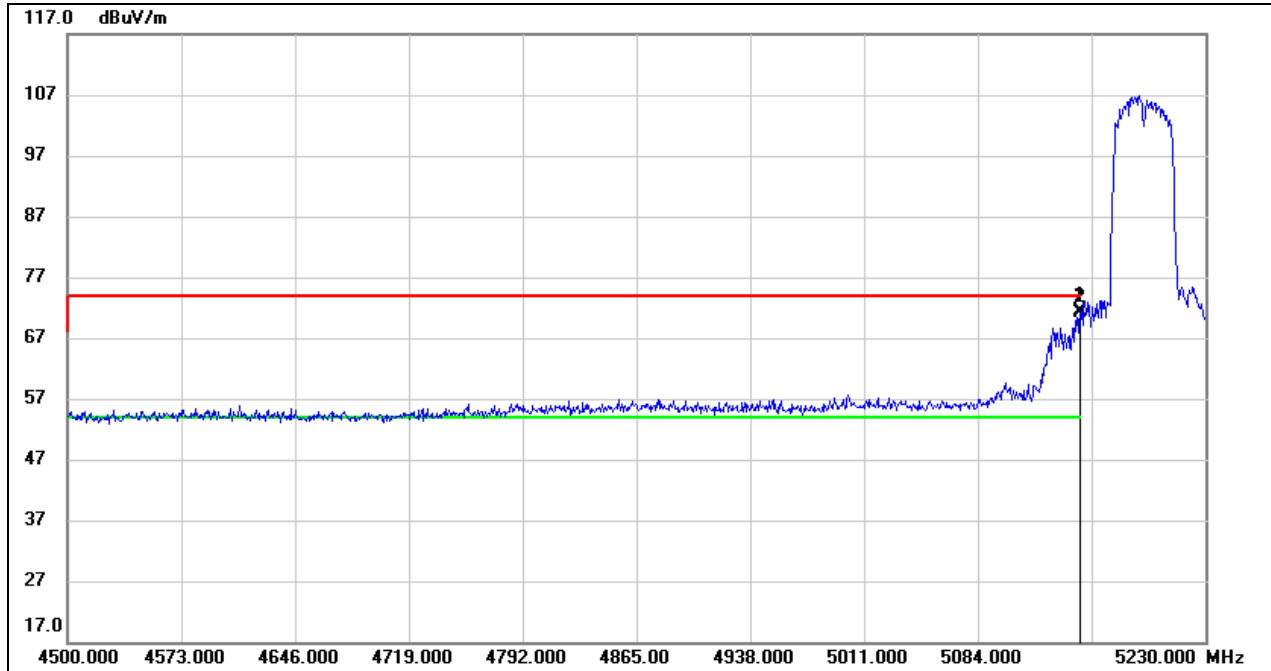

No.	Frequency (MHz)	Reading (dBuV)	Correct (dB/m)	Result (dBuV/m)	Limit (dBuV/m)	Margin (dB)	Remark
1	5149.700	30.30	41.18	71.48	74.00	-2.52	peak
2	5150.000	29.93	41.19	71.12	74.00	-2.88	peak

- Note: 1. Measurement = Reading Level + Correct Factor.
 2. If Peak Result complies with AV limit, AV Result is deemed to comply with AV limit.
 3. Peak: Peak detector.
 4. Only the worst data was recorded, if it complies with the limit, the other emissions deemed to comply with the limit.

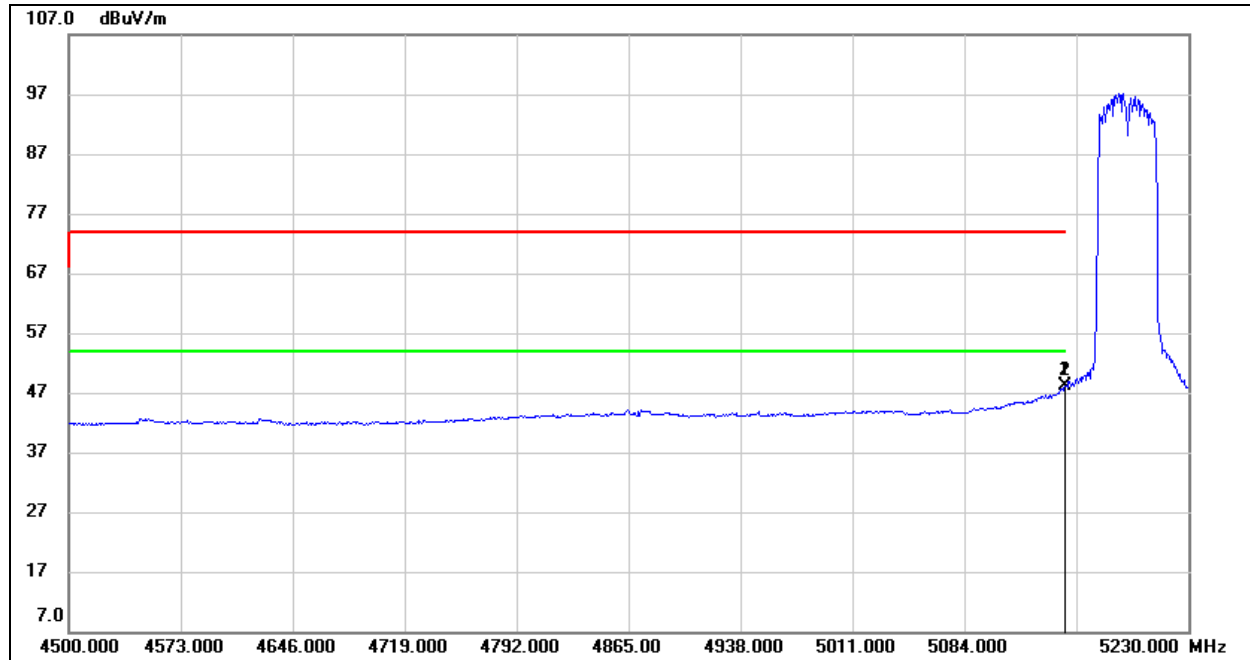
**AVG**

No.	Frequency (MHz)	Reading (dBuV)	Correct (dB/m)	Result (dBuV/m)	Limit (dBuV/m)	Margin (dB)	Remark
1	5149.700	6.87	41.18	48.05	54.00	-5.95	AVG
2	5150.000	6.83	41.19	48.02	54.00	-5.98	AVG

- Note:
1. Measurement = Reading Level + Correct Factor.
 2. If Peak Result complies with AV limit, AV Result is deemed to comply with AV limit.
 3. AVG: $VBW=1/T_{on}$, where: T_{on} is the transmitting duration.
 4. For the transmitting duration, please refer to clause 7.1.
 5. Only the worst data was recorded, if it complies with the limit, the other emissions deemed to comply with the limit.

UNII-2A BAND

RESTRICTED BANDEDGE (HIGH CHANNEL, HORIZONTAL)

PEAK

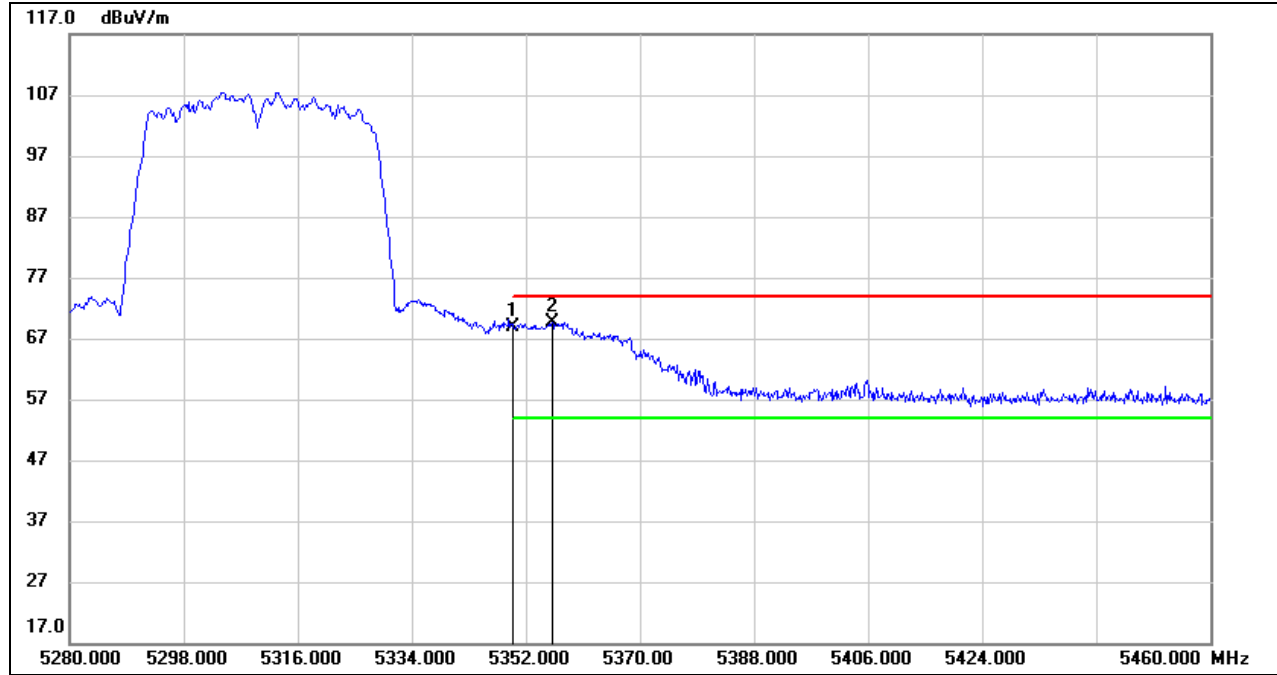

No.	Frequency (MHz)	Reading (dBuV)	Correct (dB/m)	Result (dBuV/m)	Limit (dBuV/m)	Margin (dB)	Remark
1	5350.000	27.80	41.20	69.00	74.00	-5.00	peak
2	5356.140	28.37	41.24	69.61	74.00	-4.39	peak

Note: 1. Measurement = Reading Level + Correct Factor.
 2. If Peak Result complies with AV limit, AV Result is deemed to comply with AV limit.
 3. Peak: Peak detector.
 4. Only the worst data was recorded, if it complies with the limit, the other emissions deemed to comply with the limit.

AVG

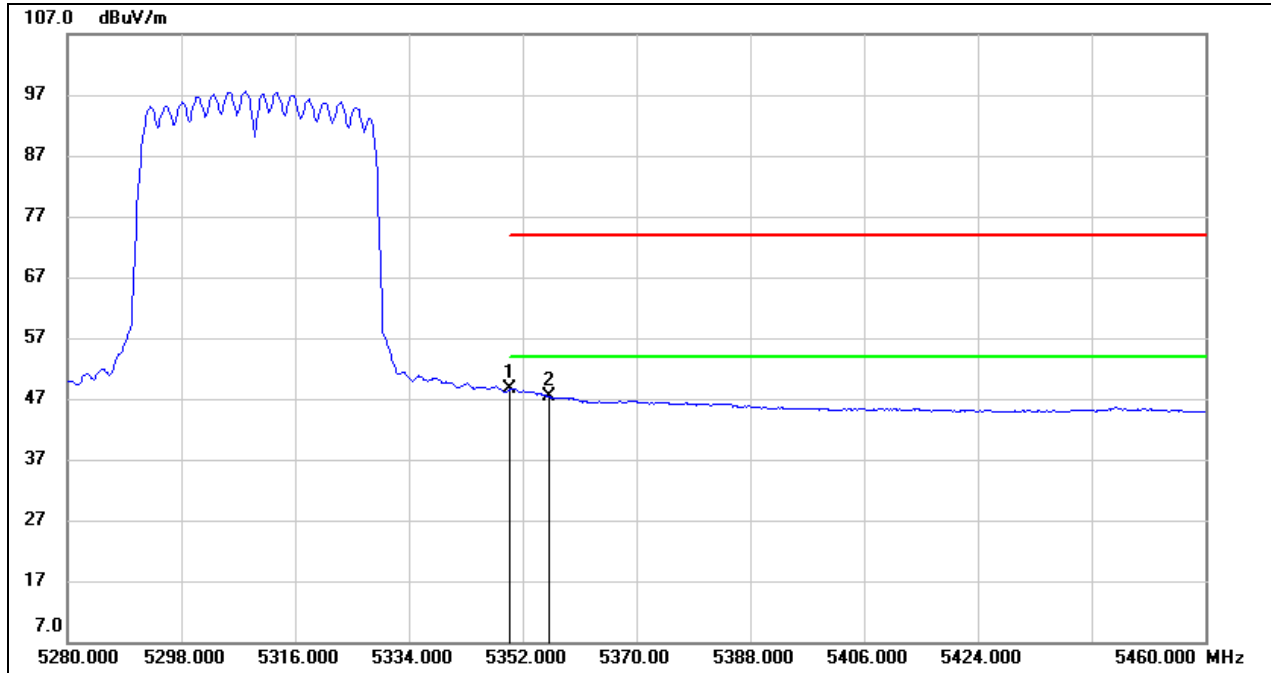

No.	Frequency (MHz)	Reading (dBuV)	Correct (dB/m)	Result (dBuV/m)	Limit (dBuV/m)	Margin (dB)	Remark
1	5350.000	7.32	41.20	48.52	54.00	-5.48	AVG
2	5356.140	6.24	41.24	47.48	54.00	-6.52	AVG

- Note: 1. Measurement = Reading Level + Correct Factor.
 2. If Peak Result complies with AV limit, AV Result is deemed to comply with AV limit.
 3. AVG: $VBW=1/Ton$, where: Ton is the transmitting duration.
 4. For the transmitting duration, please refer to clause 7.1.
 5. Only the worst data was recorded, if it complies with the limit, the other emissions deemed to comply with the limit.

UNII-2C BAND

RESTRICTED BANDEDGE (LOW CHANNEL, HORIZONTAL)

PEAK

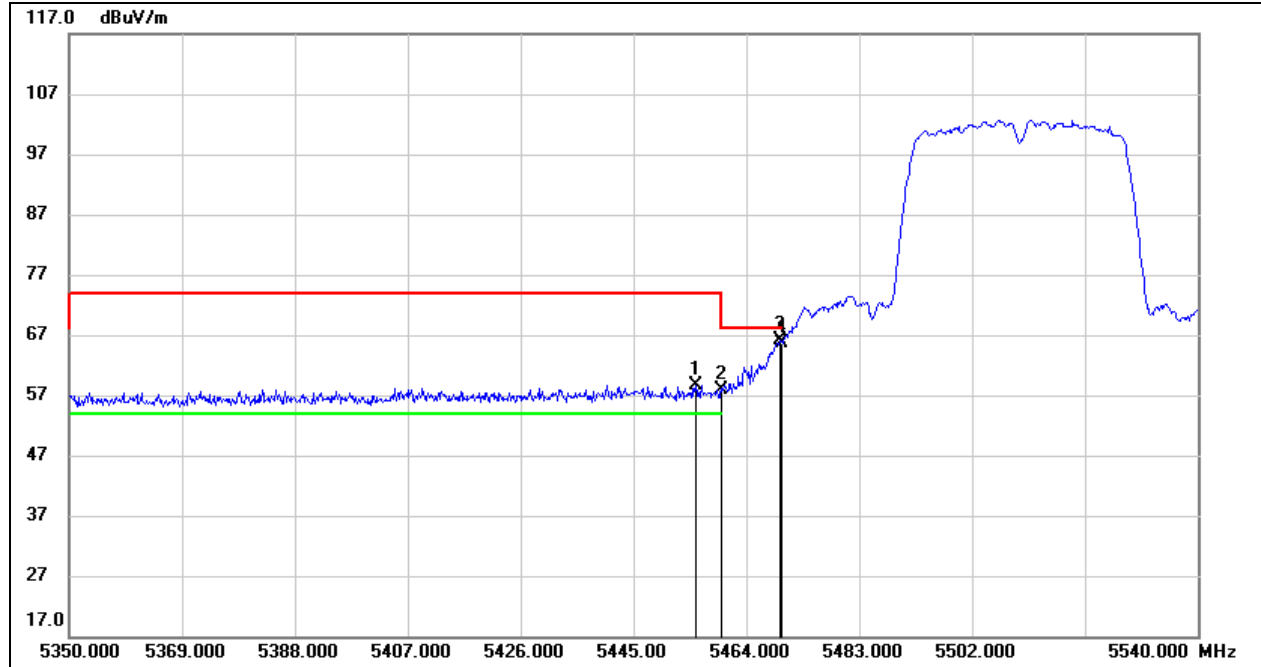

No.	Frequency (MHz)	Reading (dBuV)	Correct (dB/m)	Result (dBuV/m)	Limit (dBuV/m)	Margin (dB)	Remark
1	5455.450	16.84	41.80	58.64	74.00	-15.36	peak
2	5460.000	16.01	41.82	57.83	74.00	-16.17	peak
3	5469.700	24.25	41.87	66.12	68.20	-2.08	peak
4	5470.000	23.85	41.87	65.72	68.20	-2.48	peak

Note: 1. Measurement = Reading Level + Correct Factor.
 2. If Peak Result complies with AV limit, AV Result is deemed to comply with AV limit.
 3. Peak: Peak detector.
 4. Only the worst data was recorded, if it complies with the limit, the other emissions deemed to comply with the limit.

AVG

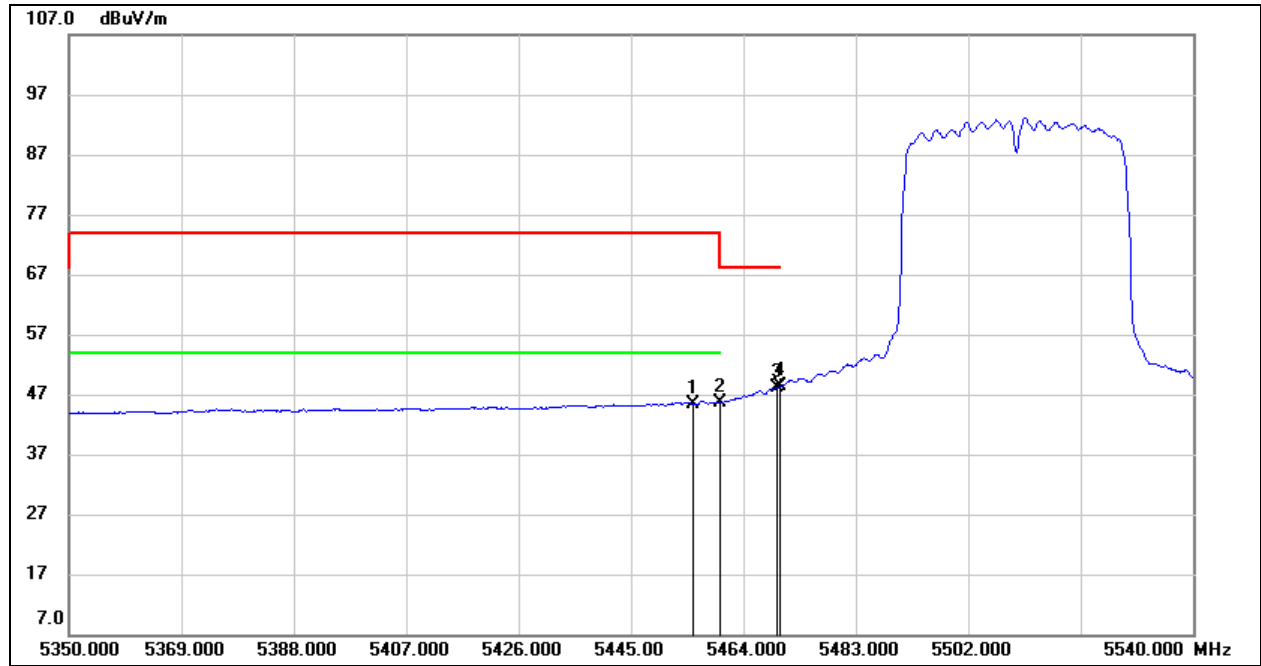

No.	Frequency (MHz)	Reading (dBuV)	Correct (dB/m)	Result (dBuV/m)	Limit (dBuV/m)	Margin (dB)	Remark
1	5455.450	3.66	41.80	45.46	54.00	-8.54	AVG
2	5460.000	3.74	41.82	45.56	54.00	-8.44	AVG
3	5469.700	6.24	41.87	48.11	/	/	AVG
4	5470.000	6.42	41.87	48.29	/	/	AVG

- Note:
1. Measurement = Reading Level + Correct Factor.
 2. If Peak Result complies with AV limit, AV Result is deemed to comply with AV limit.
 3. AVG: $VBW=1/T_{on}$, where: T_{on} is the transmitting duration.
 4. For the transmitting duration, please refer to clause 7.1.
 5. Only the worst data was recorded, if it complies with the limit, the other emissions deemed to comply with the limit.

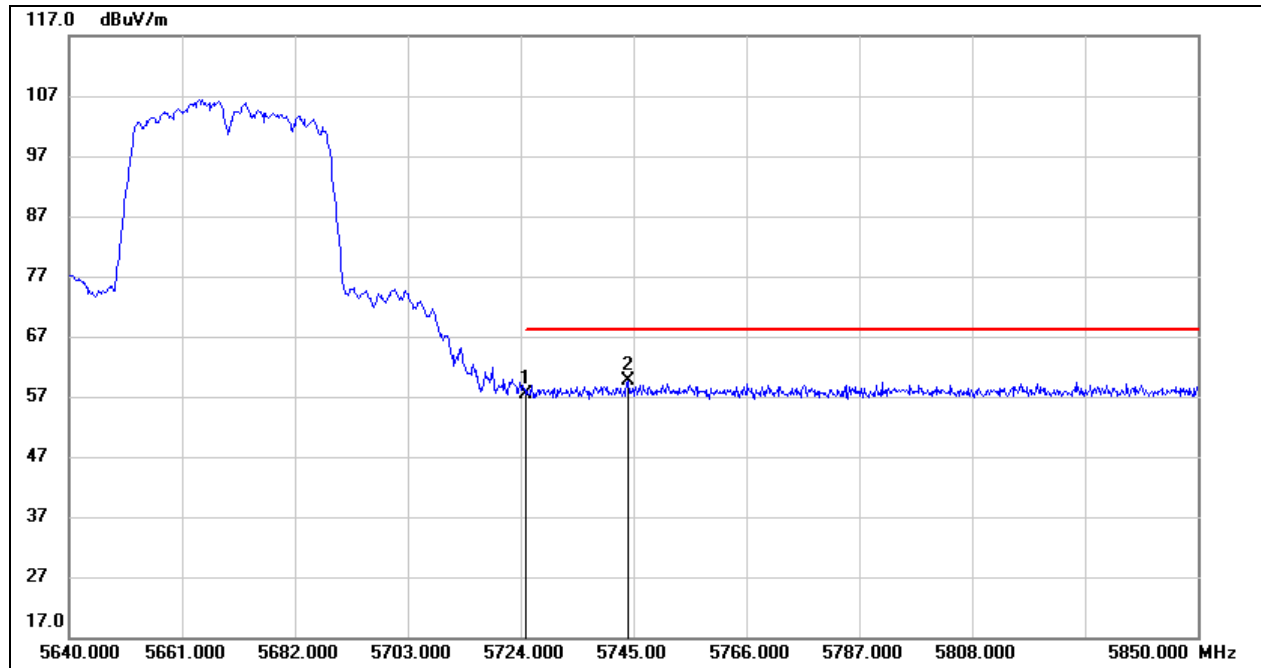
**RESTRICTED BANDEDGE (HIGH CHANNEL, HORIZONTAL)****PEAK**

No.	Frequency (MHz)	Reading (dBuV)	Correct (dB/m)	Result (dBuV/m)	Limit (dBuV/m)	Margin (dB)	Remark
1	5725.000	15.63	41.67	57.30	68.20	-10.90	peak
2	5743.950	17.83	41.75	59.58	68.20	-8.62	peak

Note: 1. Measurement = Reading Level + Correct Factor.

2. If Peak Result complies with AV limit, AV Result is deemed to comply with AV limit.

3. Peak: Peak detector.

4. Only the worst data was recorded, if it complies with the limit, the other emissions deemed to comply with the limit.



UNII-3 BAND

RESTRICTED BANDEDGE (LOW CHANNEL, HORIZONTAL)

PEAK

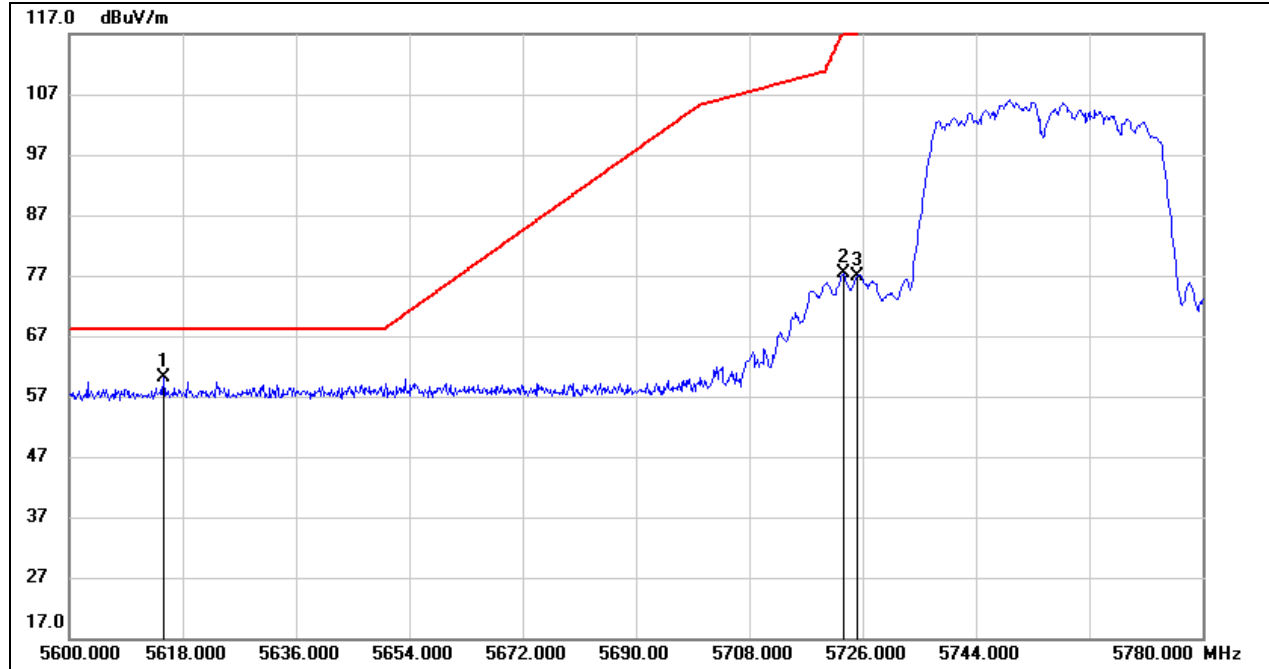

No.	Frequency (MHz)	Reading (dBuV)	Correct (dB/m)	Result (dBuV/m)	Limit (dBuV/m)	Margin (dB)	Remark
1	5614.940	18.34	41.71	60.05	68.20	-8.15	peak
2	5722.940	35.77	41.66	77.43	117.50	-40.07	peak
3	5725.000	35.24	41.67	76.91	122.20	-45.29	peak

- Note: 1. Measurement = Reading Level + Correct Factor.
 2. If Peak Result complies with AV limit, AV Result is deemed to comply with AV limit.
 3. Peak: Peak detector.
 4. Only the worst data was recorded, if it complies with the limit, the other emissions deemed to comply with the limit.

RESTRICTED BANDEDGE (HIGH CHANNEL, HORIZONTAL)

PEAK

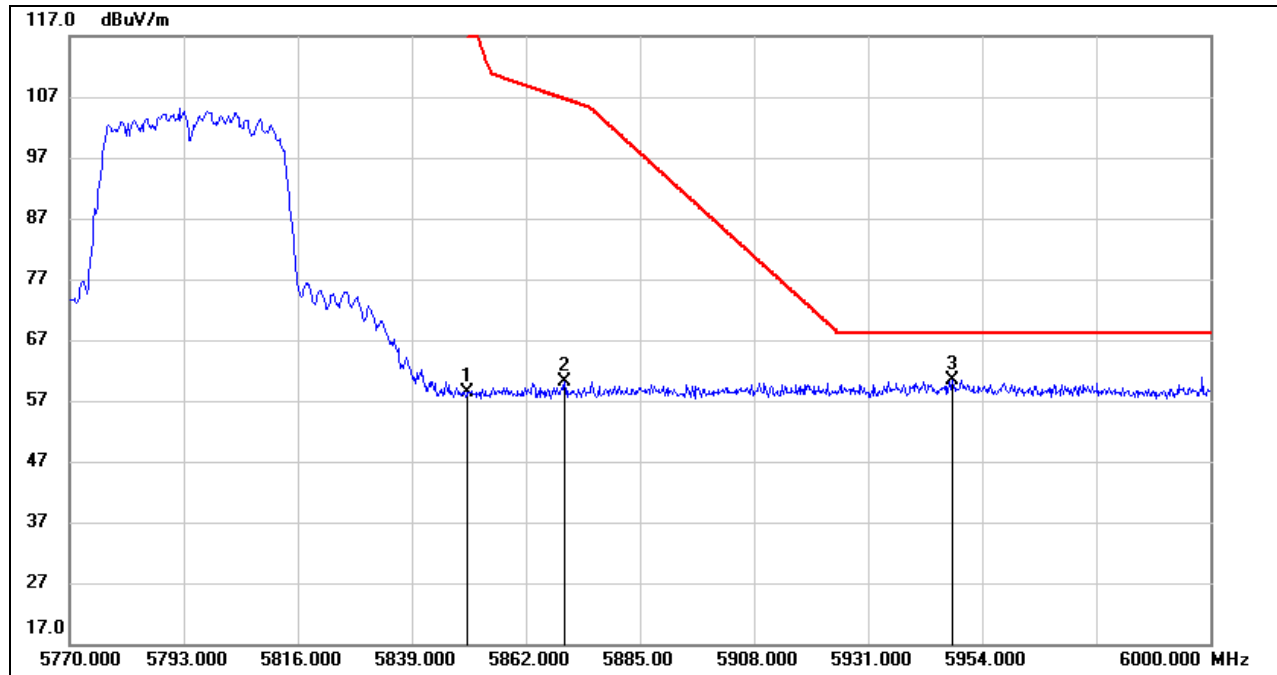

No.	Frequency (MHz)	Reading (dBuV)	Correct (dB/m)	Result (dBuV/m)	Limit (dBuV/m)	Margin (dB)	Remark
1	5850.000	15.79	42.52	58.31	122.20	-63.89	peak
2	5869.820	17.49	42.72	60.21	106.65	-46.44	peak
3	5948.020	17.60	42.81	60.41	68.20	-7.79	peak

- Note:
1. Measurement = Reading Level + Correct Factor.
 2. If Peak Result complies with AV limit, AV Result is deemed to comply with AV limit.
 3. Peak: Peak detector.
 4. Only the worst data was recorded, if it complies with the limit, the other emissions deemed to comply with the limit.

Note: Horizontal and Vertical have been tested, only the worst data was recorded in the report.

8.2. SPURIOUS EMISSIONS (1 GHz ~ 7 GHz)

8.2.1. 802.11a20 SISO MODE

ANTENNA 1 TEST RESULTS (WORST CASE)

UNII-1 BAND

HARMONICS AND SPURIOUS EMISSIONS (LOW CHANNEL, HORIZONTAL)

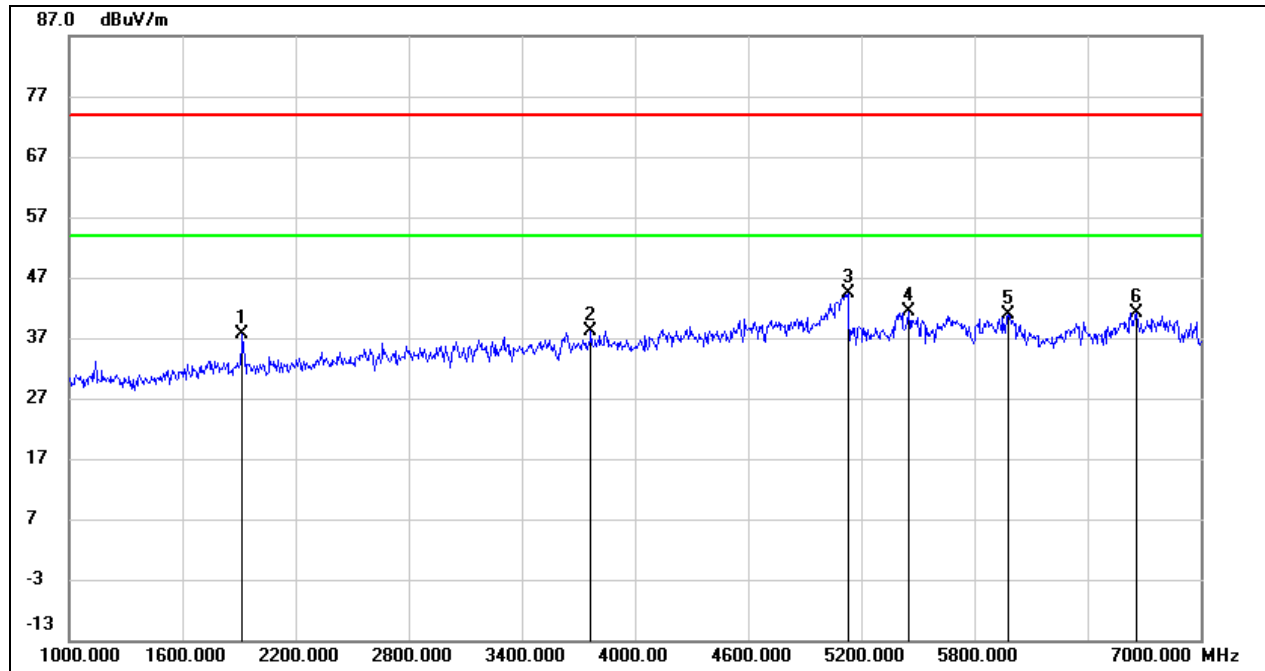

No.	Frequency (MHz)	Reading (dBuV)	Correct (dB/m)	Result (dBuV/m)	Limit (dBuV/m)	Margin (dB)	Remark
1	1918.000	47.81	-10.13	37.68	74.00	-36.32	peak
2	3766.000	41.61	-3.41	38.20	74.00	-35.80	peak
3	5128.000	42.62	1.67	44.29	74.00	-29.71	peak
4	5452.000	39.32	2.02	41.34	74.00	-32.66	peak
5	5980.000	37.59	3.22	40.81	74.00	-33.19	peak
6	6658.000	35.68	5.51	41.19	74.00	-32.81	peak

- Note: 1. Measurement = Reading Level + Correct Factor.
 2. If Peak Result complies with AV limit, AV Result is deemed to comply with AV limit.
 3. Peak: Peak detector.
 4. AVG: $VBW=1/Ton$, where: Ton is the transmitting duration.
 5. For the transmitting duration, please refer to clause 7.1.
 6. Filter losses were only considered in the spurious frequency bands and the authorized band was not corrected for Band reject filter losses.
 7. Proper operation of the transmitter prior to adding the filter to the measurement chain.
 8. Since non-restricted band peak emissions are less than the average limit, they also comply with the -27dBm/MHz (68.2dBuV/m) limit.

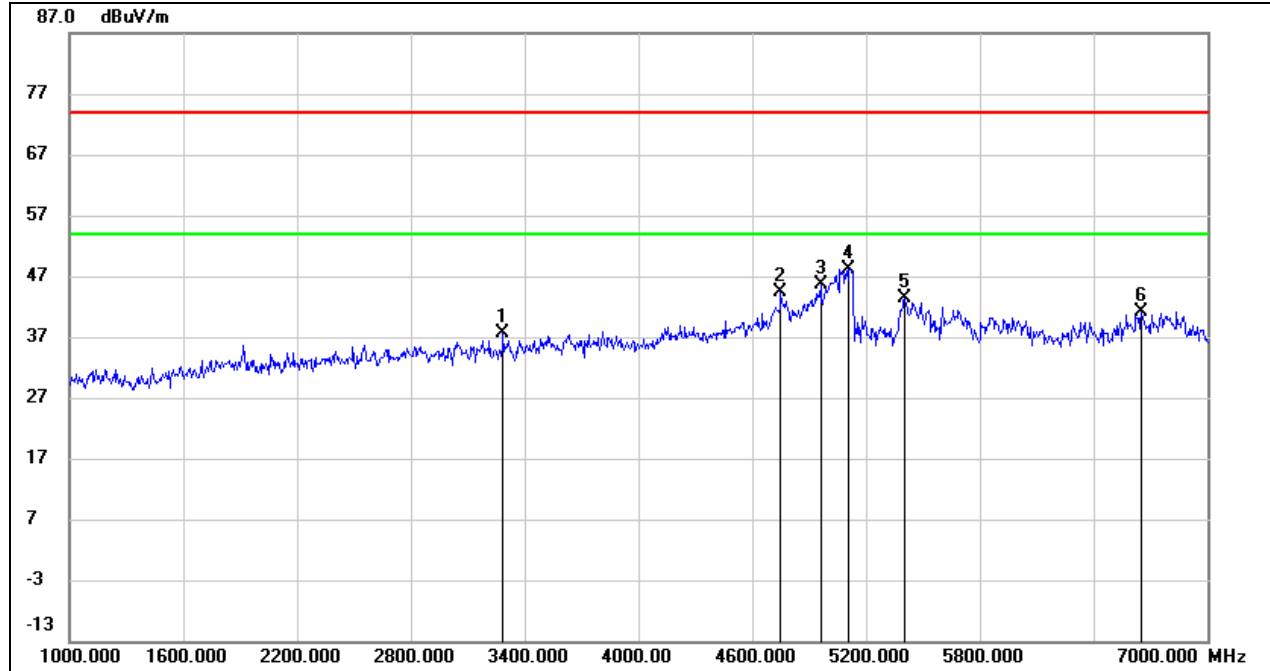
**HARMONICS AND SPURIOUS EMISSIONS (LOW CHANNEL, VERTICAL)**

No.	Frequency (MHz)	Reading (dBuV)	Correct (dB/m)	Result (dBuV/m)	Limit (dBuV/m)	Margin (dB)	Remark
1	3286.000	42.78	-5.19	37.59	74.00	-36.41	peak
2	4750.000	44.08	0.30	44.38	74.00	-29.62	peak
3	4960.000	44.71	0.84	45.55	74.00	-28.45	peak
4	5110.000	46.65	1.55	48.20	74.00	-25.80	peak
5	5404.000	41.40	1.89	43.29	74.00	-30.71	peak
6	6652.000	35.55	5.52	41.07	74.00	-32.93	peak

- Note: 1. Measurement = Reading Level + Correct Factor.
 2. If Peak Result complies with AV limit, AV Result is deemed to comply with AV limit.
 3. Peak: Peak detector.
 4. AVG: $VBW=1/Ton$, where: Ton is the transmitting duration.
 5. For the transmitting duration, please refer to clause 7.1.
 6. Filter losses were only considered in the spurious frequency bands and the authorized band was not corrected for Band reject filter losses.
 7. Proper operation of the transmitter prior to adding the filter to the measurement chain.
 8. Since non-restricted band peak emissions are less than the average limit, they also comply with the -27dBm/MHz (68.2dBuV/m) limit.

HARMONICS AND SPURIOUS EMISSIONS (MID CHANNEL, HORIZONTAL)

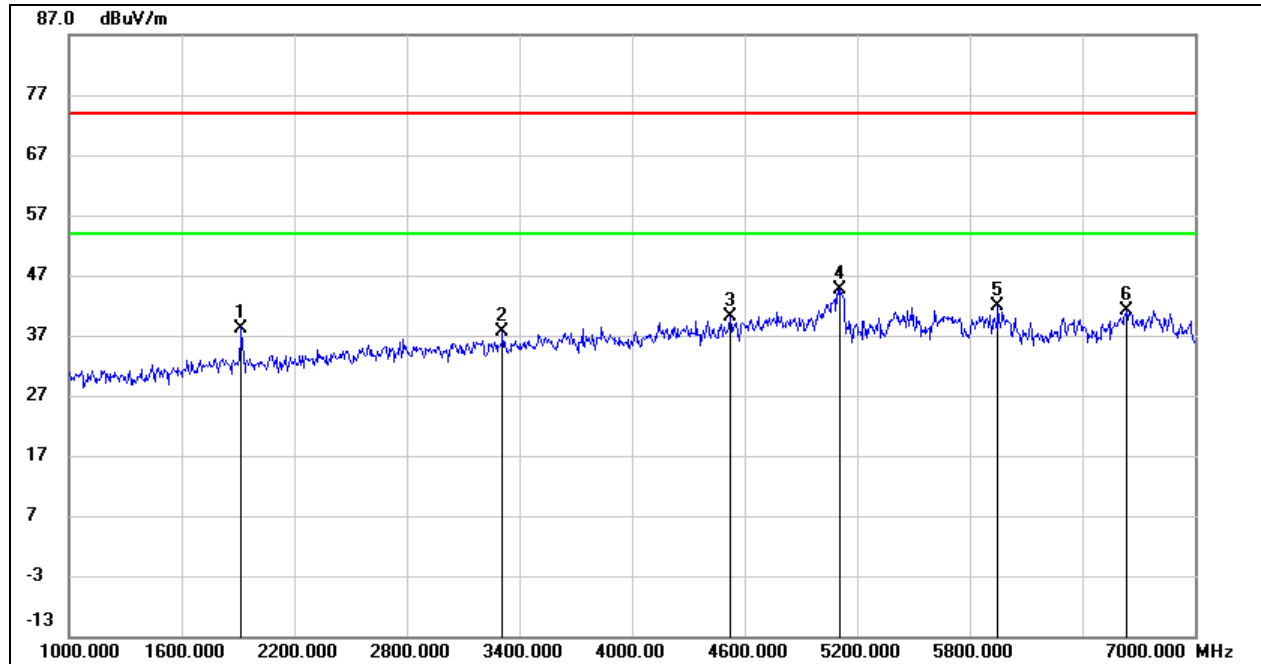

No.	Frequency (MHz)	Reading (dBuV)	Correct (dB/m)	Result (dBuV/m)	Limit (dBuV/m)	Margin (dB)	Remark
1	1918.000	48.38	-10.13	38.25	74.00	-35.75	peak
2	3310.000	42.81	-5.17	37.64	74.00	-36.36	peak
3	4522.000	41.18	-1.09	40.09	74.00	-33.91	peak
4	5110.000	43.16	1.55	44.71	74.00	-29.29	peak
5	5950.000	38.68	3.10	41.78	74.00	-32.22	peak
6	6634.000	35.72	5.51	41.23	74.00	-32.77	peak

Note: 1. Measurement = Reading Level + Correct Factor.

2. If Peak Result complies with AV limit, AV Result is deemed to comply with AV limit.

3. Peak: Peak detector.

4. AVG: $VBW=1/Ton$, where: Ton is the transmitting duration.

5. For the transmitting duration, please refer to clause 7.1.

6. Filter losses were only considered in the spurious frequency bands and the authorized band was not corrected for Band reject filter losses.

7. Proper operation of the transmitter prior to adding the filter to the measurement chain.

8. Since non-restricted band peak emissions are less than the average limit, they also comply with the -27dBm/MHz (68.2dBuV/m) limit.

HARMONICS AND SPURIOUS EMISSIONS (MID CHANNEL, VERTICAL)

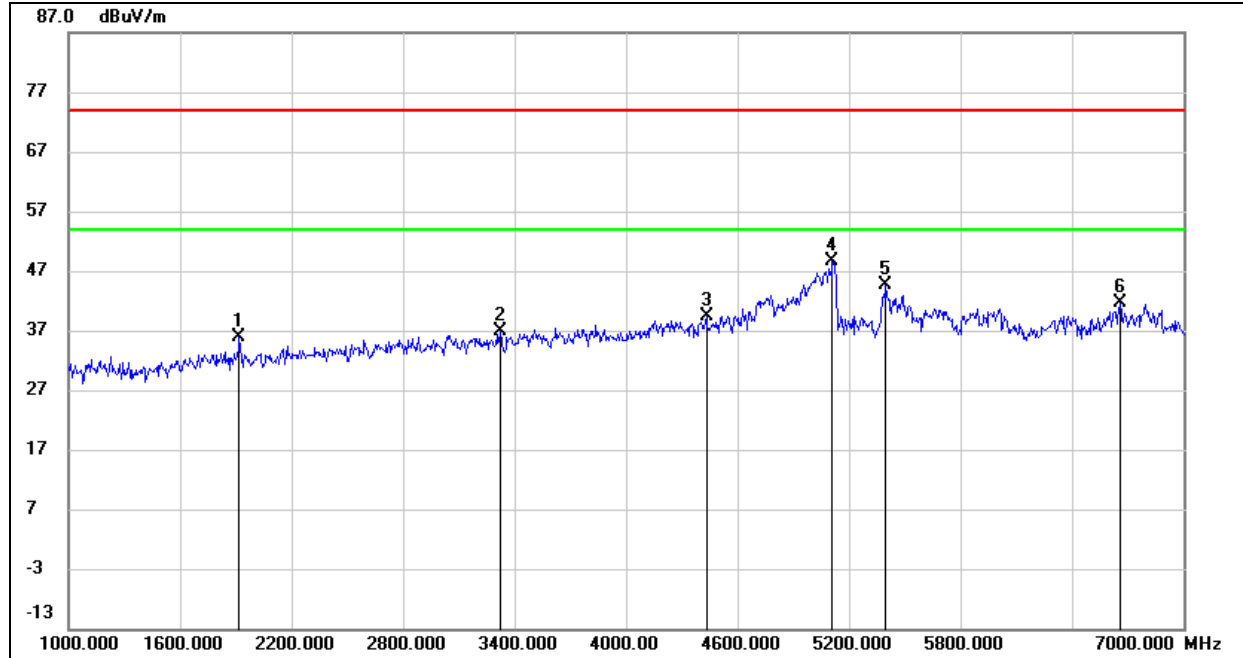

No.	Frequency (MHz)	Reading (dBuV)	Correct (dB/m)	Result (dBuV/m)	Limit (dBuV/m)	Margin (dB)	Remark
1	1918.000	45.97	-10.13	35.84	74.00	-38.16	peak
2	3322.000	42.04	-5.16	36.88	74.00	-37.12	peak
3	4432.000	41.00	-1.66	39.34	74.00	-34.66	peak
4	5110.000	47.12	1.55	48.67	74.00	-25.33	peak
5	5398.000	42.80	1.88	44.68	74.00	-29.32	peak
6	6658.000	36.11	5.51	41.62	74.00	-32.38	peak

- Note:
1. Measurement = Reading Level + Correct Factor.
 2. If Peak Result complies with AV limit, AV Result is deemed to comply with AV limit.
 3. Peak: Peak detector.
 4. AVG: $VBW=1/T_{on}$, where: T_{on} is the transmitting duration.
 5. For the transmitting duration, please refer to clause 7.1.
 6. Filter losses were only considered in the spurious frequency bands and the authorized band was not corrected for Band reject filter losses.
 7. Proper operation of the transmitter prior to adding the filter to the measurement chain.
 8. Since non-restricted band peak emissions are less than the average limit, they also comply with the -27dBm/MHz (68.2dBuV/m) limit.

HARMONICS AND SPURIOUS EMISSIONS (HIGH CHANNEL, HORIZONTAL)

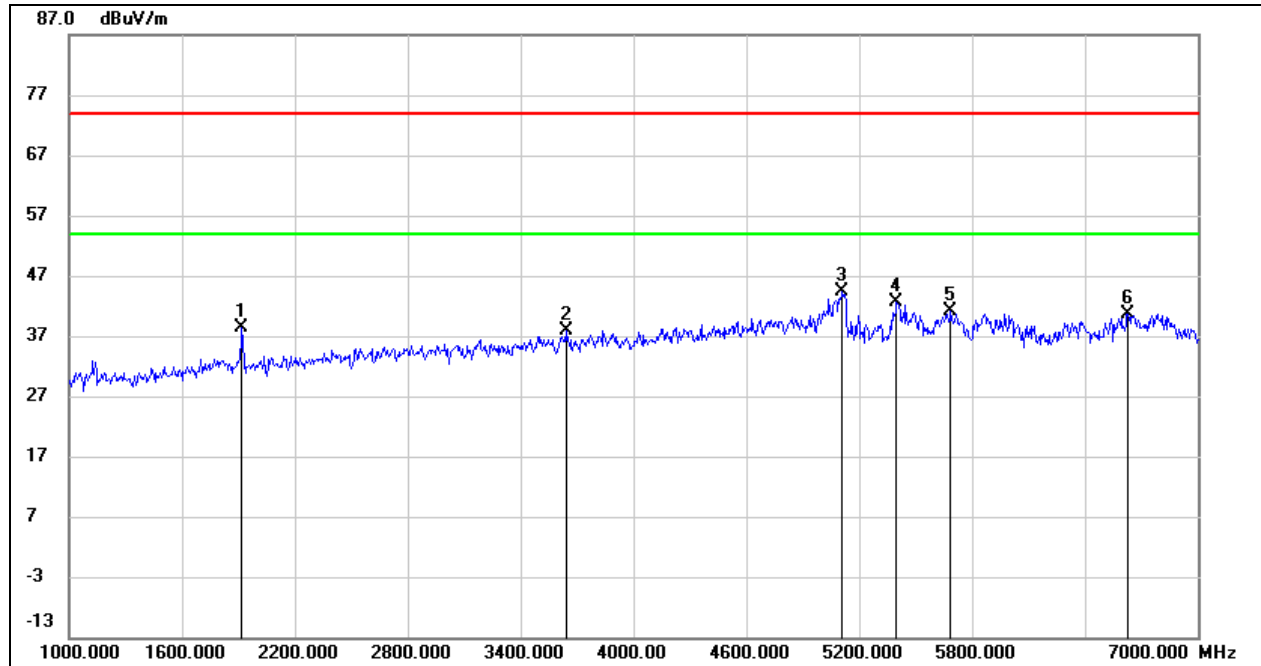

No.	Frequency (MHz)	Reading (dBuV)	Correct (dB/m)	Result (dBuV/m)	Limit (dBuV/m)	Margin (dB)	Remark
1	1918.000	48.41	-10.13	38.28	74.00	-35.72	peak
2	3640.000	41.86	-4.00	37.86	74.00	-36.14	peak
3	5110.000	42.87	1.55	44.42	74.00	-29.58	peak
4	5398.000	40.85	1.88	42.73	74.00	-31.27	peak
5	5686.000	38.65	2.47	41.12	74.00	-32.88	peak
6	6628.000	35.25	5.50	40.75	74.00	-33.25	peak

- Note: 1. Measurement = Reading Level + Correct Factor.
 2. If Peak Result complies with AV limit, AV Result is deemed to comply with AV limit.
 3. Peak: Peak detector.
 4. AVG: $VBW=1/Ton$, where: Ton is the transmitting duration.
 5. For the transmitting duration, please refer to clause 7.1.
 6. Filter losses were only considered in the spurious frequency bands and the authorized band was not corrected for Band reject filter losses.
 7. Proper operation of the transmitter prior to adding the filter to the measurement chain.
 8. Since non-restricted band peak emissions are less than the average limit, they also comply with the -27dBm/MHz (68.2dBuV/m) limit.

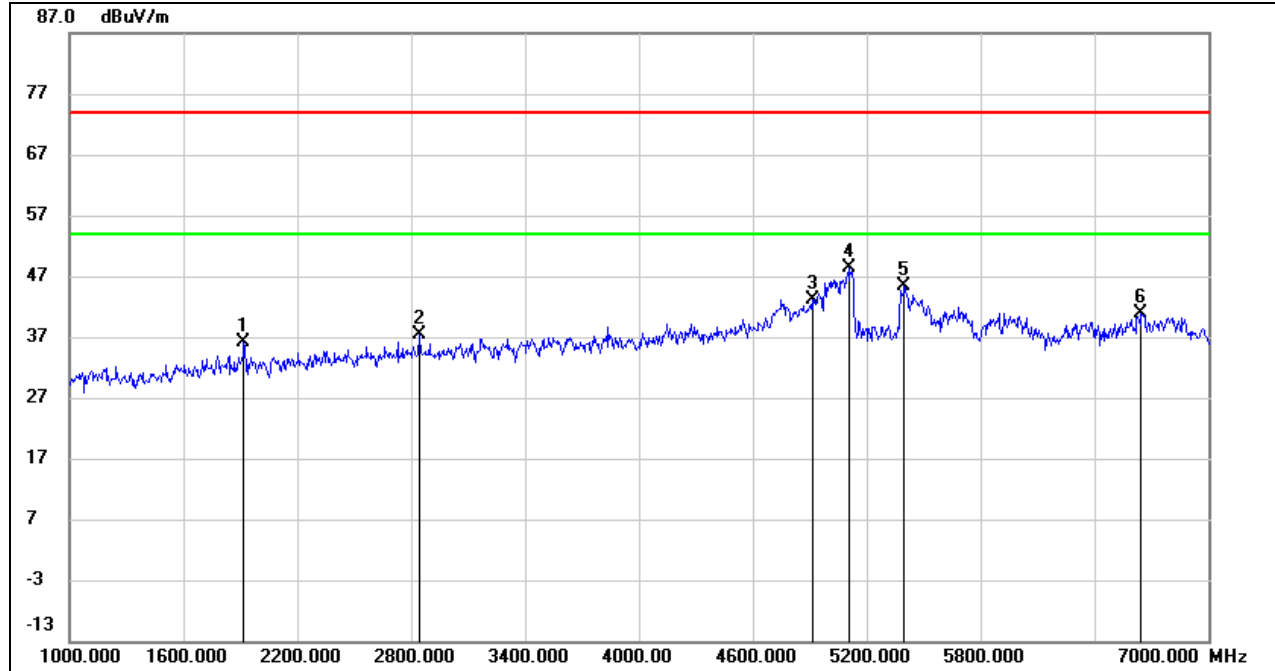
**HARMONICS AND SPURIOUS EMISSIONS (HIGH CHANNEL, VERTICAL)**

No.	Frequency (MHz)	Reading (dBuV)	Correct (dB/m)	Result (dBuV/m)	Limit (dBuV/m)	Margin (dB)	Remark
1	1918.000	46.33	-10.13	36.20	74.00	-37.80	peak
2	2842.000	43.75	-6.35	37.40	74.00	-36.60	peak
3	4912.000	42.36	0.77	43.13	74.00	-30.87	peak
4	5110.000	46.75	1.55	48.30	74.00	-25.70	peak
5	5398.000	43.39	1.88	45.27	74.00	-28.73	peak
6	6646.000	35.32	5.51	40.83	74.00	-33.17	peak

- Note: 1. Measurement = Reading Level + Correct Factor.
 2. If Peak Result complies with AV limit, AV Result is deemed to comply with AV limit.
 3. Peak: Peak detector.
 4. AVG: $VBW=1/Ton$, where: Ton is the transmitting duration.
 5. For the transmitting duration, please refer to clause 7.1.
 6. Filter losses were only considered in the spurious frequency bands and the authorized band was not corrected for Band reject filter losses.
 7. Proper operation of the transmitter prior to adding the filter to the measurement chain.
 8. Since non-restricted band peak emissions are less than the average limit, they also comply with the $-27dBm/MHz$ ($68.2dBuV/m$) limit.

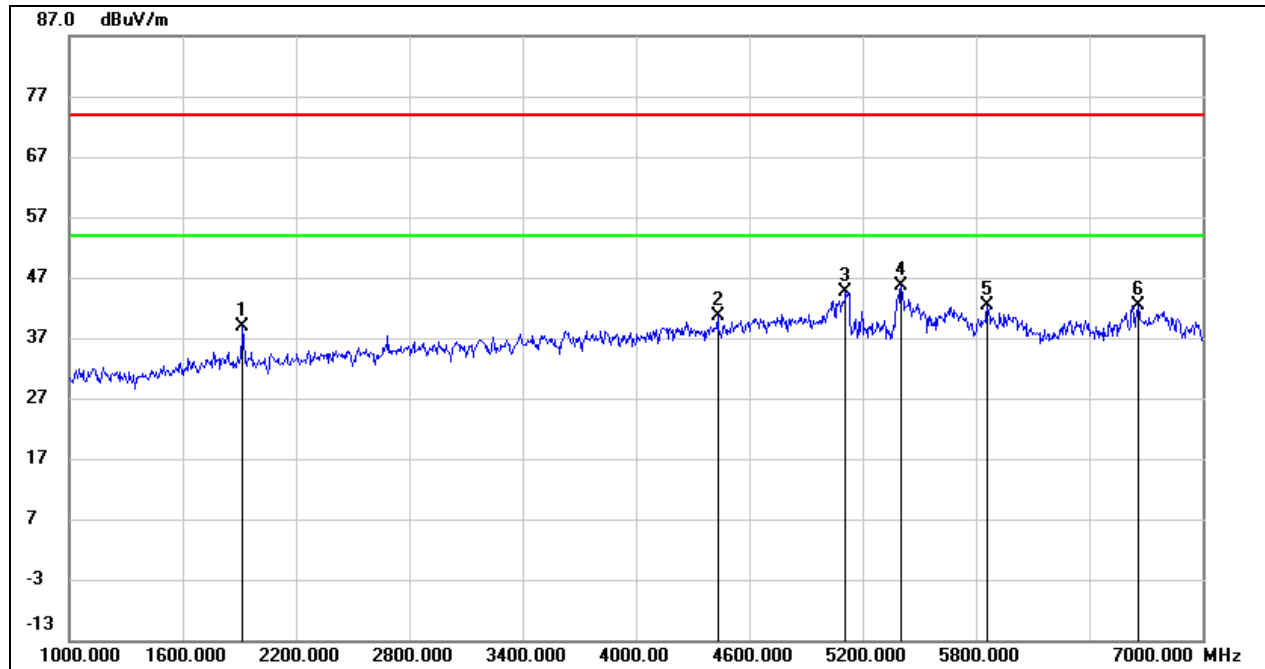
**UNII-2A BAND****HARMONICS AND SPURIOUS EMISSIONS (LOW CHANNEL, HORIZONTAL)**

No.	Frequency (MHz)	Reading (dBuV)	Correct (dB/m)	Result (dBuV/m)	Limit (dBuV/m)	Margin (dB)	Remark
1	1918.000	49.11	-10.13	38.98	74.00	-35.02	peak
2	4432.000	42.28	-1.66	40.62	74.00	-33.38	peak
3	5110.000	43.18	1.55	44.73	74.00	-29.27	peak
4	5404.000	43.66	1.89	45.55	74.00	-28.45	peak
5	5860.000	39.53	2.75	42.28	74.00	-31.72	peak
6	6658.000	36.81	5.51	42.32	74.00	-31.68	peak

Note: 1. Measurement = Reading Level + Correct Factor.

2. If Peak Result complies with AV limit, AV Result is deemed to comply with AV limit.

3. Peak: Peak detector.

4. AVG: $VBW=1/T_{on}$, where: T_{on} is the transmitting duration.

5. For the transmitting duration, please refer to clause 7.1.

6. Filter losses were only considered in the spurious frequency bands and the authorized band was not corrected for Band reject filter losses.

7. Proper operation of the transmitter prior to adding the filter to the measurement chain.

8. Since non-restricted band peak emissions are less than the average limit, they also comply with the -27dBm/MHz (68.2dBuV/m) limit.

HARMONICS AND SPURIOUS EMISSIONS (LOW CHANNEL, VERTICAL)

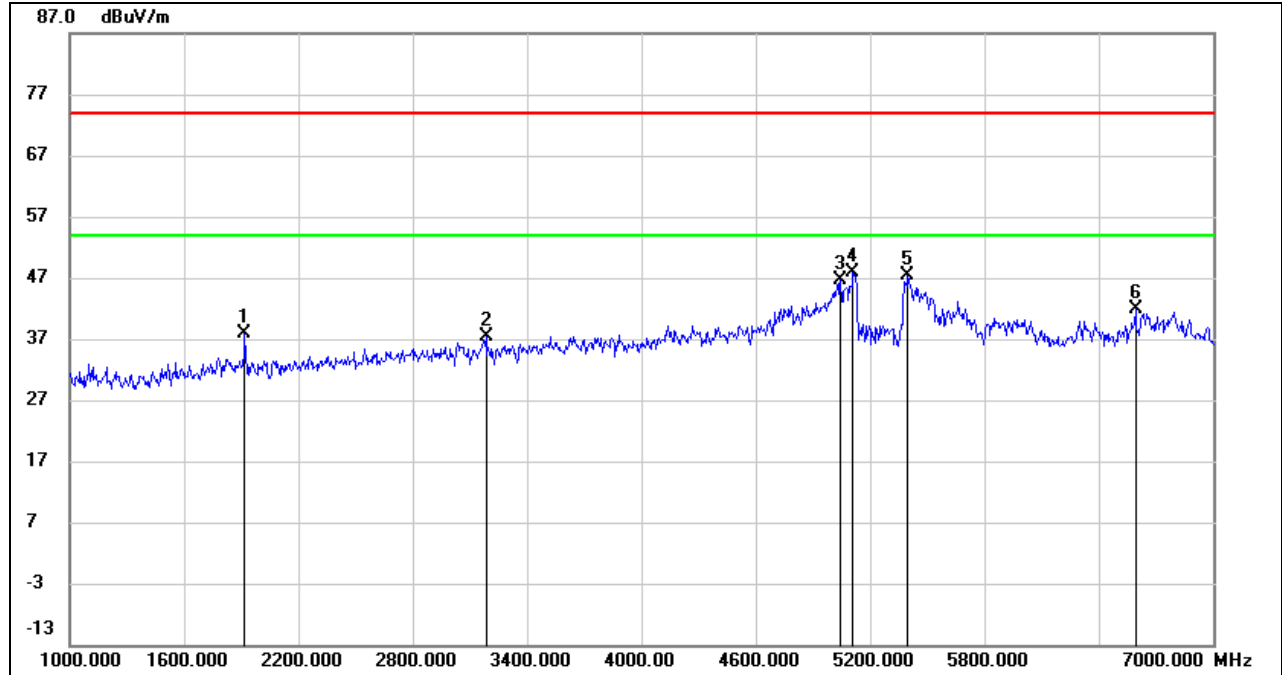

No.	Frequency (MHz)	Reading (dBuV)	Correct (dB/m)	Result (dBuV/m)	Limit (dBuV/m)	Margin (dB)	Remark
1	1918.000	47.97	-10.13	37.84	74.00	-36.16	peak
2	3184.000	42.63	-5.28	37.35	74.00	-36.65	peak
3	5044.000	45.53	1.16	46.69	74.00	-27.31	peak
4	5110.000	46.29	1.55	47.84	74.00	-26.16	peak
5	5398.000	45.45	1.88	47.33	74.00	-26.67	peak
6	6592.000	36.51	5.45	41.96	74.00	-32.04	peak

- Note:
1. Measurement = Reading Level + Correct Factor.
 2. If Peak Result complies with AV limit, AV Result is deemed to comply with AV limit.
 3. Peak: Peak detector.
 4. AVG: $VBW=1/Ton$, where: Ton is the transmitting duration.
 5. For the transmitting duration, please refer to clause 7.1.
 6. Filter losses were only considered in the spurious frequency bands and the authorized band was not corrected for Band reject filter losses.
 7. Proper operation of the transmitter prior to adding the filter to the measurement chain.
 8. Since non-restricted band peak emissions are less than the average limit, they also comply with the -27dBm/MHz (68.2dBuV/m) limit.

HARMONICS AND SPURIOUS EMISSIONS (MID CHANNEL, HORIZONTAL)

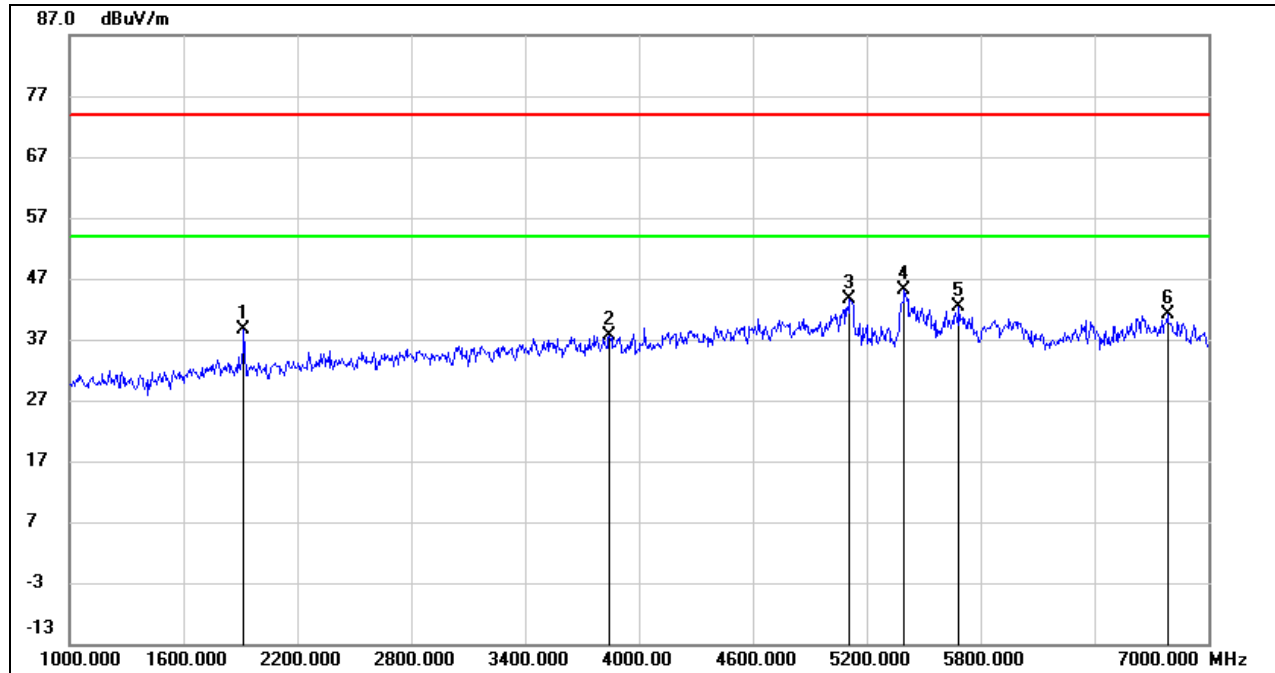

No.	Frequency (MHz)	Reading (dBuV)	Correct (dB/m)	Result (dBuV/m)	Limit (dBuV/m)	Margin (dB)	Remark
1	1918.000	48.72	-10.13	38.59	74.00	-35.41	peak
2	3844.000	40.95	-3.33	37.62	74.00	-36.38	peak
3	5110.000	42.02	1.55	43.57	74.00	-30.43	peak
4	5398.000	43.17	1.88	45.05	74.00	-28.95	peak
5	5686.000	39.96	2.47	42.43	74.00	-31.57	peak
6	6784.000	35.45	5.56	41.01	74.00	-32.99	peak

- Note:
1. Measurement = Reading Level + Correct Factor.
 2. If Peak Result complies with AV limit, AV Result is deemed to comply with AV limit.
 3. Peak: Peak detector.
 4. AVG: $VBW=1/Ton$, where: Ton is the transmitting duration.
 5. For the transmitting duration, please refer to clause 7.1.
 6. Filter losses were only considered in the spurious frequency bands and the authorized band was not corrected for Band reject filter losses.
 7. Proper operation of the transmitter prior to adding the filter to the measurement chain.
 8. Since non-restricted band peak emissions are less than the average limit, they also comply with the $-27dBm/MHz$ ($68.2dBuV/m$) limit.

HARMONICS AND SPURIOUS EMISSIONS (MID CHANNEL, VERTICAL)

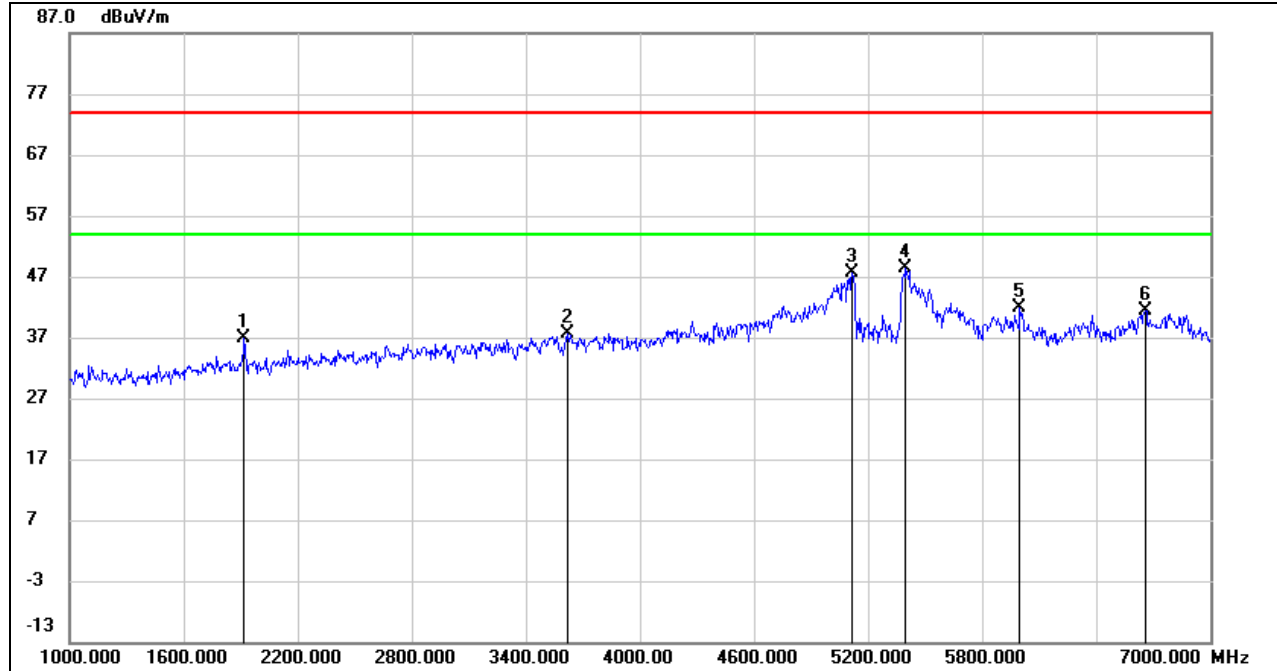

No.	Frequency (MHz)	Reading (dBuV)	Correct (dB/m)	Result (dBuV/m)	Limit (dBuV/m)	Margin (dB)	Remark
1	1918.000	46.91	-10.13	36.78	74.00	-37.22	peak
2	3616.000	41.75	-4.12	37.63	74.00	-36.37	peak
3	5116.000	45.95	1.60	47.55	74.00	-26.45	peak
4	5398.000	46.54	1.88	48.42	74.00	-25.58	peak
5	5998.000	38.63	3.30	41.93	74.00	-32.07	peak
6	6658.000	35.82	5.51	41.33	74.00	-32.67	peak

- Note:
1. Measurement = Reading Level + Correct Factor.
 2. If Peak Result complies with AV limit, AV Result is deemed to comply with AV limit.
 3. Peak: Peak detector.
 4. AVG: $VBW=1/Ton$, where: Ton is the transmitting duration.
 5. For the transmitting duration, please refer to clause 7.1.
 6. Filter losses were only considered in the spurious frequency bands and the authorized band was not corrected for Band reject filter losses.
 7. Proper operation of the transmitter prior to adding the filter to the measurement chain.
 8. Since non-restricted band peak emissions are less than the average limit, they also comply with the -27dBm/MHz (68.2dBuV/m) limit.

HARMONICS AND SPURIOUS EMISSIONS (HIGH CHANNEL, HORIZONTAL)

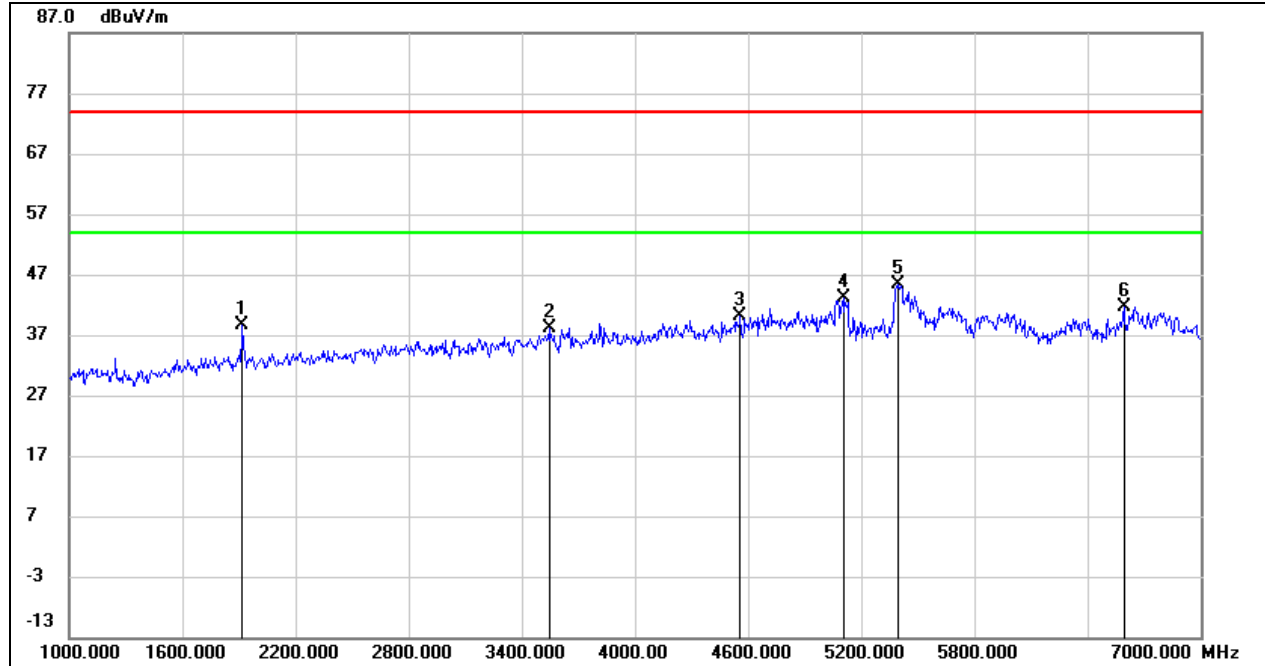

No.	Frequency (MHz)	Reading (dBuV)	Correct (dB/m)	Result (dBuV/m)	Limit (dBuV/m)	Margin (dB)	Remark
1	1918.000	48.75	-10.13	38.62	74.00	-35.38	peak
2	3544.000	42.67	-4.48	38.19	74.00	-35.81	peak
3	4558.000	41.06	-0.84	40.22	74.00	-33.78	peak
4	5110.000	41.56	1.55	43.11	74.00	-30.89	peak
5	5398.000	43.56	1.88	45.44	74.00	-28.56	peak
6	6592.000	36.18	5.45	41.63	74.00	-32.37	peak

- Note: 1. Measurement = Reading Level + Correct Factor.
 2. If Peak Result complies with AV limit, AV Result is deemed to comply with AV limit.
 3. Peak: Peak detector.
 4. AVG: $VBW=1/T_{on}$, where: T_{on} is the transmitting duration.
 5. For the transmitting duration, please refer to clause 7.1.
 6. Filter losses were only considered in the spurious frequency bands and the authorized band was not corrected for Band reject filter losses.
 7. Proper operation of the transmitter prior to adding the filter to the measurement chain.
 8. Since non-restricted band peak emissions are less than the average limit, they also comply with the -27dBm/MHz (68.2dBuV/m) limit.

HARMONICS AND SPURIOUS EMISSIONS (HIGH CHANNEL, VERTICAL)

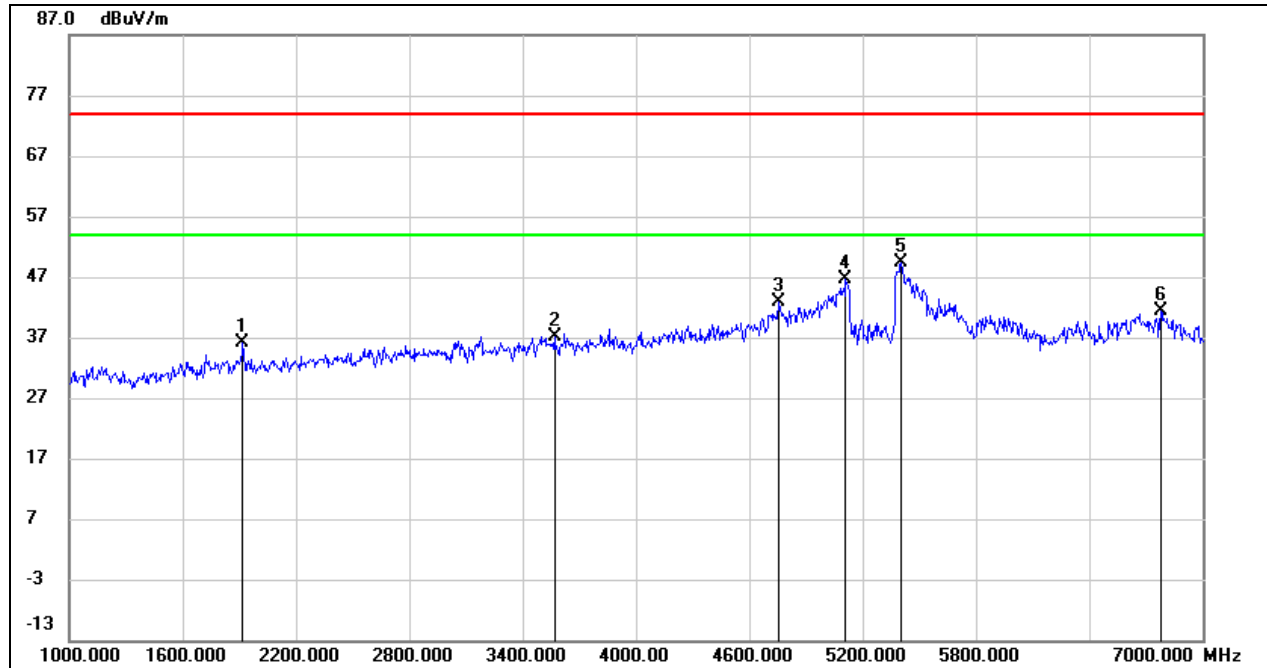

No.	Frequency (MHz)	Reading (dBuV)	Correct (dB/m)	Result (dBuV/m)	Limit (dBuV/m)	Margin (dB)	Remark
1	1918.000	46.25	-10.13	36.12	74.00	-37.88	peak
2	3568.000	41.56	-4.35	37.21	74.00	-36.79	peak
3	4756.000	42.43	0.33	42.76	74.00	-31.24	peak
4	5110.000	45.03	1.55	46.58	74.00	-27.42	peak
5	5404.000	47.49	1.89	49.38	74.00	-24.62	peak
6	6778.000	35.75	5.56	41.31	74.00	-32.69	peak

- Note: 1. Measurement = Reading Level + Correct Factor.
 2. If Peak Result complies with AV limit, AV Result is deemed to comply with AV limit.
 3. Peak: Peak detector.
 4. AVG: $VBW=1/Ton$, where: Ton is the transmitting duration.
 5. For the transmitting duration, please refer to clause 7.1.
 6. Filter losses were only considered in the spurious frequency bands and the authorized band was not corrected for Band reject filter losses.
 7. Proper operation of the transmitter prior to adding the filter to the measurement chain.
 8. Since non-restricted band peak emissions are less than the average limit, they also comply with the -27dBm/MHz (68.2dBuV/m) limit.



UNII-2C BAND

HARMONICS AND SPURIOUS EMISSIONS (LOW CHANNEL, HORIZONTAL)

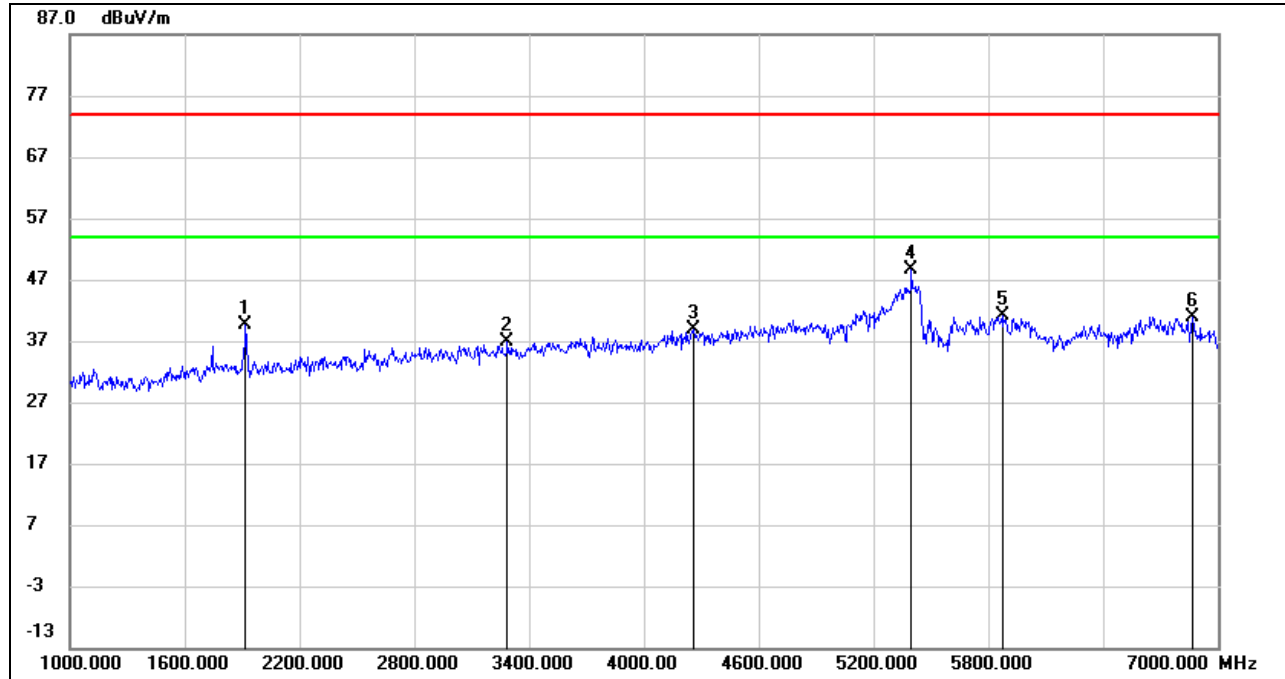

No.	Frequency (MHz)	Reading (dBuV)	Correct (dB/m)	Result (dBuV/m)	Limit (dBuV/m)	Margin (dB)	Remark
1	1918.000	49.70	-10.13	39.57	74.00	-34.43	peak
2	3286.000	42.13	-5.19	36.94	74.00	-37.06	peak
3	4258.000	40.68	-1.73	38.95	74.00	-35.05	peak
4	5398.000	46.64	1.88	48.52	74.00	-25.48	peak
5	5872.000	38.21	2.80	41.01	74.00	-32.99	peak
6	6868.000	35.07	5.76	40.83	74.00	-33.17	peak

- Note: 1. Measurement = Reading Level + Correct Factor.
 2. If Peak Result complies with AV limit, AV Result is deemed to comply with AV limit.
 3. Peak: Peak detector.
 4. AVG: $VBW=1/Ton$, where: Ton is the transmitting duration.
 5. For the transmitting duration, please refer to clause 7.1.
 6. Filter losses were only considered in the spurious frequency bands and the authorized band was not corrected for Band reject filter losses.
 7. Proper operation of the transmitter prior to adding the filter to the measurement chain.
 8. Since non-restricted band peak emissions are less than the average limit, they also comply with the -27dBm/MHz (68.2dBuV/m) limit.

HARMONICS AND SPURIOUS EMISSIONS (LOW CHANNEL, VERTICAL)

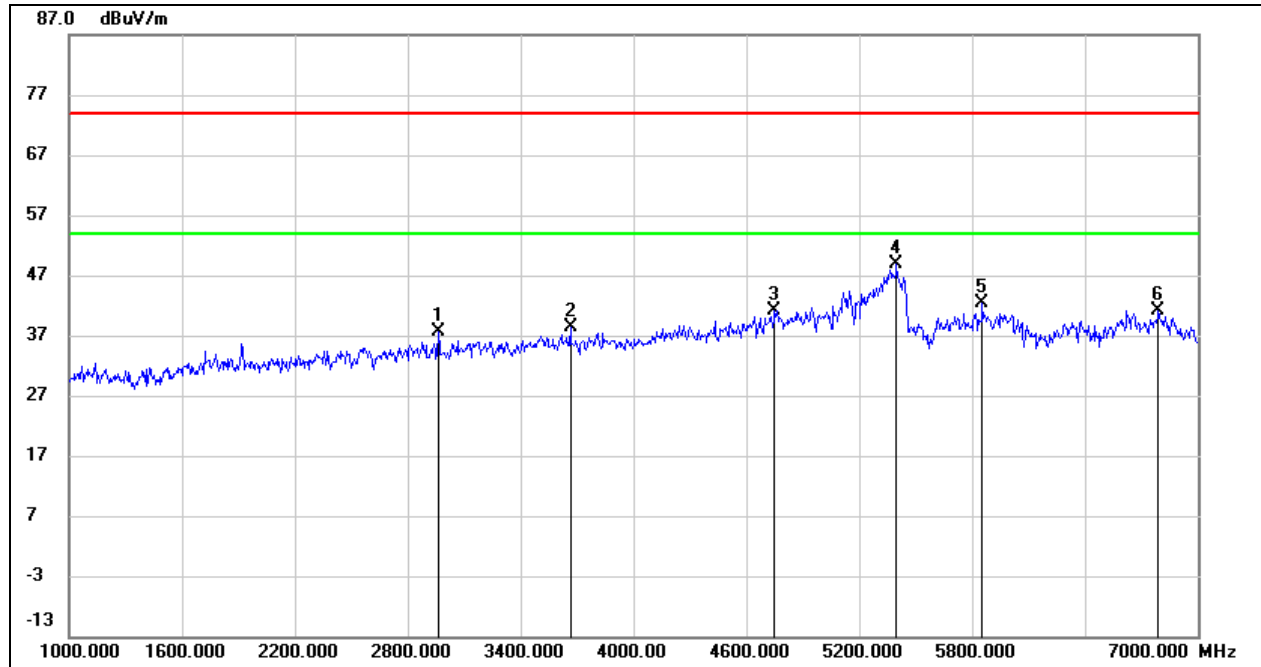

No.	Frequency (MHz)	Reading (dBuV)	Correct (dB/m)	Result (dBuV/m)	Limit (dBuV/m)	Margin (dB)	Remark
1	2962.000	43.31	-5.78	37.53	74.00	-36.47	peak
2	3664.000	42.22	-3.89	38.33	74.00	-35.67	peak
3	4750.000	40.81	0.30	41.11	74.00	-32.89	peak
4	5398.000	47.00	1.88	48.88	74.00	-25.12	peak
5	5854.000	39.76	2.71	42.47	74.00	-31.53	peak
6	6790.000	35.65	5.57	41.22	74.00	-32.78	peak

Note: 1. Measurement = Reading Level + Correct Factor.

2. If Peak Result complies with AV limit, AV Result is deemed to comply with AV limit.

3. Peak: Peak detector.

4. AVG: $VBW=1/Ton$, where: Ton is the transmitting duration.

5. For the transmitting duration, please refer to clause 7.1.

6. Filter losses were only considered in the spurious frequency bands and the authorized band was not corrected for Band reject filter losses.

7. Proper operation of the transmitter prior to adding the filter to the measurement chain.

8. Since non-restricted band peak emissions are less than the average limit, they also comply with the -27dBm/MHz (68.2dBuV/m) limit.

HARMONICS AND SPURIOUS EMISSIONS (MID CHANNEL, HORIZONTAL)

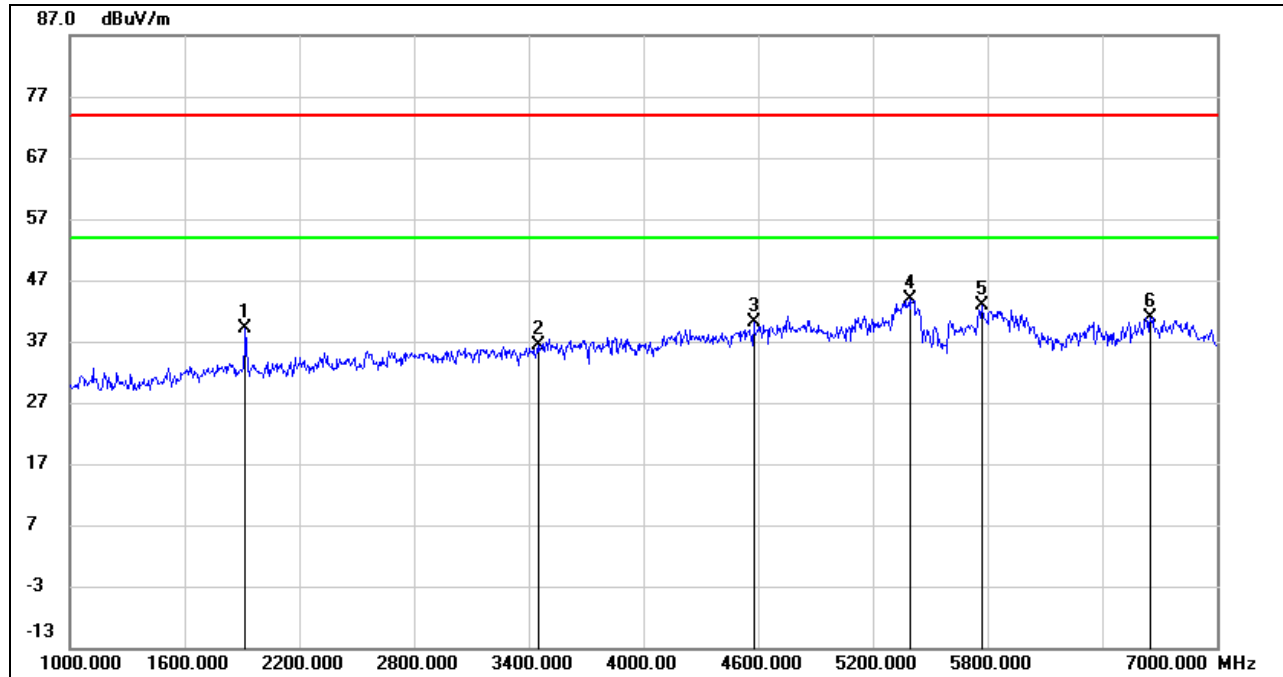

No.	Frequency (MHz)	Reading (dBuV)	Correct (dB/m)	Result (dBuV/m)	Limit (dBuV/m)	Margin (dB)	Remark
1	1918.000	49.31	-10.13	39.18	74.00	-34.82	peak
2	3448.000	41.17	-4.91	36.26	74.00	-37.74	peak
3	4576.000	40.97	-0.73	40.24	74.00	-33.76	peak
4	5398.000	41.92	1.88	43.80	74.00	-30.20	peak
5	5770.000	40.28	2.50	42.78	74.00	-31.22	peak
6	6652.000	35.47	5.52	40.99	74.00	-33.01	peak

- Note:
1. Measurement = Reading Level + Correct Factor.
 2. If Peak Result complies with AV limit, AV Result is deemed to comply with AV limit.
 3. Peak: Peak detector.
 4. AVG: $VBW=1/Ton$, where: Ton is the transmitting duration.
 5. For the transmitting duration, please refer to clause 7.1.
 6. Filter losses were only considered in the spurious frequency bands and the authorized band was not corrected for Band reject filter losses.
 7. Proper operation of the transmitter prior to adding the filter to the measurement chain.
 8. Since non-restricted band peak emissions are less than the average limit, they also comply with the -27dBm/MHz (68.2dBuV/m) limit.

HARMONICS AND SPURIOUS EMISSIONS (MID CHANNEL, VERTICAL)

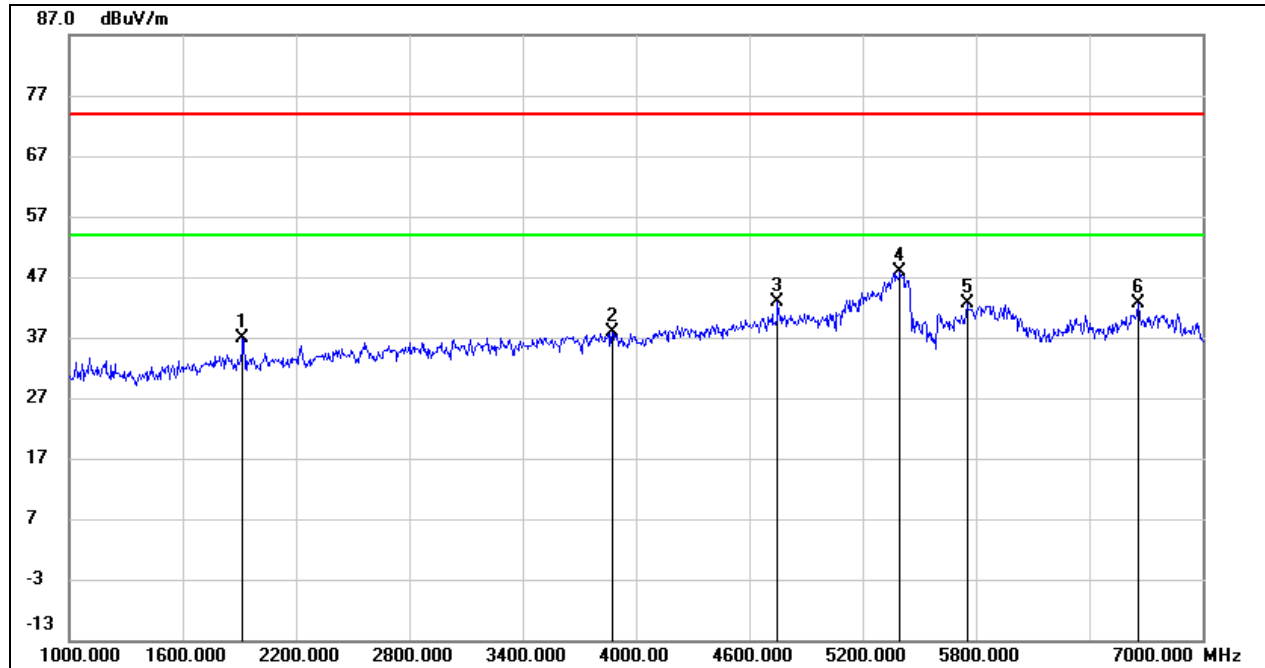

No.	Frequency (MHz)	Reading (dBuV)	Correct (dB/m)	Result (dBuV/m)	Limit (dBuV/m)	Margin (dB)	Remark
1	1918.000	47.11	-10.13	36.98	74.00	-37.02	peak
2	3874.000	41.28	-3.38	37.90	74.00	-36.10	peak
3	4750.000	42.59	0.30	42.89	74.00	-31.11	peak
4	5398.000	46.02	1.88	47.90	74.00	-26.10	peak
5	5752.000	40.08	2.49	42.57	74.00	-31.43	peak
6	6658.000	37.20	5.51	42.71	74.00	-31.29	peak

- Note: 1. Measurement = Reading Level + Correct Factor.
 2. If Peak Result complies with AV limit, AV Result is deemed to comply with AV limit.
 3. Peak: Peak detector.
 4. AVG: $VBW=1/Ton$, where: Ton is the transmitting duration.
 5. For the transmitting duration, please refer to clause 7.1.
 6. Filter losses were only considered in the spurious frequency bands and the authorized band was not corrected for Band reject filter losses.
 7. Proper operation of the transmitter prior to adding the filter to the measurement chain.
 8. Since non-restricted band peak emissions are less than the average limit, they also comply with the -27dBm/MHz (68.2dBuV/m) limit.

HARMONICS AND SPURIOUS EMISSIONS (HIGH CHANNEL, HORIZONTAL)

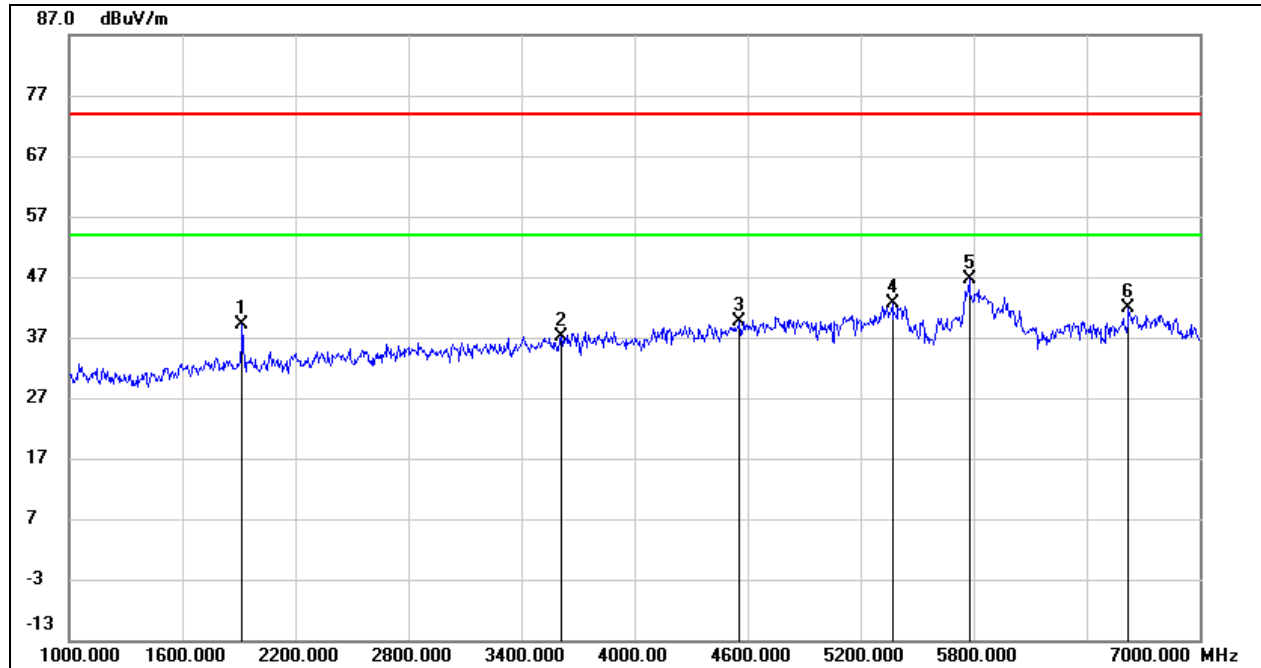

No.	Frequency (MHz)	Reading (dBuV)	Correct (dB/m)	Result (dBuV/m)	Limit (dBuV/m)	Margin (dB)	Remark
1	1918.000	49.30	-10.13	39.17	74.00	-34.83	peak
2	3610.000	41.20	-4.14	37.06	74.00	-36.94	peak
3	4558.000	40.58	-0.84	39.74	74.00	-34.26	peak
4	5368.000	40.64	1.90	42.54	74.00	-31.46	peak
5	5776.000	44.01	2.50	46.51	74.00	-27.49	peak
6	6622.000	36.42	5.51	41.93	74.00	-32.07	peak

- Note: 1. Measurement = Reading Level + Correct Factor.
 2. If Peak Result complies with AV limit, AV Result is deemed to comply with AV limit.
 3. Peak: Peak detector.
 4. AVG: $VBW=1/T_{on}$, where: T_{on} is the transmitting duration.
 5. For the transmitting duration, please refer to clause 7.1.
 6. Filter losses were only considered in the spurious frequency bands and the authorized band was not corrected for Band reject filter losses.
 7. Proper operation of the transmitter prior to adding the filter to the measurement chain.
 8. Since non-restricted band peak emissions are less than the average limit, they also comply with the -27dBm/MHz (68.2dBuV/m) limit.

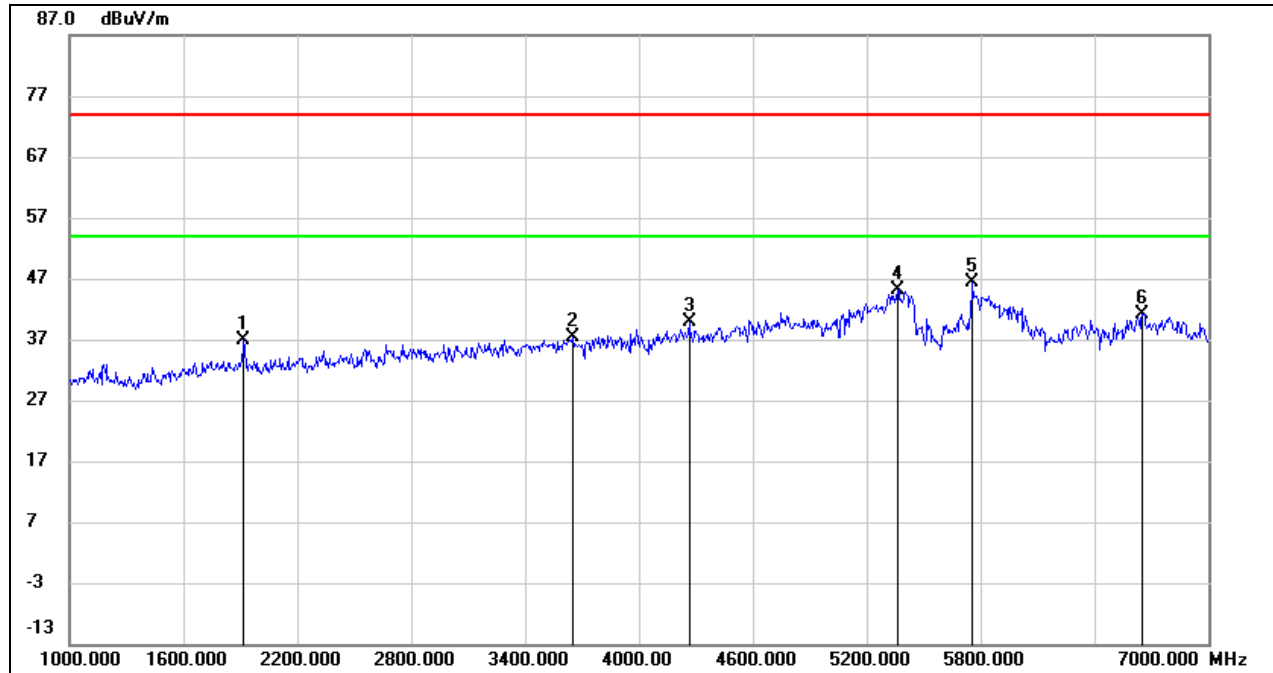
**HARMONICS AND SPURIOUS EMISSIONS (HIGH CHANNEL, VERTICAL)**

No.	Frequency (MHz)	Reading (dBuV)	Correct (dB/m)	Result (dBuV/m)	Limit (dBuV/m)	Margin (dB)	Remark
1	1918.000	47.03	-10.13	36.90	74.00	-37.10	peak
2	3652.000	41.38	-3.96	37.42	74.00	-36.58	peak
3	4264.000	41.53	-1.73	39.80	74.00	-34.20	peak
4	5362.000	43.27	1.91	45.18	74.00	-28.82	peak
5	5758.000	43.94	2.50	46.44	74.00	-27.56	peak
6	6652.000	35.67	5.52	41.19	74.00	-32.81	peak

- Note:
1. Measurement = Reading Level + Correct Factor.
 2. If Peak Result complies with AV limit, AV Result is deemed to comply with AV limit.
 3. Peak: Peak detector.
 4. AVG: $VBW=1/Ton$, where: Ton is the transmitting duration.
 5. For the transmitting duration, please refer to clause 7.1.
 6. Filter losses were only considered in the spurious frequency bands and the authorized band was not corrected for Band reject filter losses.
 7. Proper operation of the transmitter prior to adding the filter to the measurement chain.
 8. Since non-restricted band peak emissions are less than the average limit, they also comply with the $-27dBm/MHz$ ($68.2dBuV/m$) limit.



UNII-3 BAND

HARMONICS AND SPURIOUS EMISSIONS (LOW CHANNEL, HORIZONTAL)

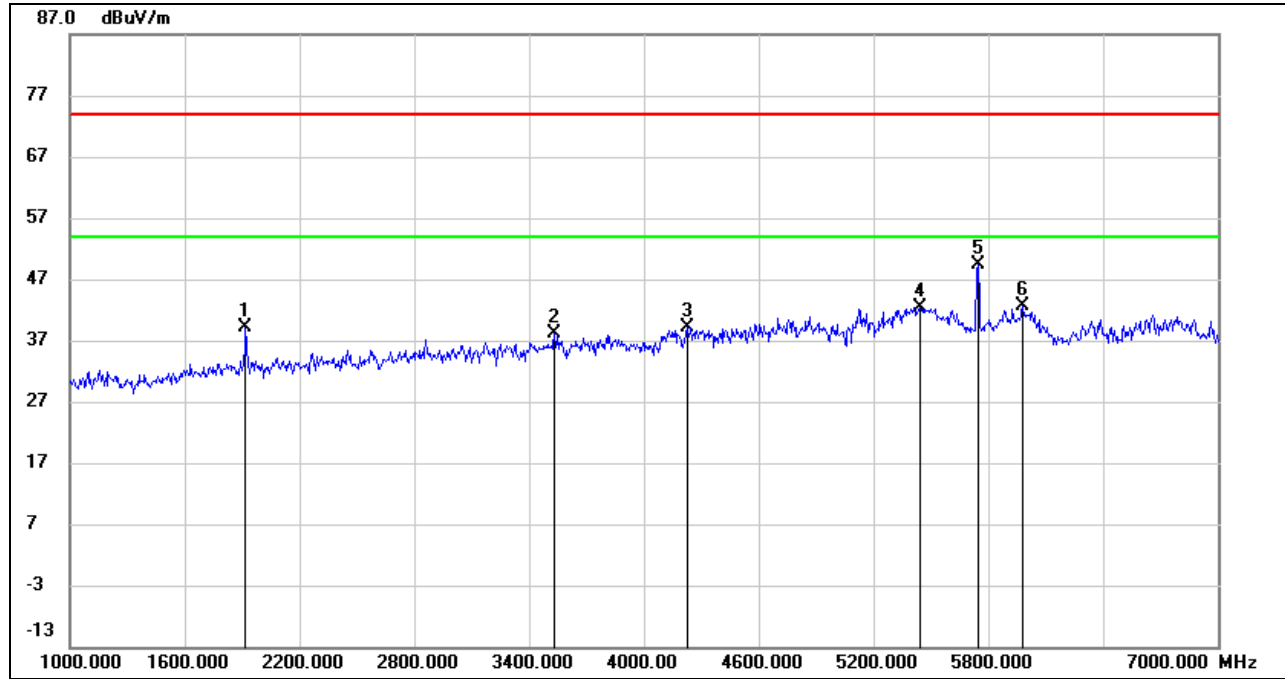

No.	Frequency (MHz)	Reading (dBuV)	Correct (dB/m)	Result (dBuV/m)	Limit (dBuV/m)	Margin (dB)	Remark
1	1918.000	49.21	-10.13	39.08	74.00	-34.92	peak
2	3532.000	42.73	-4.55	38.18	74.00	-35.82	peak
3	4228.000	40.85	-1.70	39.15	74.00	-34.85	peak
4	5440.000	40.37	2.00	42.37	74.00	-31.63	peak
5	5745.000	46.87	2.49	49.36	74.00	-24.64	peak
6	5980.000	39.42	3.22	42.64	74.00	-31.36	peak

- Note: 1. Measurement = Reading Level + Correct Factor.
 2. If Peak Result complies with AV limit, AV Result is deemed to comply with AV limit.
 3. Peak: Peak detector.
 4. AVG: $VBW=1/Ton$, where: Ton is the transmitting duration.
 5. For the transmitting duration, please refer to clause 7.1.
 6. Filter losses were only considered in the spurious frequency bands and the authorized band was not corrected for Band reject filter losses.
 7. Proper operation of the transmitter prior to adding the filter to the measurement chain.
 8. Since non-restricted band peak emissions are less than the average limit, they also comply with the -27dBm/MHz (68.2dBuV/m) limit.

HARMONICS AND SPURIOUS EMISSIONS (LOW CHANNEL, VERTICAL)

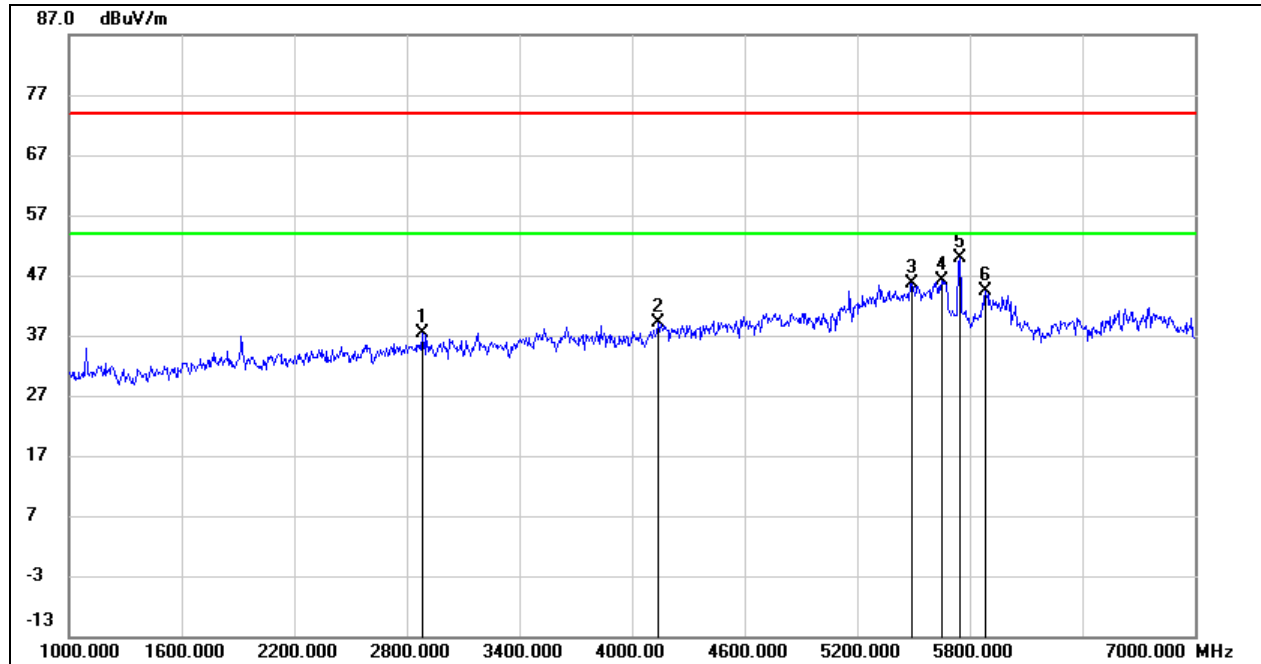

No.	Frequency (MHz)	Reading (dBuV)	Correct (dB/m)	Result (dBuV/m)	Limit (dBuV/m)	Margin (dB)	Remark
1	2884.000	43.63	-6.15	37.48	74.00	-36.52	peak
2	4138.000	41.29	-2.27	39.02	74.00	-34.98	peak
3	5494.000	43.55	2.14	45.69	74.00	-28.31	peak
4	5650.000	43.55	2.47	46.02	74.00	-27.98	peak
5	5745.000	47.47	2.49	49.96	74.00	-24.04	peak
6	5884.000	41.48	2.84	44.32	74.00	-29.68	peak

Note: 1. Measurement = Reading Level + Correct Factor.

2. If Peak Result complies with AV limit, AV Result is deemed to comply with AV limit.

3. Peak: Peak detector.

4. AVG: $VBW=1/Ton$, where: Ton is the transmitting duration.

5. For the transmitting duration, please refer to clause 7.1.

6. Filter losses were only considered in the spurious frequency bands and the authorized band was not corrected for Band reject filter losses.

7. Proper operation of the transmitter prior to adding the filter to the measurement chain.

8. Since non-restricted band peak emissions are less than the average limit, they also comply with the -27dBm/MHz (68.2dBuV/m) limit.

HARMONICS AND SPURIOUS EMISSIONS (MID CHANNEL, HORIZONTAL)

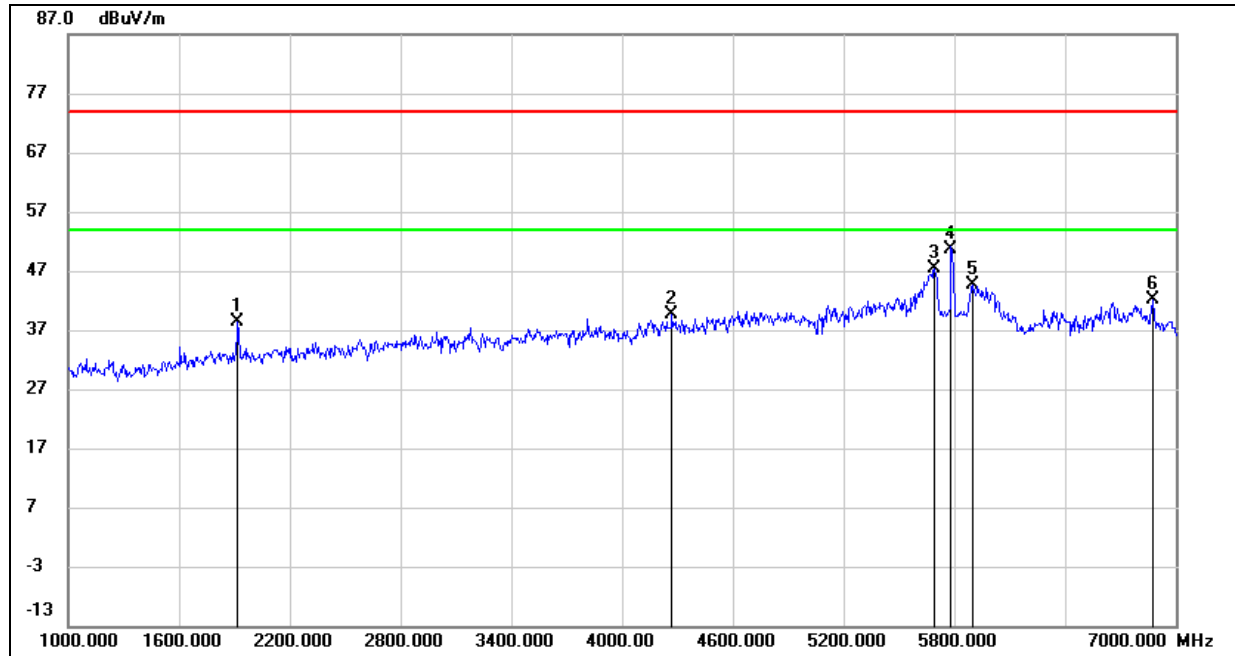

No.	Frequency (MHz)	Reading (dBuV)	Correct (dB/m)	Result (dBuV/m)	Limit (dBuV/m)	Margin (dB)	Remark
1	1918.000	48.55	-10.13	38.42	74.00	-35.58	peak
2	4270.000	41.30	-1.73	39.57	74.00	-34.43	peak
3	5692.000	44.98	2.47	47.45	74.00	-26.55	peak
4	5785.000	48.21	2.50	50.71	74.00	-23.29	peak
5	5896.000	41.65	2.90	44.55	74.00	-29.45	peak
6	6874.000	36.30	5.78	42.08	74.00	-31.92	peak

Note: 1. Measurement = Reading Level + Correct Factor.

2. If Peak Result complies with AV limit, AV Result is deemed to comply with AV limit.

3. Peak: Peak detector.

4. AVG: $VBW=1/T_{on}$, where: T_{on} is the transmitting duration.

5. For the transmitting duration, please refer to clause 7.1.

6. Filter losses were only considered in the spurious frequency bands and the authorized band was not corrected for Band reject filter losses.

7. Proper operation of the transmitter prior to adding the filter to the measurement chain.

8. Since non-restricted band peak emissions are less than the average limit, they also comply with the -27dBm/MHz (68.2dBuV/m) limit.

HARMONICS AND SPURIOUS EMISSIONS (MID CHANNEL, VERTICAL)

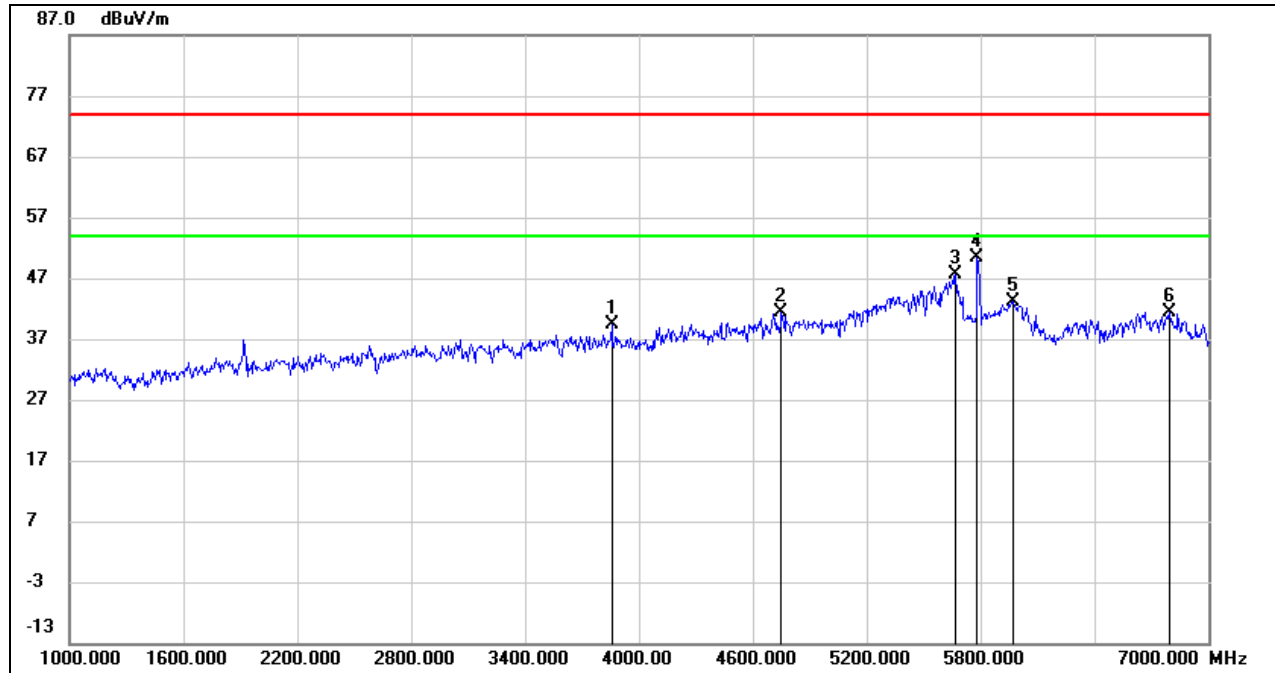

No.	Frequency (MHz)	Reading (dBuV)	Correct (dB/m)	Result (dBuV/m)	Limit (dBuV/m)	Margin (dB)	Remark
1	3856.000	42.66	-3.36	39.30	74.00	-34.70	peak
2	4750.000	41.06	0.30	41.36	74.00	-32.64	peak
3	5668.000	45.23	2.47	47.70	74.00	-26.30	peak
4	5782.000	47.82	2.50	50.32	74.00	-23.68	peak
5	5974.000	40.00	3.20	43.20	74.00	-30.80	peak
6	6796.000	35.87	5.57	41.44	74.00	-32.56	peak

- Note: 1. Measurement = Reading Level + Correct Factor.
 2. If Peak Result complies with AV limit, AV Result is deemed to comply with AV limit.
 3. Peak: Peak detector.
 4. AVG: $VBW=1/T_{on}$, where: T_{on} is the transmitting duration.
 5. For the transmitting duration, please refer to clause 7.1.
 6. Filter losses were only considered in the spurious frequency bands and the authorized band was not corrected for Band reject filter losses.
 7. Proper operation of the transmitter prior to adding the filter to the measurement chain.
 8. Since non-restricted band peak emissions are less than the average limit, they also comply with the -27dBm/MHz (68.2dBuV/m) limit.

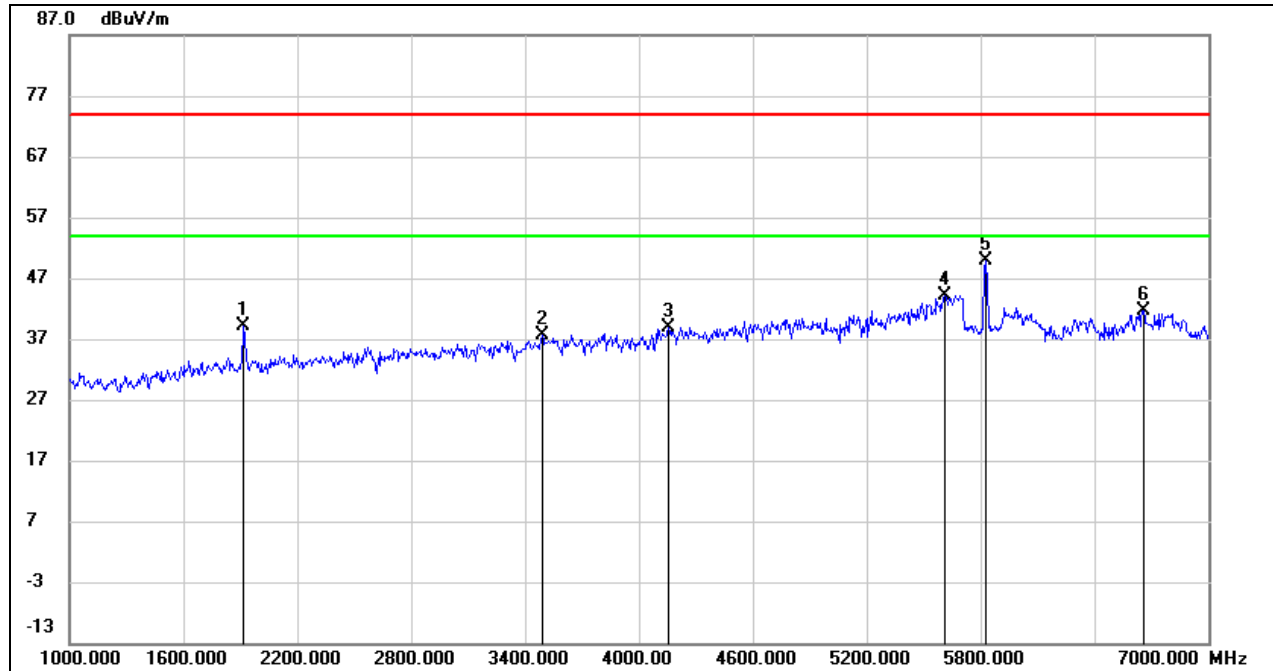
**HARMONICS AND SPURIOUS EMISSIONS (HIGH CHANNEL, HORIZONTAL)**

No.	Frequency (MHz)	Reading (dBuV)	Correct (dB/m)	Result (dBuV/m)	Limit (dBuV/m)	Margin (dB)	Remark
1	1918.000	49.15	-10.13	39.02	74.00	-34.98	peak
2	3490.000	42.36	-4.75	37.61	74.00	-36.39	peak
3	4156.000	41.01	-2.10	38.91	74.00	-35.09	peak
4	5614.000	41.74	2.46	44.20	74.00	-29.80	peak
5	5825.000	47.30	2.61	49.91	74.00	-24.09	peak
6	6658.000	36.10	5.51	41.61	74.00	-32.39	peak

- Note: 1. Measurement = Reading Level + Correct Factor.
 2. If Peak Result complies with AV limit, AV Result is deemed to comply with AV limit.
 3. Peak: Peak detector.
 4. AVG: $VBW=1/Ton$, where: Ton is the transmitting duration.
 5. For the transmitting duration, please refer to clause 7.1.
 6. Filter losses were only considered in the spurious frequency bands and the authorized band was not corrected for Band reject filter losses.
 7. Proper operation of the transmitter prior to adding the filter to the measurement chain.
 8. Since non-restricted band peak emissions are less than the average limit, they also comply with the $-27dBm/MHz$ ($68.2dBuV/m$) limit.

HARMONICS AND SPURIOUS EMISSIONS (HIGH CHANNEL, VERTICAL)

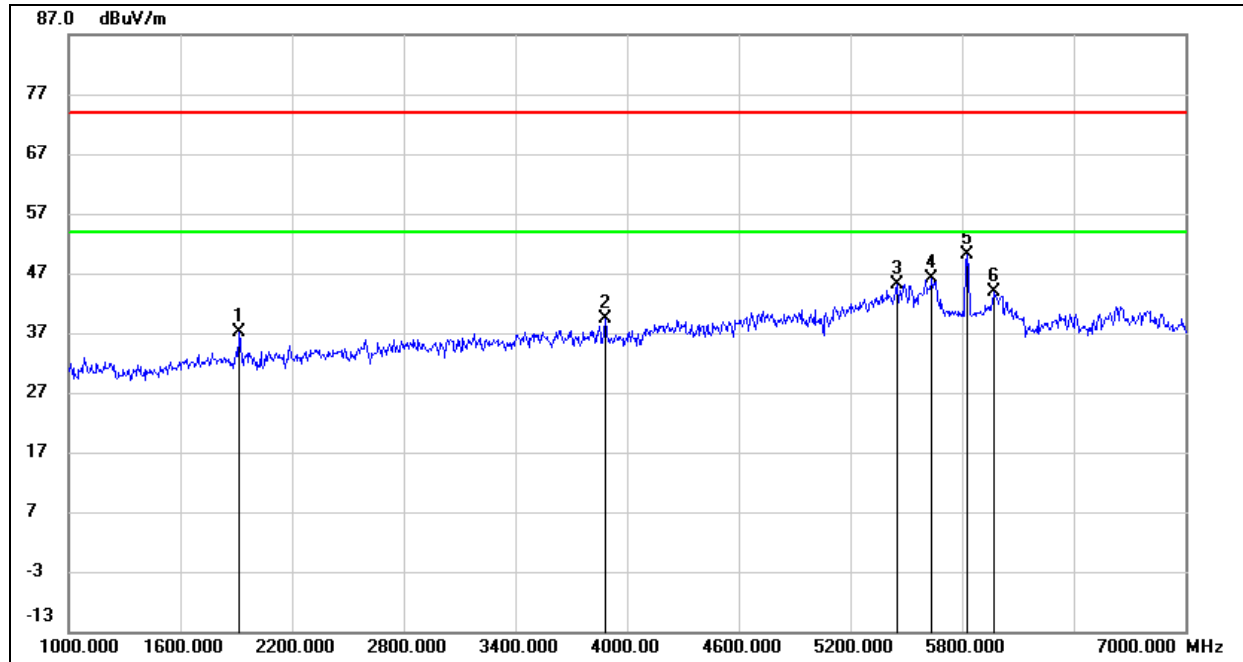

No.	Frequency (MHz)	Reading (dBuV)	Correct (dB/m)	Result (dBuV/m)	Limit (dBuV/m)	Margin (dB)	Remark
1	1918.000	47.14	-10.13	37.01	74.00	-36.99	peak
2	3886.000	42.82	-3.41	39.41	74.00	-34.59	peak
3	5452.000	43.20	2.02	45.22	74.00	-28.78	peak
4	5638.000	43.76	2.47	46.23	74.00	-27.77	peak
5	5825.000	47.62	2.61	50.23	74.00	-23.77	peak
6	5974.000	40.57	3.20	43.77	74.00	-30.23	peak

- Note:
1. Measurement = Reading Level + Correct Factor.
 2. If Peak Result complies with AV limit, AV Result is deemed to comply with AV limit.
 3. Peak: Peak detector.
 4. AVG: $VBW=1/T_{on}$, where: T_{on} is the transmitting duration.
 5. For the transmitting duration, please refer to clause 7.1.
 6. Filter losses were only considered in the spurious frequency bands and the authorized band was not corrected for Band reject filter losses.
 7. Proper operation of the transmitter prior to adding the filter to the measurement chain.
 8. Since non-restricted band peak emissions are less than the average limit, they also comply with the -27dBm/MHz (68.2dBuV/m) limit.

Note: All the modes and antennas had been tested, but only the worst data was recorded in the report.

8.3. SPURIOUS EMISSIONS (7 GHz ~ 18 GHz)

8.3.1. 802.11a SISO MODE

ANTENNA 1 TEST RESULTS (WORST CASE)

UNII-1 BAND

HARMONICS AND SPURIOUS EMISSIONS (LOW CHANNEL, HORIZONTAL)

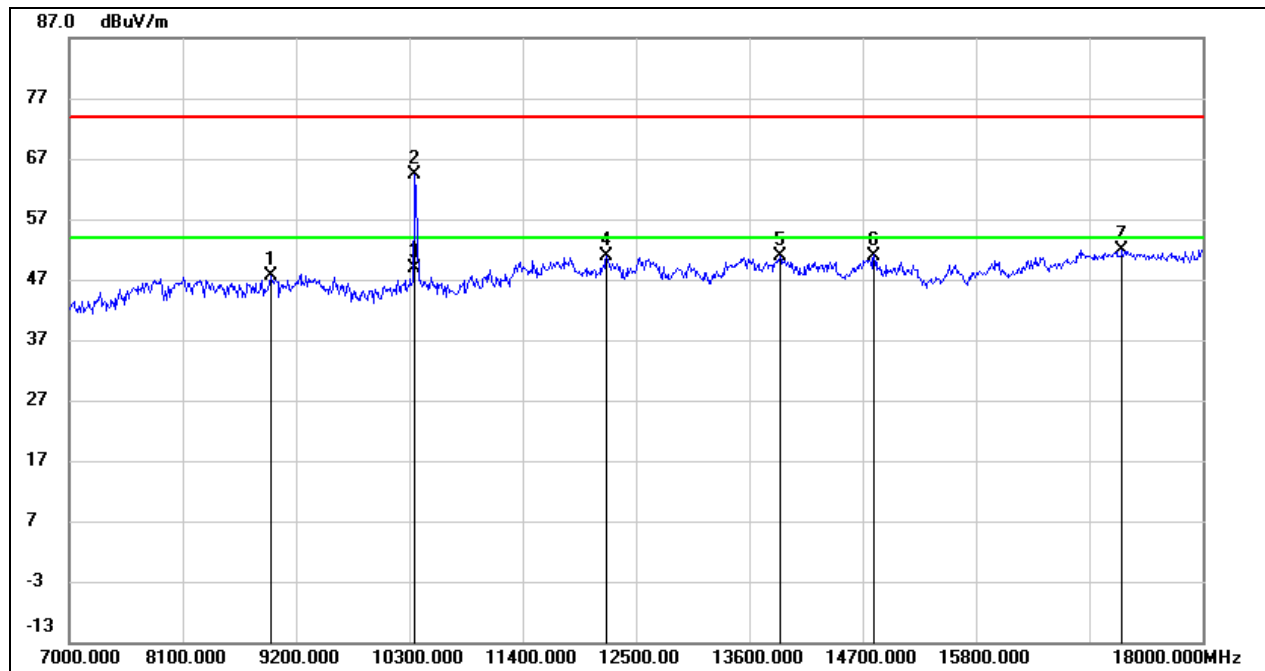

No.	Frequency (MHz)	Reading (dBuV)	Correct (dB/m)	Result (dBuV/m)	Limit (dBuV/m)	Margin (dB)	Remark
1	8958.000	37.12	10.48	47.60	74.00	-26.40	peak
2	10355.000	52.44	12.04	64.48	68.20	-3.72	peak
3	10355.000	36.72	12.04	48.76	/	/	AVG
4	12214.000	34.84	15.97	50.81	74.00	-23.19	peak
5	13897.000	33.40	17.52	50.92	74.00	-23.08	peak
6	14810.000	33.03	17.97	51.00	74.00	-23.00	peak
7	17219.000	29.81	22.11	51.92	74.00	-22.08	peak

Note: 1. Measurement = Reading Level + Correct Factor.

2. If Peak Result complies with AV limit, AV Result is deemed to comply with AV limit.

3. Peak: Peak detector.

4. AVG: $VBW=1/Ton$, where: Ton is the transmitting duration.

5. For the transmitting duration, please refer to clause 7.1.

6. Filter losses were only considered in the spurious frequency bands and the authorized band was not corrected for High Pass Filter losses.

7. Proper operation of the transmitter prior to adding the filter to the measurement chain.

8. Since non-restricted band peak emissions are less than the average limit, they also comply with the -27dBm/MHz (68.2dBuV/m) limit.

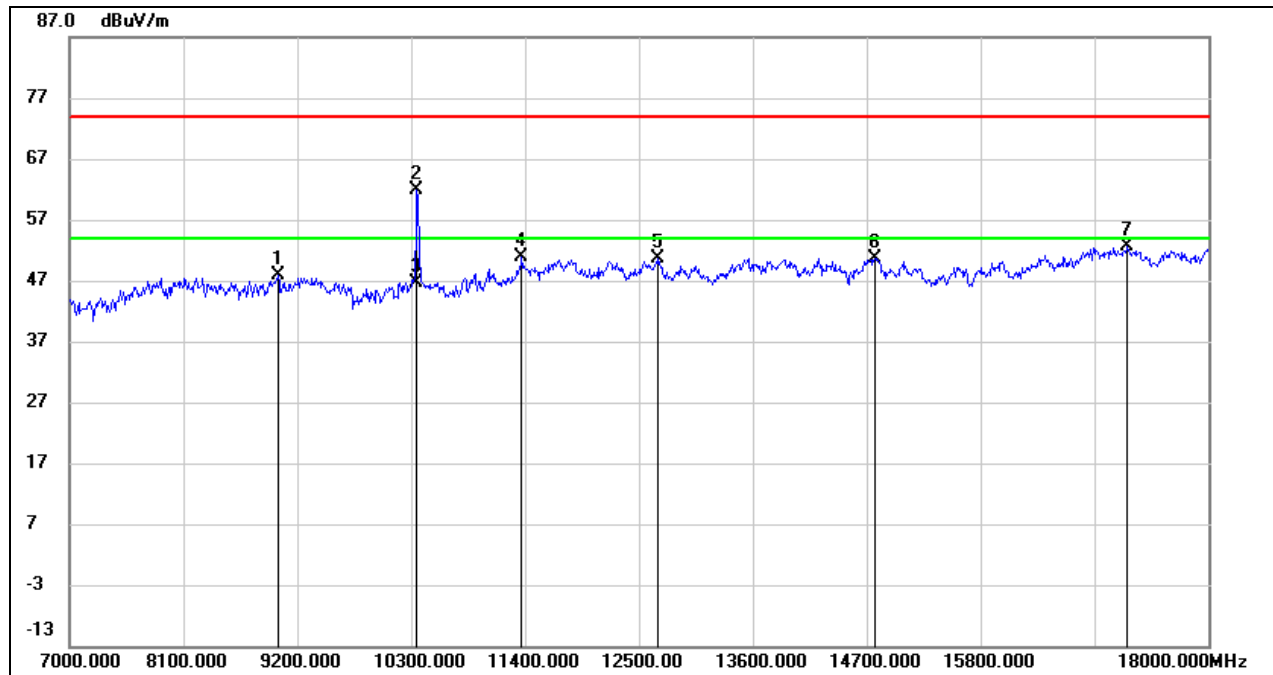
**HARMONICS AND SPURIOUS EMISSIONS (LOW CHANNEL, VERTICAL)**

No.	Frequency (MHz)	Reading (dBuV)	Correct (dB/m)	Result (dBuV/m)	Limit (dBuV/m)	Margin (dB)	Remark
1	9013.000	36.79	11.12	47.91	74.00	-26.09	peak
2	10355.000	49.94	12.04	61.98	68.20	-6.22	peak
3	10355.000	34.52	12.04	46.56	/	/	AVG
4	11367.000	36.48	14.45	50.93	74.00	-23.07	peak
5	12676.000	35.02	15.66	50.68	74.00	-23.32	peak
6	14777.000	32.76	17.96	50.72	74.00	-23.28	peak
7	17219.000	30.48	22.11	52.59	74.00	-21.41	peak

- Note: 1. Measurement = Reading Level + Correct Factor.
 2. If Peak Result complies with AV limit, AV Result is deemed to comply with AV limit.
 3. Peak: Peak detector.
 4. AVG: $VBW=1/Ton$, where: Ton is the transmitting duration.
 5. For the transmitting duration, please refer to clause 7.1.
 6. Filter losses were only considered in the spurious frequency bands and the authorized band was not corrected for High Pass Filter losses.
 7. Proper operation of the transmitter prior to adding the filter to the measurement chain.
 8. Since non-restricted band peak emissions are less than the average limit, they also comply with the $-27dBm/MHz$ ($68.2dBuV/m$) limit.

HARMONICS AND SPURIOUS EMISSIONS (MID CHANNEL, HORIZONTAL)

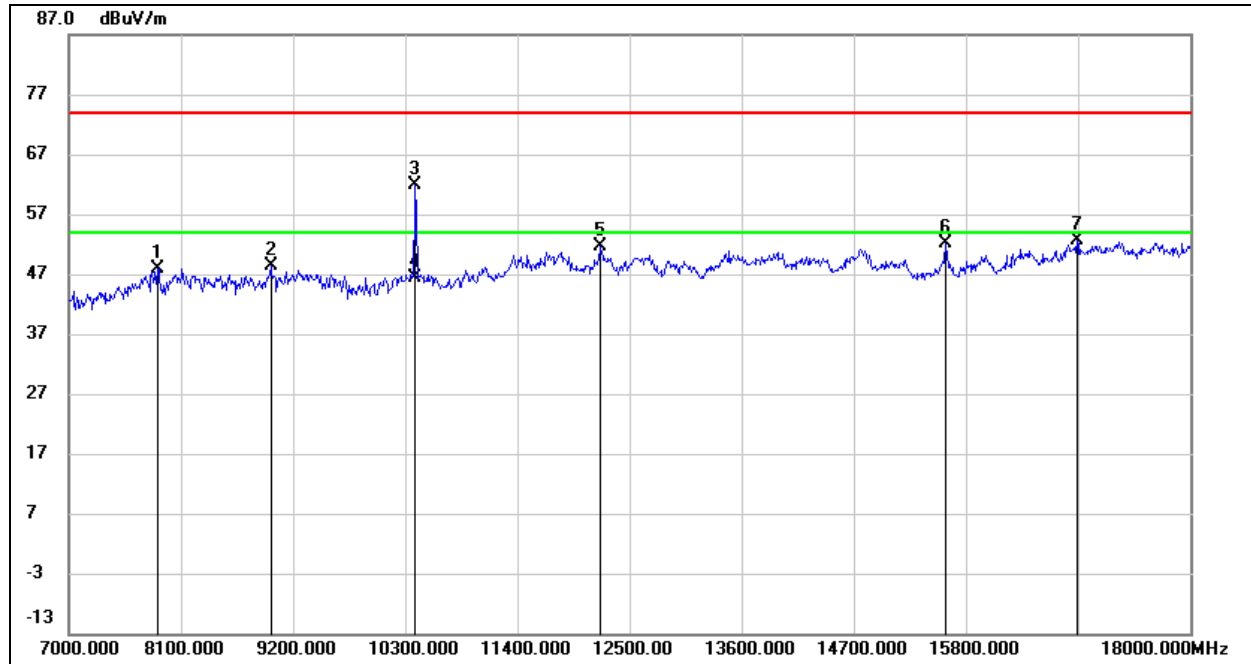

No.	Frequency (MHz)	Reading (dBuV)	Correct (dB/m)	Result (dBuV/m)	Limit (dBuV/m)	Margin (dB)	Remark
1	7869.000	38.93	9.02	47.95	74.00	-26.05	peak
2	8980.000	37.48	10.89	48.37	74.00	-25.63	peak
3	10399.000	49.55	12.23	61.78	68.20	-6.42	peak
4	10399.000	34.10	12.23	46.33	/	/	AVG
5	12214.000	35.56	15.97	51.53	74.00	-22.47	peak
6	15602.000	34.47	17.70	52.17	74.00	-21.83	peak
7	16889.000	31.04	21.47	52.51	74.00	-21.49	peak

- Note:
1. Measurement = Reading Level + Correct Factor.
 2. If Peak Result complies with AV limit, AV Result is deemed to comply with AV limit.
 3. Peak: Peak detector.
 4. AVG: $VBW=1/Ton$, where: Ton is the transmitting duration.
 5. For the transmitting duration, please refer to clause 7.1.
 6. Filter losses were only considered in the spurious frequency bands and the authorized band was not corrected for High Pass Filter losses.
 7. Proper operation of the transmitter prior to adding the filter to the measurement chain.
 8. Since non-restricted band peak emissions are less than the average limit, they also comply with the -27dBm/MHz (68.2dBuV/m) limit.

HARMONICS AND SPURIOUS EMISSIONS (MID CHANNEL, VERTICAL)

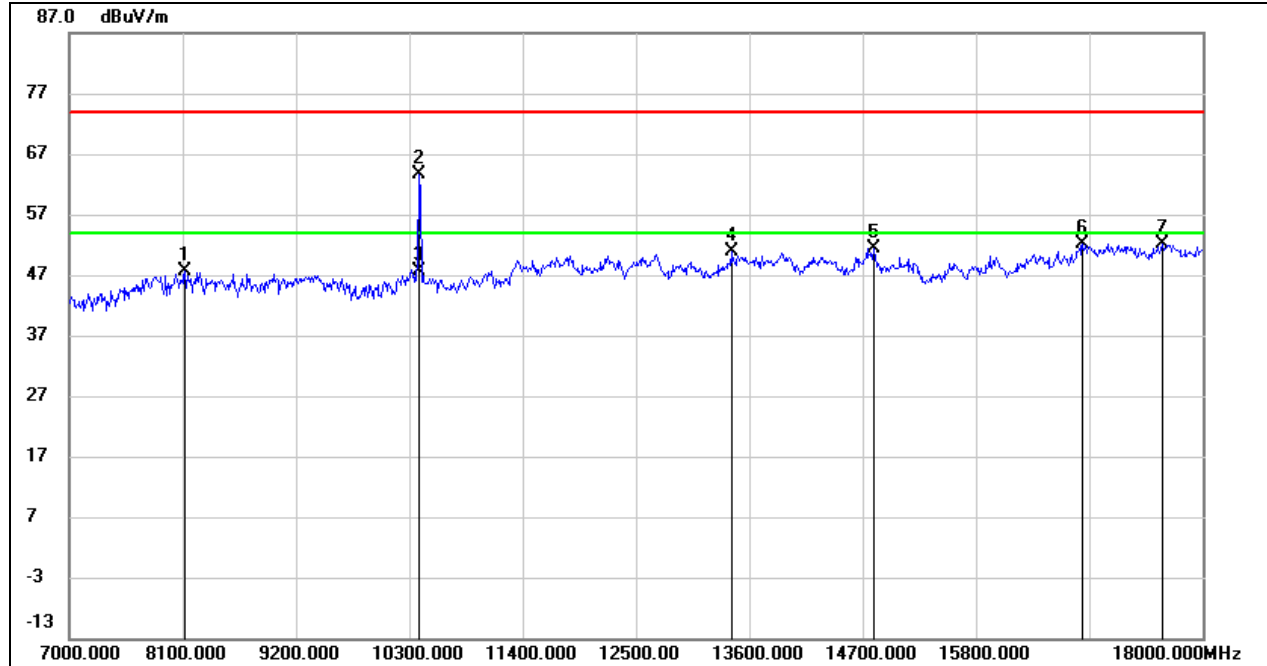

No.	Frequency (MHz)	Reading (dBuV)	Correct (dB/m)	Result (dBuV/m)	Limit (dBuV/m)	Margin (dB)	Remark
1	8122.000	37.43	10.10	47.53	74.00	-26.47	peak
2	10399.000	51.35	12.23	63.58	68.20	-4.62	peak
3	10399.000	35.35	12.23	47.58	/	/	AVG
4	13424.000	33.84	17.07	50.91	74.00	-23.09	peak
5	14810.000	33.47	17.97	51.44	74.00	-22.56	peak
6	16834.000	31.08	21.00	52.08	74.00	-21.92	peak
7	17604.000	29.41	22.76	52.17	74.00	-21.83	peak

Note: 1. Measurement = Reading Level + Correct Factor.

2. If Peak Result complies with AV limit, AV Result is deemed to comply with AV limit.

3. Peak: Peak detector.

4. AVG: $VBW=1/Ton$, where: Ton is the transmitting duration.

5. For the transmitting duration, please refer to clause 7.1.

6. Filter losses were only considered in the spurious frequency bands and the authorized band was not corrected for High Pass Filter losses.

7. Proper operation of the transmitter prior to adding the filter to the measurement chain.

8. Since non-restricted band peak emissions are less than the average limit, they also comply with the -27dBm/MHz (68.2dBuV/m) limit.

HARMONICS AND SPURIOUS EMISSIONS (HIGH CHANNEL, HORIZONTAL)

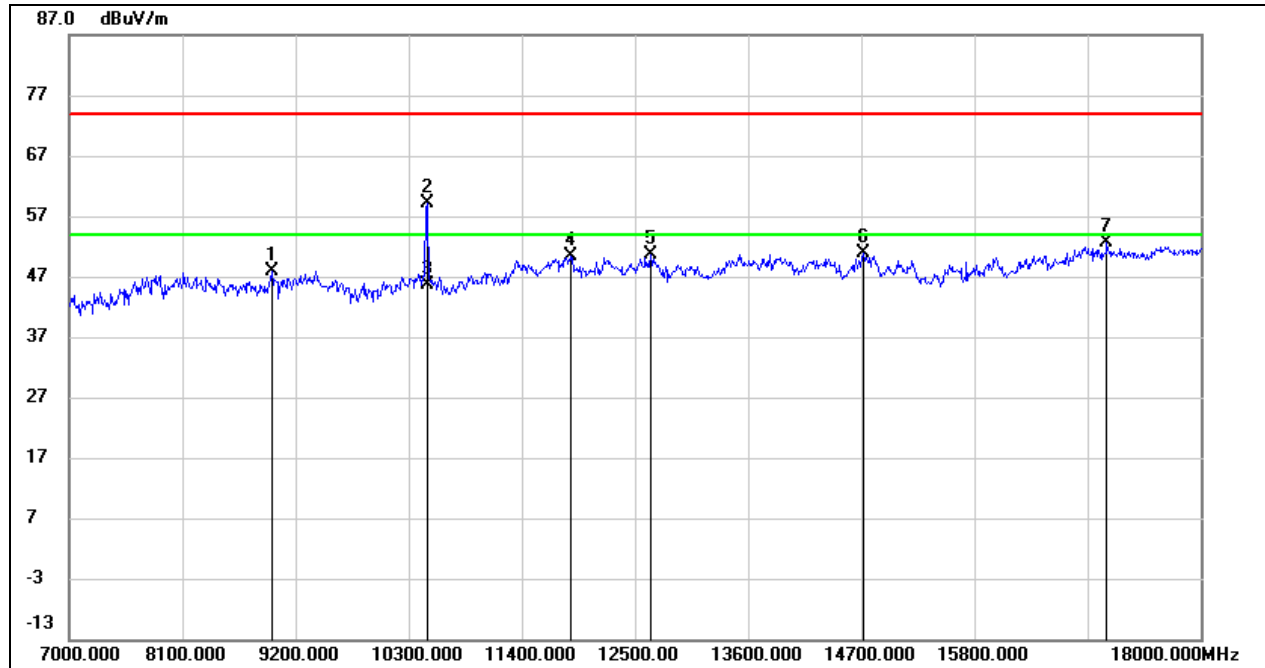

No.	Frequency (MHz)	Reading (dBuV)	Correct (dB/m)	Result (dBuV/m)	Limit (dBuV/m)	Margin (dB)	Remark
1	8969.000	37.25	10.69	47.94	74.00	-26.06	peak
2	10476.000	46.89	12.33	59.22	68.20	-8.98	peak
3	10476.000	33.19	12.33	45.52	/	/	AVG
4	11873.000	34.91	15.44	50.35	74.00	-23.65	peak
5	12654.000	34.95	15.69	50.64	74.00	-23.36	peak
6	14722.000	33.00	17.77	50.77	74.00	-23.23	peak
7	17087.000	30.85	21.81	52.66	74.00	-21.34	peak

Note: 1. Measurement = Reading Level + Correct Factor.

2. If Peak Result complies with AV limit, AV Result is deemed to comply with AV limit.

3. Peak: Peak detector.

4. AVG: $VBW=1/Ton$, where: Ton is the transmitting duration.

5. For the transmitting duration, please refer to clause 7.1.

6. Filter losses were only considered in the spurious frequency bands and the authorized band was not corrected for High Pass Filter losses.

7. Proper operation of the transmitter prior to adding the filter to the measurement chain.

8. Since non-restricted band peak emissions are less than the average limit, they also comply with the -27dBm/MHz (68.2dBuV/m) limit.

HARMONICS AND SPURIOUS EMISSIONS (HIGH CHANNEL, VERTICAL)

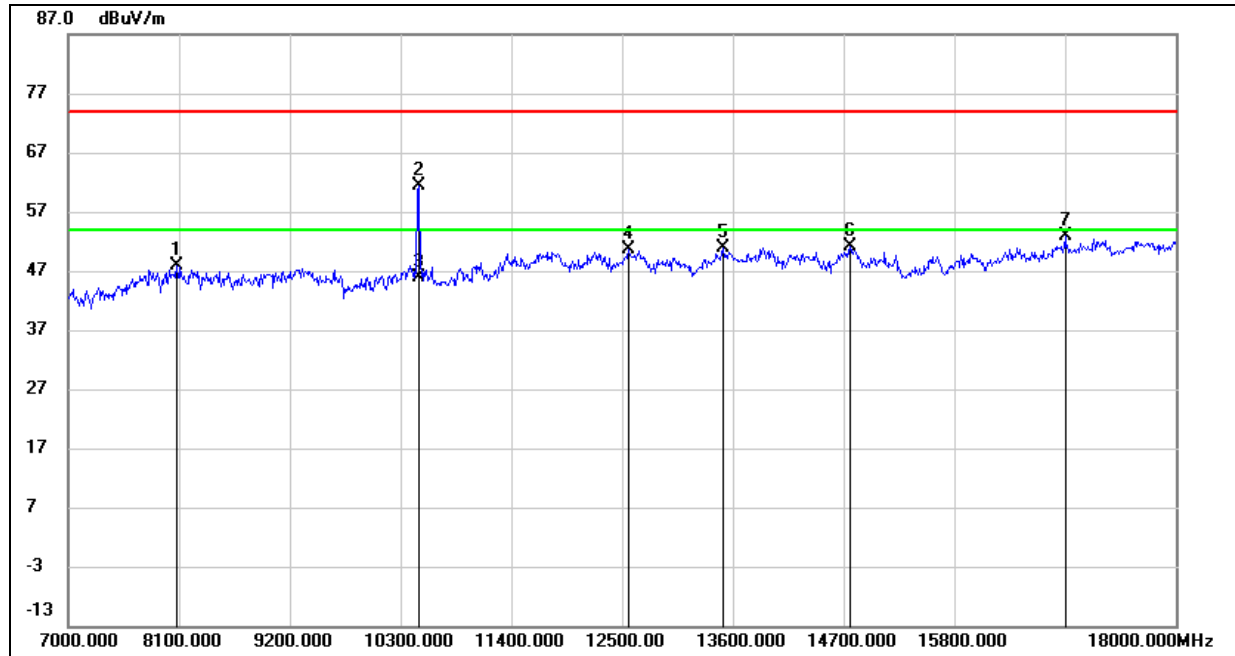

No.	Frequency (MHz)	Reading (dBuV)	Correct (dB/m)	Result (dBuV/m)	Limit (dBuV/m)	Margin (dB)	Remark
1	8078.000	38.05	9.83	47.88	74.00	-26.12	peak
2	10476.000	49.06	12.33	61.39	68.20	-6.81	peak
3	10476.000	33.53	12.33	45.86	/	/	AVG
4	12566.000	34.92	15.74	50.66	74.00	-23.34	peak
5	13501.000	33.68	17.22	50.90	74.00	-23.10	peak
6	14766.000	33.26	17.92	51.18	74.00	-22.82	peak
7	16900.000	31.22	21.57	52.79	74.00	-21.21	peak

Note: 1. Measurement = Reading Level + Correct Factor.

2. If Peak Result complies with AV limit, AV Result is deemed to comply with AV limit.

3. Peak: Peak detector.

4. AVG: $VBW=1/T_{on}$, where: T_{on} is the transmitting duration.

5. For the transmitting duration, please refer to clause 7.1.

6. Filter losses were only considered in the spurious frequency bands and the authorized band was not corrected for High Pass Filter losses.

7. Proper operation of the transmitter prior to adding the filter to the measurement chain.

8. Since non-restricted band peak emissions are less than the average limit, they also comply with the -27dBm/MHz (68.2dBuV/m) limit.

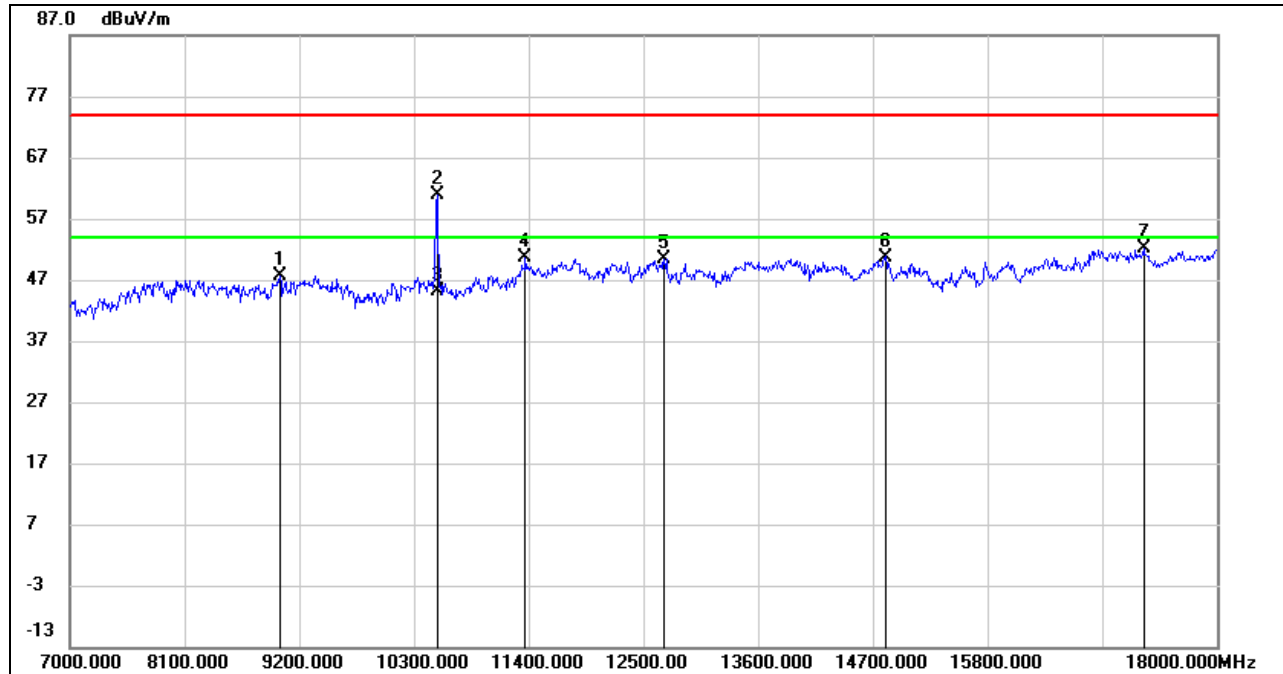
**UNII-2A BAND****HARMONICS AND SPURIOUS EMISSIONS (LOW CHANNEL, HORIZONTAL)**

No.	Frequency (MHz)	Reading (dBuV)	Correct (dB/m)	Result (dBuV/m)	Limit (dBuV/m)	Margin (dB)	Remark
1	9013.000	36.59	11.12	47.71	74.00	-26.29	peak
2	10520.000	48.51	12.43	60.94	68.20	-7.26	peak
3	10520.000	32.82	12.43	45.25	/	/	AVG
4	11367.000	36.23	14.45	50.68	74.00	-23.32	peak
5	12698.000	34.85	15.62	50.47	74.00	-23.53	peak
6	14821.000	32.85	17.90	50.75	74.00	-23.25	peak
7	17296.000	29.50	22.59	52.09	74.00	-21.91	peak

Note: 1. Measurement = Reading Level + Correct Factor.

2. If Peak Result complies with AV limit, AV Result is deemed to comply with AV limit.

3. Peak: Peak detector.

4. AVG: $VBW=1/Ton$, where: Ton is the transmitting duration.

5. For the transmitting duration, please refer to clause 7.1.

6. Filter losses were only considered in the spurious frequency bands and the authorized band was not corrected for High Pass Filter losses.

7. Proper operation of the transmitter prior to adding the filter to the measurement chain.

8. Since non-restricted band peak emissions are less than the average limit, they also comply with the -27dBm/MHz (68.2dBuV/m) limit.

HARMONICS AND SPURIOUS EMISSIONS (LOW CHANNEL, VERTICAL)

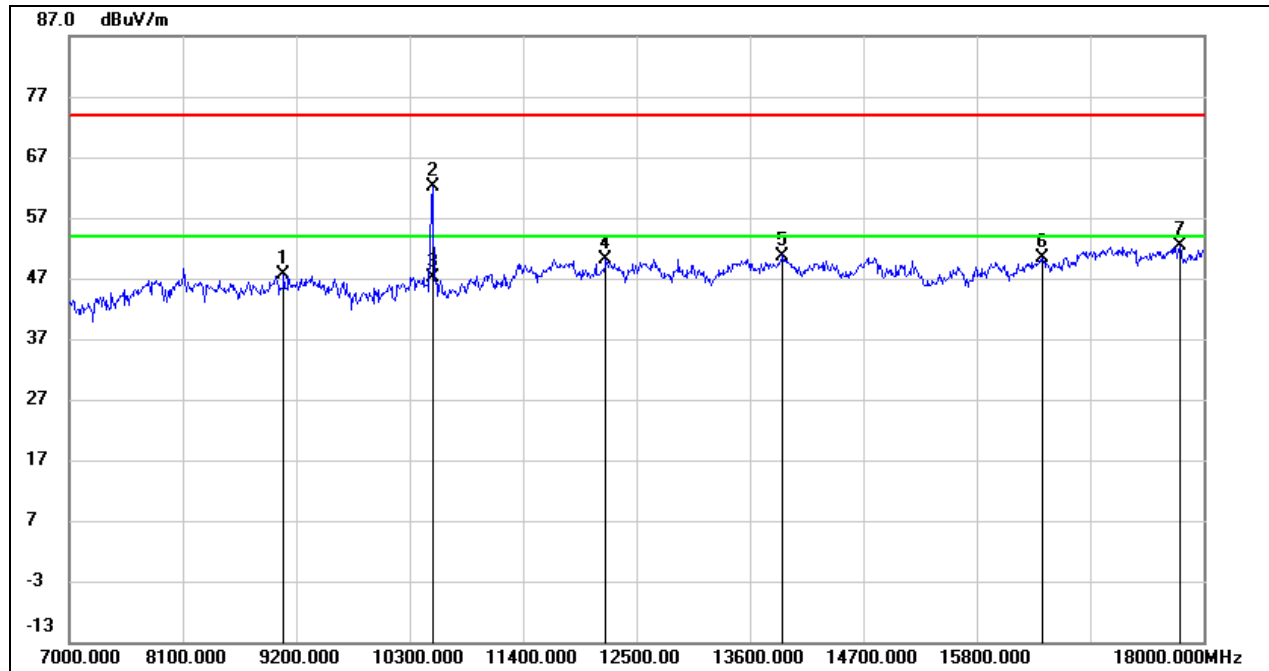

No.	Frequency (MHz)	Reading (dBuV)	Correct (dB/m)	Result (dBuV/m)	Limit (dBuV/m)	Margin (dB)	Remark
1	9079.000	37.16	10.38	47.54	74.00	-26.46	peak
2	10520.000	49.79	12.43	62.22	68.20	-5.98	peak
3	10520.000	34.78	12.43	47.21	/	/	AVG
4	12203.000	34.29	15.95	50.24	74.00	-23.76	peak
5	13919.000	33.20	17.55	50.75	74.00	-23.25	peak
6	16438.000	30.79	19.68	50.47	74.00	-23.53	peak
7	17769.000	28.56	23.87	52.43	74.00	-21.57	peak

- Note:
1. Measurement = Reading Level + Correct Factor.
 2. If Peak Result complies with AV limit, AV Result is deemed to comply with AV limit.
 3. Peak: Peak detector.
 4. AVG: $VBW=1/Ton$, where: Ton is the transmitting duration.
 5. For the transmitting duration, please refer to clause 7.1.
 6. Filter losses were only considered in the spurious frequency bands and the authorized band was not corrected for High Pass Filter losses.
 7. Proper operation of the transmitter prior to adding the filter to the measurement chain.
 8. Since non-restricted band peak emissions are less than the average limit, they also comply with the -27dBm/MHz (68.2dBuV/m) limit.

HARMONICS AND SPURIOUS EMISSIONS (MID CHANNEL, HORIZONTAL)

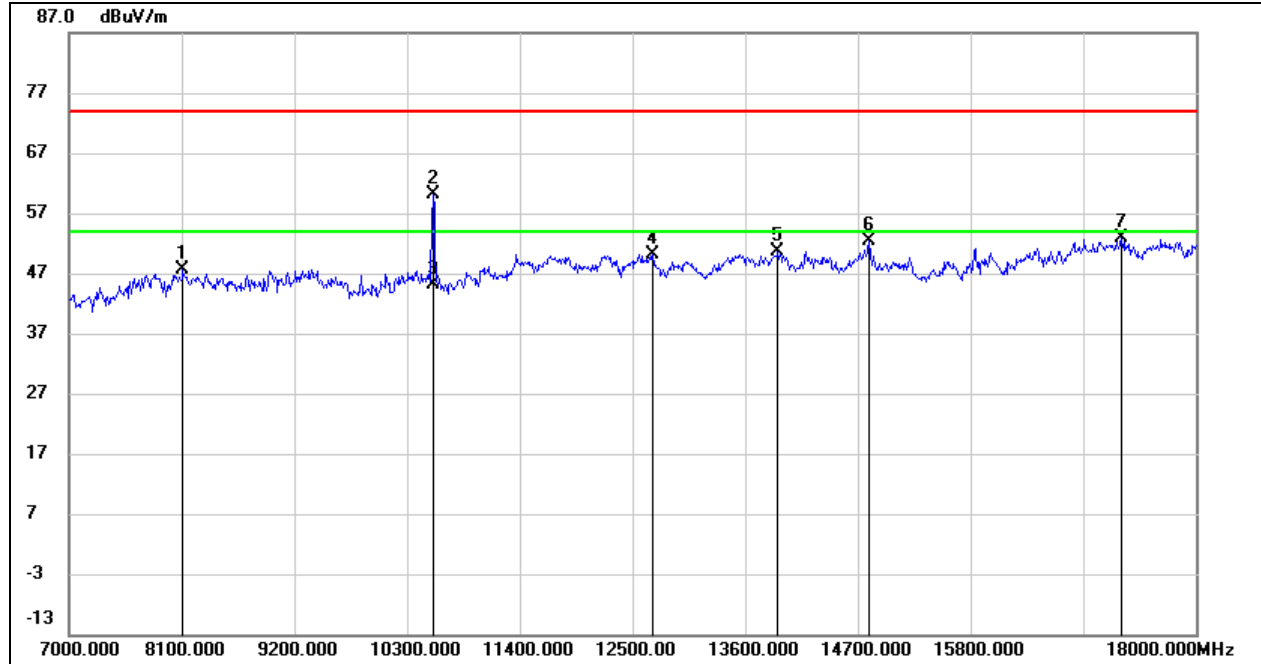

No.	Frequency (MHz)	Reading (dBuV)	Correct (dB/m)	Result (dBuV/m)	Limit (dBuV/m)	Margin (dB)	Remark
1	8111.000	37.52	10.14	47.66	74.00	-26.34	peak
2	10553.000	47.62	12.53	60.15	68.20	-8.05	peak
3	10553.000	32.49	12.53	45.02	/	/	AVG
4	12698.000	34.56	15.62	50.18	74.00	-23.82	peak
5	13919.000	33.03	17.55	50.58	74.00	-23.42	peak
6	14810.000	34.30	17.97	52.27	74.00	-21.73	peak
7	17274.000	30.36	22.45	52.81	74.00	-21.19	peak

Note: 1. Measurement = Reading Level + Correct Factor.

2. If Peak Result complies with AV limit, AV Result is deemed to comply with AV limit.

3. Peak: Peak detector.

4. AVG: $VBW=1/Ton$, where: Ton is the transmitting duration.

5. For the transmitting duration, please refer to clause 7.1.

6. Filter losses were only considered in the spurious frequency bands and the authorized band was not corrected for High Pass Filter losses.

7. Proper operation of the transmitter prior to adding the filter to the measurement chain.

8. Since non-restricted band peak emissions are less than the average limit, they also comply with the -27dBm/MHz (68.2dBuV/m) limit.

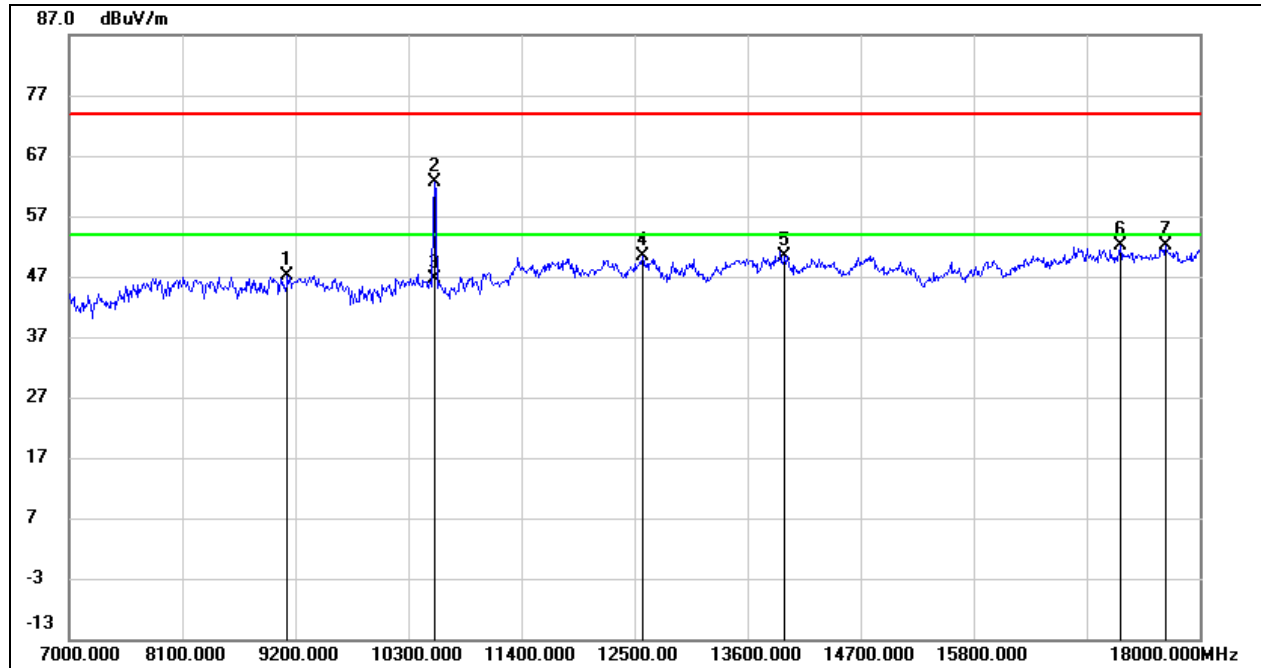
**HARMONICS AND SPURIOUS EMISSIONS (MID CHANNEL, VERTICAL)**

No.	Frequency (MHz)	Reading (dBuV)	Correct (dB/m)	Result (dBuV/m)	Limit (dBuV/m)	Margin (dB)	Remark
1	9123.000	37.06	10.09	47.15	74.00	-26.85	peak
2	10553.000	50.07	12.53	62.6	68.20	-5.60	peak
3	10553.000	34.10	12.53	46.63	/	/	AVG
4	12577.000	34.69	15.75	50.44	74.00	-23.56	peak
5	13963.000	32.83	17.61	50.44	74.00	-23.56	peak
6	17230.000	29.98	22.17	52.15	74.00	-21.85	peak
7	17670.000	28.95	23.24	52.19	74.00	-21.81	peak

Note: 1. Measurement = Reading Level + Correct Factor.

2. If Peak Result complies with AV limit, AV Result is deemed to comply with AV limit.

3. Peak: Peak detector.

4. AVG: $VBW=1/Ton$, where: Ton is the transmitting duration.

5. For the transmitting duration, please refer to clause 7.1.

6. Filter losses were only considered in the spurious frequency bands and the authorized band was not corrected for High Pass Filter losses.

7. Proper operation of the transmitter prior to adding the filter to the measurement chain.

8. Since non-restricted band peak emissions are less than the average limit, they also comply with the -27dBm/MHz (68.2dBuV/m) limit.

HARMONICS AND SPURIOUS EMISSIONS (HIGH CHANNEL, HORIZONTAL)

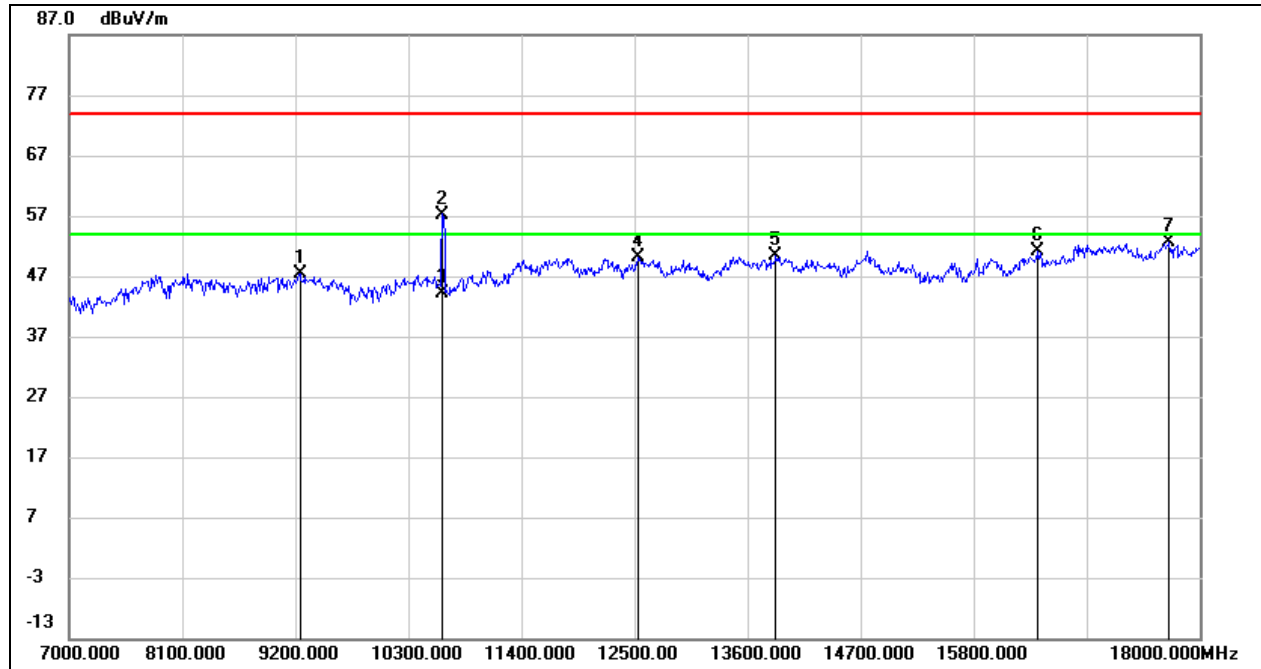

No.	Frequency (MHz)	Reading (dBuV)	Correct (dB/m)	Result (dBuV/m)	Limit (dBuV/m)	Margin (dB)	Remark
1	9244.000	37.33	10.12	47.45	74.00	-26.55	peak
2	10630.000	44.50	12.75	57.25	74.00	-16.75	peak
3	10630.000	31.45	12.75	44.20	54.00	-9.80	AVG
4	12533.000	34.38	15.71	50.09	74.00	-23.91	peak
5	13875.000	32.71	17.55	50.26	74.00	-23.74	peak
6	16416.000	31.42	19.68	51.10	74.00	-22.90	peak
7	17703.000	29.11	23.49	52.60	74.00	-21.40	peak

- Note: 1. Measurement = Reading Level + Correct Factor.
 2. If Peak Result complies with AV limit, AV Result is deemed to comply with AV limit.
 3. Peak: Peak detector.
 4. AVG: $VBW=1/Ton$, where: Ton is the transmitting duration.
 5. For the transmitting duration, please refer to clause 7.1.
 6. Filter losses were only considered in the spurious frequency bands and the authorized band was not corrected for High Pass Filter losses.
 7. Proper operation of the transmitter prior to adding the filter to the measurement chain.
 8. Since non-restricted band peak emissions are less than the average limit, they also comply with the -27dBm/MHz (68.2dBuV/m) limit.

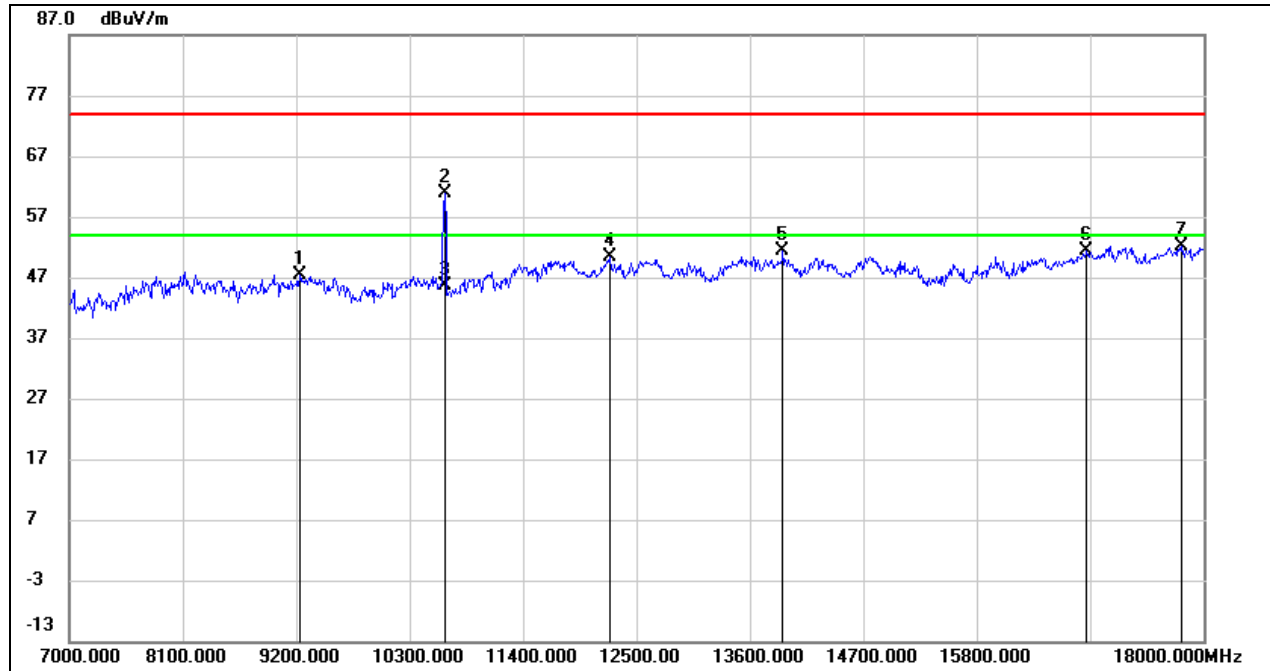
**HARMONICS AND SPURIOUS EMISSIONS (HIGH CHANNEL, VERTICAL)**

No.	Frequency (MHz)	Reading (dBuV)	Correct (dB/m)	Result (dBuV/m)	Limit (dBuV/m)	Margin (dB)	Remark
1	9233.000	37.40	10.08	47.48	74.00	-26.52	peak
2	10641.000	48.16	12.77	60.93	74.00	-13.07	peak
3	10641.000	32.74	12.77	45.51	54.00	-8.49	AVG
4	12247.000	34.40	16.02	50.42	74.00	-23.58	peak
5	13919.000	33.95	17.55	51.50	74.00	-22.50	peak
6	16867.000	30.13	21.29	51.42	74.00	-22.58	peak
7	17780.000	28.23	23.94	52.17	74.00	-21.83	peak

Note: 1. Measurement = Reading Level + Correct Factor.

2. If Peak Result complies with AV limit, AV Result is deemed to comply with AV limit.

3. Peak: Peak detector.

4. AVG: $VBW=1/Ton$, where: Ton is the transmitting duration.

5. For the transmitting duration, please refer to clause 7.1.

6. Filter losses were only considered in the spurious frequency bands and the authorized band was not corrected for High Pass Filter losses.

7. Proper operation of the transmitter prior to adding the filter to the measurement chain.

8. Since non-restricted band peak emissions are less than the average limit, they also comply with the $-27dBm/MHz$ ($68.2dBuV/m$) limit.

UNII-2C BAND

HARMONICS AND SPURIOUS EMISSIONS (LOW CHANNEL, HORIZONTAL)

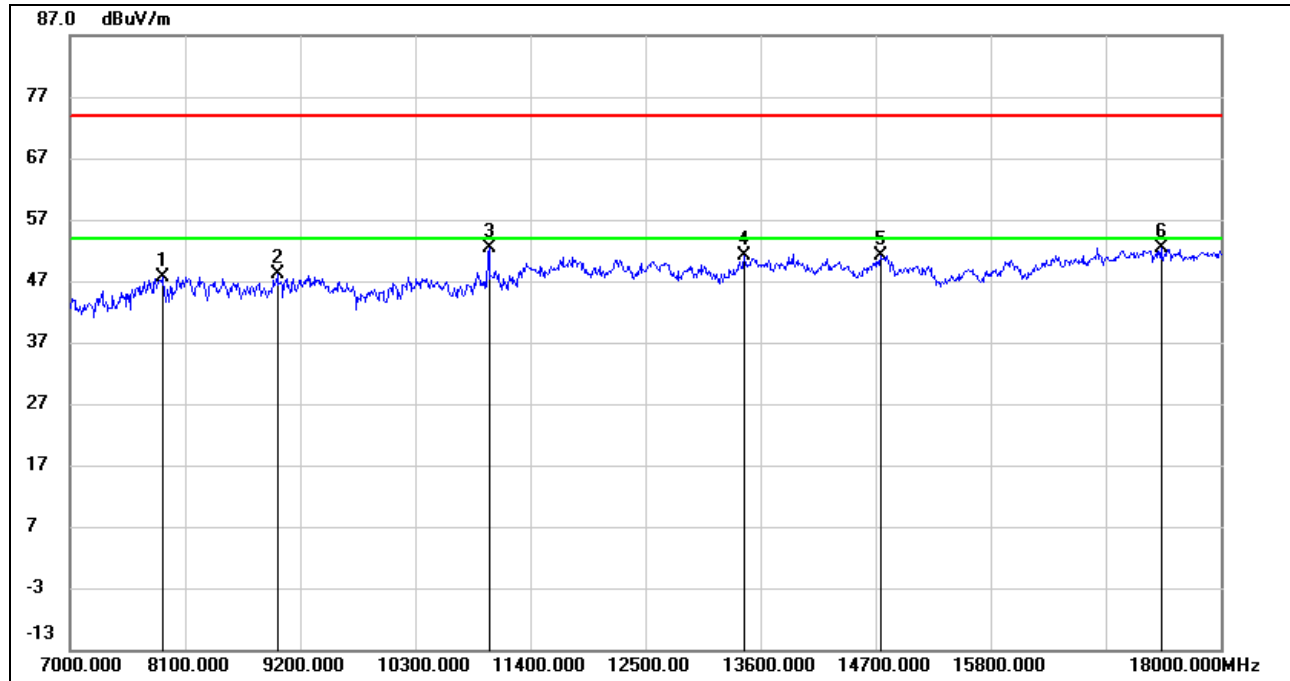

No.	Frequency (MHz)	Reading (dBuV)	Correct (dB/m)	Result (dBuV/m)	Limit (dBuV/m)	Margin (dB)	Remark
1	7880.000	38.72	8.95	47.67	74.00	-26.33	peak
2	8980.000	37.21	10.89	48.10	74.00	-25.90	peak
3	11004.000	39.10	13.32	52.42	74.00	-21.58	peak
4	13446.000	34.06	17.12	51.18	74.00	-22.82	peak
5	14744.000	33.36	17.84	51.20	74.00	-22.80	peak
6	17428.000	30.52	21.92	52.44	74.00	-21.56	peak

- Note:
1. Measurement = Reading Level + Correct Factor.
 2. If Peak Result complies with AV limit, AV Result is deemed to comply with AV limit.
 3. Peak: Peak detector.
 4. AVG: $VBW=1/Ton$, where: Ton is the transmitting duration.
 5. For the transmitting duration, please refer to clause 7.1.
 6. Filter losses were only considered in the spurious frequency bands and the authorized band was not corrected for High Pass Filter losses.
 7. Proper operation of the transmitter prior to adding the filter to the measurement chain.
 8. Since non-restricted band peak emissions are less than the average limit, they also comply with the -27dBm/MHz (68.2dBuV/m) limit.

HARMONICS AND SPURIOUS EMISSIONS (LOW CHANNEL, VERTICAL)

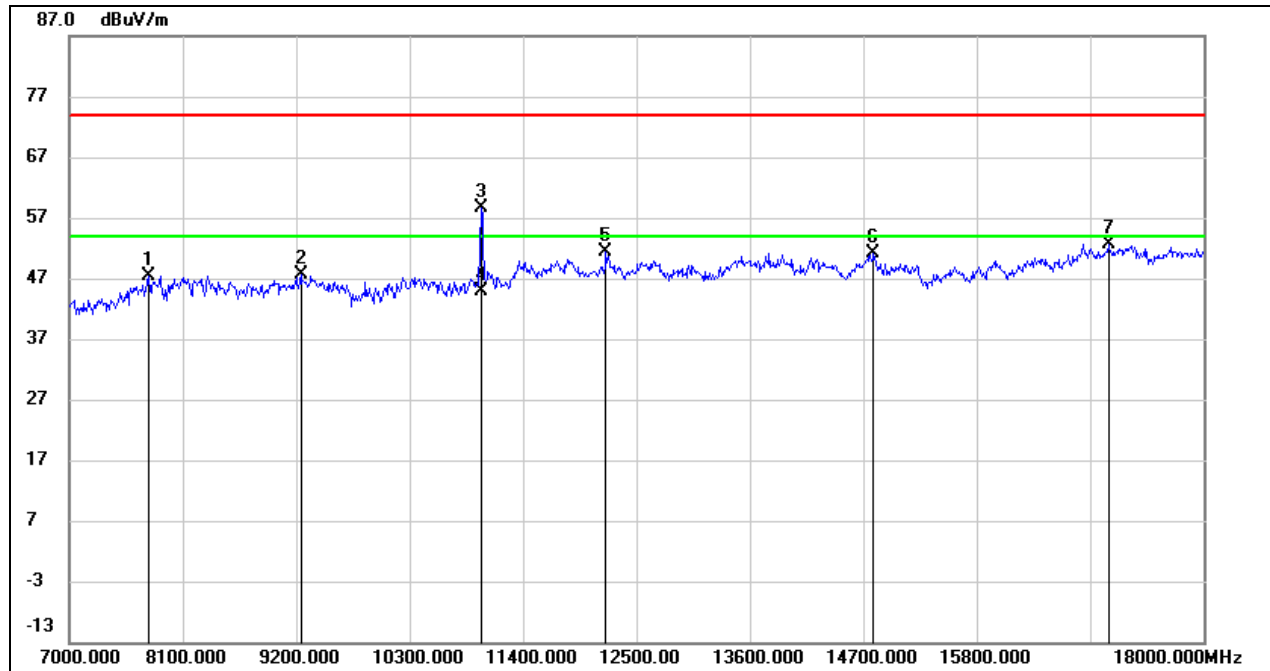

No.	Frequency (MHz)	Reading (dBuV)	Correct (dB/m)	Result (dBuV/m)	Limit (dBuV/m)	Margin (dB)	Remark
1	7770.000	38.41	9.09	47.50	74.00	-26.50	peak
2	9244.000	37.45	10.12	47.57	74.00	-26.43	peak
3	10993.000	45.23	13.31	58.54	74.00	-15.46	peak
4	10993.000	31.56	13.31	44.87	54.00	-9.13	AVG
5	12203.000	35.33	15.95	51.28	74.00	-22.72	peak
6	14799.000	33.08	18.04	51.12	74.00	-22.88	peak
7	17076.000	30.99	21.74	52.73	74.00	-21.27	peak

Note: 1. Measurement = Reading Level + Correct Factor.

2. If Peak Result complies with AV limit, AV Result is deemed to comply with AV limit.

3. Peak: Peak detector.

4. AVG: $VBW=1/T_{on}$, where: T_{on} is the transmitting duration.

5. For the transmitting duration, please refer to clause 7.1.

6. Filter losses were only considered in the spurious frequency bands and the authorized band was not corrected for High Pass Filter losses.

7. Proper operation of the transmitter prior to adding the filter to the measurement chain.

8. Since non-restricted band peak emissions are less than the average limit, they also comply with the -27dBm/MHz (68.2dBuV/m) limit.

HARMONICS AND SPURIOUS EMISSIONS (MID CHANNEL, HORIZONTAL)

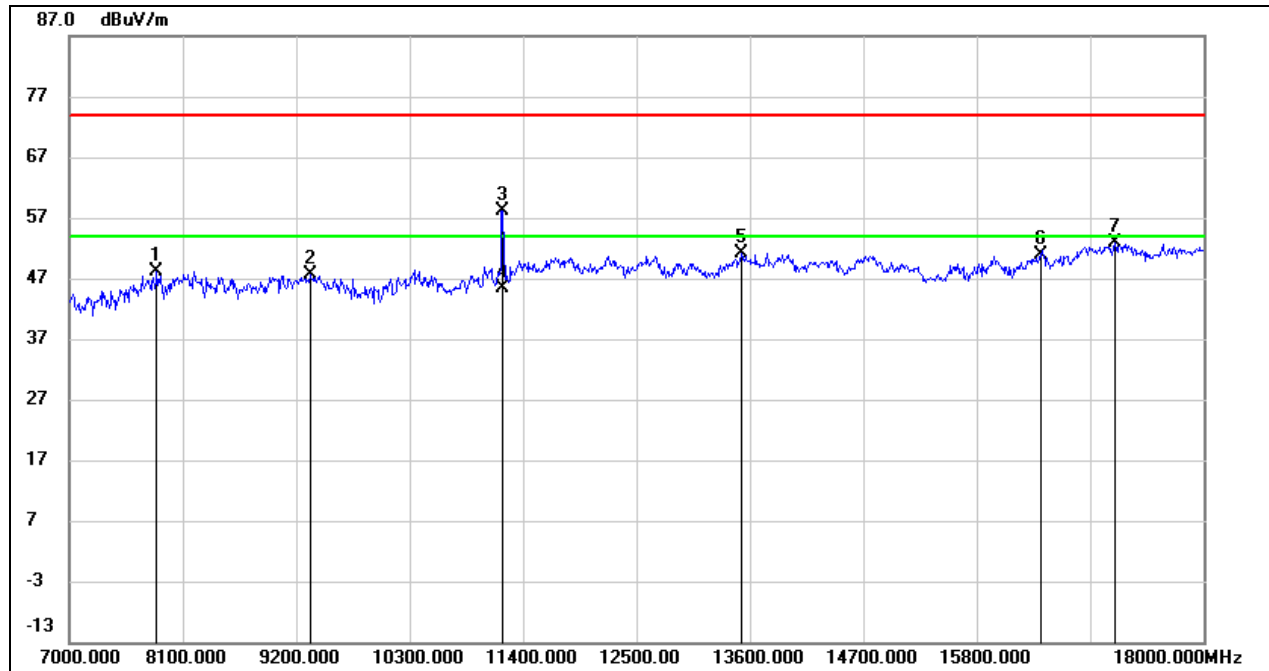

No.	Frequency (MHz)	Reading (dBuV)	Correct (dB/m)	Result (dBuV/m)	Limit (dBuV/m)	Margin (dB)	Remark
1	7847.000	38.91	9.12	48.03	74.00	-25.97	peak
2	9332.000	37.11	10.59	47.70	74.00	-26.30	peak
3	11202.000	44.45	13.79	58.24	74.00	-15.76	peak
4	11202.000	31.54	13.79	45.33	54.00	-8.67	AVG
5	13523.000	33.97	17.19	51.16	74.00	-22.84	peak
6	16416.000	31.22	19.68	50.90	74.00	-23.10	peak
7	17142.000	30.84	21.93	52.77	74.00	-21.23	peak

Note: 1. Measurement = Reading Level + Correct Factor.

2. If Peak Result complies with AV limit, AV Result is deemed to comply with AV limit.

3. Peak: Peak detector.

4. AVG: $VBW=1/T_{on}$, where: T_{on} is the transmitting duration.

5. For the transmitting duration, please refer to clause 7.1.

6. Filter losses were only considered in the spurious frequency bands and the authorized band was not corrected for High Pass Filter losses.

7. Proper operation of the transmitter prior to adding the filter to the measurement chain.

8. Since non-restricted band peak emissions are less than the average limit, they also comply with the -27dBm/MHz (68.2dBuV/m) limit.

HARMONICS AND SPURIOUS EMISSIONS (MID CHANNEL, VERTICAL)

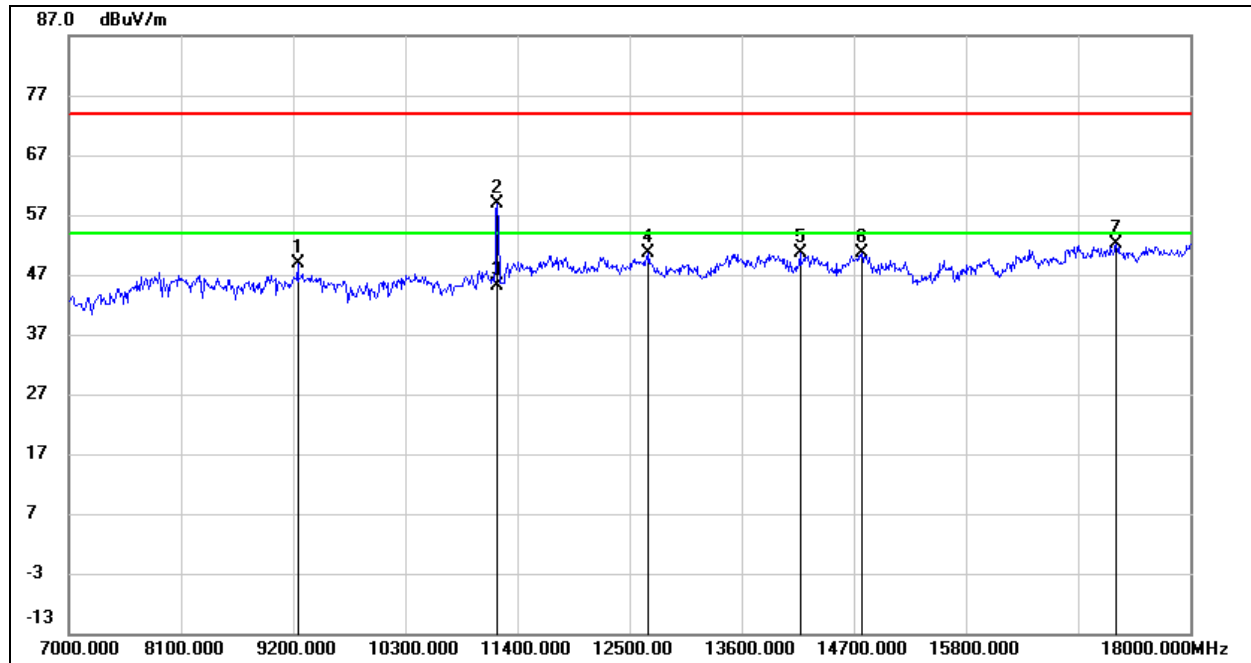

No.	Frequency (MHz)	Reading (dBuV)	Correct (dB/m)	Result (dBuV/m)	Limit (dBuV/m)	Margin (dB)	Remark
1	9244.000	38.80	10.12	48.92	74.00	-25.08	peak
2	11202.000	45.09	13.79	58.88	74.00	-15.12	peak
3	11202.000	31.26	13.79	45.05	54.00	-8.95	AVG
4	12687.000	34.93	15.64	50.57	74.00	-23.43	peak
5	14172.000	32.85	17.70	50.55	74.00	-23.45	peak
6	14777.000	32.69	17.96	50.65	74.00	-23.35	peak
7	17274.000	29.67	22.45	52.12	74.00	-21.88	peak

Note: 1. Measurement = Reading Level + Correct Factor.

2. If Peak Result complies with AV limit, AV Result is deemed to comply with AV limit.

3. Peak: Peak detector.

4. AVG: $VBW=1/Ton$, where: Ton is the transmitting duration.

5. For the transmitting duration, please refer to clause 7.1.

6. Filter losses were only considered in the spurious frequency bands and the authorized band was not corrected for High Pass Filter losses.

7. Proper operation of the transmitter prior to adding the filter to the measurement chain.

8. Since non-restricted band peak emissions are less than the average limit, they also comply with the -27dBm/MHz (68.2dBuV/m) limit.

HARMONICS AND SPURIOUS EMISSIONS (HIGH CHANNEL, HORIZONTAL)

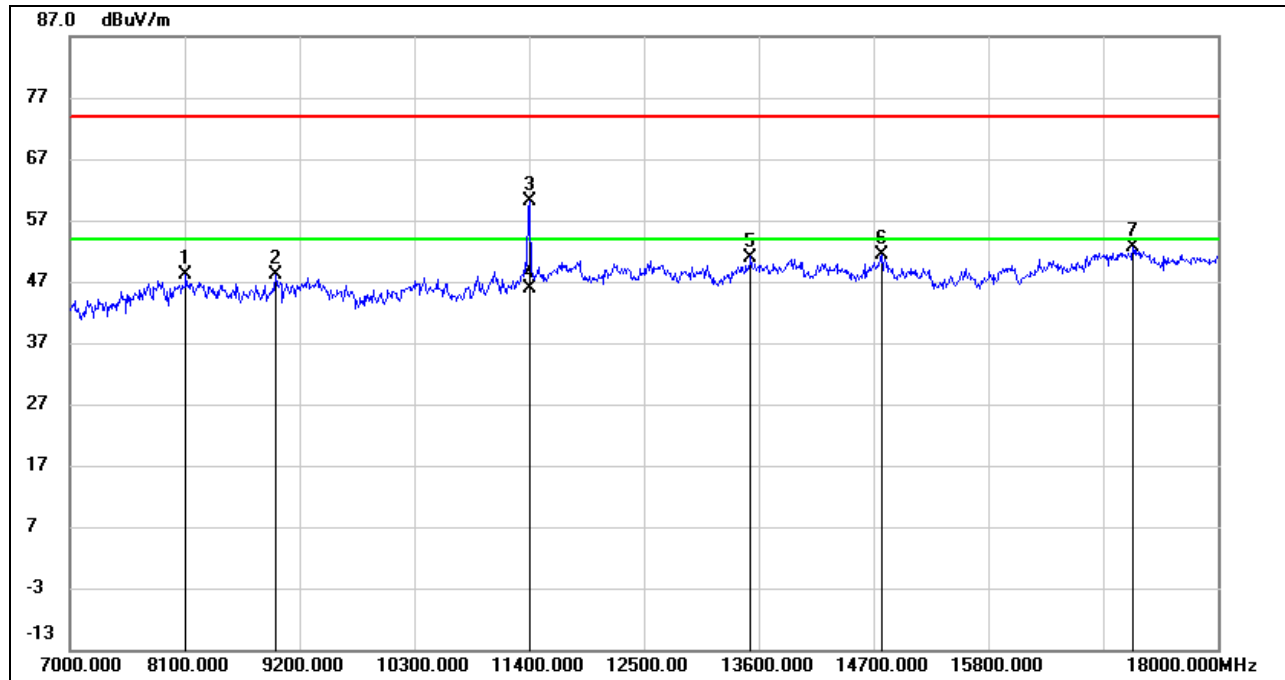

No.	Frequency (MHz)	Reading (dBuV)	Correct (dB/m)	Result (dBuV/m)	Limit (dBuV/m)	Margin (dB)	Remark
1	8111.000	38.06	10.14	48.20	74.00	-25.80	peak
2	8969.000	37.50	10.69	48.19	74.00	-25.81	peak
3	11400.000	45.35	14.76	60.11	74.00	-13.89	peak
4	11400.000	31.20	14.76	45.96	54.00	-8.04	AVG
5	13523.000	33.81	17.19	51.00	74.00	-23.00	peak
6	14777.000	33.38	17.96	51.34	74.00	-22.66	peak
7	17186.000	30.76	21.98	52.74	74.00	-21.26	peak

- Note:
1. Measurement = Reading Level + Correct Factor.
 2. If Peak Result complies with AV limit, AV Result is deemed to comply with AV limit.
 3. Peak: Peak detector.
 4. AVG: $VBW=1/Ton$, where: Ton is the transmitting duration.
 5. For the transmitting duration, please refer to clause 7.1.
 6. Filter losses were only considered in the spurious frequency bands and the authorized band was not corrected for High Pass Filter losses.
 7. Proper operation of the transmitter prior to adding the filter to the measurement chain.
 8. Since non-restricted band peak emissions are less than the average limit, they also comply with the -27dBm/MHz (68.2dBuV/m) limit.

HARMONICS AND SPURIOUS EMISSIONS (HIGH CHANNEL, VERTICAL)

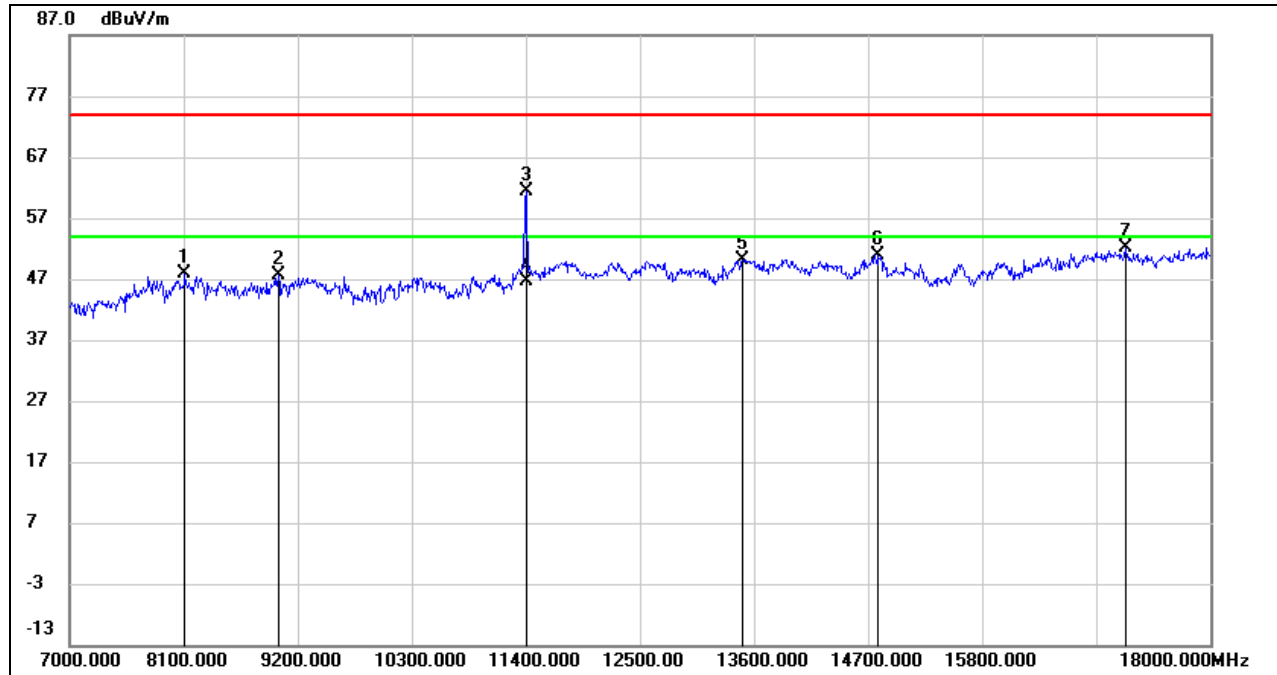

No.	Frequency (MHz)	Reading (dBuV)	Correct (dB/m)	Result (dBuV/m)	Limit (dBuV/m)	Margin (dB)	Remark
1	8111.000	37.68	10.14	47.82	74.00	-26.18	peak
2	9013.000	36.63	11.12	47.75	74.00	-26.25	peak
3	11400.000	46.52	14.76	61.28	74.00	-12.72	peak
4	11400.000	31.90	14.76	46.66	54.00	-7.34	AVG
5	13490.000	33.01	17.20	50.21	74.00	-23.79	peak
6	14799.000	32.89	18.04	50.93	74.00	-23.07	peak
7	17186.000	30.03	21.98	52.01	74.00	-21.99	peak

Note: 1. Measurement = Reading Level + Correct Factor.

2. If Peak Result complies with AV limit, AV Result is deemed to comply with AV limit.

3. Peak: Peak detector.

4. AVG: $VBW=1/T_{on}$, where: T_{on} is the transmitting duration.

5. For the transmitting duration, please refer to clause 7.1.

6. Filter losses were only considered in the spurious frequency bands and the authorized band was not corrected for High Pass Filter losses.

7. Proper operation of the transmitter prior to adding the filter to the measurement chain.

8. Since non-restricted band peak emissions are less than the average limit, they also comply with the -27dBm/MHz (68.2dBuV/m) limit.

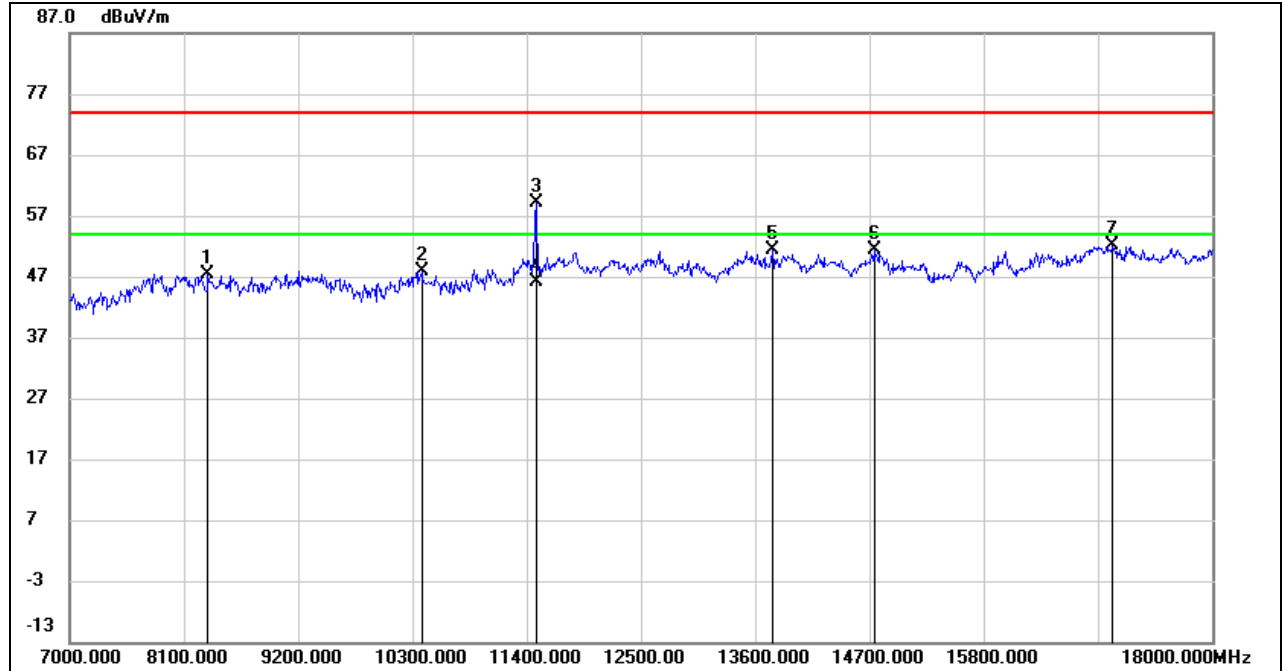
UNII-3 BAND
HARMONICS AND SPURIOUS EMISSIONS (LOW CHANNEL, HORIZONTAL)

No.	Frequency (MHz)	Reading (dBuV)	Correct (dB/m)	Result (dBuV/m)	Limit (dBuV/m)	Margin (dB)	Remark
1	8331.000	37.91	9.58	47.49	74.00	-26.51	peak
2	10388.000	35.73	12.18	47.91	74.00	-26.09	peak
3	11488.000	44.45	14.66	59.11	74.00	-14.89	peak
4	11488.000	31.37	14.66	46.03	54.00	-7.97	AVG
5	13765.000	33.80	17.61	51.41	74.00	-22.59	peak
6	14744.000	33.64	17.84	51.48	74.00	-22.52	peak
7	17043.000	30.69	21.52	52.21	74.00	-21.79	peak

Note: 1. Measurement = Reading Level + Correct Factor.

2. If Peak Result complies with AV limit, AV Result is deemed to comply with AV limit.

3. Peak: Peak detector.

4. AVG: $VBW=1/Ton$, where: Ton is the transmitting duration.

5. For the transmitting duration, please refer to clause 7.1.

6. Filter losses were only considered in the spurious frequency bands and the authorized band was not corrected for High Pass Filter losses.

7. Proper operation of the transmitter prior to adding the filter to the measurement chain.

8. Since non-restricted band peak emissions are less than the average limit, they also comply with the -27dBm/MHz (68.2dBuV/m) limit.

HARMONICS AND SPURIOUS EMISSIONS (LOW CHANNEL, VERTICAL)

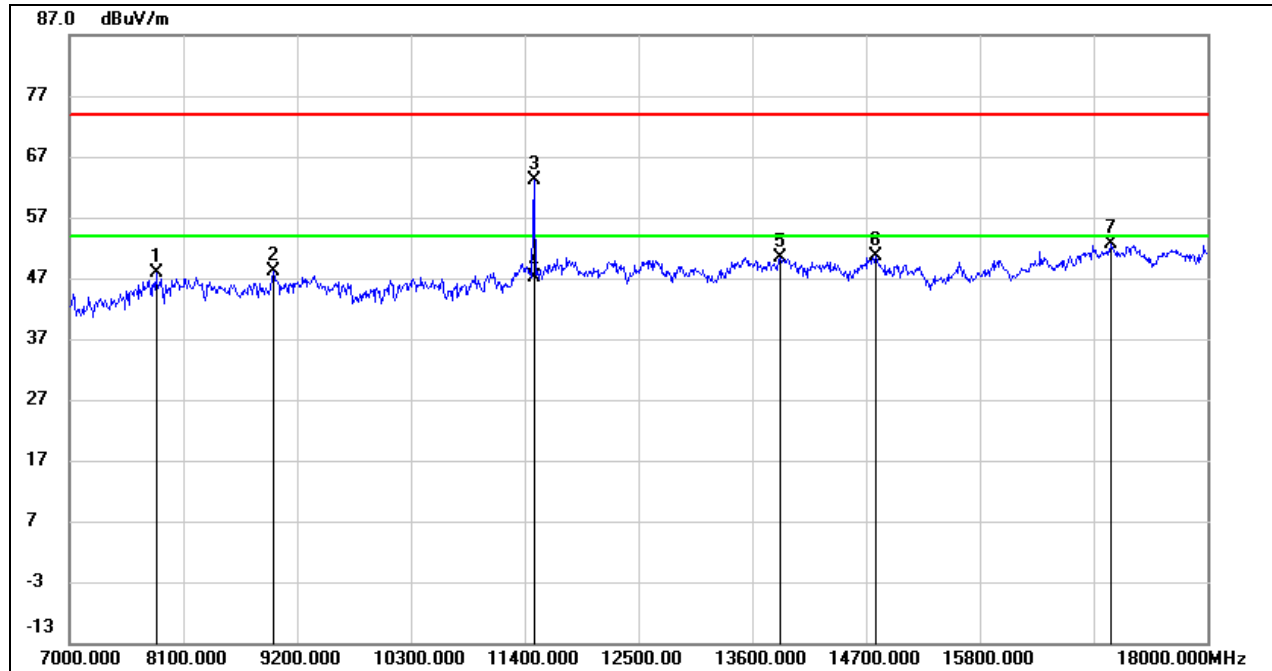

No.	Frequency (MHz)	Reading (dBuV)	Correct (dB/m)	Result (dBuV/m)	Limit (dBuV/m)	Margin (dB)	Remark
1	7836.000	38.65	9.17	47.82	74.00	-26.18	peak
2	8969.000	37.42	10.69	48.11	74.00	-25.89	peak
3	11488.000	48.40	14.66	63.06	74.00	-10.94	peak
4	11488.000	32.45	14.66	47.11	54.00	-6.89	AVG
5	13875.000	32.95	17.55	50.50	74.00	-23.50	peak
6	14788.000	32.62	18.00	50.62	74.00	-23.38	peak
7	17065.000	30.88	21.67	52.55	74.00	-21.45	peak

Note: 1. Measurement = Reading Level + Correct Factor.

2. If Peak Result complies with AV limit, AV Result is deemed to comply with AV limit.

3. Peak: Peak detector.

4. AVG: $VBW=1/T_{on}$, where: T_{on} is the transmitting duration.

5. For the transmitting duration, please refer to clause 7.1.

6. Filter losses were only considered in the spurious frequency bands and the authorized band was not corrected for High Pass Filter losses.

7. Proper operation of the transmitter prior to adding the filter to the measurement chain.

8. Since non-restricted band peak emissions are less than the average limit, they also comply with the -27dBm/MHz (68.2dBuV/m) limit.

HARMONICS AND SPURIOUS EMISSIONS (MID CHANNEL, HORIZONTAL)

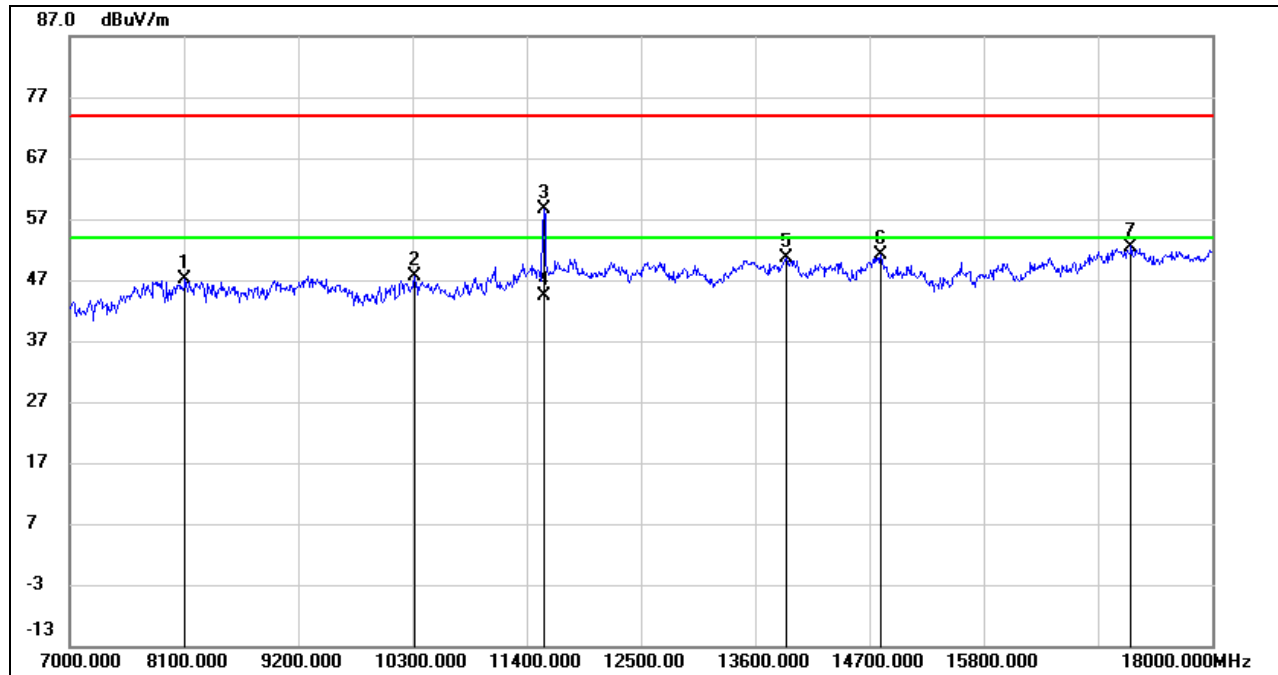

No.	Frequency (MHz)	Reading (dBuV)	Correct (dB/m)	Result (dBuV/m)	Limit (dBuV/m)	Margin (dB)	Remark
1	8111.000	37.07	10.14	47.21	74.00	-26.79	peak
2	10322.000	35.80	11.91	47.71	74.00	-26.29	peak
3	11565.000	44.03	14.69	58.72	74.00	-15.28	peak
4	11565.000	29.72	14.69	44.41	54.00	-9.59	AVG
5	13897.000	33.16	17.52	50.68	74.00	-23.32	peak
6	14810.000	33.20	17.97	51.17	74.00	-22.83	peak
7	17219.000	30.39	22.11	52.50	74.00	-21.50	peak

- Note:
1. Measurement = Reading Level + Correct Factor.
 2. If Peak Result complies with AV limit, AV Result is deemed to comply with AV limit.
 3. Peak: Peak detector.
 4. AVG: VBW=1/Ton, where: Ton is the transmitting duration.
 5. For the transmitting duration, please refer to clause 7.1.
 6. Filter losses were only considered in the spurious frequency bands and the authorized band was not corrected for High Pass Filter losses.
 7. Proper operation of the transmitter prior to adding the filter to the measurement chain.
 8. Since non-restricted band peak emissions are less than the average limit, they also comply with the -27dBm/MHz (68.2dBuV/m) limit.

HARMONICS AND SPURIOUS EMISSIONS (MID CHANNEL, VERTICAL)

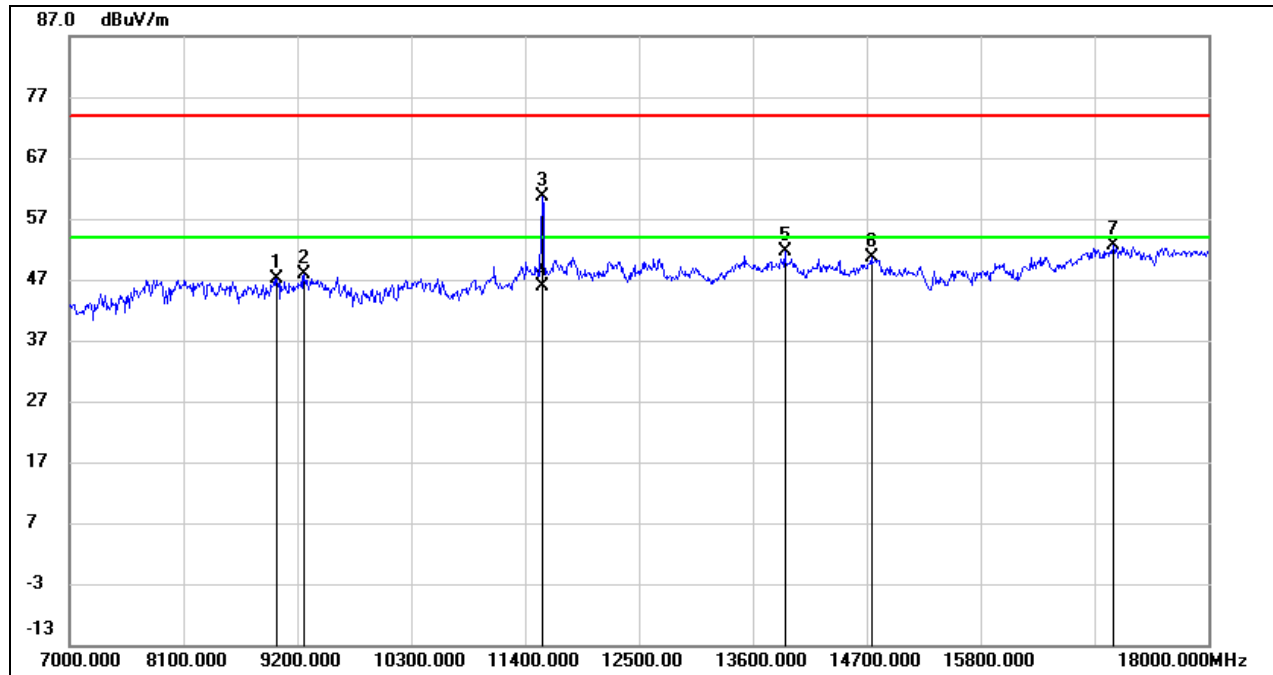

No.	Frequency (MHz)	Reading (dBuV)	Correct (dB/m)	Result (dBuV/m)	Limit (dBuV/m)	Margin (dB)	Remark
1	9002.000	35.98	11.24	47.22	74.00	-26.78	peak
2	9266.000	37.71	10.23	47.94	74.00	-26.06	peak
3	11565.000	46.01	14.69	60.70	74.00	-13.30	peak
4	11565.000	31.17	14.69	45.86	54.00	-8.14	AVG
5	13908.000	34.04	17.54	51.58	74.00	-22.42	peak
6	14744.000	32.75	17.84	50.59	74.00	-23.41	peak
7	17087.000	30.79	21.81	52.60	74.00	-21.40	peak

- Note:
1. Measurement = Reading Level + Correct Factor.
 2. If Peak Result complies with AV limit, AV Result is deemed to comply with AV limit.
 3. Peak: Peak detector.
 4. AVG: VBW=1/Ton, where: Ton is the transmitting duration.
 5. For the transmitting duration, please refer to clause 7.1.
 6. Filter losses were only considered in the spurious frequency bands and the authorized band was not corrected for High Pass Filter losses.
 7. Proper operation of the transmitter prior to adding the filter to the measurement chain.
 8. Since non-restricted band peak emissions are less than the average limit, they also comply with the -27dBm/MHz (68.2dBuV/m) limit.

HARMONICS AND SPURIOUS EMISSIONS (HIGH CHANNEL, HORIZONTAL)

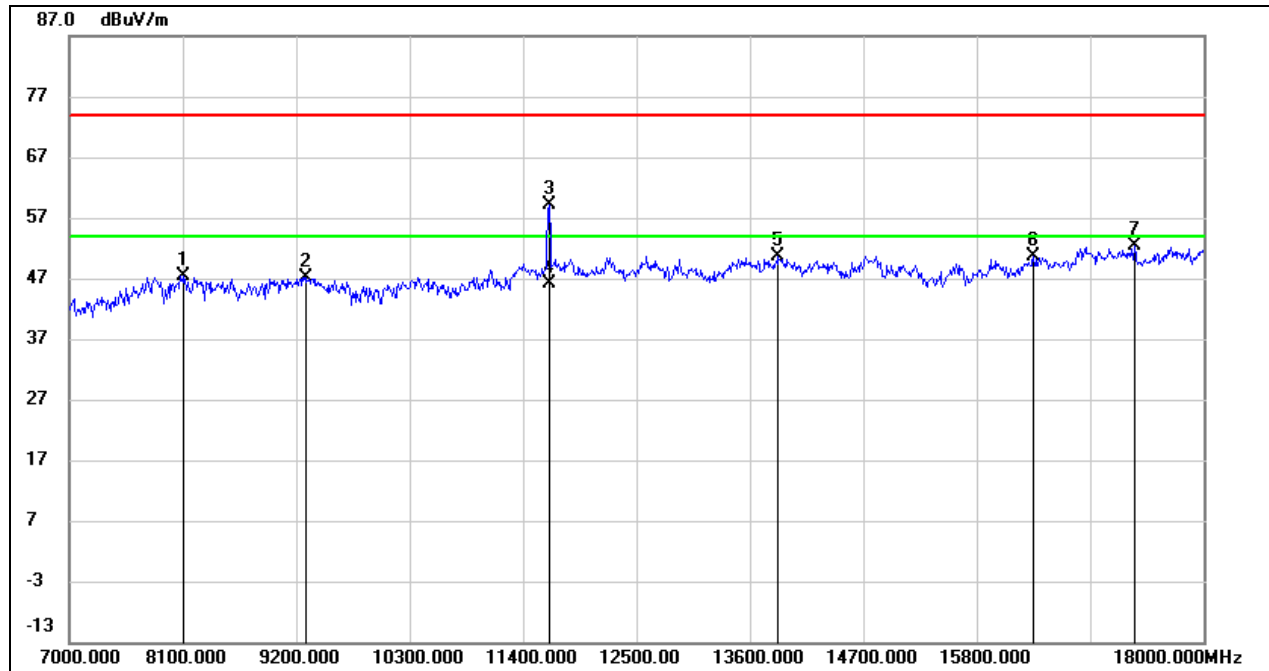

No.	Frequency (MHz)	Reading (dBuV)	Correct (dB/m)	Result (dBuV/m)	Limit (dBuV/m)	Margin (dB)	Remark
1	8111.000	37.33	10.14	47.47	74.00	-26.53	peak
2	9299.000	36.81	10.40	47.21	74.00	-26.79	peak
3	11653.000	44.14	15.05	59.19	74.00	-14.81	peak
4	11653.000	30.97	15.05	46.02	54.00	-7.98	AVG
5	13875.000	32.96	17.55	50.51	74.00	-23.49	peak
6	16350.000	31.02	19.65	50.67	74.00	-23.33	peak
7	17329.000	29.89	22.39	52.28	74.00	-21.72	peak

- Note: 1. Measurement = Reading Level + Correct Factor.
 2. If Peak Result complies with AV limit, AV Result is deemed to comply with AV limit.
 3. Peak: Peak detector.
 4. AVG: $VBW=1/Ton$, where: Ton is the transmitting duration.
 5. For the transmitting duration, please refer to clause 7.1.
 6. Filter losses were only considered in the spurious frequency bands and the authorized band was not corrected for High Pass Filter losses.
 7. Proper operation of the transmitter prior to adding the filter to the measurement chain.
 8. Since non-restricted band peak emissions are less than the average limit, they also comply with the -27dBm/MHz (68.2dBuV/m) limit.

HARMONICS AND SPURIOUS EMISSIONS (HIGH CHANNEL, VERTICAL)

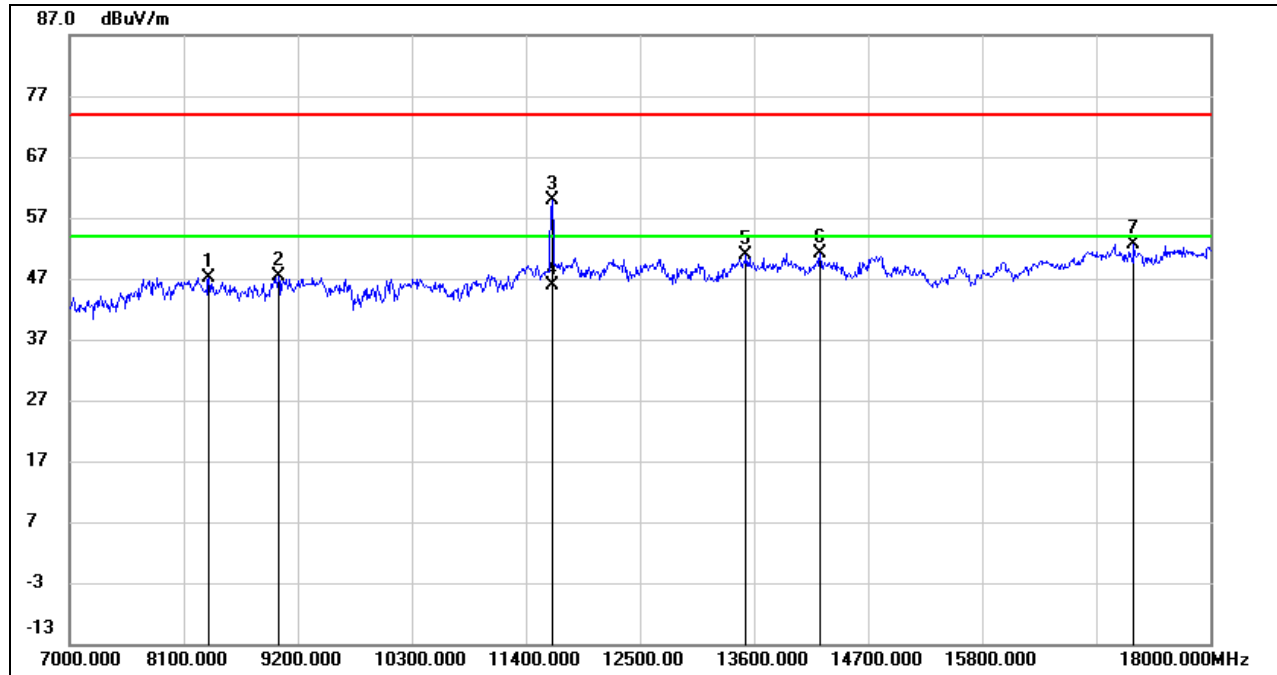

No.	Frequency (MHz)	Reading (dBuV)	Correct (dB/m)	Result (dBuV/m)	Limit (dBuV/m)	Margin (dB)	Remark
1	8342.000	37.68	9.54	47.22	74.00	-26.78	peak
2	9013.000	36.29	11.12	47.41	74.00	-26.59	peak
3	11653.000	44.81	15.05	59.86	74.00	-14.14	peak
4	11653.000	30.95	15.05	46.00	54.00	-8.00	AVG
5	13523.000	33.65	17.19	50.84	74.00	-23.16	peak
6	14238.000	33.27	17.92	51.19	74.00	-22.81	peak
7	17263.000	30.23	22.38	52.61	74.00	-21.39	peak

- Note: 1. Measurement = Reading Level + Correct Factor.
 2. If Peak Result complies with AV limit, AV Result is deemed to comply with AV limit.
 3. Peak: Peak detector.
 4. AVG: VBW=1/Ton, where: Ton is the transmitting duration.
 5. For the transmitting duration, please refer to clause 7.1.
 6. Filter losses were only considered in the spurious frequency bands and the authorized band was not corrected for High Pass Filter losses.
 7. Proper operation of the transmitter prior to adding the filter to the measurement chain.
 8. Since non-restricted band peak emissions are less than the average limit, they also comply with the -27dBm/MHz (68.2dBuV/m) limit.

8.3.2. 802.11n HT20 MIMO MODE

UNII-1 BAND

HARMONICS AND SPURIOUS EMISSIONS (LOW CHANNEL, HORIZONTAL)

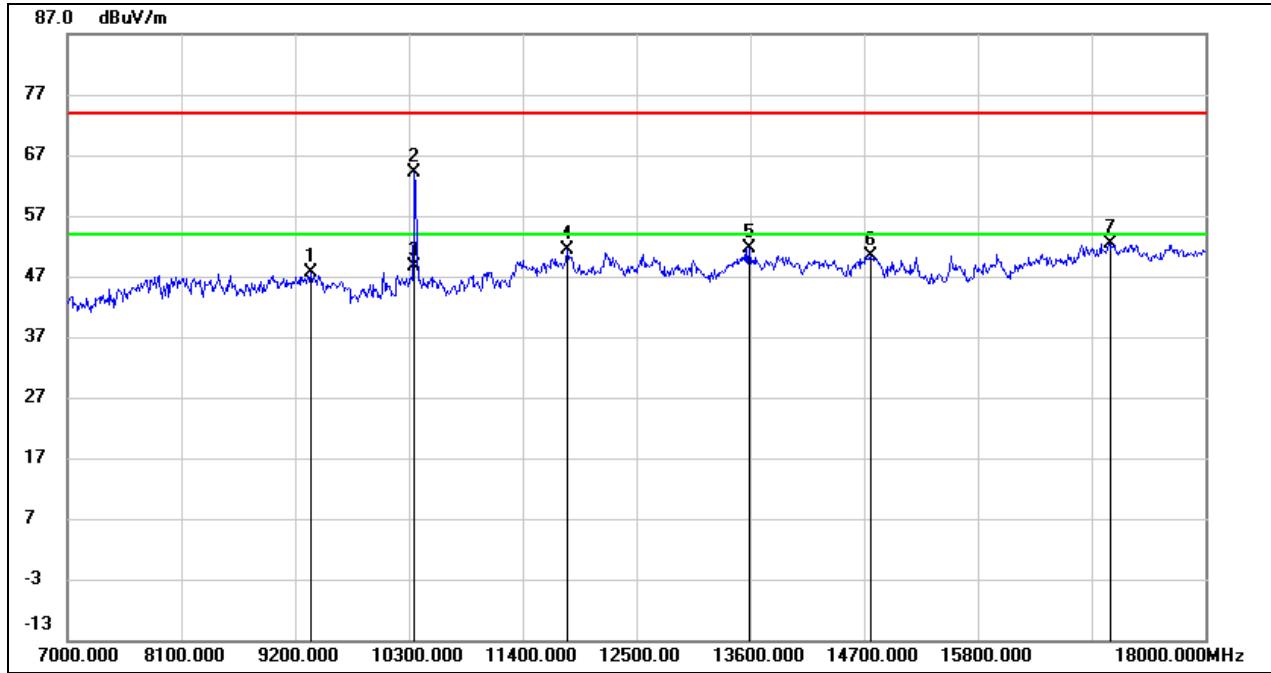

No.	Frequency (MHz)	Reading (dBuV)	Correct (dB/m)	Result (dBuV/m)	Limit (dBuV/m)	Margin (dB)	Remark
1	9354.000	36.95	10.70	47.65	74.00	-26.35	peak
2	10355.000	52.05	12.04	64.09	68.20	-4.11	peak
3	10355.000	36.47	12.04	48.51	/	/	AVG
4	11829.000	36.12	15.32	51.44	74.00	-22.56	peak
5	13589.000	34.45	17.11	51.56	74.00	-22.44	peak
6	14766.000	32.40	17.92	50.32	74.00	-23.68	peak
7	17076.000	30.65	21.74	52.39	74.00	-21.61	peak

Note: 1. Measurement = Reading Level + Correct Factor.
 2. If Peak Result complies with AV limit, AV Result is deemed to comply with AV limit.
 3. Peak: Peak detector.
 4. AVG: $VBW=1/Ton$, where: Ton is the transmitting duration.
 5. For the transmitting duration, please refer to clause 7.1.
 6. Filter losses were only considered in the spurious frequency bands and the authorized band was not corrected for High Pass Filter losses.
 7. Proper operation of the transmitter prior to adding the filter to the measurement chain.
 8. Since non-restricted band peak emissions are less than the average limit, they also comply with the -27dBm/MHz (68.2dBuV/m) limit.



HARMONICS AND SPURIOUS EMISSIONS (LOW CHANNEL, VERTICAL)

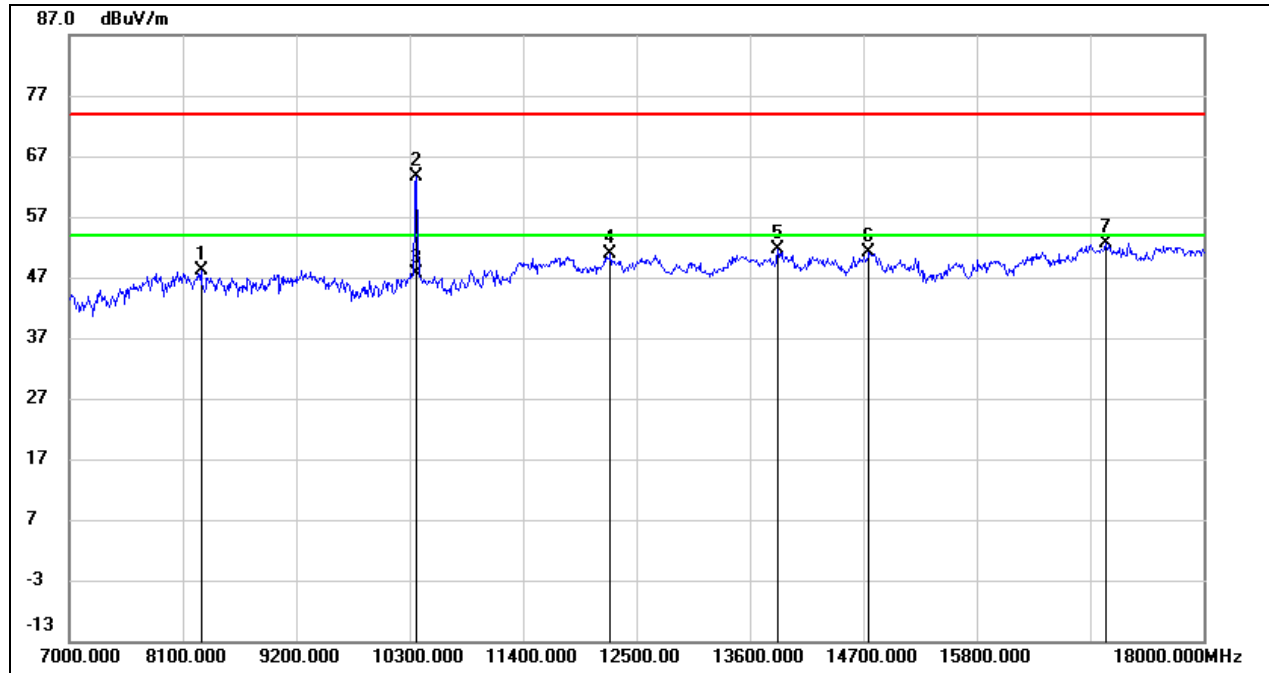

No.	Frequency (MHz)	Reading (dBuV)	Correct (dB/m)	Result (dBuV/m)	Limit (dBuV/m)	Margin (dB)	Remark
1	8276.000	38.49	9.71	48.20	74.00	-25.80	peak
2	10366.000	51.61	12.09	63.7	68.20	-4.50	peak
3	10366.000	35.49	12.09	47.58	/	/	AVG
4	12247.000	34.76	16.02	50.78	74.00	-23.22	peak
5	13875.000	33.98	17.55	51.53	74.00	-22.47	peak
6	14755.000	33.24	17.88	51.12	74.00	-22.88	peak
7	17054.000	30.96	21.59	52.55	74.00	-21.45	peak

- Note: 1. Measurement = Reading Level + Correct Factor.
 2. If Peak Result complies with AV limit, AV Result is deemed to comply with AV limit.
 3. Peak: Peak detector.
 4. AVG: $VBW=1/Ton$, where: Ton is the transmitting duration.
 5. For the transmitting duration, please refer to clause 7.1.
 6. Filter losses were only considered in the spurious frequency bands and the authorized band was not corrected for High Pass Filter losses.
 7. Proper operation of the transmitter prior to adding the filter to the measurement chain.
 8. Since non-restricted band peak emissions are less than the average limit, they also comply with the -27dBm/MHz (68.2dBuV/m) limit.



HARMONICS AND SPURIOUS EMISSIONS (MID CHANNEL, HORIZONTAL)

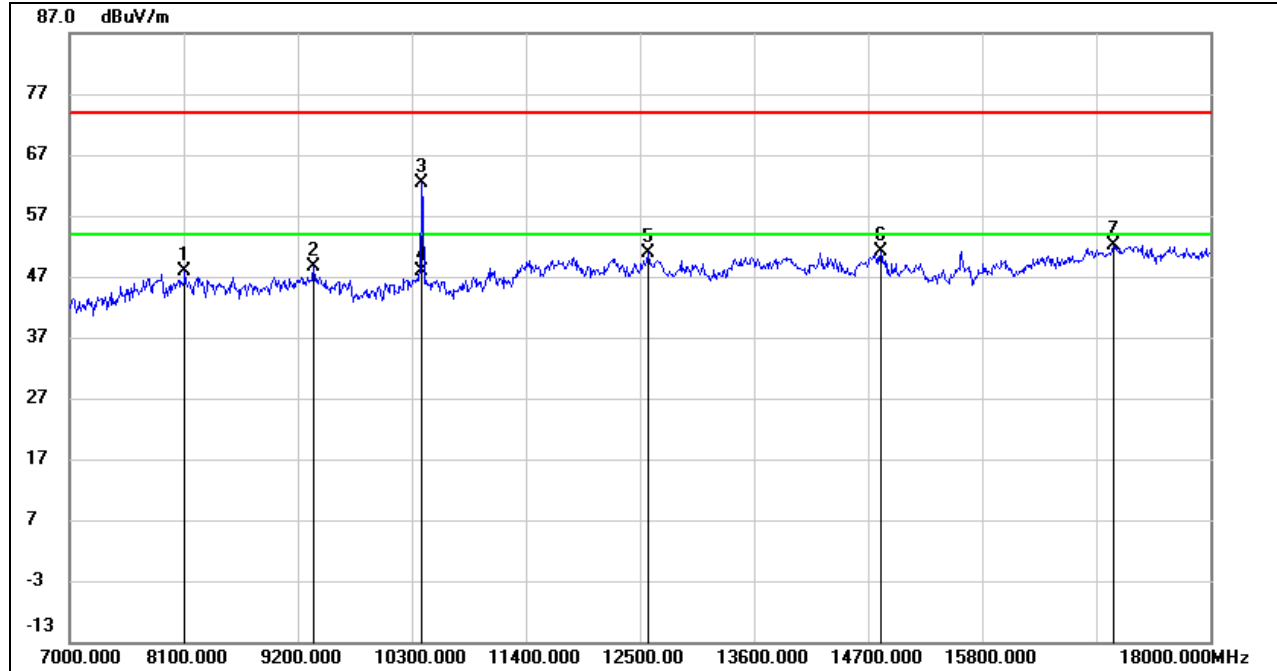

No.	Frequency (MHz)	Reading (dBuV)	Correct (dB/m)	Result (dBuV/m)	Limit (dBuV/m)	Margin (dB)	Remark
1	8111.000	37.62	10.14	47.76	74.00	-26.24	peak
2	9354.000	37.95	10.70	48.65	74.00	-25.35	peak
3	10399.000	50.03	12.23	62.26	68.20	-5.94	peak
4	10399.000	35.53	12.23	47.76	/	/	AVG
5	12577.000	35.22	15.75	50.97	74.00	-23.03	peak
6	14821.000	33.16	17.90	51.06	74.00	-22.94	peak
7	17065.000	30.57	21.67	52.24	74.00	-21.76	peak

- Note: 1. Measurement = Reading Level + Correct Factor.
 2. If Peak Result complies with AV limit, AV Result is deemed to comply with AV limit.
 3. Peak: Peak detector.
 4. AVG: $VBW=1/Ton$, where: Ton is the transmitting duration.
 5. For the transmitting duration, please refer to clause 7.1.
 6. Filter losses were only considered in the spurious frequency bands and the authorized band was not corrected for High Pass Filter losses.
 7. Proper operation of the transmitter prior to adding the filter to the measurement chain.
 8. Since non-restricted band peak emissions are less than the average limit, they also comply with the -27dBm/MHz (68.2dBuV/m) limit.

HARMONICS AND SPURIOUS EMISSIONS (MID CHANNEL, VERTICAL)

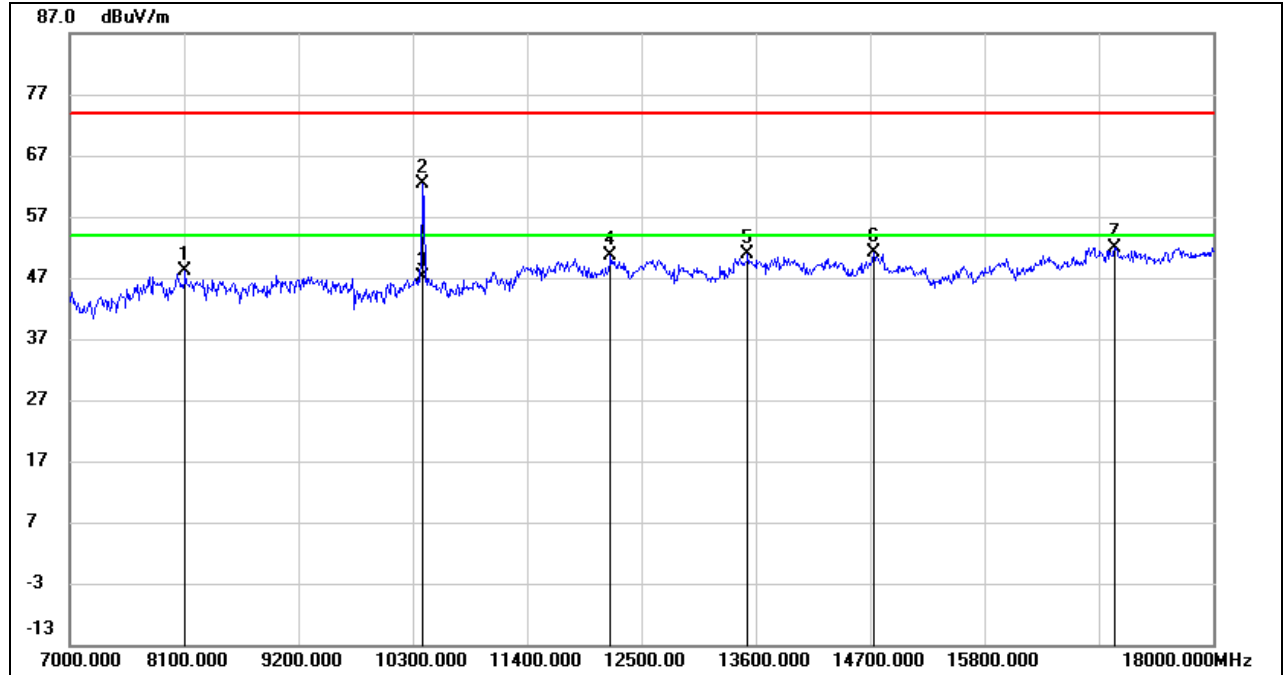

No.	Frequency (MHz)	Reading (dBuV)	Correct (dB/m)	Result (dBuV/m)	Limit (dBuV/m)	Margin (dB)	Remark
1	8111.000	37.91	10.14	48.05	74.00	-25.95	peak
2	10399.000	50.24	12.23	62.47	68.20	-5.73	peak
3	10399.000	34.94	12.23	47.17	/	/	AVG
4	12203.000	34.64	15.95	50.59	74.00	-23.41	peak
5	13523.000	33.68	17.19	50.87	74.00	-23.13	peak
6	14733.000	33.30	17.81	51.11	74.00	-22.89	peak
7	17054.000	30.37	21.59	51.96	74.00	-22.04	peak

- Note:
1. Measurement = Reading Level + Correct Factor.
 2. If Peak Result complies with AV limit, AV Result is deemed to comply with AV limit.
 3. Peak: Peak detector.
 4. AVG: $VBW=1/Ton$, where: Ton is the transmitting duration.
 5. For the transmitting duration, please refer to clause 7.1.
 6. Filter losses were only considered in the spurious frequency bands and the authorized band was not corrected for High Pass Filter losses.
 7. Proper operation of the transmitter prior to adding the filter to the measurement chain.
 8. Since non-restricted band peak emissions are less than the average limit, they also comply with the -27dBm/MHz (68.2dBuV/m) limit.

HARMONICS AND SPURIOUS EMISSIONS (HIGH CHANNEL, HORIZONTAL)

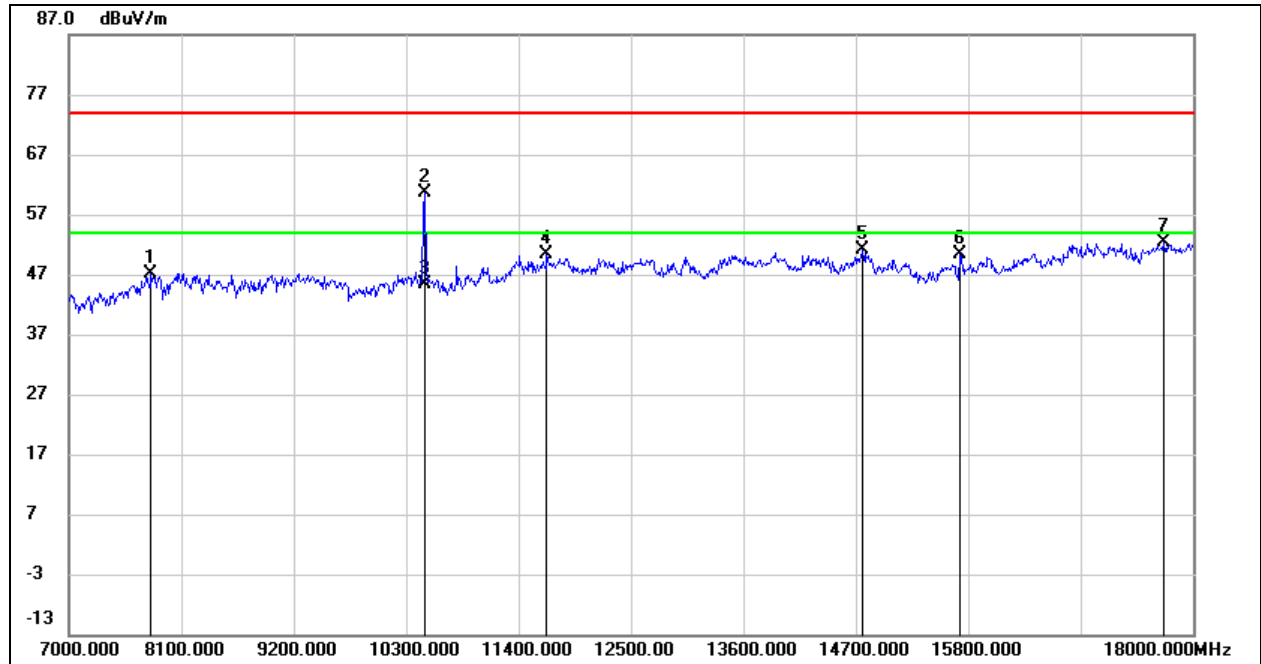

No.	Frequency (MHz)	Reading (dBuV)	Correct (dB/m)	Result (dBuV/m)	Limit (dBuV/m)	Margin (dB)	Remark
1	7803.000	37.84	9.33	47.17	74.00	-26.83	peak
2	10476.000	48.37	12.33	60.70	68.20	-7.50	peak
3	10476.000	32.95	12.33	45.28	/	/	AVG
4	11675.000	35.14	15.18	50.32	74.00	-23.68	peak
5	14766.000	33.33	17.92	51.25	74.00	-22.75	peak
6	15712.000	32.48	17.85	50.33	74.00	-23.67	peak
7	17714.000	28.80	23.55	52.35	74.00	-21.65	peak

Note: 1. Measurement = Reading Level + Correct Factor.
 2. If Peak Result complies with AV limit, AV Result is deemed to comply with AV limit.
 3. Peak: Peak detector.
 4. AVG: $VBW=1/Ton$, where: Ton is the transmitting duration.
 5. For the transmitting duration, please refer to clause 7.1.
 6. Filter losses were only considered in the spurious frequency bands and the authorized band was not corrected for High Pass Filter losses.
 7. Proper operation of the transmitter prior to adding the filter to the measurement chain.
 8. Since non-restricted band peak emissions are less than the average limit, they also comply with the -27dBm/MHz (68.2dBuV/m) limit.



HARMONICS AND SPURIOUS EMISSIONS (HIGH CHANNEL, VERTICAL)

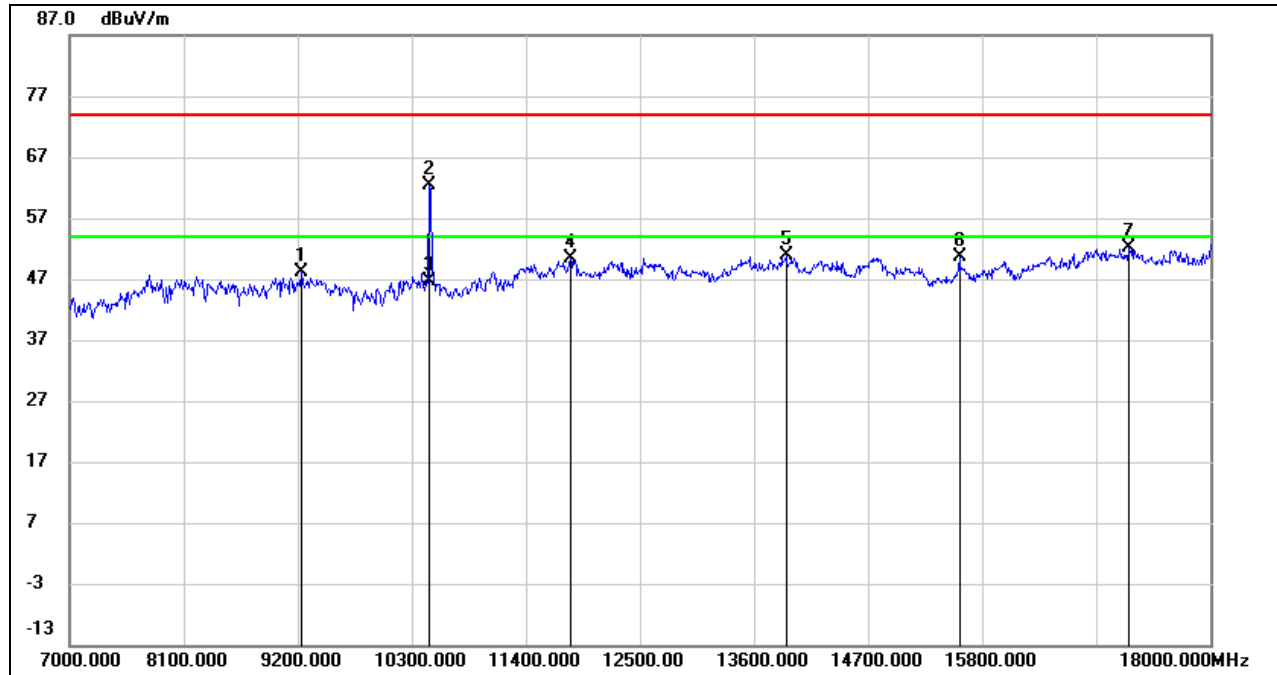

No.	Frequency (MHz)	Reading (dBuV)	Correct (dB/m)	Result (dBuV/m)	Limit (dBuV/m)	Margin (dB)	Remark
1	9233.000	37.99	10.08	48.07	74.00	-25.93	peak
2	10465.000	50.16	12.32	62.48	68.20	-5.72	peak
3	10465.000	34.37	12.32	46.69	/	/	AVG
4	11829.000	35.18	15.32	50.50	74.00	-23.50	peak
5	13908.000	33.40	17.54	50.94	74.00	-23.06	peak
6	15580.000	32.97	17.57	50.54	74.00	-23.46	peak
7	17219.000	29.91	22.11	52.02	74.00	-21.98	peak

- Note: 1. Measurement = Reading Level + Correct Factor.
 2. If Peak Result complies with AV limit, AV Result is deemed to comply with AV limit.
 3. Peak: Peak detector.
 4. AVG: $VBW=1/Ton$, where: Ton is the transmitting duration.
 5. For the transmitting duration, please refer to clause 7.1.
 6. Filter losses were only considered in the spurious frequency bands and the authorized band was not corrected for High Pass Filter losses.
 7. Proper operation of the transmitter prior to adding the filter to the measurement chain.
 8. Since non-restricted band peak emissions are less than the average limit, they also comply with the -27dBm/MHz (68.2dBuV/m) limit.

UNII-2A BAND

HARMONICS AND SPURIOUS EMISSIONS (LOW CHANNEL, HORIZONTAL)

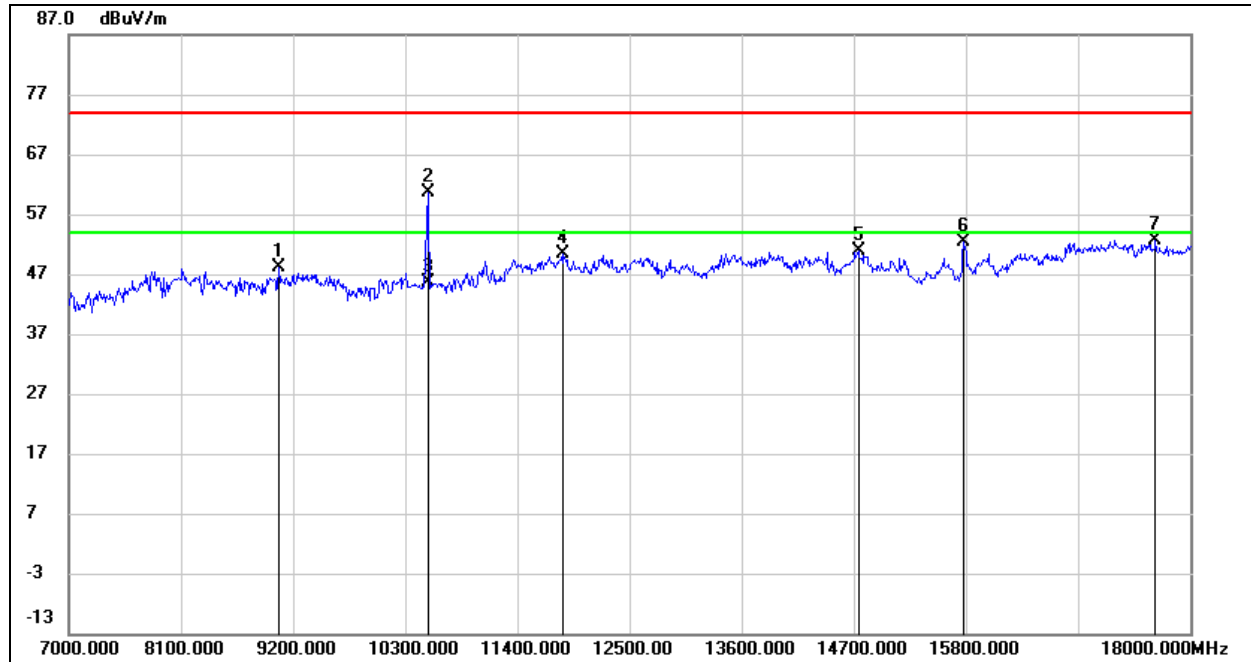

No.	Frequency (MHz)	Reading (dBuV)	Correct (dB/m)	Result (dBuV/m)	Limit (dBuV/m)	Margin (dB)	Remark
1	9057.000	37.45	10.64	48.09	74.00	-25.91	peak
2	10520.000	48.24	12.43	60.67	68.20	-7.53	peak
3	10520.000	33.12	12.43	45.55	/	/	AVG
4	11840.000	35.13	15.35	50.48	74.00	-23.52	peak
5	14744.000	32.94	17.84	50.78	74.00	-23.22	peak
6	15778.000	34.34	17.96	52.30	74.00	-21.70	peak
7	17659.000	29.56	23.17	52.73	74.00	-21.27	peak

Note: 1. Measurement = Reading Level + Correct Factor.
 2. If Peak Result complies with AV limit, AV Result is deemed to comply with AV limit.
 3. Peak: Peak detector.
 4. AVG: VBW=1/Ton, where: Ton is the transmitting duration.
 5. For the transmitting duration, please refer to clause 7.1.
 6. Filter losses were only considered in the spurious frequency bands and the authorized band was not corrected for High Pass Filter losses.
 7. Proper operation of the transmitter prior to adding the filter to the measurement chain.
 8. Since non-restricted band peak emissions are less than the average limit, they also comply with the -27dBm/MHz (68.2dBuV/m) limit.

HARMONICS AND SPURIOUS EMISSIONS (LOW CHANNEL, VERTICAL)

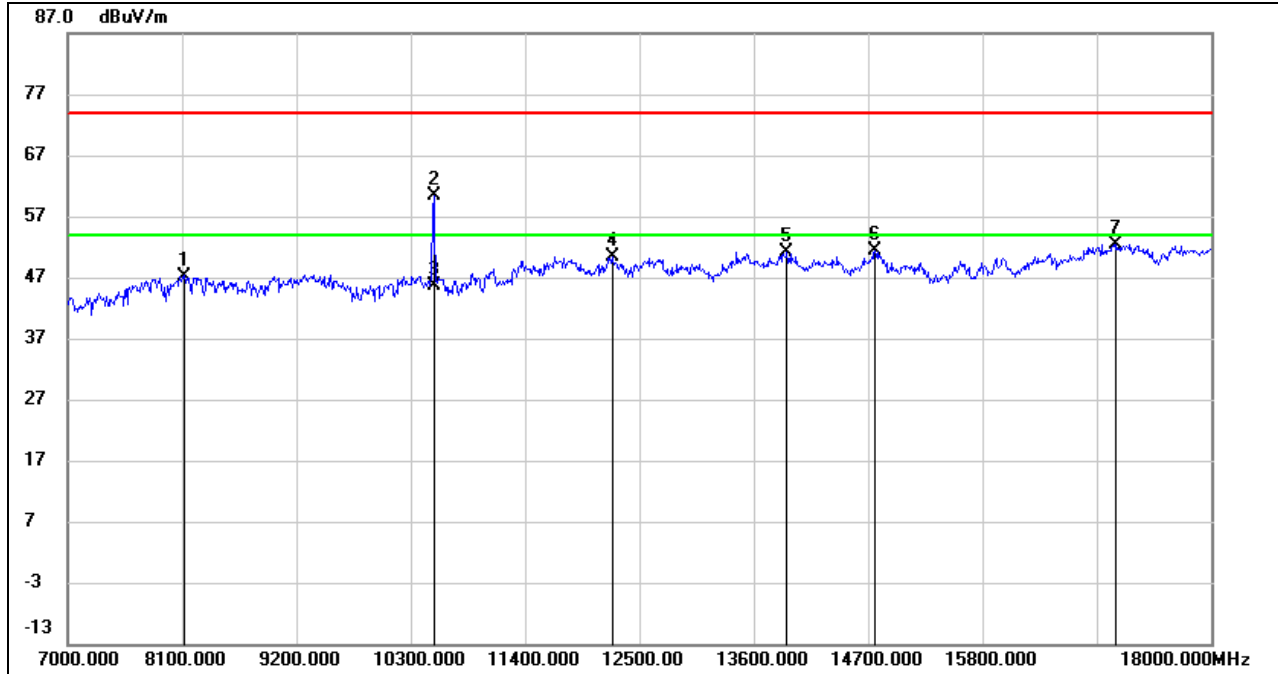

No.	Frequency (MHz)	Reading (dBuV)	Correct (dB/m)	Result (dBuV/m)	Limit (dBuV/m)	Margin (dB)	Remark
1	8122.000	37.15	10.10	47.25	74.00	-26.75	peak
2	10520.000	48.05	12.43	60.48	68.20	-7.72	peak
3	10520.000	33.15	12.43	45.58	/	/	AVG
4	12236.000	34.46	16.01	50.47	74.00	-23.53	peak
5	13919.000	33.68	17.55	51.23	74.00	-22.77	peak
6	14766.000	33.48	17.92	51.40	74.00	-22.60	peak
7	17087.000	30.68	21.81	52.49	74.00	-21.51	peak

- Note: 1. Measurement = Reading Level + Correct Factor.
 2. If Peak Result complies with AV limit, AV Result is deemed to comply with AV limit.
 3. Peak: Peak detector.
 4. AVG: $VBW=1/Ton$, where: Ton is the transmitting duration.
 5. For the transmitting duration, please refer to clause 7.1.
 6. Filter losses were only considered in the spurious frequency bands and the authorized band was not corrected for High Pass Filter losses.
 7. Proper operation of the transmitter prior to adding the filter to the measurement chain.
 8. Since non-restricted band peak emissions are less than the average limit, they also comply with the -27dBm/MHz (68.2dBuV/m) limit.

HARMONICS AND SPURIOUS EMISSIONS (MID CHANNEL, HORIZONTAL)

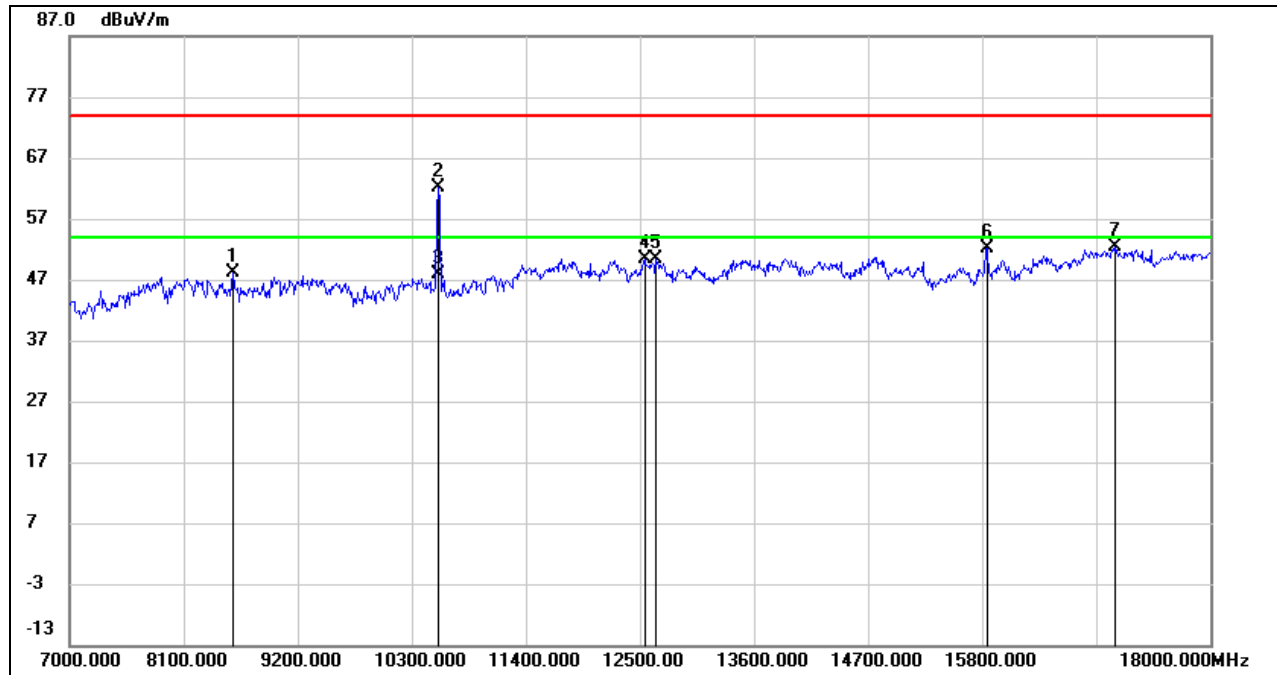

No.	Frequency (MHz)	Reading (dBuV)	Correct (dB/m)	Result (dBuV/m)	Limit (dBuV/m)	Margin (dB)	Remark
1	8573.000	38.99	9.16	48.15	74.00	-25.85	peak
2	10553.000	49.63	12.53	62.16	68.20	-6.04	peak
3	10553.000	35.32	12.53	47.85	/	/	AVG
4	12544.000	34.72	15.72	50.44	74.00	-23.56	peak
5	12654.000	34.80	15.69	50.49	74.00	-23.51	peak
6	15844.000	34.09	18.02	52.11	74.00	-21.89	peak
7	17087.000	30.54	21.81	52.35	74.00	-21.65	peak

- Note:
1. Measurement = Reading Level + Correct Factor.
 2. If Peak Result complies with AV limit, AV Result is deemed to comply with AV limit.
 3. Peak: Peak detector.
 4. AVG: VBW=1/Ton, where: Ton is the transmitting duration.
 5. For the transmitting duration, please refer to clause 7.1.
 6. Filter losses were only considered in the spurious frequency bands and the authorized band was not corrected for High Pass Filter losses.
 7. Proper operation of the transmitter prior to adding the filter to the measurement chain.
 8. Since non-restricted band peak emissions are less than the average limit, they also comply with the -27dBm/MHz (68.2dBuV/m) limit.



HARMONICS AND SPURIOUS EMISSIONS (MID CHANNEL, VERTICAL)

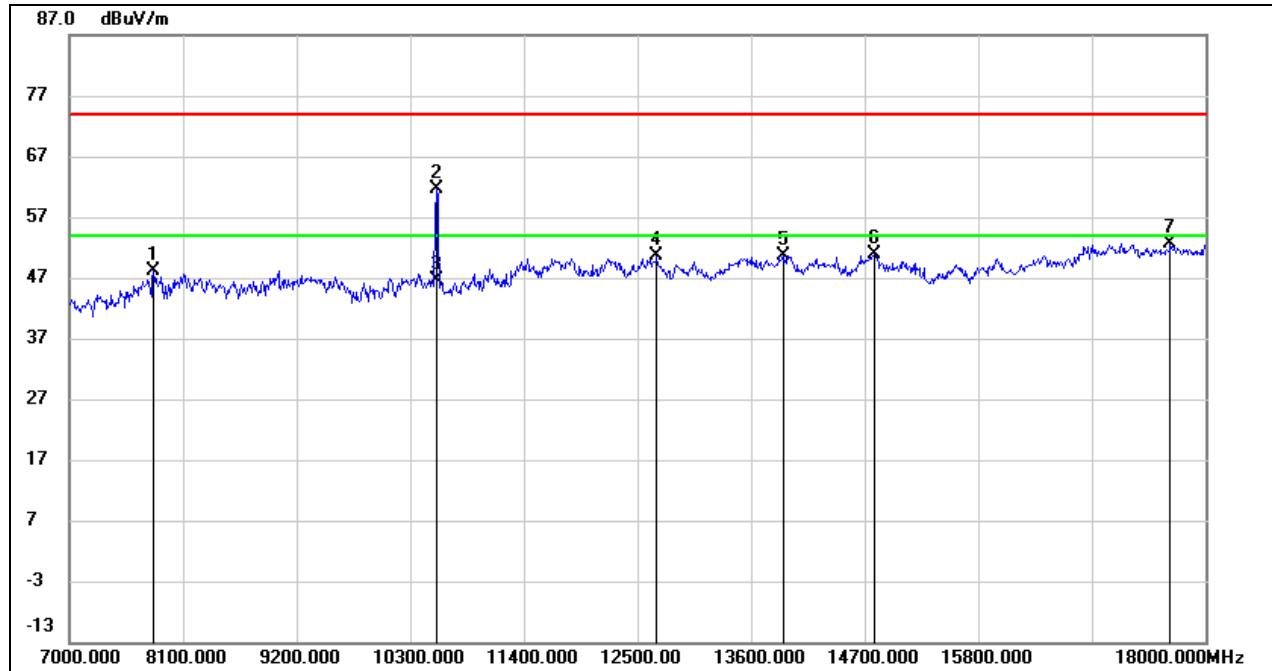

No.	Frequency (MHz)	Reading (dBuV)	Correct (dB/m)	Result (dBuV/m)	Limit (dBuV/m)	Margin (dB)	Remark
1	7814.000	38.86	9.28	48.14	74.00	-25.86	peak
2	10553.000	49.08	12.53	61.61	68.20	-6.59	peak
3	10553.000	34.10	12.53	46.63	/	/	AVG
4	12687.000	35.05	15.64	50.69	74.00	-23.31	peak
5	13908.000	33.17	17.54	50.71	74.00	-23.29	peak
6	14788.000	32.96	18.00	50.96	74.00	-23.04	peak
7	17659.000	29.56	23.17	52.73	74.00	-21.27	peak

- Note: 1. Measurement = Reading Level + Correct Factor.
 2. If Peak Result complies with AV limit, AV Result is deemed to comply with AV limit.
 3. Peak: Peak detector.
 4. AVG: $VBW=1/Ton$, where: Ton is the transmitting duration.
 5. For the transmitting duration, please refer to clause 7.1.
 6. Filter losses were only considered in the spurious frequency bands and the authorized band was not corrected for High Pass Filter losses.
 7. Proper operation of the transmitter prior to adding the filter to the measurement chain.
 8. Since non-restricted band peak emissions are less than the average limit, they also comply with the -27dBm/MHz (68.2dBuV/m) limit.

HARMONICS AND SPURIOUS EMISSIONS (HIGH CHANNEL, HORIZONTAL)

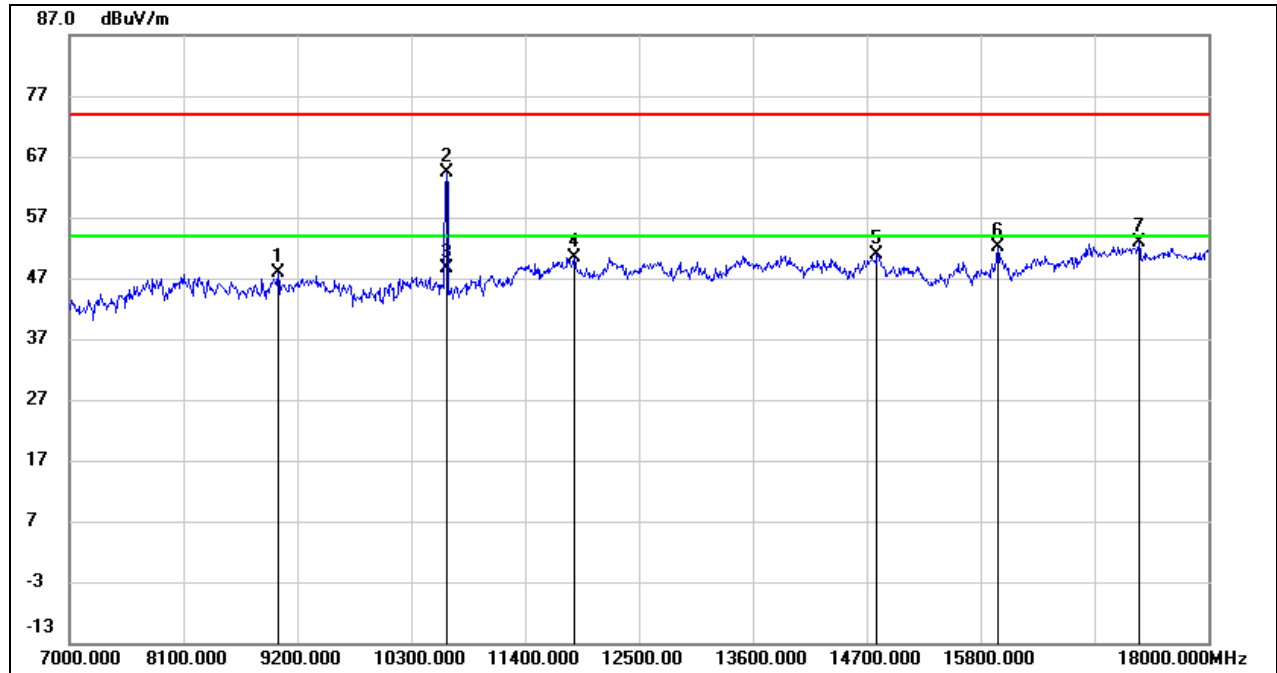

No.	Frequency (MHz)	Reading (dBuV)	Correct (dB/m)	Result (dBuV/m)	Limit (dBuV/m)	Margin (dB)	Remark
1	9013.000	36.81	11.12	47.93	74.00	-26.07	peak
2	10641.000	51.57	12.77	64.34	74.00	-9.66	peak
3	10641.000	35.82	12.77	48.59	54.00	-5.41	AVG
4	11873.000	35.05	15.44	50.49	74.00	-23.51	peak
5	14799.000	32.88	18.04	50.92	74.00	-23.08	peak
6	15965.000	33.76	18.29	52.05	74.00	-21.95	peak
7	17329.000	30.41	22.39	52.80	74.00	-21.20	peak

- Note: 1. Measurement = Reading Level + Correct Factor.
 2. If Peak Result complies with AV limit, AV Result is deemed to comply with AV limit.
 3. Peak: Peak detector.
 4. AVG: VBW=1/Ton, where: Ton is the transmitting duration.
 5. For the transmitting duration, please refer to clause 7.1.
 6. Filter losses were only considered in the spurious frequency bands and the authorized band was not corrected for High Pass Filter losses.
 7. Proper operation of the transmitter prior to adding the filter to the measurement chain.
 8. Since non-restricted band peak emissions are less than the average limit, they also comply with the -27dBm/MHz (68.2dBuV/m) limit.

HARMONICS AND SPURIOUS EMISSIONS (HIGH CHANNEL, VERTICAL)

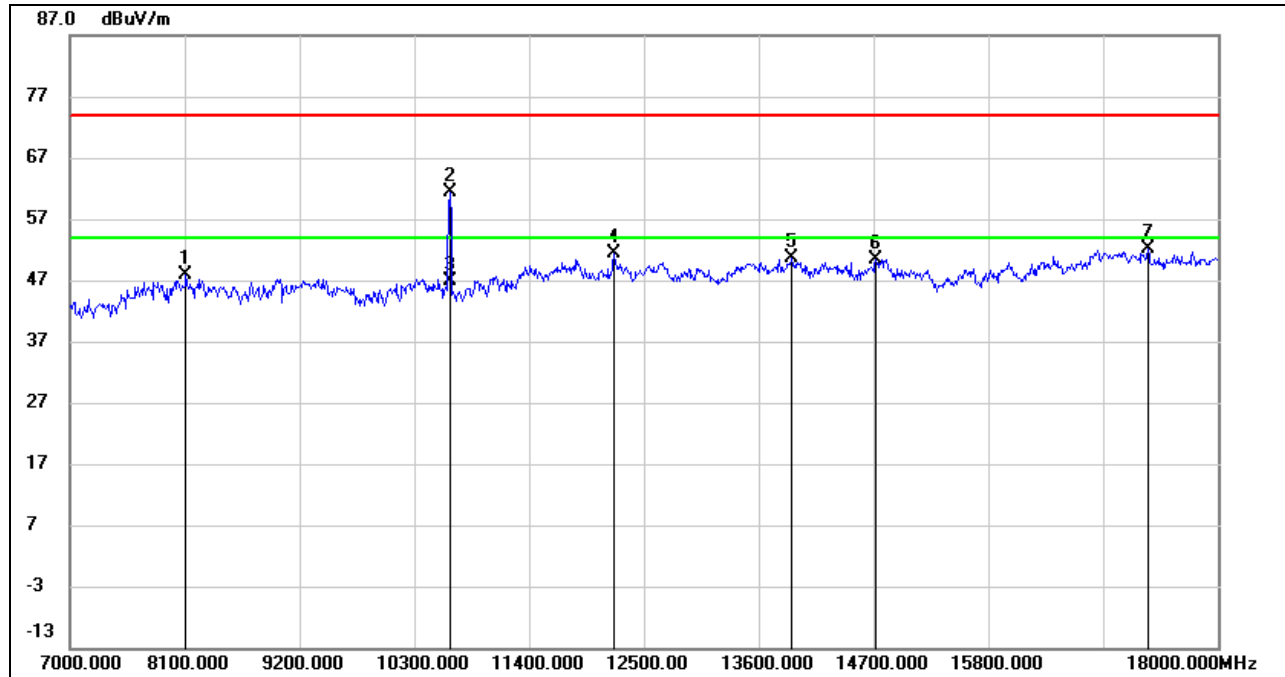

No.	Frequency (MHz)	Reading (dBuV)	Correct (dB/m)	Result (dBuV/m)	Limit (dBuV/m)	Margin (dB)	Remark
1	8111.000	37.80	10.14	47.94	74.00	-26.06	peak
2	10641.000	48.56	12.77	61.33	74.00	-12.67	peak
3	10641.000	34.10	12.77	46.87	54.00	-7.13	AVG
4	12214.000	35.52	15.97	51.49	74.00	-22.51	peak
5	13919.000	33.14	17.55	50.69	74.00	-23.31	peak
6	14722.000	32.71	17.77	50.48	74.00	-23.52	peak
7	17329.000	29.66	22.39	52.05	74.00	-21.95	peak

- Note:
1. Measurement = Reading Level + Correct Factor.
 2. If Peak Result complies with AV limit, AV Result is deemed to comply with AV limit.
 3. Peak: Peak detector.
 4. AVG: VBW=1/Ton, where: Ton is the transmitting duration.
 5. For the transmitting duration, please refer to clause 7.1.
 6. Filter losses were only considered in the spurious frequency bands and the authorized band was not corrected for High Pass Filter losses.
 7. Proper operation of the transmitter prior to adding the filter to the measurement chain.
 8. Since non-restricted band peak emissions are less than the average limit, they also comply with the -27dBm/MHz (68.2dBuV/m) limit.

UNII-2C BAND

HARMONICS AND SPURIOUS EMISSIONS (LOW CHANNEL, HORIZONTAL)

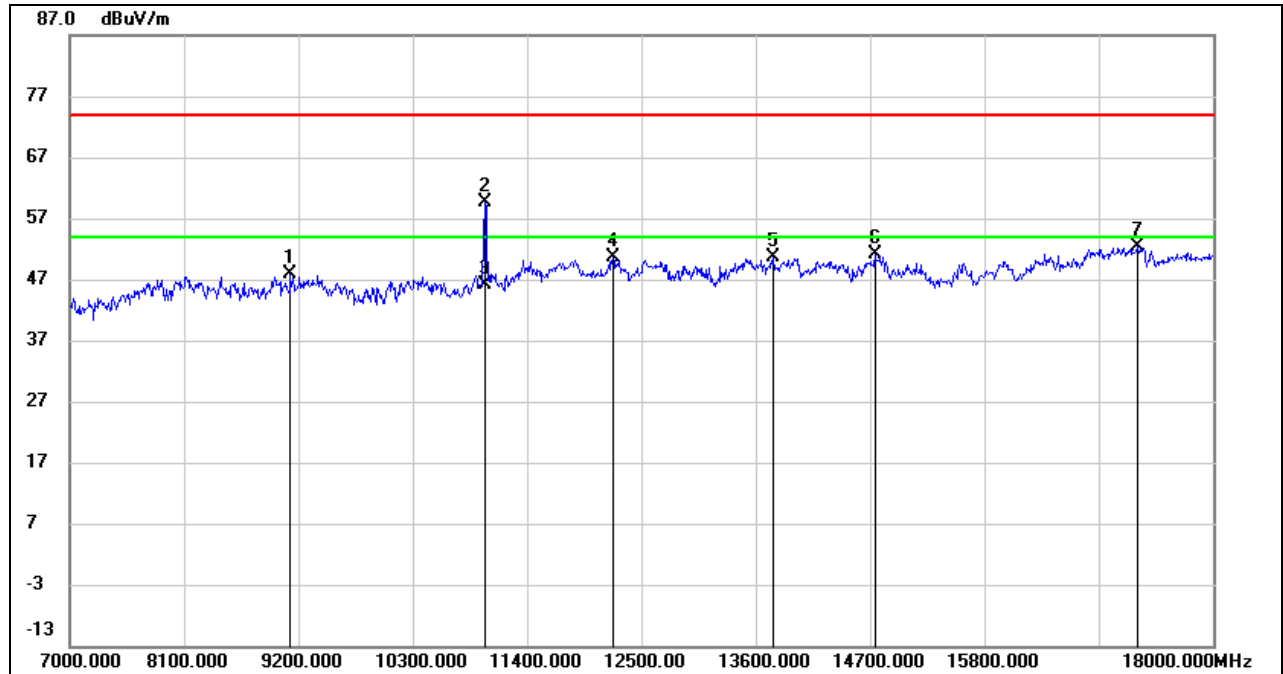

No.	Frequency (MHz)	Reading (dBuV)	Correct (dB/m)	Result (dBuV/m)	Limit (dBuV/m)	Margin (dB)	Remark
1	9123.000	37.67	10.09	47.76	74.00	-26.24	peak
2	10993.000	46.36	13.31	59.67	74.00	-14.33	peak
3	10993.000	32.70	13.31	46.01	54.00	-7.99	AVG
4	12225.000	34.55	15.99	50.54	74.00	-23.46	peak
5	13765.000	33.02	17.61	50.63	74.00	-23.37	peak
6	14744.000	33.22	17.84	51.06	74.00	-22.94	peak
7	17274.000	29.95	22.45	52.40	74.00	-21.60	peak

- Note:
1. Measurement = Reading Level + Correct Factor.
 2. If Peak Result complies with AV limit, AV Result is deemed to comply with AV limit.
 3. Peak: Peak detector.
 4. AVG: VBW=1/Ton, where: Ton is the transmitting duration.
 5. For the transmitting duration, please refer to clause 7.1.
 6. Filter losses were only considered in the spurious frequency bands and the authorized band was not corrected for High Pass Filter losses.
 7. Proper operation of the transmitter prior to adding the filter to the measurement chain.
 8. Since non-restricted band peak emissions are less than the average limit, they also comply with the -27dBm/MHz (68.2dBuV/m) limit.



HARMONICS AND SPURIOUS EMISSIONS (LOW CHANNEL, VERTICAL)

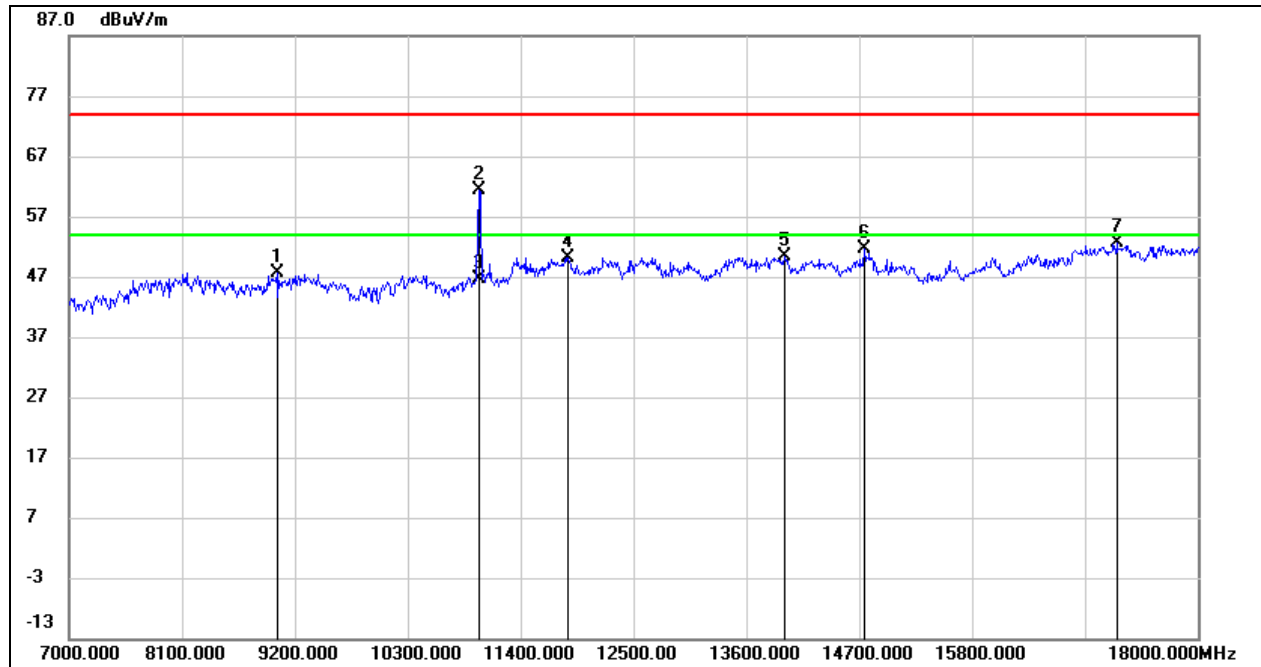

No.	Frequency (MHz)	Reading (dBuV)	Correct (dB/m)	Result (dBuV/m)	Limit (dBuV/m)	Margin (dB)	Remark
1	9024.000	36.65	11.01	47.66	74.00	-26.34	peak
2	10993.000	47.99	13.31	61.30	74.00	-12.70	peak
3	10993.000	33.30	13.31	46.61	54.00	-7.39	AVG
4	11862.000	34.77	15.41	50.18	74.00	-23.82	peak
5	13974.000	32.65	17.62	50.27	74.00	-23.73	peak
6	14755.000	33.70	17.88	51.58	74.00	-22.42	peak
7	17208.000	30.51	22.04	52.55	74.00	-21.45	peak

- Note: 1. Measurement = Reading Level + Correct Factor.
 2. If Peak Result complies with AV limit, AV Result is deemed to comply with AV limit.
 3. Peak: Peak detector.
 4. AVG: $VBW=1/Ton$, where: Ton is the transmitting duration.
 5. For the transmitting duration, please refer to clause 7.1.
 6. Filter losses were only considered in the spurious frequency bands and the authorized band was not corrected for High Pass Filter losses.
 7. Proper operation of the transmitter prior to adding the filter to the measurement chain.
 8. Since non-restricted band peak emissions are less than the average limit, they also comply with the -27dBm/MHz (68.2dBuV/m) limit.

HARMONICS AND SPURIOUS EMISSIONS (MID CHANNEL, HORIZONTAL)

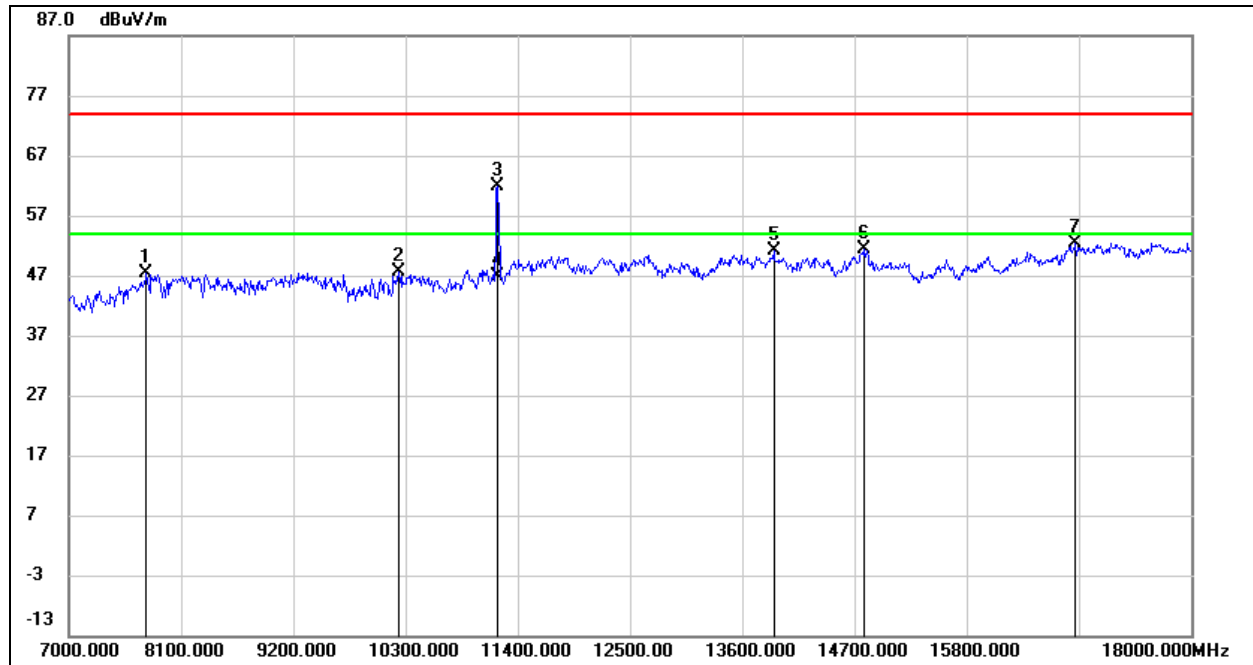

No.	Frequency (MHz)	Reading (dBuV)	Correct (dB/m)	Result (dBuV/m)	Limit (dBuV/m)	Margin (dB)	Remark
1	7759.000	38.41	8.98	47.39	74.00	-26.61	peak
2	10234.000	36.15	11.60	47.75	74.00	-26.25	peak
3	11202.000	48.18	13.79	61.97	74.00	-12.03	peak
4	11202.000	33.09	13.79	46.88	54.00	-7.12	AVG
5	13908.000	33.65	17.54	51.19	74.00	-22.81	peak
6	14788.000	33.45	18.00	51.45	74.00	-22.55	peak
7	16867.000	31.13	21.29	52.42	74.00	-21.58	peak

Note: 1. Measurement = Reading Level + Correct Factor.
 2. If Peak Result complies with AV limit, AV Result is deemed to comply with AV limit.
 3. Peak: Peak detector.
 4. AVG: $VBW=1/T_{on}$, where: T_{on} is the transmitting duration.
 5. For the transmitting duration, please refer to clause 7.1.
 6. Filter losses were only considered in the spurious frequency bands and the authorized band was not corrected for High Pass Filter losses.
 7. Proper operation of the transmitter prior to adding the filter to the measurement chain.
 8. Since non-restricted band peak emissions are less than the average limit, they also comply with the -27dBm/MHz (68.2dBuV/m) limit.

HARMONICS AND SPURIOUS EMISSIONS (MID CHANNEL, VERTICAL)

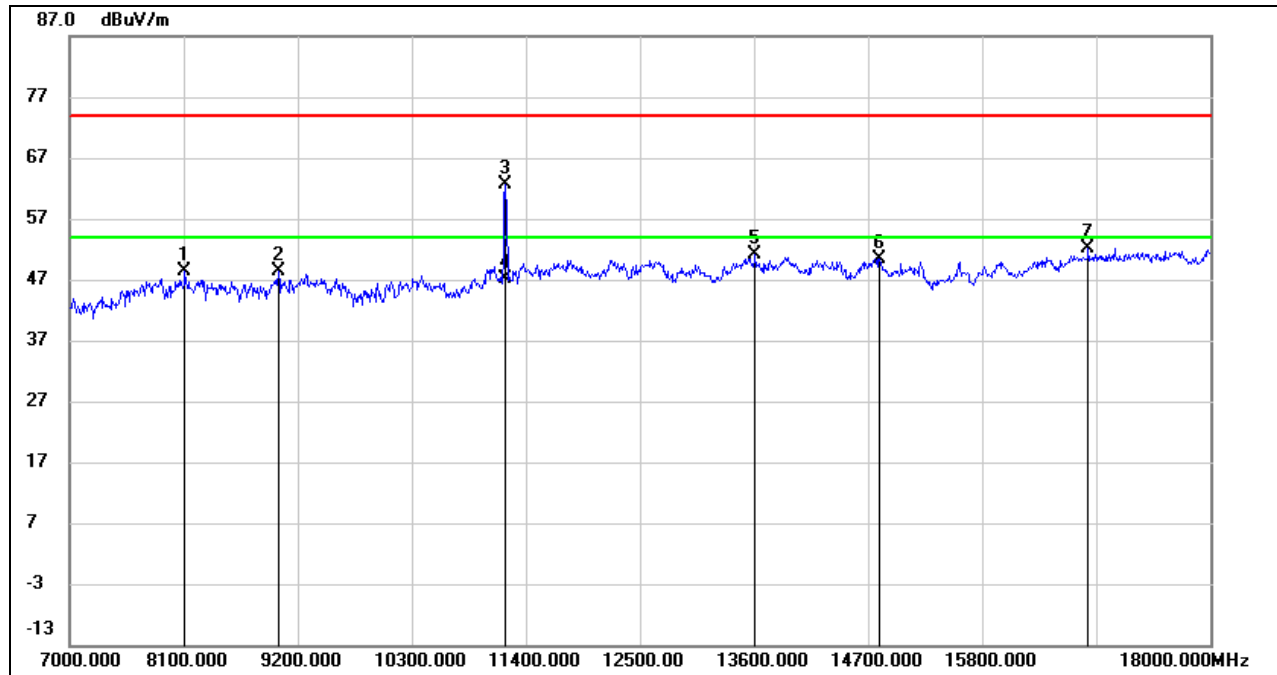

No.	Frequency (MHz)	Reading (dBuV)	Correct (dB/m)	Result (dBuV/m)	Limit (dBuV/m)	Margin (dB)	Remark
1	8111.000	38.36	10.14	48.50	74.00	-25.50	peak
2	9013.000	37.26	11.12	48.38	74.00	-25.62	peak
3	11202.000	48.87	13.79	62.66	74.00	-11.34	peak
4	11202.000	33.34	13.79	47.13	54.00	-6.87	AVG
5	13611.000	33.96	17.15	51.11	74.00	-22.89	peak
6	14810.000	32.51	17.97	50.48	74.00	-23.52	peak
7	16823.000	31.27	20.91	52.18	74.00	-21.82	peak

- Note:
1. Measurement = Reading Level + Correct Factor.
 2. If Peak Result complies with AV limit, AV Result is deemed to comply with AV limit.
 3. Peak: Peak detector.
 4. AVG: $VBW=1/Ton$, where: Ton is the transmitting duration.
 5. For the transmitting duration, please refer to clause 7.1.
 6. Filter losses were only considered in the spurious frequency bands and the authorized band was not corrected for High Pass Filter losses.
 7. Proper operation of the transmitter prior to adding the filter to the measurement chain.
 8. Since non-restricted band peak emissions are less than the average limit, they also comply with the -27dBm/MHz (68.2dBuV/m) limit.

HARMONICS AND SPURIOUS EMISSIONS (HIGH CHANNEL, HORIZONTAL)

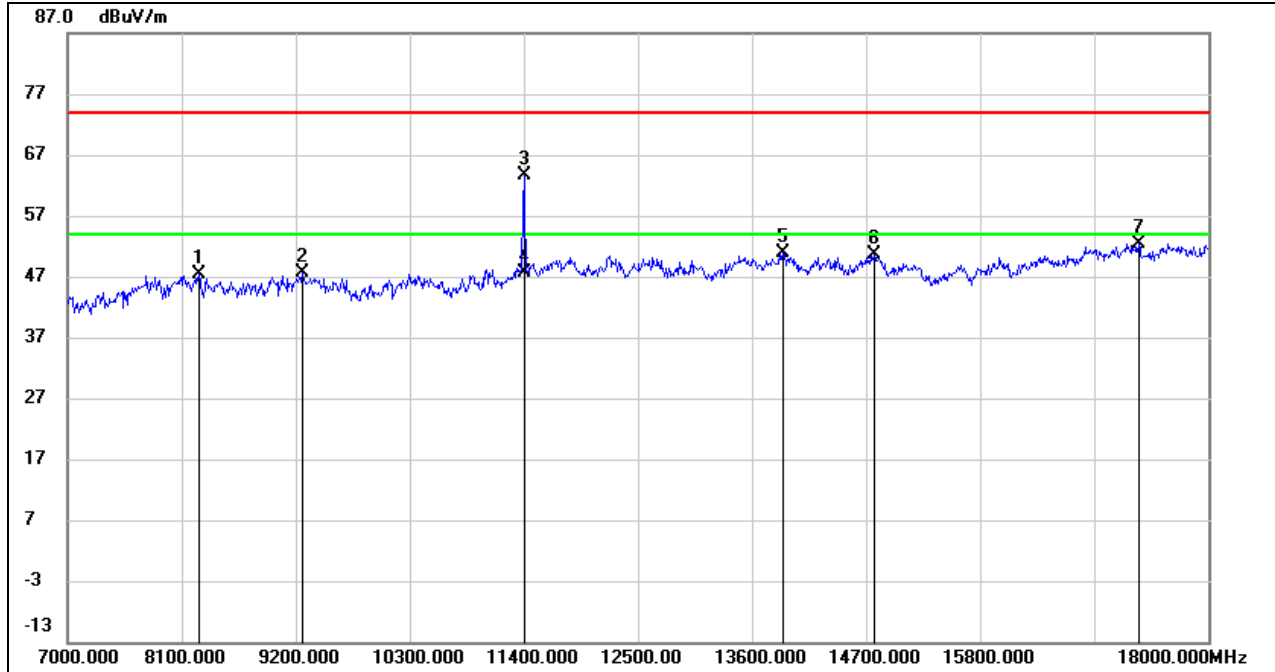

No.	Frequency (MHz)	Reading (dBuV)	Correct (dB/m)	Result (dBuV/m)	Limit (dBuV/m)	Margin (dB)	Remark
1	8265.000	37.75	9.73	47.48	74.00	-26.52	peak
2	9266.000	37.32	10.23	47.55	74.00	-26.45	peak
3	11400.000	48.84	14.76	63.60	74.00	-10.40	peak
4	11400.000	32.82	14.76	47.58	54.00	-6.42	AVG
5	13897.000	33.30	17.52	50.82	74.00	-23.18	peak
6	14777.000	32.56	17.96	50.52	74.00	-23.48	peak
7	17329.000	30.02	22.39	52.41	74.00	-21.59	peak

- Note: 1. Measurement = Reading Level + Correct Factor.
 2. If Peak Result complies with AV limit, AV Result is deemed to comply with AV limit.
 3. Peak: Peak detector.
 4. AVG: $VBW=1/Ton$, where: Ton is the transmitting duration.
 5. For the transmitting duration, please refer to clause 7.1.
 6. Filter losses were only considered in the spurious frequency bands and the authorized band was not corrected for High Pass Filter losses.
 7. Proper operation of the transmitter prior to adding the filter to the measurement chain.
 8. Since non-restricted band peak emissions are less than the average limit, they also comply with the -27dBm/MHz (68.2dBuV/m) limit.

HARMONICS AND SPURIOUS EMISSIONS (HIGH CHANNEL, VERTICAL)

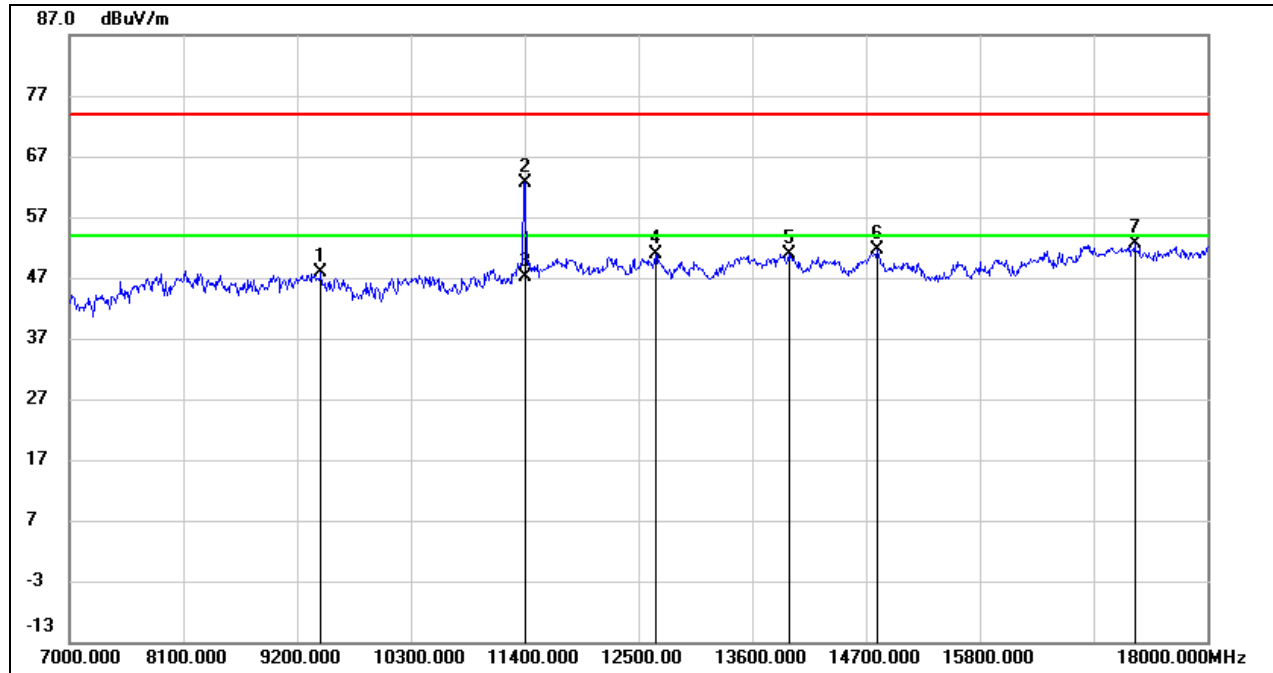

No.	Frequency (MHz)	Reading (dBuV)	Correct (dB/m)	Result (dBuV/m)	Limit (dBuV/m)	Margin (dB)	Remark
1	9431.000	37.09	10.83	47.92	74.00	-26.08	peak
2	11400.000	47.84	14.76	62.60	74.00	-11.40	peak
3	11400.000	32.49	14.76	47.25	54.00	-6.75	AVG
4	12665.000	35.28	15.68	50.96	74.00	-23.04	peak
5	13952.000	33.35	17.60	50.95	74.00	-23.05	peak
6	14810.000	33.59	17.97	51.56	74.00	-22.44	peak
7	17296.000	29.98	22.59	52.57	74.00	-21.43	peak

- Note: 1. Measurement = Reading Level + Correct Factor.
 2. If Peak Result complies with AV limit, AV Result is deemed to comply with AV limit.
 3. Peak: Peak detector.
 4. AVG: $VBW=1/T_{on}$, where: T_{on} is the transmitting duration.
 5. For the transmitting duration, please refer to clause 7.1.
 6. Filter losses were only considered in the spurious frequency bands and the authorized band was not corrected for High Pass Filter losses.
 7. Proper operation of the transmitter prior to adding the filter to the measurement chain.
 8. Since non-restricted band peak emissions are less than the average limit, they also comply with the -27dBm/MHz (68.2dBuV/m) limit.

UNII-3 BAND

HARMONICS AND SPURIOUS EMISSIONS (LOW CHANNEL, HORIZONTAL)

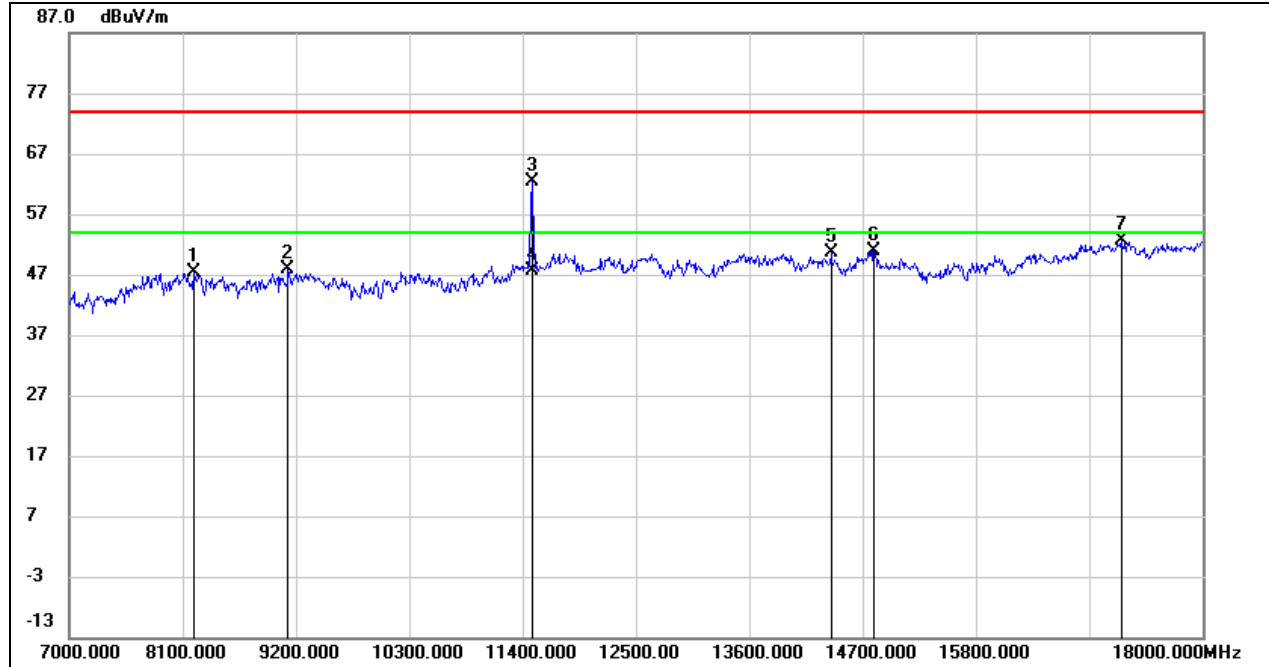

No.	Frequency (MHz)	Reading (dBuV)	Correct (dB/m)	Result (dBuV/m)	Limit (dBuV/m)	Margin (dB)	Remark
1	8210.000	37.56	9.80	47.36	74.00	-26.64	peak
2	9123.000	37.71	10.09	47.80	74.00	-26.20	peak
3	11488.000	47.66	14.66	62.32	74.00	-11.68	peak
4	11488.000	33.05	14.66	47.71	54.00	-6.29	AVG
5	14392.000	33.11	17.44	50.55	74.00	-23.45	peak
6	14810.000	33.03	17.97	51.00	74.00	-23.00	peak
7	17208.000	30.59	22.04	52.63	74.00	-21.37	peak

- Note: 1. Measurement = Reading Level + Correct Factor.
 2. If Peak Result complies with AV limit, AV Result is deemed to comply with AV limit.
 3. Peak: Peak detector.
 4. AVG: $VBW=1/Ton$, where: Ton is the transmitting duration.
 5. For the transmitting duration, please refer to clause 7.1.
 6. Filter losses were only considered in the spurious frequency bands and the authorized band was not corrected for High Pass Filter losses.
 7. Proper operation of the transmitter prior to adding the filter to the measurement chain.
 8. Since non-restricted band peak emissions are less than the average limit, they also comply with the -27dBm/MHz (68.2dBuV/m) limit.



HARMONICS AND SPURIOUS EMISSIONS (LOW CHANNEL, VERTICAL)

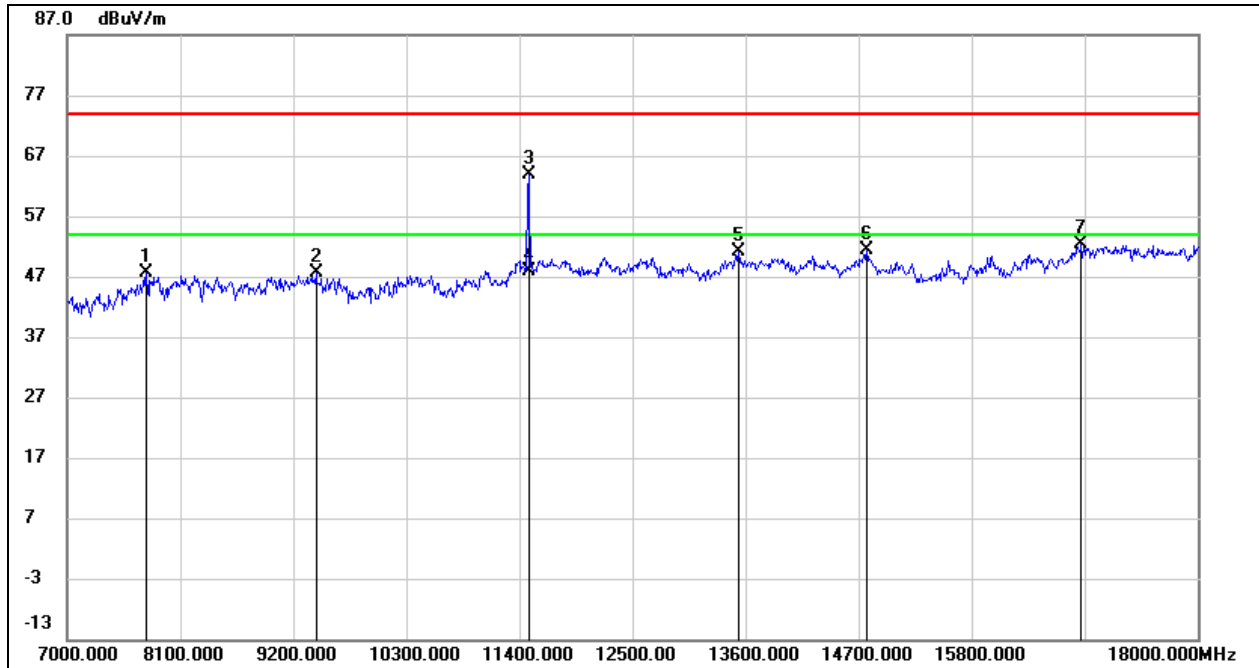

No.	Frequency (MHz)	Reading (dBuV)	Correct (dB/m)	Result (dBuV/m)	Limit (dBuV/m)	Margin (dB)	Remark
1	7770.000	38.47	9.09	47.56	74.00	-26.44	peak
2	9420.000	36.73	10.88	47.61	74.00	-26.39	peak
3	11488.000	49.32	14.66	63.98	74.00	-10.02	peak
4	11488.000	33.12	14.66	47.78	54.00	-6.22	AVG
5	13534.000	33.89	17.18	51.07	74.00	-22.93	peak
6	14777.000	33.42	17.96	51.38	74.00	-22.62	peak
7	16867.000	31.04	21.29	52.33	74.00	-21.67	peak

- Note:
1. Measurement = Reading Level + Correct Factor.
 2. If Peak Result complies with AV limit, AV Result is deemed to comply with AV limit.
 3. Peak: Peak detector.
 4. AVG: $VBW=1/Ton$, where: Ton is the transmitting duration.
 5. For the transmitting duration, please refer to clause 7.1.
 6. Filter losses were only considered in the spurious frequency bands and the authorized band was not corrected for High Pass Filter losses.
 7. Proper operation of the transmitter prior to adding the filter to the measurement chain.
 8. Since non-restricted band peak emissions are less than the average limit, they also comply with the -27dBm/MHz (68.2dBuV/m) limit.

HARMONICS AND SPURIOUS EMISSIONS (MID CHANNEL, HORIZONTAL)

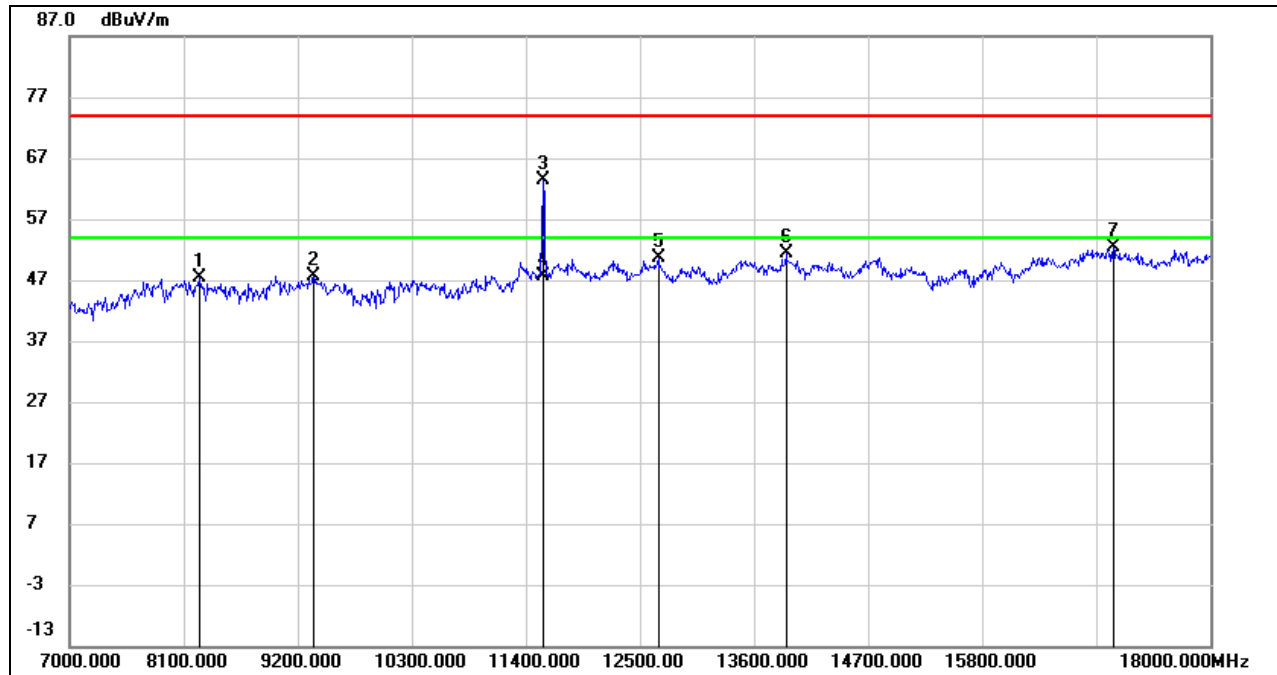

No.	Frequency (MHz)	Reading (dBuV)	Correct (dB/m)	Result (dBuV/m)	Limit (dBuV/m)	Margin (dB)	Remark
1	8254.000	37.61	9.75	47.36	74.00	-26.64	peak
2	9354.000	36.99	10.70	47.69	74.00	-26.31	peak
3	11565.000	48.60	14.69	63.29	74.00	-10.71	peak
4	11565.000	32.98	14.69	47.67	54.00	-6.33	AVG
5	12676.000	34.89	15.66	50.55	74.00	-23.45	peak
6	13908.000	33.88	17.54	51.42	74.00	-22.58	peak
7	17065.000	30.79	21.67	52.46	74.00	-21.54	peak

- Note:
1. Measurement = Reading Level + Correct Factor.
 2. If Peak Result complies with AV limit, AV Result is deemed to comply with AV limit.
 3. Peak: Peak detector.
 4. AVG: VBW=1/Ton, where: Ton is the transmitting duration.
 5. For the transmitting duration, please refer to clause 7.1.
 6. Filter losses were only considered in the spurious frequency bands and the authorized band was not corrected for High Pass Filter losses.
 7. Proper operation of the transmitter prior to adding the filter to the measurement chain.
 8. Since non-restricted band peak emissions are less than the average limit, they also comply with the -27dBm/MHz (68.2dBuV/m) limit.

HARMONICS AND SPURIOUS EMISSIONS (MID CHANNEL, VERTICAL)

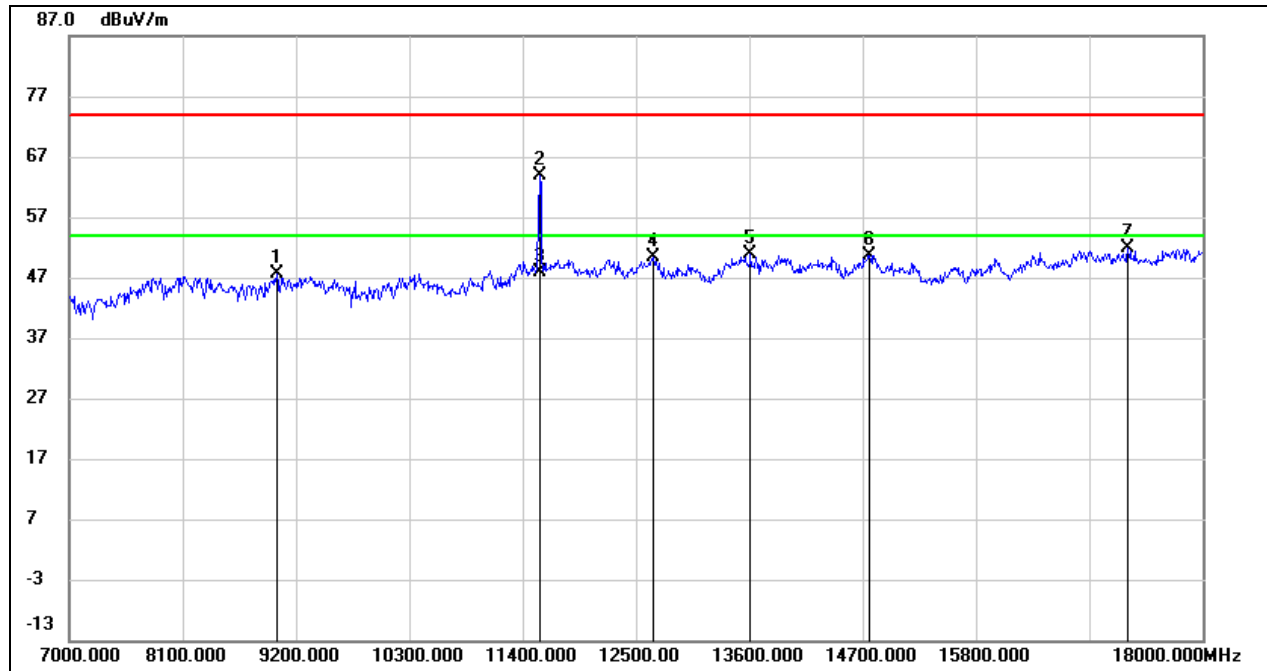

No.	Frequency (MHz)	Reading (dBuV)	Correct (dB/m)	Result (dBuV/m)	Limit (dBuV/m)	Margin (dB)	Remark
1	9013.000	36.51	11.12	47.63	74.00	-26.37	peak
2	11565.000	49.30	14.69	63.99	74.00	-10.01	peak
3	11565.000	33.16	14.69	47.85	54.00	-6.15	AVG
4	12665.000	34.75	15.68	50.43	74.00	-23.57	peak
5	13611.000	33.70	17.15	50.85	74.00	-23.15	peak
6	14766.000	32.79	17.92	50.71	74.00	-23.29	peak
7	17274.000	29.39	22.45	51.84	74.00	-22.16	peak

- Note: 1. Measurement = Reading Level + Correct Factor.
 2. If Peak Result complies with AV limit, AV Result is deemed to comply with AV limit.
 3. Peak: Peak detector.
 4. AVG: $VBW=1/Ton$, where: Ton is the transmitting duration.
 5. For the transmitting duration, please refer to clause 7.1.
 6. Filter losses were only considered in the spurious frequency bands and the authorized band was not corrected for High Pass Filter losses.
 7. Proper operation of the transmitter prior to adding the filter to the measurement chain.
 8. Since non-restricted band peak emissions are less than the average limit, they also comply with the -27dBm/MHz (68.2dBuV/m) limit.

HARMONICS AND SPURIOUS EMISSIONS (HIGH CHANNEL, HORIZONTAL)

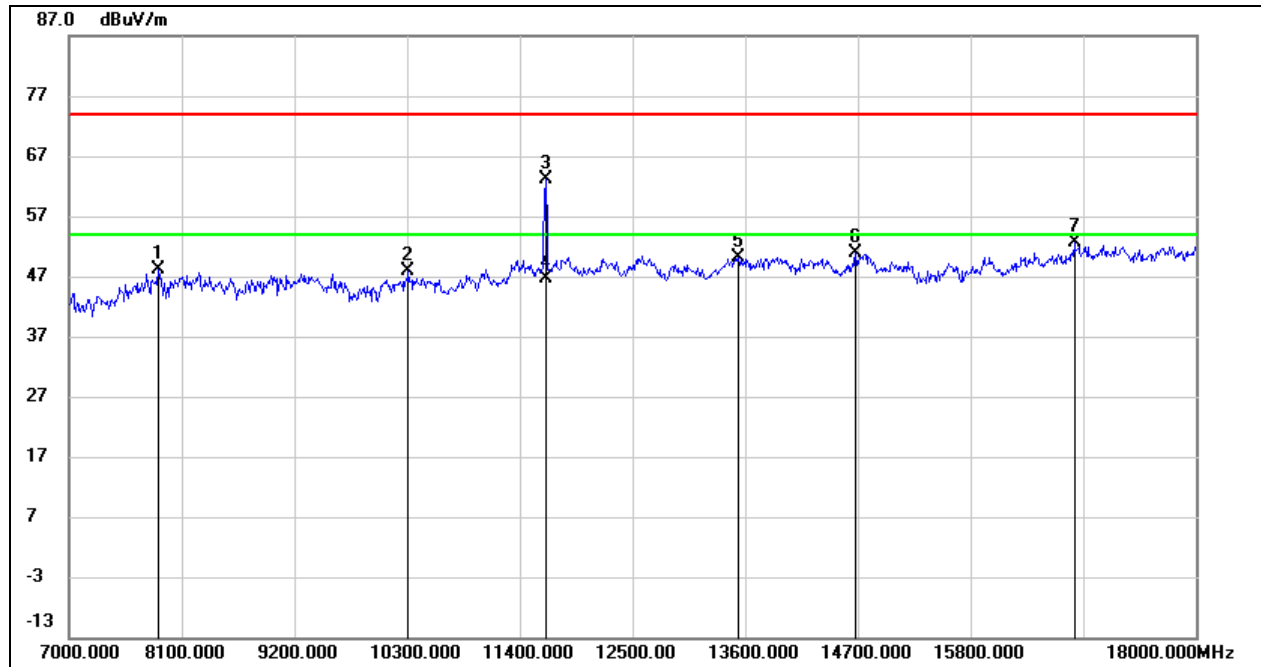

No.	Frequency (MHz)	Reading (dBuV)	Correct (dB/m)	Result (dBuV/m)	Limit (dBuV/m)	Margin (dB)	Remark
1	7869.000	39.01	9.02	48.03	74.00	-25.97	peak
2	10311.000	36.14	11.86	48.00	74.00	-26.00	peak
3	11653.000	48.11	15.05	63.16	74.00	-10.84	peak
4	11653.000	31.63	15.05	46.68	54.00	-7.32	AVG
5	13534.000	33.03	17.18	50.21	74.00	-23.79	peak
6	14678.000	33.23	17.62	50.85	74.00	-23.15	peak
7	16812.000	31.79	20.81	52.60	74.00	-21.40	peak

- Note: 1. Measurement = Reading Level + Correct Factor.
 2. If Peak Result complies with AV limit, AV Result is deemed to comply with AV limit.
 3. Peak: Peak detector.
 4. AVG: $VBW=1/Ton$, where: Ton is the transmitting duration.
 5. For the transmitting duration, please refer to clause 7.1.
 6. Filter losses were only considered in the spurious frequency bands and the authorized band was not corrected for High Pass Filter losses.
 7. Proper operation of the transmitter prior to adding the filter to the measurement chain.
 8. Since non-restricted band peak emissions are less than the average limit, they also comply with the -27dBm/MHz (68.2dBuV/m) limit.

HARMONICS AND SPURIOUS EMISSIONS (HIGH CHANNEL, VERTICAL)

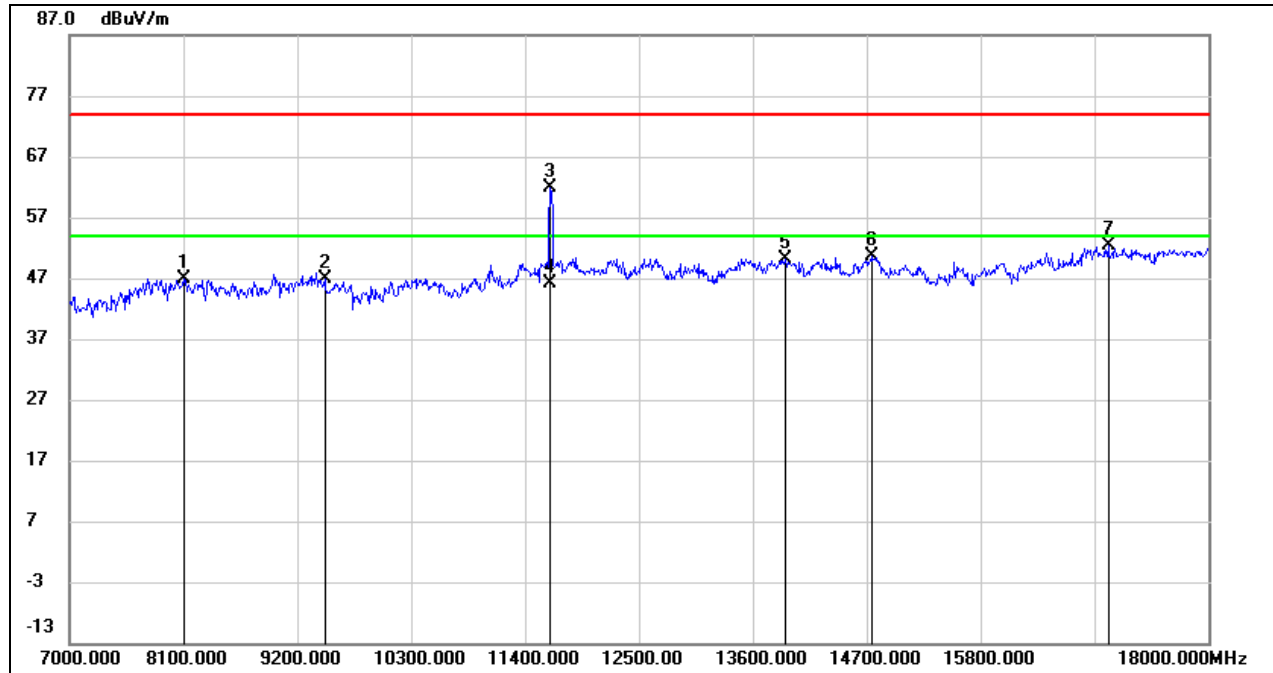

No.	Frequency (MHz)	Reading (dBuV)	Correct (dB/m)	Result (dBuV/m)	Limit (dBuV/m)	Margin (dB)	Remark
1	8100.000	36.71	10.18	46.89	74.00	-27.11	peak
2	9464.000	36.27	10.68	46.95	74.00	-27.05	peak
3	11642.000	46.81	14.98	61.79	74.00	-12.21	peak
4	11642.000	31.18	14.98	46.16	54.00	-7.84	AVG
5	13919.000	32.66	17.55	50.21	74.00	-23.79	peak
6	14755.000	32.64	17.88	50.52	74.00	-23.48	peak
7	17032.000	30.88	21.46	52.34	74.00	-21.66	peak

- Note: 1. Measurement = Reading Level + Correct Factor.
 2. If Peak Result complies with AV limit, AV Result is deemed to comply with AV limit.
 3. Peak: Peak detector.
 4. AVG: $VBW=1/T_{on}$, where: T_{on} is the transmitting duration.
 5. For the transmitting duration, please refer to clause 7.1.
 6. Filter losses were only considered in the spurious frequency bands and the authorized band was not corrected for High Pass Filter losses.
 7. Proper operation of the transmitter prior to adding the filter to the measurement chain.
 8. Since non-restricted band peak emissions are less than the average limit, they also comply with the -27dBm/MHz (68.2dBuV/m) limit.

8.3.3. 802.11n HT40 MIMO MODE

UNII-1 BAND

HARMONICS AND SPURIOUS EMISSIONS (LOW CHANNEL, HORIZONTAL)

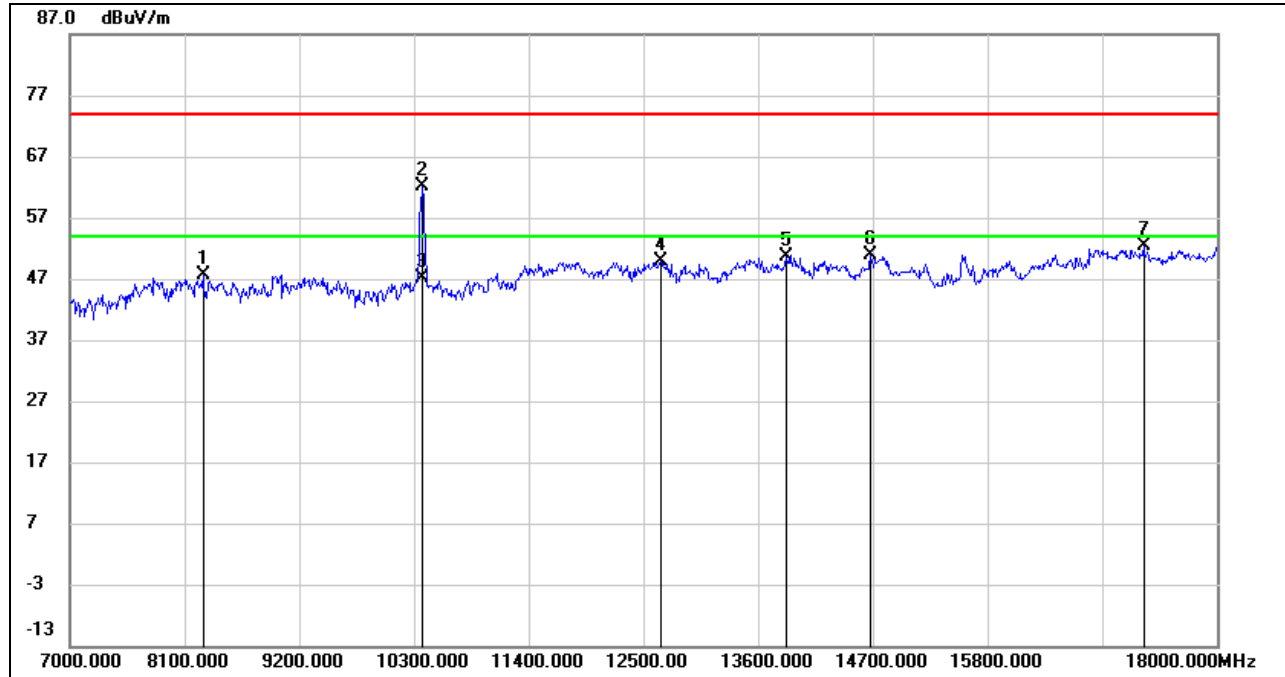

No.	Frequency (MHz)	Reading (dBuV)	Correct (dB/m)	Result (dBuV/m)	Limit (dBuV/m)	Margin (dB)	Remark
1	8276.000	37.83	9.71	47.54	74.00	-26.46	peak
2	10377.000	49.89	12.13	62.02	68.20	-6.18	peak
3	10377.000	34.92	12.13	47.05	/	/	AVG
4	12665.000	34.30	15.68	49.98	74.00	-24.02	peak
5	13864.000	33.03	17.55	50.58	74.00	-23.42	peak
6	14678.000	33.23	17.62	50.85	74.00	-23.15	peak
7	17296.000	29.72	22.59	52.31	74.00	-21.69	peak

- Note: 1. Measurement = Reading Level + Correct Factor.
 2. If Peak Result complies with AV limit, AV Result is deemed to comply with AV limit.
 3. Peak: Peak detector.
 4. AVG: $VBW=1/Ton$, where: Ton is the transmitting duration.
 5. For the transmitting duration, please refer to clause 7.1.
 6. Filter losses were only considered in the spurious frequency bands and the authorized band was not corrected for High Pass Filter losses.
 7. Proper operation of the transmitter prior to adding the filter to the measurement chain.
 8. Since non-restricted band peak emissions are less than the average limit, they also comply with the -27dBm/MHz (68.2dBuV/m) limit.

HARMONICS AND SPURIOUS EMISSIONS (LOW CHANNEL, VERTICAL)

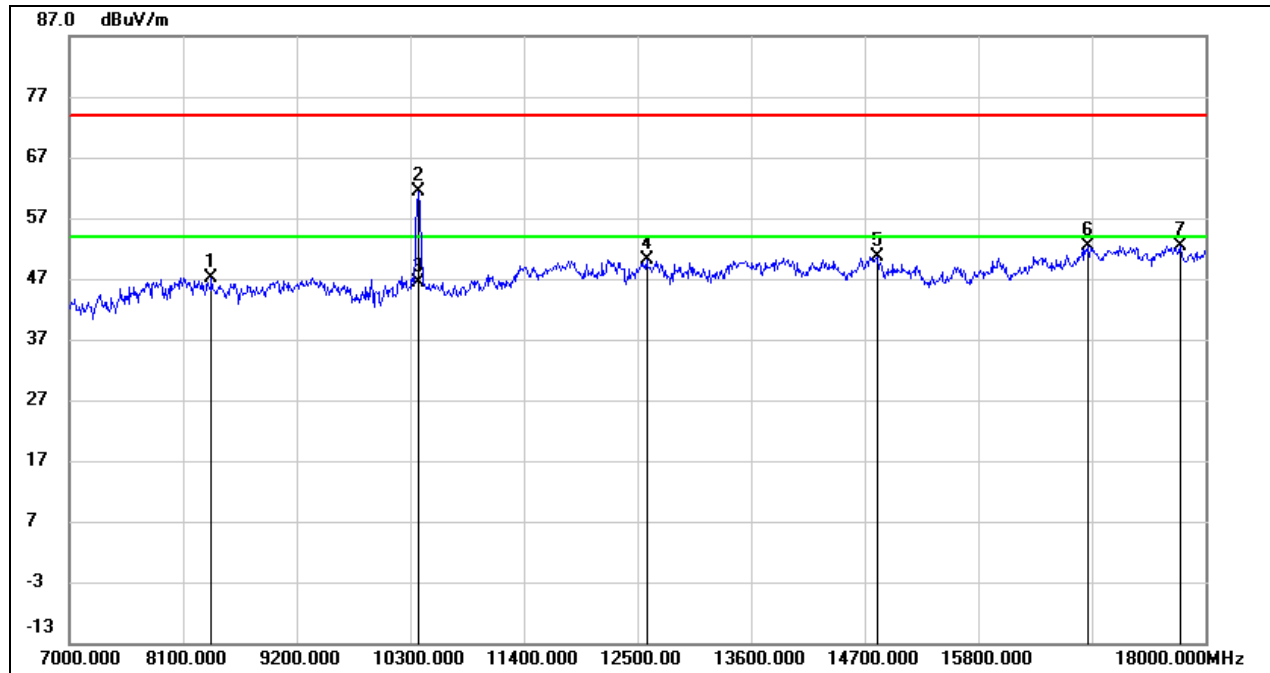

No.	Frequency (MHz)	Reading (dBuV)	Correct (dB/m)	Result (dBuV/m)	Limit (dBuV/m)	Margin (dB)	Remark
1	8375.000	37.63	9.42	47.05	74.00	-26.95	peak
2	10377.000	49.25	12.13	61.38	68.20	-6.82	peak
3	10377.000	34.23	12.13	46.36	/	/	AVG
4	12588.000	34.48	15.76	50.24	74.00	-23.76	peak
5	14821.000	32.80	17.90	50.70	74.00	-23.30	peak
6	16856.000	31.19	21.19	52.38	74.00	-21.62	peak
7	17758.000	28.57	23.81	52.38	74.00	-21.62	peak

- Note:
1. Measurement = Reading Level + Correct Factor.
 2. If Peak Result complies with AV limit, AV Result is deemed to comply with AV limit.
 3. Peak: Peak detector.
 4. AVG: $VBW=1/Ton$, where: Ton is the transmitting duration.
 5. For the transmitting duration, please refer to clause 7.1.
 6. Filter losses were only considered in the spurious frequency bands and the authorized band was not corrected for High Pass Filter losses.
 7. Proper operation of the transmitter prior to adding the filter to the measurement chain.
 8. Since non-restricted band peak emissions are less than the average limit, they also comply with the -27dBm/MHz (68.2dBuV/m) limit.

HARMONICS AND SPURIOUS EMISSIONS (HIGH CHANNEL, HORIZONTAL)

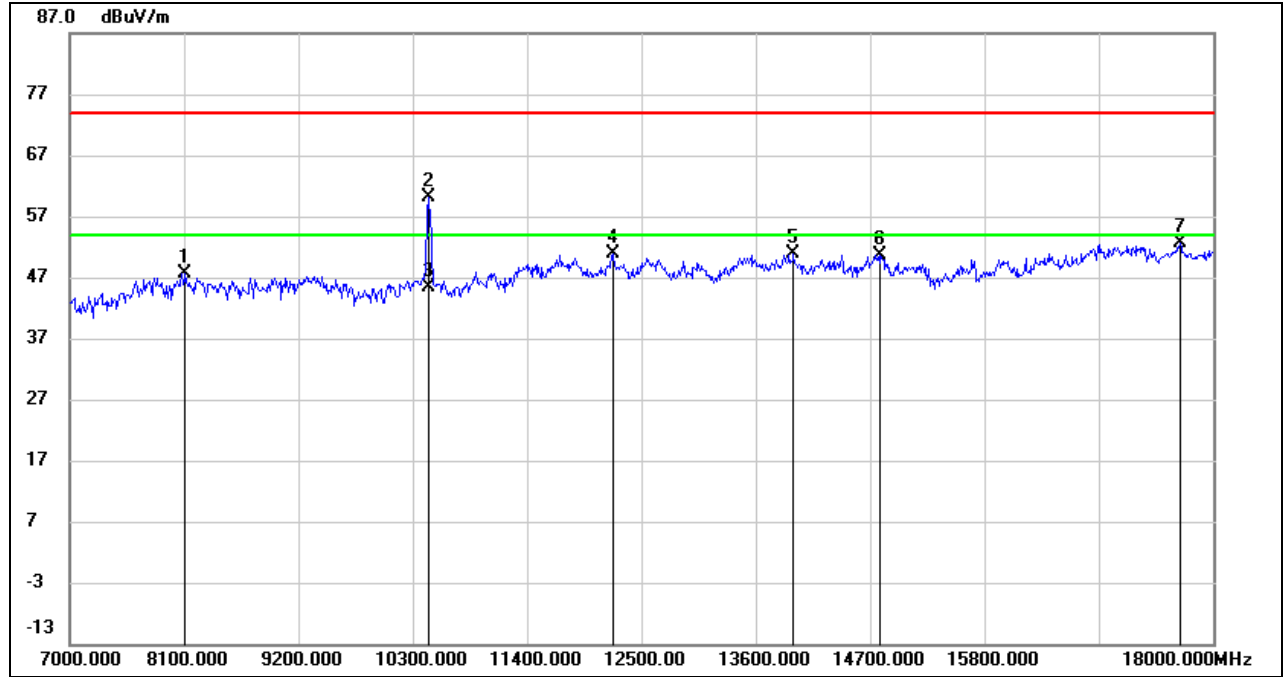

No.	Frequency (MHz)	Reading (dBuV)	Correct (dB/m)	Result (dBuV/m)	Limit (dBuV/m)	Margin (dB)	Remark
1	8111.000	37.46	10.14	47.60	74.00	-26.40	peak
2	10454.000	47.81	12.31	60.12	68.20	-8.08	peak
3	10454.000	32.97	12.31	45.28	/	/	AVG
4	12225.000	34.92	15.99	50.91	74.00	-23.09	peak
5	13963.000	33.22	17.61	50.83	74.00	-23.17	peak
6	14799.000	32.69	18.04	50.73	74.00	-23.27	peak
7	17681.000	29.19	23.33	52.52	74.00	-21.48	peak

- Note:
1. Measurement = Reading Level + Correct Factor.
 2. If Peak Result complies with AV limit, AV Result is deemed to comply with AV limit.
 3. Peak: Peak detector.
 4. AVG: VBW=1/Ton, where: Ton is the transmitting duration.
 5. For the transmitting duration, please refer to clause 7.1.
 6. Filter losses were only considered in the spurious frequency bands and the authorized band was not corrected for High Pass Filter losses.
 7. Proper operation of the transmitter prior to adding the filter to the measurement chain.
 8. Since non-restricted band peak emissions are less than the average limit, they also comply with the -27dBm/MHz (68.2dBuV/m) limit.

HARMONICS AND SPURIOUS EMISSIONS (HIGH CHANNEL, VERTICAL)

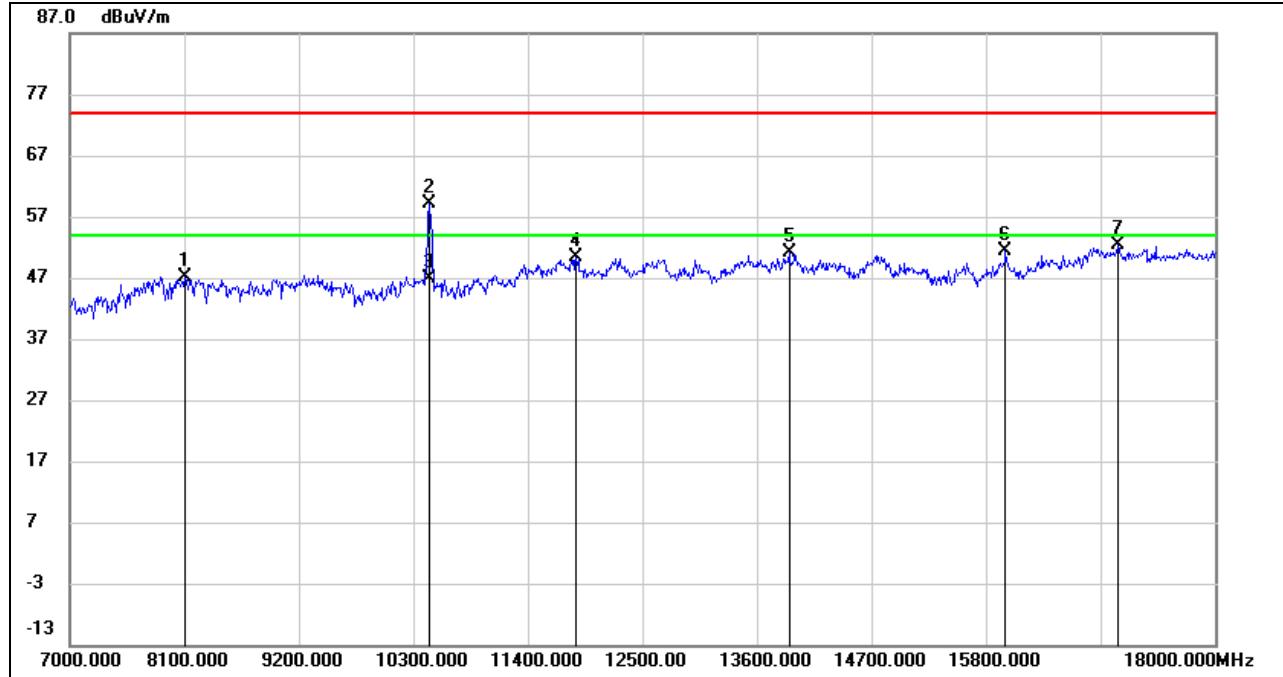

No.	Frequency (MHz)	Reading (dBuV)	Correct (dB/m)	Result (dBuV/m)	Limit (dBuV/m)	Margin (dB)	Remark
1	8100.000	36.99	10.18	47.17	74.00	-26.83	peak
2	10454.000	46.83	12.31	59.14	68.20	-9.06	peak
3	10454.000	34.58	12.31	46.89	/	/	AVG
4	11862.000	34.92	15.41	50.33	74.00	-23.67	peak
5	13908.000	33.54	17.54	51.08	74.00	-22.92	peak
6	15987.000	33.06	18.37	51.43	74.00	-22.57	peak
7	17065.000	30.71	21.67	52.38	74.00	-21.62	peak

- Note: 1. Measurement = Reading Level + Correct Factor.
 2. If Peak Result complies with AV limit, AV Result is deemed to comply with AV limit.
 3. Peak: Peak detector.
 4. AVG: $VBW=1/Ton$, where: Ton is the transmitting duration.
 5. For the transmitting duration, please refer to clause 7.1.
 6. Filter losses were only considered in the spurious frequency bands and the authorized band was not corrected for High Pass Filter losses.
 7. Proper operation of the transmitter prior to adding the filter to the measurement chain.
 8. Since non-restricted band peak emissions are less than the average limit, they also comply with the -27dBm/MHz (68.2dBuV/m) limit.

UNII-2A BAND

HARMONICS AND SPURIOUS EMISSIONS (LOW CHANNEL, HORIZONTAL)

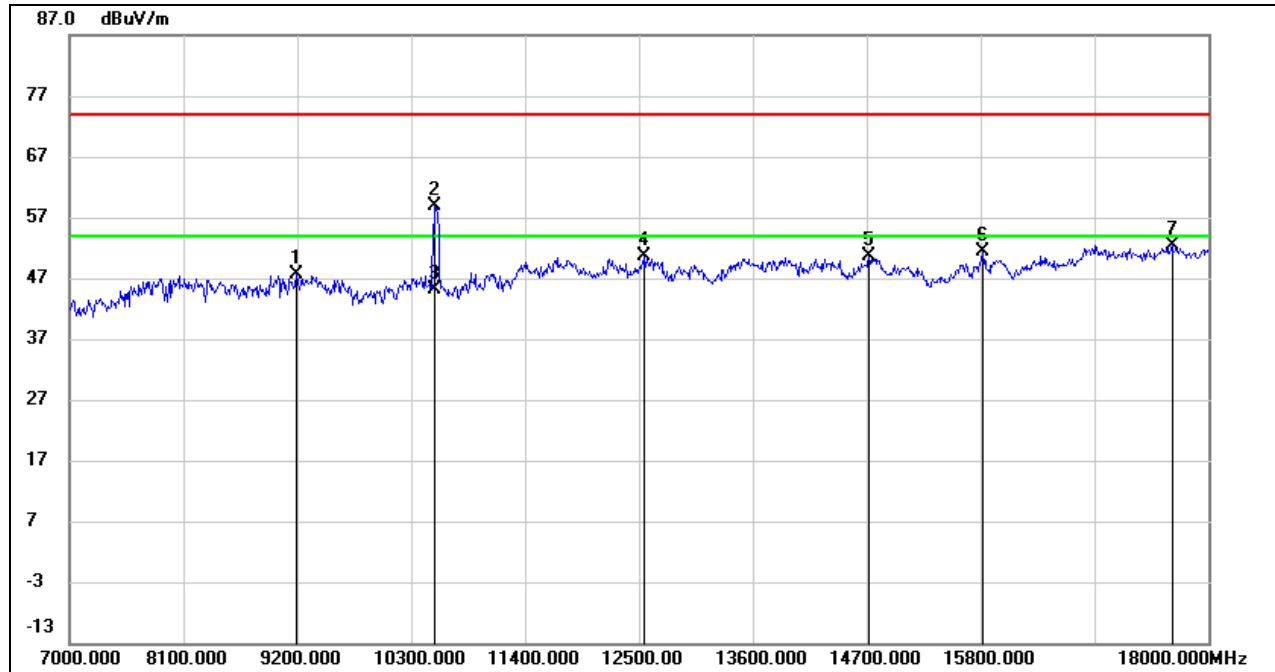

No.	Frequency (MHz)	Reading (dBuV)	Correct (dB/m)	Result (dBuV/m)	Limit (dBuV/m)	Margin (dB)	Remark
1	9189.000	37.78	9.93	47.71	74.00	-26.29	peak
2	10531.000	46.33	12.47	58.8	68.20	-9.40	peak
3	10531.000	32.56	12.47	45.03	/	/	AVG
4	12555.000	34.78	15.73	50.51	74.00	-23.49	peak
5	14722.000	32.93	17.77	50.70	74.00	-23.30	peak
6	15822.000	33.42	18.00	51.42	74.00	-22.58	peak
7	17648.000	29.42	23.08	52.50	74.00	-21.50	peak

- Note: 1. Measurement = Reading Level + Correct Factor.
 2. If Peak Result complies with AV limit, AV Result is deemed to comply with AV limit.
 3. Peak: Peak detector.
 4. AVG: $VBW=1/Ton$, where: Ton is the transmitting duration.
 5. For the transmitting duration, please refer to clause 7.1.
 6. Filter losses were only considered in the spurious frequency bands and the authorized band was not corrected for High Pass Filter losses.
 7. Proper operation of the transmitter prior to adding the filter to the measurement chain.
 8. Since non-restricted band peak emissions are less than the average limit, they also comply with the -27dBm/MHz (68.2dBuV/m) limit.



HARMONICS AND SPURIOUS EMISSIONS (LOW CHANNEL, VERTICAL)

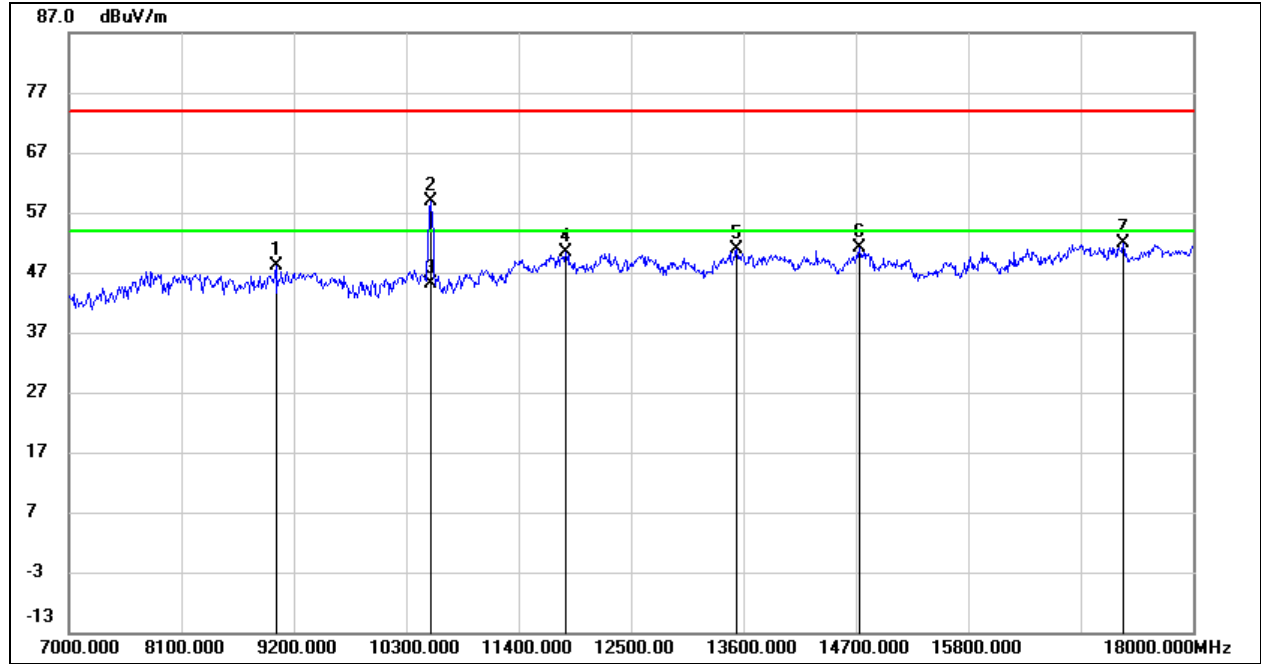

No.	Frequency (MHz)	Reading (dBuV)	Correct (dB/m)	Result (dBuV/m)	Limit (dBuV/m)	Margin (dB)	Remark
1	9024.000	37.06	11.01	48.07	74.00	-25.93	peak
2	10542.000	46.34	12.50	58.84	68.20	-9.36	peak
3	10542.000	32.73	12.50	45.23	/	/	AVG
4	11862.000	35.05	15.41	50.46	74.00	-23.54	peak
5	13534.000	33.62	17.18	50.80	74.00	-23.20	peak
6	14733.000	33.27	17.81	51.08	74.00	-22.92	peak
7	17318.000	29.33	22.47	51.80	74.00	-22.20	peak

- Note: 1. Measurement = Reading Level + Correct Factor.
 2. If Peak Result complies with AV limit, AV Result is deemed to comply with AV limit.
 3. Peak: Peak detector.
 4. AVG: $VBW=1/Ton$, where: Ton is the transmitting duration.
 5. For the transmitting duration, please refer to clause 7.1.
 6. Filter losses were only considered in the spurious frequency bands and the authorized band was not corrected for High Pass Filter losses.
 7. Proper operation of the transmitter prior to adding the filter to the measurement chain.
 8. Since non-restricted band peak emissions are less than the average limit, they also comply with the -27dBm/MHz (68.2dBuV/m) limit.



HARMONICS AND SPURIOUS EMISSIONS (HIGH CHANNEL, HORIZONTAL)

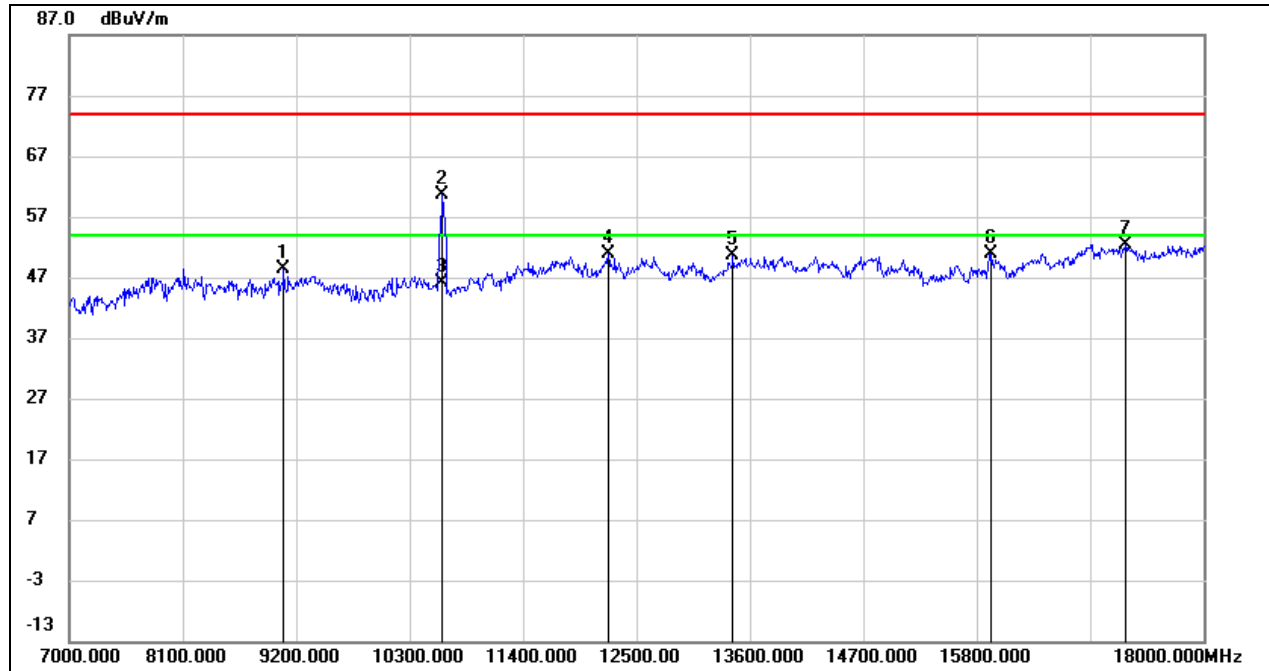

No.	Frequency (MHz)	Reading (dBuV)	Correct (dB/m)	Result (dBuV/m)	Limit (dBuV/m)	Margin (dB)	Remark
1	9079.000	37.88	10.38	48.26	74.00	-25.74	peak
2	10619.000	48.01	12.72	60.73	74.00	-13.27	peak
3	10619.000	33.31	12.72	46.03	54.00	-7.97	AVG
4	12225.000	34.96	15.99	50.95	74.00	-23.05	peak
5	13435.000	33.48	17.09	50.57	74.00	-23.43	peak
6	15943.000	32.76	18.21	50.97	74.00	-23.03	peak
7	17241.000	30.19	22.24	52.43	74.00	-21.57	peak

- Note: 1. Measurement = Reading Level + Correct Factor.
 2. If Peak Result complies with AV limit, AV Result is deemed to comply with AV limit.
 3. Peak: Peak detector.
 4. AVG: $VBW=1/Ton$, where: Ton is the transmitting duration.
 5. For the transmitting duration, please refer to clause 7.1.
 6. Filter losses were only considered in the spurious frequency bands and the authorized band was not corrected for High Pass Filter losses.
 7. Proper operation of the transmitter prior to adding the filter to the measurement chain.
 8. Since non-restricted band peak emissions are less than the average limit, they also comply with the -27dBm/MHz (68.2dBuV/m) limit.

HARMONICS AND SPURIOUS EMISSIONS (HIGH CHANNEL, VERTICAL)

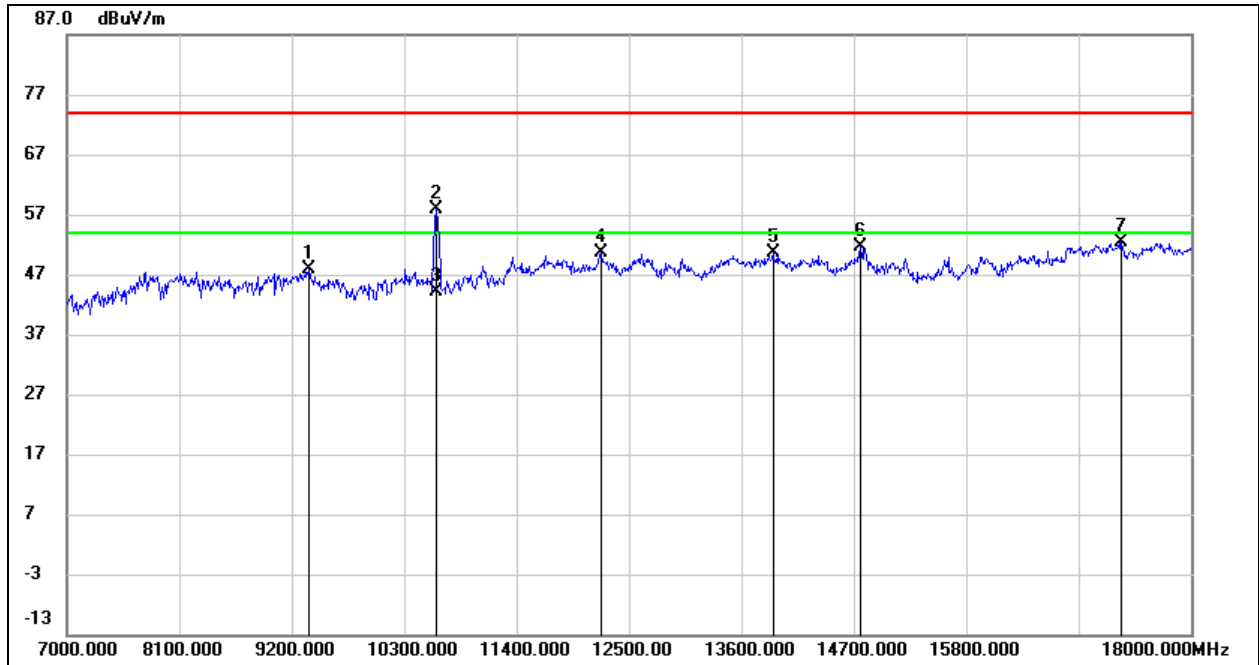

No.	Frequency (MHz)	Reading (dBuV)	Correct (dB/m)	Result (dBuV/m)	Limit (dBuV/m)	Margin (dB)	Remark
1	9365.000	37.03	10.77	47.80	74.00	-26.20	peak
2	10608.000	45.22	12.70	57.92	74.00	-16.08	peak
3	10608.000	31.53	12.70	44.23	54.00	-9.77	AVG
4	12225.000	34.65	15.99	50.64	74.00	-23.36	peak
5	13908.000	33.15	17.54	50.69	74.00	-23.31	peak
6	14766.000	33.68	17.92	51.60	74.00	-22.40	peak
7	17318.000	29.81	22.47	52.28	74.00	-21.72	peak

- Note:
1. Measurement = Reading Level + Correct Factor.
 2. If Peak Result complies with AV limit, AV Result is deemed to comply with AV limit.
 3. Peak: Peak detector.
 4. AVG: VBW=1/Ton, where: Ton is the transmitting duration.
 5. For the transmitting duration, please refer to clause 7.1.
 6. Filter losses were only considered in the spurious frequency bands and the authorized band was not corrected for High Pass Filter losses.
 7. Proper operation of the transmitter prior to adding the filter to the measurement chain.
 8. Since non-restricted band peak emissions are less than the average limit, they also comply with the -27dBm/MHz (68.2dBuV/m) limit.



UNII-2C BAND

HARMONICS AND SPURIOUS EMISSIONS (LOW CHANNEL, HORIZONTAL)

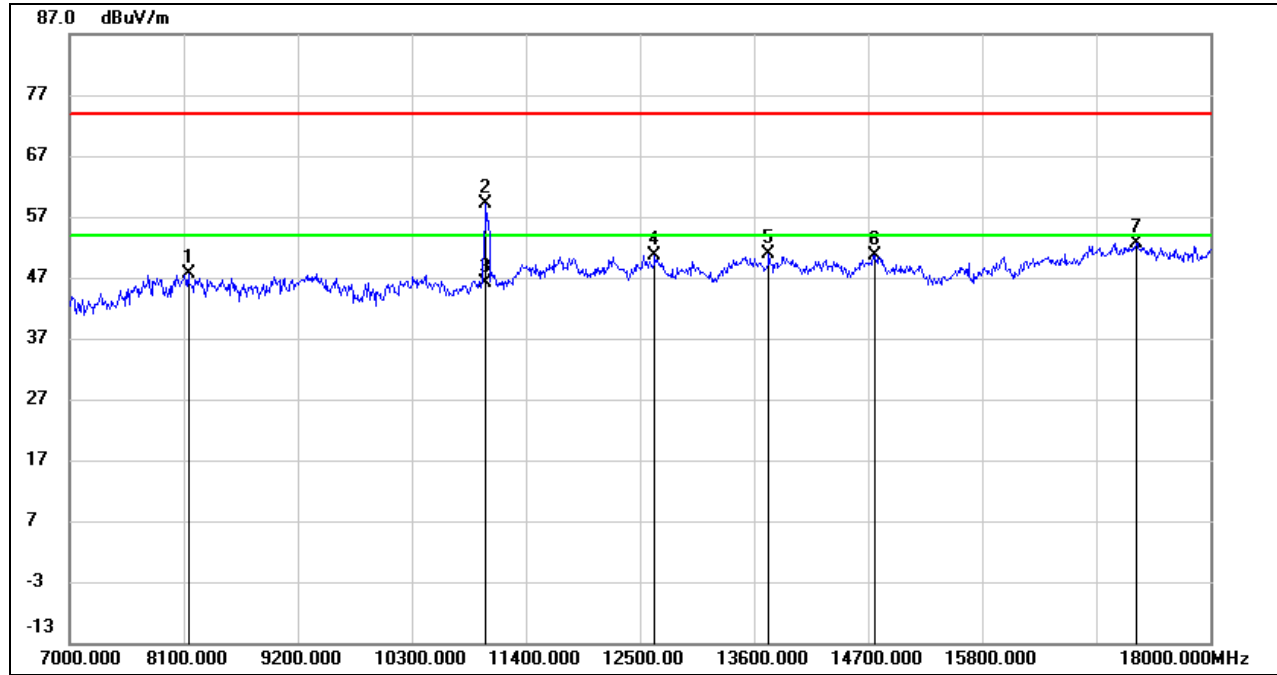

No.	Frequency (MHz)	Reading (dBuV)	Correct (dB/m)	Result (dBuV/m)	Limit (dBuV/m)	Margin (dB)	Remark
1	8144.000	37.69	10.02	47.71	74.00	-26.29	peak
2	11015.000	45.77	13.38	59.15	74.00	-14.85	peak
3	11015.000	32.82	13.38	46.20	54.00	-7.80	AVG
4	12643.000	34.97	15.71	50.68	74.00	-23.32	peak
5	13743.000	33.32	17.61	50.93	74.00	-23.07	peak
6	14766.000	32.71	17.92	50.63	74.00	-23.37	peak
7	17285.000	30.12	22.52	52.64	74.00	-21.36	peak

- Note: 1. Measurement = Reading Level + Correct Factor.
 2. If Peak Result complies with AV limit, AV Result is deemed to comply with AV limit.
 3. Peak: Peak detector.
 4. AVG: $VBW=1/Ton$, where: Ton is the transmitting duration.
 5. For the transmitting duration, please refer to clause 7.1.
 6. Filter losses were only considered in the spurious frequency bands and the authorized band was not corrected for High Pass Filter losses.
 7. Proper operation of the transmitter prior to adding the filter to the measurement chain.
 8. Since non-restricted band peak emissions are less than the average limit, they also comply with the -27dBm/MHz (68.2dBuV/m) limit.

HARMONICS AND SPURIOUS EMISSIONS (LOW CHANNEL, VERTICAL)

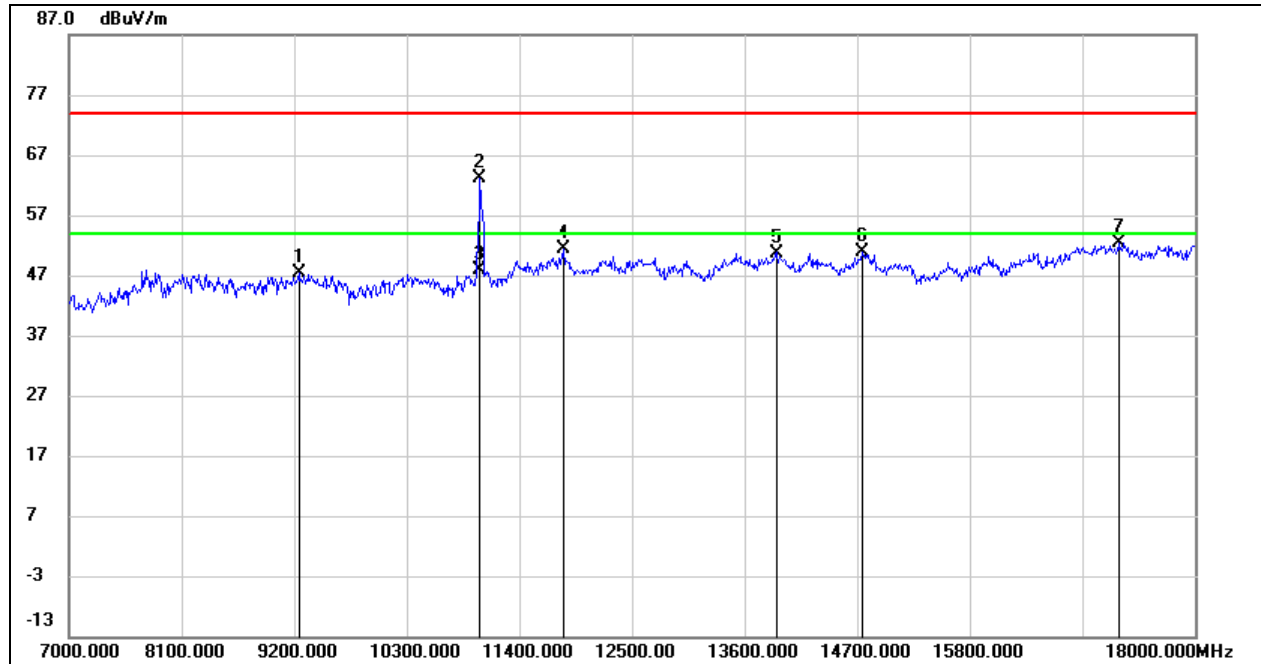

No.	Frequency (MHz)	Reading (dBuV)	Correct (dB/m)	Result (dBuV/m)	Limit (dBuV/m)	Margin (dB)	Remark
1	9244.000	37.14	10.12	47.26	74.00	-26.74	peak
2	11015.000	49.66	13.38	63.04	74.00	-10.96	peak
3	11015.000	34.48	13.38	47.86	54.00	-6.14	AVG
4	11829.000	36.03	15.32	51.35	74.00	-22.65	peak
5	13908.000	33.21	17.54	50.75	74.00	-23.25	peak
6	14755.000	32.93	17.88	50.81	74.00	-23.19	peak
7	17252.000	30.18	22.32	52.50	74.00	-21.50	peak

- Note: 1. Measurement = Reading Level + Correct Factor.
 2. If Peak Result complies with AV limit, AV Result is deemed to comply with AV limit.
 3. Peak: Peak detector.
 4. AVG: $VBW=1/T_{on}$, where: T_{on} is the transmitting duration.
 5. For the transmitting duration, please refer to clause 7.1.
 6. Filter losses were only considered in the spurious frequency bands and the authorized band was not corrected for High Pass Filter losses.
 7. Proper operation of the transmitter prior to adding the filter to the measurement chain.
 8. Since non-restricted band peak emissions are less than the average limit, they also comply with the -27dBm/MHz (68.2dBuV/m) limit.

HARMONICS AND SPURIOUS EMISSIONS (MID CHANNEL, HORIZONTAL)

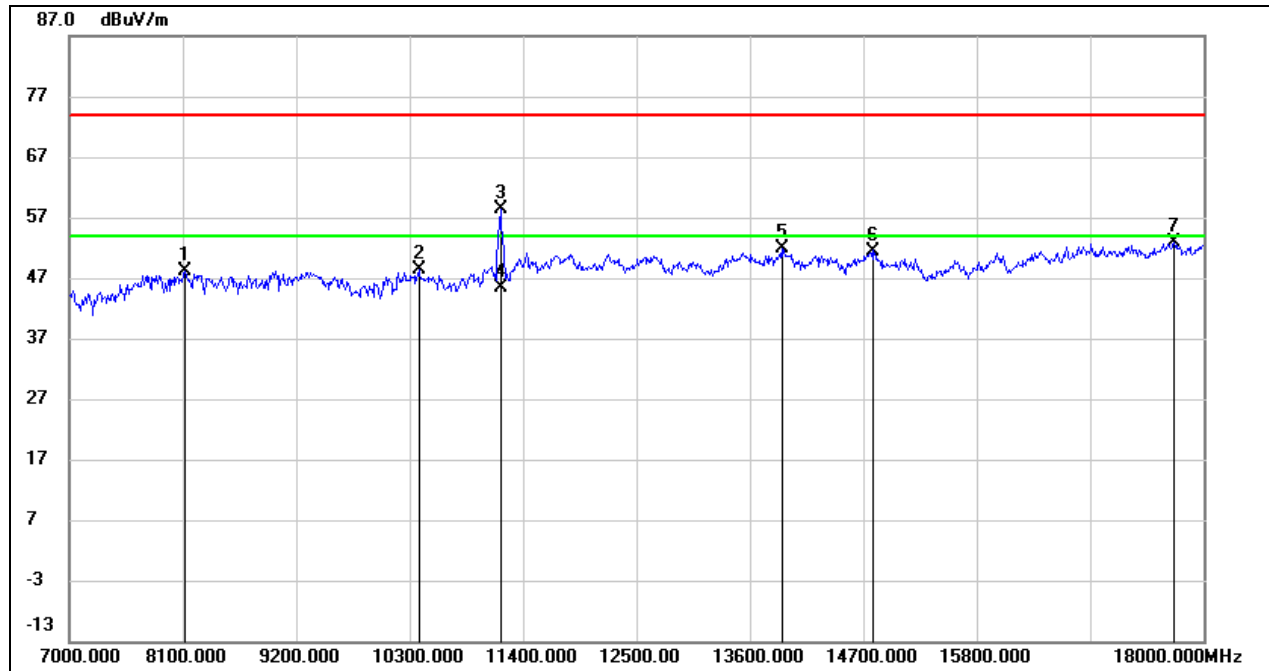

No.	Frequency (MHz)	Reading (dBuV)	Correct (dB/m)	Result (dBuV/m)	Limit (dBuV/m)	Margin (dB)	Remark
1	8122.000	38.07	10.10	48.17	74.00	-25.83	peak
2	10388.000	36.09	12.18	48.27	74.00	-25.73	peak
3	11180.000	44.54	13.79	58.33	74.00	-15.67	peak
4	11180.000	31.56	13.79	45.35	54.00	-8.65	AVG
5	13908.000	34.31	17.54	51.85	74.00	-22.15	peak
6	14799.000	33.46	18.04	51.50	74.00	-22.50	peak
7	17714.000	29.43	23.55	52.98	74.00	-21.02	peak

- Note: 1. Measurement = Reading Level + Correct Factor.
 2. If Peak Result complies with AV limit, AV Result is deemed to comply with AV limit.
 3. Peak: Peak detector.
 4. AVG: $VBW=1/Ton$, where: Ton is the transmitting duration.
 5. For the transmitting duration, please refer to clause 7.1.
 6. Filter losses were only considered in the spurious frequency bands and the authorized band was not corrected for High Pass Filter losses.
 7. Proper operation of the transmitter prior to adding the filter to the measurement chain.
 8. Since non-restricted band peak emissions are less than the average limit, they also comply with the -27dBm/MHz (68.2dBuV/m) limit.

HARMONICS AND SPURIOUS EMISSIONS (MID CHANNEL, VERTICAL)

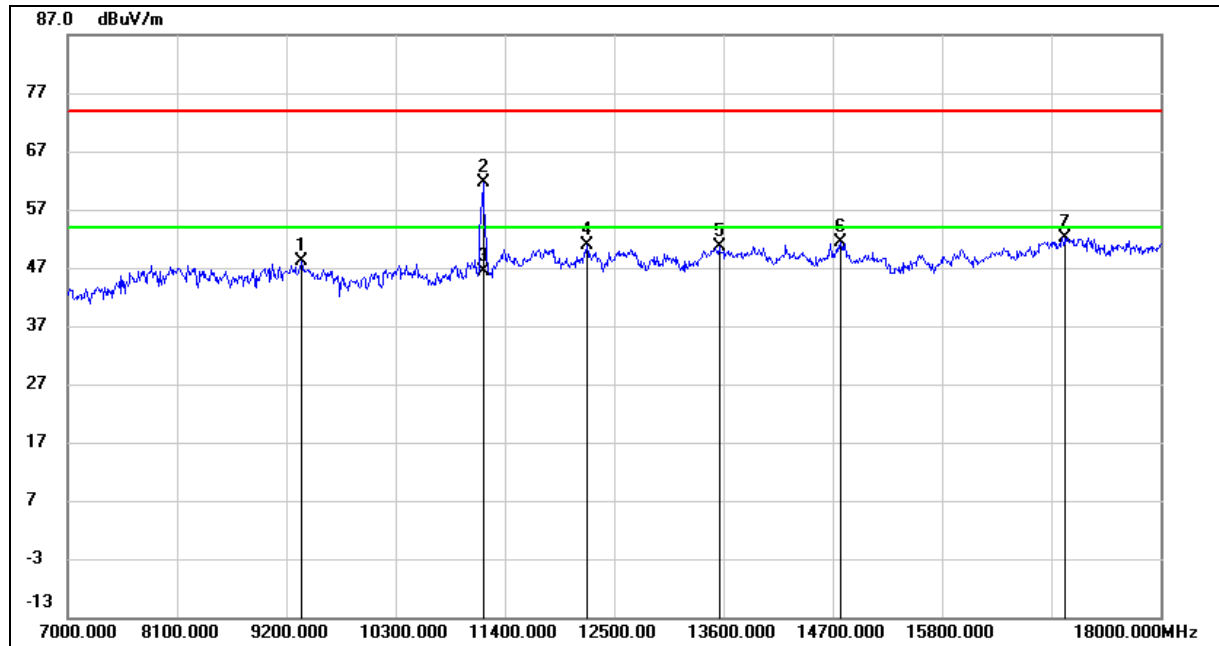

No.	Frequency (MHz)	Reading (dBuV)	Correct (dB/m)	Result (dBuV/m)	Limit (dBuV/m)	Margin (dB)	Remark
1	9354.000	37.55	10.70	48.25	74.00	-25.75	peak
2	11180.000	47.93	13.79	61.72	74.00	-12.28	peak
3	11180.000	32.54	13.79	46.33	54.00	-7.67	AVG
4	12225.000	34.78	15.99	50.77	74.00	-23.23	peak
5	13556.000	33.47	17.14	50.61	74.00	-23.39	peak
6	14777.000	33.39	17.96	51.35	74.00	-22.65	peak
7	17032.000	30.68	21.46	52.14	74.00	-21.86	peak

- Note: 1. Measurement = Reading Level + Correct Factor.
 2. If Peak Result complies with AV limit, AV Result is deemed to comply with AV limit.
 3. Peak: Peak detector.
 4. AVG: $VBW=1/Ton$, where: Ton is the transmitting duration.
 5. For the transmitting duration, please refer to clause 7.1.
 6. Filter losses were only considered in the spurious frequency bands and the authorized band was not corrected for High Pass Filter losses.
 7. Proper operation of the transmitter prior to adding the filter to the measurement chain.
 8. Since non-restricted band peak emissions are less than the average limit, they also comply with the -27dBm/MHz (68.2dBuV/m) limit.

HARMONICS AND SPURIOUS EMISSIONS (HIGH CHANNEL, HORIZONTAL)

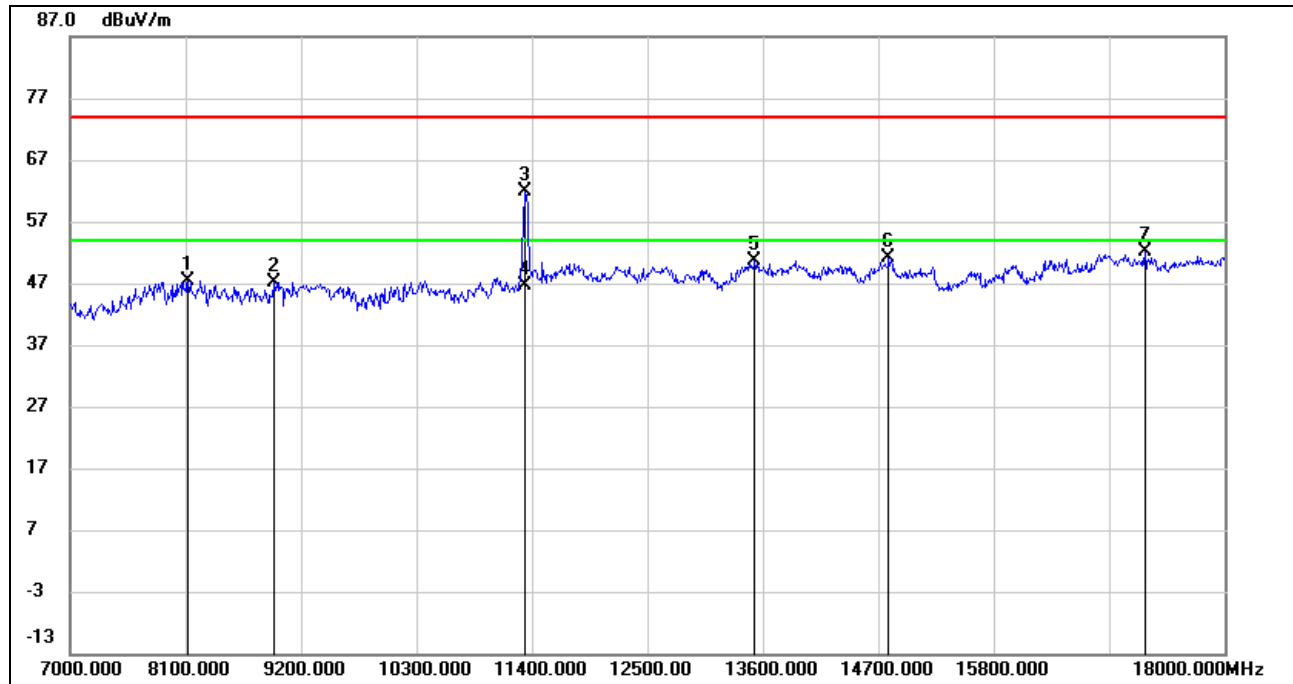

No.	Frequency (MHz)	Reading (dBuV)	Correct (dB/m)	Result (dBuV/m)	Limit (dBuV/m)	Margin (dB)	Remark
1	8122.000	37.16	10.10	47.26	74.00	-26.74	peak
2	8936.000	37.13	10.06	47.19	74.00	-26.81	peak
3	11334.000	47.78	14.15	61.93	74.00	-12.07	peak
4	11334.000	32.51	14.15	46.66	54.00	-7.34	AVG
5	13523.000	33.33	17.19	50.52	74.00	-23.48	peak
6	14799.000	33.07	18.04	51.11	74.00	-22.89	peak
7	17241.000	29.85	22.24	52.09	74.00	-21.91	peak

- Note: 1. Measurement = Reading Level + Correct Factor.
 2. If Peak Result complies with AV limit, AV Result is deemed to comply with AV limit.
 3. Peak: Peak detector.
 4. AVG: $VBW=1/Ton$, where: Ton is the transmitting duration.
 5. For the transmitting duration, please refer to clause 7.1.
 6. Filter losses were only considered in the spurious frequency bands and the authorized band was not corrected for High Pass Filter losses.
 7. Proper operation of the transmitter prior to adding the filter to the measurement chain.
 8. Since non-restricted band peak emissions are less than the average limit, they also comply with the -27dBm/MHz (68.2dBuV/m) limit.



HARMONICS AND SPURIOUS EMISSIONS (HIGH CHANNEL, VERTICAL)

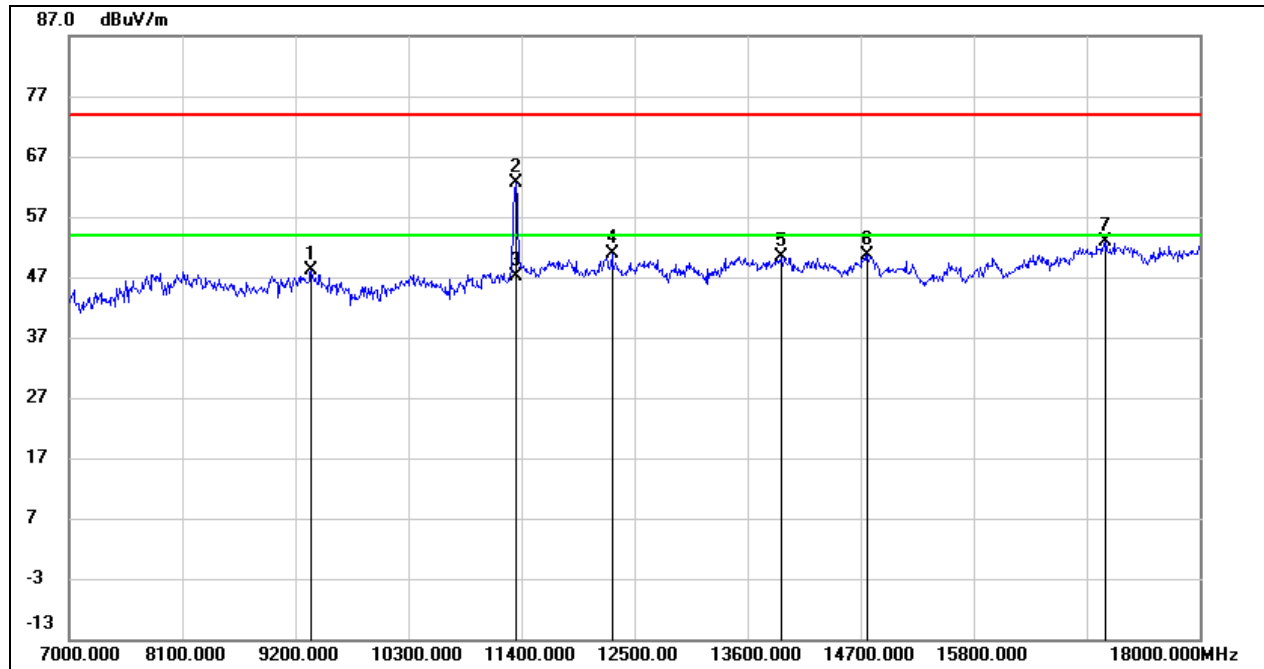

No.	Frequency (MHz)	Reading (dBuV)	Correct (dB/m)	Result (dBuV/m)	Limit (dBuV/m)	Margin (dB)	Remark
1	9354.000	37.43	10.70	48.13	74.00	-25.87	peak
2	11345.000	48.45	14.26	62.71	74.00	-11.29	peak
3	11345.000	32.99	14.26	47.25	54.00	-6.75	AVG
4	12280.000	34.77	16.07	50.84	74.00	-23.16	peak
5	13930.000	32.72	17.57	50.29	74.00	-23.71	peak
6	14766.000	32.72	17.92	50.64	74.00	-23.36	peak
7	17087.000	31.09	21.81	52.90	74.00	-21.10	peak

- Note: 1. Measurement = Reading Level + Correct Factor.
 2. If Peak Result complies with AV limit, AV Result is deemed to comply with AV limit.
 3. Peak: Peak detector.
 4. AVG: $VBW=1/T_{on}$, where: T_{on} is the transmitting duration.
 5. For the transmitting duration, please refer to clause 7.1.
 6. Filter losses were only considered in the spurious frequency bands and the authorized band was not corrected for High Pass Filter losses.
 7. Proper operation of the transmitter prior to adding the filter to the measurement chain.
 8. Since non-restricted band peak emissions are less than the average limit, they also comply with the -27dBm/MHz (68.2dBuV/m) limit.

UNII-3 BAND

HARMONICS AND SPURIOUS EMISSIONS (LOW CHANNEL, HORIZONTAL)

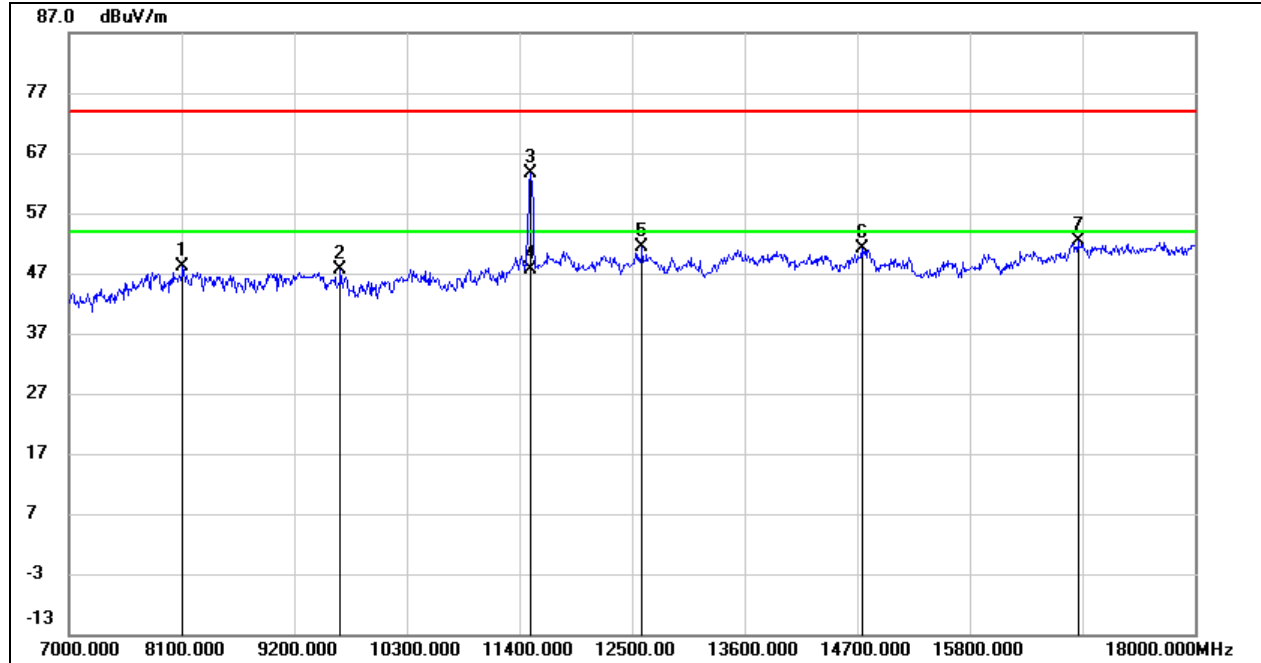

No.	Frequency (MHz)	Reading (dBuV)	Correct (dB/m)	Result (dBuV/m)	Limit (dBuV/m)	Margin (dB)	Remark
1	8111.000	38.01	10.14	48.15	74.00	-25.85	peak
2	9651.000	36.92	10.77	47.69	74.00	-26.31	peak
3	11510.000	48.97	14.66	63.63	74.00	-10.37	peak
4	11510.000	33.08	14.66	47.74	54.00	-6.26	AVG
5	12599.000	35.55	15.78	51.33	74.00	-22.67	peak
6	14744.000	33.21	17.84	51.05	74.00	-22.95	peak
7	16856.000	31.27	21.19	52.46	74.00	-21.54	peak

- Note:
1. Measurement = Reading Level + Correct Factor.
 2. If Peak Result complies with AV limit, AV Result is deemed to comply with AV limit.
 3. Peak: Peak detector.
 4. AVG: $VBW=1/Ton$, where: Ton is the transmitting duration.
 5. For the transmitting duration, please refer to clause 7.1.
 6. Filter losses were only considered in the spurious frequency bands and the authorized band was not corrected for High Pass Filter losses.
 7. Proper operation of the transmitter prior to adding the filter to the measurement chain.
 8. Since non-restricted band peak emissions are less than the average limit, they also comply with the -27dBm/MHz (68.2dBuV/m) limit.

HARMONICS AND SPURIOUS EMISSIONS (LOW CHANNEL, VERTICAL)

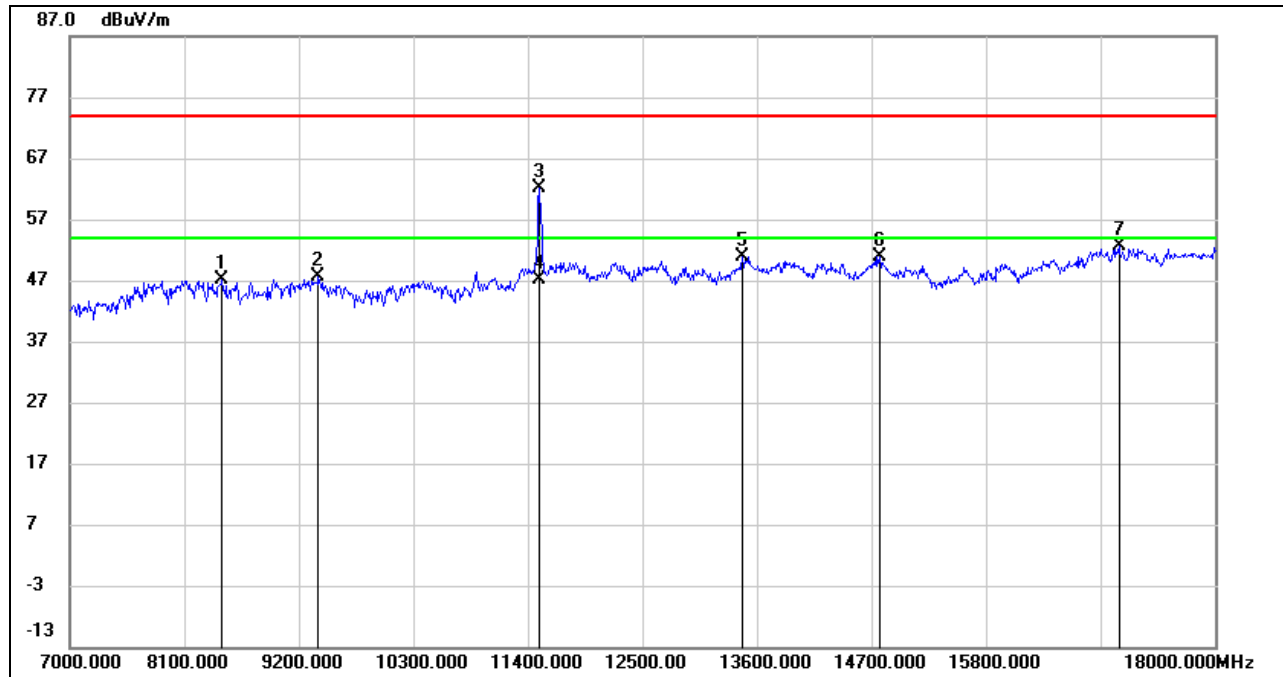

No.	Frequency (MHz)	Reading (dBuV)	Correct (dB/m)	Result (dBuV/m)	Limit (dBuV/m)	Margin (dB)	Remark
1	8463.000	37.92	9.20	47.12	74.00	-26.88	peak
2	9387.000	36.78	10.89	47.67	74.00	-26.33	peak
3	11510.000	47.40	14.66	62.06	74.00	-11.94	peak
4	11510.000	32.47	14.66	47.13	54.00	-6.87	AVG
5	13457.000	33.75	17.14	50.89	74.00	-23.11	peak
6	14777.000	32.96	17.96	50.92	74.00	-23.08	peak
7	17076.000	30.96	21.74	52.70	74.00	-21.30	peak

Note: 1. Measurement = Reading Level + Correct Factor.
 2. If Peak Result complies with AV limit, AV Result is deemed to comply with AV limit.
 3. Peak: Peak detector.
 4. AVG: $VBW=1/Ton$, where: Ton is the transmitting duration.
 5. For the transmitting duration, please refer to clause 7.1.
 6. Filter losses were only considered in the spurious frequency bands and the authorized band was not corrected for High Pass Filter losses.
 7. Proper operation of the transmitter prior to adding the filter to the measurement chain.
 8. Since non-restricted band peak emissions are less than the average limit, they also comply with the -27dBm/MHz (68.2dBuV/m) limit.

HARMONICS AND SPURIOUS EMISSIONS (HIGH CHANNEL, HORIZONTAL)

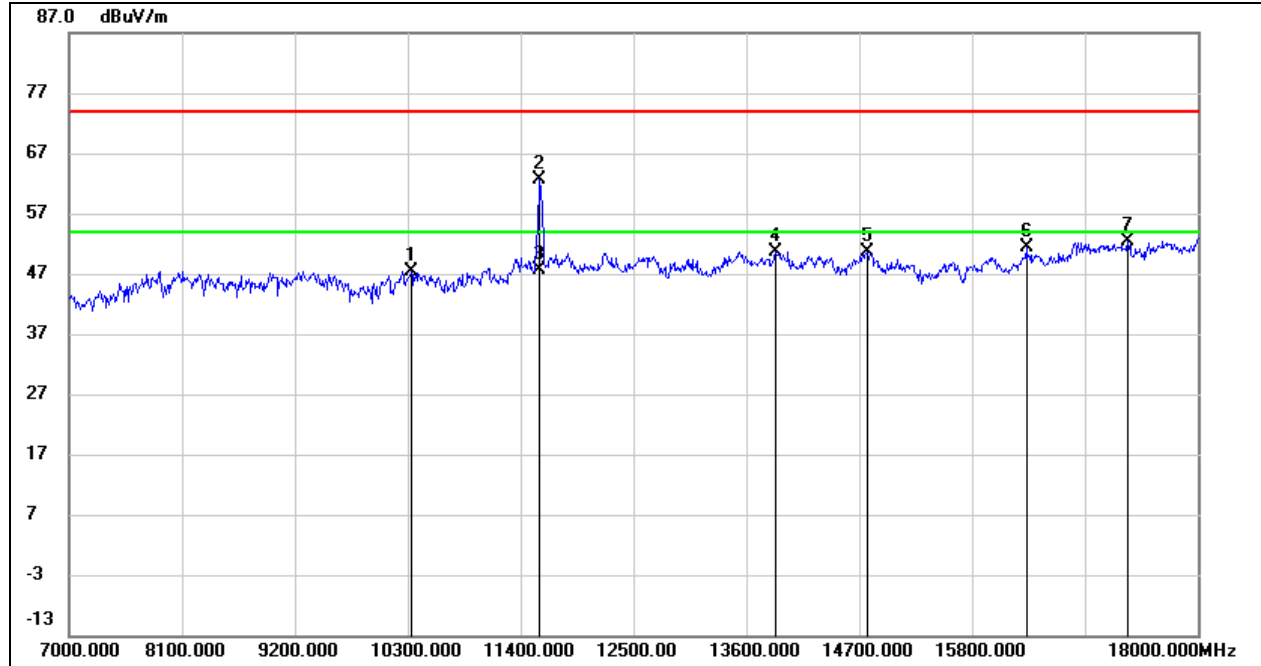

No.	Frequency (MHz)	Reading (dBuV)	Correct (dB/m)	Result (dBuV/m)	Limit (dBuV/m)	Margin (dB)	Remark
1	10333.000	35.48	11.94	47.42	74.00	-26.58	peak
2	11587.000	48.03	14.72	62.75	74.00	-11.25	peak
3	11587.000	32.98	14.72	47.70	54.00	-6.30	AVG
4	13886.000	33.11	17.54	50.65	74.00	-23.35	peak
5	14777.000	32.76	17.96	50.72	74.00	-23.28	peak
6	16328.000	31.81	19.63	51.44	74.00	-22.56	peak
7	17318.000	29.92	22.47	52.39	74.00	-21.61	peak

- Note: 1. Measurement = Reading Level + Correct Factor.
 2. If Peak Result complies with AV limit, AV Result is deemed to comply with AV limit.
 3. Peak: Peak detector.
 4. AVG: $VBW=1/Ton$, where: Ton is the transmitting duration.
 5. For the transmitting duration, please refer to clause 7.1.
 6. Filter losses were only considered in the spurious frequency bands and the authorized band was not corrected for High Pass Filter losses.
 7. Proper operation of the transmitter prior to adding the filter to the measurement chain.
 8. Since non-restricted band peak emissions are less than the average limit, they also comply with the -27dBm/MHz (68.2dBuV/m) limit.

HARMONICS AND SPURIOUS EMISSIONS (HIGH CHANNEL, VERTICAL)

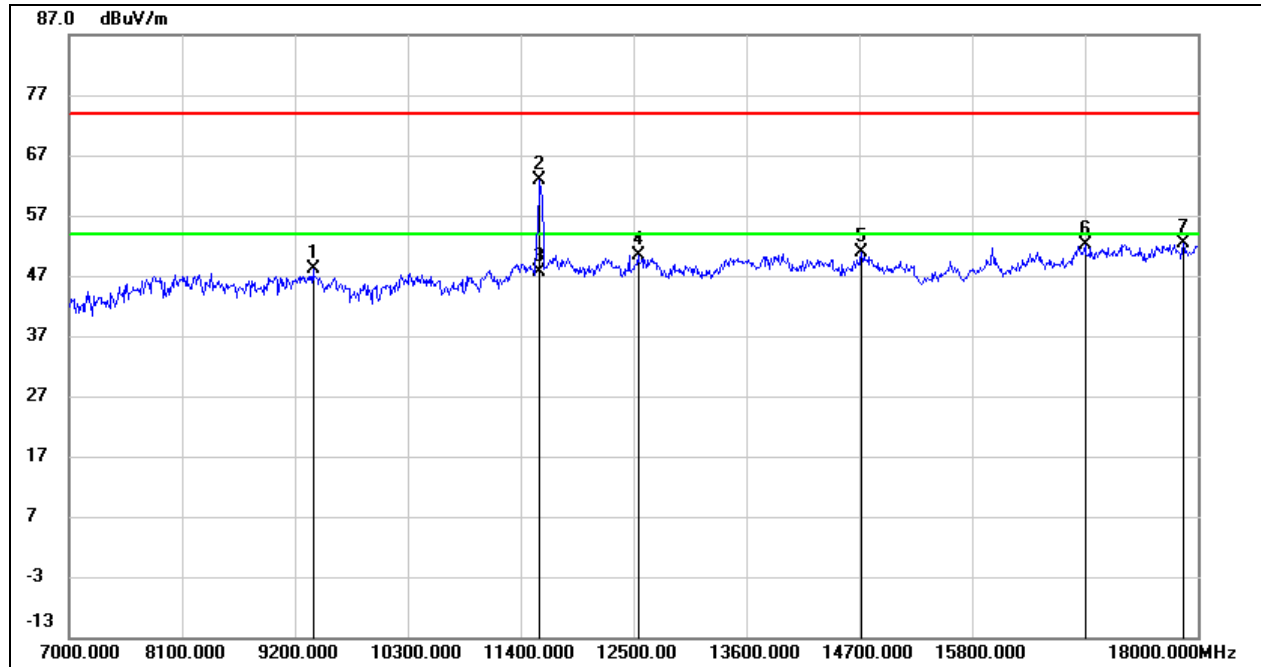

No.	Frequency (MHz)	Reading (dBuV)	Correct (dB/m)	Result (dBuV/m)	Limit (dBuV/m)	Margin (dB)	Remark
1	9376.000	37.27	10.84	48.11	74.00	-25.89	peak
2	11587.000	48.20	14.72	62.92	74.00	-11.08	peak
3	11587.000	32.81	14.72	47.53	54.00	-6.47	AVG
4	12544.000	34.55	15.72	50.27	74.00	-23.73	peak
5	14722.000	33.02	17.77	50.79	74.00	-23.21	peak
6	16900.000	30.45	21.57	52.02	74.00	-21.98	peak
7	17857.000	28.49	23.96	52.45	74.00	-21.55	peak

Note: 1. Measurement = Reading Level + Correct Factor.
 2. If Peak Result complies with AV limit, AV Result is deemed to comply with AV limit.
 3. Peak: Peak detector.
 4. AVG: VBW=1/Ton, where: Ton is the transmitting duration.
 5. For the transmitting duration, please refer to clause 7.1.
 6. Filter losses were only considered in the spurious frequency bands and the authorized band was not corrected for High Pass Filter losses.
 7. Proper operation of the transmitter prior to adding the filter to the measurement chain.
 8. Since non-restricted band peak emissions are less than the average limit, they also comply with the -27dBm/MHz (68.2dBuV/m) limit.

8.4. SPURIOUS EMISSIONS FOR SIMULTANEOUS TRANSMISSION

8.4.1. 802.11a MODE AND BT MODE WORST CASE

HARMONICS AND SPURIOUS EMISSIONS (802.11a MODE UNII-2C MIDDLE CHANNEL, BT 8DQPSK MIDDLE, HORIZONTAL)

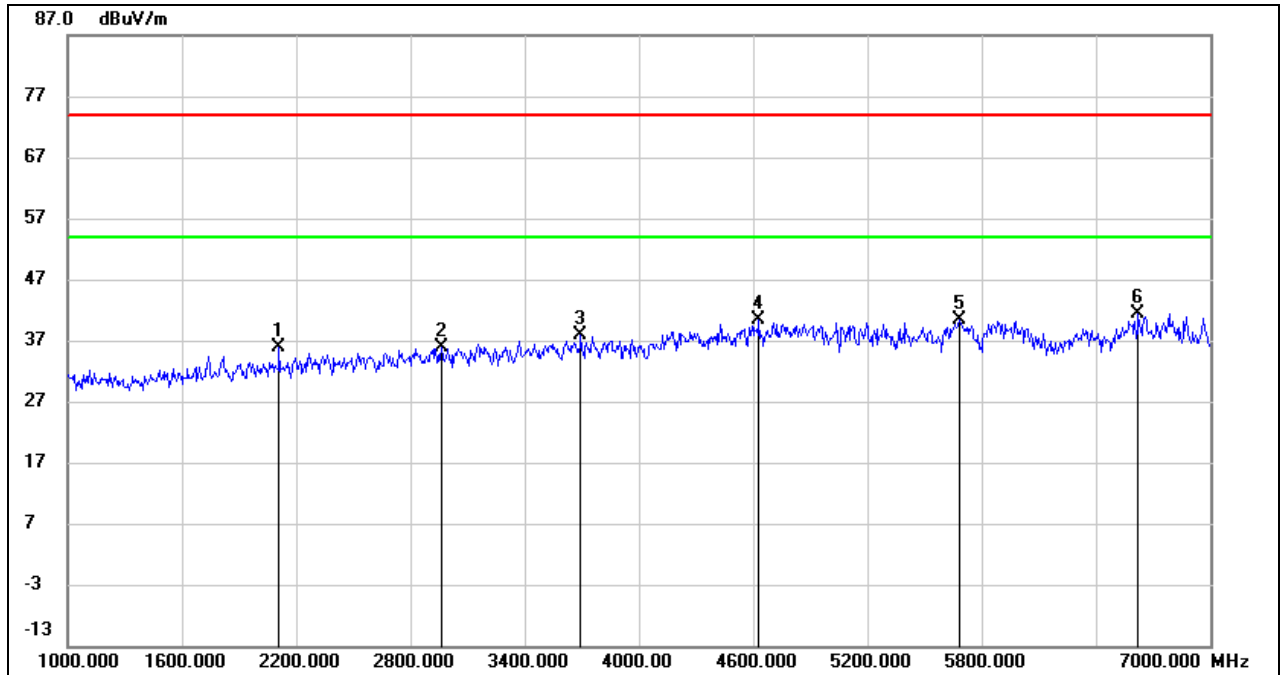

No.	Frequency (MHz)	Reading (dBuV)	Correct (dB/m)	Result (dBuV/m)	Limit (dBuV/m)	Margin (dB)	Remark
1	2110.000	45.42	-9.56	35.86	74.00	-38.14	peak
2	2962.000	41.75	-5.78	35.97	74.00	-38.03	peak
3	3694.000	41.72	-3.75	37.97	74.00	-36.03	peak
4	4630.000	40.82	-0.38	40.44	74.00	-33.56	peak
5	5680.000	38.00	2.48	40.48	74.00	-33.52	peak
6	6622.000	35.81	5.51	41.32	74.00	-32.68	peak

- Note: 1. Measurement = Reading Level + Correct Factor.
 2. If Peak Result complies with AV limit, AV Result is deemed to comply with AV limit.
 3. Peak: Peak detector.
 4. AVG: $VBW=1/T_{on}$, where: T_{on} is the transmitting duration.
 5. For the transmitting duration, please refer to clause 7.1.
 6. Filter losses were only considered in the spurious frequency bands and the authorized band was not corrected for Band reject filter losses.
 7. Proper operation of the transmitter prior to adding the filter to the measurement chain.
 8. Owing to the highest peak level of unwanted emission out of the restricted bands complies with the lowest limit(54dBuV/m), so all the test point was deemed to comply with the limits list in the standard.

HARMONICS AND SPURIOUS EMISSIONS (802.11a MODE UNII-2C MIDDLE CHANNEL, BT 8DQPSK MIDDLE, VERTICAL)

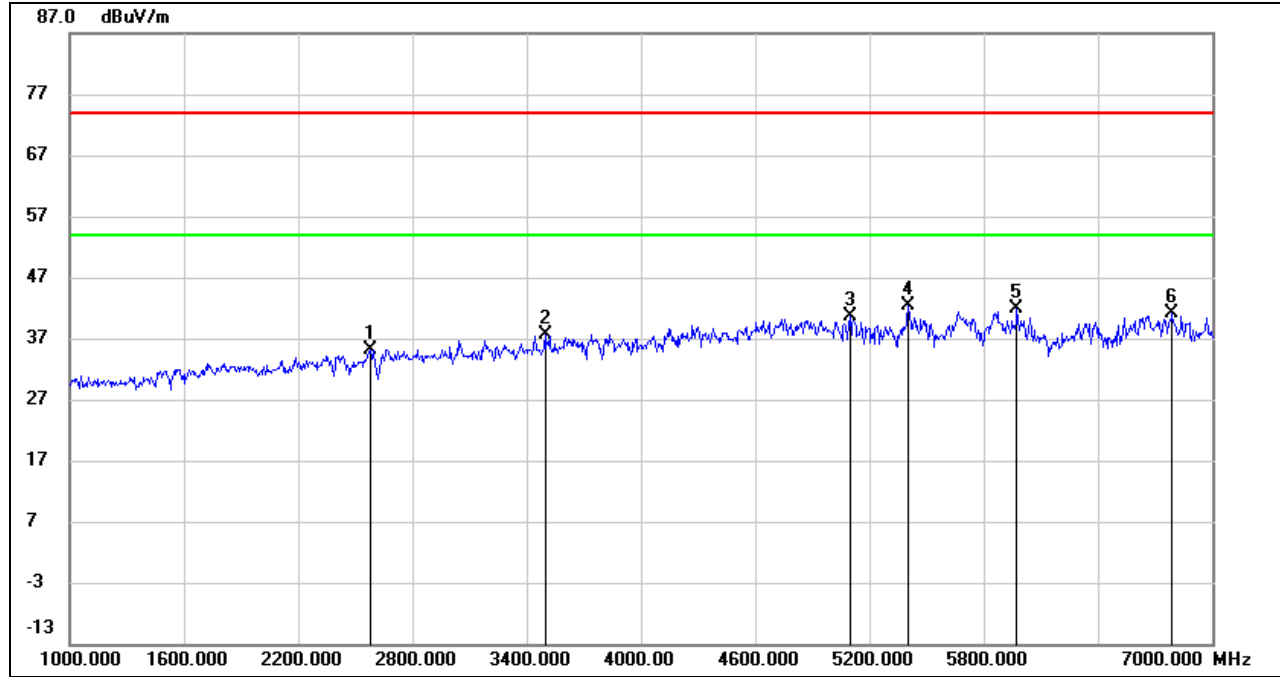

No.	Frequency (MHz)	Reading (dBuV)	Correct (dB/m)	Result (dBuV/m)	Limit (dBuV/m)	Margin (dB)	Remark
1	2578.000	43.11	-7.95	35.16	74.00	-38.84	peak
2	3496.000	42.24	-4.72	37.52	74.00	-36.48	peak
3	5098.000	39.09	1.49	40.58	74.00	-33.42	peak
4	5404.000	40.51	1.89	42.40	74.00	-31.60	peak
5	5974.000	38.58	3.20	41.78	74.00	-32.22	peak
6	6790.000	35.47	5.57	41.04	74.00	-32.96	peak

- Note: 1. Measurement = Reading Level + Correct Factor.
 2. If Peak Result complies with AV limit, AV Result is deemed to comply with AV limit.
 3. Peak: Peak detector.
 4. AVG: VBW=1/Ton, where: Ton is the transmitting duration.
 5. For the transmitting duration, please refer to clause 7.1.
 6. Filter losses were only considered in the spurious frequency bands and the authorized band was not corrected for Band reject filter losses.
 7. Proper operation of the transmitter prior to adding the filter to the measurement chain.
 8. Owing to the highest peak level of unwanted emission out of the restricted bands complies with the lowest limit(54dBuV/m), so all the test point was deemed to comply with the limits list in the standard.

Note: All the modes and antennas had been tested, but only the worst data was recorded in the report.



8.4.2. 802.11a MODE AND BT MODE WORST CASE

HARMONICS AND SPURIOUS EMISSIONS (802.11a MODE UNII-2C MIDDLE CHANNEL, BT 8DQPSK MIDDLE, HORIZONTAL)

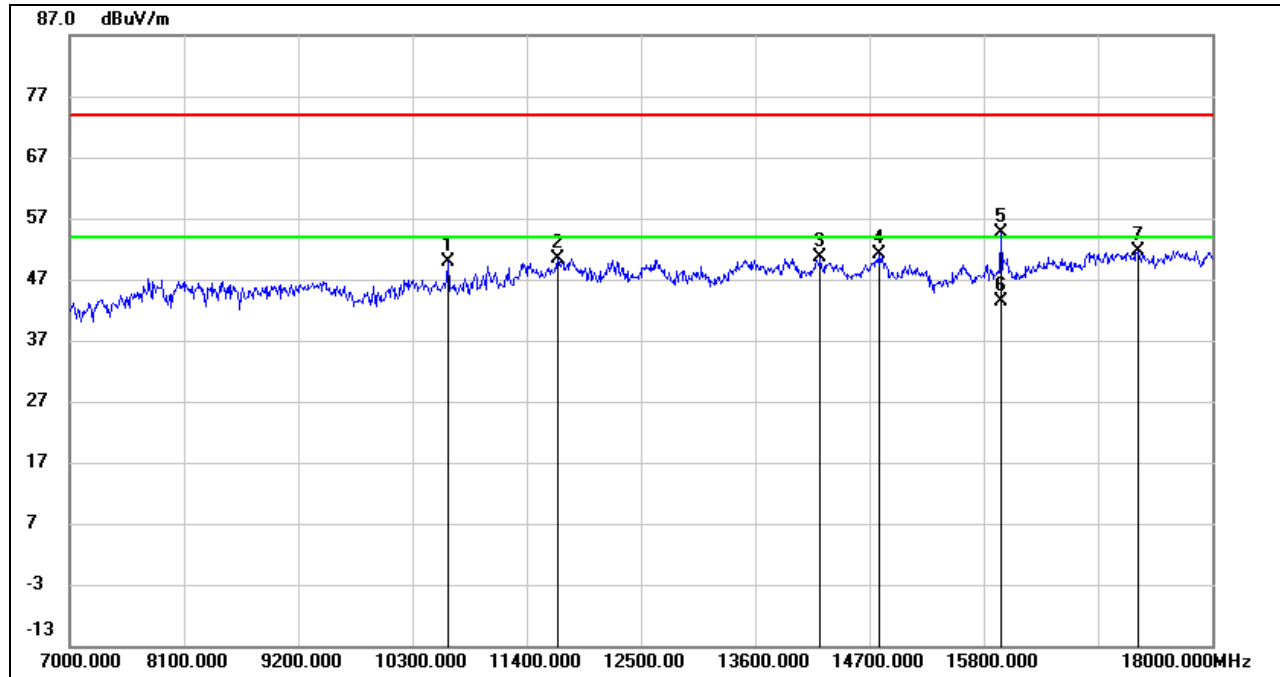

No.	Frequency (MHz)	Reading (dBuV)	Correct (dB/m)	Result (dBuV/m)	Limit (dBuV/m)	Margin (dB)	Remark
1	10641.000	36.99	12.77	49.76	74.00	-24.24	peak
2	11697.000	35.13	15.34	50.47	74.00	-23.53	peak
3	14227.000	32.71	17.88	50.59	74.00	-23.41	peak
4	14799.000	33.18	18.04	51.22	74.00	-22.78	peak
5	15960.000	36.30	18.27	54.57	74.00	-19.43	peak
6	15960.000	25.01	18.27	43.28	54.00	-10.72	AVG
7	17285.000	29.13	22.52	51.65	74.00	-22.35	peak

- Note:
1. Measurement = Reading Level + Correct Factor.
 2. If Peak Result complies with AV limit, AV Result is deemed to comply with AV limit.
 3. Peak: Peak detector.
 4. AVG: $VBW=1/Ton$, where: Ton is the transmitting duration.
 5. For the transmitting duration, please refer to clause 7.1.
 6. Filter losses were only considered in the spurious frequency bands and the authorized band was not corrected for High Pass Filter losses.
 7. Proper operation of the transmitter prior to adding the filter to the measurement chain.
 8. Owing to the highest peak level of unwanted emission out of the restricted bands complies with the lowest limit(54dBuV/m), so all the test point was deemed to comply with the limits list in the standard.

HARMONICS AND SPURIOUS EMISSIONS (802.11a MODE UNII-2C MIDDLE CHANNEL, BT 8DQPSK MIDDLE, VERTICAL)

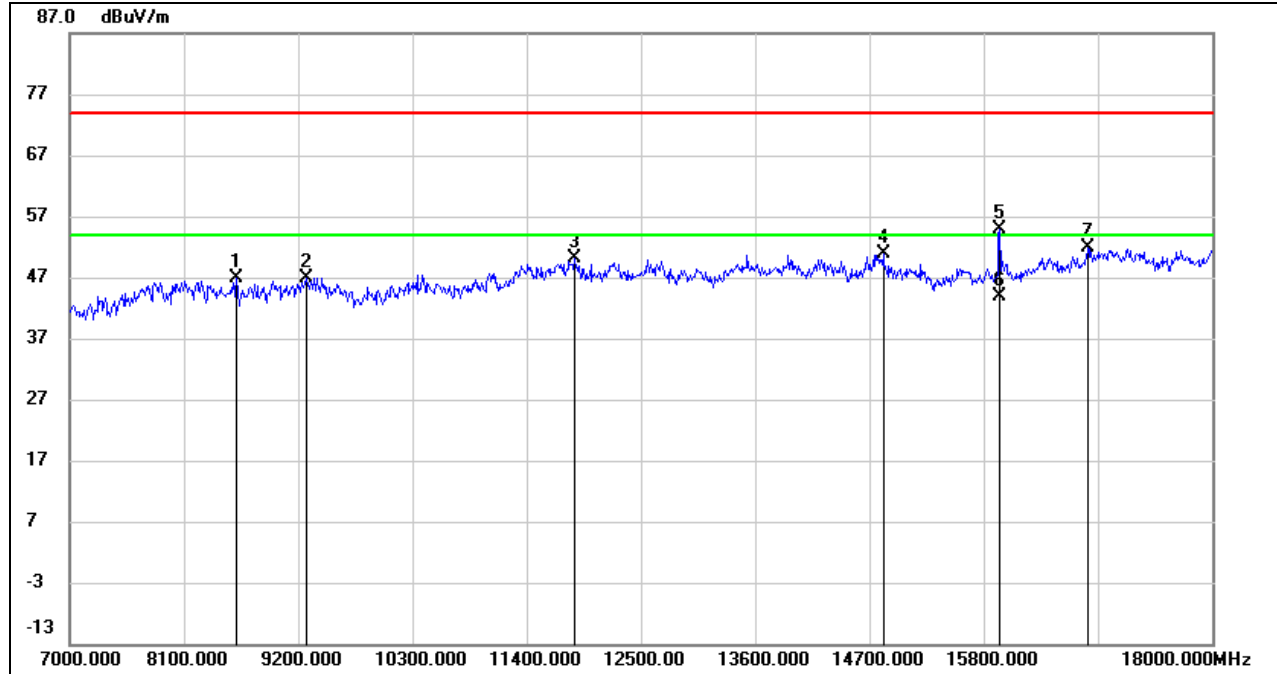

No.	Frequency (MHz)	Reading (dBuV)	Correct (dB/m)	Result (dBuV/m)	Limit (dBuV/m)	Margin (dB)	Remark
1	8606.000	37.60	9.16	46.76	74.00	-27.24	peak
2	9277.000	36.72	10.28	47.00	74.00	-27.00	peak
3	11862.000	34.67	15.41	50.08	74.00	-23.92	peak
4	14832.000	32.97	17.83	50.80	74.00	-23.20	peak
5	15960.000	36.66	18.27	54.93	74.00	-19.07	peak
6	15960.000	25.59	18.27	43.86	54.00	-10.14	AVG
7	16801.000	31.14	20.72	51.86	74.00	-22.14	peak

Note: 1. Measurement = Reading Level + Correct Factor.
 2. If Peak Result complies with AV limit, AV Result is deemed to comply with AV limit.
 3. Peak: Peak detector.
 4. AVG: $VBW=1/Ton$, where: Ton is the transmitting duration.
 5. For the transmitting duration, please refer to clause 7.1.
 6. Filter losses were only considered in the spurious frequency bands and the authorized band was not corrected for High Pass Filter losses.
 7. Proper operation of the transmitter prior to adding the filter to the measurement chain.
 8. Owing to the highest peak level of unwanted emission out of the restricted bands complies with the lowest limit(54dBuV/m), so all the test point was deemed to comply with the limits list in the standard.

Note: All the modes and antennas had been tested, but only the worst data was recorded in the report.

8.5. SPURIOUS EMISSIONS (18 GHz ~ 26 GHz)

8.5.1. 802.11a MODE AND BT MODE WORST CASE

SPURIOUS EMISSIONS (802.11a MODE UNII-2C MIDDLE CHANNEL, BT 8DQPSK MIDDLE CHANNEL, HORIZONTAL)

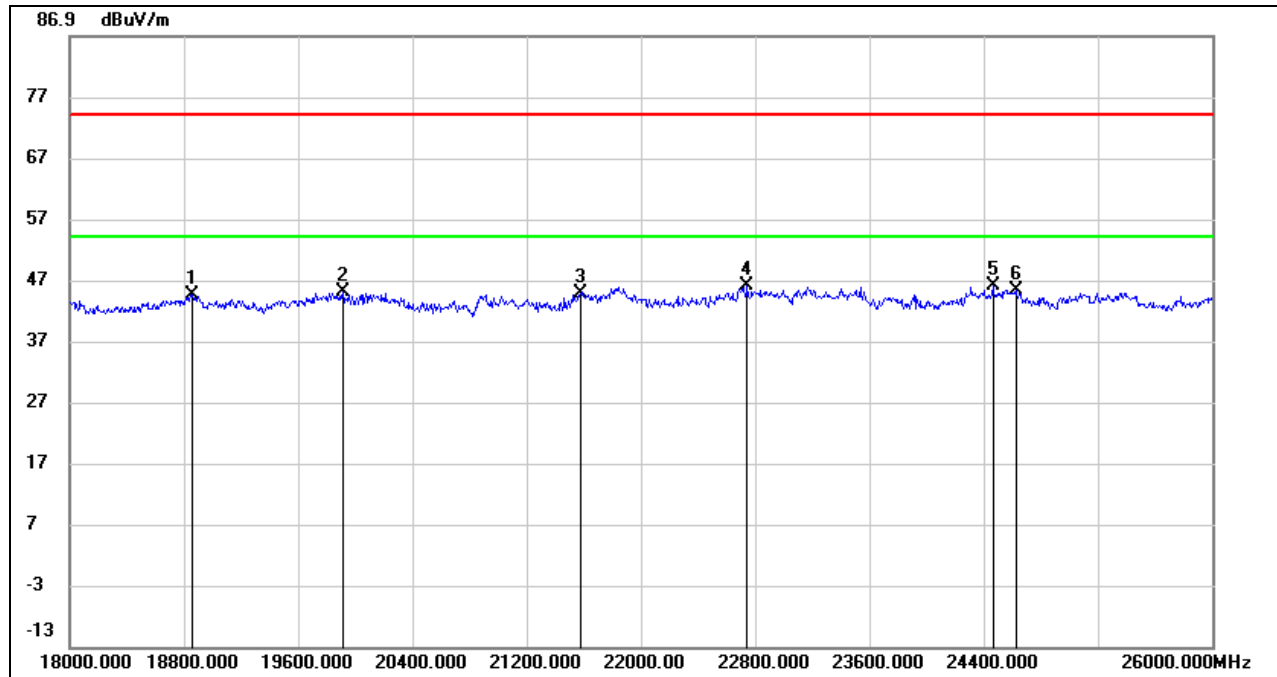

No.	Frequency (MHz)	Reading (dBuV)	Correct (dB/m)	Result (dBuV/m)	Limit (dBuV/m)	Margin (dB)	Remark
1	18856.000	49.49	-4.87	44.62	74.00	-29.38	peak
2	19912.000	49.41	-4.36	45.05	74.00	-28.95	peak
3	21576.000	50.48	-5.77	44.71	74.00	-29.29	peak
4	22744.000	51.68	-5.74	45.94	74.00	-28.06	peak
5	24464.000	48.78	-2.74	46.04	74.00	-27.96	peak
6	24624.000	47.65	-2.27	45.38	74.00	-28.62	peak

- Note: 1. Measurement = Reading Level + Correct Factor.
 2. If Peak Result complies with AV limit, AV Result is deemed to comply with AV limit.
 3. Peak: Peak detector.
 4. Proper operation of the transmitter prior to adding the filter to the measurement chain.



SPURIOUS EMISSIONS (802.11a MODE UNII-2C MIDDLE CHANNEL, BT 8DQPSK MIDDLE CHANNEL, VERTICAL)

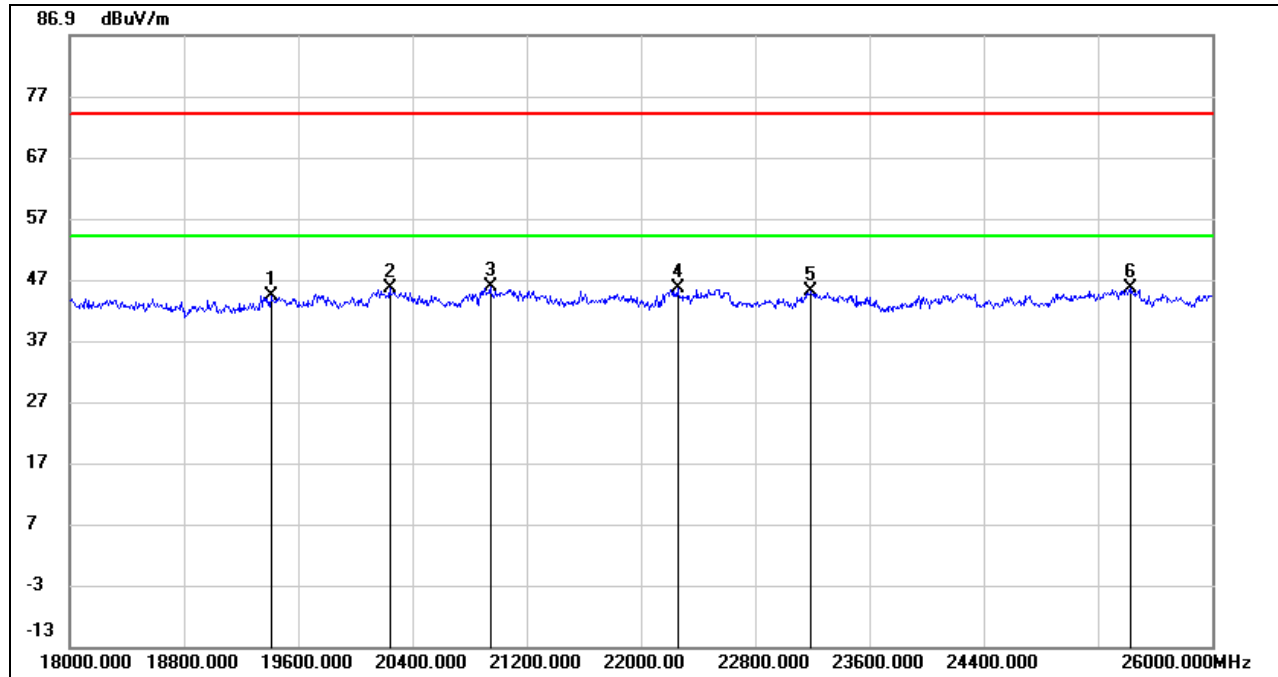

No.	Frequency (MHz)	Reading (dBuV)	Correct (dB/m)	Result (dBuV/m)	Limit (dBuV/m)	Margin (dB)	Remark
1	19408.000	49.23	-4.89	44.34	74.00	-29.66	peak
2	20240.000	50.35	-4.86	45.49	74.00	-28.51	peak
3	20944.000	50.94	-5.24	45.70	74.00	-28.30	peak
4	22256.000	51.58	-6.06	45.52	74.00	-28.48	peak
5	23192.000	50.42	-5.34	45.08	74.00	-28.92	peak
6	25424.000	47.14	-1.63	45.51	74.00	-28.49	peak

- Note: 1. Measurement = Reading Level + Correct Factor.
 2. If Peak Result complies with AV limit, AV Result is deemed to comply with AV limit.
 3. Peak: Peak detector.
 4. Proper operation of the transmitter prior to adding the filter to the measurement chain.

Note: All the modes and antennas had been tested, but only the worst data was recorded in the report.

8.6. SPURIOUS EMISSIONS (26 GHz ~ 40 GHz)

8.6.1. 802.11a MODE AND BT MODE WORST CASE

HARMONICS AND SPURIOUS EMISSIONS (802.11a MODE UNII-2C MIDDLE CHANNEL, BT 8DQPSK MIDDLE, HORIZONTAL)

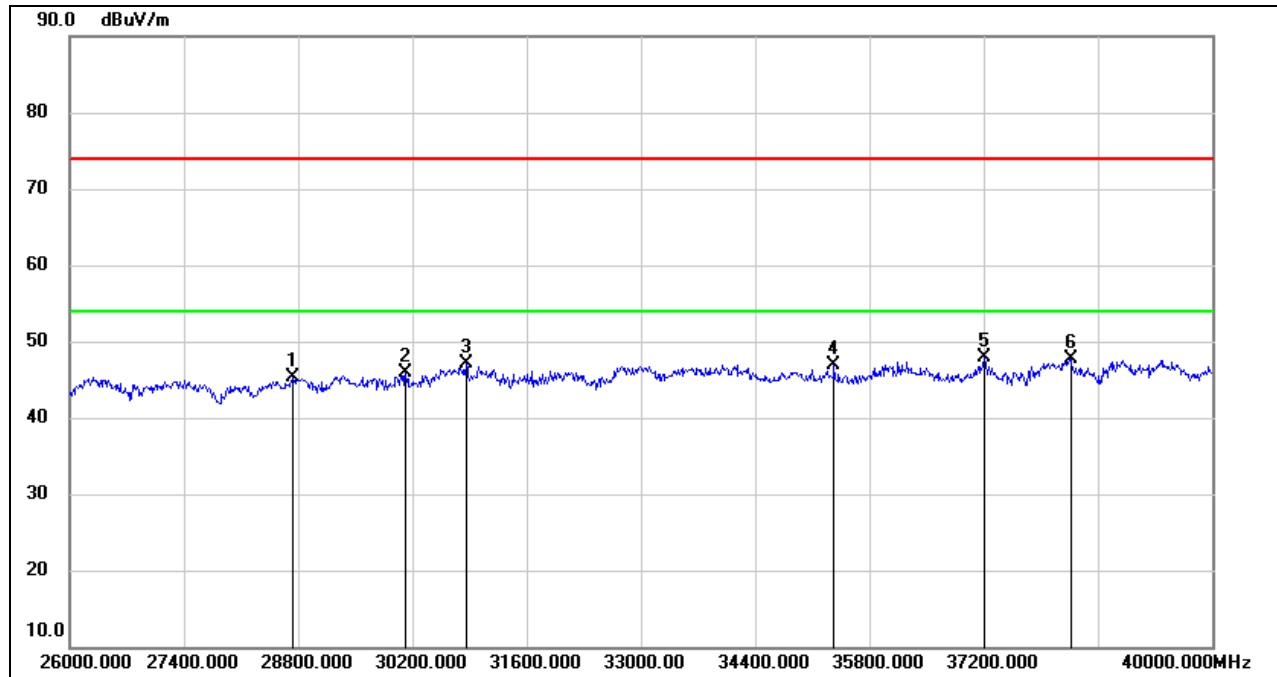

No.	Frequency (MHz)	Reading (dBuV)	Correct (dB/m)	Result (dBuV/m)	Limit (dBuV/m)	Margin (dB)	Remark
1	28730.000	45.94	-0.69	45.25	74.00	-28.75	peak
2	30116.000	47.13	-1.30	45.83	74.00	-28.17	peak
3	30858.000	48.00	-0.97	47.03	74.00	-26.97	peak
4	35366.000	44.40	2.59	46.99	74.00	-27.01	peak
5	37200.000	44.67	3.16	47.83	74.00	-26.17	peak
6	38264.000	43.90	3.84	47.74	74.00	-26.26	peak

- Note: 1. Measurement = Reading Level + Correct Factor.
 2. If Peak Result complies with AV limit, AV Result is deemed to comply with AV limit.
 3. Peak: Peak detector.
 4. Proper operation of the transmitter prior to adding the filter to the measurement chain.

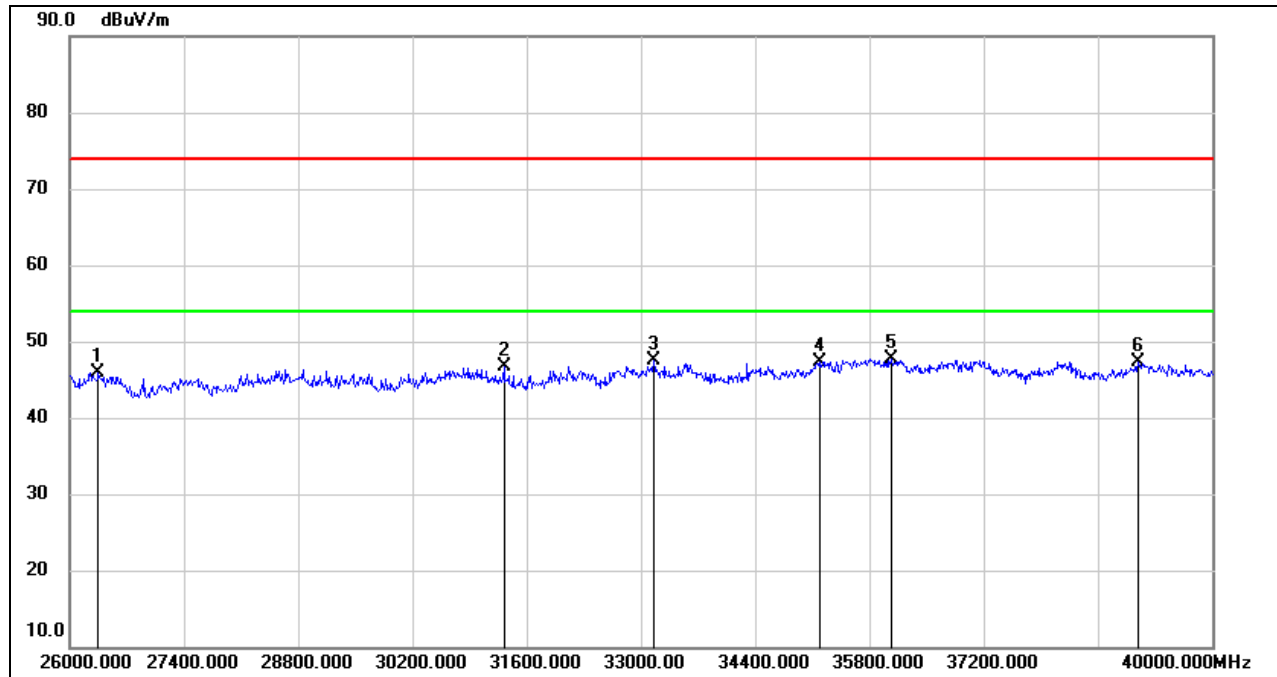
**HARMONICS AND SPURIOUS EMISSIONS (802.11a MODE UNII-2C MIDDLE CHANNEL, BT 8DQPSK MIDDLE, VERTICAL)**

No.	Frequency (MHz)	Reading (dBuV)	Correct (dB/m)	Result (dBuV/m)	Limit (dBuV/m)	Margin (dB)	Remark
1	26350.000	51.00	-5.11	45.89	74.00	-28.11	peak
2	31320.000	47.61	-0.93	46.68	74.00	-27.32	peak
3	33154.000	48.05	-0.54	47.51	74.00	-26.49	peak
4	35184.000	45.05	2.30	47.35	74.00	-26.65	peak
5	36066.000	43.85	3.83	47.68	74.00	-26.32	peak
6	39090.000	43.02	4.27	47.29	74.00	-26.71	peak

- Note: 1. Measurement = Reading Level + Correct Factor.
 2. If Peak Result complies with AV limit, AV Result is deemed to comply with AV limit.
 3. Peak: Peak detector.
 4. Proper operation of the transmitter prior to adding the filter to the measurement chain.

Note: All the modes and antennas had been tested, but only the worst data was recorded in the report.

8.7. SPURIOUS EMISSIONS (30 MHz ~ 1 GHz)

8.7.1. 802.11a MODE AND BT MODE WORST CASE

HARMONICS AND SPURIOUS EMISSIONS (802.11a MODE UNII-2C MIDDLE CHANNEL, BT 8DQPSK MIDDLE, HORIZONTAL)

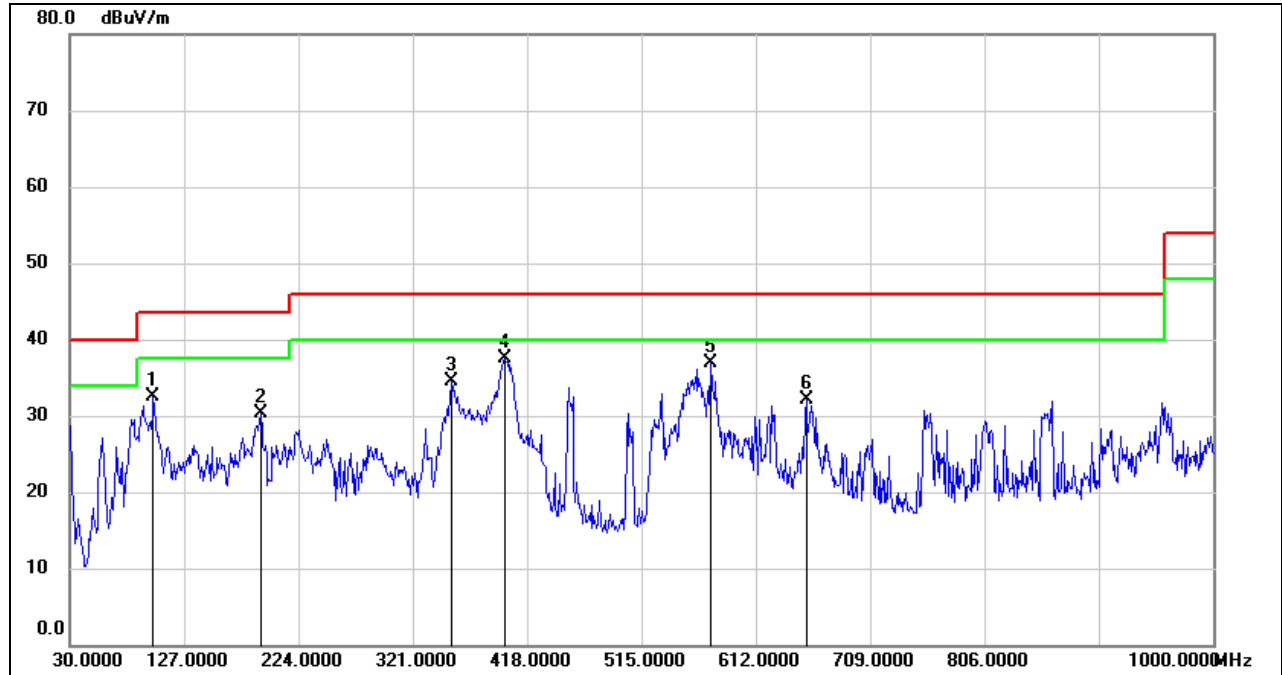

No.	Frequency (MHz)	Reading (dBuV)	Correct (dB/m)	Result (dBuV/m)	Limit (dBuV/m)	Margin (dB)	Remark
1	100.8100	53.60	-21.08	32.52	43.50	-10.98	QP
2	191.9900	46.85	-16.56	30.29	43.50	-13.21	QP
3	353.9800	48.66	-14.23	34.43	46.00	-11.57	QP
4	398.6000	50.86	-13.37	37.49	46.00	-8.51	QP
5	574.1700	47.03	-10.04	36.99	46.00	-9.01	QP
6	654.6800	41.03	-8.88	32.15	46.00	-13.85	QP

- Note: 1. Result Level = Read Level + Correct Factor.
 2. If Peak Result complies with QP limit, QP Result is deemed to comply with QP limit.
 3. Test setup: RBW: 120 kHz, VBW: 300 kHz, Sweep time: auto.



HARMONICS AND SPURIOUS EMISSIONS (802.11a MODE UNII-2C MIDDLE CHANNEL, BT 8DQPSK MIDDLE, VERTICAL)

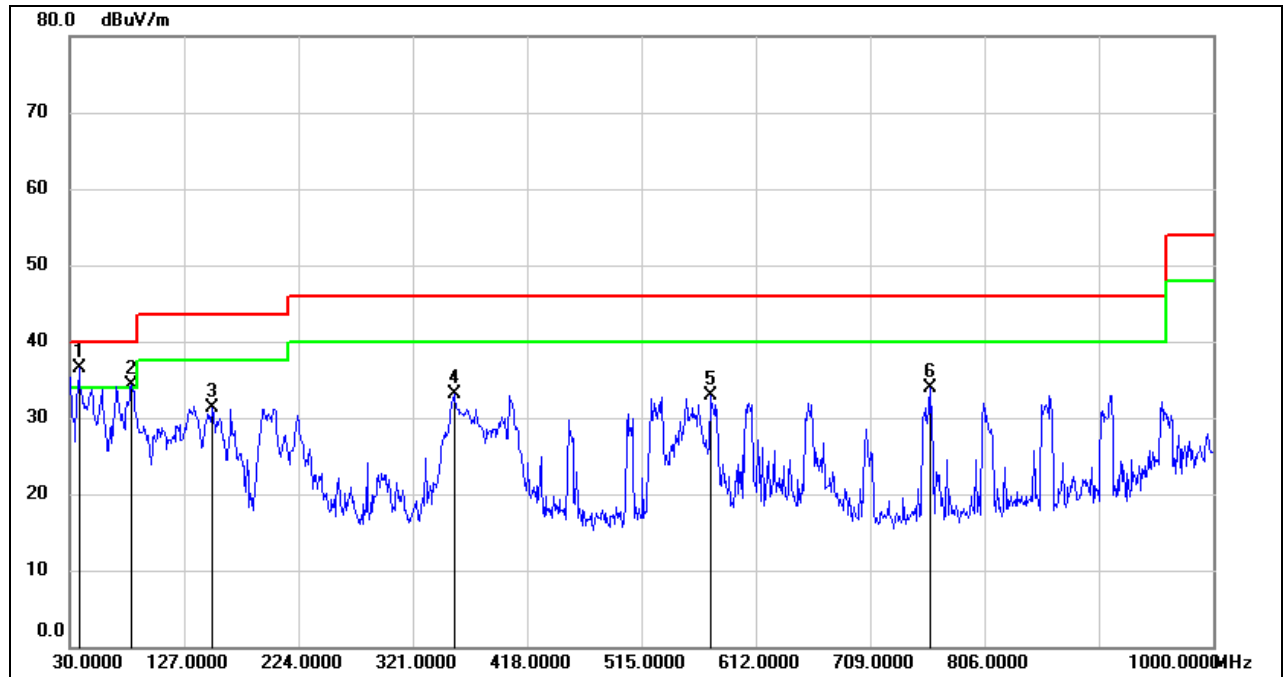

No.	Frequency (MHz)	Reading (dBuV)	Correct (dB/m)	Result (dBuV/m)	Limit (dBuV/m)	Margin (dB)	Remark
1	37.7599	56.16	-19.67	36.49	40.00	-3.51	QP
2	82.3800	55.75	-21.51	34.24	40.00	-5.76	QP
3	151.2500	49.54	-18.21	31.33	43.50	-12.17	QP
4	355.9200	47.26	-14.19	33.07	46.00	-12.93	QP
5	573.2000	42.99	-10.05	32.94	46.00	-13.06	QP
6	759.4400	41.63	-7.72	33.91	46.00	-12.09	QP

- Note: 1. Result Level = Read Level + Correct Factor.
 2. If Peak Result complies with QP limit, QP Result is deemed to comply with QP limit.
 3. Test setup: RBW: 120 kHz, VBW: 300 kHz, Sweep time: auto

Note: All the modes and antennas had been tested, but only the worst data was recorded in the report.

8.8. SPURIOUS EMISSIONS BELOW 30 MHz

8.8.1. 802.11a MODE AND BT MODE WORST CASE

HARMONICS AND SPURIOUS EMISSIONS (802.11a MODE UNII-2C MIDDLE CHANNEL, BT 8DQPSK MIDDLE, LOOP ANTENNA FACE ON TO THE EUT)

9 kHz~ 150 kHz

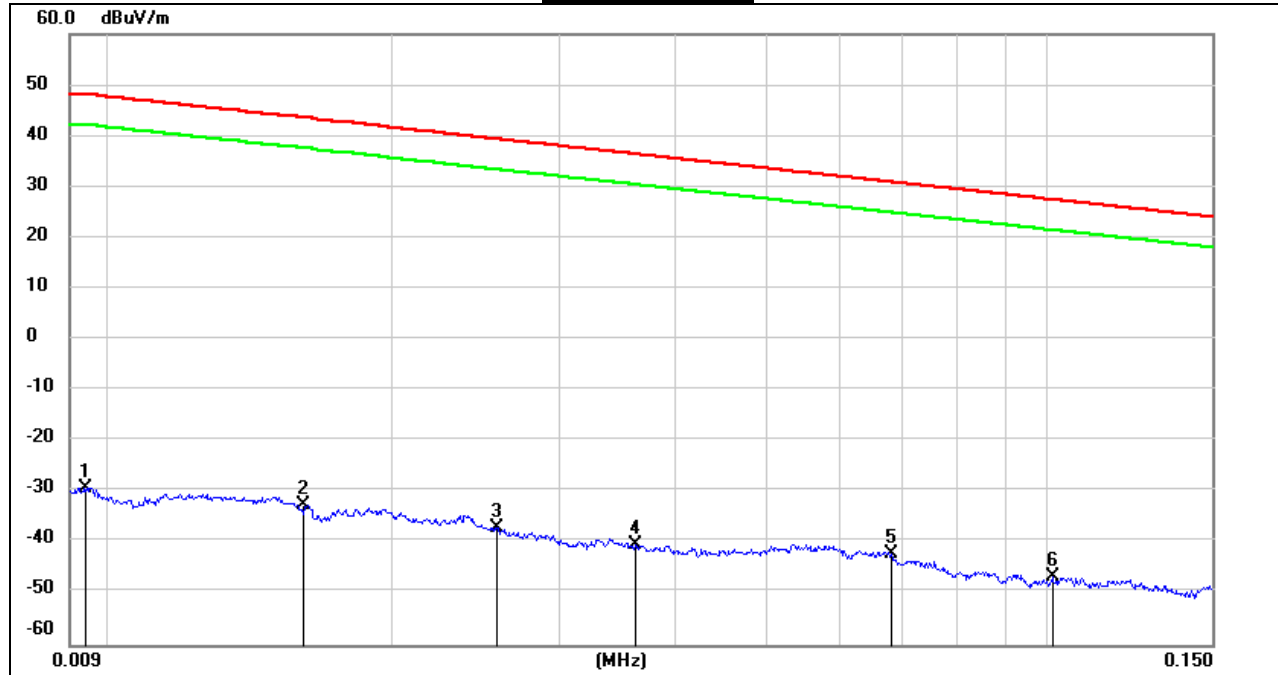

No.	Frequency (MHz)	Reading (dBuV)	Correct (dB/m)	FCC Result (dBuV/m)	FCC Limit (dBuV/m)	ISED Result (dBuA/m)	ISED Limit (dBuA/m)	Margin (dB)	Remark
1	0.0094	72.16	-101.35	-29.19	48.05	-80.69	-3.45	-77.24	peak
2	0.0160	68.91	-101.37	-32.46	43.52	-83.96	-7.98	-75.98	peak
3	0.0258	64.46	-101.37	-36.91	39.37	-88.41	-12.13	-76.28	peak
4	0.0362	61.01	-101.42	-40.41	36.43	-91.91	-15.07	-76.84	peak
5	0.0680	59.54	-101.56	-42.02	30.95	-93.52	-20.55	-72.97	peak
6	0.1014	55.06	-101.79	-46.73	27.48	-98.23	-24.02	-74.21	peak

Note: 1. Measurement = Reading Level + Correct Factor.

2. If Peak Result complies with AV and QP limit, AV and QP Result are deemed to comply with AV limit.

3. All 3 polarizations (Horizontal, Face-on and Face-off) of the loop antenna had been tested, but only the worst data recorded in the report.

4. $\text{dBuA/m} = \text{dBuV/m} - 20\log_{10}(120\pi) = \text{dBuV/m} - 51.5$.



150 kHz ~ 490 kHz

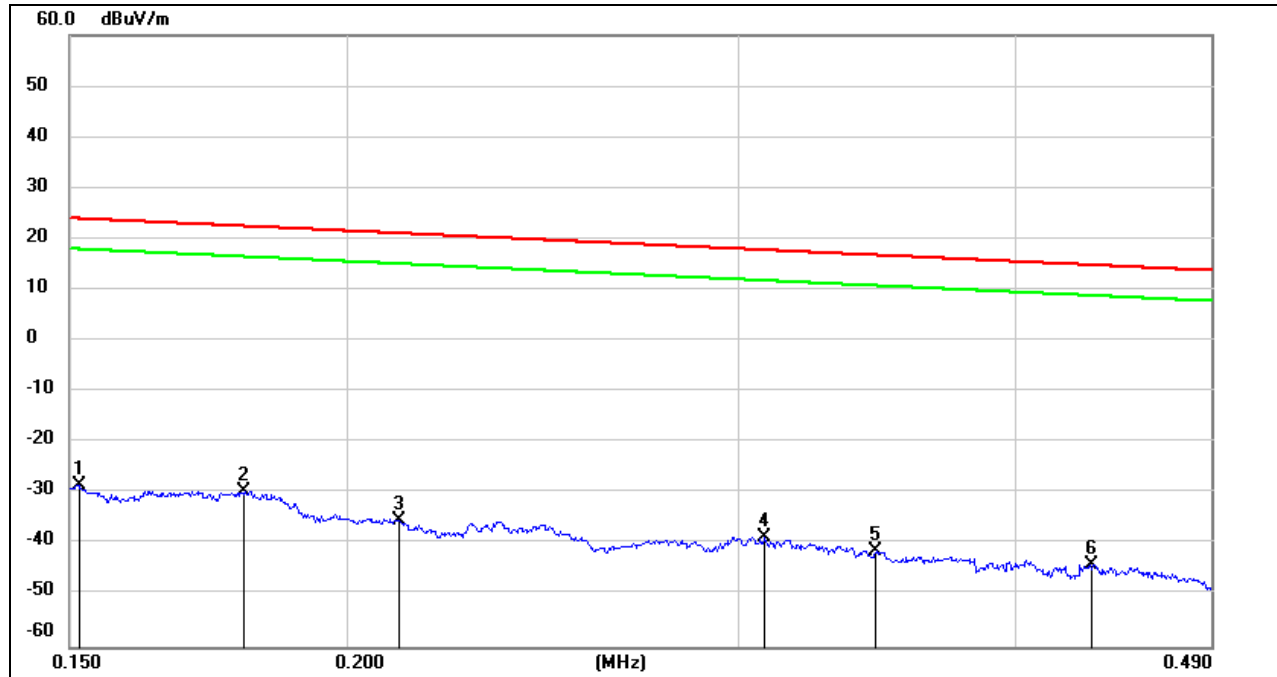

No.	Frequency (MHz)	Reading (dBuV)	Correct (dB/m)	FCC Result (dBuV/m)	FCC Limit (dBuV/m)	ISED Result (dBuA/m)	ISED Limit (dBuA/m)	Margin (dB)	Remark
1	0.1514	73.18	-101.63	-28.45	24	-79.95	-27.50	-52.45	peak
2	0.1800	72.12	-101.68	-29.56	22.5	-81.06	-29.00	-52.06	peak
3	0.2111	66.55	-101.73	-35.18	21.11	-86.68	-30.39	-56.29	peak
4	0.3084	63.45	-101.86	-38.41	17.82	-89.91	-33.68	-56.23	peak
5	0.3462	60.56	-101.90	-41.34	16.81	-92.84	-34.69	-58.15	peak
6	0.4329	58.07	-101.99	-43.92	14.87	-95.42	-36.63	-58.79	peak

- Note: 1. Measurement = Reading Level + Correct Factor.
 2. If Peak Result complies with AV and QP limit, AV and QP Result are deemed to comply with AV limit.
 3. All 3 polarizations (Horizontal, Face-on and Face-off) of the loop antenna had been tested, but only the worst data recorded in the report.
 4. $\text{dBuA/m} = \text{dBuV/m} - 20\log_{10}(120\pi) = \text{dBuV/m} - 51.5$.

490 kHz ~ 30 MHz

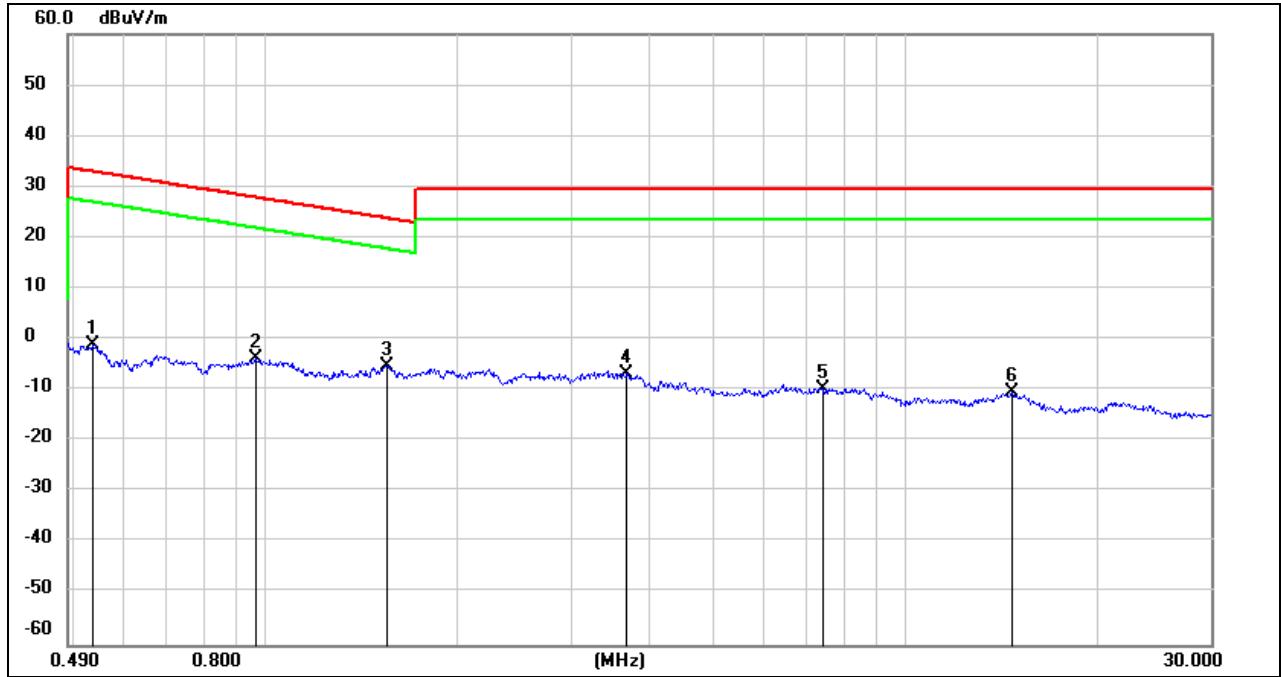

No.	Frequency (MHz)	Reading (dBuV)	Correct (dB/m)	FCC Result (dBuV/m)	FCC Limit (dBuV/m)	ISED Result (dBuA/m)	ISED Limit (dBuA/m)	Margin (dB)	Remark
1	0.5361	60.96	-62.08	-1.12	33.02	-52.62	-18.48	-34.14	peak
2	0.9622	58.47	-62.24	-3.77	27.94	-55.27	-23.56	-31.71	peak
3	1.5443	56.85	-62.03	-5.18	23.83	-56.68	-27.67	-29.01	peak
4	3.6770	54.54	-61.41	-6.87	29.54	-58.37	-21.96	-36.41	peak
5	7.4249	51.45	-61.15	-9.7	29.54	-61.20	-21.96	-39.24	peak
6	14.6843	50.53	-61.01	-10.48	29.54	-61.98	-21.96	-40.02	peak

Note: 1. Measurement = Reading Level + Correct Factor.

2. If Peak Result complies with AV and QP limit, AV and QP Result are deemed to comply with AV limit.

3. All 3 polarizations (Horizontal, Face-on and Face-off) of the loop antenna had been tested, but only the worst data recorded in the report.

4. $\text{dBuA/m} = \text{dBuV/m} - 20\log_{10}(120\pi) = \text{dBuV/m} - 51.5$.

Note: All the modes and antennas had been tested, but only the worst data was recorded in the report.

9. AC POWER LINE CONDUCTED EMISSIONS

LIMITS

Please refer to CFR 47 FCC §15.207 (a) and ISED RSS-Gen Clause 8.8

FREQUENCY (MHz)	Quasi-peak	Average
0.15 -0.5	66 - 56 *	56 - 46 *
0.50 -5.0	56.00	46.00
5.0 -30.0	60.00	50.00

TEST SETUP AND PROCEDURE

Refer to ANSI C63.10-2013 clause 6.2.

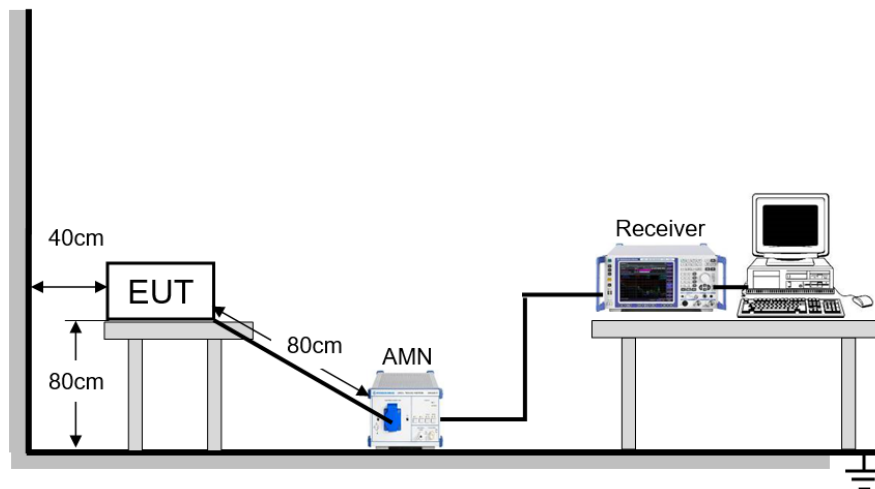

The EUT is put on a table of non-conducting material that is 80 cm high. The vertical conducting wall of shielding is located 40 cm to the rear of the EUT. The power line of the EUT is connected to the AC mains through a Artificial Mains Network (A.M.N.). A EMI Measurement Receiver (R&S Test Receiver ESR3) is used to test the emissions from both sides of AC line. According to the requirements in Section 6.2 of ANSI C63.10-2013. Conducted emissions from the EUT measured in the frequency range between 0.15 MHz and 30 MHz using CISPR Quasi-Peak and average detector mode. The bandwidth of EMI test receiver is set at 9 kHz.

The arrangement of the equipment is installed to meet the standards and operating in a manner, which tends to maximize its emission characteristics in a normal application.

TEST ENVIRONMENT

Temperature	24.1 °C	Relative Humidity	57.1 %
Atmosphere Pressure	101 kPa	Test Voltage	AC 120 V



TEST RESULTS

LINE L RESULTS (802.11a MODE UNII-2C MIDDLE CHANNEL, BT 8DQPSK MIDDLE, HORIZONTAL, WORST-CASE CONFIGURATION)

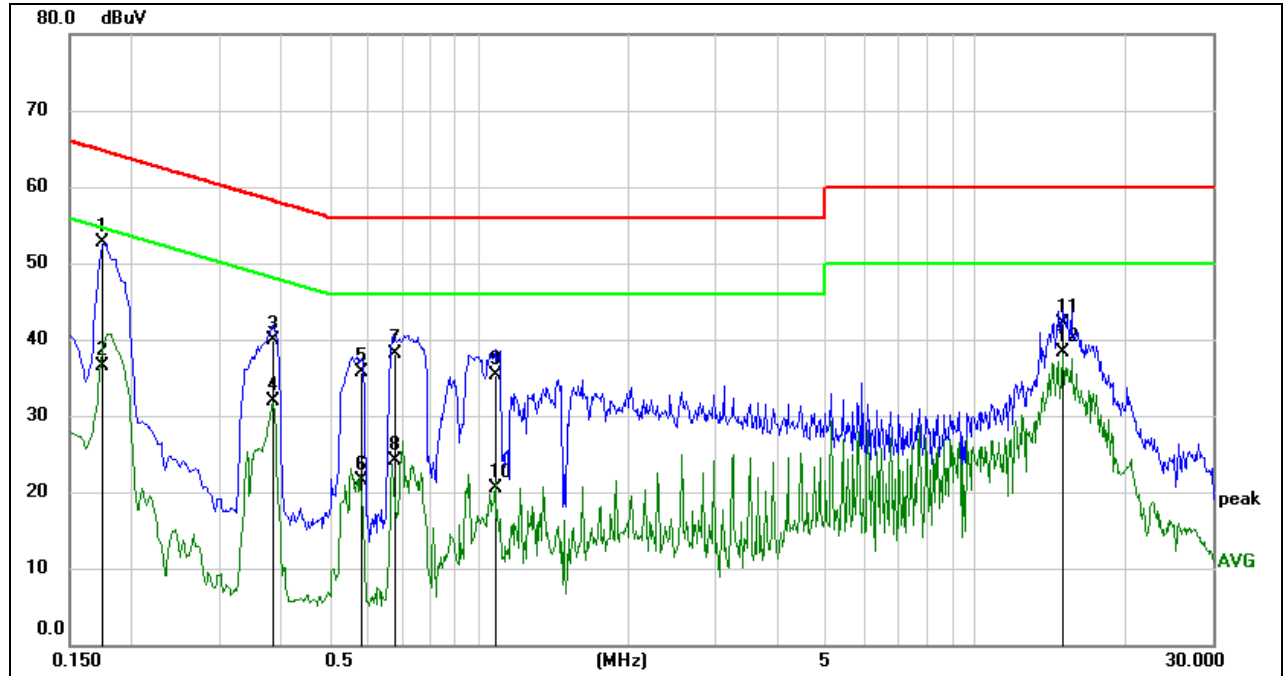

No.	Frequency (MHz)	Reading (dBuV)	Correct (dB)	Result (dBuV)	Limit (dBuV)	Margin (dB)	Remark
1	0.1732	43.07	9.59	52.66	64.81	-12.15	QP
2	0.1732	26.92	9.59	36.51	54.81	-18.30	AVG
3	0.3836	30.34	9.59	39.93	58.20	-18.27	QP
4	0.3836	22.39	9.59	31.98	48.20	-16.22	AVG
5	0.5799	26.03	9.60	35.63	56.00	-20.37	QP
6	0.5799	11.88	9.60	21.48	46.00	-24.52	AVG
7	0.6857	28.45	9.60	38.05	56.00	-17.95	QP
8	0.6857	14.56	9.60	24.16	46.00	-21.84	AVG
9	1.0801	25.61	9.61	35.22	56.00	-20.78	QP
10	1.0801	10.89	9.61	20.50	46.00	-25.50	AVG
11	14.9548	32.39	9.66	42.05	60.00	-17.95	QP
12	14.9548	28.58	9.66	38.24	50.00	-11.76	AVG

- Note: 1. Result = Reading +Correct Factor.
 2. If QP Result complies with AV limit, AV Result is deemed to comply with AV limit.
 3. Test setup: RBW: 200 Hz (9 kHz ~ 150 kHz), 9 kHz (150 kHz ~ 30 MHz).
 4. Step size: 80 Hz (0.009 MHz ~ 0.15 MHz), 4 kHz (0.15 MHz ~ 30 MHz), Scan time: auto.



LINE N RESULTS (802.11a MODE UNII-2C MIDDLE CHANNEL, BT 8DQPSK MIDDLE, HORIZONTAL, WORST-CASE CONFIGURATION)

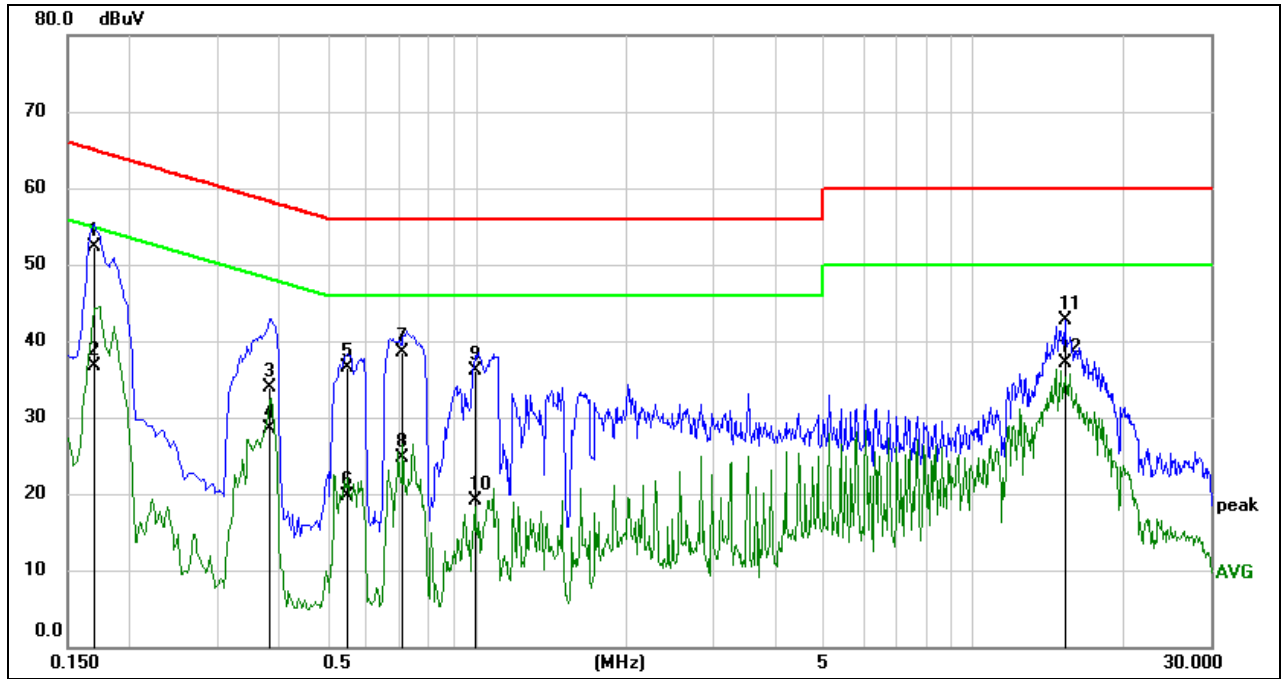

No.	Frequency (MHz)	Reading (dBuV)	Correct (dB)	Result (dBuV)	Limit (dBuV)	Margin (dB)	Remark
1	0.1686	42.71	9.59	52.30	65.03	-12.73	QP
2	0.1686	27.20	9.59	36.79	55.03	-18.24	AVG
3	0.3827	24.23	9.59	33.82	58.22	-24.40	QP
4	0.3827	18.93	9.59	28.52	48.22	-19.70	AVG
5	0.5488	26.86	9.60	36.46	56.00	-19.54	QP
6	0.5488	10.11	9.60	19.71	46.00	-26.29	AVG
7	0.7083	28.97	9.60	38.57	56.00	-17.43	QP
8	0.7083	15.18	9.60	24.78	46.00	-21.22	AVG
9	0.9911	26.45	9.61	36.06	56.00	-19.94	QP
10	0.9911	9.54	9.61	19.15	46.00	-26.85	AVG
11	15.2848	33.08	9.65	42.73	60.00	-17.27	QP
12	15.2848	27.47	9.65	37.12	50.00	-12.88	AVG

- Note: 1. Result = Reading +Correct Factor.
 2. If QP Result complies with AV limit, AV Result is deemed to comply with AV limit.
 3. Test setup: RBW: 200 Hz (9 kHz ~ 150 kHz), 9 kHz (150 kHz ~ 30 MHz).
 4. Step size: 80 Hz (0.009 MHz ~ 0.15 MHz), 4 kHz (0.15 MHz ~ 30 MHz), Scan time: auto.

Note: All the modes have been tested, only the worst data was recorded in the report.



10. ANTENNA REQUIREMENTS

APPLICABLE REQUIREMENTS

Please refer to FCC §15.203

An intentional radiator shall be designed to ensure that no antenna other than that furnished by the responsible party shall be used with the device. The use of a permanently attached antenna or of an antenna that uses a unique coupling to the intentional radiator shall be considered sufficient to comply with the provisions of this section. The manufacturer may design the unit so that a broken antenna can be replaced by the user, but the use of a standard antenna jack or electrical connector is prohibited.

Please refer to FCC §15.407(a)(1)(2)(3)

If transmitting antennas of directional gain greater than 6 dBi are used, both the maximum conducted output power and the maximum power spectral density shall be reduced by the amount in dB that the directional gain of the antenna exceeds 6 dBi..

RESULTS

Complies

END OF REPORT