



FCC TEST REPORT

According to

CFR47 §15.247

Applicant : Guangzhou Shikun Electronics Co., Ltd
Address : NO.6 Liankun Road,Huangpu District,Guangzhou,China
Manufacturer : Guangzhou Shikun Electronics Co., Ltd
Address : NO.6 Liankun Road,Huangpu District,Guangzhou,China
Equipment : IEEE 802.11a/b/g/n 2T2R USB Wi-Fi Module
Model No. : SKI.WB7638U.1_MT7638BU
Brand : N/A
FCC ID : 2AR82-SKIWB7638U1
Test Period : Dec. 17, 2019~Jan. 03, 2020

- The test result refers exclusively to the test presented test model / sample.
- Without written approval of **CerpPASS Technology (Suzhou) Co., Ltd.**, the test report shall not be reproduced exc- ept in full.
- The test report must not be used by the clients to claim product certification approval by any agency of the Government.

I **HEREBY** CERTIFY THAT :

The measurements shown in this test report were made in accordance with the procedures given in **ANSI C63.10 – 2013& FCC Part15.247** and the energy emitted by this equipment was **passed**.

Approved by:

Miro Chueh
EMC/RF Manager

Laboratory Accreditation:

CerpPASS Technology Corporation Test Laboratory



TAF LAB Code: 1439

CerpPASS Technology (SuZhou) Co., Ltd.



CNAS LAB Code: L5515



CONTENTS

1. Summary of Test Procedure and Test Results	5
1.1 Applicable Standards.....	5
2. Test Configuration of Equipment under Test	6
2.1 Feature of Equipment under Test.....	6
2.2 Carrier Frequency of Channels.....	6
2.3 Test Mode and Test Software.....	7
2.4 Description of Test System.....	7
2.5 General Information of Test.....	8
2.6 Measurement Uncertainty.....	9
2.7 Duty cycle.....	10
3. Test Equipment and Ancillaries Used for Tests	11
4. Antenna Requirements	12
4.1 Standard Applicable.....	12
4.2 Antenna Construction and Directional Gain.....	12
5. Test of AC Power Line Conducted Emission	13
5.1 Test Limit.....	13
5.2 Test Procedures.....	13
5.3 Typical Test Setup.....	13
5.4 Test Result and Data.....	14
6. Test of Spurious Emission (Radiated)	16
6.1 Test Limit.....	16
6.2 Test Procedures.....	16
6.3 Typical Test Setup.....	17
6.4 Test Result and Data (9KHz ~ 30MHz).....	18
6.5 Test Result and Data (30MHz ~ 1GHz).....	18
6.6 Test Result and Data (1GHz ~ 25GHz).....	19
6.7 Restricted Bands of Operation.....	31
6.8 Restrict Band Emission Measurement Data.....	32
7. Test of Spurious Emission (Conducted)	36
7.1 Test Limit.....	36
7.2 Test Procedure.....	36
7.3 Test Setup Layout.....	36
7.4 Test Result and Data.....	37
8. 6dB Bandwidth Measurement Data	46
8.1 Test Limit.....	46
8.2 Test Procedures.....	46
8.3 Test Setup Layout.....	46
8.4 Test Result and Data.....	46
9. Maximum Peak Output Power	51
9.1 Test Limit.....	51
9.2 Test Procedures.....	51
9.3 Test Setup Layout.....	51
9.4 Test Result and Data.....	52
10.Power Spectral Density	53



10.1 Test Limit 53
10.2 Test Procedures 53
10.3 Test Setup Layout..... 53
10.4 Test Result and Data 54



History of this Test Report

Report No.	Version	Issue Date	Description
SEFI2001042	Rev 01	Jan. 03, 2020	Original



1. Summary of Test Procedure and Test Results

1.1 Applicable Standards

FCC Rule	Description of Test	Result
FCC CFR Title 47 Part 15 Subpart C: Section 15.203/15.247 (b)	. Antenna Requirement	Pass
FCC CFR Title 47 Part 15 Subpart C: Section 15.207	. AC Power Line Conducted Emission	Pass
FCC CFR Title 47 Part 15 Subpart C: Section 15.205/15.209; Part2 section 2.1051, 2.1053, 2.1057	. Spurious Emission(Radiated)	Pass
FCC CFR Title 47 Part 15 Subpart C: Section 15.247(d); Part2 section 2.1051 and 2.1057	. Spurious Emission(Conducted)	Pass
FCC CFR Title 47 Part 15 Subpart C: Section 15.247(a)(2); Part2 section 2.1049	. 6dB Bandwidth	Pass
FCC CFR Title 47 Part 15 Subpart C: Section 15.247(b); Part2 section 2.1046	. Maximum Peak Output Power	Pass
FCC CFR Title 47 Part 15 Subpart C: Section 15.247(e)	. Power Spectral Density	Pass



2. Test Configuration of Equipment under Test

2.1 Feature of Equipment under Test

Equipment	IEEE 802.11a/b/g/n 2T2R USB Wi-Fi Module
Model No.	SKI.WB7638U.1_MT7638BU
Model Discrepancy	N/A
Power supply	Input: DC3.3V
Frequency Range	802.11b/g/n(20MHz): 2412-2462MHz 802.11n(40MHz): 2422-2452MHz
Spreading	802.11b: CCK, DQPSK, DBPSK 802.11g: 64 QAM, 16 QAM, QPSK, BPSK 802.11n: BPSK, QPSK, 16QAM, 64QAM
Number of Channels	802.11b/g/n (20MHz): 11 802.11n (40MHz): 7
Data Rate	802.11b: 1, 2, 5.5, 11Mbps 802.11g: 6, 9, 12, 18, 24, 36, 48, 54Mbps 802.11n: up to 300Mbps

Note: for more details, please refer to the User's manual of the EUT.

2.2 Carrier Frequency of Channels

802.11b, 802.11g, 802.11n HT 20 (2412MHz~2462MHz)

Channel	Frequency(MHz)	Channel	Frequency(MHz)
*01	2412	07	2442
02	2417	08	2447
03	2422	09	2452
04	2427	10	2457
05	2432	*11	2462
*06	2437	---	---

802.11an HT40(2422-2452MHz)

Channel	Frequency(MHz)	Channel	Frequency(MHz)
---	---	07	2442
---	---	08	2447
*03	2422	*09	2452
04	2427	---	---
05	2432	---	---
*06	2437	---	---

Note: Channels remarked * are selected to perform test.



2.3 Test Mode and Test Software

- a. During testing, the interface cables and equipment positions were varied according to ANSI C63.4.
- b. The complete test system included support units and EUT for the RF test.
- c. An executive program, "QATool_Dbg .exe" which transmits and receives data through Wireless.
- d. The EUT had been tested under operating condition
After verification, all tests were carried out with the worst case test modes as shown below except radiated spurious emission below 1GHz and power line conducted emissions below 30MHz, which worst case was in normal link mode only.
EUT staying in continuous transmitting mode was programmed.
- e. Test modes:
 - Mode 1: IEEE 802.11b
 - Mode 2: IEEE 802.11g
 - Mode 3: IEEE 802.11n HT20
 - Mode 4: IEEE 802.11n HT40

2.4 Description of Test System

No	Device	Manufacturer	Model No.	Description
1	Notebook	SONY	PCG-71811P	R33021
2	Adapter	FLYPOWER	PS65IBCAY5000H	N/A

Use Cable:

No.	Cable	Quantity	Description
A	DC Cable	1	1.6 m Non Shielding with one core
B	USB Cable	1	1.0m Shielding



2.5 General Information of Test

<input type="checkbox"/>	Test Site	CerpPASS Technology Corporation Test Laboratory Address: No.10, Ln. 2, Lianfu St., Luzhu Dist., Taoyuan City 33848, Taiwan (R.O.C.) Tel:+886-3-3226-888 Fax:+886-3-3226-881
	TAF	1439
	FCC	TW1079, TW1061
	IC	4934E-1, 4934E-2
	VCCI	T-2205 for Telecommunication Test C-4663 for Conducted emission test R-4399, R-4218 for Radiated emission test G-812, G-813 for radiated disturbance above 1GHz
<input checked="" type="checkbox"/>	Test Site	CerpPASS Technology (Suzhou) Co.,Ltd Address: No.66,Tangzhuang Road, Suzhou Industrial Park, Jiangsu 215006, China Tel: +86-512-6917-5888 Fax: +86-512-6917-5666
	CNAS	L5515
	FCC	CN1243
	A2LA	4981.01
	IC	7290A
VCCI	T-11945 for Telecommunication Test C-12919 for Conducted emission test R-12670 for Radiated emission test G-10227 for radiated disturbance above 1GHz	



2.6 Measurement Uncertainty

ISO/IEC 17025 requires that an estimate of the measurement uncertainties associated with the emissions test results be included in the report. The measurement uncertainties given below are based on a 95% confidence level (based on a coverage factor (k=2)).

Measurement Item	Measurement Frequency	Polarization	Uncertainty
Conducted Emission	9 kHz ~ 30 MHz	Line / Neutral	±2.9076 dB
Radiated Emission	9 kHz ~ 40,000 MHz	Vertical / Horizontal	±0.948 dB
Spurious Emission (Conducted)	-	-	±4.011 dB
Maximum Peak and Average Output Power	-	-	±0.322 dB
Power Spectral Density	-	-	±0.322 dB
Bandwidth	-	-	74.224Hz



2.7 Duty cycle

Test Item	Duty cycle
Test Date	Dec. 28, 2019

Mode	Frequency (MHz)	Measurement (%)
802.11b	2412	100
802.11g	2412	100
802.11n(20MHz)	2412	100
802.11n(40MHz)	2422	100

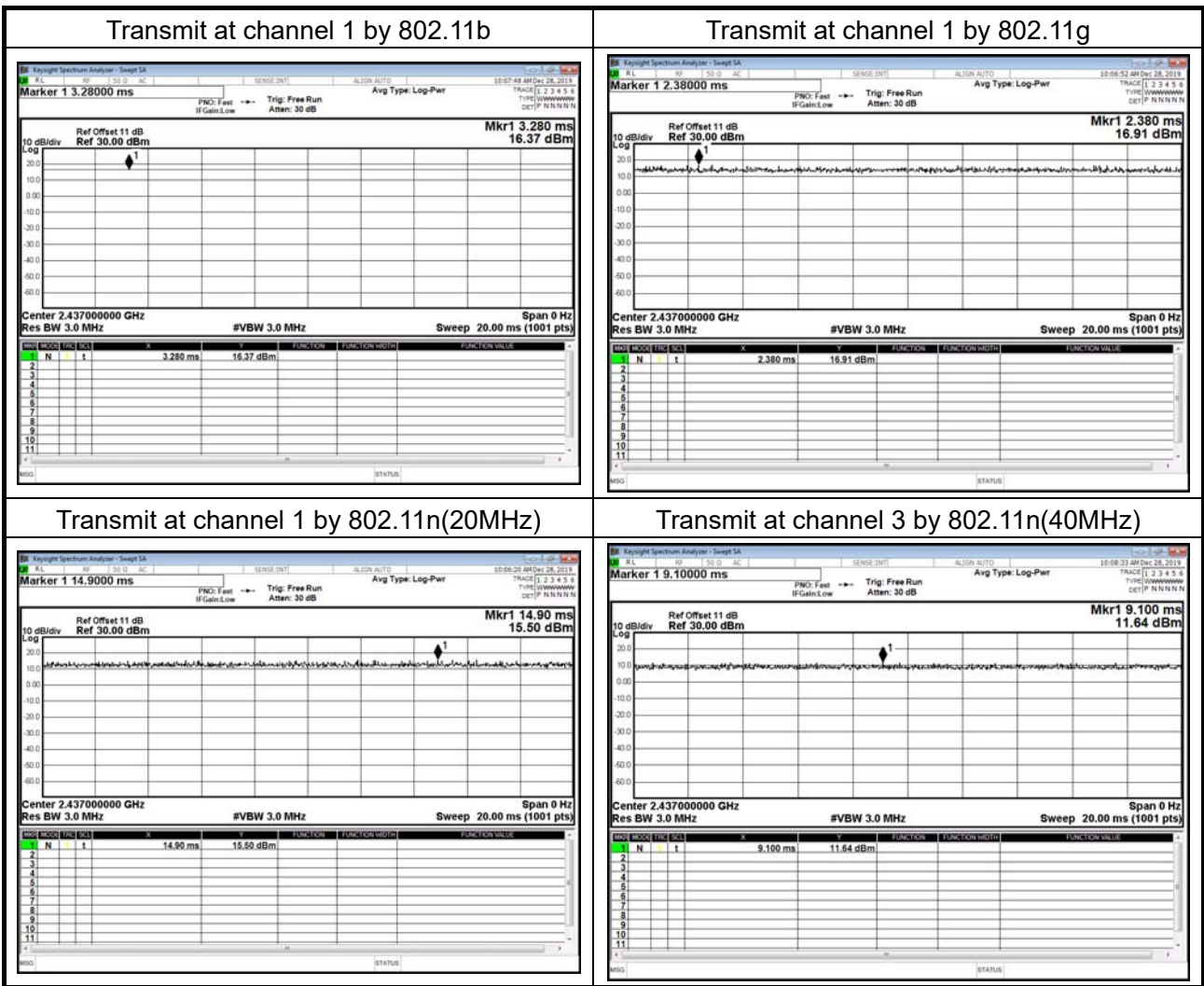



3. Test Equipment and Ancillaries Used for Tests

Instrument/Ancillary	Manufacturer	Model No.	Serial No.	Calibration Date	Valid Date.
EMI Receiver	R&S	ESCI3	100563	2019.06.21	2020.06.20
LISN	Schwarzbeck	NSLK 8127	8127-920	2019.08.22	2020.08.21
Pulse Limiter	R&S	ESH3-Z2	100529	2019.03.11	2020.03.10
Software	Farad	Ez-EMC	ver.ct3a1	N/A	N/A

Instrument/Ancillary	Manufacturer	Model No.	Serial No.	Calibration Date	Valid Date.
Bilog Antenna	Sunol	JB1	A072414-2 -2	2019.07.13	2020.07.13
EMI Receiver	R&S	ESCI3	101183	2019.06.28	2020.06.27
EMI Receiver	R&S	ESCI7	100968	2019.07.28	2020.07.27
Preamplifier	EM Electronics corp.	EM330	60618	2019.03.11	2020.03.10
Horn Antenna	Schwarzbeck	BBHA9120 D	9120D-619	2019.07.13	2020.07.13
Horn Antenna	Schwarzbeck	BBHA9170	9170-348	2019.06.23	2020.06.22
Spectrum Analyzer	R&S	FSP40	100324	2019.07.13	2020.07.12
Preamplifier	EMCI	EMCI 030-00-3230	SN016723	2019.03.11	2020.03.10
Preamplifier	EM Electronics corp.	EM01G18G	SN060714	2019.03.23	2020.03.22
Spectrum Analyzer	KEYSIGHT	N9010A	MY53400169	2019.08.22	2020.08.21
Software	E3	AUDIX	Version: 8.14.806b	N/A	N/A



4. Antenna Requirements

4.1 Standard Applicable

For intentional device, according to FCC 47 CFR Section 15.203, an intentional radiator shall be designed to ensure that no antenna other than that furnished by the responsible party shall be used with the device.

And according to FCC 47 CFR Section 15.247 (b), if transmitting antennas of directional gain greater than 6dBi are used, the power shall be reduced by the amount in dB that the directional gain of the antenna exceeds 6dBi.

4.2 Antenna Construction and Directional Gain

No.	Antenna Type	Antenna Gain
1	PIFA Antenna	Chain1: 1.5dBi Chain2: 1.5dBi



5. Test of AC Power Line Conducted Emission

5.1 Test Limit

Conducted Emissions were measured from 150 kHz to 30 MHz with a bandwidth of 9 KHz on the 120 VAC power and return leads of the EUT according to the methods defined in ANSI C63.10-2013. The EUT was placed on a nonmetallic stand in a shielded room 0.8 meters above the ground plane as shown in section 6.2.2. The interface cables and equipment positioning were varied within limits of reasonable applications to determine the position produced maximum conducted emissions.

Frequency (MHz)	Quasi Peak (dB μ V)	Average (dB μ V)
0.15 – 0.5	66-56*	56-46*
0.5 – 5.0	56	46
5.0 – 30.0	60	50

*Decreases with the logarithm of the frequency.

5.2 Test Procedures

The EUT was setup according to ANSI C63.10, 2013 and tested according to DTS test procedure of Oct 2014 KDB558074 for compliance to FCC 47CFR 15.247 requirements. The EUT was placed on a platform of nominal size, 1 m by 1.5 m, raised 80 cm above the conducting ground plane. The vertical conducting plane was located 40 cm to the rear of the EUT. All other surfaces of EUT were at least 80 cm from any other grounded conducting surface. The EUT and simulators are connected to the main power through a line impedance stabilization network (LISN). The LISN provides a 50 ohm /50uH coupling impedance for the measuring equipment. The peripheral devices are also connected to the main power through a LISN. (Please refer to the block diagram of the test setup and photographs) Each current-carrying conductor of the EUT power cord, except the ground (safety) conductor, was individually connected through a LISN to the input power source. The excess length of the power cord between the EUT and the LISN receptacle were folded back and forth at the center of the lead to form a bundle not exceeding 40 cm in length. Conducted emissions were investigated over the frequency range from 0.15MHz to 30MHz using a receiver bandwidth of 9kHz.

5.3 Typical Test Setup

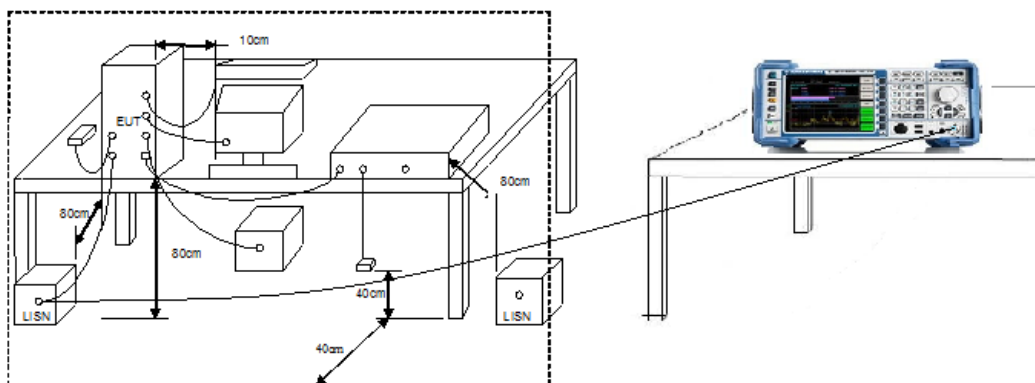



5.4 Test Result and Data

Test Mode :	Normal Link		
AC Power :	AC 120V/60Hz	Phase:	LINE
Temperature :	26°C	Humidity:	60%
Pressure(mbar) :	1002	Date:	2020-01-02

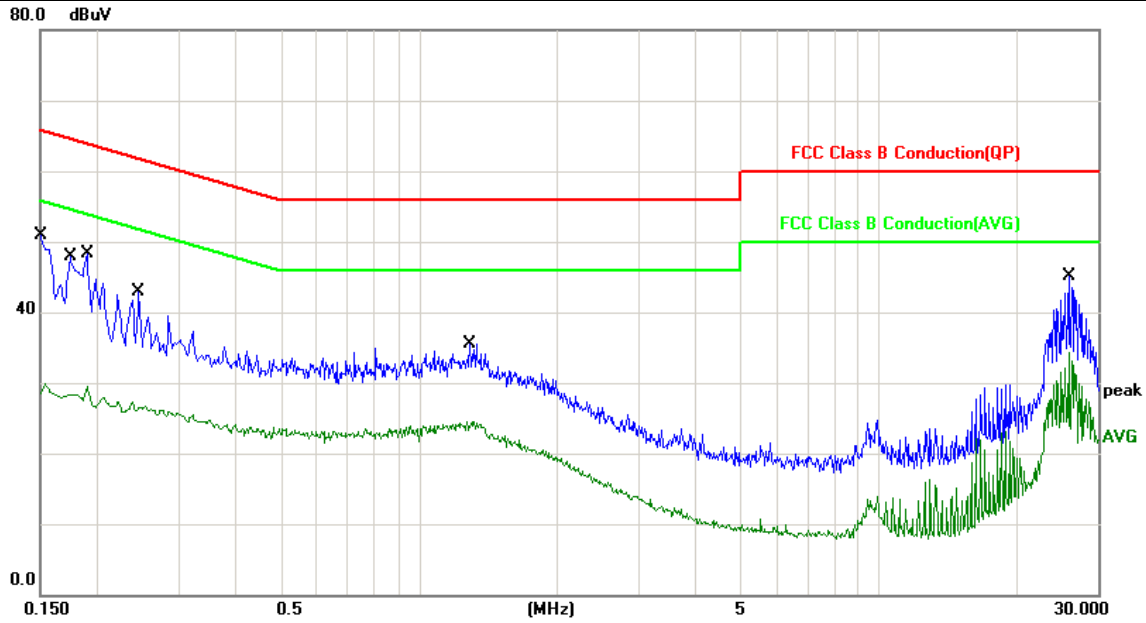

No.	Frequency (MHz)	Factor (dB)	Reading (dBuV)	Level (dBuV)	Limit (dBuV)	Margin (dB)	Detector
1	0.1500	10.06	34.08	44.14	65.99	-21.85	QP
2	0.1500	10.06	18.58	28.64	55.99	-27.35	AVG
3	0.1740	10.06	31.58	41.64	64.76	-23.12	QP
4	0.1740	10.06	17.89	27.95	54.76	-26.81	AVG
5	0.1900	10.06	28.48	38.54	64.03	-25.49	QP
6	0.1900	10.06	17.31	27.37	54.03	-26.66	AVG
7	0.2460	10.03	24.41	34.44	61.89	-27.45	QP
8	0.2460	10.03	16.40	26.43	51.89	-25.46	AVG
9	1.2900	10.40	18.36	28.76	56.00	-27.24	QP
10	1.2900	10.40	13.30	23.70	46.00	-22.30	AVG
11	25.9140	10.61	25.83	36.44	60.00	-23.56	QP
12	25.9140	10.61	19.04	29.65	50.00	-20.35	AVG

Note: Measurement Level = Reading Level + Correct Factor



Test Mode :	Normal Link		
AC Power :	AC 120V/60Hz	Phase:	NEUTRAL
Temperature :	26°C	Humidity:	60%
Pressure(mbar) :	1002	Date:	2020-01-02

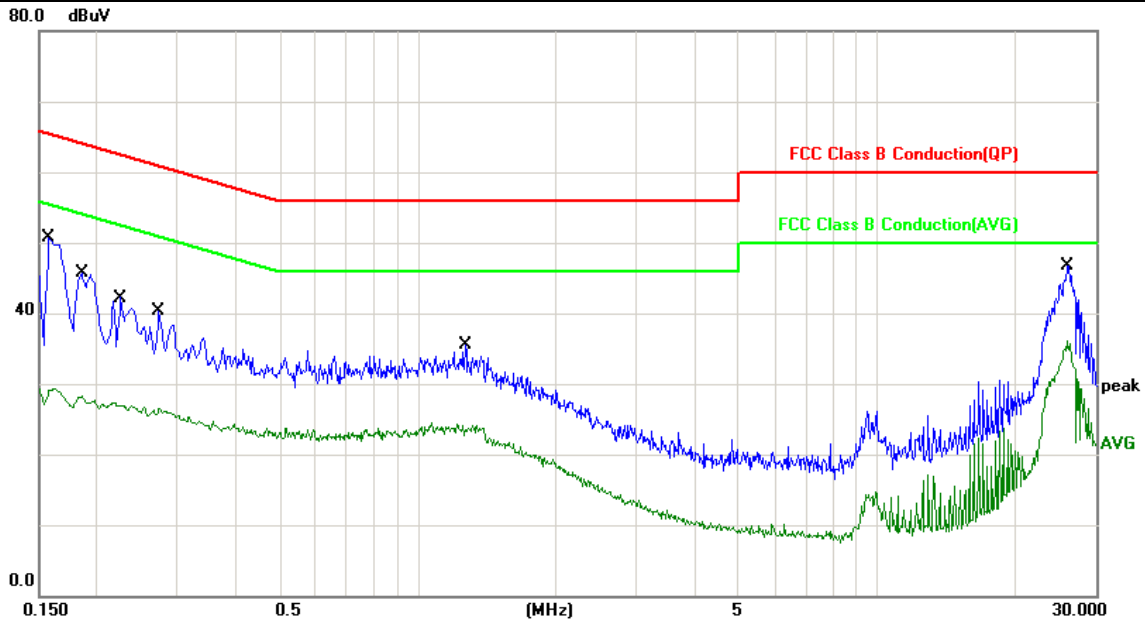

No.	Frequency (MHz)	Factor (dB)	Reading (dBuV)	Level (dBuV)	Limit (dBuV)	Margin (dB)	Detector
1	0.1580	10.06	33.01	43.07	65.56	-22.49	QP
2	0.1580	10.06	18.28	28.34	55.56	-27.22	AVG
3	0.1860	10.06	27.81	37.87	64.21	-26.34	QP
4	0.1860	10.06	17.36	27.42	54.21	-26.79	AVG
5	0.2260	10.05	24.67	34.72	62.59	-27.87	QP
6	0.2260	10.05	16.64	26.69	52.59	-25.90	AVG
7	0.2740	10.02	22.12	32.14	60.99	-28.85	QP
8	0.2740	10.02	15.79	25.81	50.99	-25.18	AVG
9	1.2700	10.14	18.35	28.49	56.00	-27.51	QP
10	1.2700	10.14	13.14	23.28	46.00	-22.72	AVG
11	26.0100	10.61	25.48	36.09	60.00	-23.91	QP
12	26.0100	10.61	16.91	27.52	50.00	-22.48	AVG

Note: Measurement Level = Reading Level + Correct Factor



6. Test of Spurious Emission (Radiated)

6.1 Test Limit

In any 100kHz bandwidth outside the frequency band in which the spread spectrum or digitally modulated intentional radiator is operating, the radio frequency power that is produced by the intentional radiator shall be at least 20dB below that in the 100kHz bandwidth within the band that contains the highest level of the desired power, based on either an RF conducted or a radiated measurement. If the transmitter measurement is based on the maximum conducted output power, the attenuation required under this paragraph shall be 30dB instead of 20dB. In addition, radiated emissions which fall in section 15.205(a) the restricted bands must also comply with the radiated emission limit specified in section 15.209(a).

FREQUENCIES(MHz)	FIELD STRENGTH (microvolts/meter)	MEASUREMENT DISTANCE(meters)
0.009~0.490	2400/F(kHz)	300
0.490~1.705	24000/F(kHz)	30
1.705~30.0	30	30
30~88	100	3
88~216	150	3
216~960	200	3
Above 960	500	3

6.2 Test Procedures

- The EUT was placed on a rotatable table top 0.8 meter for frequency below 1GHz and 1.5meter for frequency above 1GHz above ground.
- The EUT was set 3 meters from the interference receiving antenna which was mounted on the top of a variable height antenna tower.
- The table was rotated 360 degrees to determine the position of the highest radiation.
- The antenna is a broadband antenna and its height is varied between one meter and four meters above ground to find the maximum value of the field strength both horizontal polarization and vertical polarization of the antenna are set to make the measurement.
- For each suspected emission the EUT was arranged to its worst case and then tune the antenna tower (from 1 M to 4 M) and turn table (from 0 degree to 360 degrees) to find the maximum reading.
- Set the test-receiver system to Peak or CISPR quasi-peak Detect Function and specified bandwidth with Maximum Hold Mode.
- If the emission level of the EUT in peak mode was 3 dB lower than the limit specified, then testing will be stopped and peak values of EUT will be reported, otherwise, the emissions which do not have 3 dB margin will be repeated one by one using the quasi-peak method and reported.
- For testing above 1GHz, the emission level of the EUT in peak mode was 20dB lower than AVG limit (that means the emission level in peak mode also complies with the limit in AVG mode), then testing will be stopped and peak values of EUT will be reported, otherwise, the emissions will be measured in AVG mode again and reported.

6.3 Typical Test Setup

Below 30MHz Test Setup

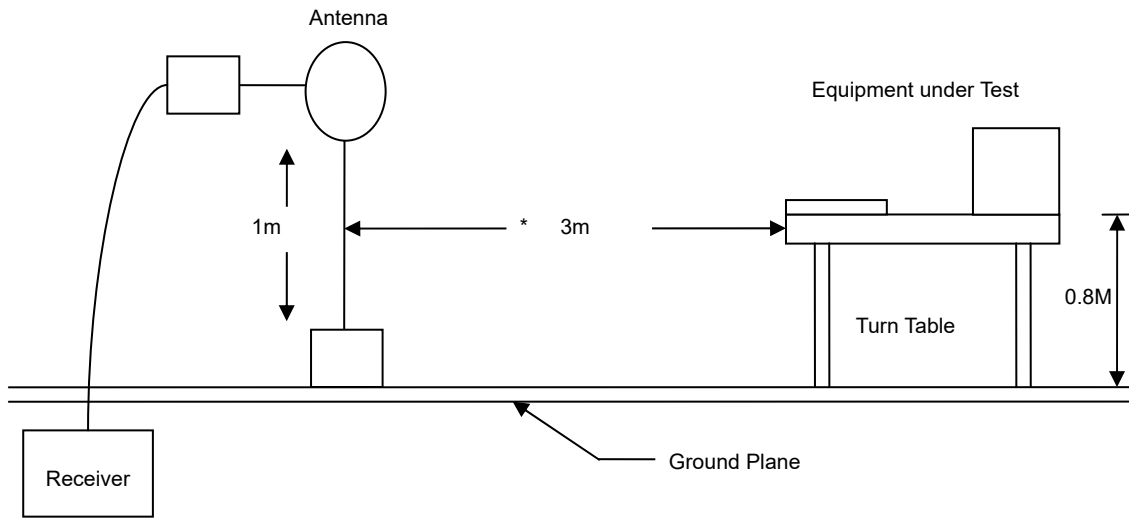

30M - 1GHz Test Setup

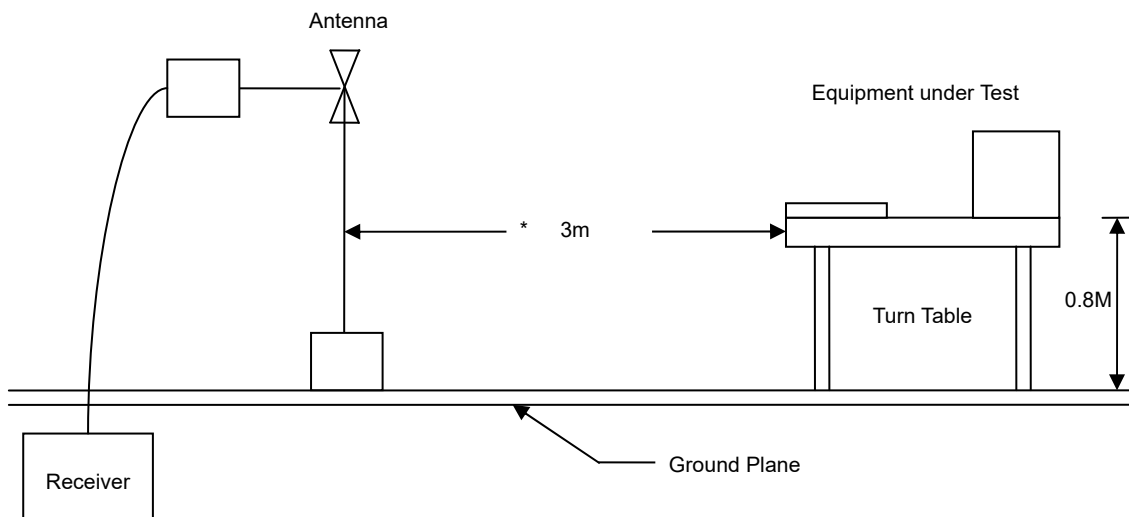

Above 1GHz Test Setup

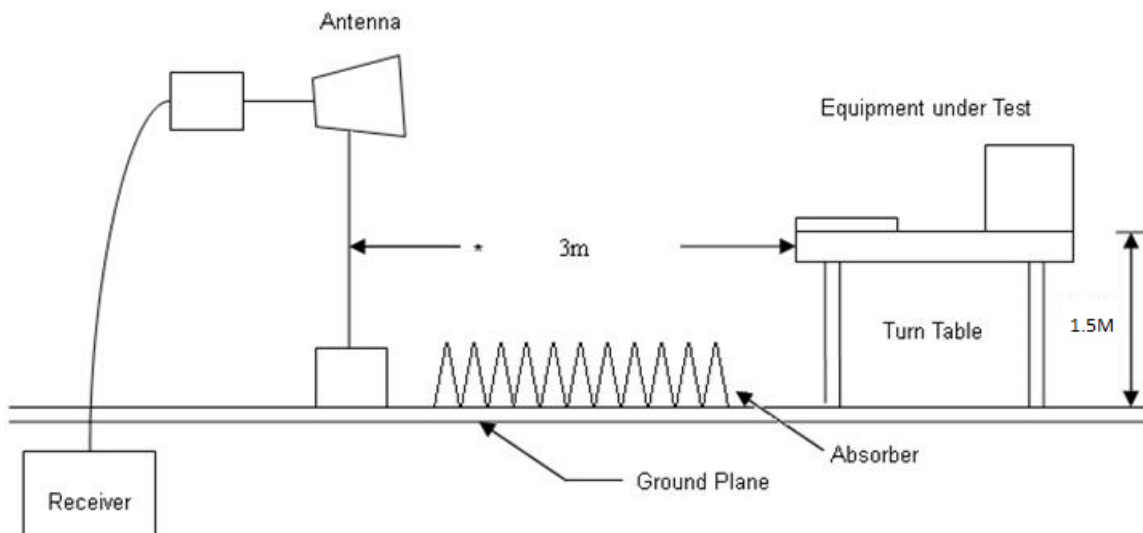



6.4 Test Result and Data (9KHz ~ 30MHz)

The 9kHz-30MHz spurious emission is under limit 20dB more.

6.5 Test Result and Data (30MHz ~ 1GHz)

Power	: DC 3.3V	Temperature	: 24 °C
Test Mode	: Normal Link	Humidity	: 54 %
Test date	: Jan. 02, 2020	Atmospheric Pressure	: 1010 hpa

Frequency (MHz)	Correct Factor (dB)	Reading level (dBuV)	Measure Level (dBuV/m)	Limit 3m (dBuV/m)	Safe Margin (dB)	Detector mode (PK/QP)	AntPol. H/V
70.7400	-17.52	50.87	33.35	40.00	-6.65	peak	H
181.3200	-9.92	47.05	37.13	43.50	-6.37	peak	H
188.1100	-10.26	46.20	35.94	43.50	-7.56	peak	H
234.6700	-7.34	45.58	38.24	46.00	-7.76	peak	H
295.7799	-7.69	40.91	33.22	46.00	-12.78	peak	H
479.1100	-1.96	35.43	33.47	46.00	-12.53	peak	H
34.8500	-8.57	41.65	33.08	40.00	-6.92	peak	V
70.7400	-17.52	51.21	33.69	40.00	-6.31	peak	V
143.4900	-12.97	44.18	31.21	43.50	-12.29	peak	V
182.2899	-12.25	46.69	34.44	43.50	-9.06	peak	V
294.8100	-10.01	40.02	30.01	46.00	-15.99	peak	V
455.8300	-4.03	37.66	33.63	46.00	-12.37	peak	V

Note: Level = Reading + Factor

Margin = Level – Limit

Factor= Antenna Factor + Cable Loss - Amplifier Factor

**6.6 Test Result and Data (1GHz ~ 25GHz)**

Power	: DC 3.3V	Temperature	: 24 °C
Test Mode1	802.11b (2412MHz)	Humidity	: 54 %
Test date	: Jan. 02, 2020	Atmospheric Pressure	: 1010 hpa

Frequency (MHz)	Correct Factor (dB)	Reading level (dBuV)	Measure Level (dBuV/m)	Limit 3m (dBuV/m)	Safe Margin (dB)	Detector mode (PK/AV)	AntPol. H/V
3266.667	-4.83	44.32	39.49	74.00	-34.51	peak	H
4088.333	-1.44	40.68	39.24	74.00	-34.76	peak	H
4824.000	1.27	44.58	45.85	74.00	-28.15	peak	H
6015.000	3.27	38.07	41.34	74.00	-32.66	peak	H
6440.000	3.44	37.34	40.78	74.00	-33.22	peak	H
7236.000	6.00	36.71	42.71	74.00	-31.29	peak	H
3351.667	-4.38	43.80	39.42	74.00	-34.58	peak	V
4201.667	-0.86	42.57	41.71	74.00	-32.29	peak	V
4824.000	1.27	44.26	45.53	74.00	-28.47	peak	V
5306.667	1.86	38.25	40.11	74.00	-33.89	peak	V
6383.333	3.41	38.05	41.46	74.00	-32.54	peak	V
7236.000	6.00	36.32	42.32	74.00	-31.68	peak	V

Note: Level = Reading + Factor

Margin = Level – Limit

Factor= Antenna Factor + Cable Loss - Amplifier Factor



Power	: DC 3.3V	Temperature	: 24 °C
Test Mode1	: 802.11b (2437MHz)	Humidity	: 54 %
Test date	: Jan. 02, 2020	Atmospheric Pressure	: 1010 hpa

Frequency (MHz)	Correct Factor (dB)	Reading level (dBuV)	Measure Level (dBuV/m)	Limit 3m (dBuV/m)	Safe Margin (dB)	Detector mode (PK/AV)	AntPol. H/V
3295.000	-4.68	43.94	39.26	74.00	-34.74	peak	H
4116.667	-1.29	41.96	40.67	74.00	-33.33	peak	H
4874.000	1.36	44.15	45.51	74.00	-28.49	peak	H
5561.667	2.17	37.89	40.06	74.00	-33.94	peak	H
6695.000	4.09	37.23	41.32	74.00	-32.68	peak	H
7311.000	6.29	36.24	42.53	74.00	-31.47	peak	H
3351.667	-4.38	44.87	40.49	74.00	-33.51	peak	V
4230.000	-0.72	41.94	41.22	74.00	-32.78	peak	V
4874.000	1.36	42.78	44.14	74.00	-29.86	peak	V
5080.000	1.67	38.05	39.72	74.00	-34.28	peak	V
6666.667	4.00	37.29	41.29	74.00	-32.71	peak	V
7311.000	6.29	36.19	42.48	74.00	-31.52	peak	V

Note: Level = Reading + Factor

Margin = Level – Limit

Factor= Antenna Factor + Cable Loss - Amplifier Factor



Power	: DC 3.3V	Temperature	: 24 °C
Test Mode1	: 802.11b (2462MHz)	Humidity	: 54 %
Test date	: Jan. 02, 2020	Atmospheric Pressure	: 1010 hpa

Frequency (MHz)	Correct Factor (dB)	Reading level (dBuV)	Measure Level (dBuV/m)	Limit 3m (dBuV/m)	Safe Margin (dB)	Detector mode (PK/AV)	AntPol. H/V
3408.333	-4.08	43.93	39.85	74.00	-34.15	peak	H
4230.000	-0.72	41.49	40.77	74.00	-33.23	peak	H
4924.000	1.46	43.20	44.66	74.00	-29.34	peak	H
5675.000	2.45	38.00	40.45	74.00	-33.55	peak	H
6355.000	3.40	36.92	40.32	74.00	-33.68	peak	H
7386.000	6.59	35.40	41.99	74.00	-32.01	peak	H
3493.333	-3.64	43.76	40.12	74.00	-33.88	peak	V
4088.333	-1.44	41.23	39.79	74.00	-34.21	peak	V
4924.000	1.46	42.56	44.02	74.00	-29.98	peak	V
5448.333	1.98	37.99	39.97	74.00	-34.03	peak	V
6355.000	3.40	37.56	40.96	74.00	-33.04	peak	V
7386.000	6.59	35.79	42.38	74.00	-31.62	peak	V

Note: Level = Reading + Factor

Margin = Level – Limit

Factor= Antenna Factor + Cable Loss - Amplifier Factor



Power	: DC 3.3V	Temperature	: 24 °C
Test Mode 2	: 802.11g (2412MHz)	Humidity	: 54 %
Test date	: Jan. 02, 2020	Atmospheric Pressure	: 1010 hpa

Frequency (MHz)	Correct Factor (dB)	Reading level (dBuV)	Measure Level (dBuV/m)	Limit 3m (dBuV/m)	Safe Margin (dB)	Detector mode (PK/AV)	AntPol. H/V
3521.667	-3.53	43.85	40.32	74.00	-33.68	peak	H
4230.000	-0.72	40.99	40.27	74.00	-33.73	peak	H
4824.000	1.27	41.71	42.98	74.00	-31.02	peak	H
5731.667	2.59	37.54	40.13	74.00	-33.87	peak	H
6100.000	3.30	37.51	40.81	74.00	-33.19	peak	H
7236.000	6.00	36.24	42.24	74.00	-31.76	peak	H
3521.667	-3.53	44.20	40.67	74.00	-33.33	peak	V
3946.667	-2.07	40.96	38.89	74.00	-35.11	peak	V
4824.000	1.27	42.11	43.38	74.00	-30.62	peak	V
5221.667	1.79	38.27	40.06	74.00	-33.94	peak	V
6468.333	3.45	36.99	40.44	74.00	-33.56	peak	V
7236.000	6.00	38.92	44.92	74.00	-29.08	peak	V

Note: Level = Reading + Factor

Margin = Level – Limit

Factor= Antenna Factor + Cable Loss - Amplifier Factor



Power	: DC 3.3V	Temperature	: 24 °C
Test Mode2	: 802.11g (2437MHz)	Humidity	: 54 %
Test date	: Jan. 02, 2020	Atmospheric Pressure	: 1010 hpa

Frequency (MHz)	Correct Factor (dB)	Reading level (dBuV)	Measure Level (dBuV/m)	Limit 3m (dBuV/m)	Safe Margin (dB)	Detector mode (PK/AV)	AntPol. H/V
3748.333	-2.75	42.21	39.46	74.00	-34.54	peak	H
4428.333	0.29	40.13	40.42	74.00	-33.58	peak	H
4874.000	1.36	41.53	42.89	74.00	-31.11	peak	H
5930.000	3.09	38.77	41.86	74.00	-32.14	peak	H
6411.667	3.42	37.98	41.40	74.00	-32.60	peak	H
7311.000	6.29	36.40	42.69	74.00	-31.31	peak	H
3691.667	-2.94	42.26	39.32	74.00	-34.68	peak	V
4315.000	-0.28	40.77	40.49	74.00	-33.51	peak	V
4874.000	1.36	42.35	43.71	74.00	-30.29	peak	V
5675.000	2.45	38.58	41.03	74.00	-32.97	peak	V
6270.000	3.37	39.40	42.77	74.00	-31.23	peak	V
7311.000	6.29	37.69	43.98	74.00	-30.02	peak	V

Note: Level = Reading + Factor

Margin = Level – Limit

Factor= Antenna Factor + Cable Loss - Amplifier Factor



Power	: DC 3.3V	Temperature	: 24 °C
Test Mode2	: 802.11g (2462MHz)	Humidity	: 54 %
Test date	: Jan. 02, 2020	Atmospheric Pressure	: 1010 hpa

Frequency (MHz)	Correct Factor (dB)	Reading level (dBuV)	Measure Level (dBuV/m)	Limit 3m (dBuV/m)	Safe Margin (dB)	Detector mode (PK/AV)	AntPol. H/V
3408.333	-4.08	43.61	39.53	74.00	-34.47	peak	H
4116.667	-1.29	40.92	39.63	74.00	-34.37	peak	H
4924.000	1.46	41.95	43.41	74.00	-30.59	peak	H
5618.333	2.31	38.88	41.19	74.00	-32.81	peak	H
6298.333	3.38	38.17	41.55	74.00	-32.45	peak	H
7386.000	6.59	37.18	43.77	74.00	-30.23	peak	H
3861.667	-2.36	42.53	40.17	74.00	-33.83	peak	V
4400.000	0.15	39.77	39.92	74.00	-34.08	peak	V
4924.000	1.46	41.35	42.81	74.00	-31.19	peak	V
6128.333	3.31	37.50	40.81	74.00	-33.19	peak	V
6610.000	3.82	38.76	42.58	74.00	-31.42	peak	V
7386.000	6.59	35.86	42.45	74.00	-31.55	peak	V

Note: Level = Reading + Factor

Margin = Level – Limit

Factor= Antenna Factor + Cable Loss - Amplifier Factor



Power	: DC 3.3V	Temperature	: 24 °C
Test Mode 3	802.11n HT20 (2412MHz)	Humidity	: 54 %
Test date	: Jan. 02, 2020	Atmospheric Pressure	: 1010 hpa

Frequency (MHz)	Correct Factor (dB)	Reading level (dBuV)	Measure Level (dBuV/m)	Limit 3m (dBuV/m)	Safe Margin (dB)	Detector mode (PK/AV)	AntPol. H/V
3238.333	-4.98	44.31	39.33	74.00	-34.67	peak	H
4371.667	0.01	40.89	40.90	74.00	-33.10	peak	H
4824.000	1.27	41.59	42.86	74.00	-31.14	peak	H
5618.333	2.31	38.88	41.19	74.00	-32.81	peak	H
6440.000	3.44	39.22	42.66	74.00	-31.34	peak	H
7236.000	6.00	36.11	42.11	74.00	-31.89	peak	H
3550.000	-3.43	42.73	39.30	74.00	-34.70	peak	V
4088.333	-1.44	41.45	40.01	74.00	-33.99	peak	V
4824.000	1.27	42.31	43.58	74.00	-30.42	peak	V
5788.333	2.74	39.33	42.07	74.00	-31.93	peak	V
6326.667	3.39	39.34	42.73	74.00	-31.27	peak	V
7236.000	6.00	37.79	43.79	74.00	-30.21	peak	V

Note: Level = Reading + Factor

Margin = Level – Limit

Factor= Antenna Factor + Cable Loss - Amplifier Factor



Power	: DC 3.3V	Temperature	: 24 °C
Test Mode 3	802.11n HT20 (2437MHz)	Humidity	: 54 %
Test date	: Jan. 02, 2020	Atmospheric Pressure	: 1010 hpa

Frequency (MHz)	Correct Factor (dB)	Reading level (dBuV)	Measure Level (dBuV/m)	Limit 3m (dBuV/m)	Safe Margin (dB)	Detector mode (PK/AV)	AntPol. H/V
3266.667	-4.83	43.43	38.60	74.00	-35.40	peak	H
3861.667	-2.36	41.47	39.11	74.00	-34.89	peak	H
4874.000	1.36	41.51	42.87	74.00	-31.13	peak	H
6128.333	3.31	39.21	42.52	74.00	-31.48	peak	H
6496.667	3.46	38.87	42.33	74.00	-31.67	peak	H
7311.000	6.29	36.22	42.51	74.00	-31.49	peak	H
3068.333	-5.87	45.99	40.12	74.00	-33.88	peak	V
4031.667	-1.73	43.06	41.33	74.00	-32.67	peak	V
4874.000	1.36	42.53	43.89	74.00	-30.11	peak	V
5958.333	3.16	38.79	41.95	74.00	-32.05	peak	V
6468.333	3.45	38.99	42.44	74.00	-31.56	peak	V
7311.000	6.29	37.25	43.54	74.00	-30.46	peak	V

Note: Level = Reading + Factor

Margin = Level – Limit

Factor= Antenna Factor + Cable Loss - Amplifier Factor



Power	: DC 3.3V	Temperature	: 24 °C
Test Mode 3	802.11n HT20 (2462MHz)	Humidity	: 54 %
Test date	: Jan. 02, 2020	Atmospheric Pressure	: 1010 hpa

Frequency (MHz)	Correct Factor (dB)	Reading level (dBuV)	Measure Level (dBuV/m)	Limit 3m (dBuV/m)	Safe Margin (dB)	Detector mode (PK/AV)	AntPol. H/V
3635.000	-3.14	42.91	39.77	74.00	-34.23	peak	H
4315.000	-0.28	39.22	38.94	74.00	-35.06	peak	H
4924.000	1.46	41.39	42.85	74.00	-31.15	peak	H
5901.667	3.02	39.71	42.73	74.00	-31.27	peak	H
6780.000	4.37	37.17	41.54	74.00	-32.46	peak	H
7386.000	6.59	35.95	42.54	74.00	-31.46	peak	H
3351.667	-4.38	45.28	40.90	74.00	-33.10	peak	V
3748.333	-2.75	42.34	39.59	74.00	-34.41	peak	V
4924.000	1.46	42.53	43.99	74.00	-30.01	peak	V
5958.333	3.16	38.29	41.45	74.00	-32.55	peak	V
6355.000	3.40	37.98	41.38	74.00	-32.62	peak	V
7386.000	6.59	36.75	43.34	74.00	-30.66	peak	V

Note: Level = Reading + Factor

Margin = Level – Limit

Factor= Antenna Factor + Cable Loss - Amplifier Factor



Power	: DC 3.3V	Temperature	: 24 °C
Test Mode 4	802.11n HT40 (2422MHz)	Humidity	: 54 %
Test date	: Jan. 02, 2020	Atmospheric Pressure	: 1010 hpa

Frequency (MHz)	Correct Factor (dB)	Reading level (dBuV)	Measure Level (dBuV/m)	Limit 3m (dBuV/m)	Safe Margin (dB)	Detector mode (PK/AV)	AntPol. H/V
3323.333	-4.53	44.11	39.58	74.00	-34.42	peak	H
4031.667	-1.73	41.62	39.89	74.00	-34.11	peak	H
4844.000	1.31	40.42	41.73	74.00	-32.27	peak	H
5760.000	2.66	37.81	40.47	74.00	-33.53	peak	H
6355.000	3.40	36.79	40.19	74.00	-33.81	peak	H
7266.000	6.12	36.49	42.61	74.00	-31.39	peak	H
3380.000	-4.23	44.01	39.78	74.00	-34.22	peak	V
4286.667	-0.43	40.76	40.33	74.00	-33.67	peak	V
4844.000	1.31	39.82	41.13	74.00	-32.87	peak	V
5618.333	2.31	39.18	41.49	74.00	-32.51	peak	V
6808.333	4.46	36.68	41.14	74.00	-32.86	peak	V
7266.000	6.12	37.31	43.43	74.00	-30.57	peak	V

Note: Level = Reading + Factor

Margin = Level – Limit

Factor= Antenna Factor + Cable Loss - Amplifier Factor



Power	: DC 3.3V	Temperature	: 24 °C
Test Mode 4	802.11n HT40 (2437MHz)	Humidity	: 54 %
Test date	: Jan. 02, 2020	Atmospheric Pressure	: 1010 hpa

Frequency (MHz)	Correct Factor (dB)	Reading level (dBuV)	Measure Level (dBuV/m)	Limit 3m (dBuV/m)	Safe Margin (dB)	Detector mode (PK/AV)	AntPol. H/V
3635.000	-3.14	44.42	41.28	74.00	-32.72	peak	H
4116.667	-1.29	41.09	39.80	74.00	-34.20	peak	H
4874.000	1.36	40.56	41.92	74.00	-32.08	peak	H
5760.000	2.66	38.31	40.97	74.00	-33.03	peak	H
6355.000	3.40	38.29	41.69	74.00	-32.31	peak	H
7311.000	6.29	36.85	43.14	74.00	-30.86	peak	H
3748.333	-2.75	42.34	39.59	74.00	-34.41	peak	V
4400.000	0.15	40.52	40.67	74.00	-33.33	peak	V
4874.000	1.36	39.63	40.99	74.00	-33.01	peak	V
6015.000	3.27	38.95	42.22	74.00	-31.78	peak	V
6355.000	3.40	39.10	42.50	74.00	-31.50	peak	V
7311.000	6.29	36.52	42.81	74.00	-31.19	peak	V

Note: Level = Reading + Factor

Margin = Level – Limit

Factor= Antenna Factor + Cable Loss - Amplifier Factor



Power	: DC 3.3V	Temperature	: 24 °C
Test Mode 4	802.11n HT40 (2452MHz)	Humidity	: 54 %
Test date	: Jan. 02, 2020	Atmospheric Pressure	: 1010 hpa

Frequency (MHz)	Correct Factor (dB)	Reading level (dBuV)	Measure Level (dBuV/m)	Limit 3m (dBuV/m)	Safe Margin (dB)	Detector mode (PK/AV)	AntPol. H/V
4031.667	-1.73	42.12	40.39	74.00	-33.61	peak	H
4541.667	0.74	40.17	40.91	74.00	-33.09	peak	H
4904.000	1.42	39.86	41.28	74.00	-32.72	peak	H
5420.000	1.95	39.08	41.03	74.00	-32.97	peak	H
6043.333	3.28	38.58	41.86	74.00	-32.14	peak	H
7356.000	6.47	36.24	42.71	74.00	-31.29	peak	H
3833.333	-2.46	41.89	39.43	74.00	-34.57	peak	V
4485.000	0.58	40.22	40.80	74.00	-33.20	peak	V
4904.000	1.42	39.87	41.29	74.00	-32.71	peak	V
5873.333	2.95	39.15	42.10	74.00	-31.90	peak	V
6411.667	3.42	38.11	41.53	74.00	-32.47	peak	V
7356.000	6.47	35.86	42.33	74.00	-31.67	peak	V

Note: Level = Reading + Factor

Margin = Level – Limit

Factor= Antenna Factor + Cable Loss - Amplifier Factor



6.7 Restricted Bands of Operation

Only spurious emissions are permitted in any of the frequency bands listed below:

MHz	MHz	MHz	GHz
0.09000 – 0.11000	16.42000 – 16.42300	399.9 – 410.0	4.500 – 5.250
0.49500 – 0.505**	16.69475 – 16.69525	608.0 – 614.0	5.350 – 5.460
2.17350 – 2.19050	16.80425 – 16.80475	960.0 – 1240.0	7.250 – 7.750
4.12500 – 4.12800	25.50000 – 25.67000	1300.0 – 1427.0	8.025 – 8.500
4.17725 – 4.17775	37.50000 – 38.25000	1435.0 – 1626.5	9.000 – 9.200
4.20725 – 4.20775	73.00000 – 74.60000	1645.5 – 1646.5	9.300 – 9.500
6.21500 – 6.21800	74.80000 – 75.20000	1660.0 – 1710.0	10.600 – 12.700
6.26775 – 6.26825	108.00000 – 121.94000	1718.8 – 1722.2	13.250 – 13.400
6.31175 – 6.31225	123.00000 – 138.00000	2200.0 – 2300.0	14.470 – 14.500
8.29100 – 8.29400	149.90000 – 150.05000	2310.0 – 2390.0	15.350 – 16.200
8.36200 – 8.36600	156.52475 – 156.52525	2483.5 – 2500.0	17.700 – 21.400
8.37625 – 8.38675	156.70000 – 156.90000	2655.0 – 2900.0	22.010 – 23.120
8.41425 – 8.41475	162.01250 – 167.17000	3260.0 – 3267.0	23.600 – 24.000
12.29000 – 12.29300	167.72000 – 173.20000	3332.0 – 3339.0	31.200 – 31.800
12.51975 – 12.52025	240.00000 – 285.00000	3345.8 – 3358.0	36.430 – 36.500
12.57675 – 12.57725	322.00000 – 335.40000	3600.0 – 4400.0	Above 38.6
13.36000 – 13.41000			

** : Until February 1, 1999, this restricted band shall be 0.490-0.510 MHz

**6.8 Restrict Band Emission Measurement Data**

Test Date: Dec. 29, 2019

Temperature: 26°C

Atmospheric pressure: 1018 hPa

Humidity: 47%

Modulation Standard: 802.11b

Channel 1				Fundamental Frequency: 2412 MHz			
Frequency (MHz)	Factor (dB/m)	Reading (dBuV)	Level (dBuV/m)	Limit (dBuV/m)	Margin (dB)	Det.	Ant-Pol H/V
2387.000	-10.07	63.49	53.42	74.00	-20.58	peak	H
2387.000	-10.07	59.55	49.48	54.00	-4.52	AVG	H
2390.000	-10.05	57.12	47.07	74.00	-26.93	peak	H
2390.000	-10.05	50.50	40.45	54.00	-13.55	AVG	H
2386.000	-10.07	64.11	54.04	74.00	-19.96	peak	V
2386.000	-10.07	59.18	49.11	54.00	-4.89	AVG	V
2390.000	-10.05	63.47	53.42	74.00	-20.58	peak	V
2390.000	-10.05	59.40	49.35	54.00	-4.65	AVG	V
Channel 11				Fundamental Frequency: 2462 MHz			
2483.500	-9.65	63.38	53.73	74.00	-20.27	peak	H
2483.500	-9.65	57.31	47.66	54.00	-6.34	AVG	H
2488.100	-9.63	62.63	53.00	74.00	-21.00	peak	H
2488.100	-9.63	57.96	48.33	54.00	-5.67	AVG	H
2483.500	-9.65	62.06	52.41	74.00	-21.59	peak	V
2483.500	-9.65	55.61	45.96	54.00	-8.04	AVG	V
2487.800	-9.63	62.97	53.34	74.00	-20.66	peak	V
2487.800	-9.63	58.83	49.20	54.00	-4.80	AVG	V

Notes:

1. Result = Meter Reading + Factor
2. Factor = Antenna Factor + Cable Loss – Amplifier
3. The resolution bandwidth of test receiver/spectrum analyzer is 1MHz and video bandwidth is 3 MHz (detector peak mode) for Peak detection at frequency above 1GHz.
4. The resolution bandwidth of test receiver/spectrum analyzer is 1MHz and video bandwidth is 3 MHz (detector sample mode) for Average detection at frequency above 1GHz.



Test Date: Dec. 29, 2019

Temperature: 26°C

Atmospheric pressure: 1018 hPa

Humidity: 47%

Modulation Standard: 802.11g

Channel 1				Fundamental Frequency: 2412 MHz			
Frequency (MHz)	Factor (dB/m)	Reading (dBuV)	Level (dBuV/m)	Limit (dBuV/m)	Margin (dB)	Det.	Ant-Pol H/V
2390.000	-10.05	76.48	66.43	74.00	-7.57	peak	H
2390.000	-10.05	61.27	51.22	54.00	-2.78	AVG	H
2390.000	-10.05	75.42	65.37	74.00	-8.63	peak	V
2390.000	-10.05	60.10	50.05	54.00	-3.95	AVG	V
Channel 11				Fundamental Frequency: 2462 MHz			
2483.500	-9.65	76.07	66.42	74.00	-7.58	peak	H
2483.500	-9.65	60.85	51.20	54.00	-2.80	AVG	H
2483.500	-9.65	74.98	65.33	74.00	-8.67	peak	V
2483.500	-9.65	59.74	50.09	54.00	-3.91	AVG	V

Notes:

1. Result = Meter Reading + Factor
2. Factor = Antenna Factor + Cable Loss – Amplifier
3. The resolution bandwidth of test receiver/spectrum analyzer is 1MHz and video bandwidth is 3 MHz (detector peak mode) for Peak detection at frequency above 1GHz.
4. The resolution bandwidth of test receiver/spectrum analyzer is 1MHz and video bandwidth is 3 MHz (detector sample mode) for Average detection at frequency above 1GHz.



Test Date: Jan. 02, 2020

Temperature: 26°C

Atmospheric pressure: 1018 hPa

Humidity: 47%

Modulation Standard: 802.11n HT20

Channel 1				Fundamental Frequency: 2412 MHz			
Frequency (MHz)	Factor (dB/m)	Reading (dBuV)	Level (dBuV/m)	Limit (dBuV/m)	Margin (dB)	Det.	Ant-Pol H/V
2390.000	-10.05	75.88	65.83	74.00	-8.17	peak	H
2390.000	-10.05	60.94	50.89	54.00	-3.11	AVG	H
2390.000	-10.05	75.33	65.28	74.00	-8.72	peak	V
2390.000	-10.05	60.39	50.34	54.00	-3.66	AVG	V
Channel 11				Fundamental Frequency: 2462 MHz			
2483.500	-9.65	75.58	65.93	74.00	-8.07	peak	H
2483.500	-9.65	60.34	50.69	54.00	-3.31	AVG	H
2483.500	-9.65	75.43	65.78	74.00	-8.22	peak	V
2483.500	-9.65	60.10	50.45	54.00	-3.55	AVG	V

Notes:

1. Result = Meter Reading + Factor
2. Factor = Antenna Factor + Cable Loss – Amplifier
3. The resolution bandwidth of test receiver/spectrum analyzer is 1MHz and video bandwidth is 3 MHz (detector peak mode) for Peak detection at frequency above 1GHz.
4. The resolution bandwidth of test receiver/spectrum analyzer is 1MHz and video bandwidth is 3 MHz (detector sample mode) for Average detection at frequency above 1GHz.



Test Date: Jan. 02, 2020

Temperature: 26°C

Atmospheric pressure: 1018 hPa

Humidity: 47%

Modulation Standard: 802.11n HT40

Channel 3				Fundamental Frequency: 2422 MHz			
Frequency (MHz)	Factor (dB/m)	Reading (dBuV)	Level (dBuV/m)	Limit (dBuV/m)	Margin (dB)	Det.	Ant-Pol H/V
2390.000	-10.05	74.51	64.46	74.00	-9.54	peak	H
2390.000	-10.05	61.18	51.13	54.00	-2.87	AVG	H
2390.000	-10.05	73.20	63.15	74.00	-10.85	peak	V
2390.000	-10.05	60.44	50.39	54.00	-3.61	AVG	V
Channel 9				Fundamental Frequency: 2452 MHz			
2483.500	-9.65	74.02	64.37	74.00	-9.63	peak	H
2483.500	-9.65	61.18	51.53	54.00	-2.47	AVG	H
2483.500	-9.65	73.96	64.31	74.00	-9.69	peak	V
2483.500	-9.65	60.77	51.12	54.00	-2.88	AVG	V

Notes:

1. Result = Meter Reading + Factor
2. Factor = Antenna Factor + Cable Loss – Amplifier
3. The resolution bandwidth of test receiver/spectrum analyzer is 1MHz and video bandwidth is 3 MHz (detector peak mode) for Peak detection at frequency above 1GHz.
4. The resolution bandwidth of test receiver/spectrum analyzer is 1MHz and video bandwidth is 3 MHz (detector sample mode) for Average detection at frequency above 1GHz.



7. Test of Spurious Emission (Conducted)

7.1 Test Limit

Below 30dB of the highest emission level of operating band (In 100 kHz Resolution Bandwidth)

7.2 Test Procedure

KDB 558074 D01v05r02

1. Reference level measurement

- (a) Set instrument center frequency to DTS channel center frequency
- (b) Set the span to ≥ 1.5 times the DTS bandwidth
- (c) Set the RBW = 100 kHz
- (d) Set the VBW $\geq 3 \times$ RBW
- (e) Detector = peak
- (f) Sweep time = auto couple
- (g) Trace mode = max hold
- (h) Allow trace to fully stabilize

2. Emission level measurement

- (a) Set the center frequency and span to encompass frequency range to be measured
- (b) RBW = 100kHz
- (c) VBW = 300kHz
- (d) Detector = Peak
- (e) Trace mode = max hold
- (f) Sweep time = auto couple
- (g) The trace was allowed to stabilize

7.3 Test Setup Layout

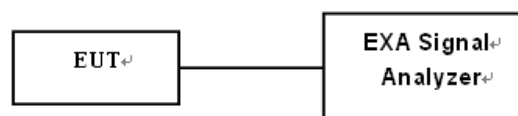



7.4 Test Result and Data

Test Date: Dec. 28, 2019

Temperature: 24°C

Atmospheric pressure: 1014 hPa

Humidity: 47%

Modulation Standard	Frequency (MHz)	Test Result
802.11b	2412	Pass
	2437	Pass
	2462	Pass
802.11g	2412	Pass
	2437	Pass
	2462	Pass
802.11n HT20	2412	Pass
	2437	Pass
	2462	Pass
802.11n HT40	2422	Pass
	2437	Pass
	2452	Pass

Note: Test plots refer to the following pages.



Chain 1
Modulation Type: 802.11b
CH01

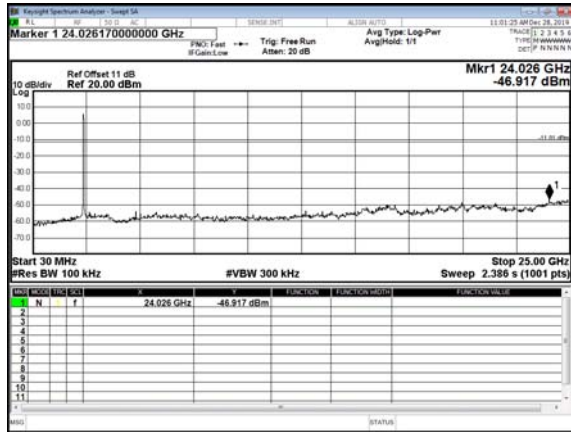

CH06

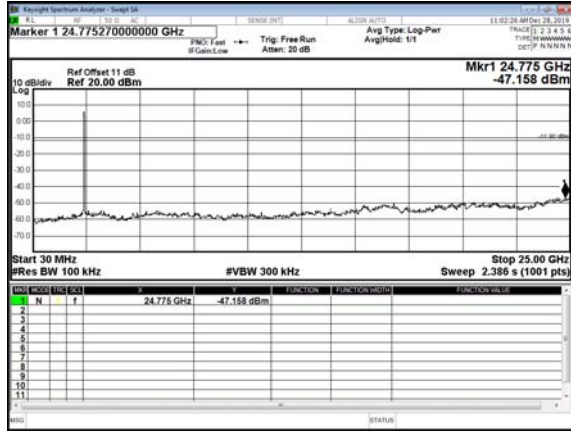
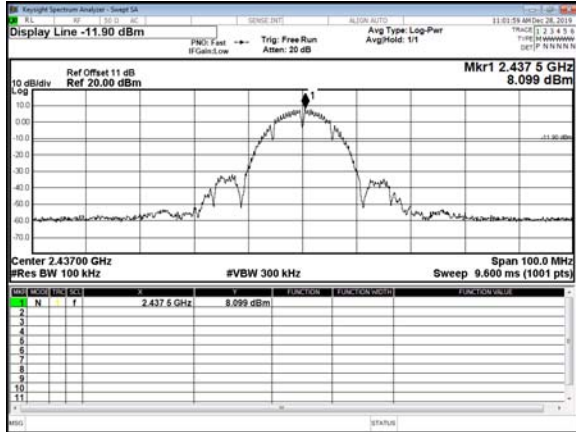

CH11

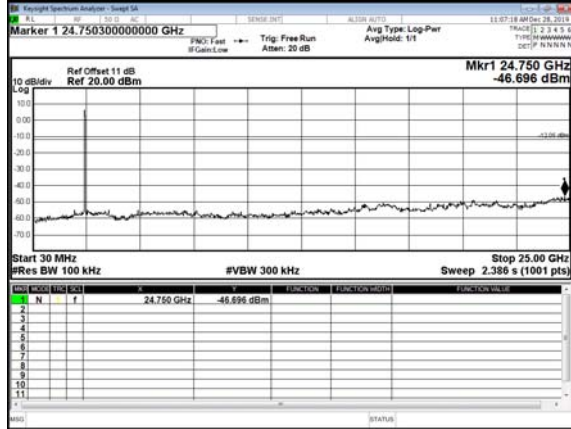
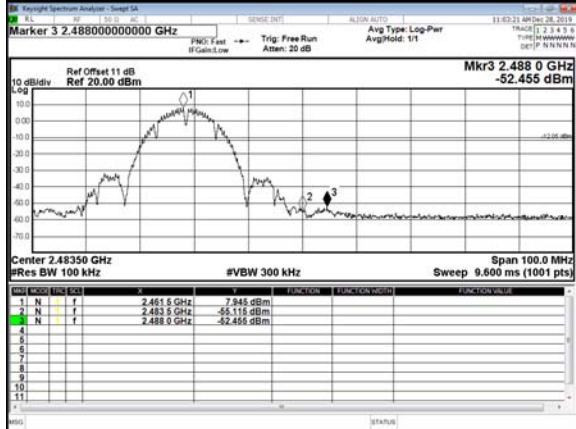



Modulation Type: 802.11g
CH01

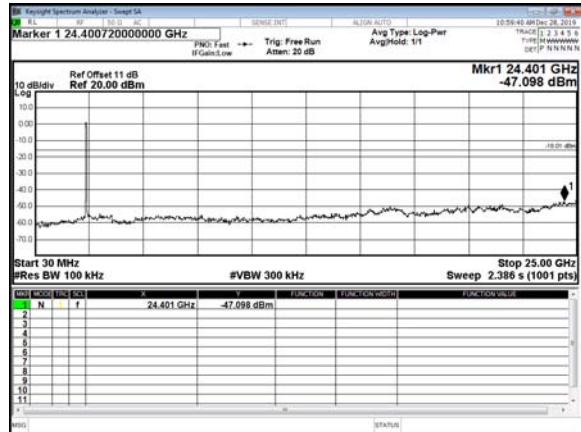
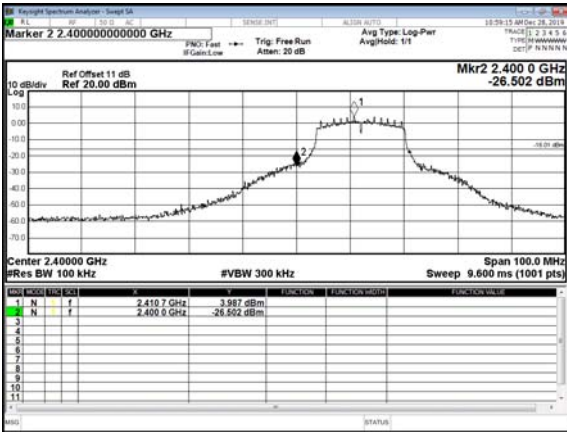

CH06

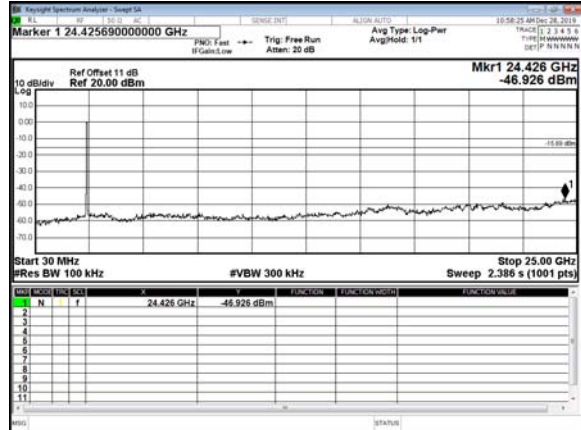
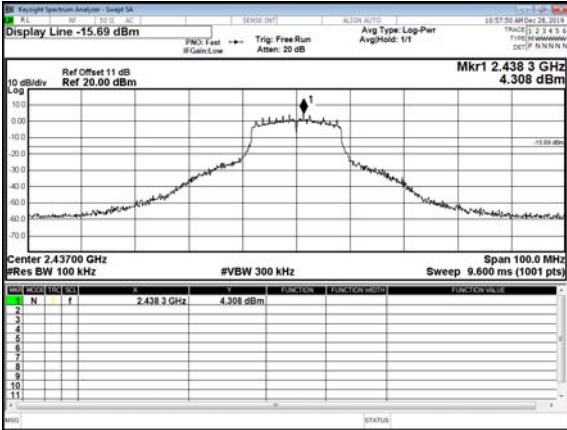

CH11

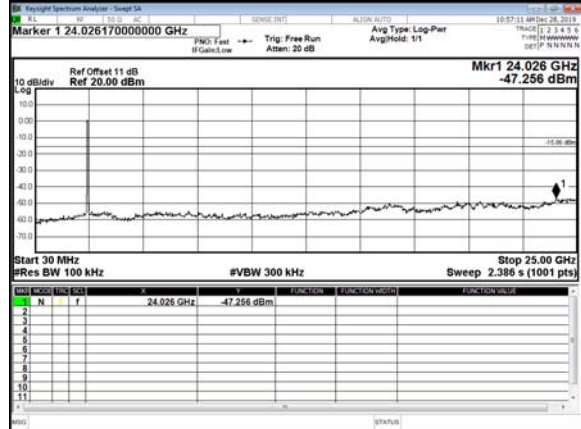
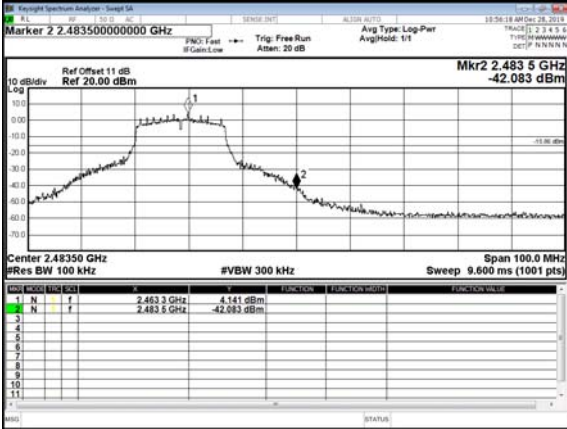



Modulation Type: 802.11n HT20
CH01

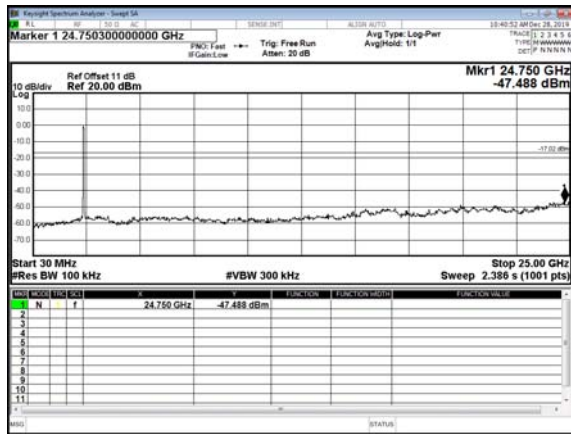
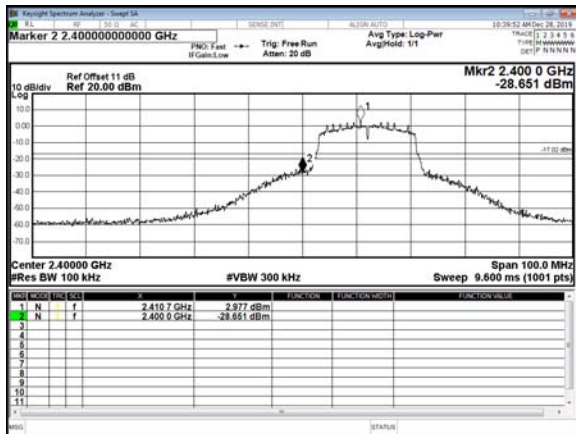

CH06

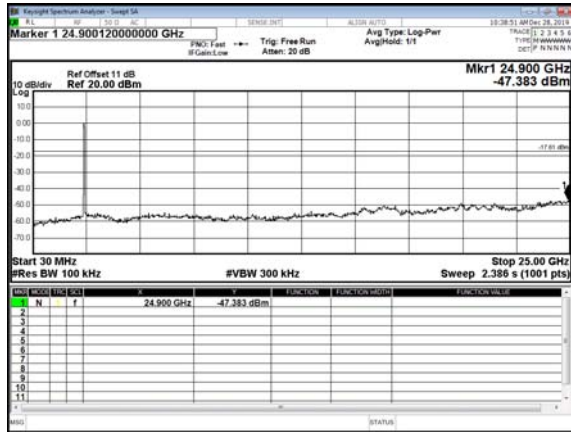
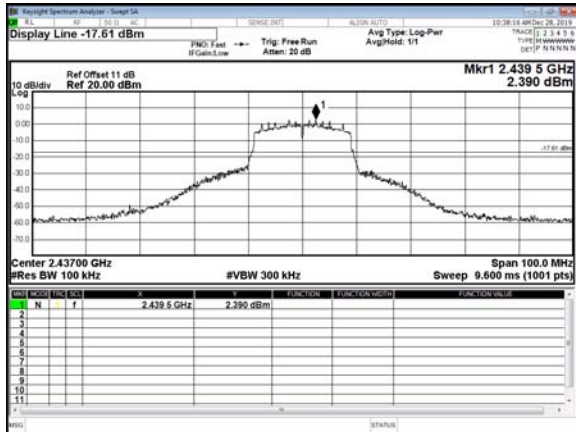

CH11

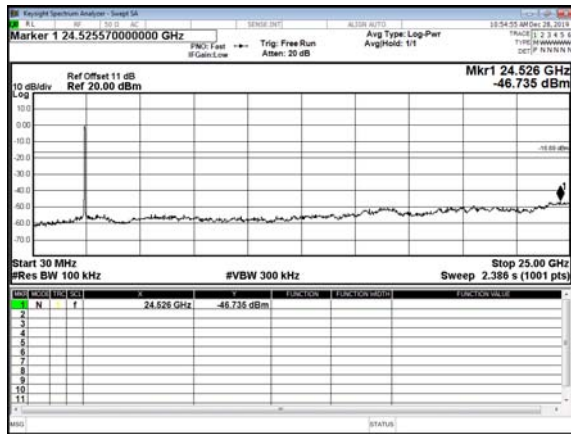
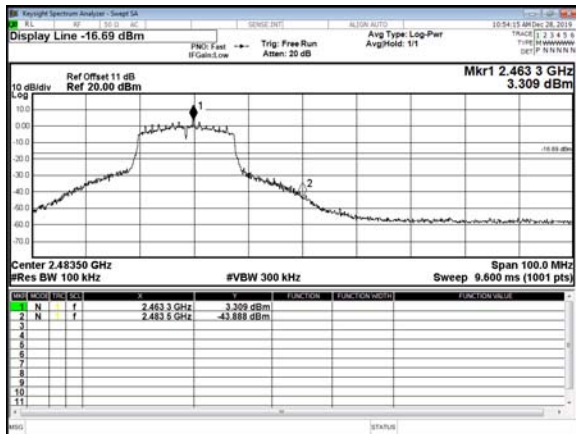



Modulation Type: 802.11n HT40
CH03

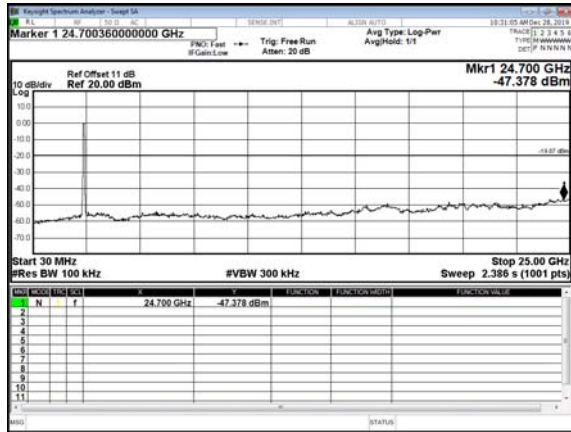
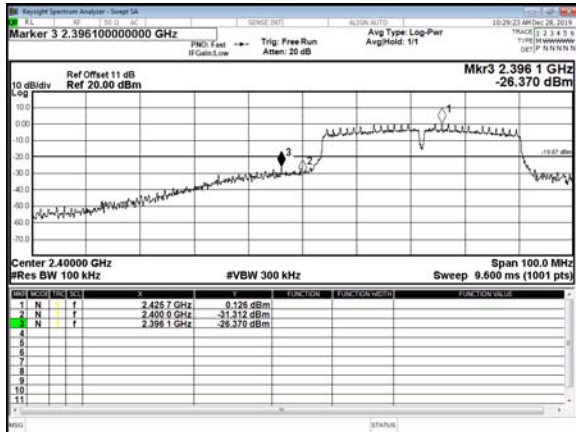

CH06

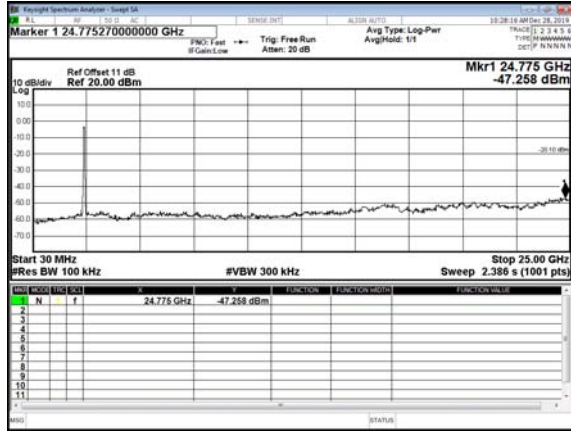
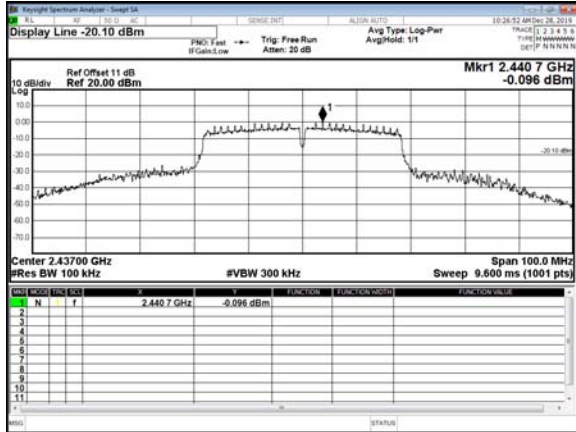

CH09

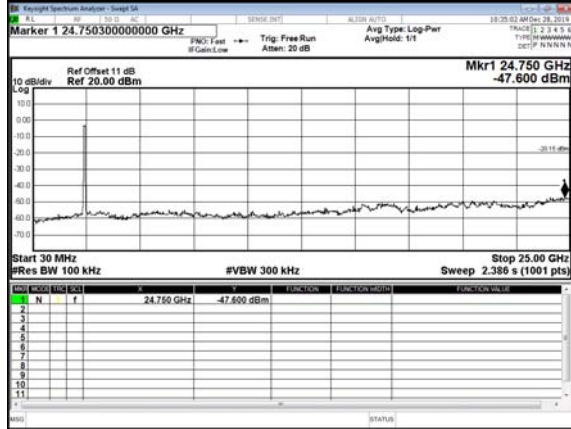
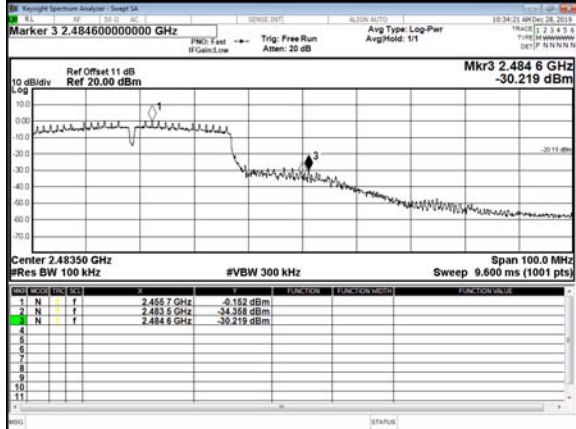



Chain 2
Modulation Type: 802.11b
CH01

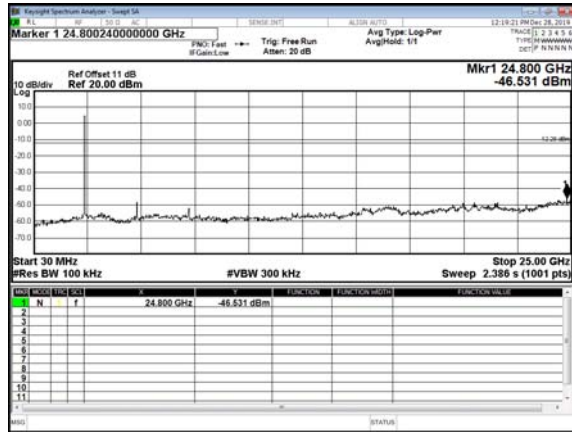
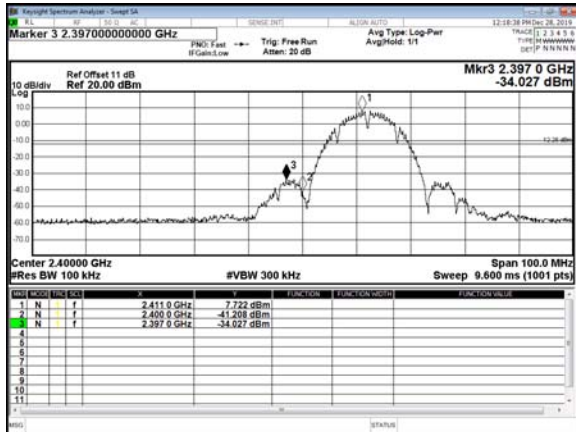

CH06

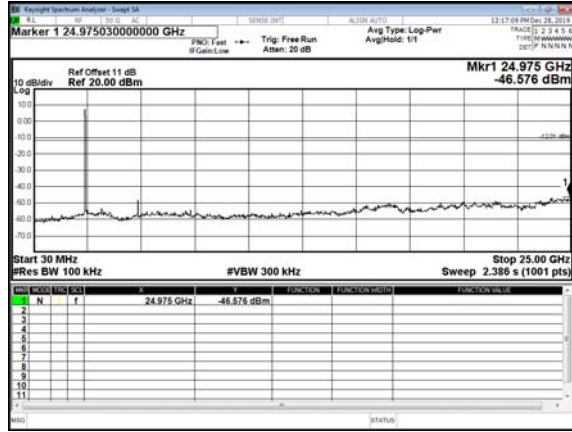
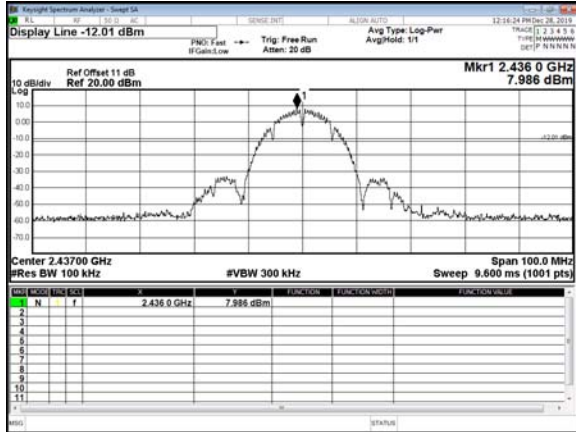

CH11

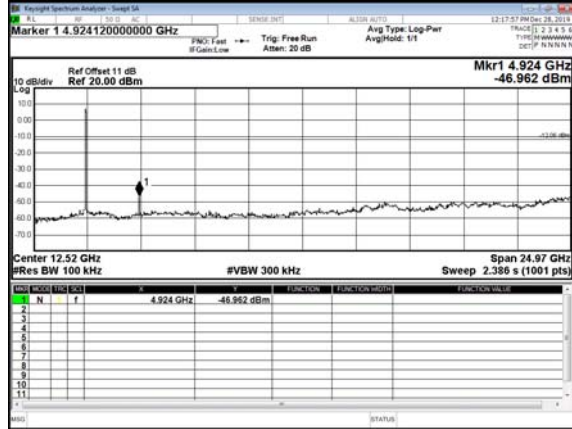
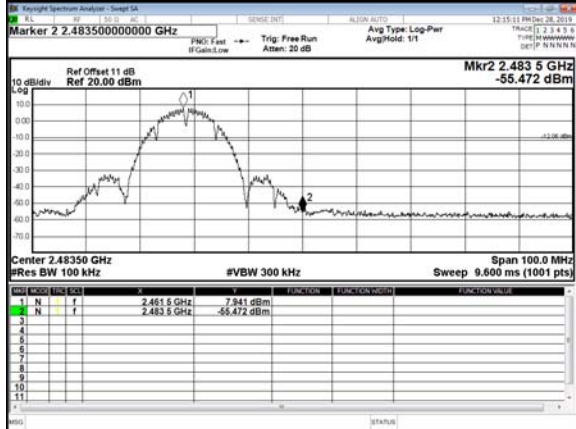



Modulation Type: 802.11g
CH01

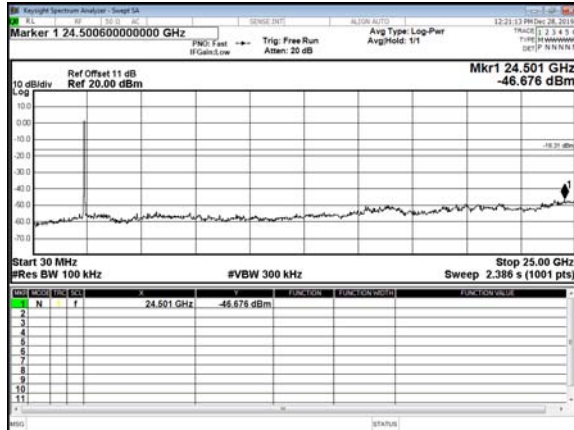
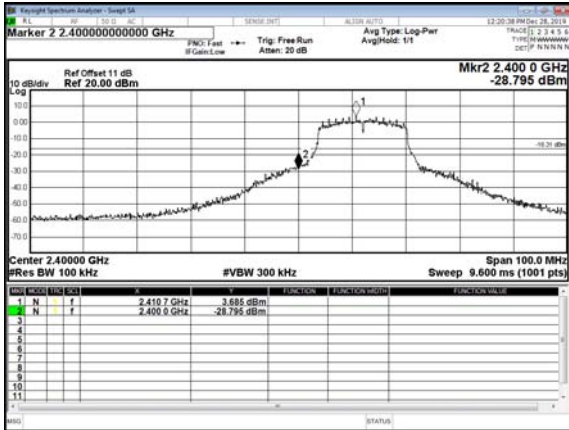

CH06

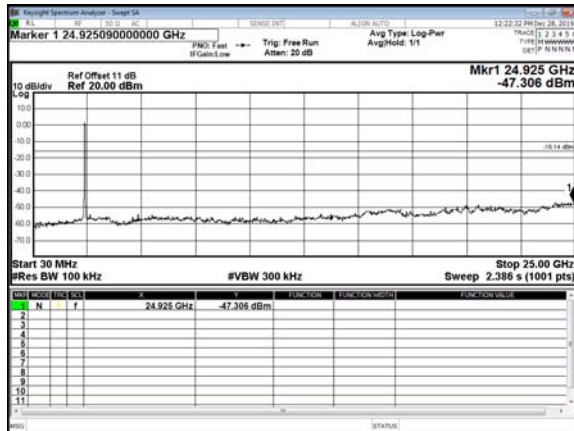
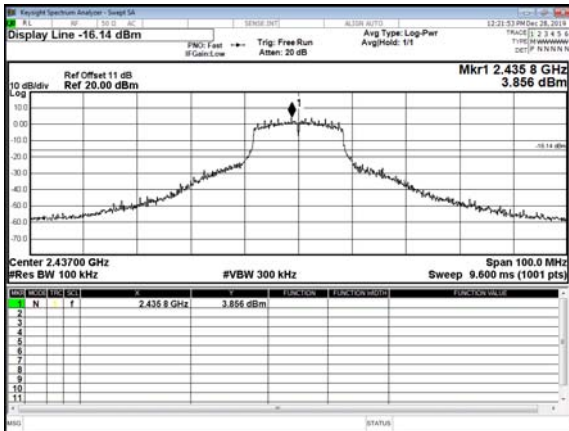

CH11

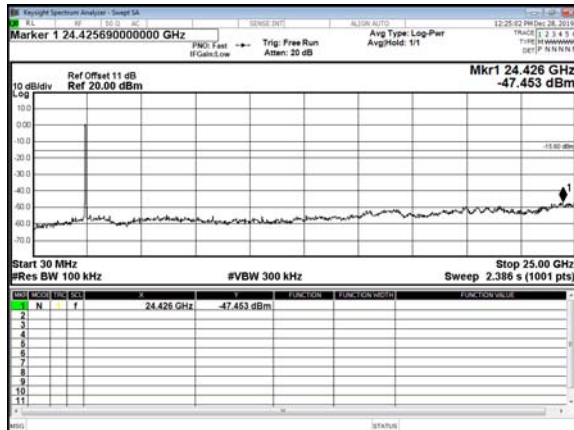
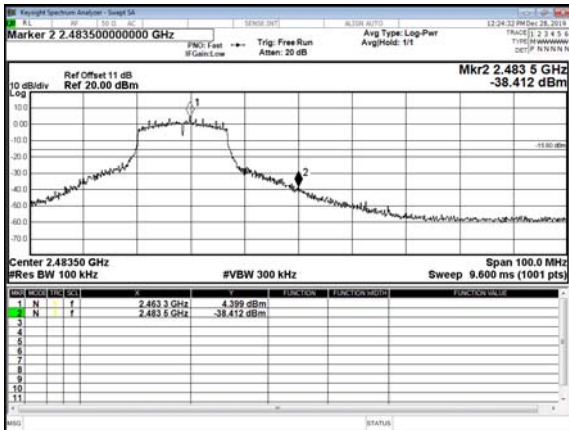



Modulation Type: 802.11n HT20
CH01

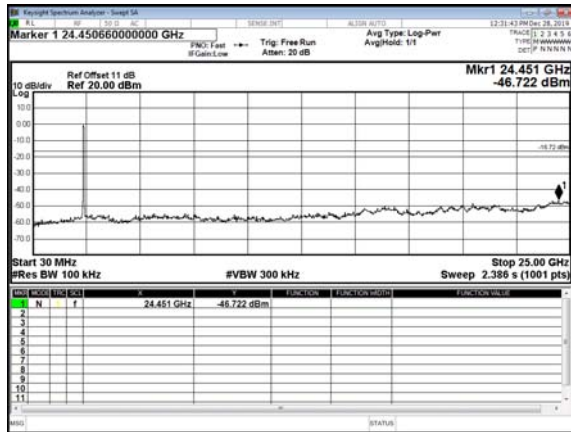
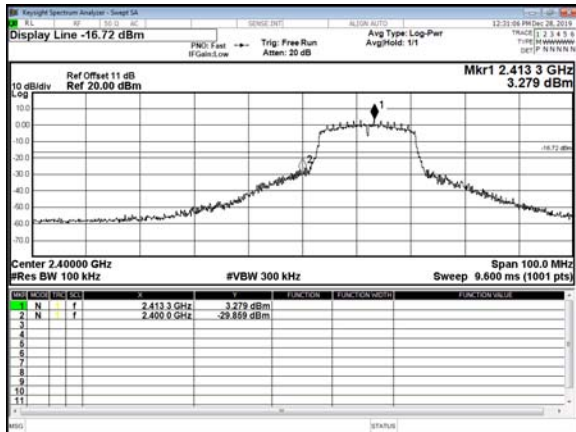

CH06

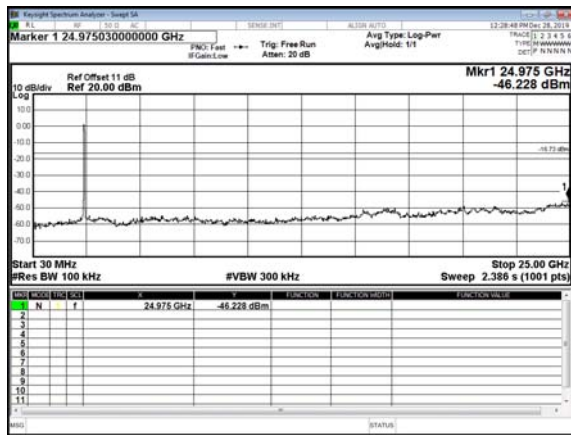
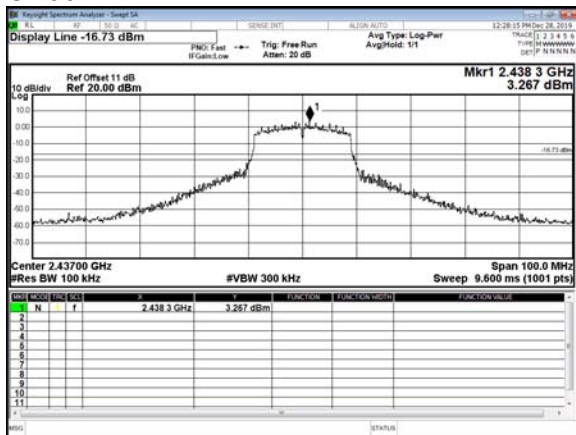

CH11

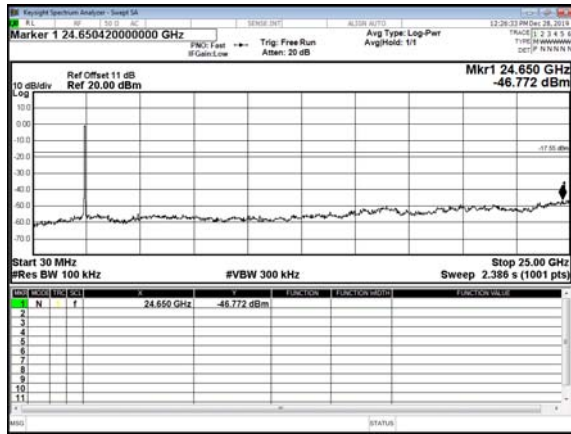
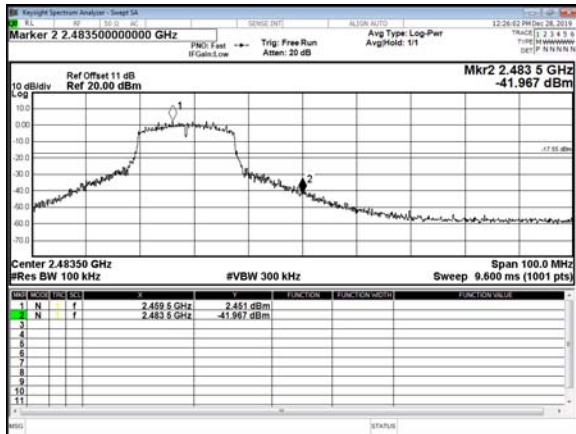



Modulation Type: 802.11n HT40
CH03

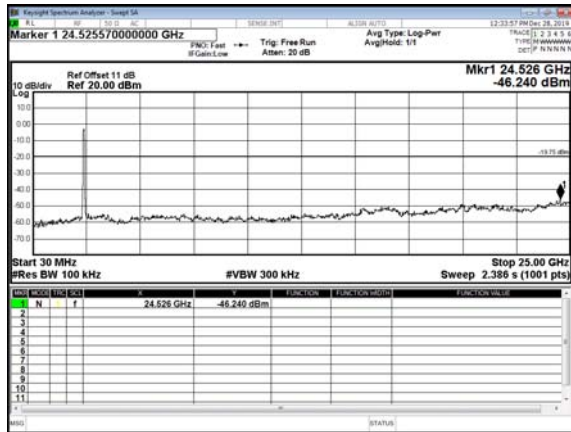
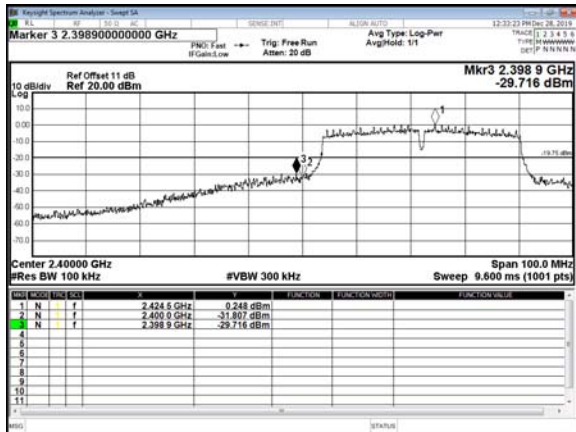

CH06

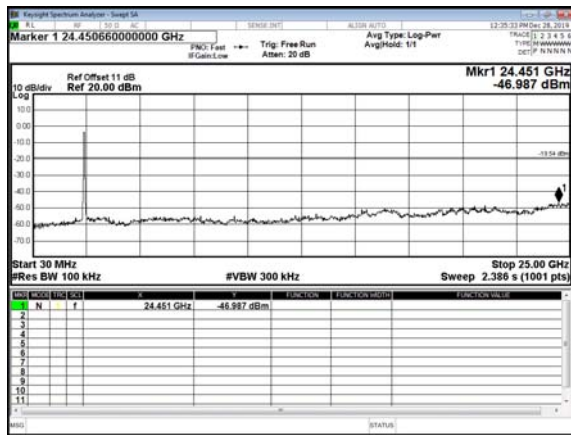
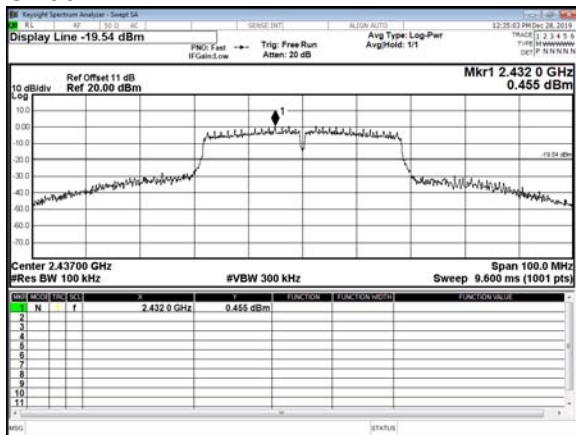

CH09

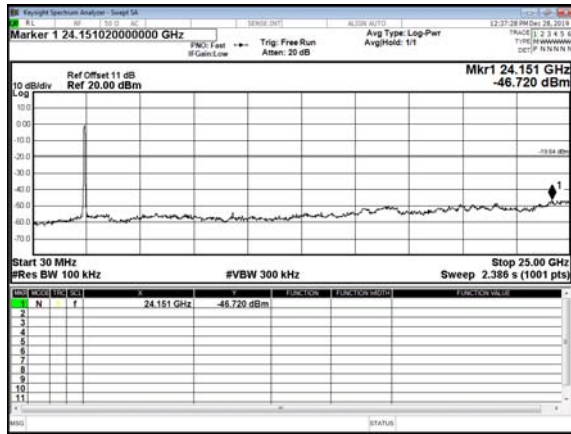
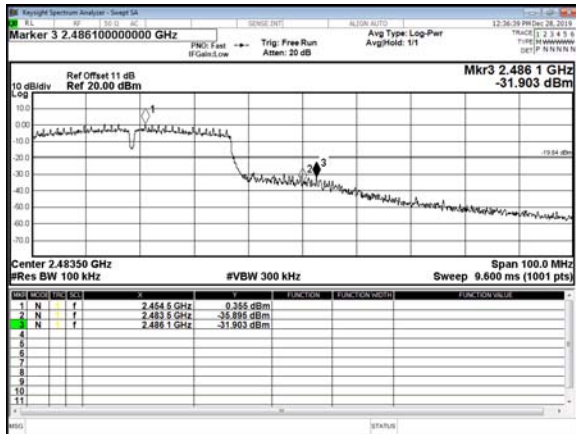



8. 6dB Bandwidth Measurement Data

8.1 Test Limit

The minimum of 6dB Bandwidth Measurement is 0.5 MHz.

8.2 Test Procedures

- The transmitter output was connected to the spectrum analyzer.
- Set RBW of spectrum analyzer to 100 KHz and VBW to 300 KHz.
- Set spectrum analyzer X dB to 6 dB.
- Set spectrum analyzer peak detector with maximum hold.

8.3 Test Setup Layout



8.4 Test Result and Data

Test Date: Dec. 28, 2019

Temperature: 24°C

Atmospheric pressure: 1016 hPa

Humidity: 46%

Modulation Type	Channel	Frequency (MHz)	6dB Bandwidth (MHz)	
			Chain 1	Chain 2
IEEE 802.11b	01	2412	9.13	8.61
	06	2437	9.12	9.13
	11	2462	8.12	9.11
IEEE 802.11g	01	2412	15.15	15.17
	06	2437	15.16	15.12
	11	2462	15.16	15.18
IEEE 802.11n HT20	01	2412	15.15	15.16
	06	2437	15.16	15.74
	11	2462	15.12	15.17
IEEE 802.11n HT40	03	2422	35.17	35.16
	06	2437	35.19	35.17
	09	2452	35.19	35.18



Chain 1
Modulation Type: 802.11b
CH01

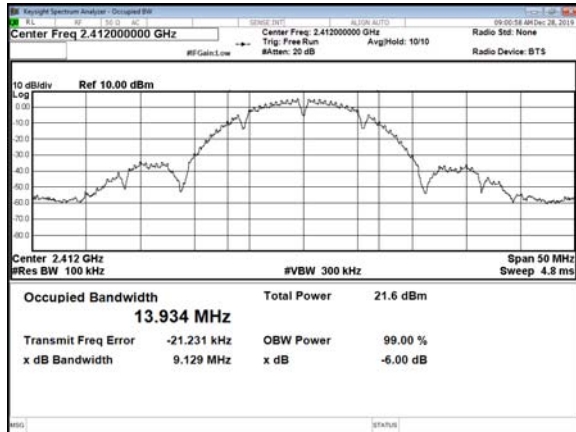

CH06

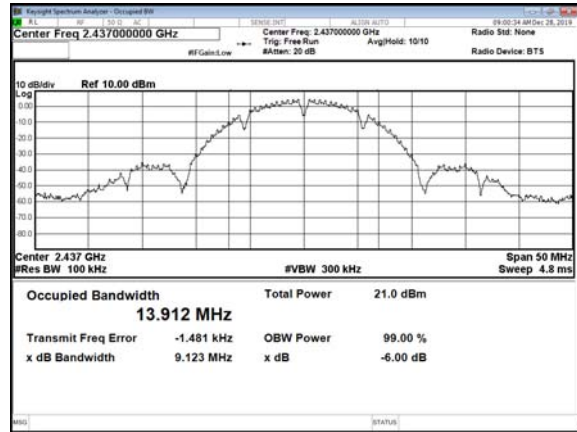

CH11

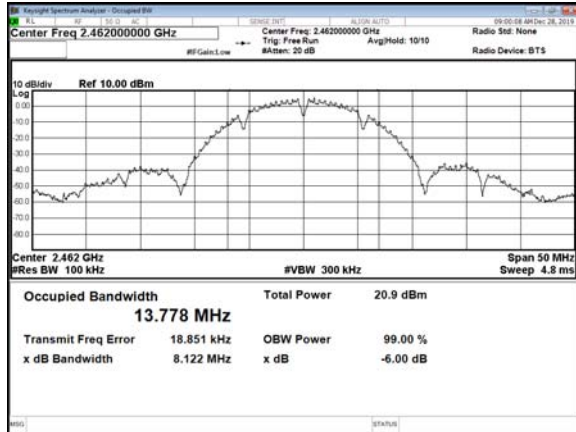

Modulation Type: 802.11g
CH01

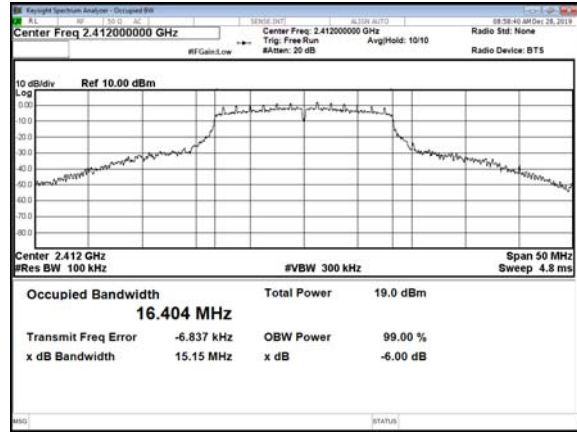

CH06

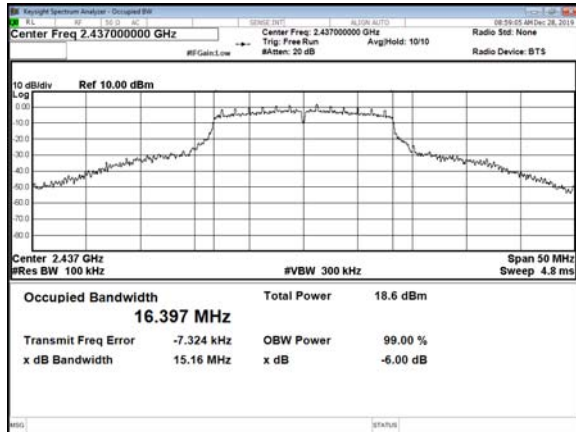

CH11

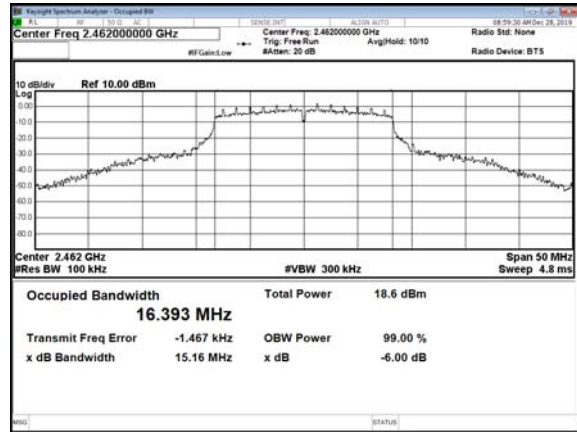



Modulation Type: 802.11n HT20
CH01

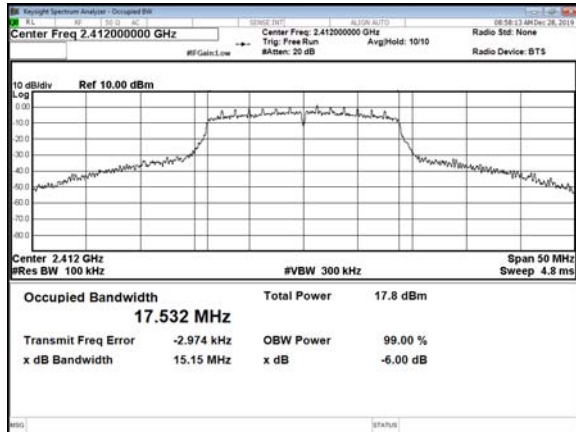

CH06

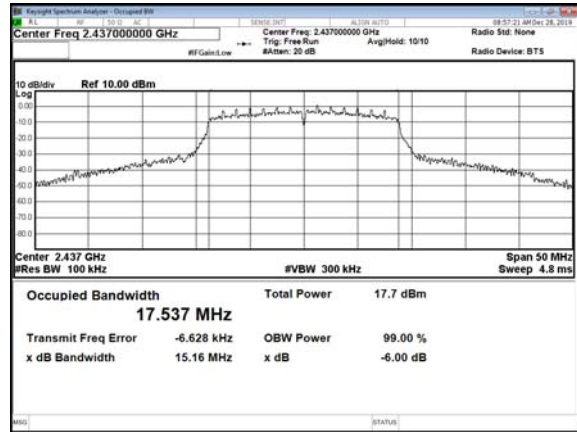

CH11

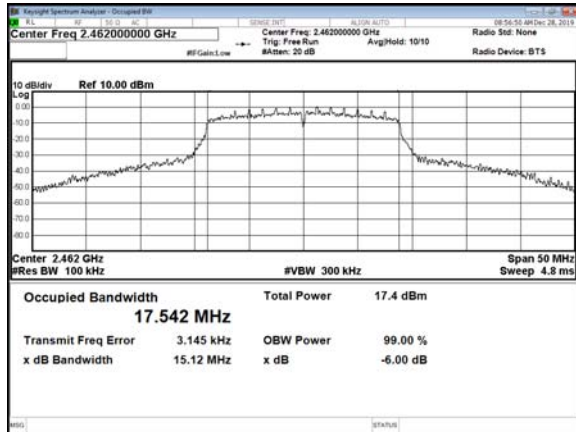

Modulation Type: 802.11n HT40
CH03

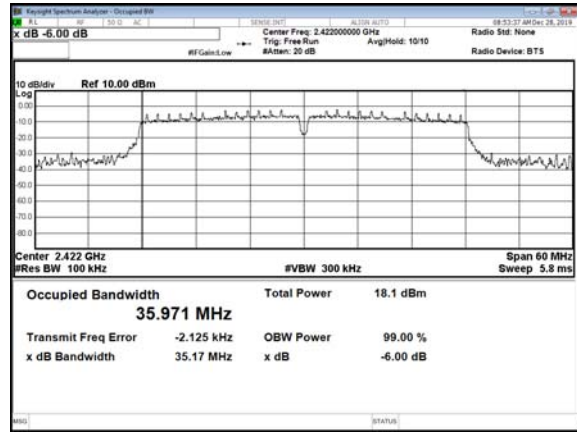

CH06

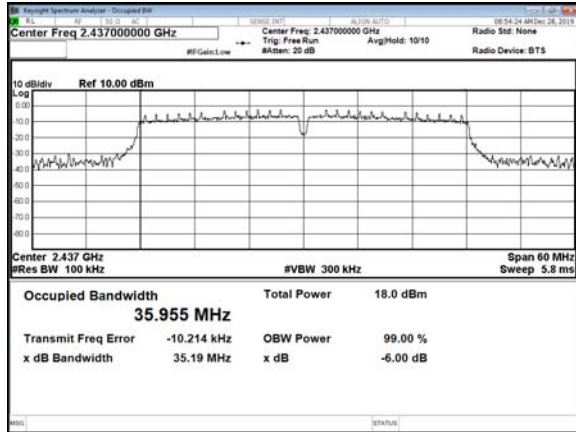

CH09

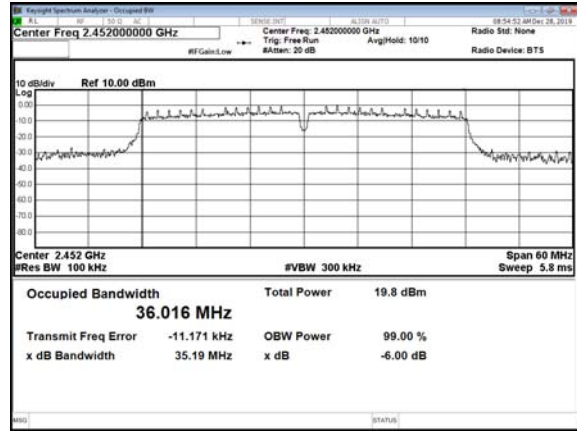



Chain 2
Modulation Type: 802.11b
CH01

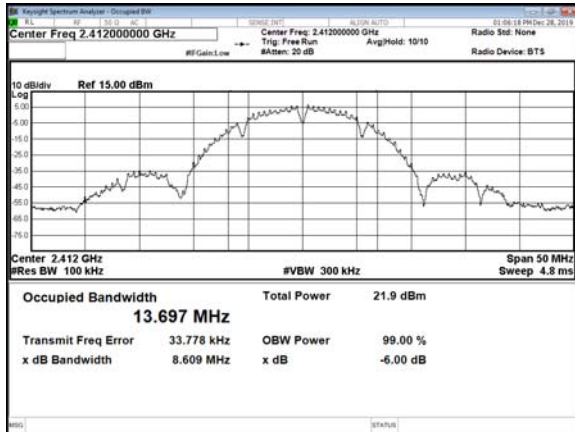

CH06

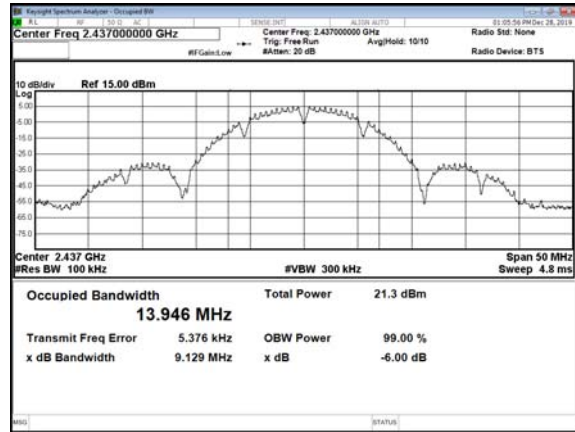

CH11

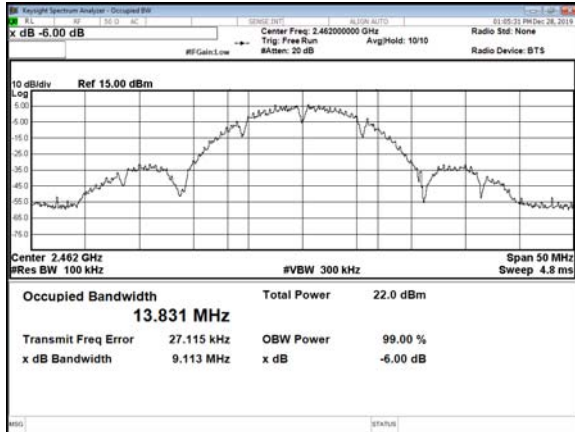

Modulation Type: 802.11g
CH01

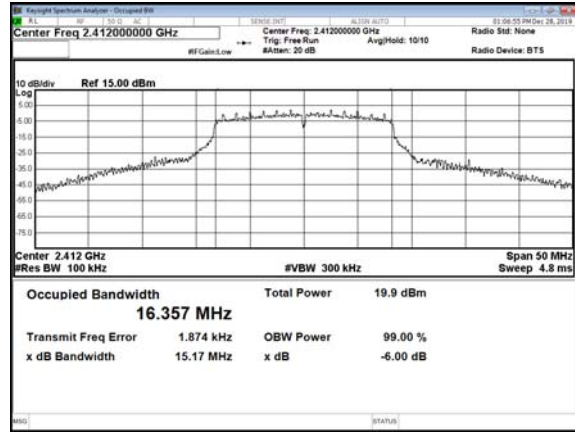

CH06

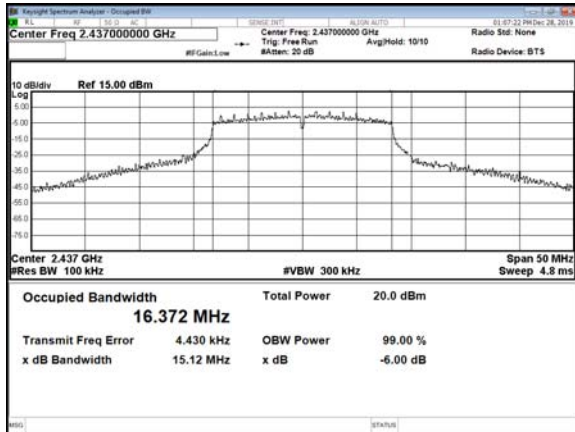

CH11

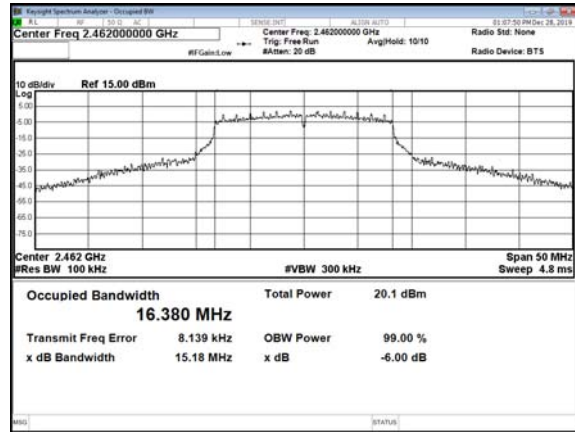



Modulation Type: 802.11n HT20
CH01

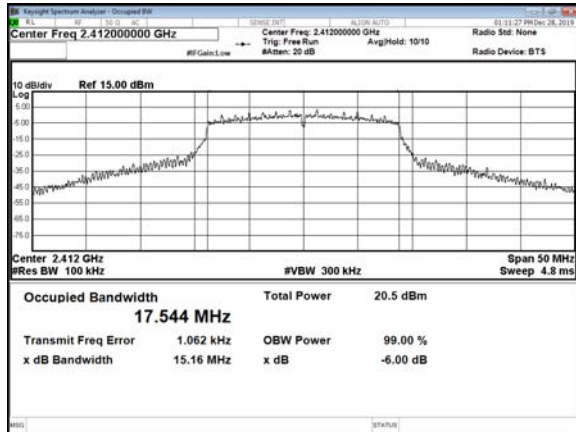

CH06

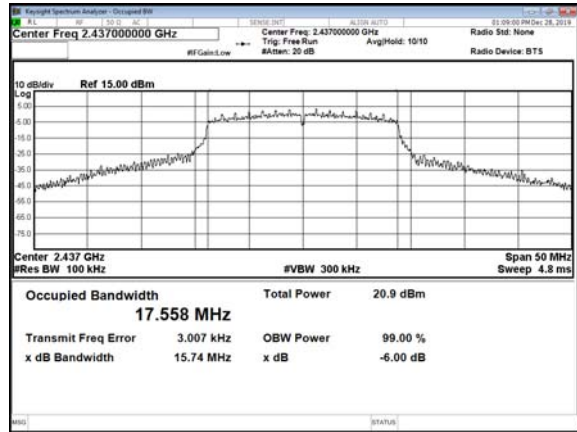

CH11

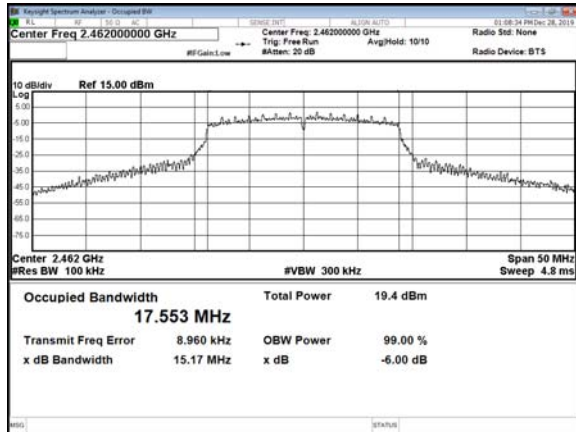

Modulation Type: 802.11n HT40
CH03

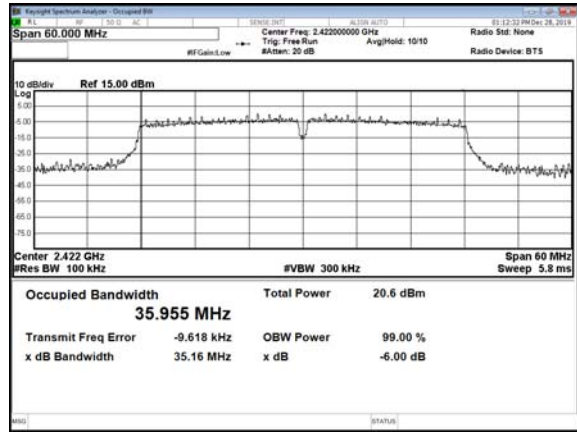

CH06

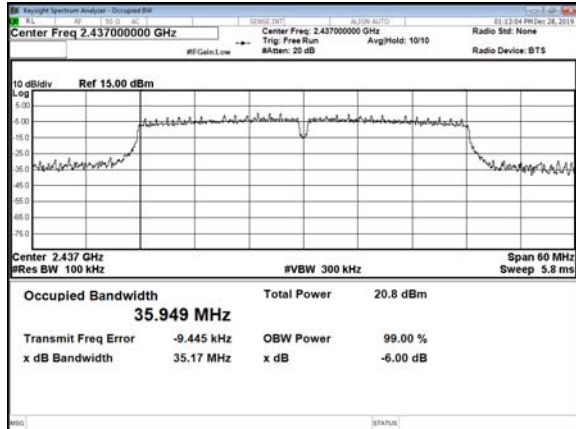

CH09

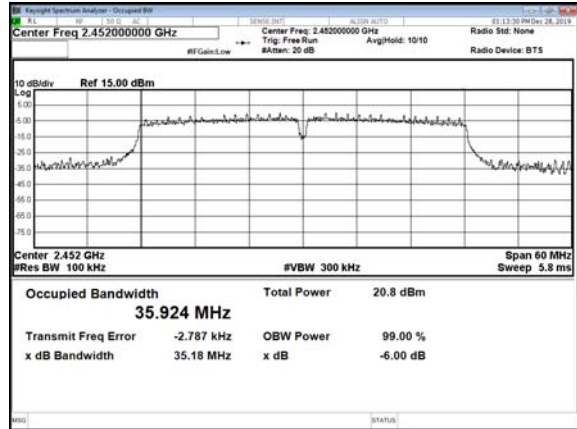



9. Maximum Peak Output Power

9.1 Test Limit

The Maximum Peak Output Power Measurement is 30dBm.

9.2 Test Procedures

Test procedure refers to KDB558074 D01 v05r02, Peak power meter method.

The antenna port (RF output) of the EUT was connected to the input (RF input) of a power meter. Power was read directly from the meter and cable loss connection was added to the reading to obtain power at the EUT antenna terminal. The EUT Output Power was set to maximum to produce the worse case test result.

9.3 Test Setup Layout

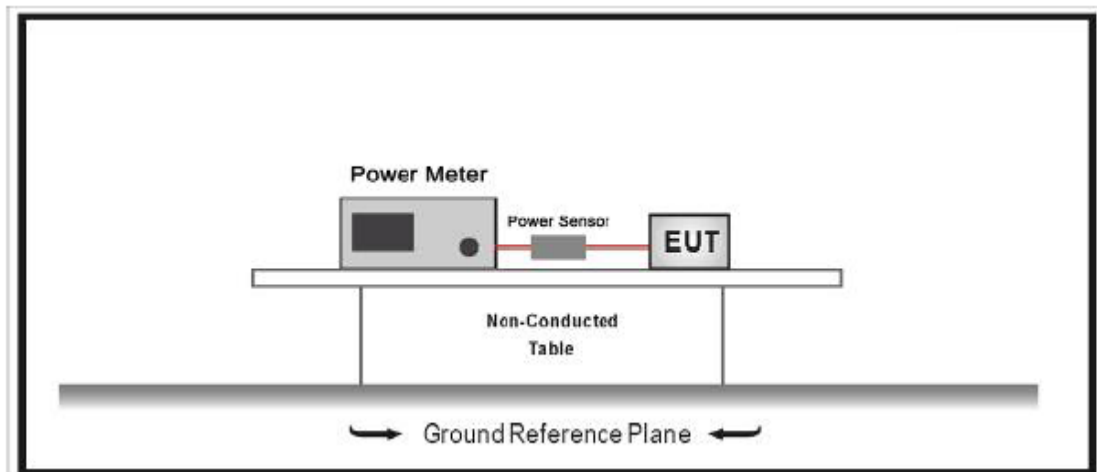

**9.4 Test Result and Data**

Test Date: Dec. 28, 2019

Temperature: 24°C

Atmospheric pressure: 1016 hPa

Humidity: 46%

Modulation Type	Frequency (MHz)	Peak Power (dBm) Chain 1	Peak Power (dBm) Chain 2	Peak Power (dBm) Chain 1+2	Peak Power Output
					mW
IEEE 802.11b	2412	16.94	19.14	21.19	131.466
	2437	16.60	19.28	21.15	130.432
	2462	16.52	19.21	21.08	128.243
IEEE 802.11g	2412	19.81	22.55	24.40	275.606
	2437	19.96	22.54	24.45	278.557
	2462	19.79	22.39	24.29	268.660
IEEE 802.11n HT20	2412	18.82	21.85	23.60	229.317
	2437	19.81	22.01	24.06	254.574
	2462	19.50	21.87	23.86	242.941
IEEE 802.11n HT40	2422	20.83	21.92	24.42	276.656
	2437	20.96	22.07	24.56	285.803
	2452	19.23	22.13	23.93	247.058

Modulation Type	Frequency (MHz)	AVG Power (dBm) Chain 1	AVG Power (dBm) Chain 2	AVG Power (dBm) Chain 1+2	AVG Power Output
					mW
IEEE 802.11b	2412	14.57	15.83	18.26	66.99
	2437	15.12	15.97	18.58	72.11
	2462	14.74	15.85	18.34	68.23
IEEE 802.11g	2412	14.21	16.32	18.40	69.18
	2437	13.80	15.68	17.85	60.95
	2462	13.13	15.83	17.70	58.88
IEEE 802.11n HT20	2412	13.09	15.10	17.22	52.72
	2437	12.48	14.44	16.58	45.50
	2462	12.37	14.29	16.45	44.16
IEEE 802.11n HT40	2422	13.26	14.41	16.88	48.75
	2437	12.50	14.77	16.79	47.75
	2452	12.40	14.61	16.65	46.24

*Average power is for reference only.



10. Power Spectral Density

10.1 Test Limit

The Maximum of Power Spectral Density Measurement is 8dBm.

10.2 Test Procedures

Test procedure refers to section 11.10.2 Method PKPSD (peak PSD).

The following procedure shall be used if maximum peak conducted output power was used to determine compliance, and it is optional if the maximum conducted (average) output power was used to determine compliance:

- a) Set analyzer center frequency to DTS channel center frequency.
- b) Set the span to 1.5 times the DTS bandwidth.
- c) Set the RBW to $3 \text{ kHz} \leq \text{RBW} \leq 100 \text{ kHz}$.
- d) Set the VBW $\geq [3 \times \text{RBW}]$.
- e) Detector = peak.
- f) Sweep time = auto couple.
- g) Trace mode = max hold.
- h) Allow trace to fully stabilize.
 - i) Use the peak marker function to determine the maximum amplitude level within the RBW.
 - j) If measured value exceeds requirement, then reduce RBW (but no less than 3 kHz) and repeat.

10.3 Test Setup Layout

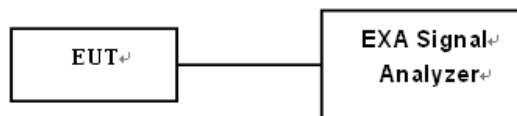



10.4 Test Result and Data

Test Date: Dec. 28, 2019

Temperature: 24°C

Atmospheric pressure: 1014 hPa

Humidity: 47%

Modulation Type	Frequency (MHz)	Power Spectral Density (dBm)		
		Chain 1	Chain 2	Chain 1+2
IEEE 802.11b	2412	-7.088	-7.184	-4.13
	2437	-9.635	-7.105	-5.18
	2462	-10.067	-6.639	-5.01
IEEE 802.11g	2412	-11.32	-10.992	-8.14
	2437	-11.846	-10.866	-8.32
	2462	-13.267	-10.361	-8.57
IEEE 802.11n HT20	2412	-12.372	-12.293	-9.32
	2437	-13.877	-11.583	-9.57
	2462	-12.958	-10.442	-8.51
IEEE 802.11n HT40	2422	-15.854	-15.258	-12.54
	2437	-16.359	-14.478	-12.31
	2452	-16.718	-14.439	-12.42



Chain 1
Modulation Type: 802.11b
CH01

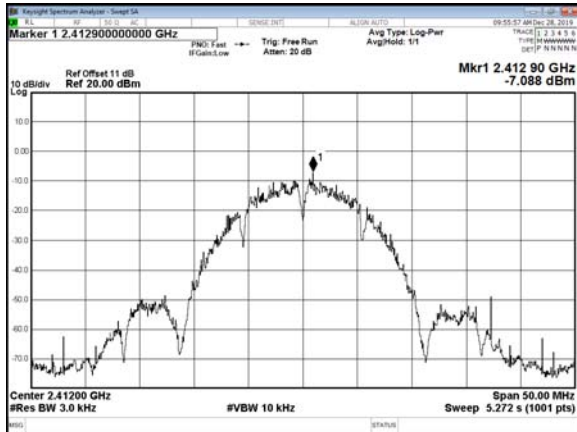

CH06



CH11

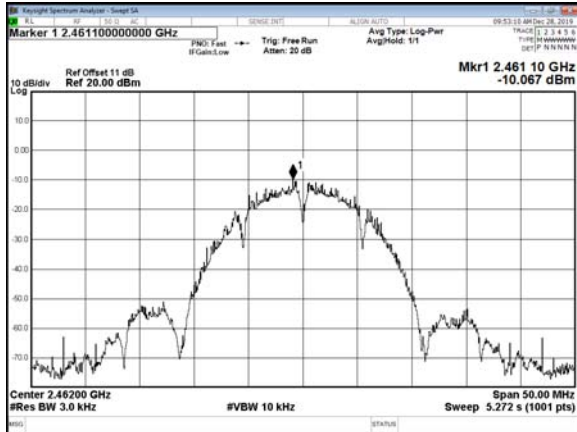

Modulation Type: 802.11g
CH01

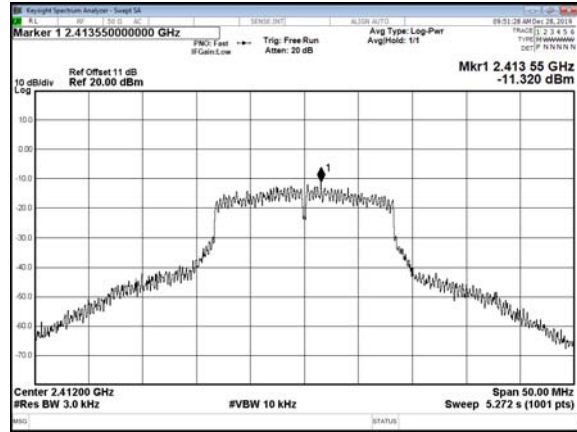

CH06

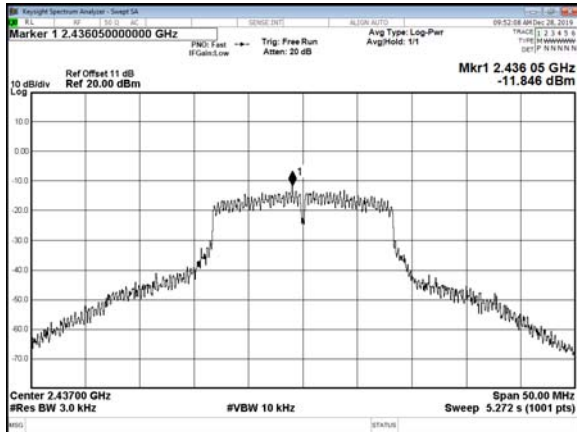

CH11

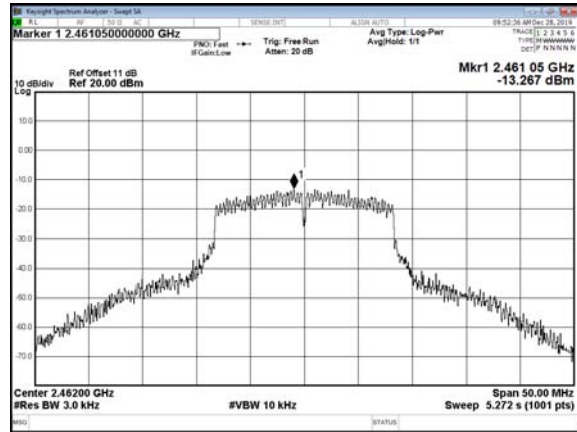



Modulation Type: 802.11n HT20
CH01

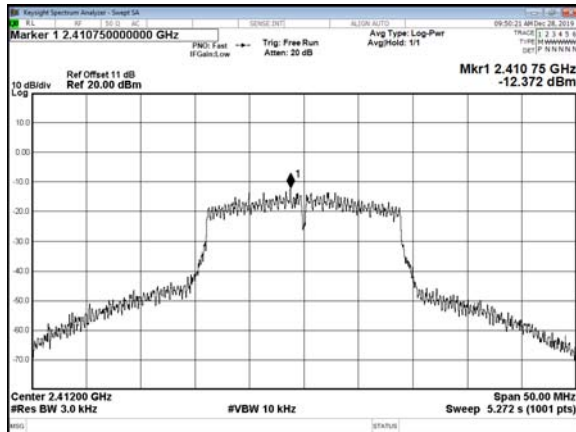

CH06

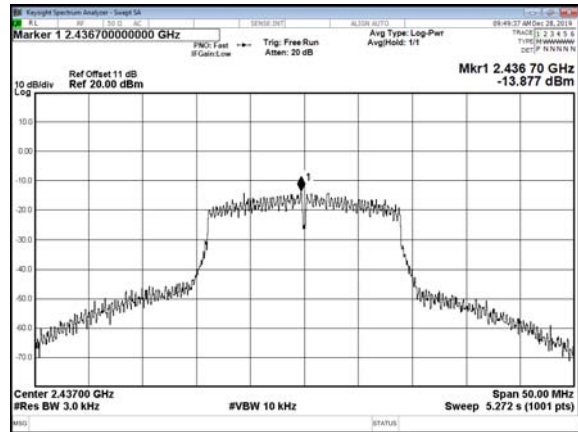

CH11

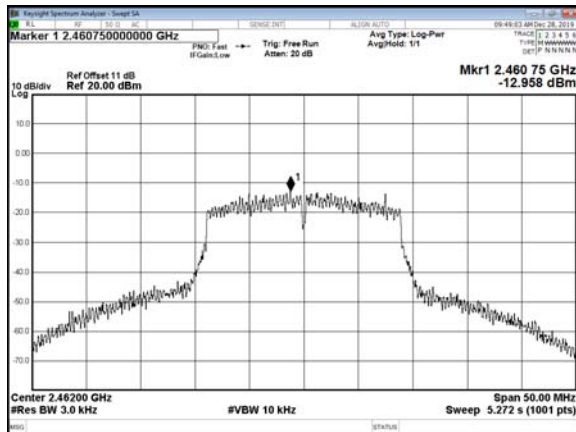

Modulation Type: 802.11n HT40
CH03

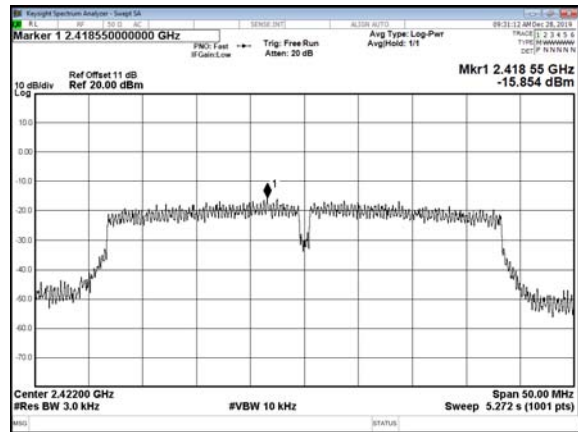

CH06

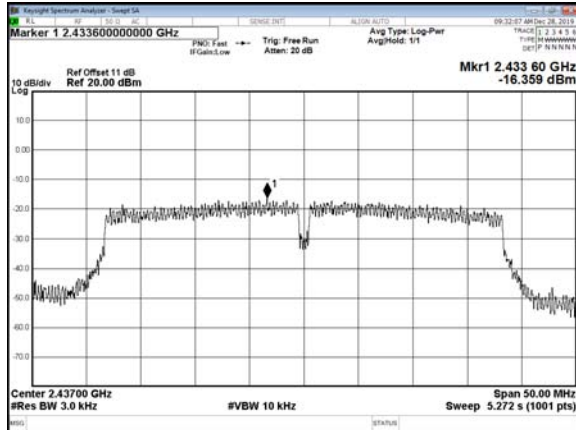

CH09

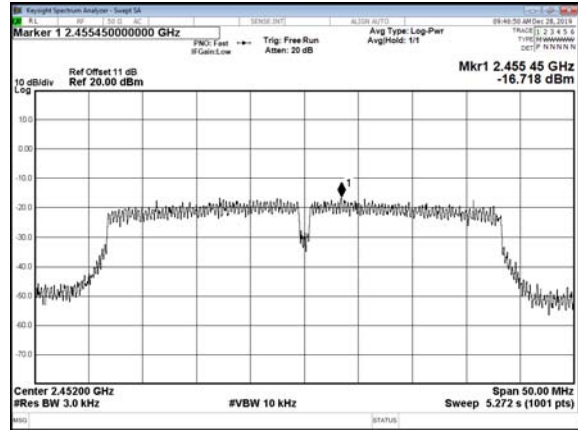



Chain 2
Modulation Type: 802.11b
CH01

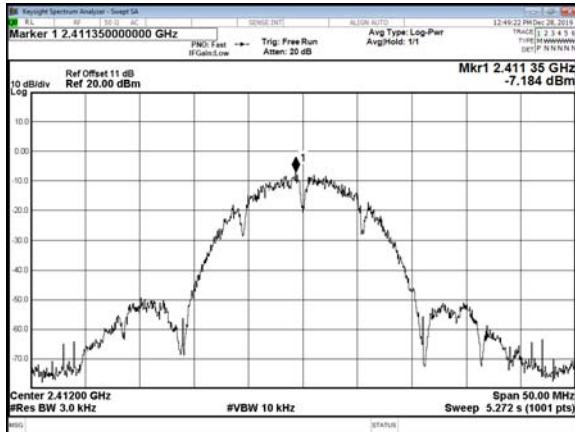

CH06

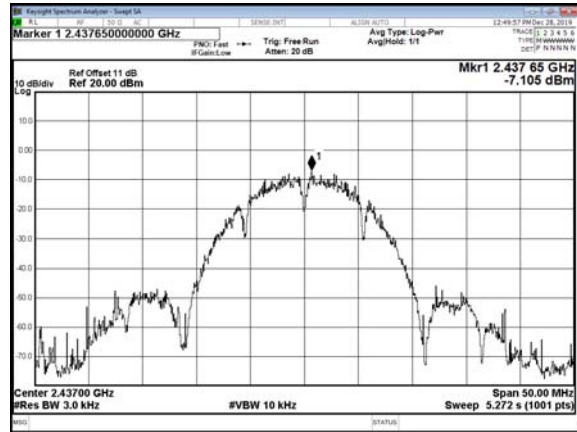

CH11

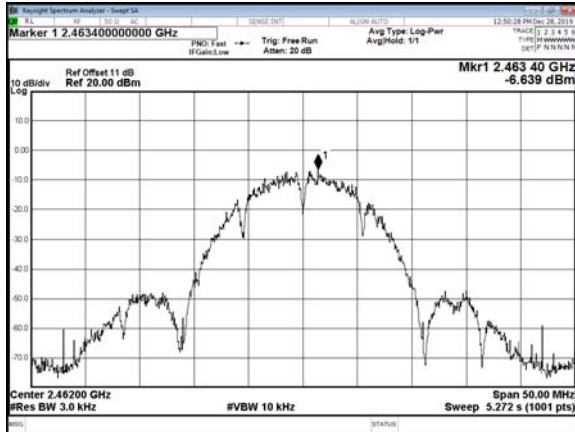

Modulation Type: 802.11g
CH01

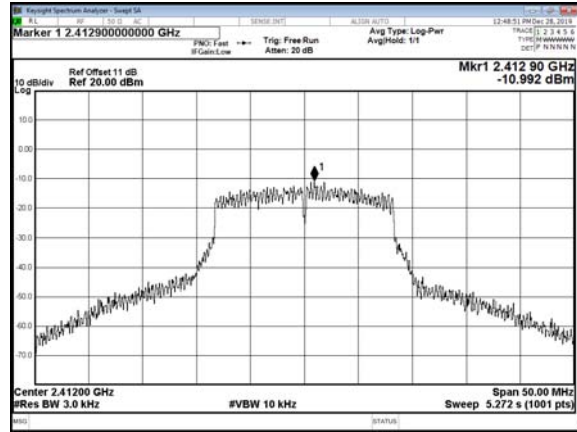

CH06

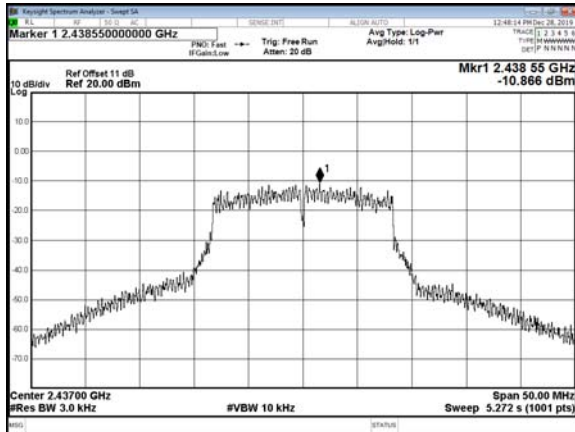

CH11

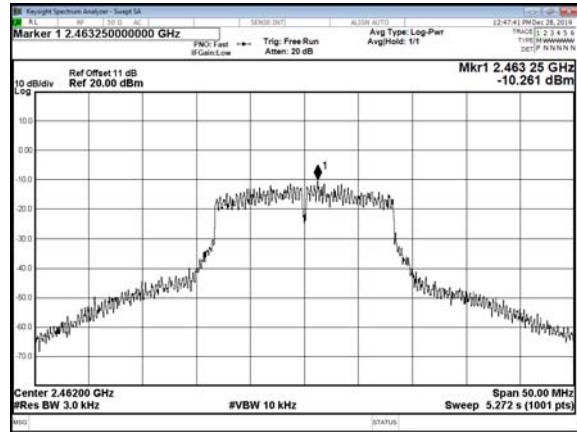



Modulation Type: 802.11n HT20
CH01

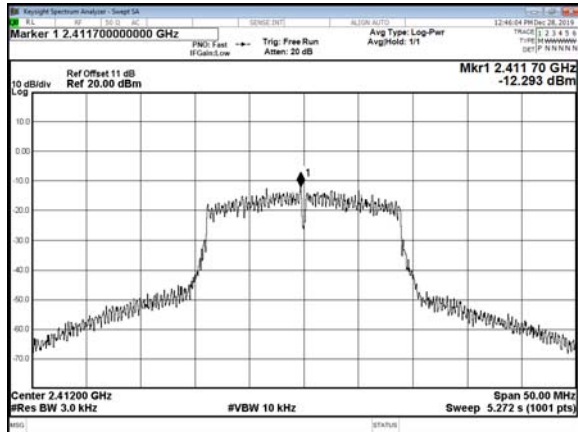

CH06

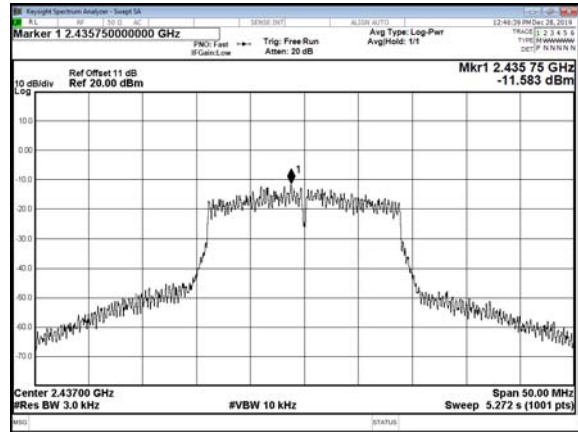

CH11

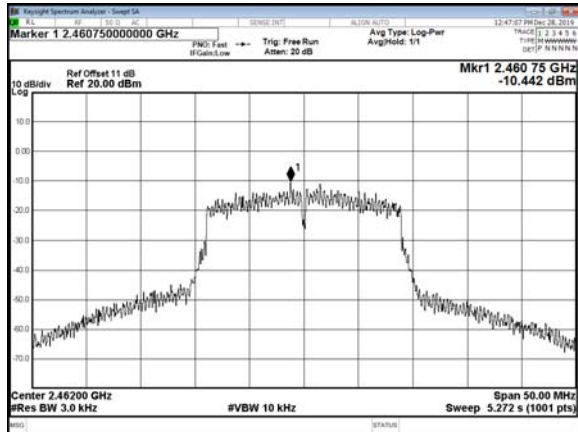

Modulation Type: 802.11n HT40
CH03

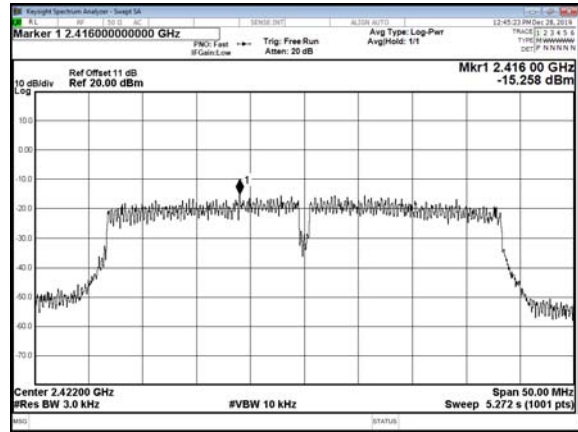

CH06

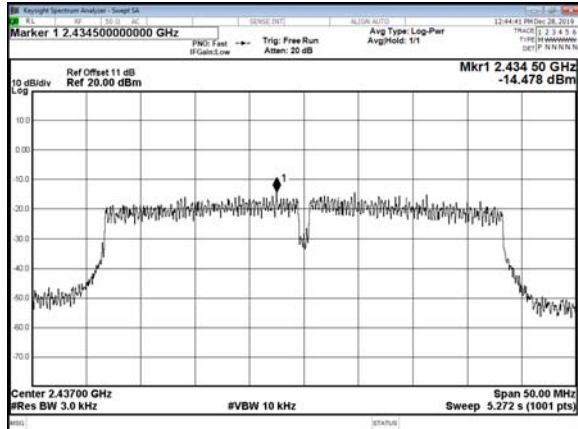

CH09

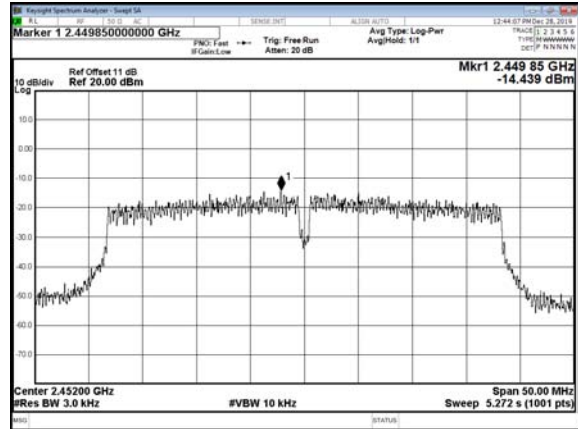

---End