



**CFR 47 FCC PART 15 SUBPART C  
ISED RSS-247 ISSUE 2**

**CERTIFICATION TEST REPORT**

*For*

**IEEE 802.11a/b/g/n 2T2R USB Wi-Fi Module  
Integrated Bluetooth 2.1+EDR/4.2/5.0**

**MODEL NUMBER: SKI.WB7638U.1\_MT7638BUB**

**FCC ID: 2AR82-SKIWB7638U2**

**IC: 24728-SKIWB7638U2**

**REPORT NUMBER: 4789787344.1-3**

**ISSUE DATE: January 21, 2021**

*Prepared for*

**Guangzhou Shikun Electronics Co., Ltd  
NO.6 Liankun Road,Huangpu District,Guangzhou,China**

*Prepared by*

**UL Verification Services (Guangzhou) Co., Ltd, Song Shan Lake Branch**

**Building 10, Innovation Technology Park, No. 1, Li Bin Road, Song Shan Lake Hi-Tech Development Zone Dongguan, 523808, People's Republic of China**

**Tel: +86 769 22038881**

**Fax: +86 769 33244054**

**Website: [www.ul.com](http://www.ul.com)**



Revision History

Rev.	Issue Date	Revisions	Revised By
V0	01/21/2021	Initial Issue	

Note: This is a spot check report base on FCC ID report SEFI2001042 (ISED report SEDL2001042) which is issued by CERPASS TECHNOLOGY (SUZHOU) CO., LTD on January 03, 2020. The module SKI.WB7638U.1\_MT7638BU had already applied for the single module and the FCC ID is 2AR82-SKIWB7638U1 (IC: 24728-SKIWB7638U1), the new module SKI.WB7638U.1\_MT7638BUB is identical with SKI.WB7638U.1\_MT7638BU except adding Bluetooth function (Bluetooth function was shielded for SKI.WB7638U.1\_MT7638BU), according to general guidance of KDB KDB484596 D01 (please refer to clause 1. a) b) c)), we used all the original WiFi test data to apply the new FCC ID for SKI.WB7638U.1\_MT7638BUB, but added the conducted output power and radiated spurious emission as spot check in this report to demonstrate that the referenced test data remains valid for the new device. For other data, please refer to the original report.

The applicant takes full responsibility that the test data referenced below represents compliance for this FCC ID.

Parent Model: SKI.WB7638U.1\_MT7638BU  
FCC ID: 2AR82-SKIWB7638U1, IC: 24728-SKIWB7638U1

Variant Model: SKI.WB7638U.1\_MT7638BUB  
FCC ID: 2AR82-SKIWB7638U2, IC: 24728-SKIWB7638U2

Reference Details

Equipment Class	Application Type	Reference Test Report Number	Exhibit Type	Spot Check Report Number	Data Re-used	FCC / ISED
DTS	Original Grant	SEFI2001042	Test Report	4789787344.1-3	All	FCC
	Original Grant	SEDL2001042	Test Report	4789787344.1-3	All	ISED
NII	Original Grant	SEDL2001042	Test Report	4789787344.1-4	All	FCC
	Original Grant	SEDM2001042	Test Report	4789787344.1-4	All	ISED



Summary of Test Results			
Clause	Test Items	FCC/ISED Rules	Test Results
1	Conducted Output Power	FCC Part 15.247 (b) (3) RSS-247 Clause 5.4 (d)	Pass
2	Radiated Bandedge and Spurious Emission Spot Check	FCC Part 15.247 (d) FCC Part 15.209 FCC Part 15.205 RSS-247 Clause 5.5 RSS-GEN Clause 8.9	Pass
3	Antenna Requirement	FCC 15.203 RSS-GEN Clause 6.8	PASS
Note: 1.This test report is only published to and used by the applicant, and it is not for evidence purpose in China. 2. The measurement result for the sample received is <Pass> according to < CFR 47 FCC PART 15 SUBPART C >< ISED RSS-247 > when <Accuracy Method> decision rule is applied.			

## TABLE OF CONTENTS

<b>1. ATTESTATION OF TEST RESULTS .....</b>	<b>5</b>
<b>2. TEST METHODOLOGY .....</b>	<b>6</b>
<b>3. FACILITIES AND ACCREDITATION .....</b>	<b>6</b>
<b>4. CALIBRATION AND UNCERTAINTY .....</b>	<b>7</b>
4.1. <i>MEASURING INSTRUMENT CALIBRATION .....</i>	<i>7</i>
4.2. <i>MEASUREMENT UNCERTAINTY.....</i>	<i>7</i>
<b>5. EQUIPMENT UNDER TEST .....</b>	<b>8</b>
5.1. <i>DESCRIPTION OF EUT .....</i>	<i>8</i>
5.2. <i>CHANNEL LIST.....</i>	<i>8</i>
5.3. <i>TEST CHANNEL CONFIGURATION.....</i>	<i>8</i>
5.4. <i>DESCRIPTION OF AVAILABLE ANTENNAS.....</i>	<i>9</i>
5.5. <i>DESCRIPTION OF TEST SETUP.....</i>	<i>10</i>
<b>6. MEASURING INSTRUMENT AND SOFTWARE USED .....</b>	<b>11</b>
<b>7. ANTENNA PORT TEST RESULTS.....</b>	<b>12</b>
7.1. <i>CONDUCTED OUTPUT POWER.....</i>	<i>12</i>
<b>8. RADIATED TEST RESULTS.....</b>	<b>15</b>
8.1. <i>SPOT CHECK VERIFICATION SUMMERY.....</i>	<i>21</i>
8.2. <i>RESTRICTED BANDEDGE.....</i>	<i>22</i>
8.2.1. <i>802.11b SISO MODE AND BT MODE WORST CASE .....</i>	<i>22</i>
8.3. <i>SPURIOUS EMISSIONS (1 GHz ~ 3 GHz).....</i>	<i>24</i>
8.3.1. <i>802.11b MIMO MODE AND BT MODE WORST CASE .....</i>	<i>24</i>
8.4. <i>SPURIOUS EMISSIONS (3 GHz ~ 18 GHz).....</i>	<i>26</i>
8.4.1. <i>802.11b MODE AND BT MODE WORST CASE .....</i>	<i>26</i>
8.5. <i>SPURIOUS EMISSIONS (18 GHz ~ 26 GHz).....</i>	<i>28</i>
8.5.1. <i>802.11b MIMO MODE AND BT MODE WORST CASE .....</i>	<i>28</i>
8.6. <i>SPURIOUS EMISSIONS (30 MHz ~ 1 GHz).....</i>	<i>30</i>
8.6.1. <i>802.11b MODE AND BT MODE WORST CASE.....</i>	<i>30</i>
8.7. <i>SPURIOUS EMISSIONS BELOW 30 MHz .....</i>	<i>32</i>
8.7.1. <i>802.11b MIMO MODE AND BT MODE WORST CASE .....</i>	<i>32</i>
<b>9. ANTENNA REQUIREMENTS.....</b>	<b>35</b>



# 1. ATTESTATION OF TEST RESULTS

## Applicant Information

Company Name: Guangzhou Shikun Electronics Co., Ltd  
 Address: NO.6 Liankun Road,Huangpu District,Guangzhou,China

## Manufacturer Information

Company Name: Guangzhou Shikun Electronics Co., Ltd  
 Address: NO.6 Liankun Road,Huangpu District,Guangzhou,China

## EUT Information

EUT Name: IEEE 802.11a/b/g/n 2T2R USB Wi-Fi Module  
 Integrated Bluetooth 2.1+EDR/4.2/5.0  
 Model: SKI.WB7638U.1\_MT7638BUB  
 Brand: /  
 Serial Model: /  
 Sample Received Date: January 7, 2021  
 Sample Status: Normal  
 Sample ID: 3576248  
 Date of Tested: January 11, 2021 ~ January 21, 2021

APPLICABLE STANDARDS	
STANDARD	TEST RESULTS
CFR 47 FCC PART 15 SUBPART C	PASS
ISED RSS-247 Issue 2	PASS
ISED RSS-GEN Issue 5	PASS

Prepared By:

Denny Huang  
 Project Engineer  
 Approved By:

Stephen Guo  
 Laboratory Manager

Checked By:

Shawn Wen  
 Laboratory Leader



## 2. TEST METHODOLOGY

The tests documented in this report were performed in accordance with KDB 558074 D01 15.247 Meas Guidance v05r02, KDB 414788 D01 Radiated Test Site v01r01, KDB484596 D01 Referencing Test Data v01, CFR 47 FCC Part 2, CFR 47 FCC Part 15, ANSI C63.10-2013, ISED RSS-247 Issue 2 and ISED RSS-GEN Issue 5.

## 3. FACILITIES AND ACCREDITATION

Accreditation Certificate	<p><b>A2LA (Certificate No.: 4102.01)</b>          UL Verification Services (Guangzhou) Co., Ltd. Song Shan Lake Branch. has been assessed and proved to be in compliance with A2LA.</p> <p><b>FCC (FCC Designation No.: CN1187)</b>          UL Verification Services (Guangzhou) Co., Ltd. Song Shan Lake Branch. Has been recognized to perform compliance testing on equipment subject to the Commission's Declaration of Conformity (DoC) and Certification rules</p> <p><b>ISED (Company No.: 21320)</b>          UL Verification Services (Guangzhou) Co., Ltd. Song Shan Lake Branch. has been registered and fully described in a report filed with ISED. The Company Number is 21320 and the test lab Conformity Assessment Body Identifier (CABID) is CN0046.</p> <p><b>VCCI (Registration No.: G-20019, R-20004, C-20012 and T-20011)</b>          UL Verification Services (Guangzhou) Co., Ltd. Song Shan Lake Branch. has been assessed and proved to be in compliance with VCCI, the Membership No. is 3793.          Facility Name:          Chamber D, the VCCI registration No. is G-20019 and R-20004          Shielding Room B , the VCCI registration No. is C-20012 and T-20011</p>
---------------------------	--

Note 1: All tests measurement facilities use to collect the measurement data are located at Building 10, Innovation Technology Park, Song Shan Lake Hi tech Development Zone, Dongguan, 523808, China

Note 2: The test anechoic chamber in UL Verification Services (Guangzhou) Co., Ltd. Song Shan Lake Branch had been calibrated and compared to the open field sites and the test anechoic chamber is shown to be equivalent to or worst case from the open field site.

Note 3: For below 30MHz, lab had performed measurements at test anechoic chamber and comparing to measurements obtained on an open field site. And these measurements below 30MHz had been correlated to measurements performed on an OFS.



## 4. CALIBRATION AND UNCERTAINTY

### 4.1. MEASURING INSTRUMENT CALIBRATION

The measuring equipment utilized to perform the tests documented in this report has been calibrated in accordance with the manufacturer's recommendations and is traceable to recognize national standards.

### 4.2. MEASUREMENT UNCERTAINTY

Where relevant, the following measurement uncertainty levels have been estimated for tests performed on the apparatus:

Test Item	Uncertainty
Conduction emission	3.62 dB
Radiated Emission (Included Fundamental Emission) (9 kHz ~ 30 MHz)	2.2 dB
Radiated Emission (Included Fundamental Emission) (30 MHz ~ 1 GHz)	4.00 dB
Radiated Emission (Included Fundamental Emission) (1 GHz to 26 GHz)	5.78 dB (1 GHz ~ 18 GHz)
	5.23 dB (18 GHz ~ 26 GHz)
Duty Cycle	±0.028%
DTS and 99% Occupied Bandwidth	±0.0196%
Maximum Conducted Output Power	±0.686 dB
Maximum Power Spectral Density Level	±0.743 dB
Conducted Band-edge Compliance	±1.328 dB
Conducted Unwanted Emissions In Non-restricted Frequency Bands	±0.746 dB (9 kHz ~ 1 GHz)
	±1.328dB (1 GHz ~ 26 GHz)
Note: This uncertainty represents an expanded uncertainty expressed at approximately the 95% confidence level using a coverage factor of k=2.	



## 5. EQUIPMENT UNDER TEST

### 5.1. DESCRIPTION OF EUT

EUT Name	IEEE 802.11a/b/g/n 2T2R USB Wi-Fi Module Integrated Bluetooth 2.1+EDR/4.2/5.0
Model	SKI.WB7638U.1_MT7638BUB
Radio Technology	WLAN (IEEE 802.11b/g/n HT20/n HT40)
Operation frequency	IEEE 802.11b: 2412MHz ~ 2462MHz IEEE 802.11g: 2412MHz ~ 2462MHz IEEE 802.11n HT20: 2412MHz ~ 2462MHz IEEE 802.11n HT40: 2422MHz ~ 2452MHz
Modulation	IEEE 802.11b: DSSS (CCK, DQPSK, DBPSK) IEEE 802.11g: OFDM (64QAM, 16QAM, QPSK, BPSK) IEEE 802.11n HT20: OFDM (64QAM, 16QAM, QPSK, BPSK) IEEE 802.11n HT40: OFDM (64QAM, 16QAM, QPSK, BPSK)
Ratings	DC 3.3 V

### 5.2. CHANNEL LIST

Channel List for 802.11b/g/n (20 MHz)							
Channel	Frequency (MHz)	Channel	Frequency (MHz)	Channel	Frequency (MHz)	Channel	Frequency (MHz)
1	2412	4	2427	7	2442	10	2457
2	2417	5	2432	8	2447	11	2462
3	2422	6	2437	9	2452	/	/

Channel List for 802.11n (40 MHz)							
Channel	Frequency (MHz)	Channel	Frequency (MHz)	Channel	Frequency (MHz)	Channel	Frequency (MHz)
3	2422	5	2432	7	2442	9	2452
4	2427	6	2437	8	2447	/	/

### 5.3. TEST CHANNEL CONFIGURATION

IEEE Std. 802.11	Test Channel Number	Frequency
b	CH 1(Low Channel), CH 6(MID Channel), CH 11(High Channel)	2412 MHz, 2437 MHz, 2462 MHz
g	CH 1(Low Channel), CH 6(MID Channel), CH 11(High Channel)	2412 MHz, 2437 MHz, 2462 MHz
n HT20	CH 1(Low Channel), CH 6(MID Channel), CH 11(High Channel)	2412 MHz, 2437 MHz, 2462 MHz
n HT40	CH 3(Low Channel), CH 6(MID Channel), CH 9(High Channel)	2422 MHz, 2437 MHz, 2452 MHz





#### 5.4. DESCRIPTION OF AVAILABLE ANTENNAS

Antenna	Frequency	Antenna Type	Maximum Antenna Gain
	(MHz)		(dBi)
0	2412 ~ 2462	PIFA	1.5
1	2412 ~ 2452	PIFA	1.5

IEEE Std. 802.11	Transmit and Receive Mode	Description
b	1TX, 1RX	Antenna 1, 2 can be used as transmitting/receiving antenna.
g	1TX, 1RX	Antenna 1, 2 can be used as transmitting/receiving antenna.
n HT20	2TX, 2RX	Antenna 1, 2 can be used as transmitting/receiving antenna.
n HT40	2TX, 2RX	Antenna 1, 2 can be used as transmitting/receiving antenna.

Note: 1. Only 802.11n HT20/HT40 support MIMO mode  
2. BT & 2.4 GHz WLAN, BT & 5 GHz WLAN can transmit simultaneously. (Declared by customer.)

Note: The value of the antenna gain was declared by customer.

## 5.5. DESCRIPTION OF TEST SETUP

### SUPPORT EQUIPMENT

Item	Equipment	Brand Name	Model Name	Remarks
1	laptop	Dell	Vostro 3902	/
2	Test fixture	/	/	/
3	Switching Adapter	FLYPOWER	PS65IBCAY5000H	Input: AC 100-240 V, 50/60 Hz, 1.5A Output: DC 12.0 V, 5000 mA

### I/O CABLES

Cable No	Port	Connector Type	Cable Type	Cable Length(m)	Remarks
1	USB	USB	Unshielded	1	/

### ACCESSORIES

Item	Accessory	Brand Name	Model Name	Description
/	/	/	/	/

### TEST SETUP

The EUT can work in engineering mode with a software through a Laptop.

### SETUP DIAGRAM FOR TESTS

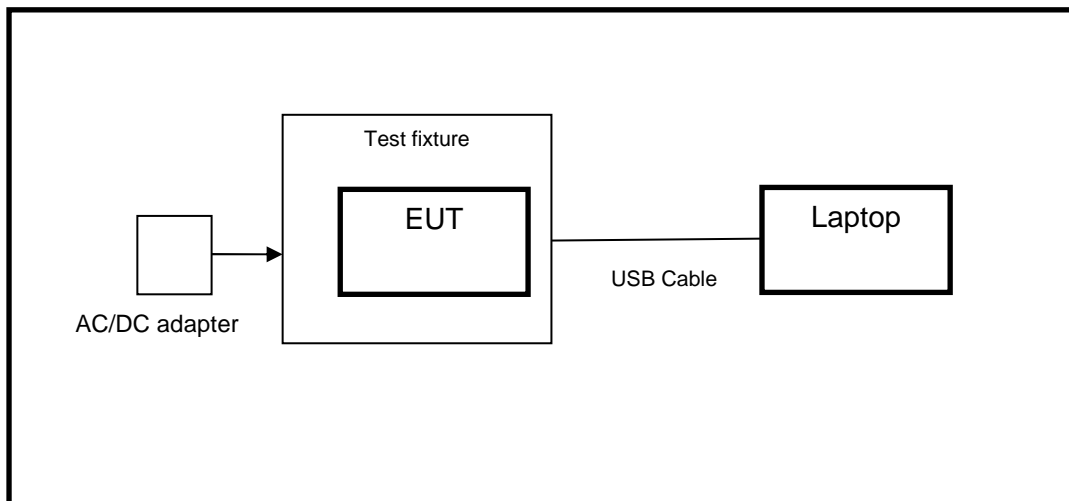

**6. MEASURING INSTRUMENT AND SOFTWARE USED**

Radiated Emissions					
Equipment	Manufacturer	Model No.	Serial No.	Last Cal.	Due Date
MXE EMI Receiver	KESIGHT	N9038A	MY56400036	Nov. 12, 2020	Nov. 11, 2021
Hybrid Log Periodic Antenna	TDK	HLP-3003C	130960	Aug. 11, 2018	Aug. 10, 2021
Preamplifier	HP	8447D	2944A09099	Nov. 12, 2020	Nov. 11, 2021
EMI Measurement Receiver	R&S	ESR26	101377	Nov. 12, 2020	Nov. 11, 2021
Horn Antenna	TDK	HRN-0118	130939	Sept. 17, 2018	Sept. 17, 2021
Preamplifier	TDK	PA-02-0118	TRS-305-00067	Nov. 20, 2020	Nov. 19, 2021
Horn Antenna	Schwarzbeck	BBHA9170	#691	Aug. 11, 2018	Aug. 11, 2021
Preamplifier	TDK	PA-02-2	TRS-307-00003	Nov. 12, 2020	Nov. 11, 2021
Preamplifier	TDK	PA-02-3	TRS-308-00002	Nov. 12, 2020	Nov. 11, 2021
Loop antenna	Schwarzbeck	1519B	00008	Jan.17, 2019	Jan.17,2022
Preamplifier	TDK	PA-02-001-3000	TRS-302-00050	Nov. 12, 2020	Nov. 11, 2021
Preamplifier	Mini-Circuits	ZX60-83LN-S+	SUP01201941	Nov. 20, 2020	Nov. 19, 2021
High Pass Filter	Wi	WHKX10-2700-3000-18000-40SS	23	Nov. 12, 2020	Nov. 11, 2021
Software					
Description			Manufacturer	Name	Version
Test Software for Radiated Emissions			Farad	EZ-EMC	Ver. UL-3A1

Other Instruments					
Equipment	Manufacturer	Model No.	Serial No.	Last Cal.	Next Cal.
Spectrum Analyzer	Keysight	N9020A	MY49100060	Nov. 20, 2020	Nov. 19, 2021
Dual Channel Power Meter	Keysight	N1912A	MY55416024	Nov. 20, 2020	Nov. 19, 2021
Power Sensor	Keysight	USB Wideband Power Sensor	MY5100022	Nov. 20, 2020	Nov. 19, 2021

## 7. ANTENNA PORT TEST RESULTS

### 7.1. CONDUCTED OUTPUT POWER

#### LIMITS

CFR 47 FCC Part15 (15.247) Subpart C ISED RSS-247 ISSUE 2			
Section	Test Item	Limit	Frequency Range (MHz)
CFR 47 FCC 15.247(b)(3) ISED RSS-247 5.4 (d)	AVG Output Power	1 watt or 30 dBm	2400-2483.5

#### TEST PROCEDURE

Refer to ANSI C63.10-2013 clause 11.9.

Connect the EUT to a low loss RF cable from the antenna port to the power sensor (video bandwidth is greater than the occupied bandwidth).

Measure peak emission level, the indicated level is the average output power, after any corrections for external attenuators and cables.

#### TEST SETUP

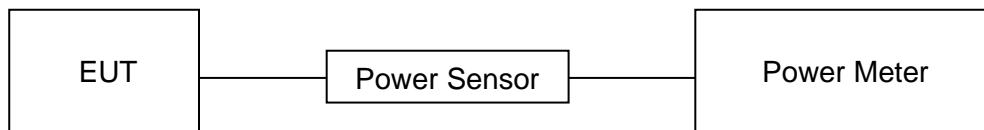

#### TEST ENVIRONMENT

Temperature	24.4 °C	Relative Humidity	34.4 %
Atmosphere Pressure	101 kPa	Test Voltage	DC 3.3 V

#### RESULTS



## Spot Check Verification Summary:

Test Item	Test Mode	Frequency	Antenna	Worst Case Test Result	
				Original Model	Spot Check Model
Conducted AV Power	802.11b	2437 MHz	0	15.12 dBm	15.63 dBm
			1	15.83 dBm	15.52 dBm
	802.11g	2437 MHz	0	14.21 dBm	14.22 dBm
			1	16.32 dBm	14.68 dBm
	802.11n HT20	2437 MHz	0	12.48 dBm	13.27 dBm
			1	14.44 dBm	13.38 dBm
	802.11n HT40	2437 MHz	0	12.50 dBm	13.21 dBm
			1	14.77 dBm	13.64 dBm

## Conclusion:

The spot check test result show that the new devices still comply with the standard and the new test result was close to the original test result, so it can demonstrate that the referenced test data remains valid for the new device.



## Test Data:

Mode	Frequency (MHz)	Antenna	Conducted AV Power		Total		Limit
			(dBm)	(mW)	(mW)	(dBm)	(dBm)
802.11b	2412	0	15.02	31.77	65.19	18.14	30
		1	15.24	33.42			
	2437	0	15.63	36.56	72.20	18.59	30
		1	15.52	35.65			
	2462	0	15.43	34.91	70.15	18.46	30
		1	15.47	35.24			
802.11g	2412	0	13.97	24.95	50.71	17.05	30
		1	14.11	25.76			
	2437	0	14.22	26.42	55.80	17.47	30
		1	14.68	29.38			
	2462	0	14.15	26.00	53.86	17.31	30
		1	14.45	27.86			
802.11n HT20	2412	0	13.26	21.18	42.81	16.32	30
		1	13.35	21.63			
	2437	0	13.27	21.23	43.01	16.34	30
		1	13.38	21.78			
	2462	0	13.06	20.23	40.84	16.11	30
		1	13.14	20.61			
802.11n HT40	2422	0	13.18	20.80	41.79	16.21	30
		1	13.22	20.99			
	2437	0	13.21	20.94	44.06	16.44	30
		1	13.64	23.12			
	2452	0	13.12	20.51	42.74	16.31	30
		1	13.47	22.23			

## 8. RADIATED TEST RESULTS

### LIMITS

Please refer to CFR 47 FCC §15.205 and §15.209.

Please refer to ISED RSS-GEN Clause 8.9 and Clause 8.10.

Radiation Disturbance Test Limit for FCC (Class B) (9 kHz ~ 1 GHz)

Emissions radiated outside of the specified frequency bands above 30 MHz			
Frequency Range (MHz)	Field Strength Limit (uV/m) at 3 m	Field Strength Limit (dBuV/m) at 3 m	
		Quasi-Peak	
30 - 88	100	40	
88 - 216	150	43.5	
216 - 960	200	46	
Above 960	500	54	
Above 1000	500	Peak	Average
		74	54

FCC Emissions radiated outside of the specified frequency bands below 30 MHz		
Frequency (MHz)	Field strength (microvolts/meter)	Measurement distance (meters)
0.009-0.490	2400/F(kHz)	300
0.490-1.705	24000/F(kHz)	30
1.705-30.0	30	30

ISED General field strength limits at frequencies below 30 MHz

Table 6 – General field strength limits at frequencies below 30 MHz		
Frequency	Magnetic field strength (H-Field) (µA/m)	Measurement distance (m)
9 - 490 kHz <sup>Note 1</sup>	6.37/F (F in kHz)	300
490 - 1705 kHz	63.7/F (F in kHz)	30
1.705 - 30 MHz	0.08	30

**Note 1:** The emission limits for the ranges 9-90 kHz and 110-490 kHz are based on measurements employing a linear average detector.



ISED Restricted bands please refer to ISED RSS-GEN Clause 8.10

**Table 7 – Restricted frequency bands<sup>Note 1</sup>**

MHz	MHz	GHz
0.090 - 0.110	149.9 - 150.05	9.0 - 9.2
0.495 - 0.505	166.52475 - 166.52525	9.3 - 9.5
2.1735 - 2.1905	166.7 - 166.9	10.6 - 12.7
3.020 - 3.028	162.0125 - 167.17	13.25 - 13.4
4.125 - 4.128	167.72 - 173.2	14.47 - 14.5
4.17725 - 4.17775	240 - 285	15.35 - 16.2
4.20725 - 4.20775	322 - 335.4	17.7 - 21.4
5.677 - 5.683	399.9 - 410	22.01 - 23.12
6.215 - 6.218	608 - 614	23.6 - 24.0
6.26775 - 6.26825	960 - 1427	31.2 - 31.8
6.31175 - 6.31225	1435 - 1626.5	36.43 - 36.5
8.291 - 8.294	1045.5 - 1646.5	Above 38.6
8.362 - 8.366	1660 - 1710	
8.37625 - 8.38675	1718.8 - 1722.2	
8.41425 - 8.41475	2200 - 2300	
12.29 - 12.293	2310 - 2390	
12.51975 - 12.52025	2483.5 - 2500	
12.57675 - 12.57725	2655 - 2900	
13.36 - 13.41	3260 - 3267	
16.42 - 16.423	3332 - 3339	
16.69475 - 16.69525	3345.8 - 3358	
16.80425 - 16.80475	3500 - 4400	
25.5 - 25.67	4500 - 5150	
37.5 - 38.25	5350 - 5460	
73 - 74.6	7250 - 7750	
74.8 - 75.2	8025 - 8500	
108 - 138		

**Note 1:** Certain frequency bands listed in table 7 and in bands above 38.6 GHz are designated for licence-exempt applications. These frequency bands and the requirements that apply to related devices are set out in the 200 and 300 series of RSSs.

FCC Restricted bands of operation refer to FCC §15.205 (a):

MHz	MHz	MHz	GHz
0.090-0.110	16.42-16.423	399.9-410	4.5-5.15
<sup>1</sup> 0.495-0.505	16.69475-16.69525	608-614	5.35-5.46
2.1735-2.1905	16.80425-16.80475	960-1240	7.25-7.75
4.125-4.128	25.5-25.67	1300-1427	8.025-8.5
4.17725-4.17775	37.5-38.25	1435-1626.5	9.0-9.2
4.20725-4.20775	73-74.6	1645.5-1646.5	9.3-9.5
6.215-6.218	74.8-75.2	1660-1710	10.6-12.7
6.26775-6.26825	108-121.94	1718.8-1722.2	13.25-13.4
6.31175-6.31225	123-138	2200-2300	14.47-14.5
8.291-8.294	149.9-150.05	2310-2390	15.35-16.2
8.362-8.366	156.52475-156.52525	2483.5-2500	17.7-21.4
8.37625-8.38675	156.7-156.9	2690-2900	22.01-23.12
8.41425-8.41475	162.0125-167.17	3260-3267	23.6-24.0
12.29-12.293	167.72-173.2	3332-3339	31.2-31.8
12.51975-12.52025	240-285	3345.8-3358	36.43-36.5
12.57675-12.57725	322-335.4	3600-4400	( <sup>2</sup> )
13.36-13.41			

Note: <sup>1</sup>Until February 1, 1999, this restricted band shall be 0.490-0.510 MHz.

<sup>2</sup>Above 38.6c



## TEST SETUP AND PROCEDURE

Below 30 MHz

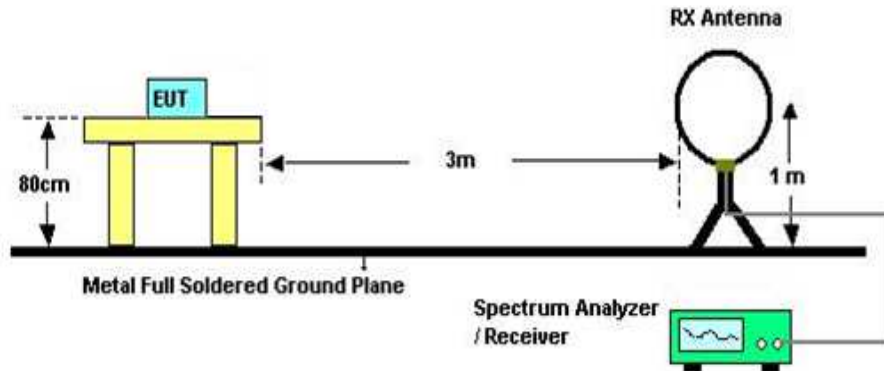

The setting of the spectrum analyser

RBW	200 Hz (From 9 kHz to 0.15 MHz) / 9 kHz (From 0.15 MHz to 30 MHz)
VBW	200 Hz (From 9 kHz to 0.15 MHz) / 9 kHz (From 0.15 MHz to 30 MHz)
Sweep	Auto
Trace	Max hold

1. The testing follows the guidelines in ANSI C63.10-2013 clause 11.11.
2. The EUT was arranged to its worst case and then turntable (from 0 degree to 360 degrees) to find the maximum reading. A pre-amp and a high pass filter are used for the test in order to get better signal level. Both Horizontal, Face-on and Face-off polarizations of the antenna are set to make the measurement.
3. The EUT was placed on a turntable with 80cm above ground.
4. The EUT was set 3 meters from the interference receiving antenna, which was mounted on the top of a 1 m height antenna tower.
5. The radiated emission limits are based on measurements employing a CISPR quasi-peak detector except for the frequency bands 9-90 kHz, 110-490 kHz and above 1000 MHz. Radiated emission limits in these three bands are based on measurements employing an average detector.
6. For measurement below 1 GHz, the initial step in collecting conducted emission data is a spectrum analyzer peak detector mode pre-scanning the measurement frequency range. Significant peaks are then marked and then Quasi Peak and average detector mode re-measured. If the emission level of the EUT measured by the peak detector is 3 dB lower than the applicable limit, the peak emission level will be reported. Otherwise, the emission measurement will be repeated using the quasi-peak and average detector and reported.
7. Although these tests were performed other than open field site, adequate comparison measurements were confirmed against 30 m open field site. Therefore sufficient tests were made to demonstrate that the alternative site produces results that correlate with the ones of tests made in an open field site based on KDB 414788.

Below 1 GHz and above 30 MHz

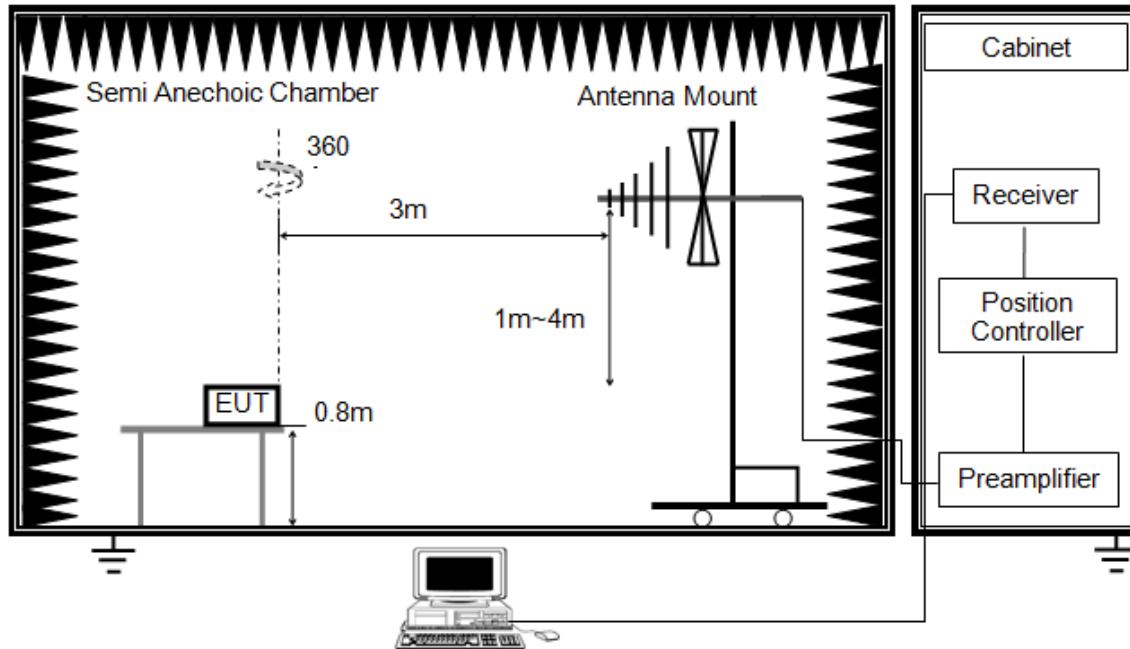

The setting of the spectrum analyser

RBW	120 kHz
VBW	300 kHz
Sweep	Auto
Detector	Peak/QP
Trace	Max hold

1. The testing follows the guidelines in ANSI C63.10-2013 clause 11.11.
2. The EUT was arranged to its worst case and then tune the antenna tower (from 1 m to 4 m) and turntable (from 0 degree to 360 degrees) to find the maximum reading. A pre-amp and a high pass filter are used for the test in order to get better signal level. Both horizontal and vertical polarizations of the antenna are set to make the measurement.
3. The EUT was placed on a turntable with 80 cm above ground.
4. The EUT was set 3 meters from the interference receiving antenna, which was mounted on the top of a variable height antenna tower.
5. For measurement below 1 GHz, the initial step in collecting conducted emission data is a spectrum analyzer peak detector mode pre-scanning the measurement frequency range. Significant peaks are then marked and then Quasi Peak detector mode re-measured. If the emission level of the EUT measured by the peak detector is 3 dB lower than the applicable limit, the peak emission level will be reported. Otherwise, the emission measurement will be repeated using the quasi-peak detector and reported.

Above 1 GHz

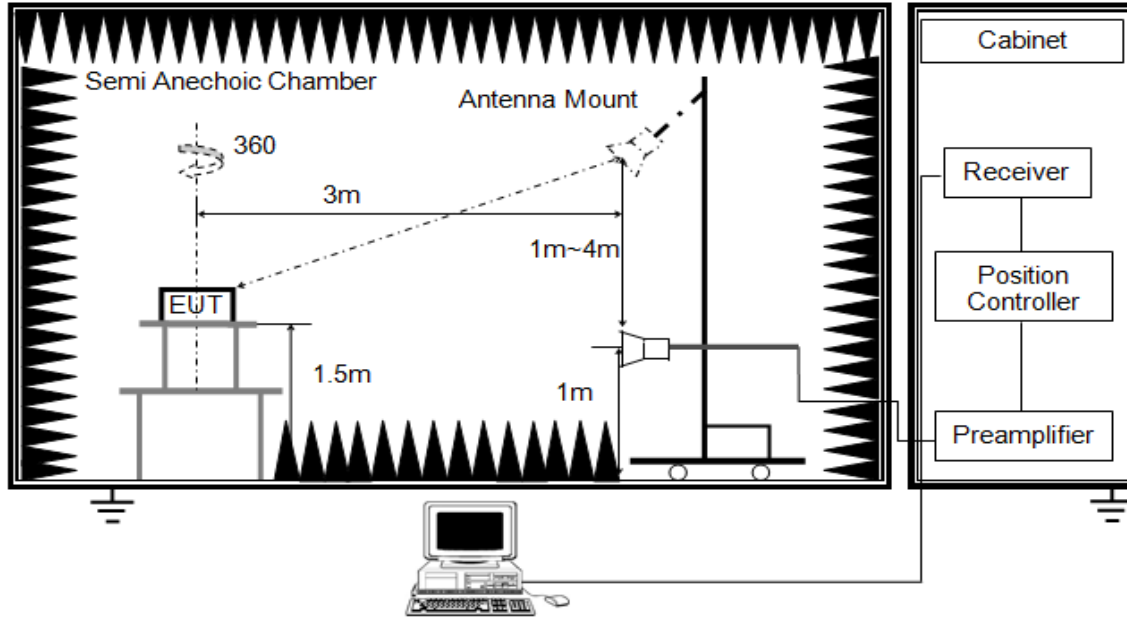

The setting of the spectrum analyser

RBW	1 MHz
VBW	PEAK: 3 MHz AVG: see note 6
Sweep	Auto
Detector	Peak
Trace	Max hold

1. The testing follows the guidelines in ANSI C63.10-2013 clause 11.11 and 11.12.
2. The EUT was arranged to its worst case and then tune the antenna tower (1.5 m) and turntable (from 0 degree to 360 degrees) to find the maximum reading. A pre-amp and a high pass filter are used for the test in order to get better signal level. Both horizontal and vertical polarizations of the antenna are set to make the measurement.
3. The EUT was placed on a turntable with 1.5 m above ground.
4. The EUT was set 3 meters from the interference receiving antenna, which was mounted on the top of a variable height antenna tower.
5. For measurement above 1 GHz, the emission measurement will be measured by the peak detector. This peak level, once corrected, must comply with the limit specified in Section 15.209.
6. For measurements above 1 GHz the resolution bandwidth is set to 1 MHz, then the video bandwidth is set to 3 MHz for peak measurements and 1 MHz resolution bandwidth with 1/T video bandwidth with peak detector for average measurements. For the Duty Cycle please refer to clause 7.1.ON TIME AND DUTY CYCLE.

X axis, Y axis, Z axis positions:

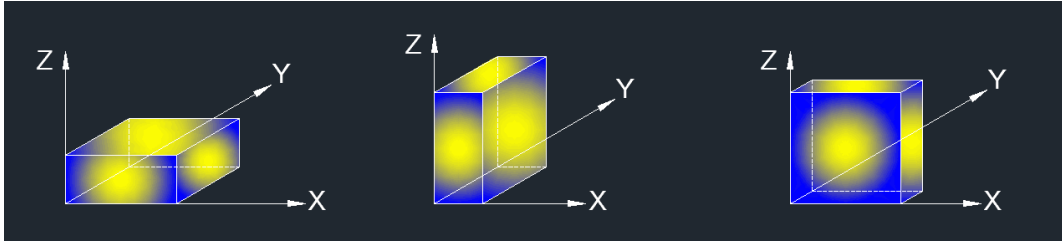

Note 1: For all radiated test, EUT in each of three orthogonal axis emissions had been tested, but only the worst case (X axis) data recorded in the report.

Note 2: Simultaneous transmission had been evaluated with the 2.4 GHz WiFi, 5 GHz WiFi and BT transmitter and there were no any additional or worse emissions found. Only the worst data was recorded in the test report.

Note 3: The EUT was fully exercised with external accessories during the test. In the case of multiple accessory external ports, an external accessory shall be connected to one of each type of port.

### **TEST ENVIRONMENT**

Temperature	19.3 °C	Relative Humidity	50.6 %
Atmosphere Pressure	101 kPa	Test Voltage	DC 3.3 V

### **RESULTS**

**8.1.1. SPOT CHECK VERIFICATION SUMMARY**

Test Item	Test Mode	Test Channel	Frequency	Worst Case Test Result	
				Original Model	Spot Check Model
		MHz	MHz	dBuV/m	
Restricted Bandedge	802.11b	2412	2390	49.48	48.51
Spurious Emission	802.11b	2412	4824 (2 <sup>th</sup> harmonic)	45.85	48.49

**Conclusion:**

The spot check test result show that the new devices still comply with the standard and the new test result was close to the original test result, so it can demonstrate that the referenced test data remains valid for the new device.

## 8.2. RESTRICTED BANDEDGE

### 8.2.1. 802.11b SISO MODE AND BT MODE WORST CASE

#### RESTRICTED BANDEDGE (802.11b MODE LOW CHANNEL, BT 8DQPSK MIDDLE CHANNEL, HORIZONTAL)

#### PEAK

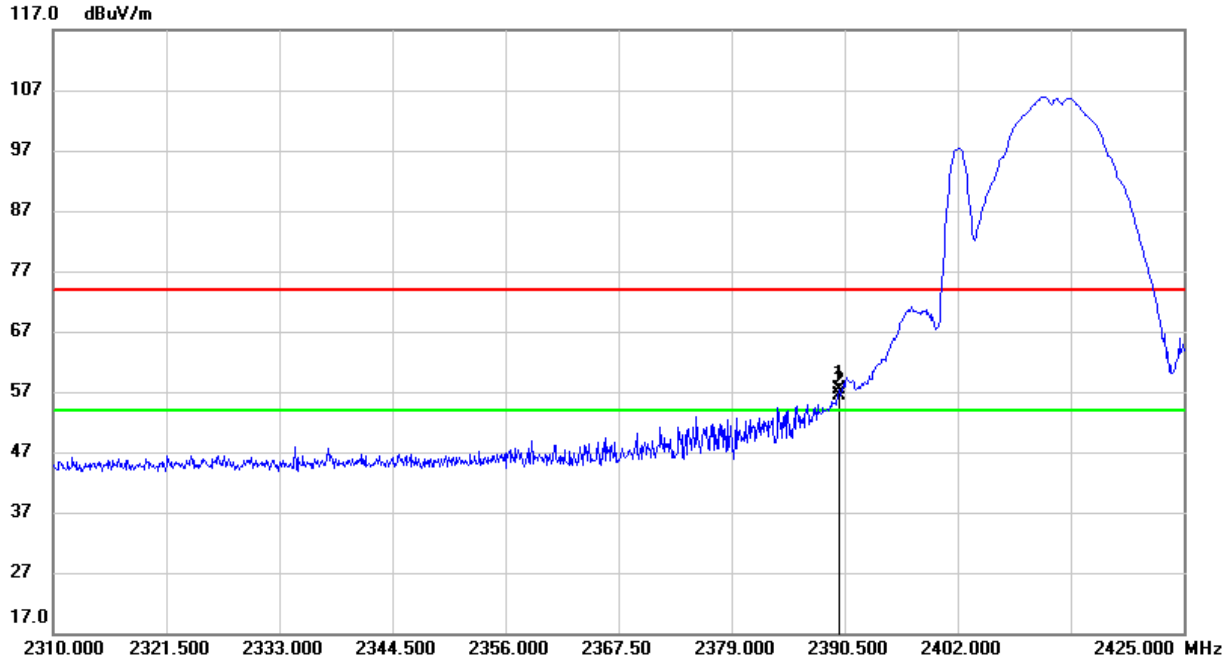

No.	Frequency (MHz)	Reading (dBuV)	Correct (dB/m)	Result (dBuV/m)	Limit (dBuV/m)	Margin (dB)	Remark
1	2389.925	45.84	11.59	57.43	74.00	-16.57	peak
2	2390.000	44.87	11.59	56.46	74.00	-17.54	peak

- Note: 1. Measurement = Reading Level + Correct Factor.  
 2. If Peak Result complies with AV limit, AV Result is deemed to comply with AV limit.  
 3. Peak: Peak detector.  
 4. Only the worst data was recorded, if it complies with the limit, the other emissions deemed to comply with the limit.



**AVERAGE**

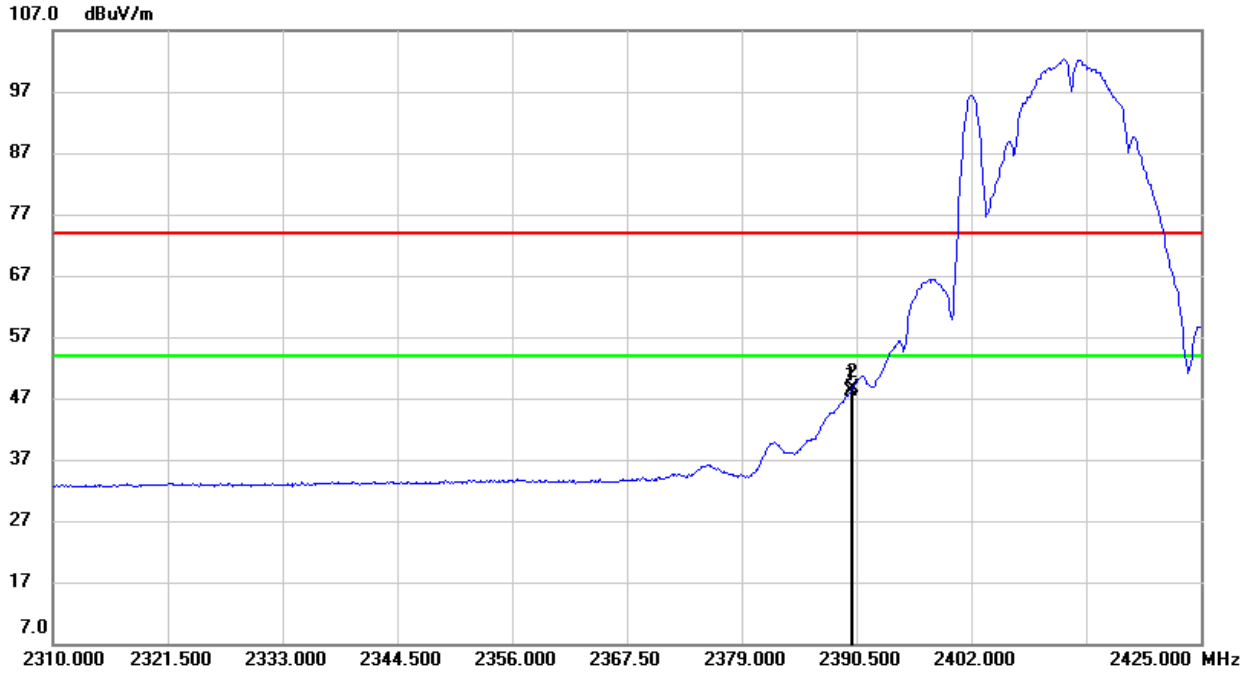

No.	Frequency (MHz)	Reading (dBuV)	Correct (dB/m)	Result (dBuV/m)	Limit (dBuV/m)	Margin (dB)	Remark
1	2389.925	36.51	11.59	48.10	54.00	-5.90	AVG
2	2390.000	36.92	11.59	48.51	54.00	-5.49	AVG

- Note:
1. Measurement = Reading Level + Correct Factor.
  2. If Peak Result complies with AV limit, AV Result is deemed to comply with AV limit.
  3. AVG:  $VBW=1/T_{on}$ , where:  $T_{on}$  is the transmitting duration.
  4. For the transmitting duration, please refer to clause 7.1.
  5. Only the worst data was recorded, if it complies with the limit, the other emissions deemed to comply with the limit.

Note: Both horizontal and vertical had been tested, but only the worst data was recorded in the report.

### 8.3. SPURIOUS EMISSIONS (1 GHz ~ 3 GHz)

#### 8.3.1. 802.11b MIMO MODE AND BT MODE WORST CASE

##### HARMONICS AND SPURIOUS EMISSIONS (802.11b MODE LOW CHANNEL, BT 8DQPSK MIDDLE CHANNEL, HORIZONTAL)

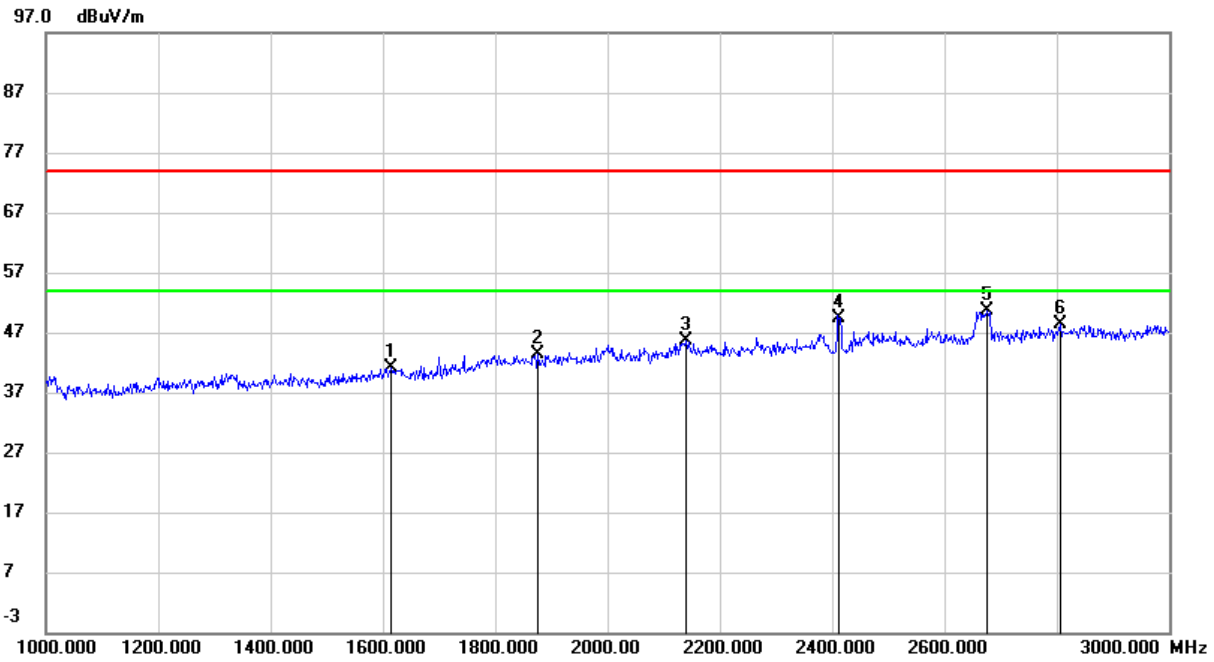

No.	Frequency (MHz)	Reading (dBuV)	Correct (dB/m)	Result (dBuV/m)	Limit (dBuV/m)	Margin (dB)	Remark
1	1614.000	33.09	7.94	41.03	74.00	-32.97	peak
2	1876.000	33.53	9.76	43.29	74.00	-30.71	peak
3	2140.000	34.76	10.87	45.63	74.00	-28.37	peak
4	2412.000	37.58	11.71	49.29	74.00	-24.71	peak
5	2676.000	38.32	12.37	50.69	74.00	-23.31	peak
6	2806.000	35.03	13.25	48.28	74.00	-25.72	peak

Note: 1. Measurement = Reading Level + Correct Factor.

2. If Peak Result complies with AV limit, AV Result is deemed to comply with AV limit.

3. Peak: Peak detector.

4. Filter losses were only considered in the spurious frequency bands and the authorized band was not corrected for Band reject filter losses.

5. Proper operation of the transmitter prior to adding the filter to the measurement chain.

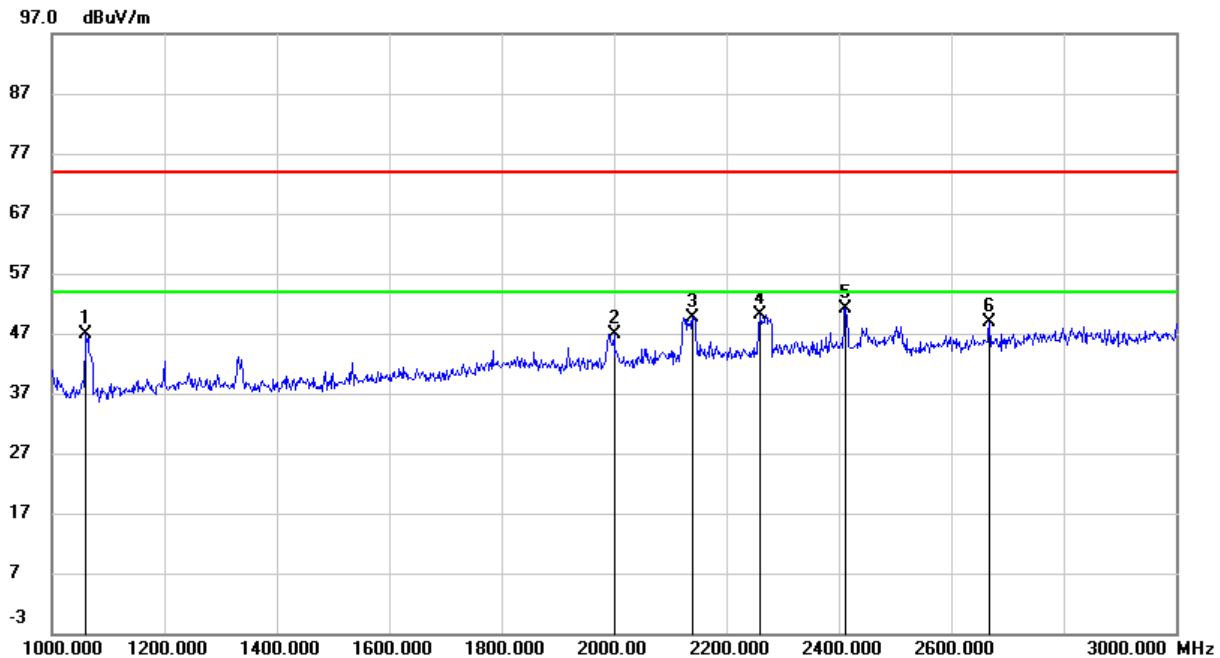

**HARMONICS AND SPURIOUS EMISSIONS (802.11b MODE LOW CHANNEL, BT 8DQPSK MIDDLE CHANNEL, VERTICAL)**

No.	Frequency (MHz)	Reading (dBuV)	Correct (dB/m)	Result (dBuV/m)	Limit (dBuV/m)	Margin (dB)	Remark
1	1060.000	41.68	5.29	46.97	74.00	-27.03	peak
2	2000.000	36.95	10.03	46.98	74.00	-27.02	peak
3	2140.000	38.79	10.87	49.66	74.00	-24.34	peak
4	2260.000	39.12	11.00	50.12	74.00	-23.88	peak
5	2412.000	39.33	11.71	51.04	74.00	-22.96	peak
6	2668.000	36.59	12.33	48.92	74.00	-25.08	peak

Note: 1. Measurement = Reading Level + Correct Factor.

2. If Peak Result complies with AV limit, AV Result is deemed to comply with AV limit.

3. Peak: Peak detector.

4. Filter losses were only considered in the spurious frequency bands and the authorized band was not corrected for Band reject filter losses.

5. Proper operation of the transmitter prior to adding the filter to the measurement chain.

Note: All the modes had been tested, only the worst data was recorded in the report.



## 8.4. SPURIOUS EMISSIONS (3 GHz ~ 18 GHz)

### 8.4.1. 802.11b MODE AND BT MODE WORST CASE

#### HARMONICS AND SPURIOUS EMISSIONS (802.11b MODE LOW CHANNEL, BT 8DQPSK MIDDLE CHANNEL, HORIZONTAL)

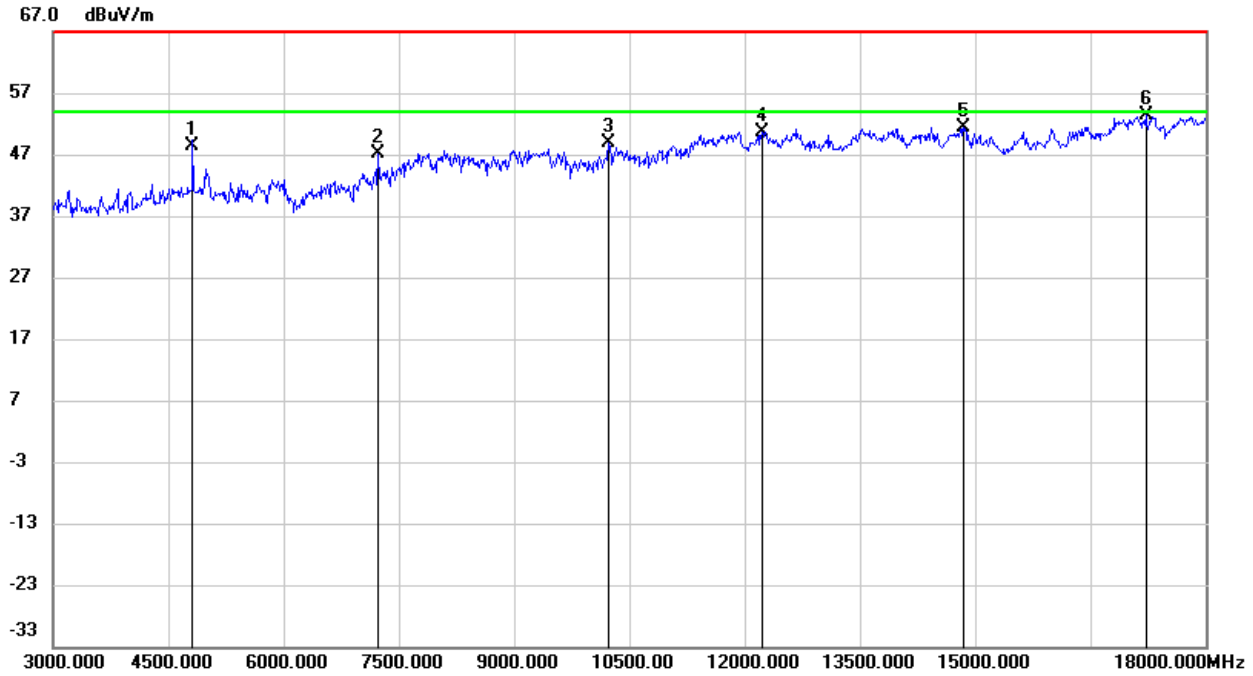

No.	Frequency (MHz)	Reading (dBuV)	Correct (dB/m)	Result (dBuV/m)	Limit (dBuV/m)	Margin (dB)	Remark
1	4824.000	47.11	1.38	48.49	74.00	-25.51	peak
2	7230.000	39.86	7.28	47.14	74.00	-26.86	peak
3	10230.000	36.25	11.58	47.83	74.00	-26.17	peak
4	12225.000	34.56	15.99	50.55	74.00	-23.45	peak
5	14850.000	33.76	17.71	51.47	74.00	-22.53	peak
6	17220.000	31.14	22.12	53.26	74.00	-20.74	peak

Note: 1. Peak Result = Reading Level + Correct Factor.

2. If Peak Result complies with AV limit, AV Result is deemed to comply with AV limit.

3. Peak: Peak detector.

4. AVG:  $VBW=1/Ton$ , where: Ton is the transmitting duration.

5. For the transmitting duration, please refer to clause 7.1.

6. Filter losses were only considered in the spurious frequency bands and the authorized band was not corrected for High Pass Filter losses.

7. Proper operation of the transmitter prior to adding the filter to the measurement chain.

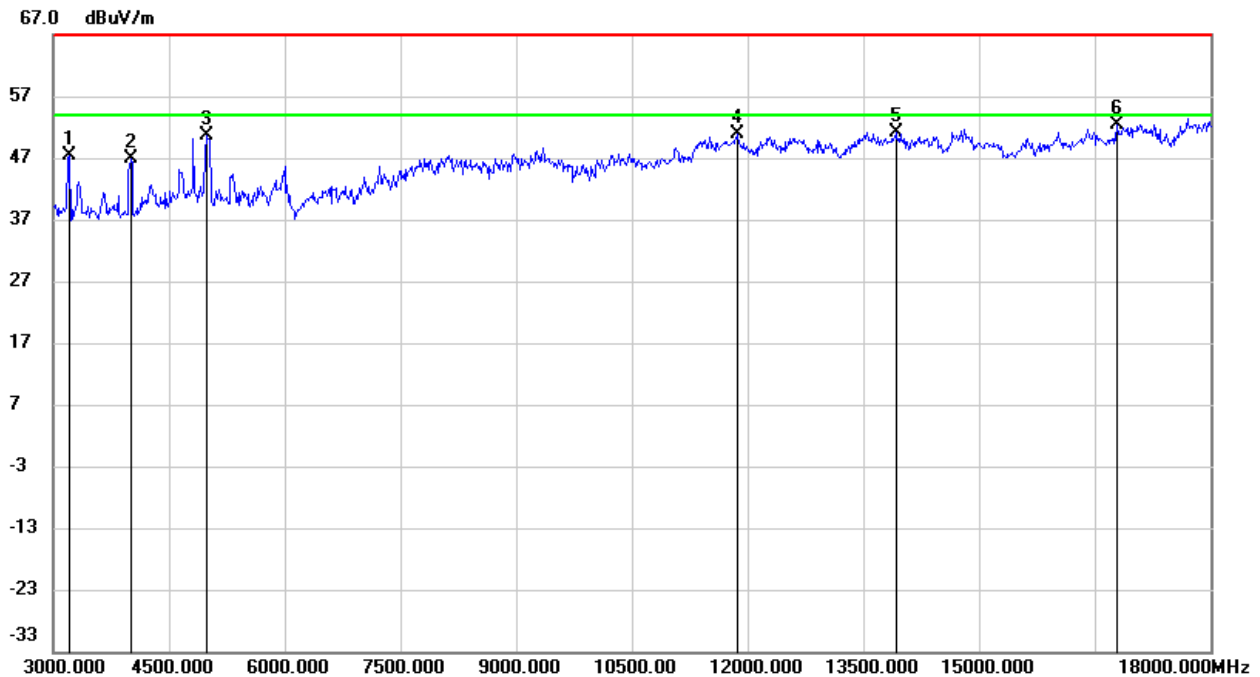
**HARMONICS AND SPURIOUS EMISSIONS (802.11b MODE LOW CHANNEL, BT 8DQPSK MIDDLE CHANNEL, VERTICAL)**

No.	Frequency (MHz)	Reading (dBuV)	Correct (dB/m)	Result (dBuV/m)	Limit (dBuV/m)	Margin (dB)	Remark
1	3210.000	51.19	-3.91	47.28	74.00	-26.72	peak
2	4005.000	49.44	-2.46	46.98	74.00	-27.02	peak
3	4995.000	48.61	2.10	50.71	74.00	-23.29	peak
4	11865.000	35.38	15.42	50.80	74.00	-23.20	peak
5	13920.000	33.55	17.55	51.10	74.00	-22.90	peak
6	16785.000	31.71	20.59	52.30	74.00	-21.70	peak

- Note: 1. Peak Result = Reading Level + Correct Factor.  
 2. If Peak Result complies with AV limit, AV Result is deemed to comply with AV limit.  
 3. Peak: Peak detector.  
 4. AVG:  $VBW=1/Ton$ , where: Ton is the transmitting duration.  
 5. For the transmitting duration, please refer to clause 7.1.  
 6. Filter losses were only considered in the spurious frequency bands and the authorized band was not corrected for High Pass Filter losses.  
 7. Proper operation of the transmitter prior to adding the filter to the measurement chain.

Note: All the modes had been tested, but only the worst data was recorded in the report.

## 8.5. SPURIOUS EMISSIONS (18 GHz ~ 26 GHz)

### 8.5.1. 802.11b MIMO MODE AND BT MODE WORST CASE

#### SPURIOUS EMISSIONS (802.11b MODE LOW CHANNEL, BT 8DQPSK MIDDLE CHANNEL, HORIZONTAL)

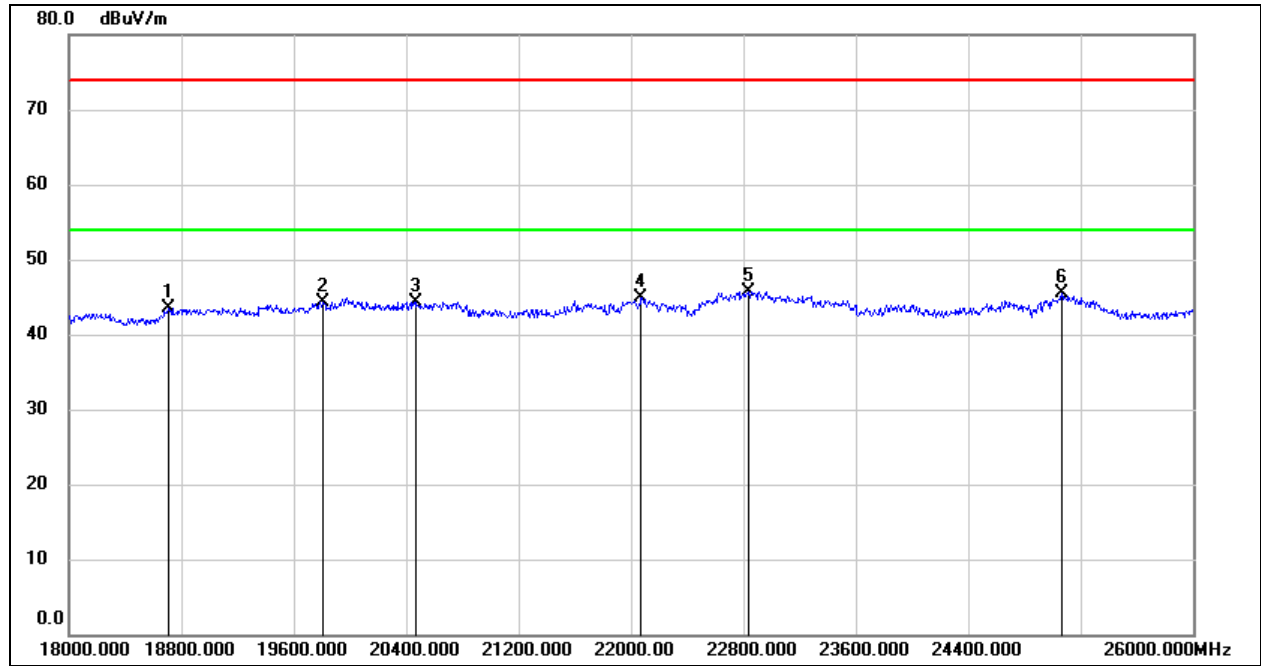

No.	Frequency (MHz)	Reading (dBuV)	Correct (dB/m)	Result (dBuV/m)	Limit (dBuV/m)	Margin (dB)	Remark
1	18712.000	48.87	-5.40	43.47	74.00	-30.53	peak
2	19808.000	49.59	-5.29	44.30	74.00	-29.70	peak
3	20472.000	49.69	-5.39	44.30	74.00	-29.70	peak
4	22072.000	49.27	-4.41	44.86	74.00	-29.14	peak
5	22840.000	49.26	-3.60	45.66	74.00	-28.34	peak
6	25064.000	47.42	-1.99	45.43	74.00	-28.57	peak

Note: 1. Measurement = Reading Level + Correct Factor.

2. If Peak Result complies with AV limit, AV Result is deemed to comply with AV limit.

3. Peak: Peak detector.

4. The preamplifier only effect to the above 18GHz signal and no filter added to the measurement chain.



**SPURIOUS EMISSIONS (802.11b MODE LOW CHANNEL, BT 8DQPSK MIDDLE CHANNEL, VERTICAL)**

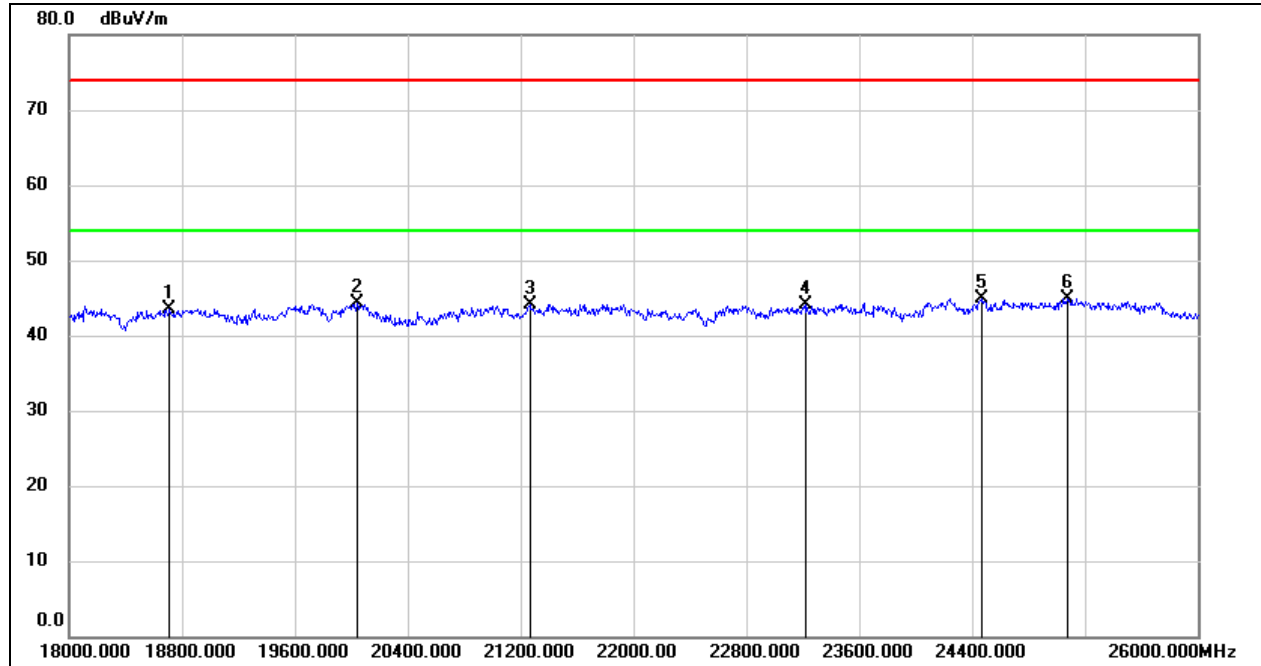

No.	Frequency (MHz)	Reading (dBuV)	Correct (dB/m)	Result (dBuV/m)	Limit (dBuV/m)	Margin (dB)	Remark
1	18712.000	48.90	-5.40	43.50	74.00	-30.50	peak
2	20040.000	49.71	-5.48	44.23	74.00	-29.77	peak
3	21264.000	48.85	-4.76	44.09	74.00	-29.91	peak
4	23216.000	47.51	-3.38	44.13	74.00	-29.87	peak
5	24472.000	47.37	-2.38	44.99	74.00	-29.01	peak
6	25072.000	46.86	-1.97	44.89	74.00	-29.11	peak

Note: 1. Measurement = Reading Level + Correct Factor.  
 2. If Peak Result complies with AV limit, AV Result is deemed to comply with AV limit.  
 3. Peak: Peak detector.  
 4. The preamplifier only effect to the above 18GHz signal and no filter added to the measurement chain.

Note: All the modes had been tested, but only the worst data was recorded in the report.



## 8.6. SPURIOUS EMISSIONS (30 MHz ~ 1 GHz)

### 8.6.1. 802.11b MODE AND BT MODE WORST CASE

#### SPURIOUS EMISSIONS (802.11b MODE LOW CHANNEL, BT 8DQPSK MIDDLE CHANNEL, HORIZONTAL)

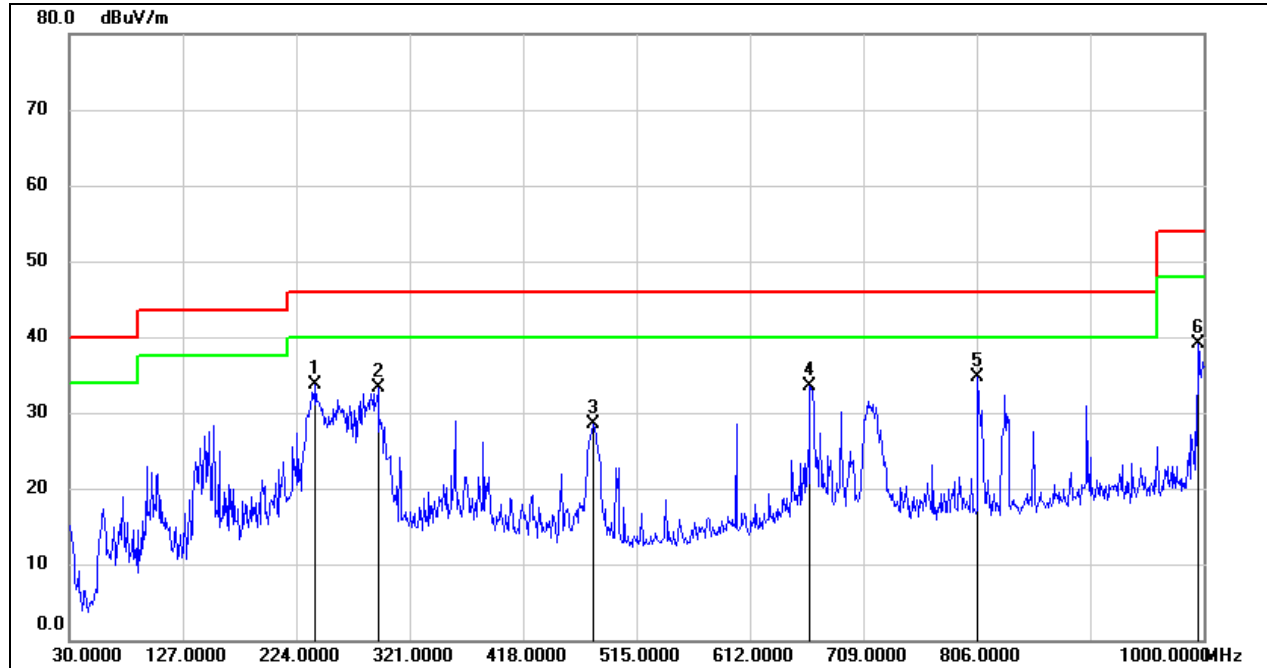

No.	Frequency (MHz)	Reading (dBuV)	Correct (dB/m)	Result (dBuV/m)	Limit (dBuV/m)	Margin (dB)	Remark
1	240.4900	52.91	-19.17	33.74	46.00	-12.26	QP
2	293.8400	48.98	-15.68	33.30	46.00	-12.70	QP
3	478.1400	40.38	-11.83	28.55	46.00	-17.45	QP
4	663.4099	42.13	-8.66	33.47	46.00	-12.53	QP
5	806.9699	41.84	-7.19	34.65	46.00	-11.35	QP
6	995.1500	43.22	-4.20	39.02	54.00	-14.98	QP

Note: 1. Result Level = Read Level + Correct Factor.

2. If Peak Result complies with QP limit, QP Result is deemed to comply with QP limit.

3. Test setup: RBW: 120 kHz, VBW: 300 kHz, Sweep time: auto.

**SPURIOUS EMISSIONS (802.11b MODE LOW CHANNEL, BT 8DQPSK MIDDLE CHANNEL, VERTICAL)**

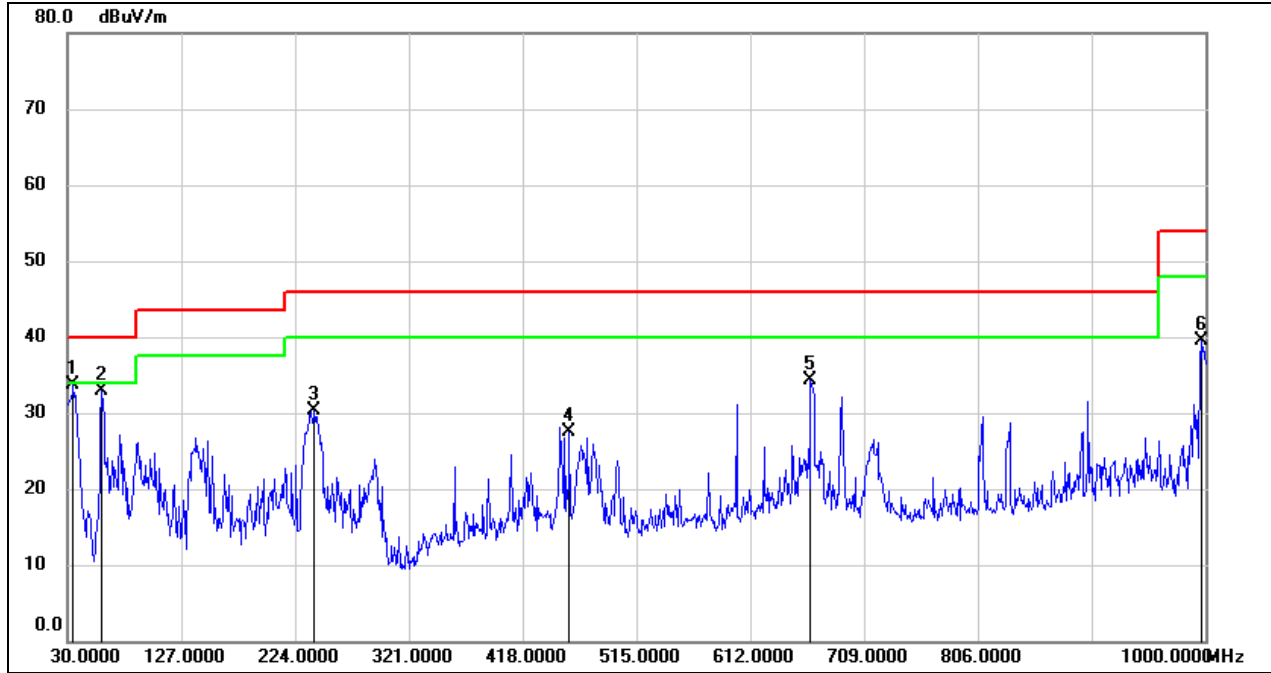

No.	Frequency (MHz)	Reading (dBuV)	Correct (dB/m)	Result (dBuV/m)	Limit (dBuV/m)	Margin (dB)	Remark
1	34.8500	53.10	-19.40	33.70	40.00	-6.30	QP
2	59.1000	53.48	-20.52	32.96	40.00	-7.04	QP
3	240.4900	49.49	-19.17	30.32	46.00	-15.68	QP
4	457.7700	39.63	-12.20	27.43	46.00	-18.57	QP
5	663.4099	43.06	-8.66	34.40	46.00	-11.60	QP
6	996.1200	43.62	-4.20	39.42	54.00	-14.58	QP

- Note: 1. Result Level = Read Level + Correct Factor.  
 2. If Peak Result complies with QP limit, QP Result is deemed to comply with QP limit.  
 3. Test setup: RBW: 120 kHz, VBW: 300 kHz, Sweep time: auto

Note: All the modes had been tested, but only the worst data was recorded in the report.

## 8.7. SPURIOUS EMISSIONS BELOW 30 MHz

### 8.7.1. 802.11b MIMO MODE AND BT MODE WORST CASE

#### SPURIOUS EMISSIONS (802.11b MODE LOW CHANNEL, BT 8DQPSK MIDDLE CHANNEL, LOOP ANTENNA FACE ON TO THE EUT)

9 kHz~ 150 kHz

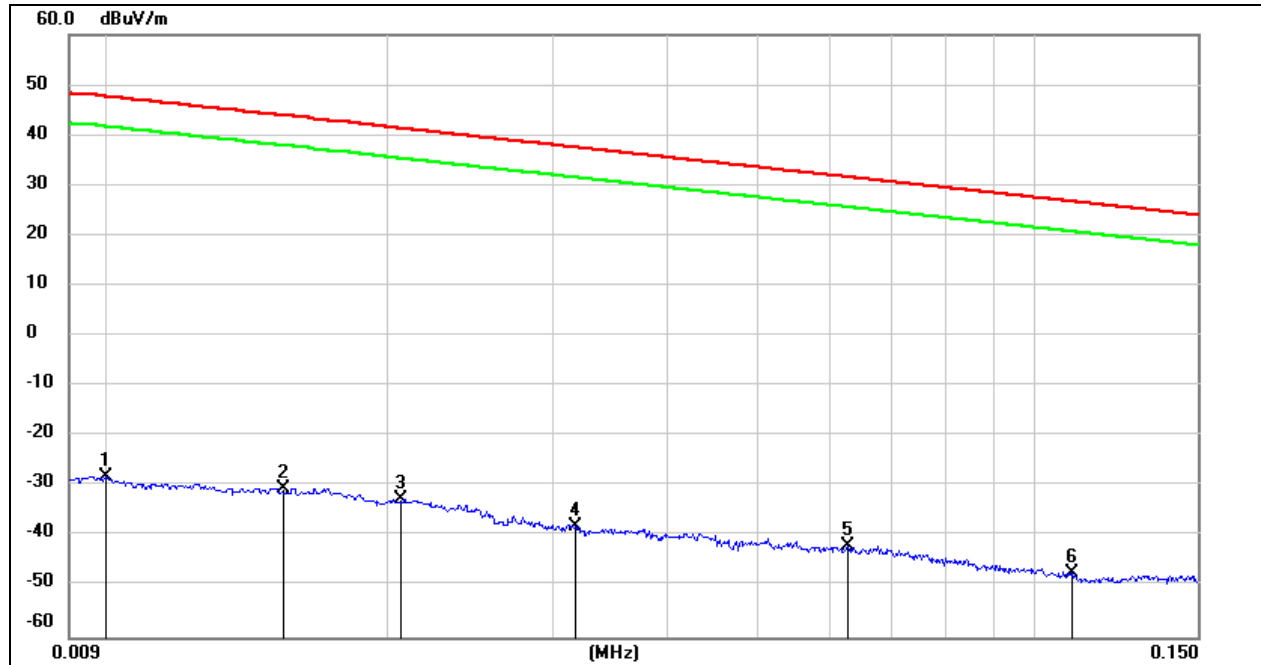

No.	Frequency (MHz)	Reading (dBuV)	Correct (dB/m)	FCC Result (dBuV/m)	FCC Limit (dBuV/m)	ISED Result (dBuA/m)	ISED Limit (dBuA/m)	Margin (dB)	Remark
1	0.0100	73.22	-101.40	-28.18	47.60	-79.68	-3.90	-75.78	peak
2	0.0154	70.94	-101.37	-30.43	43.85	-81.93	-7.65	-74.28	peak
3	0.0206	68.92	-101.35	-32.43	41.32	-83.93	-10.18	-73.75	peak
4	0.0318	63.37	-101.40	-38.03	37.55	-89.53	-13.95	-75.58	peak
5	0.0627	59.65	-101.53	-41.88	31.66	-93.38	-19.84	-73.54	peak
6	0.1100	54.42	-101.77	-47.35	26.78	-98.85	-24.72	-74.13	peak

Note: 1. Measurement = Reading Level + Correct Factor (dBuA/m= dBuV/m- 20Log10[120π] = dBuV/m- 51.5).

2. If Peak Result complies with AV and QP limit, AV and QP Result are deemed to comply with AV limit.

3. All 3 polarizations (Horizontal, Face-on and Face-off) of the loop antenna had been tested, but only the worst data recorded in the report.

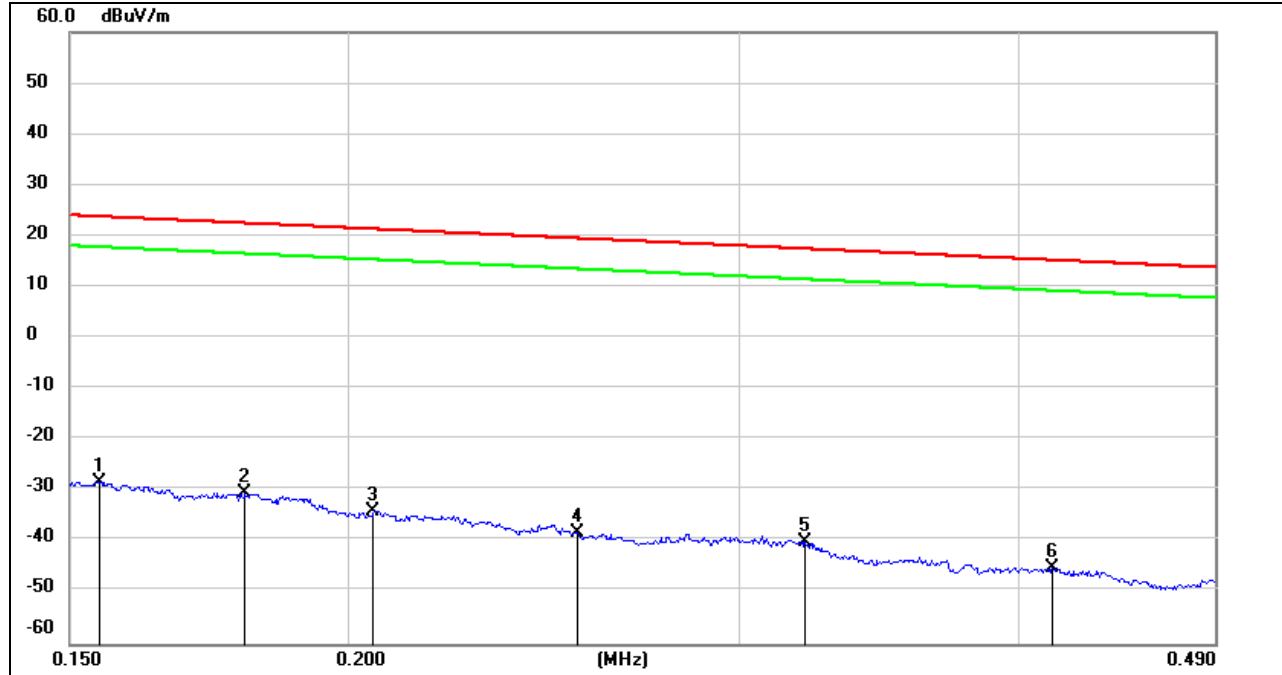

150 kHz ~ 490 kHz

No.	Frequency (MHz)	Reading (dBuV)	Correct (dB/m)	FCC Result (dBuV/m)	FCC Limit (dBuV/m)	ISED Result (dBuA/m)	ISED Limit (dBuA/m)	Margin (dB)	Remark
1	0.1547	73.31	-101.65	-28.34	23.81	-79.84	-27.69	-52.15	peak
2	0.1800	71.15	-101.68	-30.53	22.50	-82.03	-29.00	-53.03	peak
3	0.2053	67.79	-101.73	-33.94	21.35	-85.44	-30.15	-55.29	peak
4	0.2534	63.64	-101.80	-38.16	19.52	-89.66	-31.98	-57.68	peak
5	0.3205	61.95	-101.88	-39.93	17.49	-91.43	-34.01	-57.42	peak
6	0.4142	56.73	-101.98	-45.25	15.26	-96.75	-36.24	-60.51	peak

Note: 1. Measurement = Reading Level + Correct Factor (dBuA/m= dBuV/m- 20Log10[120π] = dBuV/m- 51.5).

2. If Peak Result complies with AV and QP limit, AV and QP Result are deemed to comply with AV limit.

3. All 3 polarizations (Horizontal, Face-on and Face-off) of the loop antenna had been tested, but only the worst data recorded in the report.

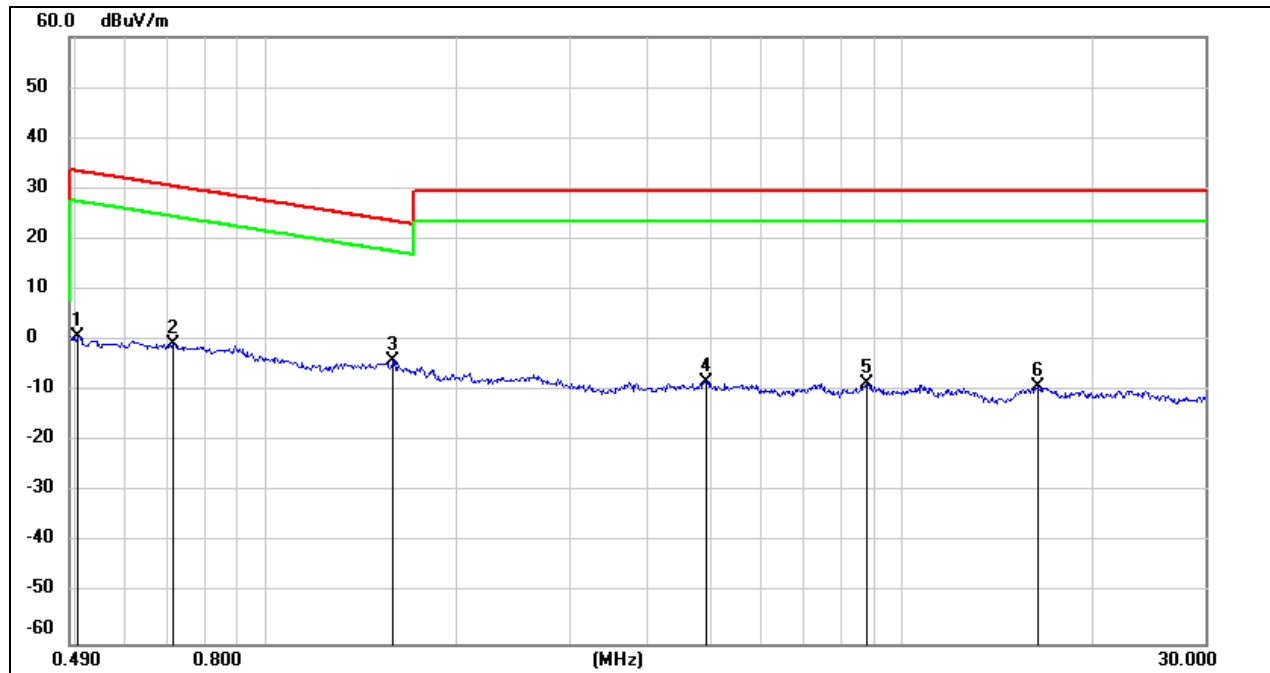
**490 kHz ~ 30 MHz**

No.	Frequency (MHz)	Reading (dBuV)	Correct (dB/m)	FCC Result (dBuV/m)	FCC Limit (dBuV/m)	ISED Result (dBuA/m)	ISED Limit (dBuA/m)	Margin (dB)	Remark
1	0.5039	62.93	-62.07	0.86	33.56	-50.64	-17.94	-32.70	peak
2	0.7125	61.32	-62.12	-0.80	30.55	-52.3	-20.95	-31.35	peak
3	1.5826	57.88	-62.01	-4.13	23.61	-55.63	-27.89	-27.74	peak
4	4.9165	53.38	-61.48	-8.10	29.54	-59.6	-21.96	-37.64	peak
5	8.8116	52.30	-60.96	-8.66	29.54	-60.16	-21.96	-38.20	peak
6	16.3959	51.67	-60.96	-9.29	29.54	-60.79	-21.96	-38.83	peak

Note: 1. Measurement = Reading Level + Correct Factor (dBuA/m= dBuV/m- 20Log10[120π] = dBuV/m- 51.5).

2. If Peak Result complies with AV and QP limit, AV and QP Result are deemed to comply with AV limit.

3. All 3 polarizations (Horizontal, Face-on and Face-off) of the loop antenna had been tested, but only the worst data recorded in the report.

Note: All the modes had been tested, but only the worst data was recorded in the report.



## 9. ANTENNA REQUIREMENTS

### APPLICABLE REQUIREMENTS

Please refer to FCC §15.203

An intentional radiator shall be designed to ensure that no antenna other than that furnished by the responsible party shall be used with the device. The use of a permanently attached antenna or of an antenna that uses a unique coupling to the intentional radiator shall be considered sufficient to comply with the provisions of this section. The manufacturer may design the unit so that a broken antenna can be replaced by the user, but the use of a standard antenna jack or electrical connector is prohibited.

Please refer to FCC §15.247(b)(4)

The conducted output power limit specified in paragraph (b) of this section is based on the use of antennas with directional gains that do not exceed 6 dBi. Except as shown in paragraph (c) of this section, if transmitting antennas of directional gain greater than 6 dBi are used, the conducted output power from the intentional radiator shall be reduced below the stated values in paragraphs (b)(1), (b)(2), and (b)(3) of this section, as appropriate, by the amount in dB that the directional gain of the antenna exceeds 6 dBi.

### RESULTS

Complies

---

**END OF REPORT**