

# AC60

# Portable Power Station

## User Manual

Please Read This Manual Before Use And Follow Its Guidance.  
Keep This Manual For Future Reference.



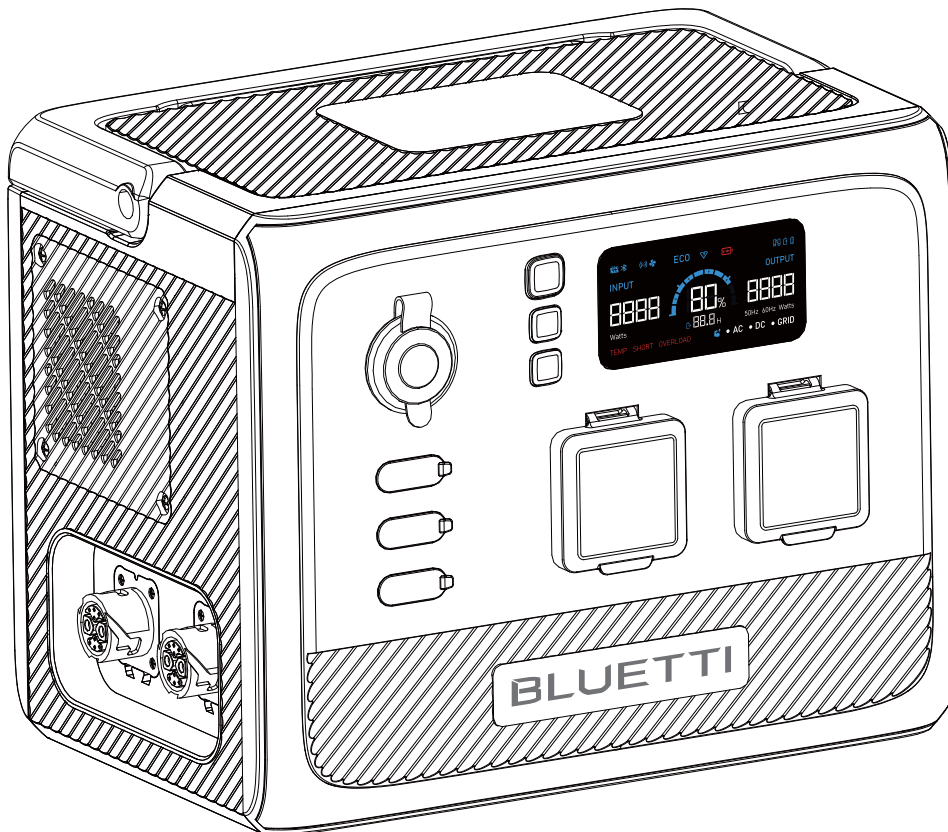

### Warning

1. Charge the unit before first use.
2. Do not use solar panels with open circuit voltage higher than 28V. Solar input voltage range for the unit is DC 12V~28V.
3. Charge the unit when the SoC drops below 5%. If the SoC drops to 0, power off the unit and charge it for at least 30mins before restarting.
4. The unit is for off-grid use only. Do not connect its AC output to the grid.
5. If not used for more than 3 months, charge the unit to 40%~60% SoC and store it with the power off. For optimum battery life, discharge and charge the unit every 3 months.
6. This equipment has been tested and found to comply with the limits for a Class A digital device. Operation of this equipment in a residential area is likely to cause harmful interference in which case the user will be required to correct the interference at his own expense.
7. This product must be grounded before operation.  
Connect a grounding cable (recommended 14AWG (1.5mm<sup>2</sup>) /105°C/yellow-green color) to the grounding terminal of AC60. Fasten the grounding screw (M4\*12) to fix the cable.

# Thank You!

Thank you for making BLUETTI a part of your family. From the very beginning, BLUETTI has tried to stay true to a sustainable future through green energy storage solutions for both indoor and outdoor use while delivering an exceptional eco-friendly experience for our homes and our world. That's why BLUETTI makes its presence in 70+ countries and is trusted by millions of customers across the globe.



# Contents

1	Safety Instructions .....	05
1.1	General Safety .....	05
1.2	Handling .....	07
1.3	Storage and Usage .....	07
2	What's In The Box .....	08
3	Product Overview .....	10
3.1	Diagram .....	10
3.2	Specifications .....	11
4	Operating Instructions .....	12
4.1	Buttons .....	12
4.2	LCD Screen .....	14
4.3	Charging .....	15
4.4	Discharging .....	17
4.5	Connect AC60 and B80 .....	18
4.6	BLUETTI App .....	18
5	Appendix .....	19
5.1	FAQs .....	19
5.2	Troubleshooting .....	20
5.3	Abbreviations .....	21
5.4	FCC Warning .....	22
5.5	Important Instructions .....	24

# 1. Safety Instructions

Read this manual for instructions on the proper use and safety information for the unit. Follow the warnings and instructions marked on the unit and its accessories.

Pay attention to the "Instruction", "Caution", "Warning" and "Danger" symbols in this manual, and follow the instructions carefully to avoid injury or damage.

The Safety Requirements provided herein are for illustrative purposes that include but are not limited to those listed in this manual. Actual operation shall comply with all applicable safety standards.

If you have any questions, feel free to contact BLUETTI support or your local BLUETTI dealers.

## 1.1. General Safety

- Always operate or store the unit in the conditions specified in this manual.
- The installation and ambient conditions must comply with the regulations in the relevant international, national or regional standards.
- Unauthorized disassembly, alteration of the equipment or modification of the software code is not allowed.

### **BLUETTI shall not be liable for the following circumstances:**

- Equipment damage caused by force majeure, such as earthquake, fire, storm, flood, mudslide, etc.
- Damage or loss during transportation.
- Damage caused by storage conditions that do not meet the requirements specified in this manual.
- Damage to the hardware or data of the equipment due to customer negligence, improper operation or intentional damage.
- Damage to the system caused by a third party or the customer, including handling and installation that does not meet the requirements specified in this manual.
- This product is not suitable for providing electrical service for equipment and machines that are highly dependent on the reliability of electrical power supply and that involve personal safety, such as atomic energy, aviation, medical, etc. Poweroak will not be held responsible for any personal safety accidents, fire accidents, equipment failures, etc. caused by using this product to supply power to the above equipment and machines.
- Damage caused by adjustment, alteration or removal of identification marks.

### **To avoid danger, please regulate the operation in the following manner:**

- Do not install, use and maintain the unit in adverse weather conditions such as lightning, rain, snow and strong breezes (including but not limited to handling and operating the unit, plugging and unplugging signal connections to outdoor facilities, working at height, outdoor installations, etc.).

- Always turn off the power source before starting any electrical work.
- Do not clean the unit with water.
- Do not disassemble, modify, tamper with or repair the unit on your own.
- Regularly inspect the unit and its accessories for damage or deterioration.
- Use a tester to check for the presence of dangerous voltage before touching any conductor or terminal.
- If the unit's shell is cracked during transportation or use, do not use it and contact BLUETTI support or your local BLUETTI dealers.
- Use a dry powder extinguisher if the unit catches fire.
- In case of fire, EVACUATE the building or affected area immediately, activate the closest FIRE ALARM system and CALL 9-1-1 or your local emergency phone number.
- Use genuine cables and accessories provided by BLUETTI.
- Keep the unit away from heat sources or high temperatures, and do not expose it to direct sunlight.
- Do not store the unit with flammable liquids, gases, or explosive materials.
- Make sure the area where you are using the unit is well ventilated and spacious.
- Do not block or cover the vents of the unit as this may cause irreversible damage to it.
- Use the unit for its intended purpose and avoid stacking objects on top of it during storage or use.
- Do not move the unit during operation as the vibrations and shocks associated with movement may cause damage to the internal hardware.
- In case of malfunction, turn off the unit immediately and contact BLUETTI support or your local BLUETTI dealers if this manual cannot adequately explain the malfunction to you.
- Do not place the unit on an unstable or inclined surface.
- Do not insert foreign objects into any port and vent of the unit.
- Keep away from children and pets.
- This product must be grounded before operation.  
Connect a grounding cable (recommended 14AWG/105°C/yellow-green color) to the grounding terminal of AC60. Fasten the grounding screw (M4\*12) to fix the cable.

## Legal and Regulatory Requirements

- The transportation, wiring and maintenance shall comply with all applicable laws, regulations and standards.
- User-provided materials and tools required shall meet the requirements specified in applicable laws, regulations and relevant standards.

## 1.2.Handling

Use mechanical assistance as needed (e.g. trolleys and adjustable height workbenches).

### Recommended number of people based on the weight of product

Weight	Number of people
<18kg	1
18kg~32kg	2
32kg~55kg	3
>55kg	4 or a cart

## 1.3. Storage and usage

- When not using the unit for over 3 months, charge it to 40% to 60% SoC to keep it in optimal condition.
- Before storing the unit, power it off and remove all electrical connections from it.
- Store the unit in a cool and dry place. The ideal temperature range is 10°C to 30°C. The unit can be safely charged and discharged at temperatures of -20°C to 40°C. However, it's NOT recommended to store the unit in harsh temperatures for extended periods of time.
- Fully cycle the unit every 6 months to maintain the battery's health.

If the SoC drops to 0 (during operation or upon startup), take the following actions to safely restart the unit:

1) Shut down immediately.

2) Charging within 48 hours.





3) Battery should be kept at an ambient temperature of 5°C to 35°C for 24 hours before charging.

It is recommended to charge the unit via an AC source. If charging via solar energy, ensure that your solar system provides an output of more than 100W.

BLUETTI shall not be liable for any equipment damage caused by the violation of above instructions.

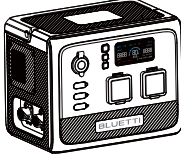
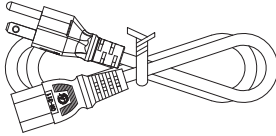
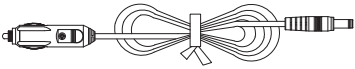
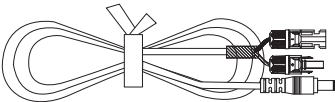
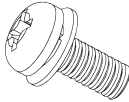
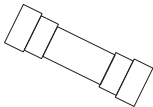
## 2. What's In The Box

### Standard Packaging

Item	Picture	Qty.
Portable Power Station		1
AC Charging Cable (16AWG, 1800mm)		1
Car Charging Cable (16AWG, 720mm)		1
Solar Charging Cable (16AWG, 1500mm)		1
Grounding screw (M4*12)		1
Fuse		1
User Manual		1
Warranty Card		1
Quality Certificate		1



## Optional

(Available on official BLUETTI website)

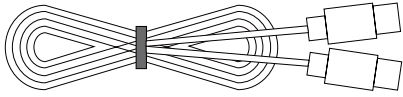
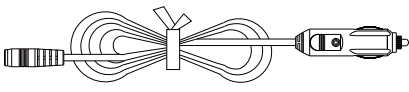
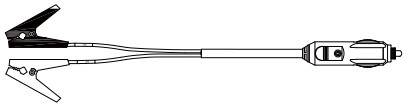
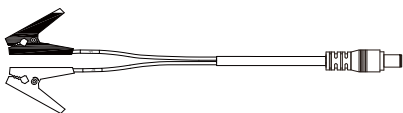
Item	Picture
TYPE-C Cable (5A/100W, 2m)	
Cigarette Lighter to 5521 Cable (For 12V devices with 5521 port, such as routers, cameras, etc.)	
Cigarette Lighter to Clamp Cable (Charging lead-acid battery via the cigarette lighter port)	
Lead-acid battery charging cable (DC7909)	

### 3. Product Overview

#### 3.1 Diagram

As a portable power station, AC60 weighs only 9.1 kg, yet features a 600W pure sine wave inverter and 403.2Wh LiFePO4 battery pack, enough to run most of your essentials for hours. LiFePO4 cells, the safest chemistry available, together with advanced Battery Management System (BMS), give you the highest level of security. The AC60 employs unique housing waterproof technology, making it very suitable for travel and outdoor use. If necessary, you can attach 2 B80 expansion batteries to AC60 for a maximum capacity of 2000Wh. AC60 also supports ECO mode - the AC output or DC output automatically shuts down at low power consumption or no load to maximize energy efficiency.

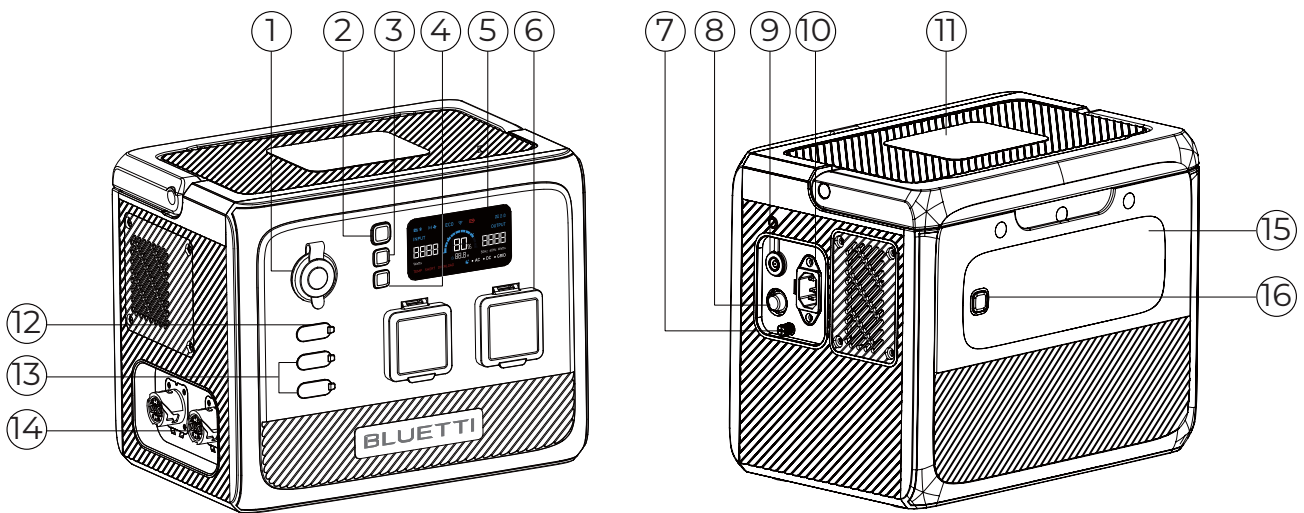

① Cigarette Lighter Port

② Power Button

③ DC Output Button

④ AC Output Button

⑤ LCD Screen

⑥ AC Output

⑦ Grounding Pole(Grounding screw: M4\*12)

⑧ AC Input Fuse

⑨ DC Input

⑩ AC Input

⑪ Wireless Charging Pad

⑫ USB-C Port

⑬ USB-A Port

⑭ Battery Expansion Port

⑮ LED Lamp

⑯ LED Lamp Button

### 3.2 Specifications

Model	AC60			
Area	JP	US	CN	EU/UN/AU
Battery Capacity	403.2Wh			
Cell Type	LiFePO4			
Net Weight	About 9.1kg/20.06lbs			
Dimensions (L*W*H)	290mm×205mm×234mm/11.42in×8.07in×9.21in			
Charging Temperature	0°C~40°C/32°F~104°F			
Discharging Temperature	-20°C~40°C(-20°C~30°C: 600W Max.; 30°C~40°C: 500W Max.) -4°F~104°F(-4°F~86°F: 600W Max.; 86°F~104°F: 500W Max.)			
Storage Temperature	-20°C~40°C/-4°F~104°F			
Working Humidity	10%~90%			
AC Output				
Power	600W in total			
Voltage	100VAC	120VAC	220VAC	230VAC
Current	6A	5A	2.7A	2.6A
Frequency	50/60Hz			
DC Output				
Cigarette Lighter Port	12VDC/10A			
USB-A*2	5VDC/3A in total			
USB-C (Type-C)	5/9/12/15/20VDC, 3A; 20VDC, 5A (eMarker chip built-in)			
Wireless Charging	5W/7.5W/10W/15W			
AC Input				
Voltage	100VAC	120VAC	220VAC	230VAC
Max. Current	10A	10A	5A	5A
Frequency	50/60Hz			
Power	600W Max. (0-80% in 45 minutes @10°C~30°C/50°F~86°F)			
DC Input				
Interface	DC7909			
Power	200W/8A Max.			
Voltage	12V~28VDC			
Expansion Port*2				
Rated voltage	22.4VDC			
Max. Input Current	30A			

## 4. Operating Instructions

**DANGER:** This device is intended to be used indoors only. Do not use outdoors.

### 4.1 Buttons

BLUETTI AC60 has PWR button, AC power button and DC power button.

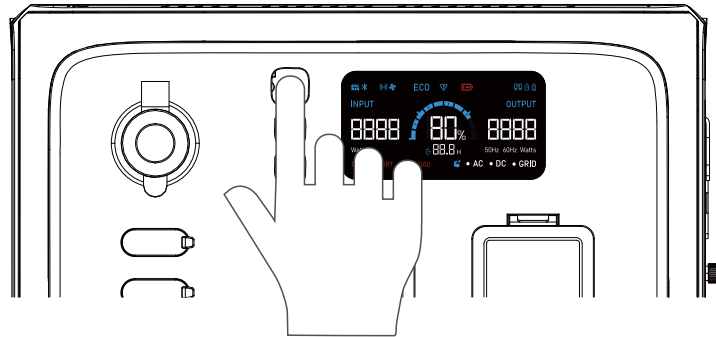

#### 4.1.1. Power ON/OFF

- Press the PWR button to start the AC60. When AC60 is on, press this button to turn on/off the LCD screen. Press and hold the button for more than 2 seconds to turn off the AC60.
- Press the DC power button to turn on/off the DC output (cigarette lighter, USB, wireless charging).
- Press the AC power button to turn on/off the AC output.

#### 4.1.2. Settings

- **Setting mode:** When the screen is on and the AC output is off, press and hold the AC and DC power buttons for about 2 seconds to enter Setting mode.
- **Frequency switching:** The current output frequency (50Hz/60Hz) is displayed in the lower right corner of screen. Under Setting mode, press the AC power button to switch the frequency.
- **Power Lifting mode:** The Power Lifting mode is disabled by default. To enable it, press and hold the AC power button for about 2s in Setting Mode, or turn it on directly in the BLUETTI app. When enabled, the icon  is displayed on the screen. In this mode, the AC60 can run high drain pure resistive loads\* ( $\leq 1200W$ ) while its rated output power remains 600W.

**Note:** The Power Lifting mode is not available when charging AC60 via an AC source like a wall outlet or generator. The AC source will bypass the inverter and supply power directly to connected AC loads.

\* Include heaters, irons or any other devices consisting of heating elements only.

- **Grid Enhancement mode:** By default, the Grid Enhancement mode is disabled. Please turn it on directly in the BLUETTI app. This mode ensures that the AC60 has a stable and continuous AC input, as it allows AC60 to adapt to voltage fluctuations and waveform distortion of an AC source.
- **ECO mode:** When operating on ECO mode, the AC/DC output will automatically turn off if the AC60 is bearing low or no load for a while.

When enabled, the ECO icon is displayed on the screen. Under Setting mode, press the DC power button turn it on/off.





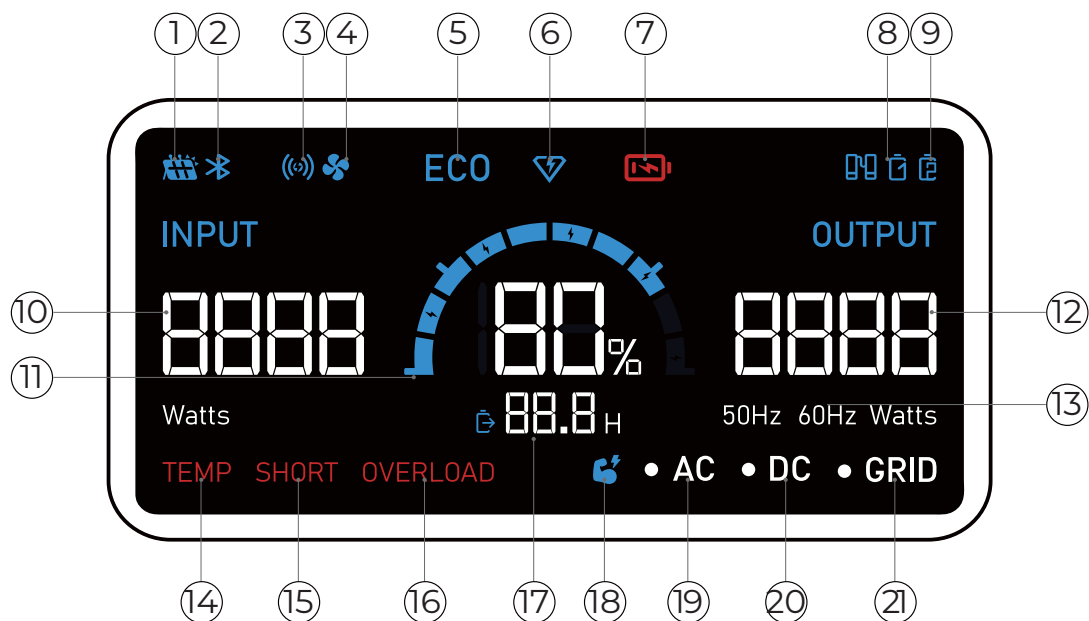

Output	Power	Duration
AC output	10W-30W	1, 2, 3, 4 hours
DC output	5W-10W	1, 2, 3, 4 hours

- Press the AC and DC power buttons at the same time to exit Setting mode.  
**Note:** If you do not perform any operation in 1 minute, AC60 will exit Setting mode automatically and no changes will be saved.
- **Check the error code:** Press the AC and DC power buttons at the same time for about 2 seconds, and then hold the AC power button to check the current error code (e.g. E001).

## 4.2. LCD Screen



- |                     |                             |                            |
|---------------------|-----------------------------|----------------------------|
| ① DC Input          | ⑧ Expansion battery 1       | ⑮ Short circuit alert      |
| ② Bluetooth         | ⑨ Expansion battery 2       | ⑯ Overload alert           |
| ③ Wireless charging | ⑩ Input power               | ⑰ Remaining time indicator |
| ④ Fan               | ⑪ Battery capacity          | ⑱ Power Lifting mode       |
| ⑤ ECO Mode          | ⑫ Output power              | ⑲ AC indicator             |
| ⑥ Turbo charging    | ⑬ AC frequency              | ⑳ DC indicator             |
| ⑦ Low voltage alert | ⑭ Temperature anomaly alert | ㉑ AC input connected       |

LCD Instructions	
Startup	LCD lights up
Shutdown	LCD lights off
Overload	<b>OVERLOAD</b> flashes
Short circuit	<b>SHORT</b> flashes
Charging	 displays
Turbo Charging	 displays
ECO mode enabled	<b>ECO</b> displays
Battery low	 displays
Abnormal temperature	<b>TEMP</b> flashes
AC Input	<b>• GRID</b> displays
DC Input	 displays
Bluetooth connected	 displays
AC output enabled	<b>• AC</b> displays
DC output enabled	<b>• DC</b> displays
Expansion battery connected	 displays
Power Lifting mode enabled	 displays

## 4.3 Charging

AC60 supports four charging methods: AC, solar, car(cigarette lighter) and generator.

### 4.3.1. AC Charging (Wall Outlet)

Simply plug the AC60 into the standard wall outlet and start charging.

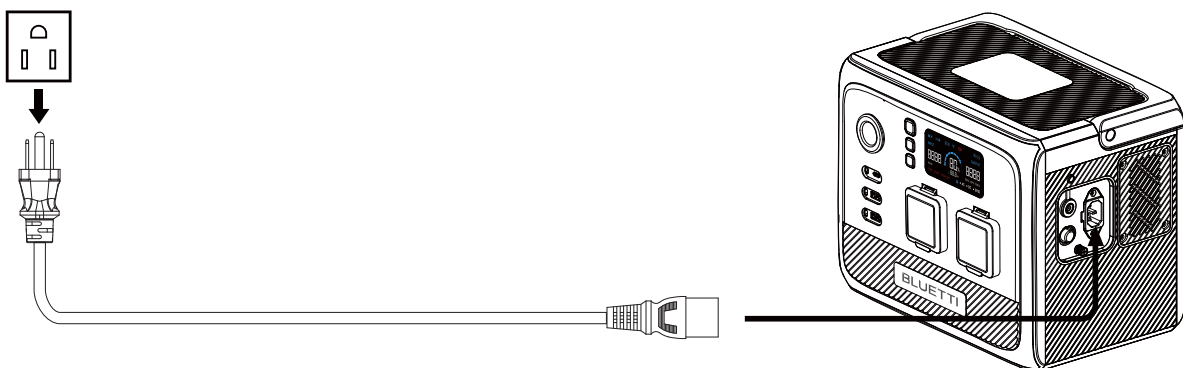

AC60 supports Turbo/Standard/Silent charging modes. It's set to standard charging by default, while the Turbo and silent modes can be enabled in BLUETTI app. BLUETTI's AC charging mode guide is as follows:

- 1) Turbo charging comes in handy when you need AC60 to be replenished in short time.
- 2) Standard charging is more friendly to AC60's battery.
- 3) Silent charging gives you quiet, low-power operation for long battery life.

### 4.3.2.Solar Charging

Connect the solar panels (in series or parallel) to AC60 via the solar charging cable.

**Note:** Please make sure your solar panels comply with:

Voc: 12V~28V Input Current: 8A Max. Input Power: 200W Max.

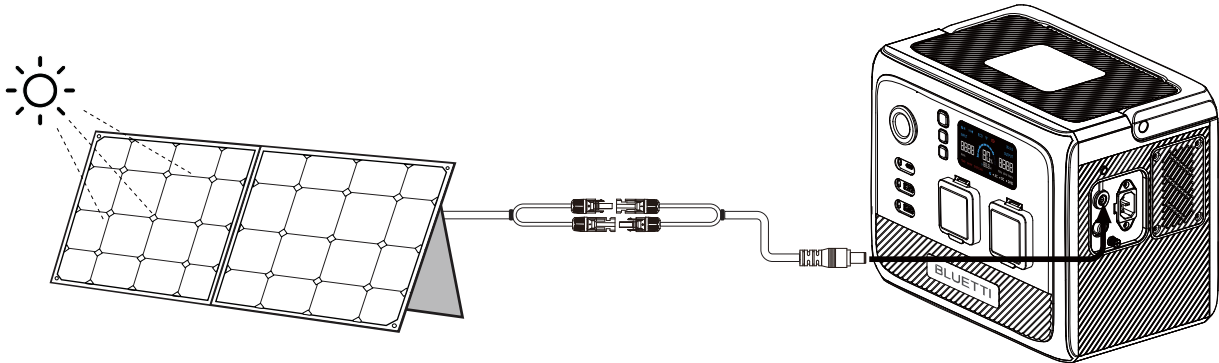

**Warning:** The open circuit voltage of solar panels cannot exceed 28V, otherwise it will damage the device.(Note: This is not covered in the warranty.)

### 4.3.3.Car Charging

Connect the AC60 to the vehicle's 12V cigarette lighter port via the car charging cable.

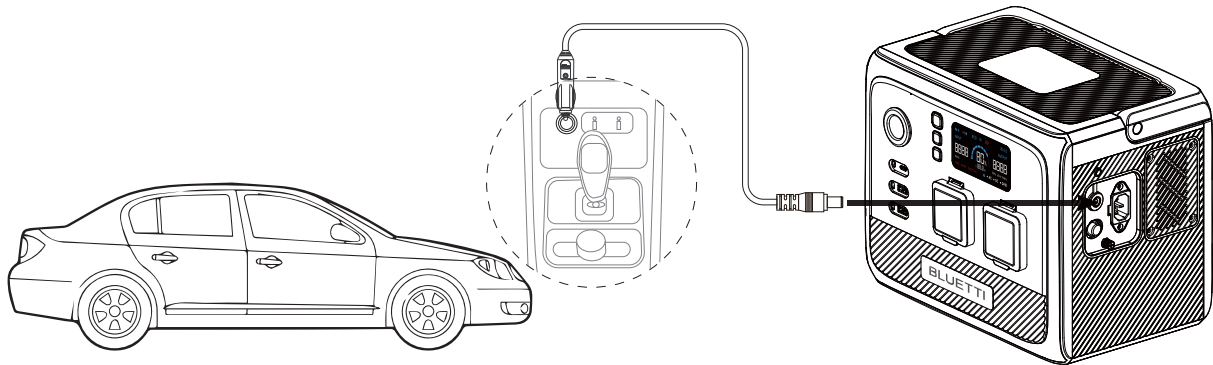

**Warning:** Cigarette lighter must be completely plugged in, otherwise it may cause safety risks.

### 4.3.4.Generator Charging

Connect the AC60 to generator via the AC charging cable.

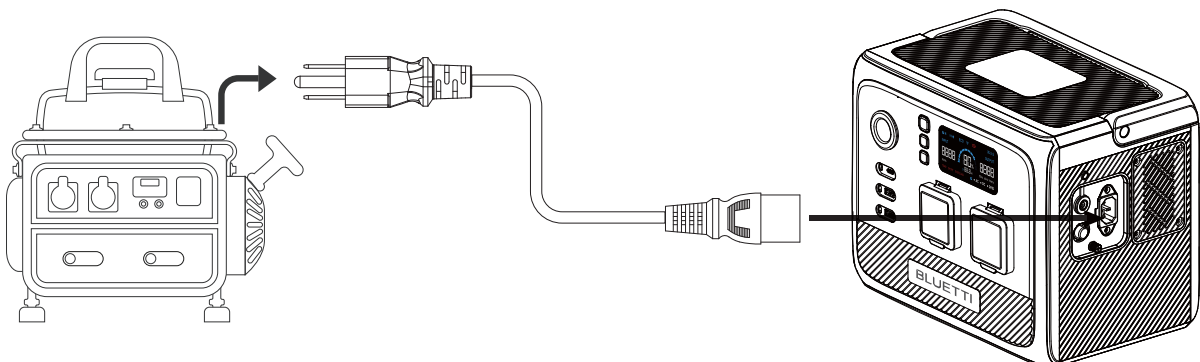



## 4.4 Discharging

The operation time of AC60 is subject to many factors, such as ambient temperature, discharge rate, battery capacity, altitude, load characteristics, etc.

### 4.4.1.AC Output

AC60 has 2 AC output ports, providing a total of up to 600W AC power. It can also handle a surge of 1200W.

### 4.4.2.DC Output

- 12V/10A cigarette lighter port
- USB-C (PD 100W)
- USB-A (\*2 5V/3A in total)
- Wireless charging pad (15W Max.)

### 4.4.3.Estimated Operation Time

Depending on the connected power loads, there are two different ways to calculate the operation time of AC60 or AC60+B80.

- If the AC60 is applied to a high power load, such as a 650W coffee maker.

Operation time (estimated) = Battery capacity (Wh) × DoD ×  $\eta$  ÷ (load power)

- If applied to a small power load like a 40W refrigerator.

Operation time (estimated) = Battery capacity (Wh) × DoD ×  $\eta$  ÷ (load power+self-consumption of AC60)

#### **Note:**

1)The self-consumption of AC60 is about 10W.

2)Load power and operation time are measured in watts and hours.

3)DoD refers to depth of discharge. AC60 works at 90% DoD for longer battery life.  $\eta$  is the conversion efficiency of the inverter, which is larger than 85% for AC60.

E.g. If you have a combo of AC60+2\*B80, you'll get a maximum capacity of 2015Wh to run your 40W refrigerator for about 30 hours.

Operation time = 2015Wh × 90% × 85% ÷ (40W+10W) ≈30 hours.

**Note:** Low temperature and excessive loads could greatly impact the battery capacity and reduces its normal operation time.

#### 4.5 Connect AC60 and B80

With the battery expansion cable, AC60 supports up to 2 B80 expansion batteries for a total capacity of 2015Wh. Turn on AC60 to activate the whole power system.

Note: Make sure the AC60 and B80 are off when connecting and disconnecting cables.

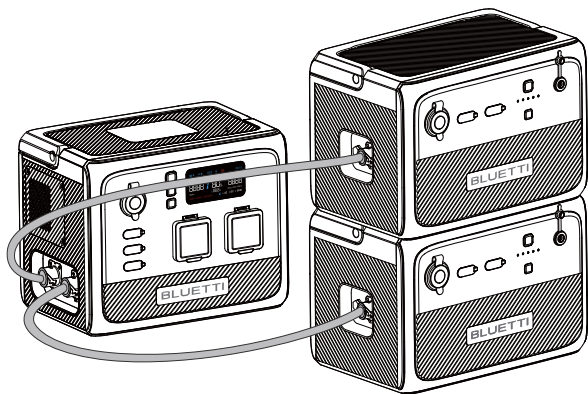

(AC60+2\*B80)

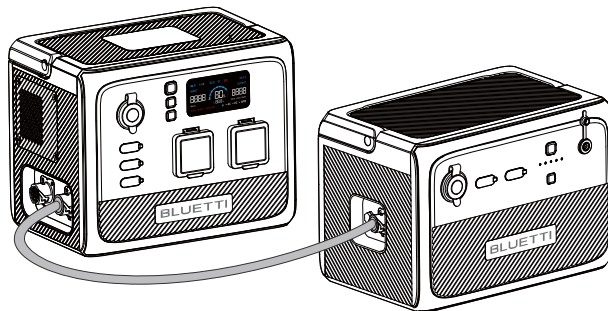

(AC60+1\*B80)

#### 4.6 BLUETTI App

Scan the QR code below or search "BLUETTI" in the App Store or Google Play to download the BLUETTI app.



AC60 supports Bluetooth connection. Once connected, the AC60 can be accessed and controlled on a mobile phone or other smart devices. For more details, please refer to BLUETTI APP INSTRUCTIONS.

## 5. Appendix

### 5.1 FAQs

**Q1:** How do I know whether my devices will work well with this product?

**A:** Please evaluate the total constant load of your devices. If it doesn't exceed the Max. output power of AC60 (600W), you can use this power station to run your devices. Please note that if the total load exceeds the limit, but the loads on AC output is lower than 600W, the inverter will turn off the DC output only.

Note: Some devices with built-in motor/compressor may start at 2-4 times the rated power, which can easily overload the AC60.

**Q2:** Can I use third-party solar panels to charge this product?

**A:** Yes, you can. Make sure your solar panels have an open circuit voltage of 12V~28V and have the MC4 connectors. Please do NOT mix different types of solar panels.

Note: Time required for one full charge depends on weather condition, the sunshine intensity and the angle of solar panels.

**Q3:** Can it charge and discharge at the same time?

**A:** Yes. It supports pass-through charging. AC60 comes with the premium LiFePO<sub>4</sub> battery and proprietary Battery Management System to ensure that it can charge and discharge at the same time.

**Q4:** What is ECO mode and can I turn it off?

**A:** ECO mode helps save power, and you can turn it on or off on the screen. When operating on ECO mode, the AC/DC output will automatically turn off if the AC60 is bearing low or no load for a while. You can set the power threshold of AC output and DC output to 10W-30W/5W-10W, respectively, for 1, 2, 3, or 4 hours.

**Q5:** Why is the charging power often too low?

**A:** AC60 has a built-in intelligent BMS that automatically adjusts the charging power in response to the battery temperature and SoC, thus protecting the battery and extending its service life.

**Q6:** Can I make the AC60 less noisy when charging?

**A:** Yes. Select "Silent" for AC charging in the BLUETTI app. Please refer to 4.3.1 AC Charging for more details.

**Q7:** When should I use the Grid Enhancement mode?

**A:** This mode is handy when charging the AC60 via an unstable AC source, such as an unreliable grid or generator.

E.g. If you change the generator's output while charging the AC60, the voltage dip will also cause the charge to fail.

## 5.2 Troubleshooting

Error Code	Error Description	Troubleshooting
E001	Inverter overload	Check if the power of connected devices is too high.
E003	Inverter short circuit	Check if the connected devices are damaged.
E065	Cigarette lighter output short circuit	Check if the power of connected devices is too high.
E068	Cigarette lighter overtemperature	Wait a few minutes and try again.
E085	Charging temperature too high	Wait for the battery to cool down before charging.
E086	Charging temperature too low	Recommended charging temperature: 0°C~40°C.
E087	Discharging temperature too high	Wait for the battery to cool down before discharging.
E088	Discharging temperature too low	Recommended discharging temperature: -20°C~40°C.
E033	PV Input overvoltage	Ensure the PV input voltage is in the range of 12V~28VDC.
E034、 E035	B80 PV Input overvoltage	Ensure the PV input voltage is in the range of 12V~28VDC.
Others		Contact BLUETTI technical support.

### 5.3 Abbreviations

- MPPT: Maximum Power Point Tracking
- SoC: State of Charge
- UPS: Uninterruptible Power Supply
- AC: Alternating Current
- DC: Direct Current
- PV: Photovoltaic (Solar Panels)
- DoD: Depth of Discharge

### 5.4 FCC Warning

This equipment has been tested and found to comply with the limits for a Class A digital device, pursuant to part 15 of the FCC Rules. These limits are designed to provide reasonable protection against harmful interference when the equipment is operated in a commercial environment. This equipment generates, uses, and can radiate radio frequency energy and, if not installed and used in accordance with the instruction manual, may cause harmful interference to radio communications. Operation of this equipment in a residential area is likely to cause harmful interference in which case the user will be required to correct the interference at his own expense.

Changes or modifications not expressly approved by the party responsible for compliance could void the user's authority to operate the equipment. This device complies with Part 15 of the FCC Rules. Operation is subject to the following two conditions:

- (1) this device may not cause harmful interference, and
- (2) this device must accept any interference received, including interference that may cause undesired operation.

This equipment complies with FCC radiation exposure limits set forth for an uncontrolled environment. This equipment shall be installed and operated with minimum distance 20cm between the radiator & body.

#### CAN ICES-3 (A) / NMB-3 (A)

This Class A digital apparatus complies with Canadian ICES-003.

(Cet appareil numérique de la Classe A conforme à la norme NMB-003 du Canada).

This device contains licence-exempt transmitter(s)/receiver(s) that comply with Innova-

tion, Science and Economic Development Canada's licence-exempt RSS(s). Operation is subject to the following two conditions:

- (1) This device may not cause interference.
- (2) This device must accept any interference, including interference that may cause undesired operation of the device.

L'émetteur/récepteur exempt de licence contenu dans le présent appareil est conforme aux CNR d'Innovation, Sciences et Développement économique Canada applicables aux appareils radio exempts de licence. L'exploitation est autorisée aux deux conditions suivantes :

- (1) L' appareil ne doit pas produire de brouillage;
- (2) L' appareil doit accepter tout brouillage radioélectrique subi, même si le brouillage est susceptible d'en compromettre le fonctionnement.

This equipment complies with IC exposure limits set forth for an uncontrolled environment. This equipment shall be installed and operated with minimum distance 10cm between the radiator & body.

Cet équipement est conforme aux limites d'exposition IC définies pour un environnement non contrôlé. Cet équipement doit être installé et utilisé avec une distance minimale de 10cm entre le radiateur et la carrosserie.

## USER MAINTENANCE INSTRUCTIONS

- (1) Please fully charge the machine before storing it.
- (2) Turn off all power buttons.
- (3) To preserve the battery lifespan, please use and recharge at least once every 6 months.
- (4) Wring the cloth with water and wipe it clean In case of dirt.

## MOVING AND STORAGE INSTRUCTIONS

- (1) Ensure proper ventilation while in use or store and keep away from any combustible materials or gases. Do not stack anything on top of the unit in storage or in use. Inadequate ventilation and/or improper storing may cause damage to the unit.
- (2) Avoid exposing the product to rain or using the product in humid environment.
- (3) Use and store the product in a clean and dry environment.
- (4) Keep this product away from children and pet.

## 5.5 Important Instructions

INSTRUCTIONS PERTAINING TO RISK OF FIRE, ELECTRIC SHOCK, OR INJURY TO PERSONS

IMPORTANT SAFETY INSTRUCTIONS, SAVE THESE INSTRUCTIONS

**WARNING** – When using this product, basic precautions should always be followed, including the following:

- a) Read all the instructions before using the product.
- b) To reduce the risk of injury, close supervision is necessary when the product is used near children.
- c) Do not put fingers or hands into the product. DO NOT insert foreign objects into any ports of the machine. Please operate it carefully and keep children away from it.
- d) Use of an attachment not recommended or sold by power pack manufacturer may result in a risk of fire, electric shock, or injury to persons.
- e) To reduce risk of damage to the electric plug and cord, pull the plug rather than the cord when disconnecting the power pack.
- f) Do not use a battery pack or appliance that is damaged or modified. Damaged or modified batteries may exhibit unpredictable behavior resulting in fire, explosion or risk of injury.
- g) Do not operate the power pack with a damaged cord or plug, or a damaged output cable.
- h) DO NOT attempt to replace the internal battery or any other component of the equipment by anyone other than authorized personnel. There are no end-user serviceable components. Do not disassemble the power pack, take it to a qualified service person when service or repair is required. Incorrect reassembly may result in a risk of fire or electric shock.
- i) To reduce the risk of electric shock, unplug the power pack from the outlet before attempting any instructed servicing.
- j) **WARNING – RISK OF EXPLOSIVE GASES.** To reduce risk of battery explosion, follow these instructions and those published by battery manufacturer and manufacturer of any equipment you intend to use in vicinity of the battery. Review cautionary marking on these products and on engine.
- k) **PERSONAL PRECAUTIONS**
  - 1) Wear complete eye protection and clothing protection. Avoid touching eyes while working near battery.

- 2) NEVER smoke or allow a spark or flame in vicinity of battery or engine.
- 3) Be extra cautious to reduce risk of dropping a metal tool onto battery. It might spark or short-circuit battery or other electrical part that may cause explosion.
- l) When charging the internal battery, work in a well ventilated area and do not restrict ventilation in any way.
- m) Under abusive conditions, liquid may be ejected from the battery; avoid contact. If contact accidentally occurs, flush with water. If liquid contacts eyes, additionally seek medical help. Liquid ejected from the battery may cause irritation or burns.
- n) DO NOT place the power station near heat sources. It is prohibited to place the equipment in an environment with flammable, explosive gas, or smoke. It is also prohibited to operate the equipment in this environment. Do not expose a power pack to fire or excessive temperature. Exposure to fire or temperature above 130° C may cause explosion.
- o) Have servicing performed by a qualified repair person using only identical replacement parts. This will ensure that the safety of the product is maintained.
- p) DO NOT operate in wet conditions. If the equipment becomes wet, please let the unit dry completely before using.
- q) Please ensure proper ventilation while in use and do not obstruct fan openings. Inadequate ventilation may cause permanent damage to equipment.
- r) DO NOT stack anything on top of the power station while in storage or while in use. DO NOT move the unit while operating as vibrations and sudden impacts may lead to poor connections to the hardware inside.
- s) In case of fire, only a dry powder fire extinguisher is suitable for the product.
- DANGER:** This device is intended to be used indoors only. Do not use outdoors.

## GROUNDING INSTRUCTIONS

This product must be grounded. If it should malfunction or breakdown, grounding provides a path of least resistance for electric current to reduce the risk of electric shock. This product is equipped with a cord having an equipment grounding conductor and a grounding plug. The plug must be plugged into an outlet that is properly installed and grounded in accordance with all local codes ordinances.

**WARNING** – Improper connection of the equipment grounding conductor is able to result in a risk of electric shock. Check with a qualified electrician if you are in doubt as to whether the product is properly grounded. Do not modify the plug provided with the product – if it will not fit the outlet, have a proper outlet installed by a qualified electrician.



## CONSIGNES DE SÉCURITÉ IMPORTANTES

AVERTISSEMENT: lors de l'utilisation de ce produit, les précautions de base doivent toujours être respectées, y compris les éléments suivants:

A) lire toutes les instructions avant d'utiliser le produit.

B) pour réduire le risque de blessure, une surveillance étroite est nécessaire lorsque le produit est utilisé à proximité des enfants.

C) ne pas mettre les doigts ou les mains dans le produit. Ne pas insérer d'objets étrangers dans les ports de la machine. S'il vous plaît, faites attention et éloignez les enfants.

D) l'utilisation d'un accessoire non recommandé ou vendu par le fabricant du groupe d'alimentation peut entraîner un risque d'incendie, de choc électrique ou de blessure.

E) pour réduire les risques d'endommagement de la prise et du cordon électriques, débrancher la prise plutôt que le cordon lors de la déconnexion de la centrale.

F) n'utilisez pas de batterie ou d'appareil endommagé ou modifié. Les batteries endommagées ou modifiées peuvent présenter un comportement imprévisible entraînant un incendie, une explosion ou un risque de blessure.

G) ne pas faire fonctionner le groupe d'alimentation avec un câble ou une prise endommagés ou un câble de sortie endommagé.

H) ne tentez pas de remplacer la batterie interne ou tout autre composant de l'équipement par quelqu'un d'autre que le personnel autorisé. Il n'y a pas de composants utilisables par l'utilisateur final. Ne démonter pas la batterie, l'amener à une personne qualifiée lorsque l'entretien ou la réparation est nécessaire. Un mauvais réassemblage peut entraîner un risque d'incendie ou de choc électrique.

I) pour réduire le risque de choc électrique, débrancher le bloc d'alimentation de la prise avant de procéder à tout entretien.

J) avertissement - risque de gaz explosifs. Pour réduire le risque d'explosion de la batterie, suivez ces instructions ainsi que celles publiées par le fabricant de la batterie et le fabricant de tout équipement que vous avez l'intention d'utiliser à proximité de la batterie. Revoir le marquage de mise en garde sur ces produits et sur le moteur.

K) précautions individuelles

1) porter une protection complète des yeux et des vêtements. Évitez de toucher les yeux en travaillant près de la batterie.

2) ne jamais fumer ou laisser une étincelle ou une flamme à proximité de la batterie ou du moteur.

3) être très prudent pour réduire le risque de tomber un outil métallique sur la batterie. Il peut étinceler ou court-circuiter une batterie ou une autre partie électrique qui peut causer une explosion.

L) lors du chargement de la batterie interne, travailler dans une zone bien ventilée et ne pas restreindre la ventilation.

M) dans des conditions abusives, le liquide peut être éjecté de la batterie; Évitez le contact. En cas de contact accidentel, rincer à l'eau. Si le liquide entre en contact avec les yeux, consulter un médecin. Le liquide éjecté de la batterie peut provoquer des irritations ou des brûlures.

N) ne pas placer la centrale à proximité des sources de chaleur. Il est interdit de placer l'équipement dans un environnement contenant des gaz inflammables, explosifs ou de la fumée. Il est également interdit d'utiliser le matériel dans cet environnement. Ne pas exposer une centrale électrique au feu ou à une température excessive. Une exposition à un incendie ou à une température supérieure à 130° C peut provoquer une explosion. La température de 130° C peut être remplacée par la température de 265° F.

O) faire effectuer l'entretien par un réparateur qualifié utilisant uniquement des pièces de rechange identiques. Cela garantira le maintien de la sécurité du produit.

P) ne pas opérer dans des conditions humides. Si le matériel se mouille, laissez sécher complètement l'appareil avant utilisation.

Q) assurer une bonne ventilation pendant l'utilisation et ne pas obstruer les ouvertures des ventilateurs. Une ventilation inadéquate peut causer des dommages permanents aux équipements.

R) n'empilez rien sur la centrale pendant son stockage ou son utilisation. Ne déplacez pas l'unité lorsque les vibrations et les chocs soudains peuvent conduire à de mauvaises connexions avec le matériel à l'intérieur.

S) en cas d'incendie, seul un extincteur à poudre sèche convient au produit.

**DANGER:** ce dispositif est destiné à être utilisé uniquement à l'intérieur. Ne pas utiliser à l'extérieur.

**INSTRUCTIONS de mise à la terre** Ce produit doit être mis à la terre. En cas de défaillance ou de panne, l'échouement Fournit un chemin de moindre résistance pour le courant électrique pour réduire le risque de choc électrique.

Ce produit est équipé d'une corde ayant un conducteur de mise à la terre d'équipement et un Prise de mise à la terre. La prise doit être branchée sur une prise qui est correctement installée et Mis en place conformément à toutes les ordonnances des codes locaux.

**Avertissement** - la connexion incorrecte du conducteur de mise à la terre de l'équipement est capable de Entraîner un risque de choc électrique. Vérifiez avec un électricien qualifié si vous avez des doutes quant à Si le produit est correctement mis à la terre. Ne modifiez pas la prise fournie avec le Produit - s'il ne s'adapte pas à la prise, ayez une prise appropriée installée par un électricien qualifié.

**For more information, please visit:**

Web: <https://www.bluettipower.com>



@ BLUETTI Support

@ BLUETTI Official



@ bluetti\_inc



@bluetti.inc

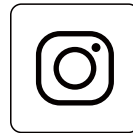

@bluetti\_official

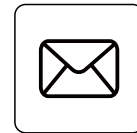

service@bluettipower.com

**SHENZHEN POWEROAK NEWENER CO., LTD.**

Add: F19, BLD No.1, Kaidaer, Tongsha Rd No.168, Xili Street,  
Nanshan, Shenzhen, China

**USA Agent**

Company name: BLUETTI POWEROAK INC

Address: 6185 S VALLEY VIEW BLVD STE D LAS VEGAS

NEVADA 89118 United States

FRN: 0033559824

Contact Name: Qiyao Li

Telephone No: +1-512-966-1898 1

Email: liqy@bluetti.com



**BLUETTI**



Just Power On