

- If you choose roof/rigid panels to be the solar power source to charge your AC300+B300, user can easily connect your rigid panels with the MC4-to-Aviation cable to your AC300+B300. The optional PV Module (additional accessory) is required to step down the voltage if the open circuit voltage produced by your roof panels exceeds the limit of AC300 can handle: 12-150VDC, 12A\*2.

Note: This PV module doesn't work with solar panels that have built-in microinverters, and open circuit voltage over 550V.

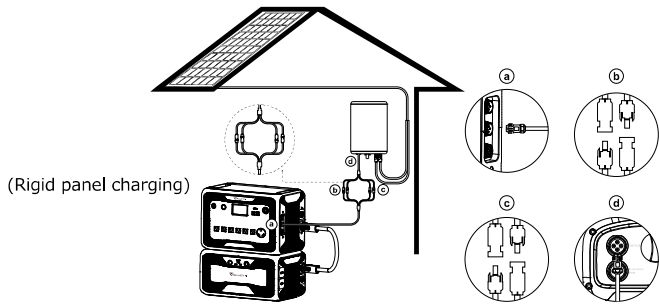

- a. DC Output Cable to AC300
- b. DC1 poles to PV1 poles
- c. DC2 poles to PV2 poles
- d. DC Output Cable to D300S

**8.2.2. Charging Method 4 :Car Charging**

- Press the power button and connect it to the cigarette lighter port through the car charging cable.
- Enter the setting interface as shown in through the display screen to set DC1/2 input source to others; The product can be charged with 8.2A maximum current.

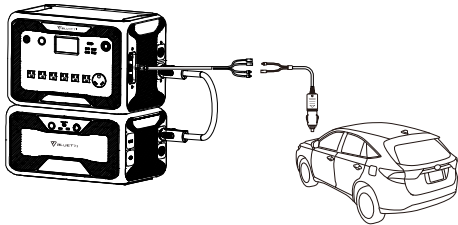

**8.2.3. Charging Method 5 :Charging via Lead-acid battery**

- Connect to the positive and negative poles of the battery through the provided solar charging cable (pay attention to distinguish the positive and negative poles of the battery, the red clamp indicates the positive pole, and the black one indicates the negative pole).
- Tap "setting" at homepage to set DC1/2 input source to "Others" to charge from lead-acid battery.

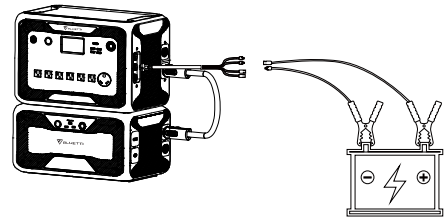

**8.3. Dual Charging**

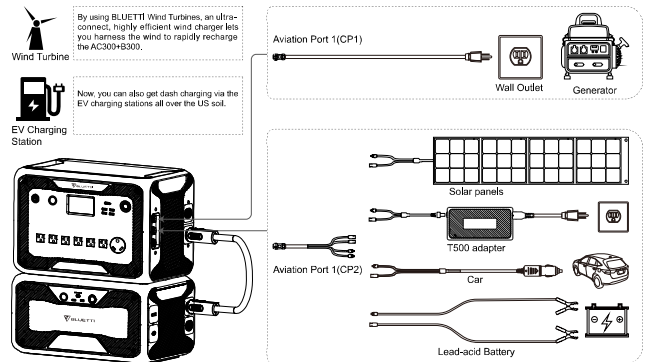

Charging Method 5: Supports charging the AC300+B300 with CP1 and CP2 at same time. You can use any charging methods listed previously, simultaneously, to maximize charging power input. They are listed here again for your convenience. Select one method for CP1 and one method for CP2 for simultaneous charging.

**CP1 Charging Port Select:**

- Method 1: GEN charging cable
- Method 2: AC charging cable

**CP2 Charging Port Select:**

- DC Input1:**
- Method 3: Solar panels (DC Input Source 1, Select PV on the touchscreen)
  - Method 4: T500 charging adapter (DC Input Source 1, Select Others on the touchscreen)
  - Method 5: 12V Car Charger/Storage battery (DC Input Source 1, Select Others on the touchscreen)
  - Method 6: 24V Car Charger/Storage battery (DC Input Source 1, Select Others on the touchscreen)



**DC Input2:**

- Method 7: Solar panels (DC Input Source 2, Select PV on the touchscreen)
- Method 8: T500 charging adapter (DC Input Source 2, Select Others on the touchscreen)
- Method 9: 12V Car Charger/Storage battery (DC Input Source 2, Select Others on the touchscreen)
- Method 10: 24V Car Charger/Storage battery (DC Input Source 2, Select Others on the touchscreen)



**Method 11: PV Parallel ( PV parallel needs to be enabled on the touchscreen)**



**8.4. How to calculate the recharging time of AC300**

**E.g. :** The total recharging power is 5400W(3000W+2400W) recharged by AC and 2nd PV at same time, the estimation time will be 1.6-2.1Hrs.(AC300 with two B300 in parallel)

**09. DISCHARGE (OUTPUT)**

The running time of the AC300+B300 is subject to factors such as ambient temperature, discharge rate, remaining battery capacity, altitude and other factors.

**9.1. The Output Port**

**9.1.1. AC Output Port**

- AC300 is equipped with \*7 AC(US, JP version) / \*6 AC(AU,EU,UK) outputs with a continuous 3000W Max. power of output in total, and the ability to support surges up to 6000W.
- Please make sure the combined power requirements of your appliances does not exceed the 3000W limit.

JP/US Version  
7 \* 100-120V/20A

EU Version  
6 \* 220-240V/20A

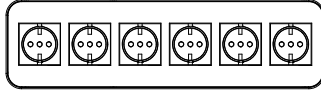
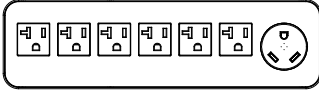

Only the NEMA TT-30 can generate 3000W,30A power of output, the standard AC output port can produce 2000-2400W,20A power of output.

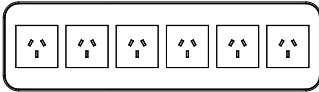

AU Version  
6 \* 220-240V/20A

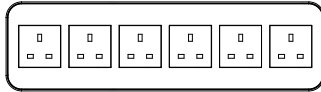

UK Version  
6 \* 220-240V/20A

9.1.2. DC Output Port

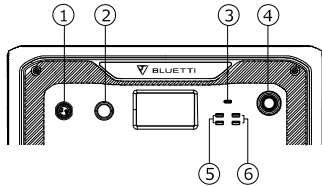

- 1. \*1 RV port
- 2. \*1 24V/10A Cigarette Lighter Port
- 3. \*1 USB-C (PD 100W)
- 4. \*1 Power button
- 5. \*2 USB-A (fast charging)
- 6. \*2 USB-A

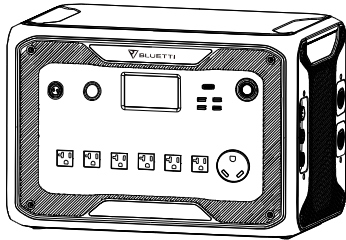

9.2. Operation Time Estimation

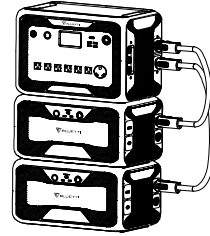

AC300 + B300\*2 = 6144Wh

●Kitchen Equipment

Refrigerator 700W(24h) 2.8 Day	Electric Fry Pan 1500W 3.3 Hrs	Microwave Oven 1000W 5.0 Hrs	Washer 500W(1000W) 4.8-9.2 Hrs

●Home Equipment

Space Heater 1500W 3.2 Hrs	Air Conditioner 8000Btu 2 Hrs	Smart Phone 18Wh 115 Times	Laptop 45Wh 71 Times	Desktop 300W 14.5 Hrs	CPAP 40W 77 Hrs

●Tools

Bench Grinder 1400W 3.5 Hrs	Welding Machine 1800W 2.8 Hrs	Circular Saw 1400W(2300W) 2.1-3.5 Hrs

●Transportation

Electric Vehicle(16A) 1800W 13.5-16 Miles	E-Bike 500W 9.2 Times

( The estimation operating time is only for reference )

9.3. How to Calculate the Operation Time

●What is the depth of discharge (DoD)?  
To extend the battery-life, the power station set the 90% DOD, which means that only 90% of the battery capacity can be discharged. 10% of the energy is reserved to avoid damage to the battery due to over-discharge.  
 $\eta$  indicates local inverter efficiency.  $DOD=90\%$ ,  $\eta =90\%$ .

10. UPS

10.1. UPS Description

An uninterruptible power supply or uninterruptible power source (UPS) is an electrical apparatus that provides emergency power to a load when the input power source or mains power fails. A UPS differs from an auxiliary or emergency power system or standby generator in that it will provide near-instantaneous protection from input power interruptions, by supplying energy stored in batteries, supercapacitors, or flywheels.

10.1.1. FYI (For Your Information)

Max. capacity retention indicates the limit of capacity of the unit that can be recharged by grid, if you set the Max. battery capacity at 80% at Time Control UPS Mode and Customized UPS Mode then AC300 could be charged to 80% via grid. The rest of the 20% capacity will be recharged via solar panels.

10.1.2. UPS working system introduction

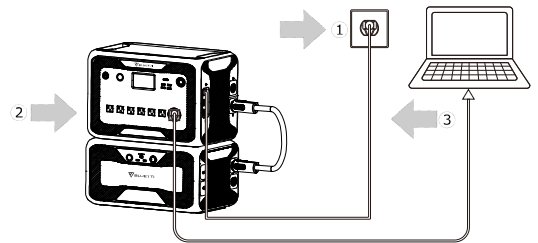
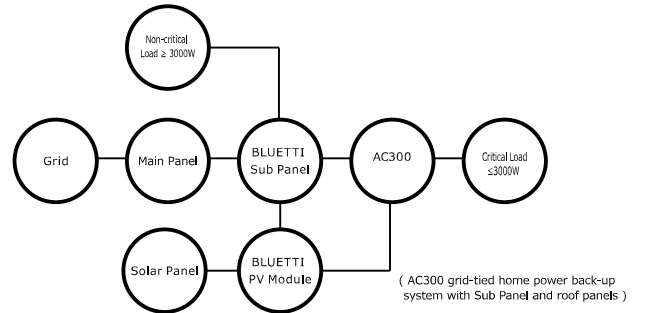
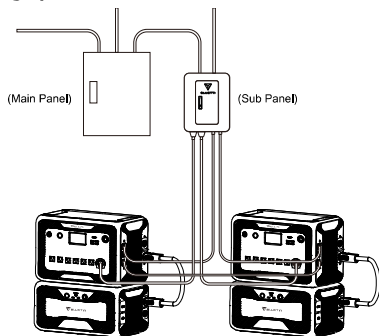

( Plug-in UPS system )

Step1: Plug the AC charging cable into the wall outlet.  
Step2: Plug the AC charging cable into the AC input port.  
Step3 : Connect the load to AC300 via AC output port  
Note: The output power in Plug-in UPS Mode is subject to the **specification of the current and voltage from home circuit.**  
a, Standard UPS Mode. b, Time Control UPS Mode.  
c, PV Priority UPS Mode. d, Customized UPS Mode.  
Eg: Current (15A wire) X Voltage (120V) = 1800W in US  
Eg: Current (30A wire) X Voltage (120V) = 3000W in US

10.1.3. Turn On UPS Function

● Select "Setting" on the main touchscreen interface. Select "Next" and select "Working Mode" to choose UPS Mode.

● The default working mode is “Standard UPS Mode”.

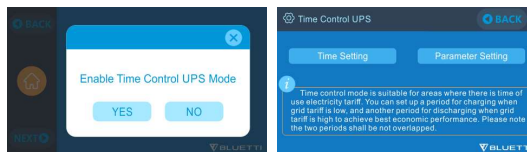
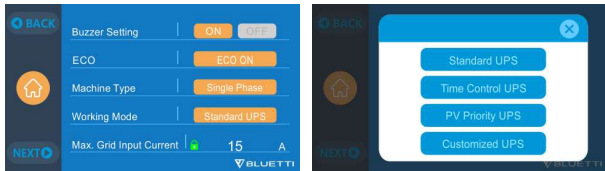

## 10.2. Enable UPS Running Mode

### 10.2.1 Standard UPS Mode

● The AC300+B300 will power your load directly from the grid and maintain a 100% charge. When grid power fails, the AC300 switches to internal batteries.

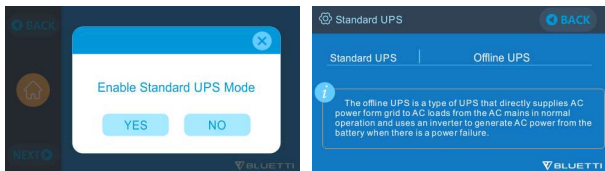

### 10.2.2. Time Control UPS Mode

● Set the times of the AC300+B300 to be charged via grid power and the times to run loads from its battery.

**Charge Time:** Set the time of when the AC300+B300 is to be recharged by grid to avoid the higher electricity rates.

**Discharge Time:** Set the time to switch to batteries to power loads connected to the Sub Panel (Optional Purchase).

● **Parameter Setting:**

**Battery SOC Low:** When the remaining capacity of AC300+B300 is under the preset High/Low battery capacity, AC300+B300 will stop powering connected loads.

**Battery SOC High:** The maximum capacity AC300+B300 can be charged via grid. Remaining capacity will be charged via solar panels, car, lead-acid battery or second adapter only.

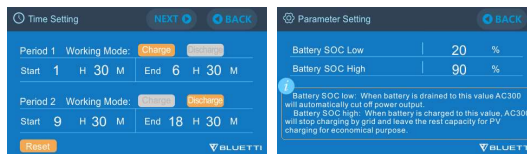

### 10.2.3. PV Priority UPS Mode

● PV Priority Mode: Recommended for areas with stable grid power. The battery will be recharged mainly by PV for power savings.

● Note: In PV Priority Mode, AC300 can only be recharged via grid to 30% capacity, and also discharge to 30% of the capacity (you can tweak it to 100% for full grid charging manually on touchscreen or App) as the "Reserved capacity for PV charging". And rest of the capacity will be fully charged from either solar power or 2 adaptors.

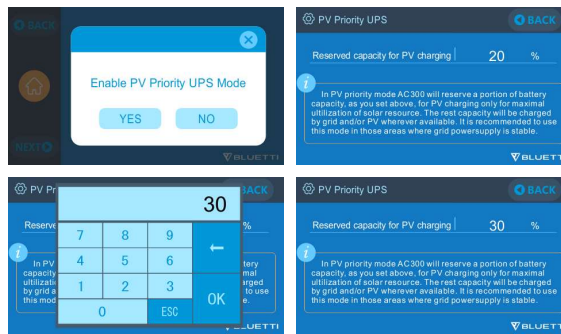

### 10.2.4. Customized UPS Mode

- Charge/Discharge time, and High/Low Battery SOC can be set in this UPS mode.
- Ability to disable the grid charging. The unit will not charge batteries from grid.
- Apart from Time Control UPS, the main switch of grid charging and time mode settings are involved. The setting of "Time Setting" and "SOC Setting" will take effect on both PV Priority Mode, Standard UPS Mode, and Time Control Mode.

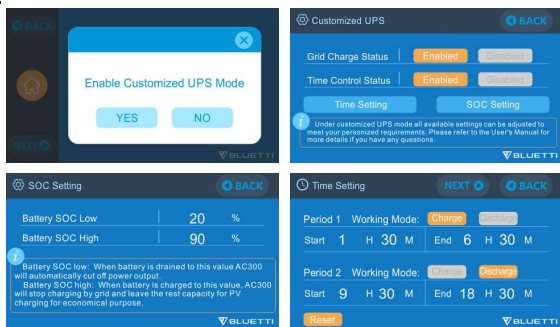

## 11. SPLIT PHASE FUNCTION

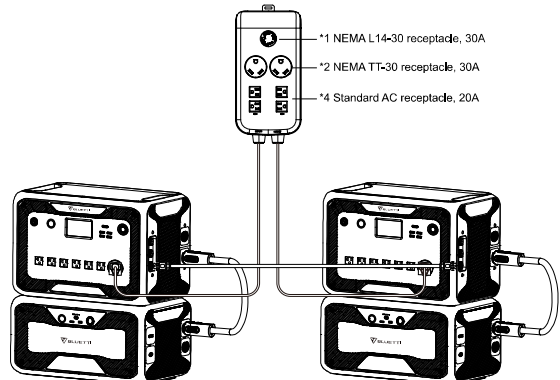

**Note:**

(1) Please disconnect the AC charging cable for both AC300 units while binding into split phase box.

(2) Certificated Technician is required to build the split phase system to power the Sub Panel.

**Warning:** If you insist to charge the AC300 which has been connected into split phase box already, please make sure the L1/L2/N wire is set at the right phase sequence or the AC300 will be damaged.

L: Live wire N: Neutral wire

### CONNECTION 1 (Standard Mode)

"Single Phase" is set as the default machine type if you are operating a single AC300+B300 system. It's the only and correct setting if a single AC300+B300 is being used. "Machine type" is only used to set for Split Phase, "Split Phase" is only used for connecting both \*2 AC300+B300 (exclusive for AC300 100-120V Version) bonded 2 pairs of AC300+B300 to one power supply system to double the output power, voltage, so as to capacity. Please refer to Split Phase Setting for detailed information.

### CONNECTION 2 (Power Mode)

In Split Phase Power System, it is recommended that you choose the **Fusion AC Input Cable**. The AC input ports of the two set of AC300+B300 should be connected to be as the phase sequence: L1,N,PE and L2,N,PE. Make sure that the phase sequence of the two machines is correct.

**Wrong Connection will damage the power station and your warranty will be invalid, BLUETTI will not take responsibility for the damage caused by personal negligence or wrong operation.**

The Fusion AC Input Cable(Optional Purchase) is designed to power the Split Phase System. One end of the cable is going to be connected to NEMA L14-30 socket, and connect the aviation plugs to the AC input ports of the two set of AC300+B300. The current of AC input plug: ≥ 30A.

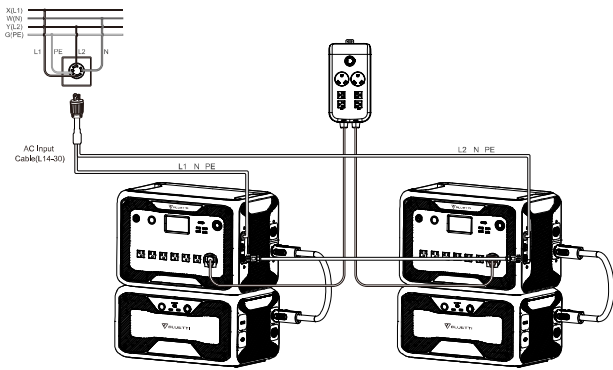

**WRONG CONNECTION**

It's forbidden to charge AC300+B300 through the original AC charging cable in Split Phase System, please use Fusion AC Input Cable(Optional Purchase) to charge the two set of the AC300+B300 in Split Phase System.

Wrong Connection will damage the power station and your warranty will be invalid, BLUETTI will not take responsible for the damage caused by personal negligence or wrong operation.

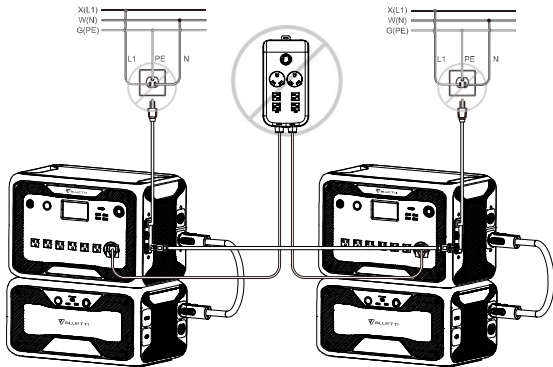

- The "Machine Type" setting on screen is used to enable or disable Split Phase output. Split-Phase output is achieved by bonding two AC300 into one power system to double the available output power, voltage, and capacity.
- "Split Phase" is only used for connecting both \*2 AC300 together (exclusive for the 100-120V version of the AC300). A Fusion Box(P30A) is required (sold separately).
- Launch Split Phase Function:

**Note:**

If one of the AC300 is out of power, the Split Phase Bonding function will deactivate automatically.

Step 1: Plug the output cables from each of the two AC300 to the Split Fusion Box Pro.

Step 2: Plug the communication cables from each of the two AC300 to the Split Fusion Box Pro.

Step 3: Set the Machine Type to "Split Phase" on AC300 either.

Step 4: Select "Master" or "Slave" on the operating AC300. Select "Master" will set the operating AC300 as the one to control both two AC300. Then select "Slave" for another AC300.

Step 5: Clear the alarm history if the connection failed and reconnect the cables.

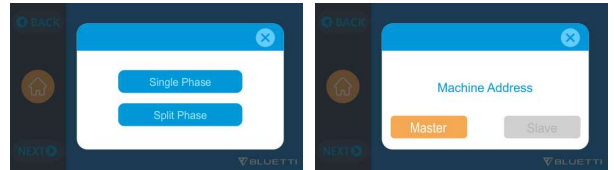

**12. TECHNICAL SPECIFICATION**

Model	AC300-JP	AC300-US	AC300-EU/UK/AU
Net Weight	21.6kg (47.62lbs)		
Dimensions	520*320*358mm (20.5*12.5*14.1in)		
Charge Temperature	0-40°C (32-104 °F)		
Discharge Temperature	-20-40°C (-4-104 °F)		
Storage Temperature	-20-40°C (-4-104 °F)		
Working Environment Humidity	10-90%		
Certification	PSE, FCC, CE, UN38.3, msds, UL, SAA and ROHS		
Capacity	3072-12288Wh (60-240Ah)		
Battery Type	LiFePO4		
Standard Battery Voltage	51.2VDC		
Battery Cell Voltage Range	44.8-57.6VDC		
Short-circuit Protection	Included		
Over-temperature Protection	Included		
MPPT	Built-in		
<b>Over-temperature Protection</b>			
Discharge Over-temperature	65°C		
Discharge Over-temperature Recovery	55°C		
Charge Over-temperature	55°C		
Charge Over-temperature Recovery	45°C		
<b>AC Output</b>			
AC Inverter	*7 3000W total		*6 3000W total
Rated Output Voltage	100VAC	120VAC	220-240VAC

Rated Output Frequency	50/60Hz		
Rated Continuous Power	3000W		
Rated Output Current	30A	25A	13A
Power of Over-load	3100W < load < 3750W, 2min; 3750W < load < 4500W, 5s; 4500W < load < 6000W, 500ms		
Efficiency	>88%		
THD	<5%		
<b>DC Output</b>			
Cigarette Lighter Port	*1 24VDC,10A		
USB-A	*2 5VDC,3A,15W total		
USB-A(fast charging)	*2 3.6-12VDC,3A;18W*2 total		
USB-C (Type-C)	*1 5-15VDC,3A;20VDC,5A,100W		
Wireless Charging Pad	*2 5/7.5/10/15W*2		
RV Port	*1 12VDC,30A	408W>load, 2S	
<b>AC Input</b>			
Input Voltage	85-110VAC/JP	102-132VAC/US	207-253VAC EU/UK/AU
Input Frequency	47Hz-63Hz		
Max. Input Current	30A		
Configurable Input Current	Preset at 15A, can be changed on screen		
AC Charging Voltage Range	90-264VAC		
AC Charging Frequency Range	47Hz-63Hz		
Power of Charging	3000W Max		
<b>PV Input</b>			
Max. Input Voltage	150VDC		
MPPT Voltage Range	12-150VDC		
Max. Power of Input	1200W*2		
Rated Input Current	12A*2		



### 13. STORAGE AND MAINTENANCE

- Please turn off the unit and charge it to 50-70% capacity every time before storing it.
- To preserve the battery health, please discharge and fully charge the unit at least once every 6 months.
- Ensure proper ventilation in use or store and keep away from any combustible materials or gases.
- Do not stack anything on the top of the unit in storage or use.
- Avoid exposing the unit to rain or wet environment, and direct sunlight (32-113 °F , 0-45°C ), clean and dry environment is strongly recommended.
- Dry, non-abrasive cloths to wipe will be perfect. The power station is a versatile tool for various adventures, simple cleaning would be required from time to time to keep the unit in a good condition.
- Keep the unit away from children and pets.

### 14. TROUBLESHOOTING

Error Code	Error List	Troubleshooting
001	D-AMCU Warning	Please contact with the dealer if the error still exists after rebooting the unit.
002	D-BMS Warning	Please contact with the dealer if the error still exists after rebooting the unit.
003	D-A Communication Error	Please contact with the dealer if the error still exists after rebooting the unit.
004	Battery Voltage High -Hardware	Please contact with the dealer if the error still exists after rebooting the unit.
005	BUS Voltage High-Hardware	Please contact with the dealer if the error still exists after rebooting the unit.
006	SPS Voltage Low-Hardware	Please contact with the dealer if the error still exists after rebooting the unit.
007	Fan Warning-Hardware	Clean or replace the fan to ensure proper ventilation. Please contact with the dealer if the error still exists after rebooting the unit.

008	OCP (Over Current Protection)- Hardware	Please contact with the dealer if the error still exists after rebooting the unit.
009	LLC Soft-Start Failure	Please contact with the dealer if the error still exists after rebooting the unit.
010	BUS Soft-Start Failure	Please contact with the dealer if the error still exists after rebooting the unit.
011	H-BUS Voltage High	Please contact with the dealer if the error still exists after rebooting the unit.
012	Bus Voltage High	Please contact with the dealer if the error still exists after rebooting the unit.
013	LLC-Bus Voltage High	Please contact with the dealer if the error still exists after rebooting the unit.
014	Bus Voltage Low	Please contact with the dealer if the error still exists after rebooting the unit.
015	DC Input Voltage High	Please contact with the dealer if the error still exists after rebooting the unit.
016	DC Input Voltage Low	Please contact with the dealer if the error still exists after rebooting the unit.
017	DC Input Over Current	Please contact with the dealer if the error still exists after rebooting the unit.
018	Inverter Output Over Current	The output power of load exceeds. Please contact with the dealer if the error still exists after rebooting the unit.
019	Inverter Voltage High	Please check if the output of load meets the specifications of the unit. Turn on the AC after rebooting, please contact with the dealer if the error still exists.
020	Inverter Voltage Low	Please check if the output of the load meets the specifications of the unit. Turn on the AC after rebooting, please contact with the dealer if the error still exists.
021	Grid Input Over Current	Please check if the input of the current meets the specifications of the unit. Turn on the AC after rebooting, please contact with the dealer if the error still exists.

022	Inverter Output Short circuit	Please disconnect the load to make sure the load has been connected properly. Click to clear the alarm history.
023	Inverter Over-load Protection	Please disconnect the load to make sure the output power of loads meet the limit of the unit. Click to clear the alarm history.
024	Phase Integration Error	Check the input wire and whether the "Master" unit or "Slave" unit can work well.
025	AC Relay Short Circuit	Please contact with the dealer if the error still exists after rebooting the unit.
026	AC Relay Open Circuit	Please contact with the dealer if the error still exists after rebooting the unit.
027	Load Relay Short Circuit	Please contact with the dealer if the error still exists after rebooting the unit.
028	Load Relay Open Circuit	Please contact with the dealer if the error still exists after rebooting the unit.
049	PV1 Over Current	Please contact with the dealer if the error still exists after rebooting the unit.
050	PV2 Over Current	Please contact with the dealer if the error still exists after rebooting the unit.
051	PV1 Over Voltage	Please check if the open circuit voltage of solar panels exceeds the input voltage standard of AC300.
052	PV2 Over Voltage	Please check if the open circuit voltage of solar panels exceeds the input voltage standard of AC300.
053	D-BAT Full	The battery is full.
054	D-BAT Drained	Empty of battery. When SOC > 5%, the alarm is cleared. You need to turn AC ON again on the screen.
055	Inverter Overload Warning	The output power of load exceeds.
056	AC Overload Warning	The output power of load exceeds.

057	Grid Voltage High	Please check whether the grid voltage fits the input voltage standard of AC300.
058	Grid Voltage Low	Please check whether the grid voltage fits the input voltage standard of AC300.
059	Grid Frequency High	Please check whether the grid frequency fits the input frequency of AC300.
060	Grid Frequency Low	Please check whether the grid frequency fits the input frequency of AC300.
061	Multi Communication Error	Please check whether the communication cable is connected correctly. Clear the alarm history or restart the unit.
062	Multi Address Error	Please check whether the communication cable is connected correctly. Clear the alarm history or restart the unit.
063	Multi Synchronization Error	Please check whether the communication cable is connected correctly. Clear the alarm history or restart the unit.
064	Multi Brak Phase Error	Please check if the input of the AC voltage meets the specifications of the unit. Clear the alarm history or restart the unit.
065	PV Paralleling Error	Please check whether the PV parallel enable setting is consistent with the PV input. Please contact with the dealer if the error still exists after rebooting the unit.
081	BMS Communication Interrupt	Please contact with the dealer if the error still exists after rebooting the unit.
082	LCD Communication Interrupt	Please contact with the dealer if the error still exists after rebooting the unit.
083	EEPROM Read & Write Error	Please contact with the dealer if the error still exists after rebooting the unit.
084	DSP Configuration Error	Please contact with the dealer if the error still exists after rebooting the unit.
085	RTC Read & Write Error	Please contact with the dealer if the error still exists after rebooting the unit.

086	12V/30A Port OCP	Please disconnect the appliances on DC 12V/30A ports. Clear the alarm history or restart the unit.
087	24V/10A Port OCP	Please disconnect the appliances on DC 24V/10A ports. Clear the alarm history or restart the unit.
088	USB/TYPE-C/PD Port Current High	Please disconnect the appliances on USB ports. Clear the alarm history or restart the unit.
089	DC 12V/30A Output Current High	Please disconnect the appliances on DC 12V/30A ports. Clear the alarm history or restart the unit.
090	DC 24V/10A Output Current High	Please disconnect the appliances on DC 24V/10A ports. Clear the alarm history or restart the unit.
091	DC Output soft start Failure	Please contact with the dealer if the error still exists after rebooting the unit.
092	DC 12V/30A Output Short Circuit	Please disconnect the appliances on DC output ports.
093	DC 24V/10A Output Short Circuit	Please disconnect the appliances on DC output ports.
094	USB/TYPE-C/PD Port Locked	Please disconnect the load to make sure the output power of loads meet the limit of the unit. Please contact with the dealer if the error still exists after rebooting the unit.
095	12V/30A DC Port Locked	Please disconnect the load to make sure the output power of loads meet the limit of the unit. Please contact with the dealer if the error still exists after rebooting the unit.
096	24V/10A DC Port Locked	Please disconnect the load to make sure the output power of loads meet the limit of the unit. Please contact with the dealer if the error still exists after rebooting the unit.

The firmware including ARM, DSP, IoT and BMS can be upgraded online through BLUETTI APP.

- Can it be charged and discharged at the same time?  
Yes, the unit supports pass-through charging function for both AC and DC outputs.
- What is the UPS switching latency?  
No delay for online UPS; 20ms from offline UPS.
- Can I connect my two AC300+B300 units with a Fusion Box(P020A) to achieve double the output power, voltage and capacity?  
Only Fusion Box Pro(P030A) can be connected two set of AC300+B300 power station.
- Can I use third-party solar panels to charge the unit?  
Yes, the third-party solar panels are available as long as they contain MC4 connectors, besides the voltage (in series or parallel) is between 12V to 150V and the maximum combined input power from the two PV input ports is 2400W. If the open circuit voltage of the panels is between 150V-550V, you can choose D300S to drop down the voltage of the panels to achieve solar charging.
- How do I know whether my appliance can work well with the power station?  
Calculate how much the continuous loads are for your appliances are in total. As long as they do not exceed the rated output power of the power station, it should work.
- How can I connect the product to my main panel?  
To install the grid-tie power system, an electrician with a professional technician certificate is required, connect the wires of critical equipment from your main electrical box to the BLUETTI Sub Panel (optional purchase), then connect AC300 to the Sub Panel.

## 16. DECLARATION

- Some changes including App may not be noticed specifically such as appearance or specifications due to the exterior material or hardware improvement of the product.
- BLUETTI shall not be liable for any damage caused by force majeure such as fire, typhoon, flood, earthquake or the user's intentional negligence, misuse or other abnormal conditions.
- No compensation for damages shall be made for utilizing non-standard

097	BMS Temperature abnormal	Please store AC300 at the recommended temperature and leave it until the temperature inside back to the normal standard.
098	BMS Over Voltage	Please contact with the dealer if the error still exists after rebooting the unit.
099	BMS Low Voltage	Please contact with the dealer if the error still exists after rebooting the unit.
100	BMS Over Current	Please contact with the dealer if the error still exists after rebooting the unit.
101	BMS Precharge Error	Please contact with the dealer if the error still exists after rebooting the unit.
102	BMS Output Short Circuit	Please contact with the dealer if the error still exists after rebooting the unit.
103	BMS communication cable error	Please check whether the battery power cable is reliably connected. Please check whether the lock switch on the power cable has been turned on. Please contact with the dealer if the error still exists after rebooting the unit.
107	NTC Faulty	Please leave the unit at the recommended temperature few hours to recover. Please contact with the dealer if the error still exists after rebooting the unit.
108	Fan Faulty	Clean or replace the fan to ensure proper ventilation. Please contact with the dealer if the error still exists after rebooting the unit.

adapters and accessories.

- BLUETTI will not bear all responsibilities if the damage is caused by not operating the product properly according to the instruction of user manual.
- AC300 is not suitable for use on the relevant equipment or machines involving:  
Personal safety, such as atomic energy devices, aerospace devices, or any equipment or machines that require highly reliable power sources. We are not responsible for accidents, fires, or wrongful or negligent actions done to the machine and equipment which result in damage.

## FCC WARNING:

This device complies with part 15 of the FCC Rules. Operation is subject to the following

two conditions: (1) this device may not cause harmful interference, and (2) this device must accept any interference received, including interference that may cause undesired operation.

Any changes or modifications not expressly approved by the party responsible for compliance could void the user's authority to operate the equipment.

NOTE: This equipment has been tested and found to comply with the limits for a Class B digital device, pursuant to Part 15 of the FCC Rules. These limits are designed to provide reasonable protection against harmful interference in a residential installation. This equipment generates, uses and can radiate radio frequency energy and, if not installed and used in accordance with the instructions, may cause harmful interference to radio communications. However, there is no guarantee that interference will not occur in a particular installation.

If this equipment does cause harmful interference to radio or television reception, which can be determined by turning the equipment off and on, the user is encouraged to try to correct the interference by one or more of the following measures:

- Reorient or relocate the receiving antenna.
- Increase the separation between the equipment and receiver.
- Connect the equipment into an outlet on a circuit different from that to which the receiver is connected.
- Consult the dealer or an experienced radio/TV technician for help.

FCC Radiation Exposure Statement

This equipment complies with FCC radiation exposure limits set forth for an uncontrolled environment. This equipment should be installed and operated with a minimum distance of 20 cm between the radiator and your body.

<b>EU REP</b> Company: POWEROAK GmbH Address: Lindwurmstr. 114, 80337 München Germany Mail: logi@bluetti.de	<b>UK REP</b> Company: POWEROAK ENERGY UK CO.,LTD Address: Suite 108 Chase Business Center 39-41 Chase Side London United Kingdom N14 5BP Mail: poweroak.eu@bluetti.com
---	---

P/N:17.0303.0400-00A0