



# OTA TEST REPORT

**Applicant**      Espressif Systems  
**Product**        ESP ANT B  
**Model**            ESP ANT B  
**Report No.**      Y2209A0967-T1  
**Issue Date**      October 8, 2022

TA Technology (Shanghai) Co., Ltd. tested the above equipment in accordance with the requirements in **ANSI/IEEE Std 149-2008**. The test results show that the equipment tested is capable of demonstrating compliance with the requirements as documented in this report.

Handwritten signature of Xu Ying in black ink.

*Prepared by: Xu Ying*

Handwritten signature of Xu Kai in black ink.

*Approved by: Xu Kai*

---

**TA Technology (Shanghai) Co., Ltd.**

*Building 3, No.145, Jintang Rd, Tangzhen Industry Park, Pudong Shanghai, China*

*TEL: +86-021-50791141/2/3*

*FAX: +86-021-50791141/2/3-8000*



## TABLE OF CONTENTS

1.	General Information .....	3
1.1.	Notes of the Test Report .....	3
1.2.	Testing laboratory .....	3
1.3.	Laboratory Environment .....	3
2.	General Description of Equipment under Test .....	4
2.1.	Applicant Information .....	4
2.2.	Manufacturer Information .....	4
2.3.	Information of EUT .....	4
2.4.	Test Date .....	4
2.5.	Applied Standards .....	5
3.	Test Conditions .....	6
3.1.	Test Configuration .....	6
3.2.	Test Measurement .....	6
4.	Test Results .....	7
4.1.	Gain and Efficiency .....	7
4.2.	Voltage Standing Wave Ratio (VSWR) .....	8
4.3.	Antenna S11 .....	9
5.	Test Equipment List .....	10
	APPENDIX A: 2-D Pattern Plots .....	11
	<b>APPENDIX B: The EUT Appearance and Test Configuration</b> .....	15
	<b>B.1 EUT Appearance</b> .....	15
	<b>B.2 Test Configuration</b> .....	16



## 1. General Information

### 1.1. Notes of the Test Report

This report shall not be reproduced in full or partial, without the written approval of TA technology (shanghai) co., Ltd. The results documented in this report apply only to the tested sample, under the conditions and modes of operation as described herein. Measurement Uncertainties were not taken into account and are published for informational purposes only. This report is written to support regulatory compliance of the applicable standards stated above. This report must not be used by the client to claim product certification, approval, or endorsement by any government agencies.

### 1.2. Testing laboratory

Company: TA Technology (Shanghai) Co., Ltd.  
Address: Building 3, No.145, Jintang Rd, Tangzhen Industry Park, Pudong Shanghai, China  
City: Shanghai  
Post code: 201201  
Country: P. R. China  
Contact: Xu Kai  
Telephone: +86-021-50791141/2/3  
Fax: +86-021-50791141/2/3-8000  
Website: <http://www.ta-shanghai.com>  
E-mail: [xukai@ta-shanghai.com](mailto:xukai@ta-shanghai.com)

### 1.3. Laboratory Environment

Temperature	Min. =19°C, Max. = 25°C	
Relative humidity	Min. =40%, Max. =72%	
Shield effect	0.7-6GHz	> 100dB
Ground resistance	<0.5Ω	



## 2. General Description of Equipment under Test

### 2.1. Applicant Information

Company: Espressif Systems  
Address: #101, Block 2, 690 Bibo Road, Zhang Jiang High-Tech Park, Shanghai, China

### 2.2. Manufacturer Information

Company: Espressif Systems  
Address: #101, Block 2, 690 Bibo Road, Zhang Jiang High-Tech Park, Shanghai, China

### 2.3. Information of EUT

#### General information

EUT Description	
Product Name:	ESP ANT B
Model	ESP ANT B
HW Version:	/
SW Version:	/
Antenna Type:	PCB Antenna
Antenna Size	18mm *6.19mm *0.8mm
Antenna Manufacturer:	Espressif Systems
Test Frequency:	2400MHz ~ 2500MHz

Test values partial duplicated from the original Report (Report No.:Y1806A0621-T1V3). Only add 2400 MHz, 2490 MHz and 2500 MHz test data in this report.

### 2.4. Test Date

The test is performed from June 25, 2018 to August 3, 2018 and October 5, 2022.



## 2.5. Applied Standards

According to the specifications of the manufacturer, it must comply with the requirements of the following standards:

Test Method: **ANSI/IEEE Std 149-2008**



### 3. Test Conditions

#### 3.1. Test Configuration

Great-Circle-Cut method is used to measure the antenna 3D GAIN of EUT in OTA qualified anechoic chamber. Equipment Under Test (EUT) geometry centre vertical projection at the centre of platform, the distance from EUT to measurement antenna is 5m.

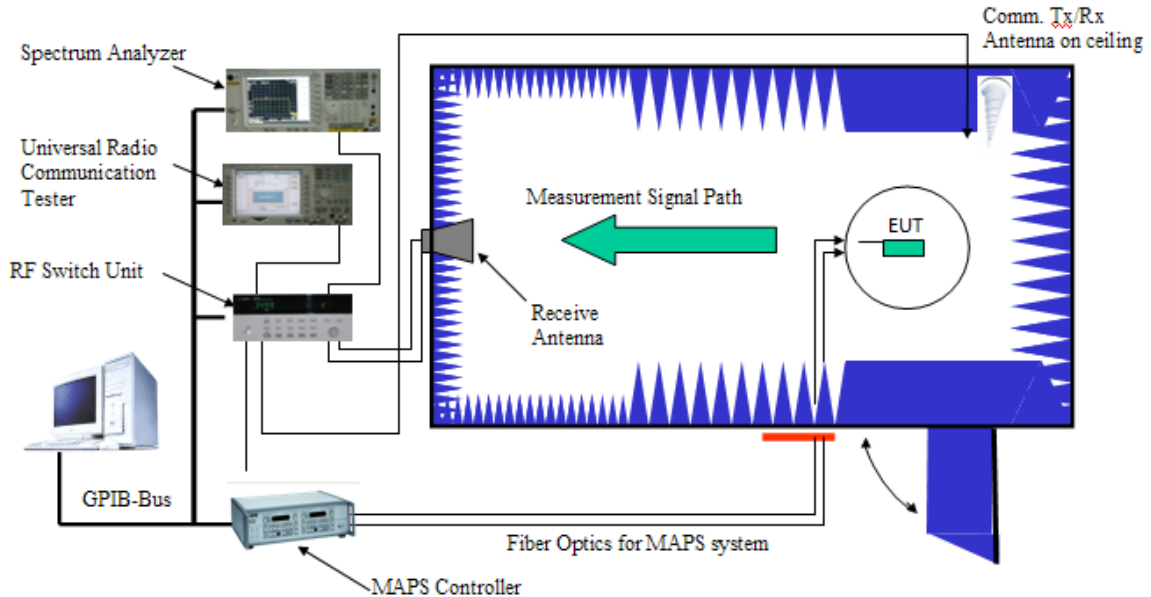

#### 3.2. Test Measurement

##### Spherical coordinate system

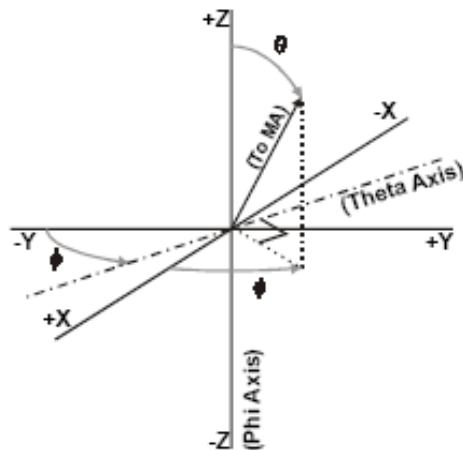

Figure 1 Test coordinate system

Note: Theta is from 0~180 degree. Phi is from 0~360. Rotate the EUT and record the Data, the step of rotation is 30 degree.



## 4. Test Results

### 4.1. Gain and Efficiency

Test Item	Test State	Frequency (MHz)	Efficiency (%)	Gain (dBi)	Note
Gain	Free Space	2400	72.68	3.76	Vertical 30°
		2412	73.79	2.39	
		2417	77.04	2.97	
		2422	79.83	2.80	
		2427	81.19	2.89	
		2432	80.54	3.04	
		2437	76.86	2.86	
		2442	76.17	2.99	
		2447	73.99	2.96	
		2452	72.00	2.80	
		2457	70.71	2.72	
		2462	71.31	2.94	
		2467	71.32	3.12	
		2472	72.03	3.28	
		2477	72.71	3.24	
		2482	75.42	3.42	
		2490	85.32	3.57	
2500	86.78	3.28			

Note: comment variation is +/- 0.02dBi



### 4.2. Voltage Standing Wave Ratio (VSWR)

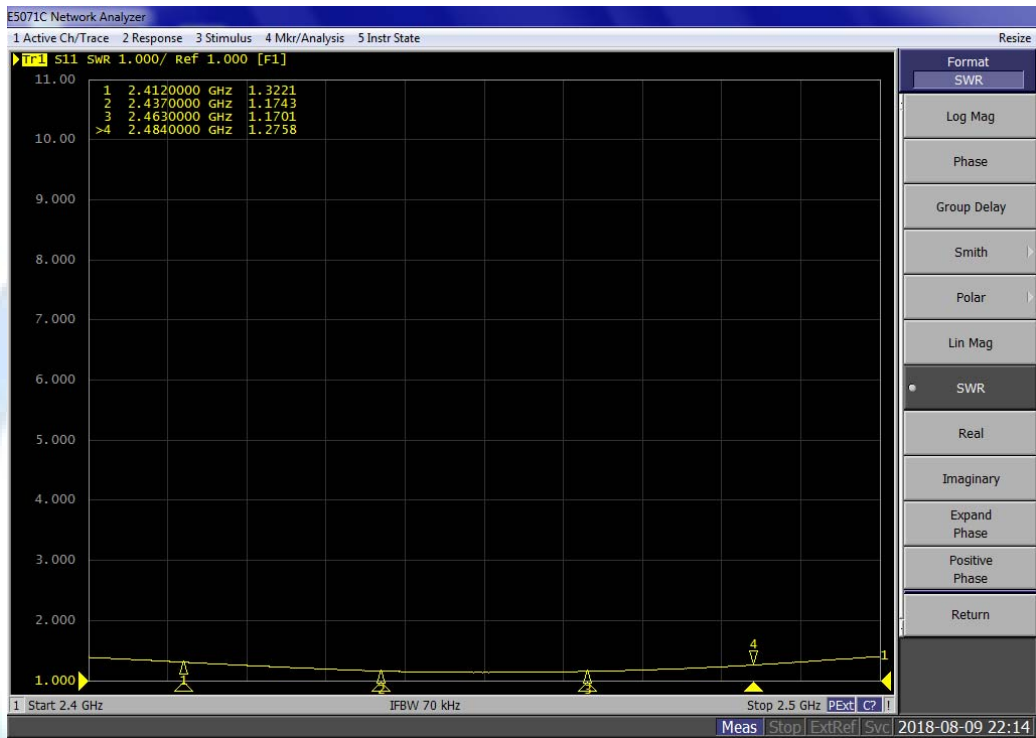

Frequency (MHz)	2412	2437	2463	2484
VSWR	1.32	1.17	1.17	1.28





### 4.3. Antenna S11

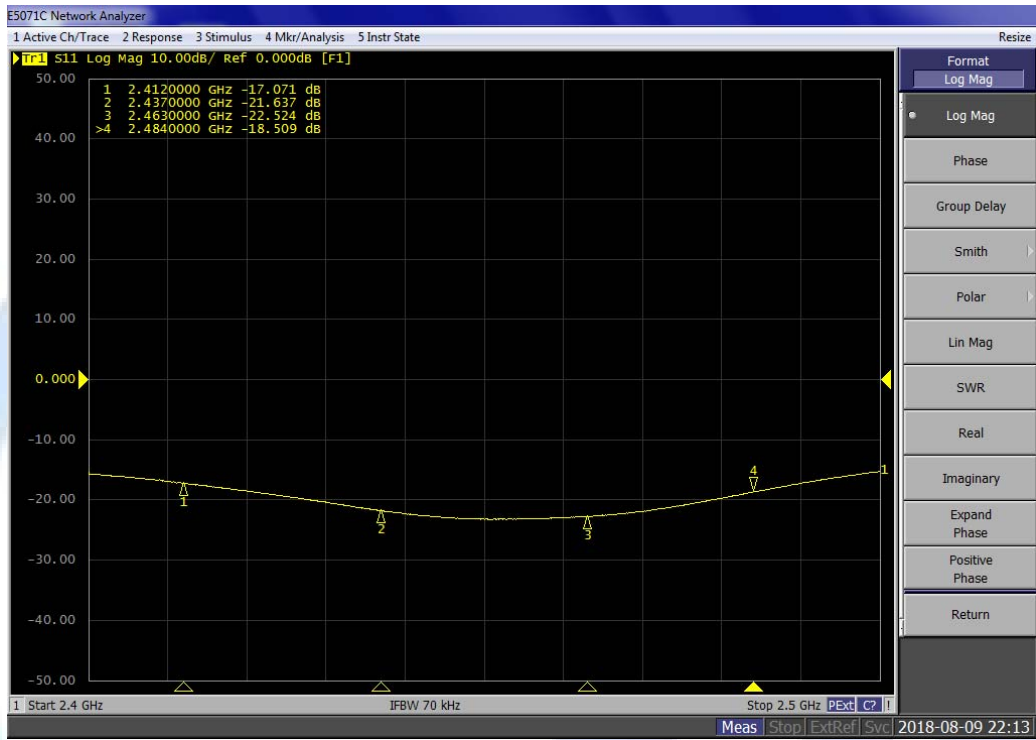

Frequency (MHz)	2412	2437	2463	2484
S11(dB)	-17.07	-21.64	-22.52	-18.51



## 5. Test Equipment List

Date of Sample Received: June 25, 2018 to August 3, 2018

Type of Equipment	Manufacture	Model Number	SN	Calibration Date	Expiration Time
Network Analyzer	Key sight	E5071B	MY42404014	2018-05-20	2019-05-19
Switch Control System	ETS	7006/7001	00059957/MY4 2001152	2018-05-20	2019-05-19
Dual polarized horn antenna	ETS	3164-04	00062743	2018-05-20	2019-05-19
Anechoic Chamber	ETS	AMS-8500	CT-001157- 1219	/	/
Software	ETS-lindgren	EMQ-100 Pattern Measureme nt software	1.09	/	/

Date of Sample Received: October 5, 2022

Type of Equipment	Manufacture	Model Number	SN	Calibration Date	Expiration Time
Anechoic Chamber	ETS	AMS-8500	CT-001157- 1219	2020-05-17	2025-05-16
Test Software	ETS	EMQuest™	REV 1.0.9	/	/
EMCenter_Switch Control System	ETS	7006/7001	00059957/MY 42001152	/	/
Diagonal Dual Polarized Horn	ETS	ETS 3164- 04	00062743	2020-04-14	2025-04-13
Network Analyzer	Keysight	E5071B	MY42404014	2022-05-14	2023-05-13



### APPENDIX A: 2-D Pattern Plots

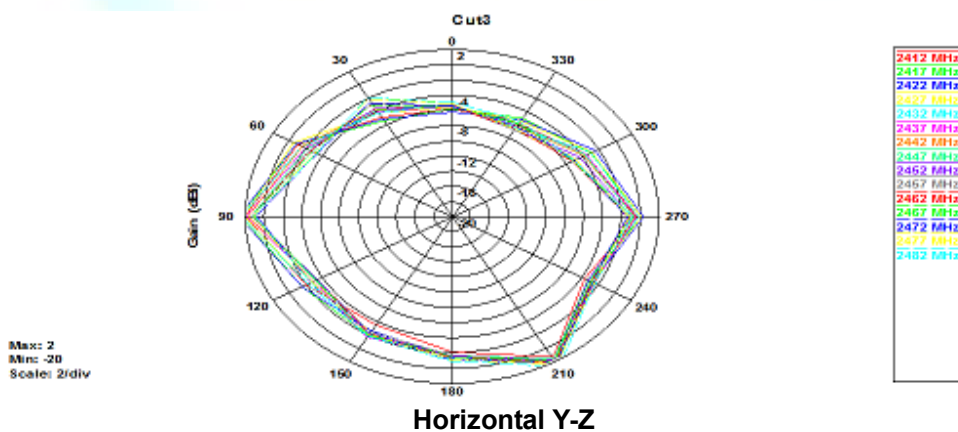
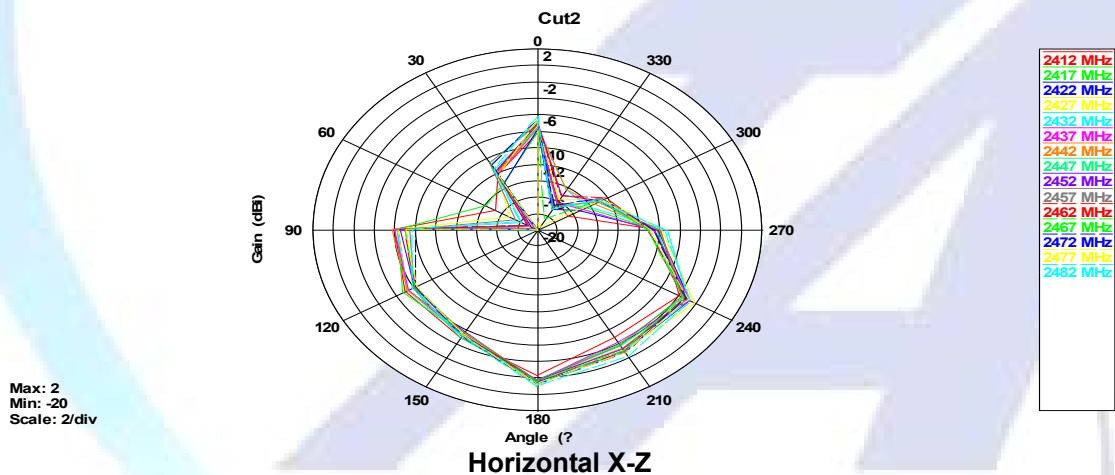
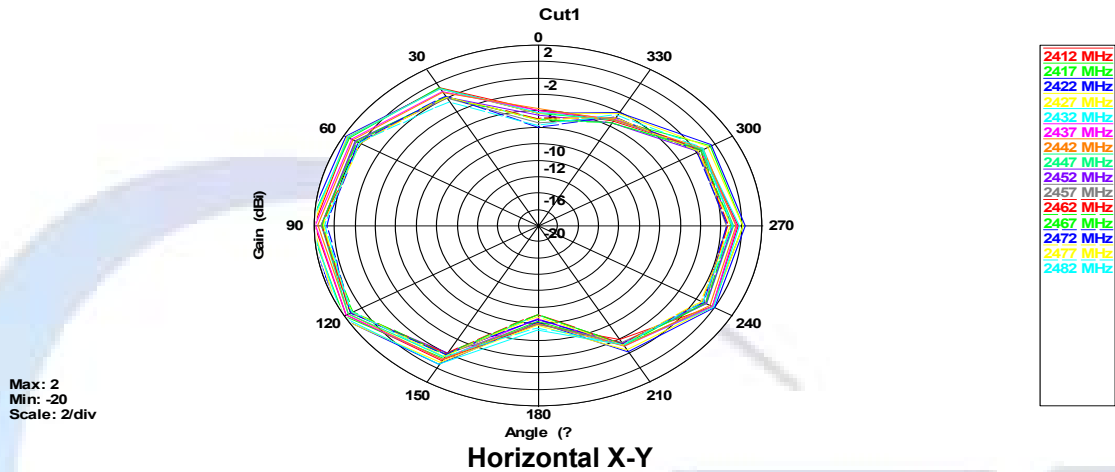

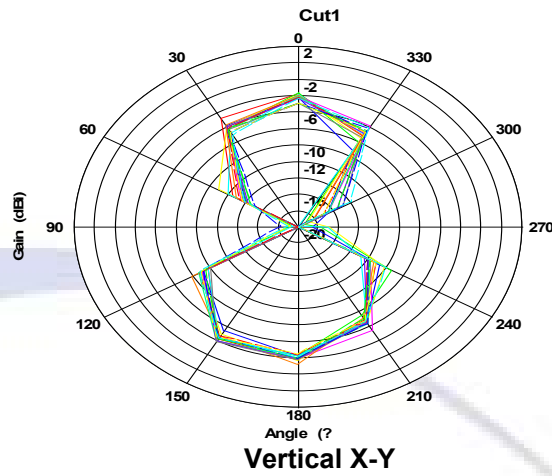

- 2412 MHz
- 2417 MHz
- 2422 MHz
- 2427 MHz
- 2432 MHz
- 2437 MHz
- 2442 MHz
- 2447 MHz
- 2452 MHz
- 2457 MHz
- 2462 MHz
- 2467 MHz
- 2472 MHz
- 2477 MHz
- 2482 MHz

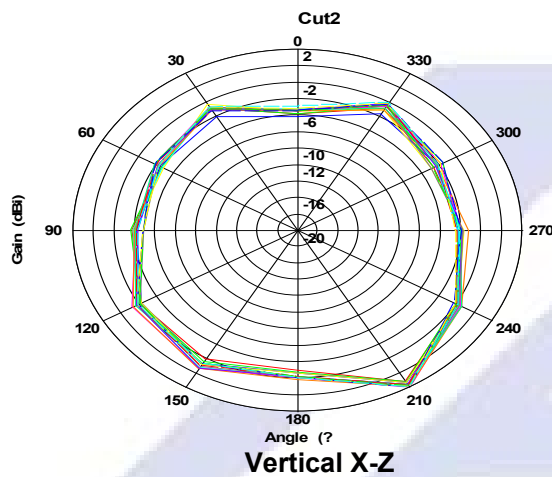

- 2412 MHz
- 2417 MHz
- 2422 MHz
- 2427 MHz
- 2432 MHz
- 2437 MHz
- 2442 MHz
- 2447 MHz
- 2452 MHz
- 2457 MHz
- 2462 MHz
- 2467 MHz
- 2472 MHz
- 2477 MHz
- 2482 MHz

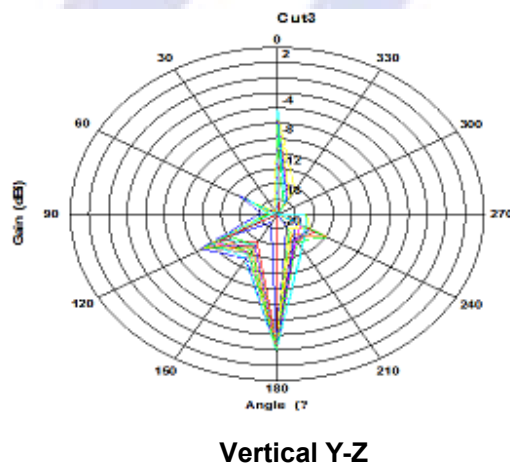

- 2412 MHz
- 2417 MHz
- 2422 MHz
- 2427 MHz
- 2432 MHz
- 2437 MHz
- 2442 MHz
- 2447 MHz
- 2452 MHz
- 2457 MHz
- 2462 MHz
- 2467 MHz
- 2472 MHz
- 2477 MHz
- 2482 MHz

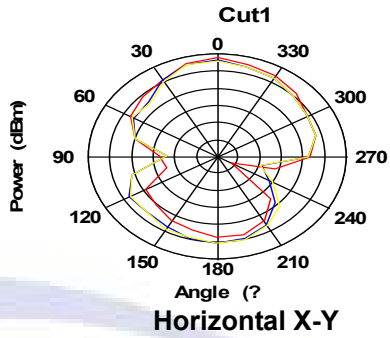

Max: 5  
Min: -25  
Scale: 5/div

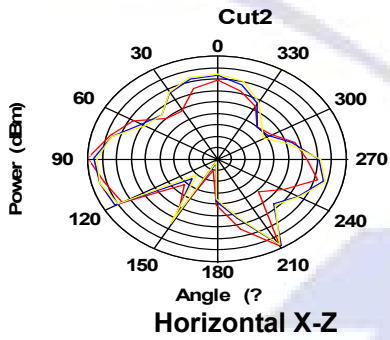
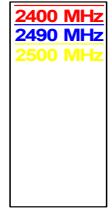

Max: 4  
Min: -14  
Scale: 2/div

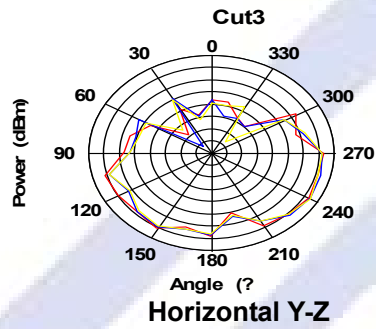
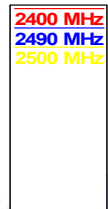

Max: 0  
Min: -40  
Scale: 5/div

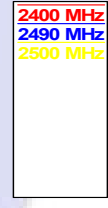

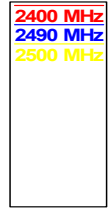
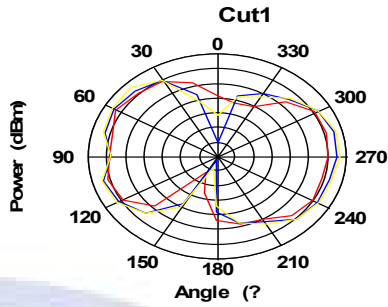

Max: 0  
Min: -35  
Scale: 5/div

Vertical X-Y

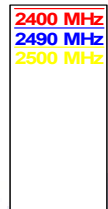
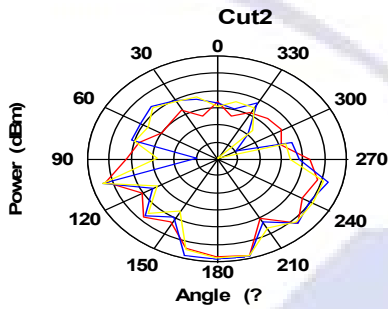

Max: -5  
Min: -35  
Scale: 5/div

Vertical X-Z

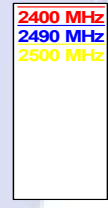
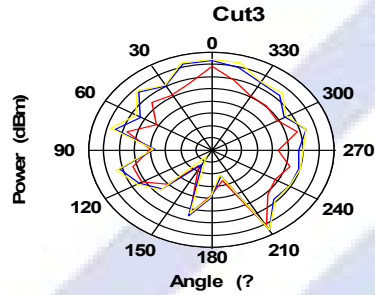

Max: 2  
Min: -14  
Scale: 2/div

Vertical Y-Z

## APPENDIX B: The EUT Appearance and Test Configuration

### B.1 EUT Appearance

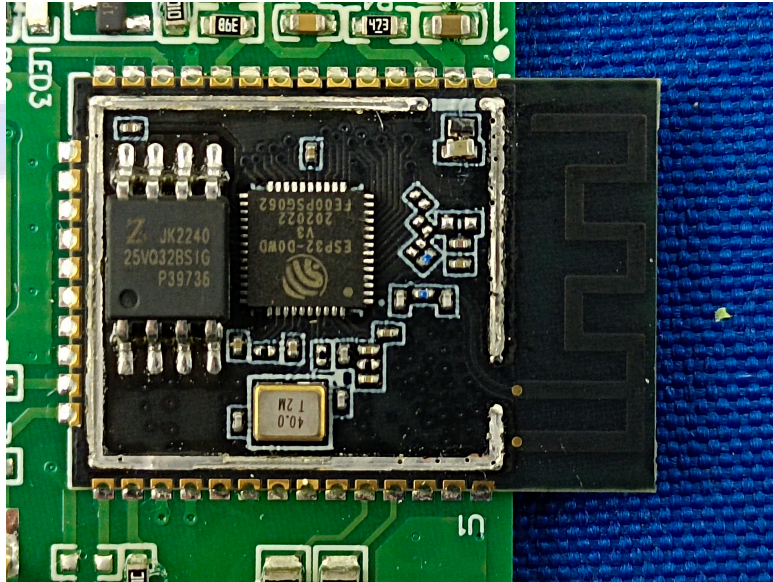

Picture 1 Constituents of EUT

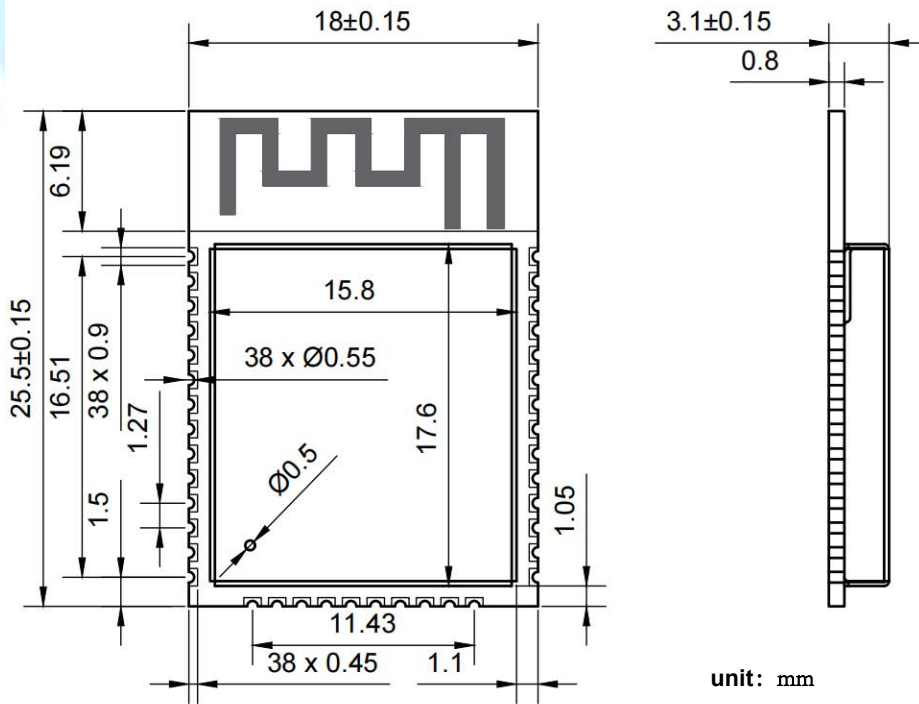



## B.2 Test Configuration

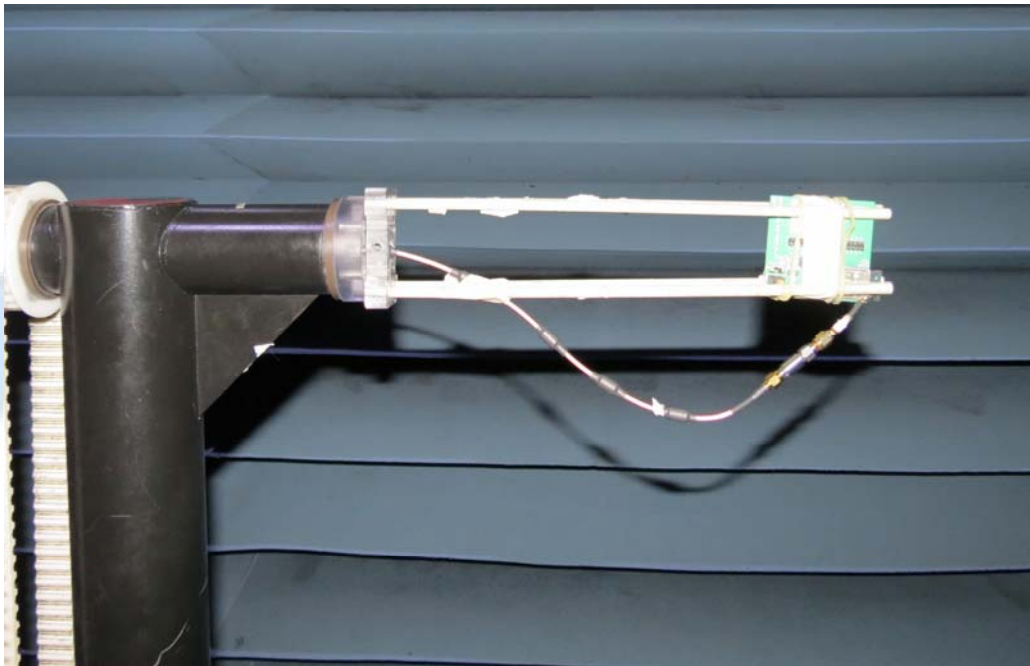

ESP-ANT B  
Picture 2 Test Setup

\*\*\*\*\*END\*\*\*\*\*