

版本	更改	审核	日期
A0	首版发布	徐瑕曼	23.07.31
A1	武工要求更改内容	徐瑕曼	23.09.21
A2	更改标选配等内容	杨振华	24.05.14
A2			

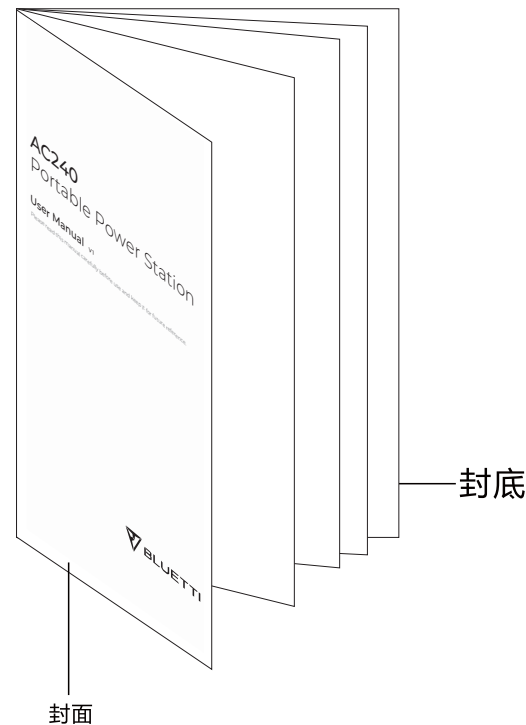
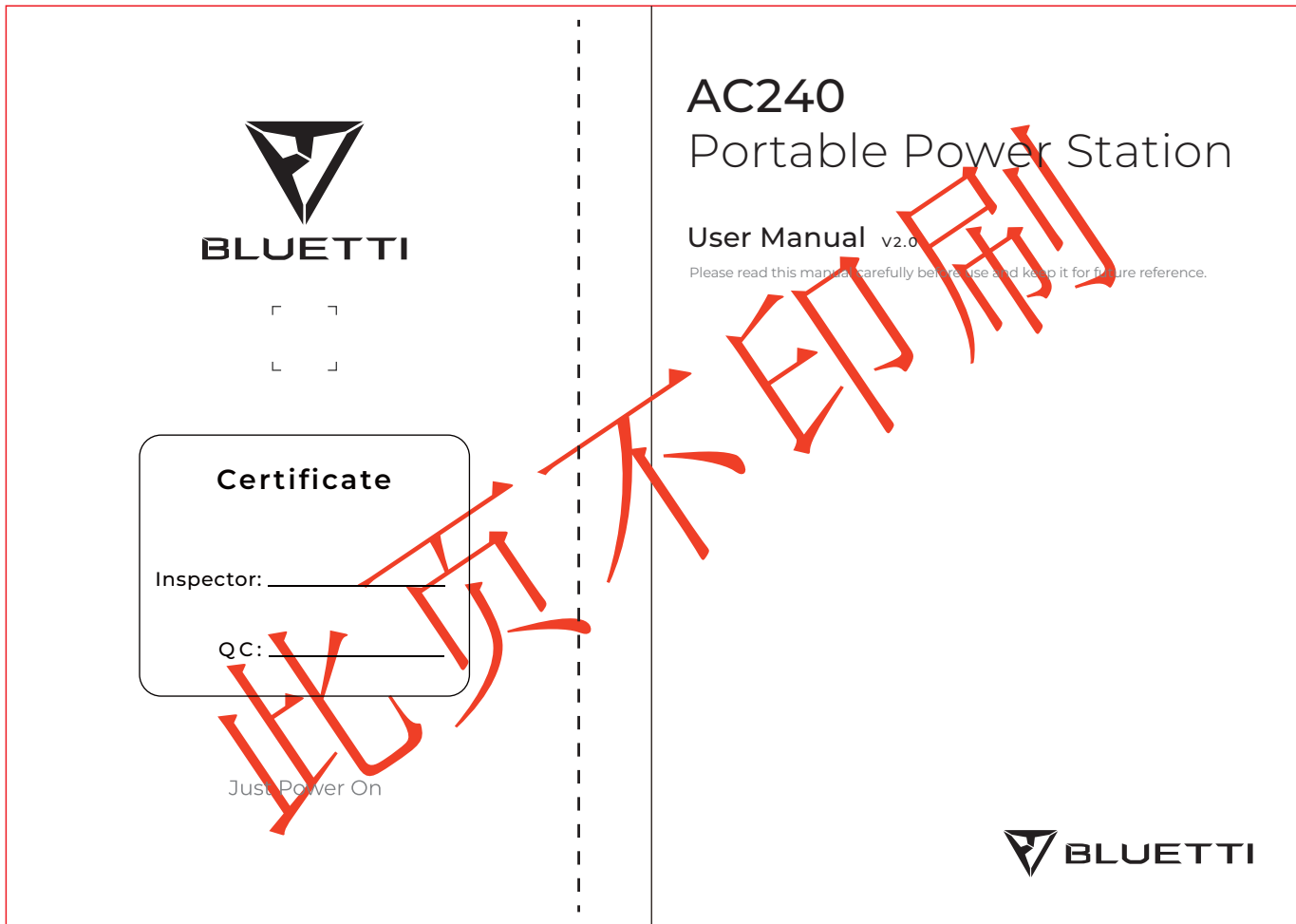

说明书示意图 (40P)

技术要求:

成品尺寸: A5 (142X210mm), 公差+1/-1mm;

材质: 80g书写纸封面封底内页, 双面印刷, 订装;

颜色: 单黑印刷;

所用材质需符合RoHS;

注: 印刷需清晰, 表面洁净, 无凹凸痕迹, 无刮花, 折边整齐;

不能有模糊, 脏污, 脱墨, 花点, 重影, 印歪, 纸张不平整等不良。

样品承认书要求:

01、封面 (供应商&我司承认会签)

02、图纸/规格

03、尺寸报告

04、包装说明

05、试验报告 (如纸张, 胶水, 装订环保证明等)

06、材质分解表 (如纸张的克重品牌, 材质克重和胶水品牌型号等)

07、材质证明、MSDS

(如有第三方正式机构的证明也附上)

08、IQC检验报告

深圳市德兰明海科技有限公司 Shenzhen PowerOak Newener Co.,Ltd			
材料		表面处理	见技术说明
型号	AC240	图纸编号/版本	PR006-6D01A2
名称	美规文说明书 (BLUETTI)		物料编号
设计	审核	批准	17.0303.0629-02
杨振华 24.05.14			共 2 / 页

AC240

Portable Power Station

User Manual v2.0

Please read this manual carefully before use and keep it for future reference.



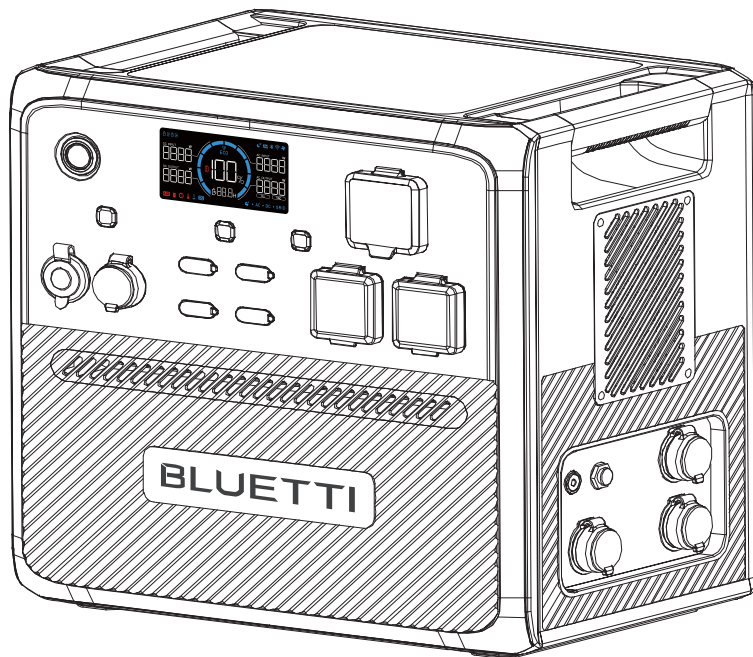

⚠ Warning

1. Charge the unit before first use.
2. Do not use solar panels with open circuit voltage higher than 60VDC. Solar input voltage range for the unit is 11V-60VDC.
3. Charge the unit immediately when the SoC drops below 5%. If the SoC drops to 0, power off the unit and charge it for at least 30 minutes before restarting.
4. The unit is for off-grid use only. Do not connect its AC output to the grid.
5. If not used for more than 3 months, charge the unit to 40%-60% SoC and store it with the power off. For optimum battery life, discharge and charge the unit every 3 months.

Thank You!

Thank you for making BLUETTI a part of your family.

From the very beginning, BLUETTI has tried to stay true to a sustainable future through green energy storage solutions while delivering an exceptional eco-friendly experience for our homes and our world.

That's why BLUETTI makes its presence in 100+ countries and is trusted by millions of customers across the globe.



Copyright © Shenzhen PowerOak Newener Co., Ltd. All rights reserved.

No part of this document may be reproduced or transmitted in any form or by any means without the prior written consent of Shenzhen PowerOak Newener Co., Ltd.

Notice



BLUETTI's products, services, and features are subject to the agreed-upon terms and conditions during purchase. Please note that some products, services, or features described in this manual may not be available under your purchase contract. Unless otherwise specified in the contract, BLUETTI makes no representations or warranties of any kind, express or implied, with respect to the contents of this manual.

The contents of this manual are subject to change without notice. Please get the latest version from: <https://www.bluettipower.com/pages/user-guides>

If you have any questions or concerns about this manual, please contact BLUETTI support for further assistance.

Symbol Conventions

This manual uses the following symbols to highlight important information:

Symbol	Category	Description
	Danger / Warning / Attention	It indicates a hazardous situation which, if not avoided, could result in death or serious injury.
	Notice	It indicates a potentially hazardous situation which, if not avoided, could cause substantial damage to property and the environment.

Contents

1	Safety Instructions	05
2	Packing List	09
3	Product Introduction	12
4	Product Overview	12
5	Power ON / OFF	13
6	LED Screen	14
7	Charging	16
8	Discharging	19
9	Settings	20
10	AC240 + B210 Expansion Connection	24
11	Parallel Operation	25
12	BLUETTI App	26
13	Specifications	26
14	Button Operation Instructions	28
15	Troubleshooting	29
	Appx. 1 Estimating Operation Time	30
	Appx. 2 FAQ	31
	Appx. 3 FCC Statement	32
	Appx. 4 IC Caution	33
	Appx. 5 Consignes de sécurité	34

1. Safety Instructions

Read this manual for instructions on the proper use and safety information for the product. The safety instructions provided herein are for illustrative purposes that include but are not limited to those listed in this manual. Actual operation shall comply with all applicable safety standards. If you have any questions, feel free to contact BLUETTI support or your local BLUETTI dealers.

1.1 Statement

To ensure a safe operation, it's crucial to observe and adhere to the following conditions:

- Always operate or store the product in the conditions specified in this manual.
- The installation and ambient conditions must comply with the requirements in the relevant international, national, or regional standards.
- Avoid unauthorized disassembly, component replacement, or modification of software codes.

⚠ BLUETTI shall not be liable for damages resulting from the following circumstances:

- Damage resulting from force majeure events such as earthquakes, fires, storms, floods, or mudslides.
- Damage caused by the customer's own transportation.
- Damage resulting from inadequate storage conditions as specified in the manual.
- Hardware or data damage caused by customer negligence, improper operation, or intentional actions.
- System damage caused by third parties or customers, including but not limited to improper handling and installation not in accordance with the instructions in this manual.
- The product doesn't fulfill power supply needs for power-reliant equipment in critical sectors like atomic energy, aviation, medical, and other domains where safety is paramount. BLUETTI assumes no liability for incidents involving personal safety, fire, equipment malfunction, or any adverse aftermath resulting from using this product with such equipment.
- Damage caused by adjustments, changes, or removal of labels in violation of this manual.
- This product is not intended for use with devices that require a high-performance Uninterruptible Power Supply (UPS), including but not limited to data servers, workstations, medical equipment, and other similar devices. BLUETTI shall not be liable for any data loss, equipment damage, or personal injury resulting from the violation of this requirement.

1.2 General Requirements

INSTRUCTIONS PERTAINING TO RISK OF FIRE, ELECTRIC SHOCK, OR INJURY TO PERSONS
IMPORTANT SAFETY INSTRUCTIONS

WARNING:

When using this product, basic precautions should always be followed, including the following:

- Read all the instructions before using the product.
- To reduce the risk of injury, close supervision is necessary when the product is used near children.
- Do not put fingers or hands into the product. And do not insert foreign objects into any ports of the product.
- Use of an attachment not recommended or sold by the manufacturer may result in a risk of fire, electric shock, or injury to persons.
- To reduce the risk of damage to the electric plug and cord, pull the plug rather than the cord when disconnecting the product.
- Do not use a battery pack or appliance that is damaged or modified, as they may exhibit unpredictable behavior resulting in fire, explosion, or personal injury.
- Do not operate the product with a damaged cord or plug, or a damaged output cable.
- Do not attempt to replace the internal battery or any other component of the product by anyone other than authorized personnel. There are no end-user serviceable components. Do not disassemble the product, take it to a qualified service person when service or repair is required. Incorrect reassembly may result in a risk of fire or electric shock.
- To reduce the risk of electric shock, unplug the product from the outlet before attempting any instructed servicing.
- **WARNING - RISK OF EXPLOSIVE GASES.** To reduce the risk of battery explosion, follow these instructions and those published by the battery manufacturer and manufacturer of any equipment you intend to use in the vicinity of the battery. Review cautionary markings on these products and engines.
- **PERSONAL PRECAUTIONS**
 - a. Wear complete eye protection and clothing protection. Avoid touching eyes while working near the battery.
 - b. Never smoke or allow a spark or flame in the vicinity of the battery or engine.
 - c. Be extra cautious to reduce the risk of dropping a metal tool onto the battery. It might spark or short-circuit the battery or other electrical parts which may cause an explosion.
- When charging the internal battery, work in a well ventilated area and do not restrict ventilation in any way.
- Under abusive conditions, liquid may be ejected from the battery; avoid contact. If contact accidentally occurs, flush with water. If liquid contacts eyes, additionally seek medical help. Liquid ejected from the battery may cause irritation or burns.
- Do not expose the product to fire or excessive temperature. Exposure to fire or temperature above 80°C (176°F) may cause an explosion.

- Have servicing performed by a qualified repair person using only identical replacement parts. This will ensure that safety is maintained.
- **WARNING:** Avoid contact with seawater, which may cause corrosion of metal parts.
- Do not stack anything on top of the product while in storage or while in use. Do not move the product while operating as vibrations and sudden impacts may lead to poor connections to the hardware inside.
- In case of fire, use only a dry powder fire extinguisher appropriate for the product.
- **WARNING - RISK OF ELECTRIC SHOCK.** Never use the product to supply power tools to cut or access live parts or live wirings, or materials that may contain live parts or live wirings inside, such as building walls, etc.

1.3 Grounding Instructions

This product must be grounded when connected to the grid. If it should malfunction or break down, grounding provides a path of least resistance for electric current to reduce the risk of electric shock. This product is equipped with a cord having an equipment-grounding conductor and a grounding plug. The plug must be plugged into an outlet that is properly installed and grounded in accordance with all local codes and ordinances.

WARNING - Improper connection of the equipment-grounding conductor can result in a risk of electric shock. Check with a qualified electrician if you are in doubt as to whether the product is properly grounded. Do not modify the plug provided with the product - if it does not fit the outlet, have a proper outlet installed by a qualified electrician.

1.4 Handling Requirements

During transportation or storage, take care to avoid dropping, violently impacting, or tilting the product as it may result in internal damage. If necessary, use mechanical assistance such as carts or adjustable height workbenches to ensure safe handling.

Recommended number of people based on the weight of product

Weight	Number of people
<18kg (39.7lbs)	1
18kg~32kg (39.7lbs~70.5lbs)	2
32kg~55kg (70.5lbs~121.3lbs)	3
>55kg (121.3lbs)	4 or a cart

1.5 Storage Instructions

- When the SoC drops to 5%, please charge the product immediately.
 - Before storing the product, charge it to 40% to 60% SoC to keep it in optimal condition.
- In addition, power off the unit and disconnect all electrical connections from it.

- Store the product in a cool and dry place, keeping it away from flammable or combustible materials and gases.
- The product can be safely stored within a temperature range of -20°C to 45°C (-4°F to 113°F). However, if the storage duration exceeds one month, it's recommended to maintain an ideal storage temperature of around 30°C (86°F).
- Fully cycle the product every 3 months to maintain the battery's health. It's NOT recommended to store the unit for extended periods of time, as it may affect its performance and overall lifespan.

If the SoC drops to 0 (during storage or upon startup), take the following actions to safely restart the product:

- Shut down immediately.
- Charge within 48 hours.
- Keep it at an ambient temperature of 5°C to 35°C (41°F to 95°F) for 6 hours before charging. It's recommended to charge the product via an AC source. If charging via solar energy, ensure that your solar system provides an output of more than 100W.

 The symbol displayed is intended to remind you to read the instructions in the literature accompanying the product before operation and maintenance.







- Connect the product to a socket-outlet that has an earthing connection using the power cord provided.
- The socket-outlet should be installed near the product and easily accessible for safety purposes.
- Never dispose of a battery by throwing it into fire or a hot oven, or by mechanically crushing or cutting it, as these may cause it to explode.
- Avoid leaving batteries in extremely high-temperature environments, as this can result in an explosion or the leakage of flammable liquid or gas.
- The battery subjected to extremely low air pressure may result in an explosion or the leakage of flammable liquid or gas.
- Attention should be drawn to the environmental aspects of battery disposal.
- Please refer to the information on the exterior bottom enclosure for electrical and safety information before installing or operating the apparatus.

SAVE THESE INSTRUCTIONS

 **BLUETTI shall not be liable for any equipment damage caused by the violation of the above instructions.**

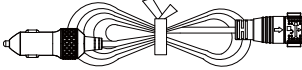
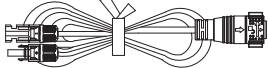

2. Packing List

Standard Accessories

Item	Picture	Qty.
Portable Power Station		1
AC Charging Cable		1
Car Charging Cable		1
Solar Charging Cable		1
Grounding Screw (M5 x10)		1
Product Documentation		1
Warranty Card		1

Optional Accessories

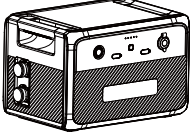
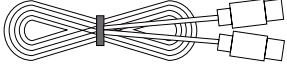
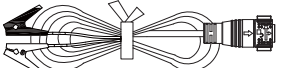
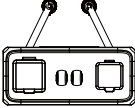
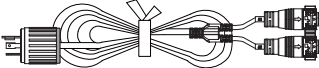
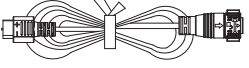
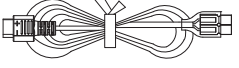
(Available on the official BLUETTI website: <https://www.bluettipower.com>)

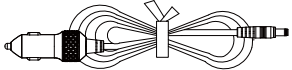
Item	Picture
B210 Expansion Battery	
USB-C to USB-C Cable (output)	
Lead-acid Battery Charging Cable (Charge the AC240 via a lead-acid battery)	
P480A Parallel Box AC Parallel Charging Cable (The appearance of the cable is subject to the cable received)	 
RV Power Cable (For RV's 12V devices)	 
PV Voltage Regulator (Convert high solar panel voltage to a suitable level for battery charging)	
12V Power Cable (For 12V devices with DC5521 port, such as routers, cameras, etc.)	

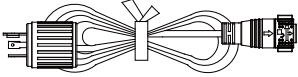
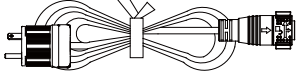
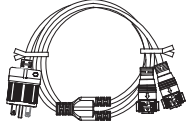
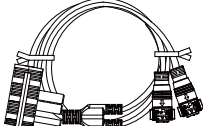
Item	Picture
L14-30 AC Charging Cable	
TT-30 AC Charging Cable	
TT-30 30A AC Parallel Charging Cable (The appearance of the cable is subject to the cable received)	
N14-50P 50A AC Parallel Charging Cable (The appearance of the cable is subject to the cable received)	

3. Product Introduction

Meet the BLUETTI AC240 Power Station, an exceptional energy solution for travel enthusiasts who demand the best. With a massive 2,400W output, it can power everything from small electronics to large RV appliances. Plus, its IP65-rated water and dust resistance makes it durable enough to withstand even the harshest weather conditions.

Not only that, but the AC240 also boasts an impressive battery capacity that ranges from 1,536Wh to a staggering 10,136Wh with four B210 expansion batteries. And if you need even more power, you can simply connect another AC240 for uninterrupted power for days on end.

Managing the AC240 is a breeze thanks to the BLUETTI App, which lets you control the unit's various functions and settings with ease. With features like ECO Mode and UPS Mode, you can optimize your power consumption and protect your device at all times. Whether you're camping or on a road trip, the AC240 provides a reliable and easy-to-use energy solution for your on-the-go lifestyle.

⚠ Danger:

Do not connect the AC output of AC240 to the grid.

4. Product Overview

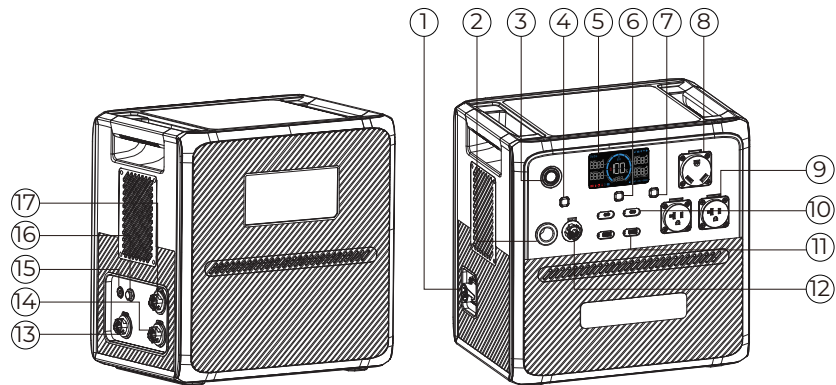

- | | | |
|--------------------------|--------------------------|----------------------|
| ① Battery Expansion Port | ⑦ AC Output Power Button | ⑬ DC Input |
| ② Cigarette Lighter Port | ⑧ NEMA TT-30 Port | ⑭ AC Input |
| ③ Power Button | ⑨ AC Output | ⑮ Grounding Terminal |
| ④ DC Output Power Button | ⑩ USB-C Port | ⑯ Bleed Valve |
| ⑤ LED Screen | ⑪ USB-A Port | ⑰ Parallel Port |
| ⑥ USB Power Button | ⑫ RV Port | |

5. Power ON / OFF

Attention:

Please place the unit on the platform firmly and stably.

- Power ON: Press the power button once, and the button lights up indicating that the AC240 is now on standby.
- Power OFF: Press and hold the power button for 2 seconds to turn off the unit.
- AC ON / OFF: When the AC240 is on, press the AC power button to turn it on / off.
- USB ON / OFF: When the AC240 is on, press the USB power button to turn it on / off.
- DC ON / OFF: When the AC240 is on, press the DC power button to turn it on / off.
- Restart: Power off the AC240 first, then press the power button to restart.
- If you do not perform any operation in 1 minute, the screen will turn off automatically.

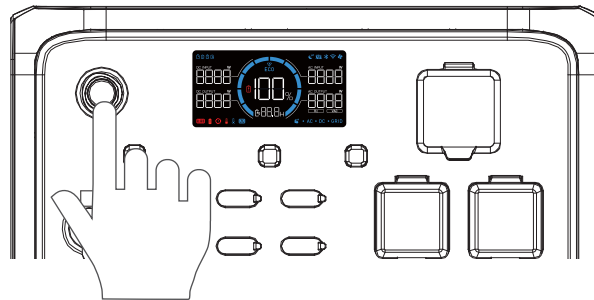





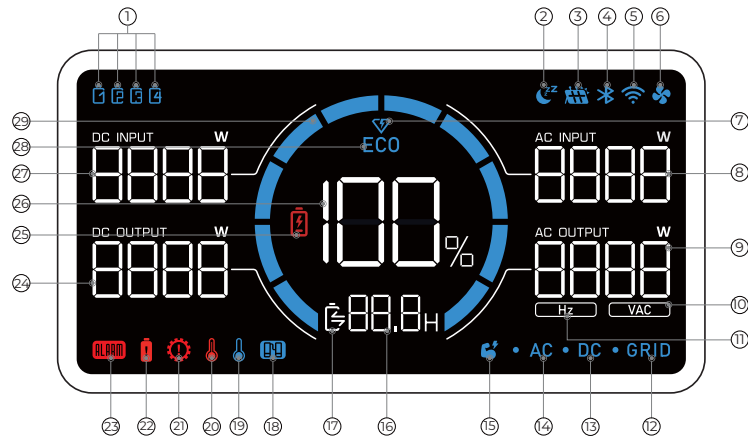

























6. LED Screen

The AC240 features an informative LED screen that offers easy access to all the essential information about the unit's status and performance. When you power on the unit, the LED screen lights up, and when you power off the unit, the screen turns off as well.



- | | | |
|------------------------|-------------------------------------|-------------------------------|
| ① Expansion Battery | ⑫ Grid Connection | ⑫ Overcurrent Alert |
| ② Silent Charging | ⑬ DC Output | ⑫ Fault Alert |
| ③ DC Input | ⑭ AC Output | ⑫ DC Output Power |
| ④ Bluetooth Connection | ⑮ Power Lifting Mode | ⑫ Low Battery Alert |
| ⑤ WiFi Connection | ⑯ Charge / Discharge Remaining Time | ⑫ Battery Capacity (SoC) |
| ⑥ Fan Status | ⑰ Charge / Discharge Status | ⑫ DC Input Power |
| ⑦ Turbo Charging | ⑱ Parallel Connection | ⑫ ECO Mode |
| ⑧ AC Input Power | ⑲ Low Temperature Alert | ⑫ Charge / Discharge Progress |
| ⑨ AC Output Power | ⑳ High Temperature Alert | |
| ⑩ AC Output Voltage | ㉑ Overload Alert | |
| ⑪ AC Output Frequency | | |

LCD Instructions	
Startup	LCD lights up
Shutdown	LCD lights off
Each icon represents an attached expansion battery. The AC240 can display up to 4 battery icons.	
The AC240 is charging in Silent Charging Mode.	
The AC240 is charging from solar panels.	
The AC240 connects to BLUETTI app via Bluetooth.	
The AC240 connects to BLUETTI app via WiFi.	
When it lights up, the fan is activated and working properly. If it flashes, there may be a problem with the fan.	
The AC240 is charging in Turbo Charging Mode.	
The real-time AC charging power.	
The real-time total AC output power.	
The real-time AC output voltage.	
The real-time AC output frequency.	
The AC240 is charging from the home grid.	
The DC output is turned on.	
The AC output is turned on.	
The AC240 is operating in Power Lifting Mode.	
The remaining time of charging or discharging.	
 : Charging  : Discharging	
The AC240 is operating in parallel mode with another AC240 unit.	
The temperature inside the unit is lower than -20°C (-4°F).	
The temperature inside the unit is higher than 70°C (158°F).	
The AC240 is overloaded.	
The AC240 is drawing too much current, which can cause damage to the unit or any connected devices.	
There's an issue with the AC240, which may require troubleshooting or repair.	
The real-time DC output power.	
The SoC drops below 5%.	
The remaining battery capacity.	
The real-time DC input power.	
The ECO Mode is activated to save power.	
The bar increases during charging and decreases during discharging.	

7. Charging

AC240 supports five charging methods: AC, solar, car, generator, and lead-acid battery.

⚠ Attention:

- Double-check that all cables are firmly plugged in.
- Avoid getting the plug and socket wet to prevent any potential damage.

7.1 AC Charging

Plug the AC240 into a standard wall outlet and start charging. Once it's fully charged, the AC240 automatically stops charging to prevent overcharging. For a fast charge, you can enable Turbo Charging in the BLUETTI App, which allows for an 80% capacity in just 45 minutes at an ambient temperature of 25°C (77°F).

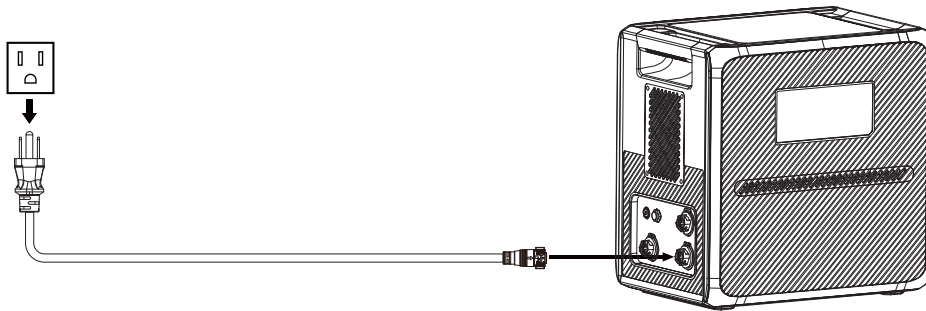

7.2 Solar Charging

Connect the solar panels (in series or parallel) to AC240 via the solar charging cable. When receiving a continuous input of 1200W, the AC240 can be charged up to 80% in about 1.3 hours. However, please be aware that the charging time may vary based on weather conditions, sunlight intensity, panel orientation, and other variables.

Note:

- Make sure your solar panels meet the following requirements:
Voc: 11V-60V Current: 21A Max. Power: 1200W Max.
- Non-waterproof solar panels will lose efficiency if they get exposed in the rain for a long time.

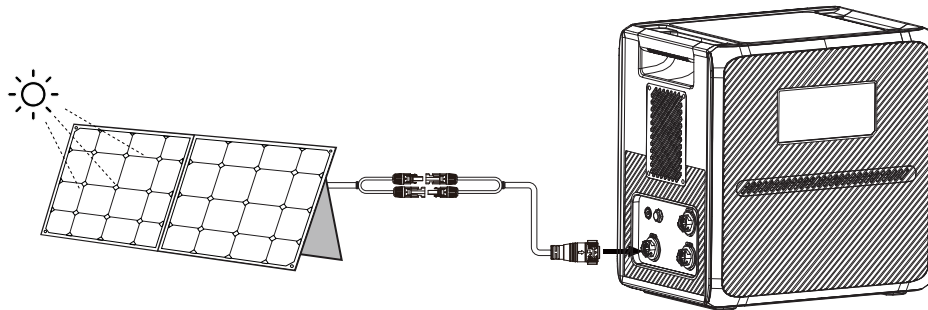

⚠ Attention:

For solar panels with an open circuit voltage between 60V and 145V, you can still use them to charge the AC240. Simply connect the solar panels to the AC240 via the PV Voltage Regulator, and you can enjoy seamless and hassle-free solar charging.

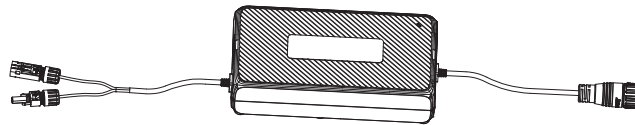

7.3 Car Charging

Connect AC240 to the vehicle's 12V / 24V cigarette lighter port via the car charging cable. The AC240 automatically stops charging once it's fully charged.

Note: Make sure your vehicle meets the following conditions for charging:

- The vehicle is capable of supplying power with a maximum current of 8.2A.
- The vehicle's engine is running during the charging process.

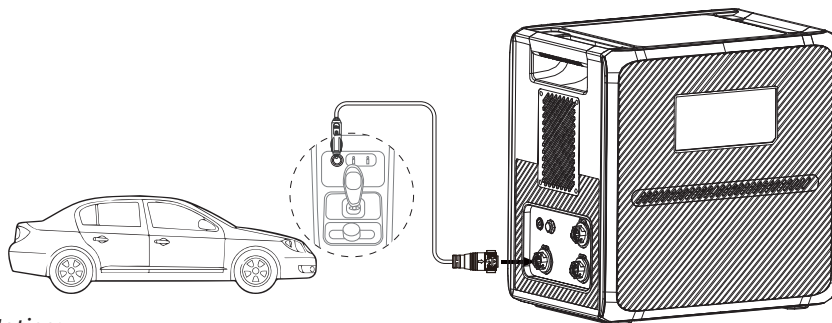

📖 Notice:

The AC240 has a low-voltage disconnect function designed to protect your vehicle's battery during charging. When the car battery is low, the unit will automatically stop charging to prevent over-discharging and potential damage to the battery.

7.4 Generator Charging

Connect the AC240 to a generator via the AC charging cable. The AC240 also automatically stops charging when it's fully charged.

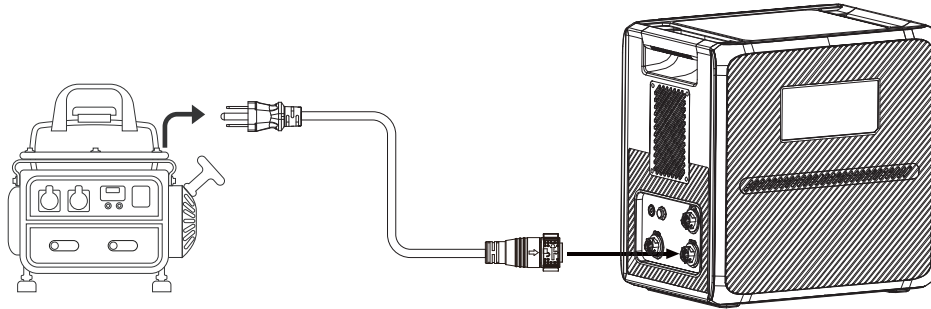

Note: Make sure your generator delivers the AC output with charging voltage and frequency that meet AC240's specifications.

If the total power demand of your connected devices exceeds the generator's output capacity, please turn on the Grid Self-adaption Mode to ensure a seamless charging experience.

7.5 Lead-acid Battery Charging

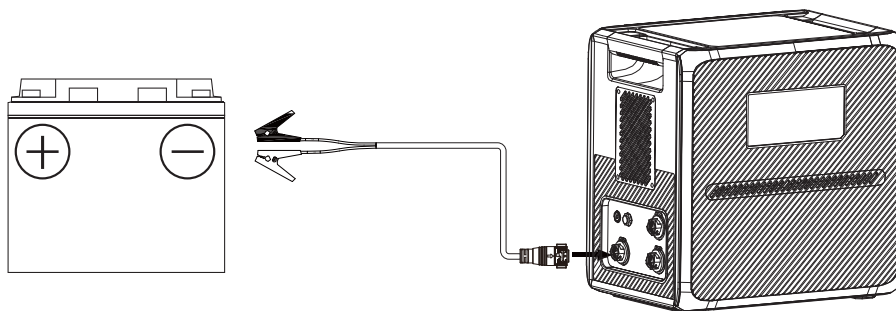

Connect the AC240 to a lead-acid battery via the lead-acid battery charging cable. The AC240 also automatically stops charging when it's fully charged.





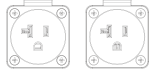

8. Discharging

Besides the cigarette lighter port, USB-A, and USB-C, AC240 also features two types of AC outlets and an RV port, expanding your charging options.



8.1 AC Discharging



Port	Picture	Description
AC Outlet x 2		For AC electrical devices.
NEMA TT-30 x 1 (AC output)		For AC electrical devices with NEMA TT-30 plug.

8.2 DC Discharging

Port	Picture	Specifications	Compatible Loads
Cigarette Lighter Port x 1		12V / 10A	12V DC appliances.
USB-A x 2		QC 3.0, 18W Max.	Mobile phones and other small loads.
USB-C x 2		PD 3.0, 100W Max.	Mobile phones, laptops, etc.
RV Port x 1		12V / 30A	RV's 12V DC appliances.

Note: To ensure optimal performance, avoid short-circuiting the ports and keep them dry during use or storage. Additionally, do not block or cover the ports while ensuring proper ventilation.

The AC240 has a maximum DC output of 430W. If the real-time output is exceeded, the AC240 turns off the USB output first to lower the total output. The screen flashes the  and , and the USB power button indicator flashes.

If the real-time output is still exceeded, the AC240 shuts off all DC output. The screen flashes the  and , the USB indicator goes off, and the DC power button blinks.

9. Settings

The AC240 offers the convenience of adjusting its settings either via the LED screen or the BLUETTI app. With the unit's LED screen, you have direct control over various settings such as Power Lifting Mode, ECO Mode, output frequency, and charging modes. Additionally, by using the BLUETTI app, you can access a user-friendly interface on your phone to conveniently monitor and control the AC240.

9.1 Setting Mode

When the screen is on and the AC output is off, press and hold the AC and DC power buttons for about 2 seconds till the output frequency flashes to enter the Setting Mode.

9.2 ECO Mode

The AC240 has two ECO modes that help you save power and extend battery life:

- AC-ECO Mode

In this mode, if the AC power output falls below a certain level for a set period of time, the AC power will automatically turn off.

Note: This mode is not available when the AC240 is charging from an AC source like a wall outlet or generator.

- DC-ECO Mode

In this mode, if the DC power output falls below a certain level for a set period of time, the DC power will automatically turn off.

Attention:



- The AC-ECO and DC-ECO modes are enabled by default to save energy, and it's recommended to keep them enabled at all times.
- Use the BLUETTI app to enable or disable AC-ECO Mode and DC-ECO Mode separately. If you use the LED screen, they'll be turned on or off at the same time.
- To avoid any interruption in charging, disable ECO Mode when charging a small device that consumes less than 60W of power.

In the Setting Mode, press the DC power button to navigate through the setting items. When the **ECO** icon flashes on the screen, press the AC power button to enable or disable the ECO Mode.

9.3 Frequency Switching

The current output frequency (50Hz / 60Hz) is displayed in the lower right corner of the screen. In the Setting Mode, press the DC power button to navigate until the output frequency appears on the screen. Then, press the AC power button to switch the frequency options based on your requirements. Remember to turn off the AC output before setting it.

9.4 WiFi & Bluetooth Connection

To connect the AC240 to the BLUEETTI app, turn on the WiFi or Bluetooth first. In the Setting Mode, press the DC power button to navigate through the setting items. When the  icon flashes on the screen, press the AC power button to turn Bluetooth on. Similarly, when the  icon flashes on the screen, press the AC power button to toggle WiFi on.

Note: Bluetooth and WIFI on by default



9.5 Power Lifting Mode



The Power Lifting Mode is specifically designed to handle resistive loads up to 3,600W, including electric blankets, kettles, hairdryers, and other heating devices. To enable it, access the Setting Mode, navigate with the DC power button until the  appears, and press the AC power button to enable the mode.

Note: The Power Lifting Mode is not enabled by default and is only suitable for resistive loads with a power rating between 2,400W-3,600W.

Although the AC240 can handle higher power demands, its actual operating power remains at 2,400W. Also, the mode is not available when the AC240 is working with another AC240 unit in parallel.

9.6 AC Charging Mode

The AC240 supports 3 AC charging modes - Standard, Turbo, and Silent to fit your specific needs. In the Setting Mode, press the DC power button to navigate through the setting items until both the  and  start simultaneously flashing on the screen. Then, press the AC power button to choose the charging mode. Please refer to the table below for useful instructions.

Mode	Recharging Power			Description	Note	Icon
	AC	PV	AC+PV			
Standard	800W Max.	800W Max.	800W Max.	Fully charged in about 3 hours	More friendly to AC240's battery.	None
Turbo	2200W Max.	1200W Max.	2200W Max.	80% charge in 45 minutes	Comes in handy when recharging time is a priority.	
Silent	800W Max.	800W Max.	800W Max.	Low operation noise less than 45dB	Offers a quiet, low-power operation for long battery life.	

9.7 UPS Mode

With the UPS mode enabled, the AC240 can provide uninterrupted power to your essential appliances during a power outage. And there are four different modes available through the BLUETTI app, allowing you to choose the best option for your needs.

- Standard UPS Mode

In this mode, the AC240 and its expansion batteries (if any) are always charged using available solar or grid power, ensuring that they are ready to provide backup power in case of a grid failure. When the grid fails, the AC240 units seamlessly take over to keep your devices running without any interruption.

Note: This mode is only available when two AC240 units are connected in parallel.

- Time Control UPS Mode

This mode allows you to program the AC240 to charge during off-peak hours when electricity is cheaper. Then, during peak hours when electricity is more expensive, the AC240 seamlessly switches over to power your devices, helping you to save money on your electricity bills.

- PV Priority UPS Mode

In this mode, the AC240 is mainly charged by solar energy to save power. You can also set a specific State of Charge (SoC) threshold. AC240 charges from the grid until reaching the designated SoC, and then seamlessly switches to solar charging for the remaining capacity.

- Customized UPS Mode

Tailor your UPS settings to match your unique needs in this mode. Create personalized schedules for charging and discharging, set battery SoC limits, and even control the grid charging switch and scheduled charging switch according to your diverse requirements.

9.8 Grid Self-adaption Mode

If you are charging the AC240 using a generator or unstable grid voltage, and the total power demand of your connected devices exceeds the AC240's input power, it is recommended that you enable the Grid Self-adaption Mode through the BLUETTI app to ensure a stable, safe charging experience for both the AC240 and your devices.

9.9 Max. Grid Input Current

The Max. Grid Input Current is set to 15A by default. If the grid current doesn't match this setting, adjust the setting in the BLUETTI app.

Attention:

A single AC240 unit allows a maximum grid input current of up to 20A.

If you need to increase the setting beyond the default 15A, please contact BLUETTI and request a password to make the necessary adjustments.

9.10 Exit Setting Mode

To save your AC240 settings and exit the Setting Mode, press and hold down both the DC and AC power buttons at the same time.

Note: If you do not perform any operation in 1 minute, the AC240 will automatically exit the Setting Mode, and no changes will be saved.

10. AC240 + B210 Expansion Connection

The AC240 unit supports up to 4 B210 expansion batteries, providing a total capacity of up to 10,136Wh. Follow these steps to connect the two units:

1. Make sure both the AC240 and B210 are turned off.
2. Connect them using the battery expansion cable.
3. Power the AC240 on and the B210 turns on automatically. The  displays on the AC240's screen.

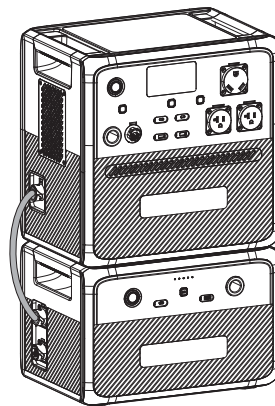

If you want to add more B210 units, please set up the system as shown below.

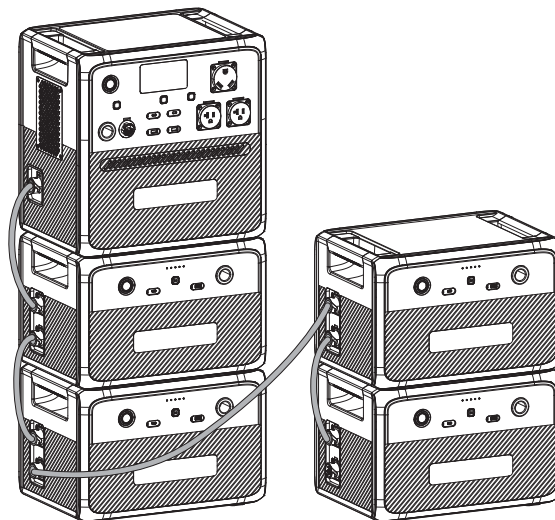

Attention:

The AC240 connects to the upper battery expansion port of B210.

11. Parallel Operation

To increase your power output, you can connect two AC240 units in parallel. When connected in this way, the two units can deliver up to 4,800W of power. To connect them, please follow these steps:

1. Make sure both AC240 units are turned off.
2. Connect them using the parallel box and AC parallel charging cable.
3. Power on one AC240 unit, and the other unit will automatically turn on.

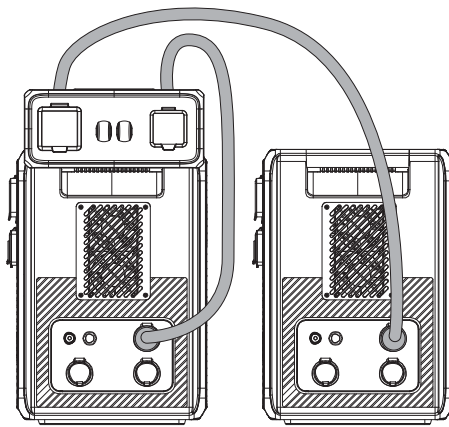

When you connect the Parallel System to a wall outlet, your device will be energized by the grid or the system's power frame, depending on its power demand. If the load demand is less than 4000W, the parallel system can tap into the grid and energize the load. However, if the load demand is between 4000W and 4800W, the grid needs to be removed to obtain a more stable output of energy to the load.

Note:

- All the settings made on one AC240 unit will be synchronized to the other unit.
- If you need to adjust the Max. Grid Input Current, please use the BLUETTI app and make the necessary changes.
- Charge the two AC240s using the Parallel Charging Cable(with parallel box in Optional Accessories) in parallel mode.
- When the charging current exceeds 15A, be sure to check that the parallel charging cable used is capable of carrying the maximum grid input current setting, otherwise overheating of the charging cable may cause a fire.

12. BLUETTI App

Scan the QR code below or search "BLUETTI" in the App Store or Google Play to download the BLUETTI app.







For more details, please refer to AC240 BLUETTI App User Manual.

13. Specifications

Model	AC240
Battery Capacity	1,536Wh (30Ah)
Cell Type	Lithium Iron Phosphate (LiFePO ₄ , LFP)
AC + DC Input Power	2,400W Max.
AC+DC Output Power	2,500W Max.
Weight	33kg / 72lbs
Dimensions (L × W × H)	419.5mm × 293.5mm × 409.5mm / 16.5in × 11.6in × 16.1in
Charging Temperature	0°C to 40°C / 32°F to 104°F
Discharging Temperature	-20°C to 40°C / -4°F to 104°F
Storage Temperature	Up to 1 month: -20°C to 45°C / -4°F to 113°F
	Up to 3 months: -20°C to 30°C / -4°F to 86°F
	Up to 12 months: -20°C to 25°C / -4°F to 77°F
Working Humidity	10% to 90%
Noise	53dB
Working Altitude	2,000m / 6,561ft











AC Output	
Power	2,400W in total
Overload Power	2500W-3000W, 2min;
	3000W-3600W, 10s;
	>3600W, 500ms
Voltage	120VAC
Current	20A
Frequency	50Hz / 60Hz
DC Output	
Cigarette Lighter Port × 1	12VDC / 10A
USB-A × 2	18W Max. (QC3.0: 5V / 3A; 9V / 2A; 12V / 1.5A)
USB-C × 2	100W Max. (PD3.0: 5 / 9 / 12 / 15 / 20V 3A; 20V / 5A, with built-in EMarker chip)
RV Port × 1	12VDC / 30A
Total DC Output Power	430W
AC Input	
Voltage	120VAC
Current	20A Max.
Frequency	50Hz / 60Hz
UPS	Switching time ≤15ms
Power	0-80% in 45 min 2,200W Max.(Pair with B210 for 2,400W Max.)
DC Input	
Interface	2-pin Aviation Socket
Power	1,200W Max.
Current	21A Max.
Voltage	11V to 60VDC
Battery Expansion Port	
Voltage	44.8V to 57.6VDC
Input Current	60A Max.
Parallel Port	
Interface	3-pin Aviation Socket + 8-pin Aviation Socket
Output Current	24A Max.



14. Button Operation Instructions

Operation	Function	Description
Press the AC power button	Turn on / off the AC output	/
Press the DC power button	Turn on / off the cigarette lighter port and RV port output	/
Press the USB power button	Turn on / off the USB output	/
Press the AC and DC power buttons simultaneously and hold for more than 2 seconds till the output frequency flashes	Enter / exit the Setting Mode	In the Setting Mode, the icons for the currently enabled functions remain lit, except for the flashing output frequency icon. If you do not perform any operation in 1 minute, the AC240 will automatically exit the Setting Mode, and no changes will be saved.
Press the DC power button in the Setting Mode	Navigate through the setting items	The flashing setting item is selected and editable. In the Setting Mode, the corresponding codes will be displayed on the left side: P01: Output Frequency P03: Charging Mode P04: Power Lifting Mode P05: ECO Mode P06: Bluetooth P07: WiFi
Press the AC power button when the setting item is flashing	Enable or disable the selected function.	/
Press and hold the DC power button in the Setting Mode	Switch the status page	You can view relevant information on the status page.  : Serial Number (SN)  : Error Code  : Fault History  : Version

15. Troubleshooting

In the Setting Mode, press and hold the DC power button to switch the status page until the  icon and the error code appear simultaneously on the screen. Please refer to the table below for helpful guidance.

Error Code	Alarm Icon	Description	Troubleshooting
E001		Inverter overload	Check if the power consumption of your devices is too high. Reduce the load if necessary.
E002		Inverter overtemperature protection, AC output off	Wait for about 10 minutes until the unit cools down, then turn on the AC output again.
E003		Inverter short circuit	1. Check if the power consumption of your devices is too high. 2. Check if any of your electrical devices are causing a short circuit.
E033		PV overvoltage	Make sure the PV input voltage is within the range of 11V-60VDC.
E039		PV overtemperature	Wait for about 10 minutes until the unit cools down, then re-enable the PV input.
E065		DC output short circuit	1. Check if the power consumption of your devices is too high. 2. Check if any of your electrical devices are causing a short circuit.
E067		DC output overcurrent	Check if the power consumption of your devices is too high. Reduce the load if necessary.
E068		DC output overtemperature	Wait for about 10 minutes until the unit cools down, then restart your devices.
E085		Charging temperature too high	Wait for the unit to cool down before charging.
E086		Charging temperature too low	Make sure the unit is placed in an ambient temperature of 0°C to 40°C (32°F to 104°F).
E087		Discharging temperature too high	Wait for the unit to cool down before discharging.

E088		Discharging temperature too low	Make sure the unit is placed in an ambient temperature of -20°C to 40°C (-4°F to 104°F).
E115		Grid overfrequency	Check if the grid frequency is too high. Contact your local power provider if necessary.
E116		Grid underfrequency	Check if the grid frequency is too low. Contact your local power provider if necessary.
Others	/	/	Please contact BLUETTI support for assistance.

Appx. 1 Estimating Operation Time

To estimate the operation time of the AC240, consider the load you're applying:

Operation time = Battery Capacity (Wh) x DoD x η ÷ (Load Power + AC240 Self-consumption)

Note: DoD refers to the depth of discharge. AC240 works at 95% DoD for longer battery life.

η is the conversion efficiency of the inverter, typically over 85% for AC240.

The self-consumption of AC240 is approximately 9W.

Please keep in mind that the estimated operation time provided is for reference purposes and may vary based on actual usage conditions. Factors such as low temperature and excessive loads can significantly affect the battery capacity, leading to a reduction in

Appx. 2 FAQ

Q1: How do I know whether my devices will work well with this product?

A: Please evaluate the total constant load of your devices. If it doesn't exceed the Max. output power of AC240 (2,400W), you can use this power station to run your devices.

Note: Some devices with built-in motors or compressors may start at 2-4 times the rated power, which can easily overload the AC240.

Q2: Can I use third-party solar panels to charge this product?

A: Yes, you can. However, make sure your solar panels have an open circuit voltage of 11V-60V and are equipped with MC4 connectors. It's also important not to mix different types of solar panels.

Q3: Can it charge and discharge at the same time?

A: Yes. It supports pass-through charging. The AC240 comes with the premium LiFePO₄ battery and proprietary Battery Management System to ensure that it can charge and discharge at the same time.

Q4: Why is the charging power often too low?

A: AC240 has a built-in intelligent BMS that automatically adjusts the charging power in response to the battery temperature and SoC, thus protecting the battery and extending its service life.

Appx. 3 FCC Statement

This device complies with part 15 of the FCC Rules. Operation is subject to the following two conditions:

- (1) This device may not cause harmful interference.
- (2) This device must accept any interference received, including interference that may cause undesired operation.

This equipment has been tested and found to comply with the limits for a Class B digital device, pursuant to part 15 of the FCC Rules. These limits are designed to provide reasonable protection against harmful interference in a residential installation. This equipment generates, uses and can radiate radio frequency energy and, if not installed and used in accordance with the instructions, may cause harmful interference to radio communications. However, there is no guarantee that interference will not occur in a particular installation. If this equipment does cause harmful interference to radio or television reception, which can be determined by turning the equipment off and on, the user is encouraged to try to correct the interference by one or more of the following measures:

- Reorient or relocate the receiving antenna.
- Increase the separation between the equipment and receiver.
- Connect the equipment into an outlet on a circuit different from that to which the receiver is connected.
- Consult the dealer or an experienced radio / TV technician for help.

FCC Caution: Any changes or modifications not expressly approved by the party responsible for compliance could void the user's authority to operate this equipment. To maintain compliance with FCC's RF Exposure guidelines, this equipment should be installed and operated with minimum distance between 20cm the radiator your body. Use only the supplied antenna.

Appx. 4 IC Caution

This device contains licence-exempt transmitter(s) / receiver(s) that comply with Innovation, Science and Economic Development Canada's licence-exempt RSS(s). Operation is subject to the following two conditions:

- (1) This device may not cause interference.
- (2) This device must accept any interference, including interference that may cause undesired operation of the device.

RF exposure statement: The equipment complies with IC Radiation exposure limits set forth for uncontrolled environments. This equipment should be installed and operated with a minimum distance of 20cm between the radiator and your body.

L'émetteur/récepteur exempt de licence contenu dans le présent appareil est conforme aux CNR d'Innovation, Sciences et Développement économique Canada applicables aux appareils radio exempts de licence. L'exploitation est autorisée aux deux conditions suivantes:

- (1) L' appareil ne doit pas produire de brouillage;
- (2) L' appareil doit accepter tout brouillage radioélectrique subi, même si le brouillage est susceptible d' en compromettre le fonctionnement.

Déclaration d'exposition aux radiofréquences IC:(Con bluetooth)

Cet équipement est conforme aux limites d'exposition IC établies pour un environnement non contrôlé. Cet équipement doit être installé et utilisé avec une distance minimale de 20 cm entre le radiateur et le corps.

CAN ICES-3 (B)/NMB-3(B) (Canada)

This Class B digital apparatus complies with Canadian ICES-003.

Appx. 5 Consignes de sécurité

Lisez ce manuel pour savoir comment utiliser correctement le produit et connaître les consignes de sécurité correspondantes. Les exigences en matière de sécurité sont fournies à titre d'exemple et comprennent, sans s'y limiter, les exigences énumérées dans le présent manuel. Le fonctionnement réel doit être conforme à toutes les normes de sécurité applicables. Si vous avez des questions, n'hésitez pas à contacter l'équipe de support BLUETTI ou votre revendeur local.

1) Déclaration

Pour garantir un fonctionnement sûr, il est essentiel de respecter les conditions suivantes :

- Utilisez ou stockez toujours le produit dans les conditions spécifiées dans ce manuel.
- Évitez tout démontage, tout remplacement des composants ou toute modification des codes logiciels non autorisés.

 *BLUETTI n'est pas responsable des dommages résultant des circonstances suivantes :*

- Les cas de force majeure tels que les tremblements de terre, les incendies, les tempêtes, les inondations ou les coulées de boue.
- Les dommages causés par le transport du client.
- Les dommages résultant de conditions de stockage inadéquates telles que spécifiées dans le manuel.
- Les dommages causés par la négligence du client, une mauvaise utilisation ou des actions intentionnelles.
- Les dommages occasionnés au système ou au matériel par des tiers ou des clients, y compris, mais sans s'y limiter, une manipulation ou une installation non conforme aux consignes du présent manuel.
- L'utilisation du produit avec des appareils nécessitant une alimentation sans interruption (ASI) de haute performance, y compris, mais sans s'y limiter, les serveurs de données, les stations de travail, les équipements médicaux et d'autres appareils similaires.

2) Exigences générales

CONSIGNES RELATIVES AU RISQUE D'INCENDIE, D'ÉLECTROCUTION OU DE BLESSURE
CONSIGNES DE SÉCURITÉ IMPORTANTES

AVERTISSEMENT – Les précautions de base suivantes doivent toujours être prises lorsque vous utilisez ce produit :

- a. Lisez l'ensemble des consignes avant toute utilisation du produit.
- b. Pour réduire le risque de blessure, une surveillance étroite est nécessaire lorsque vous utilisez le produit à proximité d'enfants.
- c. Ne placez pas vos doigts ou vos mains à l'intérieur du produit. N'insérez pas de corps étrangers dans les ports du produit.

- d. L'utilisation d'un accessoire non recommandé ou vendu par le fabricant peut entraîner un risque d'incendie, d'électrocution ou de blessure.
- e. Pour réduire le risque d'endommagement de la fiche et du câble électriques, tirez au niveau de la fiche plutôt que sur le cordon lors du débranchement.
- f. N'utilisez pas un bloc-batterie ou un appareil endommagé ou modifié, car ils peuvent présenter un comportement imprévisible entraînant un risque d'incendie, d'explosion ou de blessure.
- g. N'utilisez pas le produit avec un câble ou une fiche endommagés, ou un câble de sortie endommagé.
- h. SEUL du personnel autorisé peut remplacer la batterie interne ou tout autre composant du produit. Aucun composant ne peut être réparé par l'utilisateur final. Ne démontez pas le produit par vous-même, adressez-vous à un technicien qualifié pour tout service de réparation ou d'entretien. Un réassemblage incorrect peut entraîner un risque d'incendie ou d'électrocution.
- i. Pour réduire le risque d'électrocution, débranchez le produit de la prise avant de procéder à toute opération d'entretien prévue dans les consignes.
- j. AVERTISSEMENT – RISQUE DE GAZ EXPLOSIFS. Pour réduire le risque d'explosion de la batterie, suivez ces consignes ainsi que les consignes du fabricant de la batterie et du fabricant de tout équipement que vous avez l'intention d'utiliser à proximité de la batterie. Examinez les mises en garde apposées sur ces produits et sur les moteurs.
- k. PRÉCAUTIONS PERSONNELLES
- 1) Protégez-vous complètement et portez des vêtements et des lunettes de protection. Évitez tout contact avec les yeux lorsque vous travaillez à proximité de la batterie.
- 2) Ne fumez JAMAIS et ne produisez JAMAIS d'étincelles ou de flammes à proximité de la batterie ou du moteur.
- 3) Travaillez avec une extrême prudence et évitez toute chute d'outil métallique sur la batterie. Cela pourrait provoquer une étincelle ou un court-circuit de la batterie ou d'autres pièces électriques, entraînant par conséquent un risque d'explosion.
- l. Lorsque vous chargez la batterie interne, travaillez dans un endroit bien ventilé et ne limitez en rien la ventilation.
- m. Dans des conditions abusives, du liquide peut être éjecté de la batterie, évitez tout contact. En cas de contact accidentel, rincez à l'eau. Si le liquide entre en contact avec les yeux, consultez immédiatement un médecin. Le liquide éjecté de la batterie peut provoquer des irritations ou des brûlures.
- n. N'exposez pas le produit au feu ou à une température excessive. L'exposition au feu ou à une température supérieure à 130 °C peut entraîner un risque d'explosion.
- o. Confiez l'entretien du produit à un réparateur qualifié qui utilisera uniquement des pièces de rechange identiques, de manière à assurer une sécurité continue.

- p. N'utilisez PAS le produit dans des conditions humides. Si le produit est mouillé, veuillez le sécher soigneusement avant de l'utiliser.
- q. Veuillez assurer une ventilation adéquate pendant l'utilisation et ne pas obstruer les ouvertures du ventilateur. Une ventilation inadéquate peut causer des dommages permanents sur le produit.
- r. NE placez RIEN sur la surface supérieure du produit lors de l'utilisation ou du stockage. NE déplacez PAS le produit pendant son fonctionnement, car les vibrations et les chocs soudains peuvent conduire à de mauvaises connexions avec le matériel à l'intérieur.
- s. En cas d'incendie, seul un extincteur à base de poudre sèche est adapté au produit.
- t. AVERTISSEMENT – RISQUE DE CHOC ÉLECTRIQUE. N'utilisez jamais le produit pour alimenter des outils électriques dans le but de couper ou d'accéder à des pièces ou des câbles sous tension, ou à des matériaux pouvant contenir des pièces ou des câbles sous tension, tels que les murs d'un bâtiment, etc.
- u. Pour éviter tout contact avec des liquides, n'utilisez pas ce produit par temps de pluie ou dans des environnements à forte humidité.

3) Consignes de mise à la terre

Ce produit doit être mis à la terre. En cas de dysfonctionnement ou de panne, la mise à la terre fournit un chemin de moindre résistance pour le courant électrique afin de réduire le risque d'électrocution. Ce produit est équipé d'un câble muni d'un conducteur de mise à la terre et d'une fiche de mise à la terre. La fiche doit être branchée dans une prise correctement installée et mise à la terre conformément à tous les codes et règlements locaux.

AVERTISSEMENT

Une mauvaise connexion du conducteur de mise à la terre de l'équipement peut entraîner un risque d'électrocution. Vérifiez auprès d'un électricien qualifié en cas de doutes quant à la mise à la terre de l'appareil. Ne modifiez pas la fiche fournie avec le produit. Si elle n'est pas adaptée à la prise, faites installer une prise adéquate par un électricien qualifié.

4) Consignes de stockage

- a. Lorsque le SoC atteint 5 %, veuillez charger le produit immédiatement.
- b. Avant de stocker le produit, veuillez le charger de manière à ce que le SoC soit compris entre 40 % et 60 % afin de préserver l'état optimal du produit. De plus, éteignez le produit et débranchez toutes les raccordements électriques de celui-ci.
- c. Stockez le produit dans un endroit frais et sec, à l'écart des matériaux et des gaz inflammables ou combustibles.

d. Le produit peut être stocké en toute sécurité à une température comprise entre -20 °C et 40 °C (entre -4 °F et 104 °F). Toutefois, si la durée de stockage dépasse un mois, il est recommandé de maintenir une température de stockage idéale d'environ 30 °C (86 °F). Afin de maintenir le produit en bon état, veuillez décharger et charger complètement l'appareil au moins une fois tous les 3 mois. Il n'est PAS recommandé de stocker l'appareil pendant des périodes prolongées, car cela peut altérer les performances et la durée de vie générale du produit.

Si le SoC chute à 0 (pendant le stockage ou au démarrage), prenez les mesures suivantes pour redémarrer le produit en toute sécurité :

- Mettez-le immédiatement hors tension.
- Chargez-le dans les 48 heures.
- Placez-le à une température ambiante comprise entre 5 °C et 35 °C (entre 41 °F et 95 °F) pendant 24 heures avant de le charger. Il est recommandé de charger le produit via une source CA. Si vous le chargez à l'aide de l'énergie solaire, assurez-vous que votre système solaire fournit une puissance supérieure à 100 W.

 *BLUETTI n'est pas responsable des dommages causés à l'équipement en raison du non-respect des consignes ci-dessus.*

CONSERVEZ CES CONSIGNES

  Le symbole représenté vous rappelle de lire les consignes figurant dans la documentation accompagnant le produit avant toute utilisation ou tout entretien.

- Branchez le produit sur une prise de courant avec mise à la terre à l'aide du câble d'alimentation fourni.
- La prise de courant doit être installée à proximité du produit et facilement accessible pour des raisons de sécurité.
- Concernant l'élimination, ne JAMAIS procéder aux actions suivantes pour cause de risque d'explosion : ne jamais placer une batterie au feu ou dans un four chaud et ne jamais écraser ou couper mécaniquement une batterie.
- Évitez de placer les batteries dans des environnements à très haute température, car cela peut entraîner une explosion ou une fuite de liquide ou de gaz inflammable.
- Les batteries soumises à une pression d'air extrêmement basse peuvent entraîner une explosion ou une fuite de liquide ou de gaz inflammable.
- Il convient d'attirer l'attention sur les critères environnementaux quant à l'élimination des batteries.
- Avant toute installation ou utilisation de l'appareil, veuillez vous référer aux informations figurant sur le dessous extérieur de l'appareil pour obtenir des informations sur les caractéristiques électriques et la sécurité.

For more information, please visit:

Web: <https://www.bluettipower.com>



@ BLUETTI Support
@ BLUETTI Official



@ bluetti_inc



@bluetti.inc



@bluetti_official



service@
bluettipower.com

Customer Service

Tel: **800-200-2980** (Monday to Sunday 9:00-17:00)

Email: sale@bluettipower.com (Pre-sales),

service@bluettipower.com (After-sales)

USA Company

Company: BLUETTI POWER INC

Add: 6185 S VALLEY VIEW BLVD STE D LAS VEGAS

NEVADA 89118 United States

FRN: 0033559824

SHENZHEN POWEROAK NEWENER CO., LTD.

Add: F19, BLD No.1, Kaidaer, Tongsha Rd No.168,
Xili Street, Nanshan, Shenzhen, China





BLUETTI



Certificate

Inspector: _____

QC: _____

Just Power On

