

FCC CERTIFICATION TEST REPORT

FOR

Applicant	:	UNION SQUARE LTD
Address	:	RM 1206, MIRROR TOWER, 61 MODYROAD, TST, KLN, HK
Equipment under Test	:	M.R. REMOTE SMOKER THERMOMETER W/ HIGH TEMP CORD
Model No.	:	41008
Trade Mark	:	/
FCC ID	:	2AYSZ-USL41008
Manufacturer	:	UNION SQUARE LTD
Address	:	RM 1206, MIRROR TOWER, 61 MODYROAD, TST, KLN, HK

Issued By: Dongguan Dongdian Testing Service Co., Ltd.

Add.: No. 17, Zongbu Road 2, SongshanLakeSci&Tech, IndustryPark, Dongguan
City, Guangdong Province, China, 523808

Tel.: +86-0769-38826678, **E-mail:** ddt@dgddt.com, <http://www.dgddt.com>

REPORT

Table of Contents

	Test report declares.....	3
1	Summary of Test Results.....	6
2	General Test Information	7
2.1.	Description of EUT	7
2.2.	Accessories of EUT.....	7
2.3.	Assistant equipment used for test.....	7
2.4.	Block diagram of EUT configuration for test.....	7
2.5.	Deviations of test standard.....	7
2.6.	Test environment conditions	8
2.7.	Test laboratory.....	8
2.8.	Measurement uncertainty.....	8
3	Equipment Used During Test.....	9
4	Duty Cycle	11
4.1.	Block diagram of test setup.....	11
4.2.	Limits	11
4.3.	Test procedure	11
4.4.	Test result.....	11
4.5.	Original test data	12
5	20 dB Bandwidth	13
5.1.	Block diagram of test setup.....	13
5.2.	Limits	13
5.3.	Test procedure	13
5.4.	Test result.....	13
5.5.	Original test data	14
6	Transmission Time.....	15
6.1.	Block diagram of test setup.....	15
6.2.	Limits	15
6.3.	Test procedure	15
6.4.	Test result.....	15
6.5.	Original test data	16
7	Radiated Emission	18
7.1.	Block diagram of test setup.....	18
7.2.	Limit.....	19
7.3.	Test procedure	21
7.4.	Test result.....	22
8	Power Line Conducted Emission.....	26

8.1.	Block diagram of test setup.....	26
8.2.	Power line conducted emission limits.....	26
8.3.	Test procedure.....	26
8.4.	Test result.....	27
9.	Antenna Requirements.....	28
9.1.	Limit.....	28
9.2.	Result.....	28

Test Report Declare

Applicant	:	UNION SQUARE LTD
Address	:	RM 1206, MIRROR TOWER, 61 MODYROAD, TST, KLN, HK
Equipment under Test	:	M.R. REMOTE SMOKER THERMOMETER W/ HIGH TEMP CORD
Model No.	:	41008
Trade mark	:	/
Manufacturer	:	UNION SQUARE LTD
Address	:	RM 1206, MIRROR TOWER, 61 MODYROAD, TST, KLN, HK

Test Standard Used:

FCC Rules and Regulations Part 15 Subpart C.

Test procedure used:

ANSI C63.10:2013

We Declare:

The equipment described above is tested by Dongguan Dongdian Testing Service Co., Ltd. and in the configuration tested the equipment complied with the standards specified above. The test results are contained in this test report and Dongguan Dongdian Testing Service Co., Ltd. is assumed of full responsibility for the accuracy and completeness of these tests.

After test and evaluation, our opinion is that the equipment provided for test compliance with the requirement of the above FCC standards.

Report No.:	DDT-R20102311-1E2		
Date of Receipt:	Nov. 09, 2020	Date of Test:	Nov. 09, 2020 ~ May 06, 2021

Prepared By:

Sam Li

Sam Li/Engineer

Approved By:

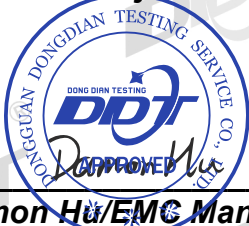

Damon Hu/EMC Manager

Note: This report applies to above tested sample only. This report shall not be reproduced in parts without written approval of Dongguan Dongdian Testing Service Co., Ltd.

Revision History

Rev.	Revisions	Issue Date	Revised By
---	Initial issue	May 06, 2021	

1 Summary of Test Results

Description of Test Item	Standard	Results
20 dB Bandwidth	FCC Part 15: 15.231(c) ANSI C63.10:2013	PASS
Transmission Time	FCC Part 15C: 15.231(e)	PASS
Radiated Emission	FCC Part 15: 15.209 FCC Part 15: 15.231(e) ANSI C63.10:2013	PASS
Power Line Conducted Emissions	FCC Part 15: 15.207 ANSI C63.10:2013	N/A
Antenna Requirement	FCC Part 15: 15.203	PASS

Note: N/A is an abbreviation for Not Applicable.

2 General Test Information

2.1. Description of EUT

EUT* Name	: M.R. REMOTE SMOKER THERMOMETER W/ HIGH TEMP CORD
Model Number	: 41008
EUT function description	: Please reference user manual of this device
Power Supply	: DC 3V (2* "AAA" Size batteries)
Operation frequency	: 433.92 MHz
Modulation	: ASK
Antenna Type	: Line Antenna, maximum PK gain: 0 dBi
Serial Number	: N/A

Note: EUT is the abbreviation of equipment under test.

2.2. Accessories of EUT

Description of Accessories	Manufacturer	Model number	Serial No.	Other
N/A	N/A	N/A	N/A	N/A

2.3. Assistant equipment used for test

Assistant equipment	Manufacturer	Model number	Serial No.	Other
N/A	N/A	N/A	N/A	N/A

2.4. Block diagram of EUT configuration for test

EUT

Tested mode, channel, information		
Mode	Channel	Frequency (MHz)
Tx mode	/	433.92

Note : New battery is used during all test

2.5. Deviations of test standard

No deviation.

2.6. Test environment conditions

During the measurement the environmental conditions were within the listed ranges:

Temperature range:	21-25 °C
Humidity range:	40-75%
Pressure range:	86-106 kPa

2.7. Test laboratory

Dongguan Dongdian Testing Service Co., Ltd.

Add.: No. 17, Zongbu Road 2, Songshan Lake Sci&Tech, Industry Park, Dongguan City,
Guangdong Province, China, 523808

Tel.: +86-0769-38826678, <http://www.dgddt.com>, Email: ddt@dgddt.com

CNAS Registration No. CNAS L6451; A2LA Certificate Number: 3870.01;

FCC Designation Number: CN1182; FCC Test Firm Registration Number: 540522

Industry Canada Site Registration Number: 10288A-1

2.8. Measurement uncertainty

Test Item	Uncertainty
Bandwidth	1.1%
Peak Output Power (Conducted) (Spectrum analyzer)	0.86 dB (10 MHz ≤ f < 3.6 GHz);
	1.38 dB (3.6 GHz ≤ f < 8 GHz)
Peak Output Power (Conducted) (Power Sensor)	0.74 dB
Power Spectral Density	0.74 dB (10 MHz ≤ f < 3.6 GHz);
	1.38 dB (3.6 GHz ≤ f < 8 GHz)
Frequencies Stability	6.7 × 10 ⁻⁸ (Antenna couple method)
	5.5 × 10 ⁻⁸ (Conducted method)
Conducted spurious emissions	0.86 dB (10 MHz ≤ f < 3.6 GHz);
	1.40 dB (3.6 GHz ≤ f < 8 GHz)
	1.66 dB (8 GHz ≤ f < 22 GHz)
Uncertainty for radio frequency (RBW < 20 kHz)	3 × 10 ⁻⁸
Temperature	0.4 °C
Humidity	2%
Uncertainty for Radiation Emission test (30 MHz - 1 GHz)	4.70 dB (Antenna Polarize: V)
	4.84 dB (Antenna Polarize: H)
Uncertainty for Radiation Emission test (1 GHz - 40 GHz)	4.10 dB (1-6 GHz)
	4.40 dB (6 GHz - 18 GHz)
	3.54 dB (18 GHz - 26 GHz)
	4.30 dB (26 GHz - 40 GHz)
Uncertainty for Power line conduction emission test	3.32 dB (150 kHz - 30 MHz)

Note: This uncertainty represents an expanded uncertainty expressed at approximately the 95% confidence level using a coverage factor of k=2.

3 Equipment Used During Test

Equipment	Manufacturer	Model No.	Serial No.	Last Cal.	Cal. Interval
RF Connected Test (Tonscend RF Measurement System 1#)					
Spectrum analyzer	R&S	FSU26	101272	Jul. 01, 2020	1 Year
Spectrum analyzer	Agilent	N9020D	MY49100362	Sep. 28, 2020	1 Year
Wideband Radio Communication tester	R&S	CMW500	117491	Jul. 01, 2020	1 Year
Vector Signal Generator	Agilent	E8267D	US49060192	Sep. 24, 2020	1 Year
Vector Signal Generator	Agilent	N5182A	MY48180737	Jul. 01, 2020	1 Year
Power Sensor	Agilent	U2021XA	MY55150010	Jul. 01, 2020	1 Year
Power Sensor	Agilent	U2021XA	MY55150011	Jul. 01, 2020	1 Year
RF Cable	Micable	C10-01-01-1	100309	Sep. 28, 2020	1 Year
Temp&Humi Programmable	ZHIXIANG	ZXGDJS-150L	ZX170110-A	Jul. 01, 2020	1 Year
Test Software	JS Tonscend	JS1120-3	Ver.2.7	N/A	N/A
RF Connected Test (Tonscend RF Measurement System 2#)					
Spectrum analyzer	R&S	FSU26	200071	Sep. 25, 2020	1 Year
Spectrum analyzer	Agilent	N9020D	MY49100362	Sep. 28, 2020	1 Year
Wideband Radio Communication tester	R&S	CMW500	117491	Jul. 01, 2020	1 Year
Vector Signal Generator	Agilent	N5182A	MY19060405	Jul. 01, 2020	1 Year
Vector Signal Generator	Agilent	N5182A	MY48180912	Jul. 01, 2020	1 Year
RF Control Unit	Tonsend	JS0806-2	DDT-ZC01449	Jul. 01, 2020	1 Year
RF Cable	Micable	C10-01-01-1	100309	Sep. 28, 2020	1 Year
Temp&Humi Programmable	ZHIXIANG	ZXGDJS-150L	ZX170110-A	Jul. 01, 2020	1 Year
Test Software	JS Tonscend	JS1120-3	Ver.2.7	N/A	N/A
Radiation 1#chamber					
EMI Test Receiver	R&S	ESU8	100316	Sep. 24, 2020	1 Year
Spectrum analyzer	Agilent	E4447A	MY50180031	Jul. 01, 2020	1 Year
Trilog Broadband Antenna	Schwarzbeck	VULB9163	9163-462	Nov. 13, 2020	1 Year
Active Loop antenna	Schwarzbeck	FMZB-1519	1519-038	Nov. 13, 2020	1 Year
Double Ridged Horn Antenna	R&S	HF907	100276	Nov. 18, 2020	1 Year
Pre-amplifier	A.H.	PAM-0118	360	Sep. 28, 2020	1 Year
RF Cable	HUBSER	CP-X2+ CP-X1	W11.03+ W12.02	Sep. 24, 2020	1 Year
RF Cable	N/A	5m+6m+1m	06270619	Sep. 30, 2020	1 Year
MI Cable	HUBSER	C10-01-01-1 M	1091629	Sep. 30, 2020	1 Year
Test software	Audix	E3	V 6.11111b	N/A	N/A
Radiation 2#chamber					
EMI Test Receiver	R&S	ESCI	101364	Sep. 28, 2020	1 Year

Spectrum analyzer	Agilent	E4447A	MY50180031	Jul. 01, 2020	1 Year
Trilog Broadband Antenna	Schwarzbeck	VULB 9163	9163-994	Nov. 13, 2020	1 Year
Active Loop antenna	Schwarzbeck	FMZB-1519	1519-038	Nov. 13, 2020	1 Year
Double Ridged Horn Antenna	Schwarzbeck	BBHA9120	02108	Jul. 11, 2020	1 Year
Pre-amplifier	TERA-MW	TRLA-0040 G35	1013 03	Sep. 28, 2020	1 Year
RF Cable	N/A	14+1.5m	06270619	Sep. 28, 2020	1 Year
Test software	Audix	E3	V 6.11111b	N/A	N/A

4 Duty Cycle

4.1. Block diagram of test setup

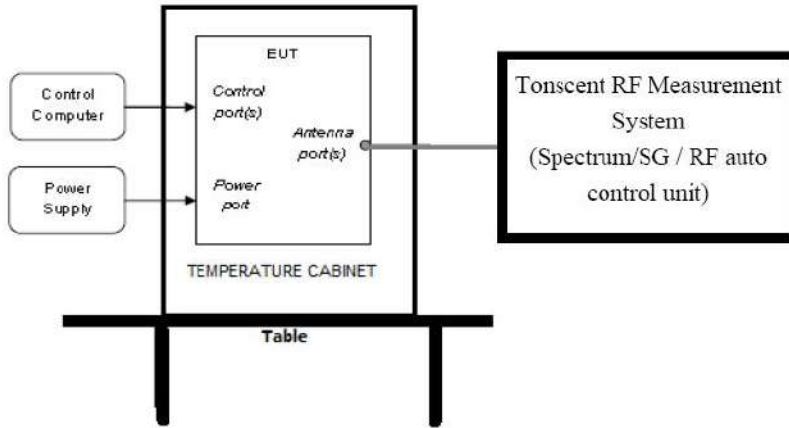

4.2. Limits

None: for reporting purposes only.

4.3. Test procedure

Set the Centre frequency of the spectrum analyzer to the transmitting frequency;

Set the span = 0, RBW = 1 MHz, VBW = 3 MHz, Sweep time = 100 ms;

Trace mode = Single hold.

4.4. Test result

Test Channel [MHz]	Duty Cycle [%]	20log(Δ) Factor[dB]
433.92	32.70	-9.71

Average value:	
Calculate Formula:	Average value = Peak value + PDCF
	PDCF = 20 log(Duty cycle)
	Duty cycle = $T_{on\ time} / T_{period}$
Test data:	$T_{on\ time} = (0.545 * 12 * 5) \text{ ms} = 32.70 \text{ ms}$
	$T_{period} = 100 \text{ ms}$
	PDCF = 20 log(Duty cycle) = 20 log(32.70/100) = -9.71 dB

4.5. Original test data

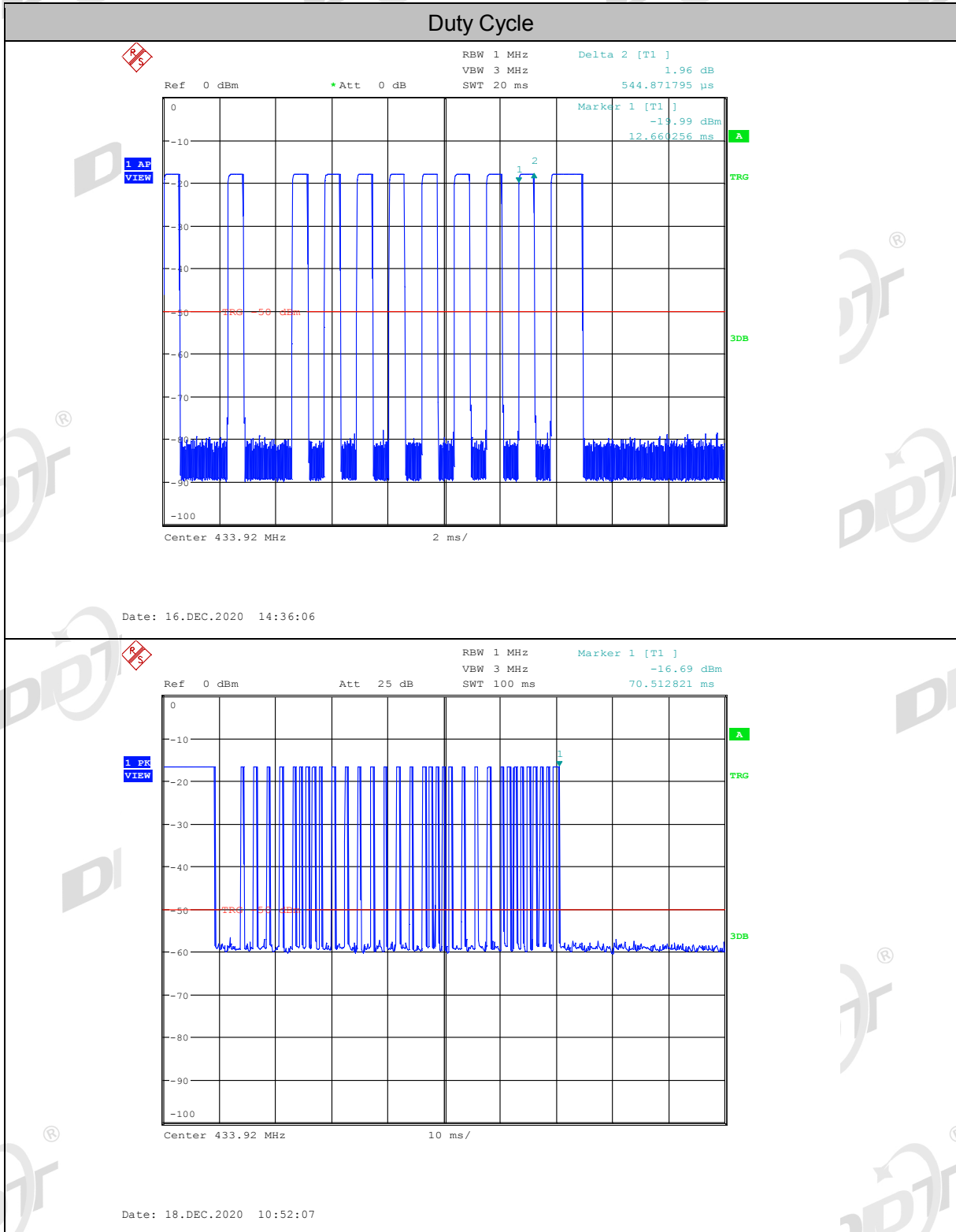

5 20 dB Bandwidth

5.1. Block diagram of test setup

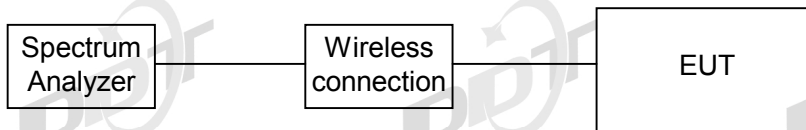

5.2. Limits

The bandwidth of the emission shall be no wider than 0.25% of the center frequency for devices operating above 70 MHz and below 900 MHz, Bandwidth is determined at the points 20 dB down from the modulated carrier.

5.3. Test procedure

- (1) Connect EUT's antenna output to spectrum analyzer by RF cable.
- (2) The bandwidth of the fundamental frequency was measured by spectrum analyzer with 3 kHz RBW and 10 kHz VBW. The 20 dB bandwidth is defined as the total spectrum the power of which is higher than peak power minus 20 dB.

5.4. Test result

Frequency (MHz)	20 dB Bandwidth (kHz)	Limit (MHz): No wider than 0.25% of the center frequency	Conclusion
433.92	99.36	$433.92 \times 0.25\% = 1.0848$	PASS

5.5. Original test data

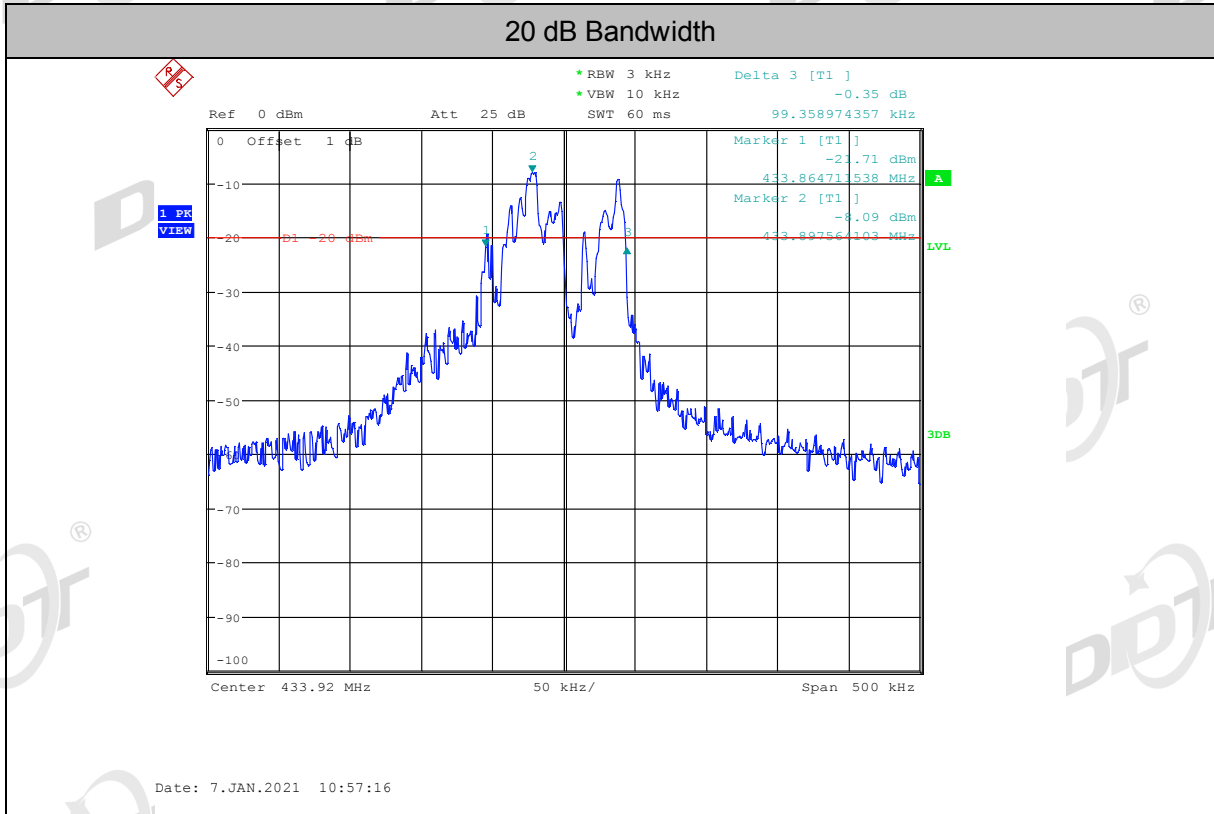

6 Transmission Time

6.1. Block diagram of test setup

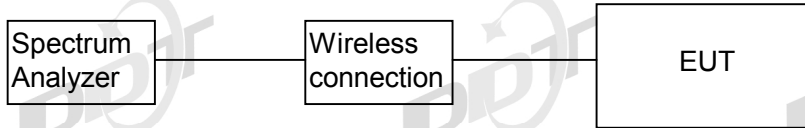

6.2. Limits

15.231(e), In addition, devices operated under the provisions of this paragraph shall be provided with a means for automatically limiting operation so that the duration of each transmission shall not be greater than one second and the silent period between transmissions shall be at least 30 times the duration of the transmission but in no case less than 10 seconds.

6.3. Test procedure

- (1) The EUT's RF signal was coupled to spectrum analyzer by antenna connected to spectrum analyzer.
- (2) Set the spectrum to zero span mode, and centered of EUT frequency.
- (3) Measure the stop transmitting time after release EUT button.

6.4. Test result

Frequency (MHz)	Test silent time	Results
433.92	> 10 s	Pass

6.5. Original test data

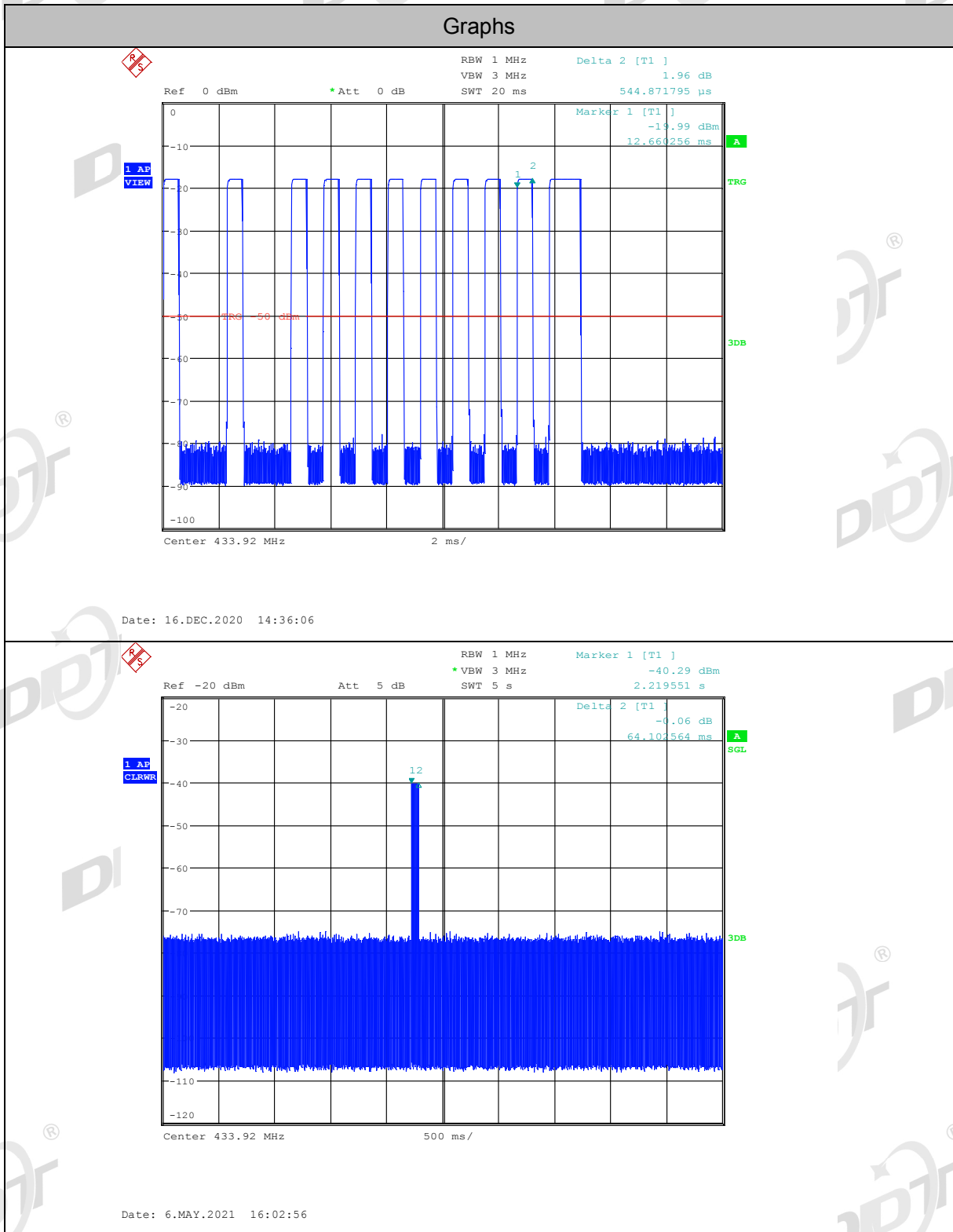

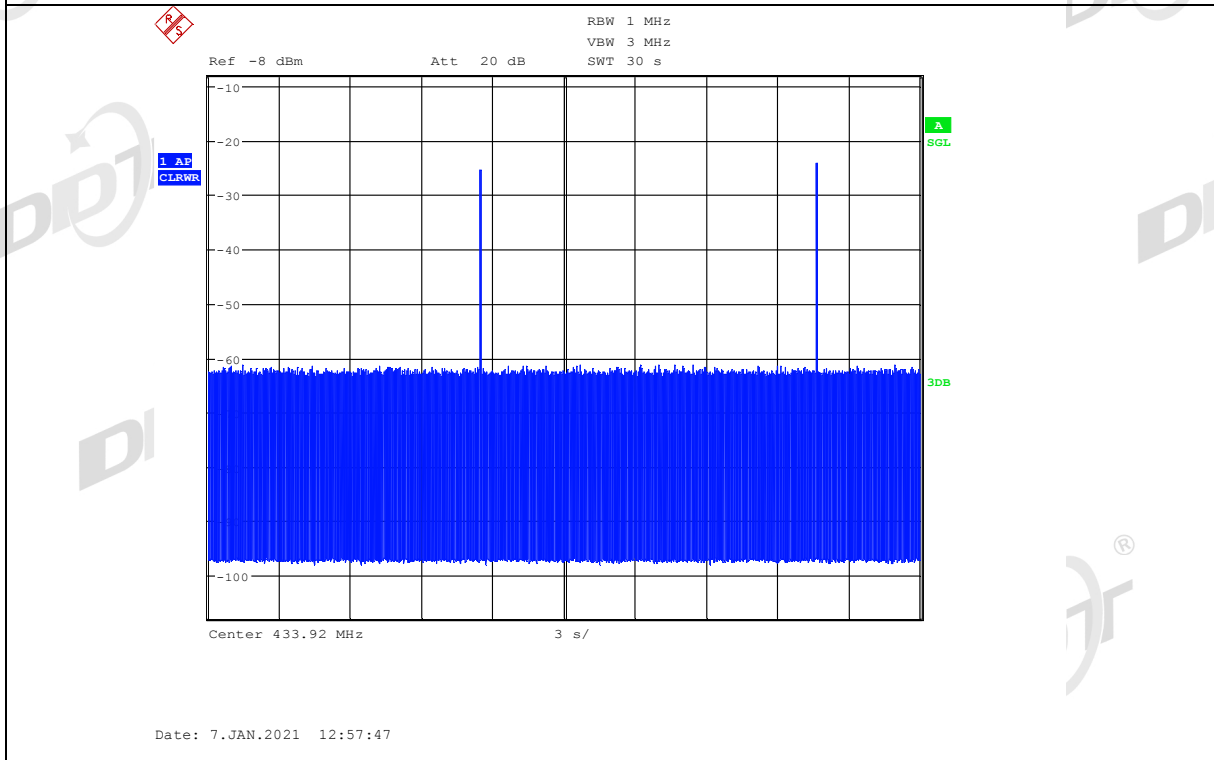
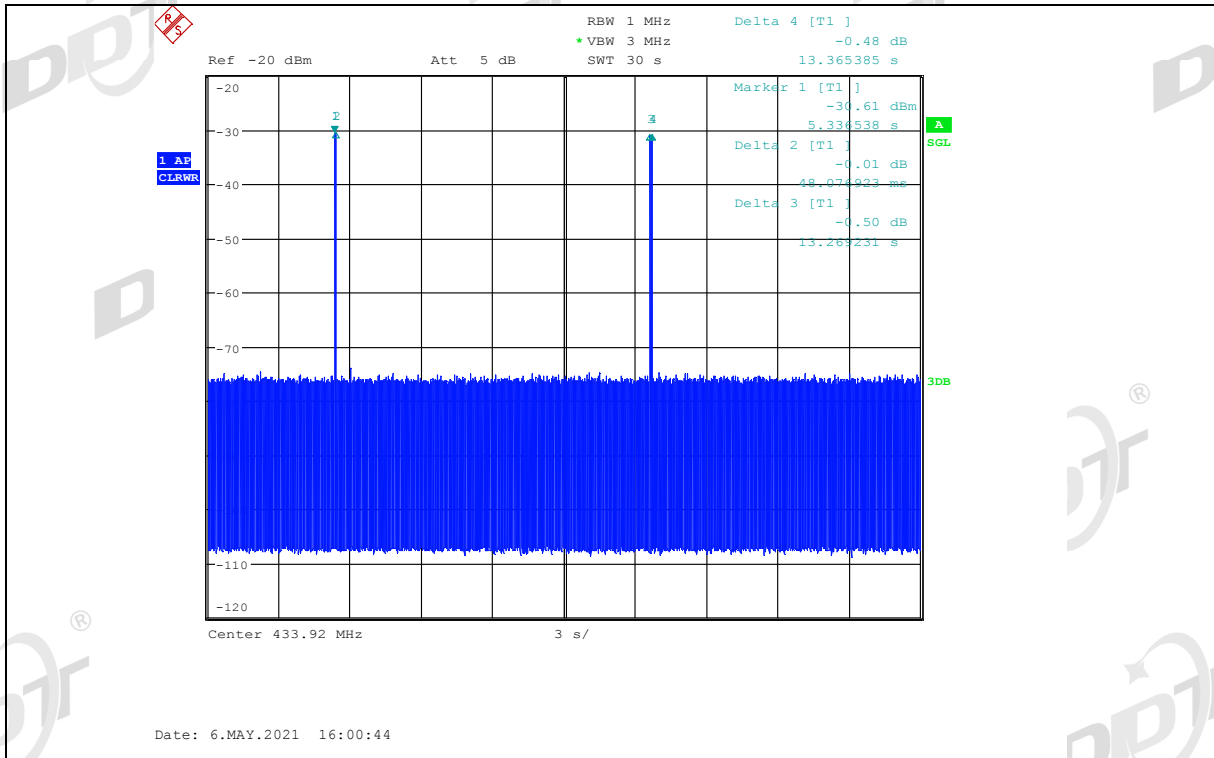

7 Radiated Emission

7.1. Block diagram of test setup

In 3 m Anechoic Chamber Test Setup Diagram for 9 kHz - 30 MHz

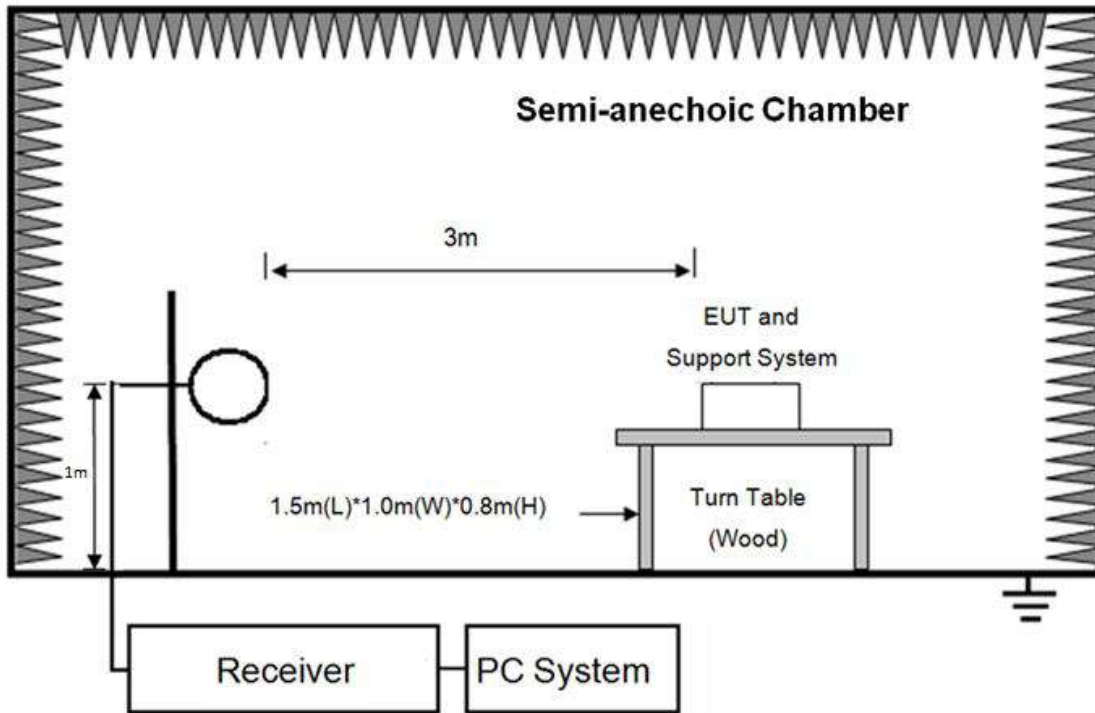

In 3 m Anechoic Chamber Test Setup Diagram for below 1 GHz

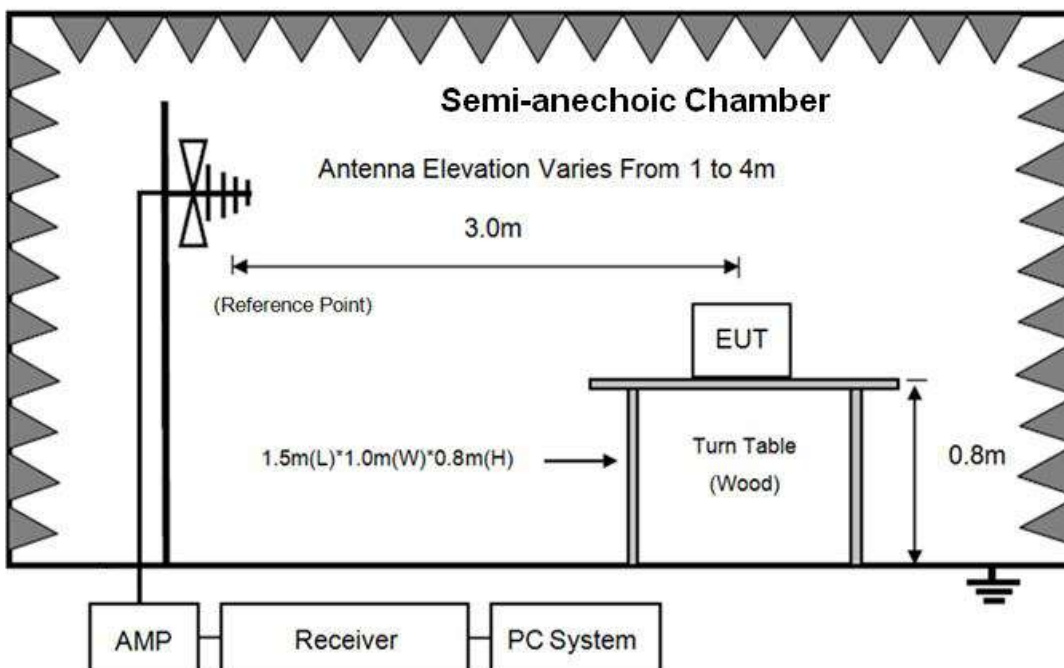

In 3 m Anechoic Chamber Test Setup Diagram for frequency above 1 GHz

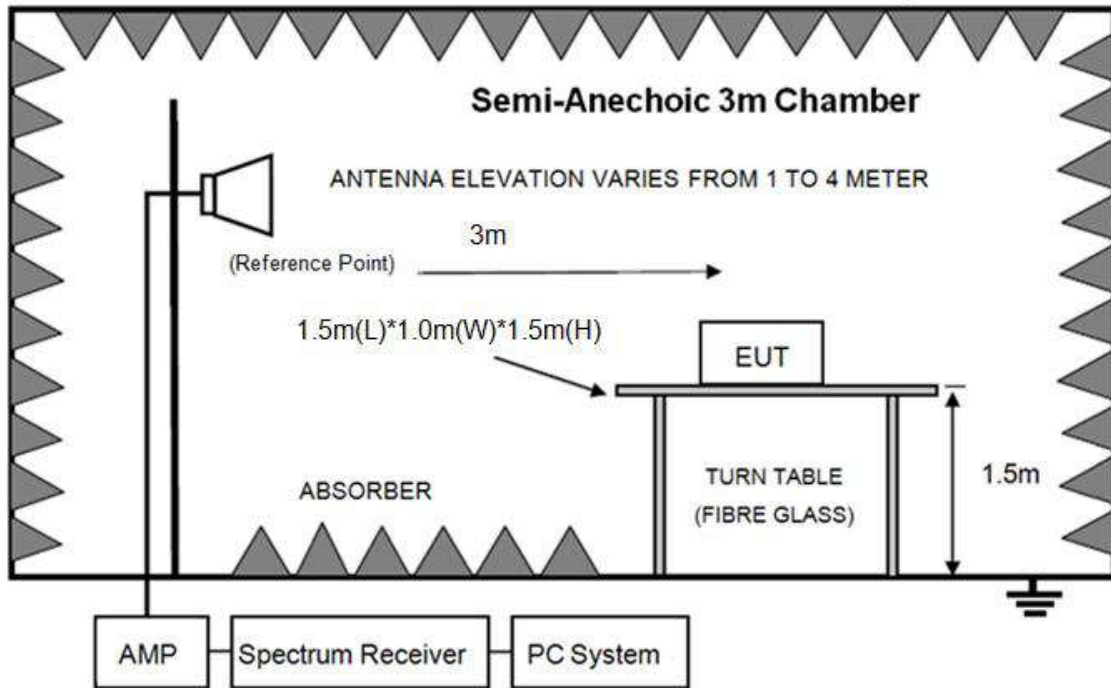

Note: For harmonic emissions test an appropriate high pass filter was inserted in the input port of AMP.

7.2. Limit

(1) FCC 15.205 Restricted frequency band

MHz	MHz	MHz	GHz
0.090-0.110	16.42-16.423	399.9-410	4.5-5.15
10.495-0.505	16.69475-16.69525	608-614	5.35-5.46
2.1735-2.1905	16.80425-16.80475	960-1240	7.25-7.75
4.125-4.128	25.5-25.67	1300-1427	8.025-8.5
4.1772&4.17775	37.5-38.25	1435-1626.5	9.0-9.2
4.2072&4.20775	73-74.6	1645.5-1646.5	9.3-9.5
6.215-6.218	74.8-75.2	1660-1710	10.6-12.7
6.26775-6.26825	108-121.94	1718.8-1722.2	13.25-13.4
6.31175-6.31225	123-138	2200-2300	14.47-14.5
8.291-8.294	149.9-150.05	2310-2390	15.35-16.2
8.362-8.366	156.52475-156.52525	2483.5-2500	17.7-21.4
8.37625-8.38675	156.7-156.9	2690-2900	22.01-23.12
8.41425-8.41475	162.0125-167.17	3260-3267	23.6-24.G
12.29-12.293	167.72-173.2	3332-3339	31.2-31.8
12.51975-12.52025	240-285	3345.8-3358	36.43-36.5
12.57675-12.57725	322-335.4	3600-4400	(²)
13.36-13.41			

(2) FCC 15.231(e) Limit.

Fundamental frequency (MHz)	Field strength of fundamental (microvolts/meter)	Field strength of spurious emissions (microvolts/meter)
40.66-40.70	1,000	100
70-130	500	50
130-174	500 to 1,500 ¹	50 to 150 ¹
174-260	1,500	150
260-470	1,500 to 5,000 ¹	150 to 500 ¹
Above 470	5,000	500

¹Linear interpolations.

FREQUENCY MHz	DISTANCE Meters	FIELD STRENGTHS LIMIT	
		μV/m	dB(μV)/m
0.009 ~ 0.490	300	2400/F(kHz)	67.6-20log(F)
0.490 ~ 1.705	30	24000/F(kHz)	87.6-20log(F)
1.705 ~ 30.0	30	30	29.54
30 ~ 88	3	100	40.0
88 ~ 216	3	150	43.5
216 ~ 960	3	200	46.0
960 ~ 1000	3	500	54.0
Above 1000	3	74.0 dB(μV)/m (Peak) 54.0 dB(μV)/m (Average)	

(3) FCC 15.231 section (e) limit

Fundamental Frequency (MHz)	Field Strength of Fundamental
433.92	AV: 72.87 dBuV/m @3m PK: 92.87 dBuV/m @3m

Note: (1) The emission limits shown in the above table are based on measurements employing a CISPR QP detector except for the frequency bands 9-90 kHz, 110-490 kHz and above 1000 MHz. Radiated emissions limits in these three bands are based on measurements employing an average detector.

(2) At frequencies below 30 MHz, measurement may be performed at a distance closer than that specified, and the limit at closer measurement distance can be extrapolated by below formula:

$$\text{Limit}_{3m}(\text{dBuV/m}) = \text{Limit}_{300m}(\text{dBuV/m}) + 40\text{Log}(300m/3m) = \text{Limit}_{300m}(\text{dBuV/m}) + 80$$

$$\text{Limit}_{3m}(\text{dBuV/m}) = \text{Limit}_{30m}(\text{dBuV/m}) + 40\text{Log}(30m/3m) = \text{Limit}_{30m}(\text{dBuV/m}) + 40$$

(3) Limit for this EUT

All the emissions appearing within 15.205 restricted frequency bands shall not exceed the limits shown in 15.209, all the other emissions include fundamental emission shall not exceed FCC 15.231 section (e) limit of comply with FCC 15.209 limit which permit higher emission level.

7.3. Test procedure

- (1) EUT was placed on a non-metallic table, 80 cm above the ground plane inside a semi-anechoic chamber for below 1G and 150 cm above the ground plane inside a semi-anechoic chamber for above 1G.
- (2) Test antenna was located 3 m from the EUT on an adjustable mast, and the antenna used as below table.

Test frequency range	Test antenna used	Test antenna distance
9 kHz - 30 MHz	Active Loop antenna	3 m
30 MHz - 1 GHz	Trilog Broadband Antenna	3 m
1 GHz - 18 GHz	Double Ridged Horn Antenna (1 GHz - 18 GHz)	3 m
18 GHz - 40 GHz	Horn Antenna (18 GHz - 40 GHz)	1 m

According ANSI C63.10:2013 clause 6.4.4.2 and 6.5.3, for measurements below 30 MHz, the loop antenna was positioned with its plane vertical from the EUT and rotated about its vertical axis for maximum response at each azimuth position around the EUT. And the loop antenna also is positioned with its plane horizontal at the specified distance from the EUT. The center of the loop is 1 m above the ground for measurement above 30 MHz, the Trilog Broadband Antenna or Horn Antenna was located 3 m from EUT, Measurements were made with the antenna positioned in both the horizontal and vertical planes of Polarization, and the measurement antenna was varied from 1 m to 4 m. in height above the reference ground plane to obtain the maximum signal strength.

(3) Below pre-scan procedure was first performed in order to find prominent frequency spectrum radiated emissions from 9 kHz to 5 GHz (tenth harmonic of fundamental frequency):

(a) Scanning the peak frequency spectrum with the antenna specified in step (3), and the EUT was rotated 360 degree, the antenna height was varied from 1 m to 4 m (Except loop antenna, it's fixed 1 m above ground.)

(b) Change work frequency or channel of device if practicable.

(c) Change modulation type of device if practicable.

(d) Change power supply range from 85% to 115% of the rated supply voltage

(e) Rotated EUT though three orthogonal axes to determine the attitude of EUT arrangement produces highest emissions.

(4) For final emissions measurements at each frequency of interest, the EUT was rotated and the antenna height was varied between 1 m and 4 m in order to maximize the emission. Measurements in both horizontal and vertical polarities were made and the data was recorded. In order to find the maximum emission, the relative positions of equipment and all of the interface cables were changed according to ANSI C63.10:2013 on Radiated Emission test.

(5) The emissions from 9 kHz to 1 GHz were measured based on CISPR QP detector except for

the frequency bands 9-90 kHz, 110-490 kHz, for emissions from 9 kHz - 90 kHz, 110 kHz - 490 kHz and above 1 GHz were measured based on average detector, for emissions above 1 GHz, peak emissions also be measured and need comply with Peak limit.

- (6) The emissions from 9 kHz to 1 GHz, QP or average values were measured with EMI receiver with below RBW.

Frequency band	RBW
9 kHz - 150 kHz	200 Hz
150 kHz - 30 MHz	9 kHz
30 MHz - 1 GHz	120 kHz

- (7) For emissions above 1 GHz, both Peak and Average level were measured with Spectrum Analyzer, and the RBW is set at 1 MHz, VBW is set at 3 MHz for Peak measure; For Average measure according to ANSI C63.10:2013 clause 4.2.3.2.3.

- (8) X axis, Y axis, Z axis are tested, and worse setup X axis is reported.

7.4. Test result

PASS. (See below detailed test result)

Note1: According exploratory test no any obvious emission were detected from 9 kHz to 30 MHz.

Note2: For emissions above 1 GHz. If peak results comply with AV limit, AV Result is deemed to comply with AV limit.

Radiated Emission test (below 1 GHz) TR-4-E-009 Radiated Emission Test Result

Test Site : DDT 3m Chamber 2# Test Date : 2020-12-28 EUT : M.R. REMOTE SMOKER THERMOMETER W/ HIGH TEMP CORD Power Supply : Battery Condition : Temp:24.5°C,Humi:55%,Press:100.1kPa Memo :	D:\2020 RE2# Report Data\Q20102311-1E\FCC BELOW1G.EM6 Tested By : Zora Model Number : 41008 Test Mode : Tx mode Antenna/Distance : 2019 VULB 9163 2#/3m/HORIZONTAL
---	---

Data: 9

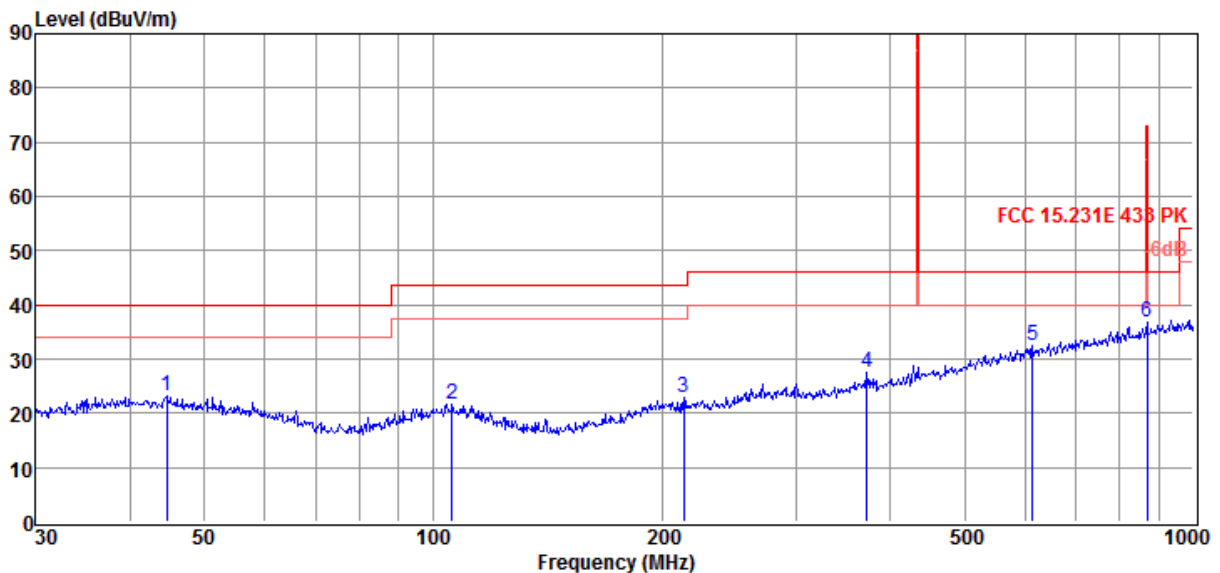

Item (Mark)	Freq. (MHz)	Read Level (dBμV)	Antenna Factor (dB/m)	Cable Loss dB	Result Level (dBμV/m)	Limit Line (dBμV/m)	Over Limit (dB)	Detector	Polarization
1	44.59	5.64	13.92	3.74	23.30	40.00	-16.70	Peak	HORIZONTAL
2	106.01	5.75	11.64	4.25	21.64	43.50	-21.86	Peak	HORIZONTAL
3	213.76	6.06	11.83	4.93	22.82	43.50	-20.68	Peak	HORIZONTAL
4	372.00	6.63	15.12	5.71	27.46	46.00	-18.54	Peak	HORIZONTAL
5	614.21	6.35	19.39	6.83	32.57	46.00	-13.43	Peak	HORIZONTAL
6	869.13	7.05	21.83	7.81	36.69	72.87	-36.18	Peak	HORIZONTAL

Note: 1. Result Level = Read Level + Antenna Factor + Cable loss.
 2. If Peak Result complies with QP limit, QP Result is deemed to comply with QP limit.
 3. Test setup: RBW: 120 kHz, VBW: 300 kHz, Sweep time: auto.

TR-4-E-009 Radiated Emission Test Result

Test Site : DDT 3m Chamber 2#

D:\2020 RE2# Report Data\Q20102311-1E\FCC BELOW1G.EM6

Test Date : 2020-12-28

Tested By : Zora

EUT : M.R. REMOTE SMOKER
THERMOMETER W/ HIGH TEMP CORD

Model Number : 41008

Power Supply : Battery

Test Mode : Tx mode

Condition : Temp:24.5°C,Humi:55%,Press:100.1kPa

Antenna/Distance : 2019 VULB 9163 2#/3m/VERTICAL

Memo :

Data: 10

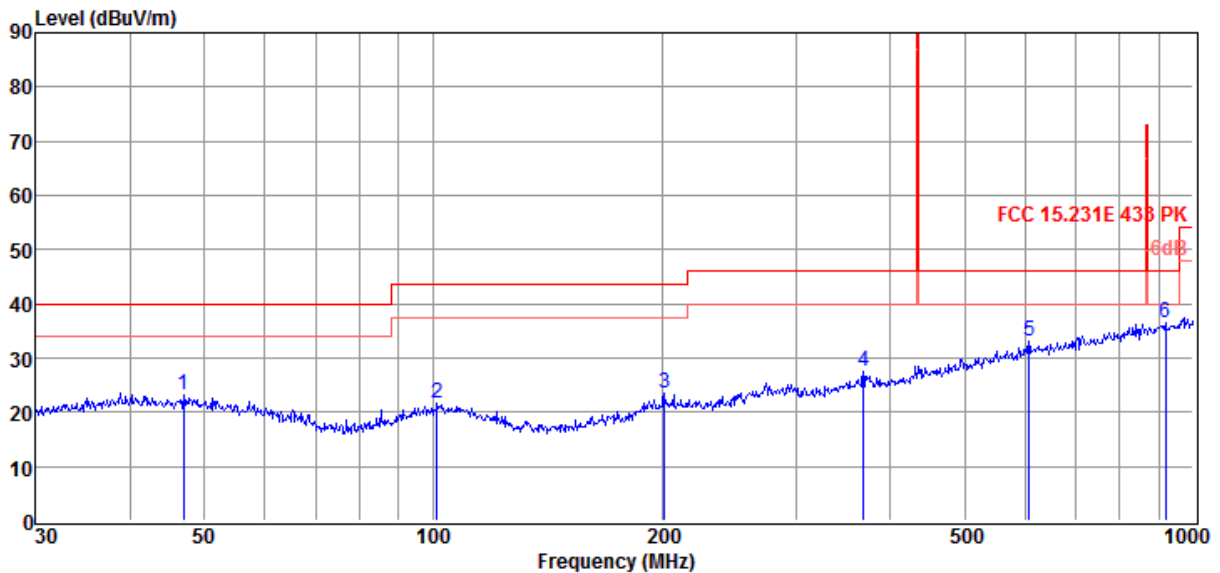

Item (Mark)	Freq. (MHz)	Read Level (dBμV)	Antenna Factor (dB/m)	Cable Loss (dB)	Result Level (dBμV/m)	Limit Line (dBμV/m)	Over Limit (dB)	Detector	Polarization
1	47.00	5.82	13.63	3.76	23.21	40.00	-16.79	Peak	VERTICAL
2	101.29	5.76	11.69	4.21	21.66	43.50	-21.84	Peak	VERTICAL
3	201.39	7.37	11.44	4.85	23.66	43.50	-19.84	Peak	VERTICAL
4	368.11	6.85	15.07	5.70	27.62	46.00	-18.38	Peak	VERTICAL
5	607.79	7.03	19.35	6.80	33.18	46.00	-12.82	Peak	VERTICAL
6	919.29	6.13	22.24	7.99	36.36	46.00	-9.64	Peak	VERTICAL

Note: 1. Result Level = Read Level + Antenna Factor + Cable loss.

2. If Peak Result complies with QP limit, QP Result is deemed to comply with QP limit.

3. Test setup: RBW: 120 kHz, VBW: 300 kHz, Sweep time: auto.

Field Strength of the Fundamental Signal

Frequency (MHz)	PK Level (dBuV/m)	PK Limit Line (dBuV/m)	Over Limit (dB)	Polarization
433.92	72.58	92.87	-20.29	Horizontal
433.92	68.45	92.87	-24.42	Vertical

Frequency (MHz)	AV Level (dBuV/m)	AV Limit Line (dBuV/m)	Over Limit (dB)	Polarization
433.92	62.87	72.87	-10.00	Horizontal
433.92	58.74	72.87	-14.13	Vertical

Note: AV Level = PK Level + PDCF

Radiated Emission test (above 1 GHz)

Freq. (MHz)	Read level (dB μ V)	Antenna Factor (dB/m)	PRM Factor (dB)	Cable Loss (dB)	Result Level (dB μ V/m)	Limit (dB μ V/m)	Margin (dB)	Detector type	Polarization
Tx mode									
1732.00	50.55	26.06	43.91	3.32	36.02	74.00	-37.98	Peak	HORIZONTAL
2620.00	50.94	28.04	44.22	4.26	39.02	74.00	-34.98	Peak	HORIZONTAL
3328.00	53.21	29.23	44.32	4.97	43.09	74.00	-30.91	Peak	HORIZONTAL
3648.00	54.09	29.68	44.36	5.31	44.72	74.00	-29.28	Peak	HORIZONTAL
4140.00	53.53	30.94	44.42	5.77	45.82	74.00	-28.18	Peak	HORIZONTAL
4888.00	53.42	32.34	44.49	6.21	47.48	74.00	-26.52	Peak	HORIZONTAL
1296.00	52.14	25.34	43.54	2.76	36.70	74.00	-37.30	Peak	VERTICAL
2020.00	50.95	26.74	44.10	3.68	37.27	74.00	-36.73	Peak	VERTICAL
2892.00	52.42	28.80	44.26	4.52	41.48	74.00	-32.52	Peak	VERTICAL
3688.00	54.25	29.79	44.37	5.36	45.03	74.00	-28.97	Peak	VERTICAL
4232.00	53.29	31.16	44.43	5.82	45.84	74.00	-28.16	Peak	VERTICAL
4688.00	53.29	32.06	44.47	6.09	46.97	74.00	-27.03	Peak	VERTICAL
Result: Pass									

Note: 1. Result Level = Read Level + Antenna Factor + Cable loss - PRM Factor.

2. For emissions above 1 GHz. If peak results comply with AV limit, AV Result is deemed to comply with AV limit.

8 Power Line Conducted Emission

8.1. Block diagram of test setup

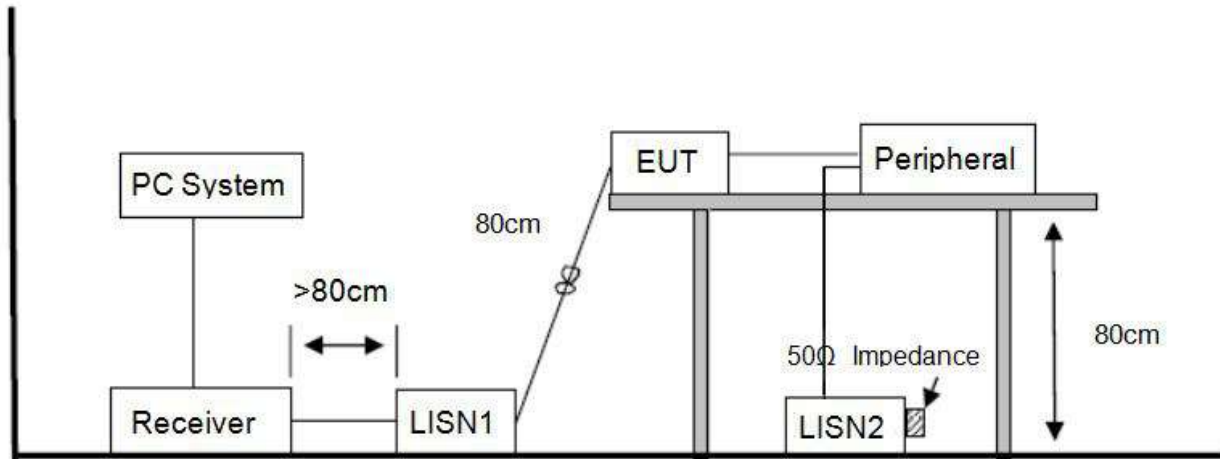

8.2. Power line conducted emission limits

Frequency	Quasi-Peak Level dB(μ V)	Average Level dB(μ V)
150 kHz ~ 500 kHz	66 ~ 56*	56 ~ 46*
500 kHz ~ 5 MHz	56	46
5 MHz ~ 30 MHz	60	50

Note 1: * Decreasing linearly with logarithm of frequency.

Note 2: The lower limit shall apply at the transition frequencies.

8.3. Test procedure

The EUT and Support equipment, if needed, were put placed on a non-metallic table, 80cm above the ground plane.

Configuration EUT to simulate typical usage as described in clause 2.4 and test equipment as described in clause 10.2 of this report.

All I/O cables were positioned to simulate typical actual usage as per ANSI C63.10.

All support equipment power received from a second LISN.

Emissions were measured on each current carrying line of the EUT using an EMI Test Receiver connected to the LISN powering the EUT.

The Receiver scanned from 150 kHz to 30 MHz for emissions in each of the test modes.

During the above scans, the emissions were maximized by cable manipulation.

The test mode(s) described in clause 2.4 were scanned during the preliminary test.

After the preliminary scan, we found the test mode producing the highest emission level.

The EUT configuration and worse cable configuration of the above highest emission levels were

recorded for reference of the final test.

EUT and support equipment were set up on the test bench as per the configuration with highest emission level in the preliminary test.

A scan was taken on both power lines, Neutral and Line, recording at least the six highest emissions.

Emission frequency and amplitude were recorded into a computer in which correction factors were used to calculate the emission level and compare reading to the applicable limit.

The test data of the worst-case condition(s) was recorded.

The bandwidth of test receiver is set at 9 kHz.

8.4. Test result

Not Applicable

Conducted limits are not required for devices which only employ battery power for operation according to 15.207(C)

9. Antenna Requirements

9.1. Limit

For intentional device, according to FCC 47 CFR Section 15.203, an intentional radiator shall be designed to ensure that no antenna other than that furnished by the responsible party shall be used with the device.

9.2. Result

The antenna used for this product is Line Antenna and that no antenna other than that furnished by the responsible party shall be used with the device, the maximum peak gain of the transmit antenna is 0 dBi.

END OF REPORT