

FCC Test Report (WLAN 5GHz Band)

Report No.: RFBEMT-WTW-P21090660-3

FCC ID: 2AYRA-08321

Test Model: MR2000

Variant Model: MR20MS, MR20EC, ME20WH (Refer to item 3.1 for more details)

Received Date: Sep. 30, 2021

Test Date: Oct. 07 ~ Nov. 04, 2021

Issued Date: Jan. 18, 2022

Applicant: Linksys USA, Inc.

Address: 121 Theory, Irvine, CA 92617, USA

Issued By: Bureau Veritas Consumer Products Services (H.K.) Ltd., Taoyuan Branch
Lin Kou Laboratories

Lab Address: No. 47-2, 14th Ling, Chia Pau Vil., Lin Kou Dist., New Taipei City, Taiwan

Test Location (1): No. 19, Hwa Ya 2nd Rd., Wen Hwa Vil., Kwei Shan Dist., Taoyuan City
33383, Taiwan

Test Location (2): No. 70, Wenming Rd., Guishan Dist., Taoyuan City 333, Taiwan

**FCC Registration /
Designation Number (1):** 788550 / TW0003

**FCC Registration /
Designation Number (2):** 281270 / TW0032



This report is for your exclusive use. Any copying or replication of this report to or for any other person or entity, or use of our name or trademark, is permitted only with our prior written permission. This report sets forth our findings solely with respect to the test samples identified herein. The results set forth in this report are not indicative or representative of the quality or characteristics of the lot from which a test sample was taken or any similar or identical product specifically and expressly noted. Our report includes all of the tests requested by you and the results thereof based upon the information that you provided to us. You have 60 days from date of issuance of this report to notify us of any material error or omission caused by our negligence, provided, however, that such notice shall be in writing and shall specifically address the issue you wish to raise. A failure to raise such issue within the prescribed time shall constitute your unqualified acceptance of the completeness of this report, the tests conducted and the correctness of the report contents. Unless specific mention, the uncertainty of measurement has been explicitly taken into account to declare the compliance or non-compliance to the specification.

Table of Contents

Release Control Record	4
1 Certificate of Conformity	5
2 Summary of Test Results	6
2.1 Measurement Uncertainty.....	6
2.2 Modification Record.....	6
3 General Information	7
3.1 General Description of EUT.....	7
3.2 Description of Test Modes.....	10
3.2.1 Test Mode Applicability and Tested Channel Detail.....	12
3.3 Duty Cycle of Test Signal.....	14
3.4 Description of Support Units.....	15
3.4.1 Configuration of System under Test.....	15
3.5 General Description of Applied Standards and References.....	16
4 Test Types and Results	17
4.1 Radiated Emission and Bandedge Measurement.....	17
4.1.1 Limits of Radiated Emission and Bandedge Measurement.....	17
4.1.2 Test Instruments.....	18
4.1.3 Test Procedures.....	19
4.1.4 Deviation from Test Standard.....	20
4.1.5 Test Setup.....	20
4.1.6 EUT Operating Conditions.....	21
4.1.7 Test Results.....	22
4.2 Conducted Emission Measurement.....	66
4.2.1 Limits of Conducted Emission Measurement.....	66
4.2.2 Test Instruments.....	66
4.2.3 Test Procedures.....	67
4.2.4 Deviation from Test Standard.....	67
4.2.5 Test Setup.....	67
4.2.6 EUT Operating Conditions.....	67
4.2.7 Test Results.....	68
4.3 Transmit Power Measurement.....	72
4.3.1 Limits of Transmit Power Measurement.....	72
4.3.2 Test Setup.....	72
4.3.3 Test Instruments.....	72
4.3.4 Test Procedure.....	73
4.3.5 Deviation from Test Standard.....	73
4.3.6 EUT Operating Conditions.....	73
4.3.7 Test Result.....	74
4.4 Occupied Bandwidth Measurement.....	86
4.4.1 Test Setup.....	86
4.4.2 Test Instruments.....	86
4.4.3 Test Procedure.....	86
4.4.4 Test Result.....	87
4.5 Peak Power Spectral Density Measurement.....	95
4.5.1 Limits of Peak Power Spectral Density Measurement.....	95
4.5.2 Test Setup.....	95
4.5.3 Test Instruments.....	95
4.5.4 Test Procedures.....	95
4.5.5 Deviation from Test Standard.....	96
4.5.6 EUT Operating Conditions.....	96
4.5.7 Test Results.....	97
4.6 Frequency Stability.....	105
4.6.1 Limits of Frequency Stability Measurement.....	105

4.6.2	Test Setup.....	105
4.6.3	Test Instruments	105
4.6.4	Test Procedure	105
4.6.5	Deviation from Test Standard	106
4.6.6	EUT Operating Condition	106
4.6.7	Test Results	106
4.7	6dB Bandwidth Measurement.....	107
4.7.1	Limits of 6dB Bandwidth Measurement.....	107
4.7.2	Test Setup.....	107
4.7.3	Test Instruments	107
4.7.4	Test Procedure	107
4.7.5	Deviation from Test Standard	107
4.7.6	EUT Operating Condition	107
4.7.7	Test Results	108
5	Pictures of Test Arrangements.....	110
	Annex A- Radiated out of Band Emission (OOBE) Measurement (For U-NII-3 band).....	111
	Annex B- Band Edge Measurement.....	114
	Appendix – Information of the Testing Laboratories	128

Release Control Record

Issue No.	Description	Date Issued
RFBEMT-WTW-P21090660-3	Original release	Jan. 18, 2022

1 Certificate of Conformity

Product: AX3000 DUAL-BAND WIFI 6 ROUTER

Brand: LINKSYS

Test Model: MR2000

Variation Model: MR20MS, MR20EC, ME20WH (Refer to item 3.1 for more details)

Sample Status: Engineering sample

Applicant: Linksys USA, Inc.

Test Date: Oct. 07 ~ Nov. 04, 2021

Standards: 47 CFR FCC Part 15, Subpart E (Section 15.407)
ANSI C63.10:2013

The above equipment has been tested by **Bureau Veritas Consumer Products Services (H.K.) Ltd., Taoyuan Branch**, and found compliance with the requirement of the above standards. The test record, data evaluation & Equipment Under Test (EUT) configurations represented herein are true and accurate accounts of the measurements of the sample's RF characteristics under the conditions specified in this report.

Prepared by : Pettie Chen , **Date:** Jan. 18, 2022
Pettie Chen / Senior Specialist

Approved by : Jeremy Lin , **Date:** Jan. 18, 2022
Jeremy Lin / Project Engineer

2 Summary of Test Results

47 CFR FCC Part 15, Subpart E (Section 15.407)			
FCC Clause	Test Item	Result	Remarks
15.407(b)(9)	AC Power Conducted Emissions	Pass	Meet the requirement of limit. Minimum passing margin is -10.25dB at 0.52600MHz.
15.407(b)(1/2/3/4(i/ii)/9)	Radiated Emissions & Band Edge Measurement	Pass	Meet the requirement of limit. Minimum passing margin is -1.0dB at 5040.0, 5650.0MHz.
15.407(a)(1/2/3)	Max Average Transmit Power	Pass	Meet the requirement of limit.
---	Occupied Bandwidth Measurement	-	Reference only.
15.407(a)(1/2/3)	Peak Power Spectral Density	Pass	Meet the requirement of limit.
15.407(e)	6dB bandwidth	Pass	Meet the requirement of limit. (U-NII-3 Band only)
15.407(g)	Frequency Stability	Pass	Meet the requirement of limit.
15.203	Antenna Requirement	Pass	Antenna connector is ipex(MHF) not a standard connector.

Note:

- Determining compliance based on the results of the compliance measurement, not taking into account measurement instrumentation uncertainty.
- For U-NII-1, U-NII-2a, U-NII-2c band compliance with rule 15.407(b) of the band-edge items, the test plots were recorded in Annex B. Test Procedures refer to report 4.1.3.
For U-NII-3 band compliance with rule part 15.407(b)(4)(i), the OOB test plots were recorded in Annex A.

2.1 Measurement Uncertainty

Where relevant, the following measurement uncertainty levels have been estimated for tests performed on the EUT as specified in CISPR 16-4-2:

Measurement	Frequency	Expanded Uncertainty (k=2) (\pm)
Conducted Emissions at mains ports	150kHz ~ 30MHz	2.79 dB
Radiated Emissions up to 1 GHz	9kHz ~ 30MHz	3.00 dB
	30MHz ~ 200MHz	2.91 dB
	200MHz ~ 1000MHz	2.93 dB
Radiated Emissions above 1 GHz	1GHz ~ 18GHz	1.76 dB
	18GHz ~ 40GHz	1.77 dB

2.2 Modification Record

There were no modifications required for compliance.

3 General Information

3.1 General Description of EUT

Product	AX3000 DUAL-BAND WIFI 6 ROUTER
Brand	LINKSYS
Test Model	MR2000
Variant Model	MR20MS, MR20EC, ME20WH
Model Difference	for Marketing purpose
Sample Status	Engineering sample
Power Supply Rating	12Vdc (From adapter)
Modulation Type	256QAM, 64QAM, 16QAM, QPSK, BPSK for OFDM 1024QAM, 256QAM, 64QAM, 16QAM, QPSK, BPSK for OFDMA
Modulation Technology	OFDM, OFDMA
Transfer Rate	802.11a: 54/48/36/24/18/12/9/6Mbps 802.11n: up to 300Mbps 802.11ac: up to 866.7Mbps 802.11ax: up to 1200Mbps
Operating Frequency	5180 ~ 5320MHz, 5500 ~ 5700MHz, 5745 ~ 5825MHz
Number of Channel	5180 ~ 5320MHz: 802.11a, 802.11n (HT20), 802.11ac (VHT20), 802.11ax (HE20): 8 802.11n (HT40), 802.11ac (VHT40), 802.11ax (HE40): 4 802.11ac (VHT80), 802.11ax (HE80): 2 802.11ac (VHT160), 802.11ax (HE160): 1 5500 ~ 5700MHz: 802.11a, 802.11n (HT20), 802.11ac (VHT20), 802.11ax (HE20): 11 802.11n (HT40), 802.11ac (VHT40), 802.11ax (HE40): 5 802.11ac (VHT80), 802.11ax (HE80): 2 802.11ac (VHT160), 802.11ax (HE160): 1 5745 ~ 5825MHz: 802.11a, 802.11n (HT20), 802.11ac (VHT20), 802.11ax (HE20): 5 802.11n (HT40), 802.11ac (VHT40), 802.11ax (HE40): 2 802.11ac (VHT80), 802.11ax (HE80): 1
Output Power	CDD Mode: 5180 ~ 5240MHz: 529.245mW 5260 ~ 5320MHz: 235.644mW 5500 ~ 5700MHz: 232.687mW 5745 ~ 5825MHz: 656.302mW Beamforming Mode: 5180 ~ 5240MHz: 501.234mW 5260 ~ 5320MHz: 208.324mW 5500 ~ 5700MHz: 206.296mW 5745 ~ 5825MHz: 656.302mW
Antenna Type	Refer to Note
Antenna Connector	Refer to Note
Accessory Device	Refer to Note
Cable Supplied	NA

Note:

1. The EUT incorporates a MIMO function. Physically, the EUT provides 2 completed transmitters and 2 receivers.

Modulation Mode	Beamforming Mode	TX Function
802.11a	Not Support	2TX
802.11n (HT20)	Support	2TX
802.11n (HT40)	Support	2TX
802.11ac (VHT20)	Support	2TX
802.11ac (VHT40)	Support	2TX
802.11ac (VHT80)	Support	2TX
802.11ac (VHT160)	Support	2TX
802.11ax (HE20)	Support	2TX
802.11ax (HE40)	Support	2TX
802.11ax (HE80)	Support	2TX
802.11ax (HE160)	Support	2TX

* The bandwidth and modulation are similar for HT20/HT40 on 802.11n mode and VHT20/VHT40 on 802.11ac mode and HE20/HE40/HE80 on 802.11ax mode. Therefore the investigated worst case is the representative mode in test report. (Final test mode refer section 3.2.1)

* For 802.11n and 802.11ac, CDD mode and Beamforming mode are presented in power output test item. For other test items, CDD mode is the worst case for final tests after pretesting.

2. The antenna information is listed as below.

Antenna Type	Dipole	
Connector Type	ipex(MHF)	
Frequency	Antenna Gain (dBi)	
	Chain 0	Chain 1
2400~2483.5MHz	3.70	4.09
5150~5250MHz	3.65	3.46
5250~5350MHz	3.57	3.54
5470~5725MHz	3.81	3.75
5725~5850MHz	3.81	3.75
5850~5925MHz	3.71	3.48

*The above Antenna information is declared by manufacturer and for more detailed features description, please refer to the manufacturer's specifications, the laboratory shall not be held responsible.

3. The EUT uses following adapters.

Adapter 1	
Brand	Ktec
Model	KSA-18W-120150VU
Input Power	100-240Vac~50/60Hz, 0.5A
Output Power	12Vdc, 1.5A
Power line	1.5m non-shielded cable without core

Adapter 2	
Brand	Moso
Model	MSA-C1500IC12.0-18P-US
Input Power	100-240Vac~50/60Hz, 0.7A max
Output Power	12Vdc, 1.5A
Power line	1.5m non-shielded cable without core

Adapter 3	
Brand	Ktec
Model	KSA-18W-120150D5
Input Power	100-240Vac~50/60Hz, 0.5A
Output Power	12Vdc, 1.5A
Power line	1.5m non-shielded cable without core

Adapter 4	
Brand	Moso
Model	MSA-C1500IC12.0-18P-zz
Input Power	100-240Vac~50/60Hz, 0.7A
Output Power	12Vdc, 1.5A
Power line	1.5m non-shielded cable without core

* Adapter 1 & 3, 2 & 4 are identical to each other, except the plug type for different country, therefore only adapter 1 & 2 were for final test and presented in the test report.

4. WLAN 2.4GHz & 5.0GHz & BT technology can transmit at same time.

3.2 Description of Test Modes

For 5180 ~ 5320MHz:

8 channels are provided for 802.11a, 802.11n (HT20), 802.11ac (VHT20), 802.11ax (HE20):

Channel	Frequency	Channel	Frequency
36	5180 MHz	44	5220 MHz
40	5200 MHz	48	5240 MHz
52	5260 MHz	60	5300 MHz
56	5280 MHz	64	5320 MHz

4 channels are provided for 802.11n (HT40), 802.11ac (VHT40), 802.11ax (HE40):

Channel	Frequency	Channel	Frequency
38	5190 MHz	46	5230 MHz
54	5270 MHz	62	5310 MHz

2 channels are provided for 802.11ac (VHT80), 802.11ax (HE80):

Channel	Frequency	Channel	Frequency
42	5210MHz	58	5290MHz

1 channel is provided for 802.11ac (VHT160), 802.11ax (HE160):

Channel	Frequency
50	5250MHz

For 5500 ~ 5700MHz:

11 channels are provided for 802.11a, 802.11n (HT20), 802.11ac (VHT20), 802.11ax (HE20):

Channel	Frequency	Channel	Frequency
100	5500 MHz	124	5620 MHz
104	5520 MHz	128	5640 MHz
108	5540 MHz	132	5660 MHz
112	5560 MHz	136	5680 MHz
116	5580 MHz	140	5700 MHz
120	5600 MHz		

5 channels are provided for 802.11n (HT40), 802.11ac (VHT40), 802.11ax (HE40):

Channel	Frequency	Channel	Frequency
102	5510 MHz	126	5630 MHz
110	5550 MHz	134	5670 MHz
118	5590 MHz		

2 channels are provided for 802.11ac (VHT80), 802.11ax (HE80):

Channel	Frequency	Channel	Frequency
106	5530 MHz	122	5610 MHz

1 channel is provided for 802.11ac (VHT160), 802.11ax (HE160):

Channel	Frequency
114	5570MHz

For 5745 ~ 5825MHz:

5 channels are provided for 802.11a, 802.11n (HT20), 802.11ac (VHT20), 802.11ax (HE20):

Channel	Frequency	Channel	Frequency
149	5745MHz	161	5805MHz
153	5765MHz	165	5825MHz
157	5785MHz		

2 channels are provided for 802.11n (HT40), 802.11ac (VHT40), 802.11ax (HE40):

Channel	Frequency	Channel	Frequency
151	5755MHz	159	5795MHz

1 channel is provided for 802.11ac (VHT80), 802.11ax (HE80):

Channel	Frequency
155	5775MHz

3.2.1 Test Mode Applicability and Tested Channel Detail

EUT Configure Mode	Applicable to				Description
	RE \geq 1G	RE<1G	PLC	APCM	
A	√	√	√	√	Power from adapter 1
B	-	√	√	-	Power from adapter 2

Where RE \geq 1G: Radiated Emission above 1GHz & Bandedge Measurement
 RE<1G: Radiated Emission below 1GHz
 PLC: Power Line Conducted Emission
 APCM: Antenna Port Conducted Measurement

Note:

- The EUT had been pre-tested on the positioned of each 3 axis. The worst case was found when positioned on **X-plane**.
- Radiated emission test (below 1GHz) and power line conducted emission test items chosen the worst maximum power.

Radiated Emission Test (Above 1GHz):

- Pre-Scan has been conducted to determine the worst-case mode from all possible combinations between available modulations, data rates and antenna ports (if EUT with antenna diversity architecture).
- Following channel(s) was (were) selected for the final test as listed below.

EUT Configure Mode	Mode	Frequency Band (MHz)	Available Channel	Tested Channel	Modulation Technology	Data Rate (Mbps)
A	802.11a	5180-5240	36 to 48	36, 40, 48	OFDM	6.0
	802.11ax (HE20)		36 to 48	36, 40, 48	OFDMA	MCS0
	802.11ax (HE40)		38 to 46	38, 46	OFDMA	MCS0
	802.11ax (HE80)		42	42	OFDMA	MCS0
A	802.11a	5260-5320	52 to 64	52, 60, 64	OFDM	6.0
	802.11ax (HE20)		52 to 64	52, 60, 64	OFDMA	MCS0
	802.11ax (HE40)		54 to 62	54, 62	OFDMA	MCS0
	802.11ax (HE80)		58	58	OFDMA	MCS0
	802.11ax (HE160)		50	50	OFDMA	MCS0
A	802.11a	5500-5700	100 to 140	100, 116, 140	OFDM	6.0
	802.11ax (HE20)		100 to 140	100, 116, 140	OFDMA	MCS0
	802.11ax (HE40)		102 to 134	102, 110, 134	OFDMA	MCS0
	802.11ax (HE80)		106 to 122	106, 122	OFDMA	MCS0
	802.11ax (HE160)		114	114	OFDMA	MCS0
A	802.11a	5745-5825	149 to 165	149, 157, 165	OFDM	6.0
	802.11ax (HE20)		149 to 165	149, 157, 165	OFDMA	MCS0
	802.11ax (HE40)		151 to 159	151, 159	OFDMA	MCS0
	802.11ax (HE80)		155	155	OFDMA	MCS0

Radiated Emission Test (Below 1GHz):

- Pre-Scan has been conducted to determine the worst-case mode from all possible combinations between available modulations, data rates and antenna ports (if EUT with antenna diversity architecture).
- Following channel(s) was (were) selected for the final test as listed below.

EUT Configure Mode	Mode	Frequency Band (MHz)	Available Channel	Tested Channel	Modulation Technology	Data Rate (Mbps)
A, B	802.11ax (HE40)	5180-5240	38 to 46	159	OFDMA	MCS0
	802.11ax (HE40)	5260-5320	54 to 62		OFDMA	MCS0
	802.11ax (HE40)	5500-5700	102 to 134		OFDMA	MCS0
	802.11ax (HE40)	5745-5825	151 to 159		OFDMA	MCS0

Power Line Conducted Emission Test:

- Pre-Scan has been conducted to determine the worst-case mode from all possible combinations between available modulations, data rates and antenna ports (if EUT with antenna diversity architecture).
- Following channel(s) was (were) selected for the final test as listed below.

EUT Configure Mode	Mode	Frequency Band (MHz)	Available Channel	Tested Channel	Modulation Technology	Data Rate (Mbps)
A, B	802.11ax (HE40)	5180-5240	38 to 46	159	OFDMA	MCS0
	802.11ax (HE40)	5260-5320	54 to 62		OFDMA	MCS0
	802.11ax (HE40)	5500-5700	102 to 134		OFDMA	MCS0
	802.11ax (HE40)	5745-5825	151 to 159		OFDMA	MCS0

Antenna Port Conducted Measurement:

- This item includes all test value of each mode, but only includes spectrum plot of worst value of each mode.
- Pre-Scan has been conducted to determine the worst-case mode from all possible combinations between available modulations, data rates and antenna ports (if EUT with antenna diversity architecture).
- Following channel(s) was (were) selected for the final test as listed below.

EUT Configure Mode	Mode	Frequency Band (MHz)	Available Channel	Tested Channel	Modulation Technology	Data Rate (Mbps)
A	802.11a	5180-5240	36 to 48	36, 40, 48	OFDM	6.0
	802.11ax (HE20)		36 to 48	36, 40, 48	OFDMA	MCS0
	802.11ax (HE40)		38 to 46	38, 46	OFDMA	MCS0
	802.11ax (HE80)		42	42	OFDMA	MCS0
A	802.11a	5260-5320	52 to 64	52, 60, 64	OFDM	6.0
	802.11ax (HE20)		52 to 64	52, 60, 64	OFDMA	MCS0
	802.11ax (HE40)		54 to 62	54, 62	OFDMA	MCS0
	802.11ax (HE80)		58	58	OFDMA	MCS0
	802.11ax (HE160)		50	50	OFDMA	MCS0
A	802.11a	5500-5700	100 to 140	100, 116, 140	OFDM	6.0
	802.11ax (HE20)		100 to 140	100, 116, 140	OFDMA	MCS0
	802.11ax (HE40)		102 to 134	102, 110, 134	OFDMA	MCS0
	802.11ax (HE80)		106 to 122	106, 122	OFDMA	MCS0
	802.11ax (HE160)		114	114	OFDMA	MCS0
A	802.11a	5745-5825	149 to 165	149, 157, 165	OFDM	6.0
	802.11ax (HE20)		149 to 165	149, 157, 165	OFDMA	MCS0
	802.11ax (HE40)		151 to 159	151, 159	OFDMA	MCS0
	802.11ax (HE80)		155	155	OFDMA	MCS0

Test Condition:

Applicable to	Environmental Conditions	Input Power	Tested by
RE \geq 1G	24 deg. C, 66% RH 25 deg. C, 70% RH	120Vac, 60Hz	Raymond Lee Edison Lee
RE<1G	21 deg. C, 65% RH	120Vac, 60Hz	Greg Lin
PLC	25 deg. C, 68% RH 25 deg. C, 75% RH	120Vac, 60Hz	Raymond Lee Hans Wu
APCM	25 deg. C, 60% RH	120Vac, 60Hz	Alan Wu

3.3 Duty Cycle of Test Signal

Duty cycle of test signal is < 98%, duty factor is required.

802.11a: Duty cycle = 1.973/2.137 = 0.923, Duty factor = $10 * \log(1/0.923) = 0.35$

802.11ax (HE20): Duty cycle = 5.400/5.945 = 0.908, Duty factor = $10 * \log(1/0.908) = 0.42$

802.11ax (HE40): Duty cycle = 5.41/5.955 = 0.908, Duty factor = $10 * \log(1/0.908) = 0.42$

802.11ax (HE80): Duty cycle = 5.42/5.96 = 0.909, Duty factor = $10 * \log(1/0.909) = 0.41$

802.11ax (HE160): Duty cycle = 5.42/6.00 = 0.903, Duty factor = $10 * \log(1/0.903) = 0.44$



3.4 Description of Support Units

The EUT has been tested as an independent unit together with other necessary accessories or support units. The following support units or accessories were used to form a representative test configuration during the tests.

ID	Product	Brand	Model No.	Serial No.	FCC ID	Remarks
A.	Notebook	Lenovo	20J4 MD A003TW	PF-11H9AK	FCC DoC Approved	-
B.	Flash	Transcend	16GB	NA	NA	-
C.	Load	NA	NA	NA	NA	-

Note:

1. All power cords of the above support units are non-shielded (1.8m).
2. Item A acted as a communication partner to transfer data.

ID	Cable Descriptions	Qty.	Length (m)	Shielding (Yes/No)	Cores (Qty.)	Remarks
1.	LAN cable	1	1	N	0	RJ45, Cat5e, Accessory
2.	LAN cable	1	10	N	0	RJ45, Cat5e
3.	LAN cable	4	1.5	N	0	RJ45, Cat5e

3.4.1 Configuration of System under Test

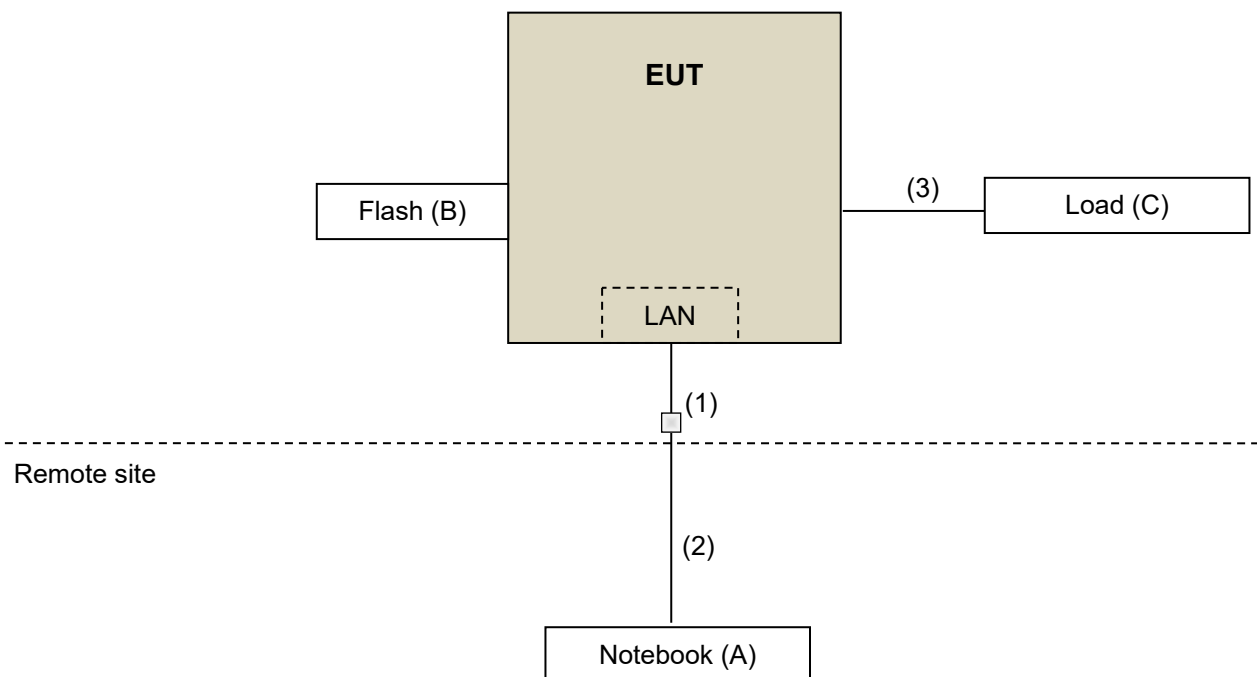

3.5 General Description of Applied Standards and References

The EUT is a RF Product. According to the specifications of the manufacturer, it must comply with the requirements of the following standards and references:

Test standard:

FCC Part 15, Subpart E (15.407)

ANSI C63.10:2013

All test items have been performed and recorded as per the above standards.

KDB References Test Guidance:

KDB 789033 D02 General UNII Test Procedure New Rules v02r01

KDB 662911 D01 Multiple Transmitter Output v02r01

All test items have been performed as a reference to the above KDB test guidance.

4 Test Types and Results

4.1 Radiated Emission and Bandedge Measurement

4.1.1 Limits of Radiated Emission and Bandedge Measurement

Radiated emissions which fall in the restricted bands must comply with the radiated emission limits specified as below table.

Frequencies (MHz)	Field Strength (microvolts/meter)	Measurement Distance (meters)
0.009 ~ 0.490	2400/F(kHz)	300
0.490 ~ 1.705	24000/F(kHz)	30
1.705 ~ 30.0	30	30
30 ~ 88	100	3
88 ~ 216	150	3
216 ~ 960	200	3
Above 960	500	3

Note:

1. The lower limit shall apply at the transition frequencies.
2. Emission level (dBuV/m) = 20 log Emission level (uV/m).
3. For frequencies above 1000MHz, the field strength limits are based on average detector, however, the peak field strength of any emission shall not exceed the maximum permitted average limits, specified above by more than 20dB under any condition of modulation.

Limits of unwanted emission out of the restricted bands

Applicable To		Limit	
789033 D02 General UNII Test Procedure New Rules v02r01		Field Strength at 3m	
		PK: 74 (dBµV/m)	AV: 54 (dBµV/m)
Frequency Band	Applicable To	EIRP Limit	Equivalent Field Strength at 3m
5150~5250 MHz	15.407(b)(1)	PK: -27 (dBm/MHz)	PK: 68.2(dBµV/m)
5250~5350 MHz	15.407(b)(2)		
5470~5725 MHz	15.407(b)(3)		
5725~5850 MHz	<input checked="" type="checkbox"/> 15.407(b)(4)(i)	PK: -27 (dBm/MHz) ^{*1} PK: 10 (dBm/MHz) ^{*2} PK: 15.6 (dBm/MHz) ^{*3} PK: 27 (dBm/MHz) ^{*4}	PK: 68.2(dBµV/m) ^{*1} PK: 105.2 (dBµV/m) ^{*2} PK: 110.8(dBµV/m) ^{*3} PK: 122.2 (dBµV/m) ^{*4}
	<input type="checkbox"/> 15.407(b)(4)(ii)	Emission limits in section 15.247(d)	
^{*1} beyond 75 MHz or more above of the band edge.		^{*2} below the band edge increasing linearly to 10 dBm/MHz at 25 MHz above.	
^{*3} below the band edge increasing linearly to a level of 15.6 dBm/MHz at 5 MHz above.		^{*4} from 5 MHz above or below the band edge increasing linearly to a level of 27 dBm/MHz at the band edge.	

Note: The following formula is used to convert the equipment isotropic radiated power (eirp) to field strength:

$$E = \frac{1000000\sqrt{30P}}{3} \mu\text{V/m, where P is the eirp (Watts).}$$

4.1.2 Test Instruments

Description & Manufacturer	Model No.	Serial No.	Cal. Date	Cal. Due
Test Receiver Rohde & Schwarz	ESR3	102783	Dec. 21, 2020	Dec. 20, 2021
Spectrum Analyzer KEYSIGHT	N9020B	MY60110513	Dec. 21, 2020	Dec. 20, 2021
BILOG Antenna SCHWARZBECK	VULB9168	1214	Nov. 04, 2020	Nov. 03, 2021
			Oct. 28, 2021	Oct. 27, 2022
HORN Antenna SCHWARZBECK	BBHA 9120 D	9120D-1170	Nov. 22, 2020	Nov. 21, 2021
HORN Antenna SCHWARZBECK	BBHA 9170	995	Nov. 22, 2020	Nov. 21, 2021
Preamplifier EMCI	EMC330N	980798	Jan. 12, 2021	Jan. 11, 2022
Preamplifier EMCI	EMC118A45SE	980809	Jan. 12, 2021	Jan. 11, 2022
Preamplifier EMCI	EMC184045SE	980786	Jan. 12, 2021	Jan. 11, 2022
RF signal cable EMCI	EMC104-SM-SM-(9000+2000+1000)	201244+ 201232+ 210103	Jan. 12, 2021	Jan. 11, 2022
RF signal cable EMCI	EMCCFD400-NM-NM-(9000+300+500)	201251+ 201249+ 201248	Jan. 12, 2021	Jan. 11, 2022
RF signal cable EMCI	EMC101G-KM-KM-(5000+3000+2000)	201261+201258+201249	Jan. 12, 2021	Jan. 11, 2022
Software BV ADT	ADT_Radiated_V7.6.15.9.5	NA	NA	NA
Antenna Tower Max-Full	MFA-515BSN	NA	NA	NA
Turn Table Max-Full	MFT-201SS	NA	NA	NA
Turn Table Controller Max-Full	MF-7802BS	MF780208676	NA	NA
Peak Power Analyzer KEYSIGHT	8990B	MY51000485	Jan. 19, 2021	Jan. 18, 2022
Wideband Power Sensor KEYSIGHT	N1923A	MY58020002	Jan. 11, 2021	Jan. 10, 2022

- Note: 1. The calibration interval of the above test instruments is 12 months and the calibrations are traceable to NML/ROC and NIST/USA.
 2. The test was performed in WM Chamber 9.

4.1.3 Test Procedures

For Radiated emission below 30MHz

- a. The EUT was placed on the top of a rotating table 0.8 meters above the ground at a 3 meter chamber room. The table was rotated 360 degrees to determine the position of the highest radiation.
- b. The EUT was set 3 meters away from the interference-receiving antenna, which was mounted on the top of a variable-height antenna tower.
- c. Parallel, perpendicular, and ground-parallel orientations of the antenna are set to make the measurement.
- d. For each suspected emission, the EUT was arranged to its worst case and the rotatable table was turned from 0 degrees to 360 degrees to find the maximum reading.
- e. The test-receiver system was set to Quasi-Peak Detect Function and Specified Bandwidth with Maximum Hold Mode.

Note:

1. The resolution bandwidth and video bandwidth of test receiver/spectrum analyzer is 9kHz at frequency below 30MHz.

For Radiated emission above 30MHz

- a. The EUT was placed on the top of a rotating table 0.8 meters (for 30MHz ~ 1GHz) / 1.5 meters (for above 1GHz) above the ground at 3 meter chamber room for test. The table was rotated 360 degrees to determine the position of the highest radiation.
- b. The EUT was set 3 meters away from the interference-receiving antenna, which was mounted on the top of a variable-height antenna tower.
- c. The height of antenna is varied from one meter to four meters above the ground to determine the maximum value of the field strength. Both horizontal and vertical polarizations of the antenna are set to make the measurement.
- d. For each suspected emission, the EUT was arranged to its worst case and then the antenna was tuned to heights from 1 meter to 4 meters and the rotatable table was turned from 0 degrees to 360 degrees to find the maximum reading.
- e. The test-receiver system was set to quasi-peak detect function and specified bandwidth with maximum hold mode when the test frequency is below 1 GHz.
- f. The test-receiver system was set to peak and average detect function and specified bandwidth with maximum hold mode when the test frequency is above 1 GHz. If the peak reading value also meets average limit, measurement with the average detector is unnecessary.

Note:

1. The resolution bandwidth and video bandwidth of test receiver/spectrum analyzer is 120kHz for Quasi-peak detection (QP) at frequency below 1GHz.
2. The resolution bandwidth of test receiver/spectrum analyzer is 1 MHz and the video bandwidth is 3 MHz for Peak detection (PK) at frequency above 1GHz.
3. The resolution bandwidth of test receiver/spectrum analyzer is 1MHz and the video bandwidth is $\geq 1/T$ (Duty cycle < 98%) or 10Hz (Duty cycle $\geq 98\%$) for Average detection (AV) at frequency above 1GHz.
(802.11a: RBW = 1MHz, VBW = 3kHz; 802.11ax (HE20): RBW = 1MHz, VBW = 1kHz;
802.11 ax (HE40): RBW = 1MHz, VBW = 1kHz; 802.11 ax (HE80): RBW = 1MHz, VBW = 1kHz;
802.11 ax (HE160): RBW = 1MHz, VBW = 1kHz)
4. All modes of operation were investigated and the worst-case emissions are reported.

4.1.4 Deviation from Test Standard

No deviation.

4.1.5 Test Setup

For Radiated emission below 30MHz

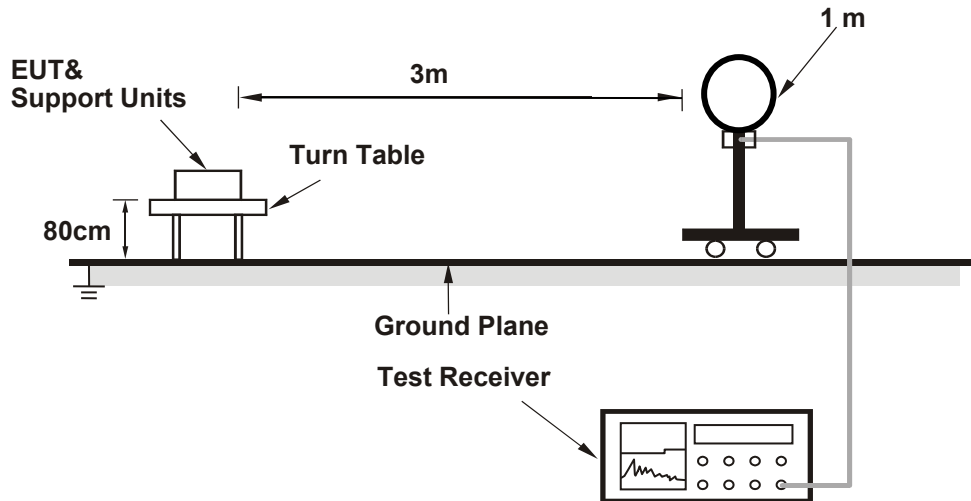

For Radiated emission 30MHz to 1GHz

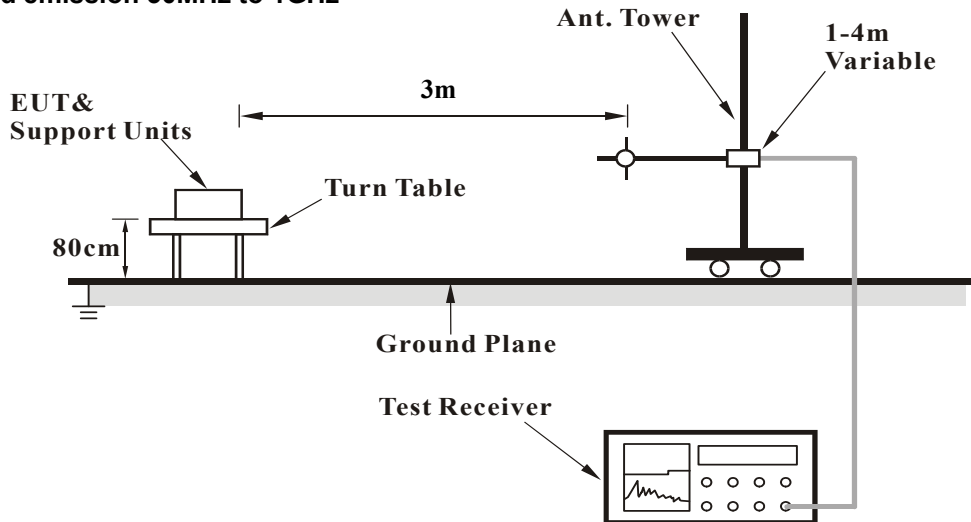

For Radiated emission above 1GHz

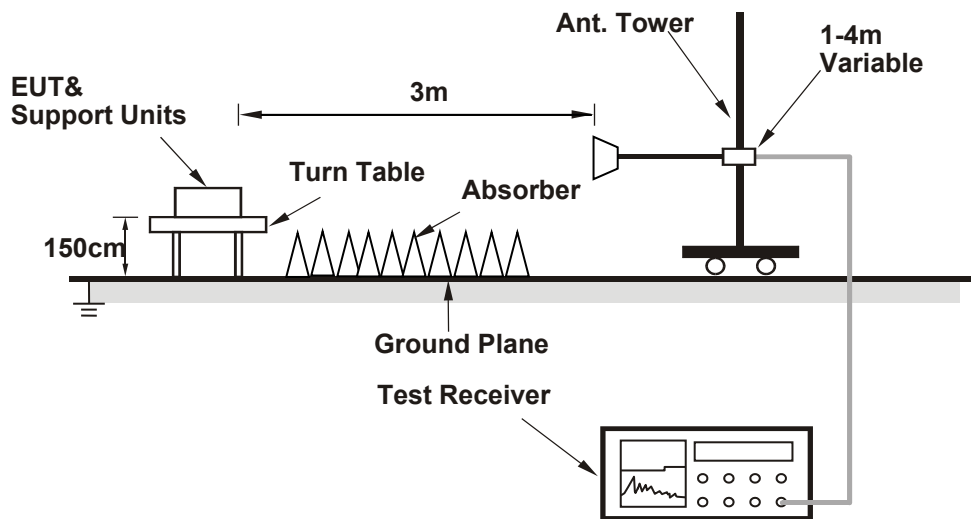

For the actual test configuration, please refer to the attached file (Test Setup Photo).

4.1.6 EUT Operating Conditions

- a. Placed the EUT on the testing table.
- b. Prepared a notebook to act as a communication partner and placed it outside of testing area.
- c. The communication partner connected with EUT via a RJ45 cable and ran a test program (provided by manufacturer) to enable EUT under transmission condition continuously at specific channel frequency.
- d. The communication partner sent data to EUT by command "PING".

4.1.7 Test Results

Above 1GHz data:

RF Mode	TX 802.11a	Channel	CH 36 : 5180 MHz
Frequency Range	1GHz ~ 40GHz	Detector Function	Peak (PK) Average (AV)

Antenna Polarity & Test Distance : Horizontal at 3 m								
No	Frequency (MHz)	Emission Level (dBuV/m)	Limit (dBuV/m)	Margin (dB)	Antenna Height (m)	Table Angle (Degree)	Raw Value (dBuV)	Correction Factor (dB/m)
1	5040.00	58.6 PK	74.0	-15.4	2.65 H	332	56.4	2.2
2	5040.00	47.0 AV	54.0	-7.0	2.65 H	332	44.8	2.2
3	5150.00	57.4 PK	74.0	-16.6	2.65 H	332	55.0	2.4
4	5150.00	46.6 AV	54.0	-7.4	2.65 H	332	44.2	2.4
5	*5180.00	112.6 PK			2.65 H	332	72.7	39.9
6	*5180.00	104.1 AV			2.65 H	332	64.2	39.9
7	#10360.00	55.2 PK	68.2	-13.0	3.01 H	127	47.2	8.0
Antenna Polarity & Test Distance : Vertical at 3 m								
No	Frequency (MHz)	Emission Level (dBuV/m)	Limit (dBuV/m)	Margin (dB)	Antenna Height (m)	Table Angle (Degree)	Raw Value (dBuV)	Correction Factor (dB/m)
1	5040.00	61.5 PK	74.0	-12.5	1.56 V	195	59.3	2.2
2	5040.00	53.0 AV	54.0	-1.0	1.56 V	195	50.8	2.2
3	5150.00	60.5 PK	74.0	-13.5	1.56 V	195	58.1	2.4
4	5150.00	52.3 AV	54.0	-1.7	1.56 V	195	49.9	2.4
5	*5180.00	121.8 PK			1.56 V	195	81.9	39.9
6	*5180.00	113.5 AV			1.56 V	195	73.6	39.9
7	#10360.00	55.5 PK	68.2	-12.7	1.00 V	304	47.5	8.0

Remarks:

1. Emission Level(dBuV/m) = Raw Value(dBuV) + Correction Factor(dB/m).
2. Correction Factor(dB/m) = Antenna Factor(dB/m) + Cable Factor(dB) – Pre-Amplifier Factor(dB).
3. Margin value = Emission Level – Limit value.
4. The other emission levels were very low against the limit.
5. " * ": Fundamental frequency.
6. " # ": The radiated frequency is out of the restricted band.

RF Mode	TX 802.11a	Channel	CH 40 : 5200 MHz
Frequency Range	1GHz ~ 40GHz	Detector Function	Peak (PK) Average (AV)

Antenna Polarity & Test Distance : Horizontal at 3 m								
No	Frequency (MHz)	Emission Level (dBuV/m)	Limit (dBuV/m)	Margin (dB)	Antenna Height (m)	Table Angle (Degree)	Raw Value (dBuV)	Correction Factor (dB/m)
1	5040.00	56.8 PK	74.0	-17.2	2.25 H	332	54.6	2.2
2	5040.00	45.6 AV	54.0	-8.4	2.25 H	332	43.4	2.2
3	*5200.00	113.0 PK			2.25 H	332	73.1	39.9
4	*5200.00	104.3 AV			2.25 H	332	64.4	39.9
5	#10400.00	54.8 PK	68.2	-13.4	3.04 H	130	46.7	8.1

Antenna Polarity & Test Distance : Vertical at 3 m								
No	Frequency (MHz)	Emission Level (dBuV/m)	Limit (dBuV/m)	Margin (dB)	Antenna Height (m)	Table Angle (Degree)	Raw Value (dBuV)	Correction Factor (dB/m)
1	5040.00	60.5 PK	74.0	-13.5	1.55 V	195	58.3	2.2
2	5040.00	50.7 AV	54.0	-3.3	1.55 V	195	48.5	2.2
3	*5200.00	122.0 PK			1.55 V	195	82.1	39.9
4	*5200.00	113.7 AV			1.55 V	195	73.8	39.9
5	#10400.00	54.7 PK	68.2	-13.5	1.02 V	358	46.6	8.1

Remarks:

1. Emission Level(dBuV/m) = Raw Value(dBuV) + Correction Factor(dB/m).
2. Correction Factor(dB/m) = Antenna Factor(dB/m) + Cable Factor(dB) – Pre-Amplifier Factor(dB).
3. Margin value = Emission Level – Limit value.
4. The other emission levels were very low against the limit.
5. " * ": Fundamental frequency.
6. " # ": The radiated frequency is out of the restricted band.

RF Mode	TX 802.11a	Channel	CH 48 : 5240 MHz
Frequency Range	1GHz ~ 40GHz	Detector Function	Peak (PK) Average (AV)

Antenna Polarity & Test Distance : Horizontal at 3 m								
No	Frequency (MHz)	Emission Level (dBuV/m)	Limit (dBuV/m)	Margin (dB)	Antenna Height (m)	Table Angle (Degree)	Raw Value (dBuV)	Correction Factor (dB/m)
1	5040.00	57.3 PK	74.0	-16.7	2.47 H	333	55.1	2.2
2	5040.00	45.9 AV	54.0	-8.1	2.47 H	333	43.7	2.2
3	*5240.00	112.7 PK			2.47 H	333	72.8	39.9
4	*5240.00	104.2 AV			2.47 H	333	64.3	39.9
5	5350.00	57.2 PK	74.0	-16.8	2.47 H	333	55.2	2.0
6	5350.00	45.5 AV	54.0	-8.5	2.47 H	333	43.5	2.0
7	#10480.00	54.4 PK	68.2	-13.8	3.03 H	128	46.6	7.8

Antenna Polarity & Test Distance : Vertical at 3 m								
No	Frequency (MHz)	Emission Level (dBuV/m)	Limit (dBuV/m)	Margin (dB)	Antenna Height (m)	Table Angle (Degree)	Raw Value (dBuV)	Correction Factor (dB/m)
1	5040.00	59.3 PK	74.0	-14.7	1.83 V	161	57.1	2.2
2	5040.00	49.9 AV	54.0	-4.1	1.83 V	161	47.7	2.2
3	*5240.00	122.1 PK			1.83 V	161	82.2	39.9
4	*5240.00	114.2 AV			1.83 V	161	74.3	39.9
5	5350.00	60.5 PK	74.0	-13.5	1.83 V	161	58.5	2.0
6	5350.00	52.2 AV	54.0	-1.8	1.83 V	161	50.2	2.0
7	#10480.00	55.1 PK	68.2	-13.1	1.15 V	318	47.3	7.8

Remarks:

1. Emission Level(dBuV/m) = Raw Value(dBuV) + Correction Factor(dB/m).
2. Correction Factor(dB/m) = Antenna Factor(dB/m) + Cable Factor(dB) – Pre-Amplifier Factor(dB).
3. Margin value = Emission Level – Limit value.
4. The other emission levels were very low against the limit.
5. " * " : Fundamental frequency.
6. " # " : The radiated frequency is out of the restricted band.

RF Mode	TX 802.11a	Channel	CH 52 : 5260 MHz
Frequency Range	1GHz ~ 40GHz	Detector Function	Peak (PK) Average (AV)

Antenna Polarity & Test Distance : Horizontal at 3 m								
No	Frequency (MHz)	Emission Level (dBuV/m)	Limit (dBuV/m)	Margin (dB)	Antenna Height (m)	Table Angle (Degree)	Raw Value (dBuV)	Correction Factor (dB/m)
1	5040.00	56.9 PK	74.0	-17.1	2.75 H	333	54.7	2.2
2	5040.00	45.9 AV	54.0	-8.1	2.75 H	333	43.7	2.2
3	5150.00	57.9 PK	74.0	-16.1	2.75 H	333	55.5	2.4
4	5150.00	45.7 AV	54.0	-8.3	2.75 H	333	43.3	2.4
5	*5260.00	110.1 PK			2.75 H	333	70.2	39.9
6	*5260.00	101.4 AV			2.75 H	333	61.5	39.9
7	#10520.00	54.9 PK	68.2	-13.3	3.07 H	137	47.2	7.7

Antenna Polarity & Test Distance : Vertical at 3 m								
No	Frequency (MHz)	Emission Level (dBuV/m)	Limit (dBuV/m)	Margin (dB)	Antenna Height (m)	Table Angle (Degree)	Raw Value (dBuV)	Correction Factor (dB/m)
1	5040.00	58.2 PK	74.0	-15.8	1.82 V	178	56.0	2.2
2	5040.00	48.2 AV	54.0	-5.8	1.82 V	178	46.0	2.2
3	5150.00	56.9 PK	74.0	-17.1	1.82 V	178	54.5	2.4
4	5150.00	46.1 AV	54.0	-7.9	1.82 V	178	43.7	2.4
5	*5260.00	119.0 PK			1.86 V	173	79.1	39.9
6	*5260.00	110.9 AV			1.86 V	173	71.0	39.9
7	#10520.00	55.7 PK	68.2	-12.5	1.04 V	300	48.0	7.7

Remarks:

1. Emission Level(dBuV/m) = Raw Value(dBuV) + Correction Factor(dB/m).
2. Correction Factor(dB/m) = Antenna Factor(dB/m) + Cable Factor(dB) – Pre-Amplifier Factor(dB).
3. Margin value = Emission Level – Limit value.
4. The other emission levels were very low against the limit.
5. " * " : Fundamental frequency.
6. " # " : The radiated frequency is out of the restricted band.

RF Mode	TX 802.11a	Channel	CH 60 : 5300 MHz
Frequency Range	1GHz ~ 40GHz	Detector Function	Peak (PK) Average (AV)

Antenna Polarity & Test Distance : Horizontal at 3 m								
No	Frequency (MHz)	Emission Level (dBuV/m)	Limit (dBuV/m)	Margin (dB)	Antenna Height (m)	Table Angle (Degree)	Raw Value (dBuV)	Correction Factor (dB/m)
1	5040.00	57.3 PK	74.0	-16.7	1.81 H	335	55.1	2.2
2	5040.00	47.2 AV	54.0	-6.8	1.81 H	335	45.0	2.2
3	*5300.00	109.5 PK			1.81 H	335	69.6	39.9
4	*5300.00	100.8 AV			1.81 H	335	60.9	39.9
5	10600.00	54.5 PK	74.0	-19.5	3.10 H	132	46.7	7.8
6	10600.00	44.0 AV	54.0	-10.0	3.10 H	132	36.2	7.8

Antenna Polarity & Test Distance : Vertical at 3 m								
No	Frequency (MHz)	Emission Level (dBuV/m)	Limit (dBuV/m)	Margin (dB)	Antenna Height (m)	Table Angle (Degree)	Raw Value (dBuV)	Correction Factor (dB/m)
1	5040.00	60.6 PK	74.0	-13.4	1.51 V	160	58.4	2.2
2	5040.00	50.6 AV	54.0	-3.4	1.51 V	160	48.4	2.2
3	*5300.00	119.6 PK			1.51 V	160	79.7	39.9
4	*5300.00	111.4 AV			1.51 V	160	71.5	39.9
5	10600.00	54.9 PK	74.0	-19.1	1.02 V	310	47.1	7.8
6	10600.00	45.3 AV	54.0	-8.7	1.02 V	310	37.5	7.8

Remarks:

1. Emission Level(dBuV/m) = Raw Value(dBuV) + Correction Factor(dB/m).
2. Correction Factor(dB/m) = Antenna Factor(dB/m) + Cable Factor(dB) – Pre-Amplifier Factor(dB).
3. Margin value = Emission Level – Limit value.
4. The other emission levels were very low against the limit.
5. " * ": Fundamental frequency.

RF Mode	TX 802.11a	Channel	CH 64 : 5320 MHz
Frequency Range	1GHz ~ 40GHz	Detector Function	Peak (PK) Average (AV)

Antenna Polarity & Test Distance : Horizontal at 3 m								
No	Frequency (MHz)	Emission Level (dBuV/m)	Limit (dBuV/m)	Margin (dB)	Antenna Height (m)	Table Angle (Degree)	Raw Value (dBuV)	Correction Factor (dB/m)
1	5040.00	58.2 PK	74.0	-15.8	3.11 H	323	56.0	2.2
2	5040.00	46.2 AV	54.0	-7.8	3.11 H	323	44.0	2.2
3	*5320.00	107.8 PK			3.11 H	323	68.0	39.8
4	*5320.00	99.5 AV			3.11 H	323	59.7	39.8
5	5350.00	55.6 PK	74.0	-18.4	3.11 H	323	53.6	2.0
6	5350.00	45.2 AV	54.0	-8.8	3.11 H	323	43.2	2.0
7	10640.00	55.2 PK	74.0	-18.8	3.08 H	123	47.2	8.0
8	10640.00	44.4 AV	54.0	-9.6	3.08 H	123	36.4	8.0
Antenna Polarity & Test Distance : Vertical at 3 m								
No	Frequency (MHz)	Emission Level (dBuV/m)	Limit (dBuV/m)	Margin (dB)	Antenna Height (m)	Table Angle (Degree)	Raw Value (dBuV)	Correction Factor (dB/m)
1	5040.00	59.7 PK	74.0	-14.3	1.72 V	177	57.5	2.2
2	5040.00	49.5 AV	54.0	-4.5	1.72 V	177	47.3	2.2
3	*5320.00	120.2 PK			1.72 V	177	80.4	39.8
4	*5320.00	111.8 AV			1.72 V	177	72.0	39.8
5	5350.00	58.8 PK	74.0	-15.2	1.72 V	177	56.8	2.0
6	5350.00	46.8 AV	54.0	-7.2	1.72 V	177	44.8	2.0
7	10640.00	55.4 PK	74.0	-18.6	1.03 V	297	47.4	8.0
8	10640.00	44.6 AV	54.0	-9.4	1.03 V	297	36.6	8.0

Remarks:

1. Emission Level(dBuV/m) = Raw Value(dBuV) + Correction Factor(dB/m).
2. Correction Factor(dB/m) = Antenna Factor(dB/m) + Cable Factor(dB) – Pre-Amplifier Factor(dB).
3. Margin value = Emission Level – Limit value.
4. The other emission levels were very low against the limit.
5. " * " : Fundamental frequency.

RF Mode	TX 802.11a	Channel	CH 100 : 5500 MHz
Frequency Range	1GHz ~ 40GHz	Detector Function	Peak (PK) Average (AV)

Antenna Polarity & Test Distance : Horizontal at 3 m								
No	Frequency (MHz)	Emission Level (dBuV/m)	Limit (dBuV/m)	Margin (dB)	Antenna Height (m)	Table Angle (Degree)	Raw Value (dBuV)	Correction Factor (dB/m)
1	5460.00	57.5 PK	74.0	-16.5	2.42 H	335	55.4	2.1
2	5460.00	45.4 AV	54.0	-8.6	2.42 H	335	43.3	2.1
3	#5470.00	57.8 PK	68.2	-10.4	2.42 H	335	55.7	2.1
4	*5500.00	107.5 PK			2.42 H	335	67.2	40.3
5	*5500.00	98.9 AV			2.42 H	335	58.6	40.3
6	11000.00	54.0 PK	74.0	-20.0	2.88 H	157	46.5	7.5
7	11000.00	44.1 AV	54.0	-9.9	2.88 H	157	36.6	7.5
Antenna Polarity & Test Distance : Vertical at 3 m								
No	Frequency (MHz)	Emission Level (dBuV/m)	Limit (dBuV/m)	Margin (dB)	Antenna Height (m)	Table Angle (Degree)	Raw Value (dBuV)	Correction Factor (dB/m)
1	5460.00	57.4 PK	74.0	-16.6	1.97 V	157	55.3	2.1
2	5460.00	46.8 AV	54.0	-7.2	1.97 V	157	44.7	2.1
3	#5470.00	58.8 PK	68.2	-9.4	1.97 V	157	56.7	2.1
4	*5500.00	119.1 PK			1.97 V	157	78.8	40.3
5	*5500.00	110.3 AV			1.97 V	157	70.0	40.3
6	11000.00	54.2 PK	74.0	-19.8	1.49 V	326	46.7	7.5
7	11000.00	44.2 AV	54.0	-9.8	1.49 V	326	36.7	7.5

Remarks:

1. Emission Level(dBuV/m) = Raw Value(dBuV) + Correction Factor(dB/m).
2. Correction Factor(dB/m) = Antenna Factor(dB/m) + Cable Factor(dB) – Pre-Amplifier Factor(dB).
3. Margin value = Emission Level – Limit value.
4. The other emission levels were very low against the limit.
5. " * " : Fundamental frequency.
6. " # " : The radiated frequency is out of the restricted band.

RF Mode	TX 802.11a	Channel	CH 116 : 5580 MHz
Frequency Range	1GHz ~ 40GHz	Detector Function	Peak (PK) Average (AV)

Antenna Polarity & Test Distance : Horizontal at 3 m								
No	Frequency (MHz)	Emission Level (dBuV/m)	Limit (dBuV/m)	Margin (dB)	Antenna Height (m)	Table Angle (Degree)	Raw Value (dBuV)	Correction Factor (dB/m)
1	*5580.00	108.2 PK			2.51 H	335	67.7	40.5
2	*5580.00	99.5 AV			2.51 H	335	59.0	40.5
3	11160.00	55.4 PK	74.0	-18.6	2.66 H	168	46.9	8.5
4	11160.00	45.1 AV	54.0	-8.9	2.66 H	168	36.6	8.5
Antenna Polarity & Test Distance : Vertical at 3 m								
No	Frequency (MHz)	Emission Level (dBuV/m)	Limit (dBuV/m)	Margin (dB)	Antenna Height (m)	Table Angle (Degree)	Raw Value (dBuV)	Correction Factor (dB/m)
1	*5580.00	119.1 PK			1.93 V	188	78.6	40.5
2	*5580.00	110.6 AV			1.93 V	188	70.1	40.5
3	11160.00	55.6 PK	74.0	-18.4	1.51 V	318	47.1	8.5
4	11160.00	45.3 AV	54.0	-8.7	1.51 V	318	36.8	8.5

Remarks:

1. Emission Level(dBuV/m) = Raw Value(dBuV) + Correction Factor(dB/m).
2. Correction Factor(dB/m) = Antenna Factor(dB/m) + Cable Factor(dB) – Pre-Amplifier Factor(dB).
3. Margin value = Emission Level – Limit value.
4. The other emission levels were very low against the limit.
5. " * " : Fundamental frequency.

RF Mode	TX 802.11a	Channel	CH 140 : 5700 MHz
Frequency Range	1GHz ~ 40GHz	Detector Function	Peak (PK) Average (AV)

Antenna Polarity & Test Distance : Horizontal at 3 m								
No	Frequency (MHz)	Emission Level (dBuV/m)	Limit (dBuV/m)	Margin (dB)	Antenna Height (m)	Table Angle (Degree)	Raw Value (dBuV)	Correction Factor (dB/m)
1	*5700.00	107.5 PK			2.33 H	349	66.4	41.1
2	*5700.00	98.3 AV			2.33 H	349	57.2	41.1
3	#5725.00	58.2 PK	68.2	-10.0	2.33 H	349	55.0	3.2
4	11400.00	55.1 PK	74.0	-18.9	2.65 H	172	46.7	8.4
5	11400.00	45.0 AV	54.0	-9.0	2.65 H	172	36.6	8.4

Antenna Polarity & Test Distance : Vertical at 3 m								
No	Frequency (MHz)	Emission Level (dBuV/m)	Limit (dBuV/m)	Margin (dB)	Antenna Height (m)	Table Angle (Degree)	Raw Value (dBuV)	Correction Factor (dB/m)
1	*5700.00	119.0 PK			1.71 V	189	77.9	41.1
2	*5700.00	110.6 AV			1.71 V	189	69.5	41.1
3	#5725.00	59.3 PK	68.2	-8.9	1.71 V	189	56.1	3.2
4	11400.00	55.3 PK	74.0	-18.7	1.40 V	322	46.9	8.4
5	11400.00	45.2 AV	54.0	-8.8	1.40 V	322	36.8	8.4

Remarks:

1. Emission Level(dBuV/m) = Raw Value(dBuV) + Correction Factor(dB/m).
2. Correction Factor(dB/m) = Antenna Factor(dB/m) + Cable Factor(dB) – Pre-Amplifier Factor(dB).
3. Margin value = Emission Level – Limit value.
4. The other emission levels were very low against the limit.
5. " * " : Fundamental frequency.
6. " # " : The radiated frequency is out of the restricted band.

RF Mode	TX 802.11a	Channel	CH 149 : 5745 MHz
Frequency Range	1GHz ~ 40GHz	Detector Function	Peak (PK) Average (AV)

Antenna Polarity & Test Distance : Horizontal at 3 m								
No	Frequency (MHz)	Emission Level (dBuV/m)	Limit (dBuV/m)	Margin (dB)	Antenna Height (m)	Table Angle (Degree)	Raw Value (dBuV)	Correction Factor (dB/m)
1	#5649.20	56.8 PK	68.2	-11.4	3.37 H	309	53.9	2.9
2	*5745.00	110.9 PK			3.37 H	309	69.6	41.3
3	*5745.00	102.0 AV			3.37 H	309	60.7	41.3
4	#5948.80	57.2 PK	68.2	-11.0	3.37 H	309	53.6	3.6
5	11490.00	56.3 PK	74.0	-17.7	2.96 H	125	47.8	8.5
6	11490.00	44.7 AV	54.0	-9.3	2.96 H	125	36.2	8.5
7	#17235.00	62.9 PK	68.2	-5.3	3.18 H	186	53.2	9.7

Antenna Polarity & Test Distance : Vertical at 3 m								
No	Frequency (MHz)	Emission Level (dBuV/m)	Limit (dBuV/m)	Margin (dB)	Antenna Height (m)	Table Angle (Degree)	Raw Value (dBuV)	Correction Factor (dB/m)
1	#5637.60	58.4 PK	68.2	-9.8	1.60 V	182	55.5	2.9
2	*5745.00	122.8 PK			1.60 V	182	81.5	41.3
3	*5745.00	114.3 AV			1.60 V	182	73.0	41.3
4	#5939.20	59.0 PK	68.2	-9.2	1.60 V	182	55.5	3.5
5	11490.00	57.3 PK	74.0	-16.7	1.32 V	333	48.8	8.5
6	11490.00	46.6 AV	54.0	-7.4	1.32 V	333	38.1	8.5
7	#17235.00	65.7 PK	68.2	-2.5	1.07 V	279	56.1	9.6

Remarks:

1. Emission Level(dBuV/m) = Raw Value(dBuV) + Correction Factor(dB/m).
2. Correction Factor(dB/m) = Antenna Factor(dB/m) + Cable Factor(dB) – Pre-Amplifier Factor(dB).
3. Margin value = Emission Level – Limit value.
4. The other emission levels were very low against the limit.
5. " * " : Fundamental frequency.
6. " # " : The radiated frequency is out of the restricted band.

RF Mode	TX 802.11a	Channel	CH 157 : 5785 MHz
Frequency Range	1GHz ~ 40GHz	Detector Function	Peak (PK) Average (AV)

Antenna Polarity & Test Distance : Horizontal at 3 m								
No	Frequency (MHz)	Emission Level (dBuV/m)	Limit (dBuV/m)	Margin (dB)	Antenna Height (m)	Table Angle (Degree)	Raw Value (dBuV)	Correction Factor (dB/m)
1	#5642.00	57.1 PK	68.2	-11.1	2.47 H	344	54.2	2.9
2	*5785.00	113.0 PK			2.47 H	344	71.5	41.5
3	*5785.00	104.8 AV			2.47 H	344	63.3	41.5
4	#5928.80	57.9 PK	68.2	-10.3	2.47 H	344	54.4	3.5
5	11570.00	56.3 PK	74.0	-17.7	2.79 H	143	47.5	8.8
6	11570.00	45.9 AV	54.0	-8.1	2.79 H	143	37.1	8.8
7	#17355.00	64.7 PK	68.2	-3.5	2.99 H	193	54.6	10.1

Antenna Polarity & Test Distance : Vertical at 3 m								
No	Frequency (MHz)	Emission Level (dBuV/m)	Limit (dBuV/m)	Margin (dB)	Antenna Height (m)	Table Angle (Degree)	Raw Value (dBuV)	Correction Factor (dB/m)
1	#5600.80	58.1 PK	68.2	-10.1	1.46 V	165	55.5	2.6
2	*5785.00	122.6 PK			1.46 V	165	81.1	41.5
3	*5785.00	114.5 AV			1.46 V	165	73.0	41.5
4	#5975.60	61.4 PK	68.2	-6.8	1.46 V	165	57.8	3.6
5	11570.00	56.8 PK	74.0	-17.2	1.34 V	321	48.0	8.8
6	11570.00	46.4 AV	54.0	-7.6	1.34 V	321	37.6	8.8
7	#17355.00	65.4 PK	68.2	-2.8	1.00 V	279	55.3	10.1

Remarks:

1. Emission Level(dBuV/m) = Raw Value(dBuV) + Correction Factor(dB/m).
2. Correction Factor(dB/m) = Antenna Factor(dB/m) + Cable Factor(dB) – Pre-Amplifier Factor(dB).
3. Margin value = Emission Level – Limit value.
4. The other emission levels were very low against the limit.
5. " * " : Fundamental frequency.
6. " # " : The radiated frequency is out of the restricted band.

RF Mode	TX 802.11a	Channel	CH 165 : 5825 MHz
Frequency Range	1GHz ~ 40GHz	Detector Function	Peak (PK) Average (AV)

Antenna Polarity & Test Distance : Horizontal at 3 m								
No	Frequency (MHz)	Emission Level (dBuV/m)	Limit (dBuV/m)	Margin (dB)	Antenna Height (m)	Table Angle (Degree)	Raw Value (dBuV)	Correction Factor (dB/m)
1	#5613.60	57.5 PK	68.2	-10.7	2.49 H	344	54.8	2.7
2	*5825.00	112.5 PK			2.49 H	344	70.9	41.6
3	*5825.00	104.2 AV			2.49 H	344	62.6	41.6
4	#5944.80	58.3 PK	68.2	-9.9	2.49 H	344	54.8	3.5
5	11650.00	56.2 PK	74.0	-17.8	3.77 H	132	47.4	8.8
6	11650.00	46.1 AV	54.0	-7.9	3.77 H	132	37.3	8.8
7	#17475.00	63.5 PK	68.2	-4.7	3.26 H	191	53.3	10.2
Antenna Polarity & Test Distance : Vertical at 3 m								
No	Frequency (MHz)	Emission Level (dBuV/m)	Limit (dBuV/m)	Margin (dB)	Antenna Height (m)	Table Angle (Degree)	Raw Value (dBuV)	Correction Factor (dB/m)
1	#5632.00	59.6 PK	68.2	-8.6	1.40 V	176	56.8	2.8
2	*5825.00	123.0 PK			1.40 V	176	81.4	41.6
3	*5825.00	114.3 AV			1.40 V	176	72.7	41.6
4	#5971.60	59.0 PK	68.2	-9.2	1.40 V	176	55.4	3.6
5	11650.00	56.7 PK	74.0	-17.3	1.40 V	329	47.9	8.8
6	11650.00	46.8 AV	54.0	-7.2	1.40 V	329	38.0	8.8
7	#17475.00	64.9 PK	68.2	-3.3	1.00 V	279	54.7	10.2

Remarks:

1. Emission Level(dBuV/m) = Raw Value(dBuV) + Correction Factor(dB/m).
2. Correction Factor(dB/m) = Antenna Factor(dB/m) + Cable Factor(dB) – Pre-Amplifier Factor(dB).
3. Margin value = Emission Level – Limit value.
4. The other emission levels were very low against the limit.
5. " * " : Fundamental frequency.
6. " # " : The radiated frequency is out of the restricted band.

RF Mode	TX 802.11ax (HE20)	Channel	CH 36 : 5180 MHz
Frequency Range	1GHz ~ 40GHz	Detector Function	Peak (PK) Average (AV)

Antenna Polarity & Test Distance : Horizontal at 3 m								
No	Frequency (MHz)	Emission Level (dBuV/m)	Limit (dBuV/m)	Margin (dB)	Antenna Height (m)	Table Angle (Degree)	Raw Value (dBuV)	Correction Factor (dB/m)
1	5040.00	56.4 PK	74.0	-17.6	2.67 H	333	54.2	2.2
2	5040.00	45.4 AV	54.0	-8.6	2.67 H	333	43.2	2.2
3	5150.00	56.6 PK	74.0	-17.4	2.67 H	333	54.2	2.4
4	5150.00	46.3 AV	54.0	-7.7	2.67 H	333	43.9	2.4
5	*5180.00	112.0 PK			2.67 H	333	72.1	39.9
6	*5180.00	102.4 AV			2.67 H	333	62.5	39.9
7	#10360.00	55.2 PK	68.2	-13.0	3.04 H	122	47.2	8.0

Antenna Polarity & Test Distance : Vertical at 3 m								
No	Frequency (MHz)	Emission Level (dBuV/m)	Limit (dBuV/m)	Margin (dB)	Antenna Height (m)	Table Angle (Degree)	Raw Value (dBuV)	Correction Factor (dB/m)
1	5040.00	60.7 PK	74.0	-13.3	1.68 V	157	58.5	2.2
2	5040.00	50.8 AV	54.0	-3.2	1.68 V	157	48.6	2.2
3	5150.00	61.1 PK	74.0	-12.9	1.68 V	157	58.7	2.4
4	5150.00	51.7 AV	54.0	-2.3	1.68 V	157	49.3	2.4
5	*5180.00	120.2 PK			1.68 V	157	80.3	39.9
6	*5180.00	112.1 AV			1.68 V	157	72.2	39.9
7	#10360.00	55.0 PK	68.2	-13.2	1.05 V	312	47.0	8.0

Remarks:

1. Emission Level(dBuV/m) = Raw Value(dBuV) + Correction Factor(dB/m).
2. Correction Factor(dB/m) = Antenna Factor(dB/m) + Cable Factor(dB) – Pre-Amplifier Factor(dB).
3. Margin value = Emission Level – Limit value.
4. The other emission levels were very low against the limit.
5. " * " : Fundamental frequency.
6. " # " : The radiated frequency is out of the restricted band.

RF Mode	TX 802.11ax (HE20)	Channel	CH 40 : 5200 MHz
Frequency Range	1GHz ~ 40GHz	Detector Function	Peak (PK) Average (AV)

Antenna Polarity & Test Distance : Horizontal at 3 m								
No	Frequency (MHz)	Emission Level (dBuV/m)	Limit (dBuV/m)	Margin (dB)	Antenna Height (m)	Table Angle (Degree)	Raw Value (dBuV)	Correction Factor (dB/m)
1	5040.00	56.7 PK	74.0	-17.3	2.37 H	333	54.5	2.2
2	5040.00	45.5 AV	54.0	-8.5	2.37 H	333	43.3	2.2
3	*5200.00	112.8 PK			2.37 H	333	72.9	39.9
4	*5200.00	104.0 AV			2.37 H	333	64.1	39.9
5	#10400.00	55.4 PK	68.2	-12.8	3.05 H	121	47.3	8.1

Antenna Polarity & Test Distance : Vertical at 3 m								
No	Frequency (MHz)	Emission Level (dBuV/m)	Limit (dBuV/m)	Margin (dB)	Antenna Height (m)	Table Angle (Degree)	Raw Value (dBuV)	Correction Factor (dB/m)
1	5040.00	59.2 PK	74.0	-14.8	1.75 V	176	57.0	2.2
2	5040.00	49.8 AV	54.0	-4.2	1.75 V	176	47.6	2.2
3	*5200.00	122.7 PK			1.75 V	176	82.8	39.9
4	*5200.00	114.3 AV			1.75 V	176	74.4	39.9
5	#10400.00	55.1 PK	68.2	-13.1	1.07 V	302	47.0	8.1

Remarks:

1. Emission Level(dBuV/m) = Raw Value(dBuV) + Correction Factor(dB/m).
2. Correction Factor(dB/m) = Antenna Factor(dB/m) + Cable Factor(dB) – Pre-Amplifier Factor(dB).
3. Margin value = Emission Level – Limit value.
4. The other emission levels were very low against the limit.
5. " * ": Fundamental frequency.
6. " # ": The radiated frequency is out of the restricted band.

RF Mode	TX 802.11ax (HE20)	Channel	CH 48 : 5240 MHz
Frequency Range	1GHz ~ 40GHz	Detector Function	Peak (PK) Average (AV)

Antenna Polarity & Test Distance : Horizontal at 3 m								
No	Frequency (MHz)	Emission Level (dBuV/m)	Limit (dBuV/m)	Margin (dB)	Antenna Height (m)	Table Angle (Degree)	Raw Value (dBuV)	Correction Factor (dB/m)
1	5040.00	56.5 PK	74.0	-17.5	2.56 H	334	54.3	2.2
2	5040.00	45.6 AV	54.0	-8.4	2.56 H	334	43.4	2.2
3	*5240.00	112.3 PK			2.56 H	334	72.4	39.9
4	*5240.00	102.6 AV			2.56 H	334	62.7	39.9
5	5350.00	53.6 PK	74.0	-20.4	2.56 H	334	51.6	2.0
6	5350.00	43.5 AV	54.0	-10.5	2.56 H	334	41.5	2.0
7	#10480.00	54.5 PK	68.2	-13.7	2.98 H	125	46.7	7.8

Antenna Polarity & Test Distance : Vertical at 3 m								
No	Frequency (MHz)	Emission Level (dBuV/m)	Limit (dBuV/m)	Margin (dB)	Antenna Height (m)	Table Angle (Degree)	Raw Value (dBuV)	Correction Factor (dB/m)
1	5040.00	60.3 PK	74.0	-13.7	1.74 V	176	58.1	2.2
2	5040.00	49.9 AV	54.0	-4.1	1.74 V	176	47.7	2.2
3	*5240.00	122.3 PK			1.74 V	176	82.4	39.9
4	*5240.00	114.5 AV			1.74 V	176	74.6	39.9
5	5350.00	60.3 PK	74.0	-13.7	1.74 V	176	58.3	2.0
6	5350.00	51.0 AV	54.0	-3.0	1.74 V	176	49.0	2.0
7	#10480.00	55.4 PK	68.2	-12.8	1.01 V	316	47.6	7.8

Remarks:

1. Emission Level(dBuV/m) = Raw Value(dBuV) + Correction Factor(dB/m).
2. Correction Factor(dB/m) = Antenna Factor(dB/m) + Cable Factor(dB) – Pre-Amplifier Factor(dB).
3. Margin value = Emission Level – Limit value.
4. The other emission levels were very low against the limit.
5. " * " : Fundamental frequency.
6. " # " : The radiated frequency is out of the restricted band.

RF Mode	TX 802.11ax (HE20)	Channel	CH 52 : 5260 MHz
Frequency Range	1GHz ~ 40GHz	Detector Function	Peak (PK) Average (AV)

Antenna Polarity & Test Distance : Horizontal at 3 m								
No	Frequency (MHz)	Emission Level (dBuV/m)	Limit (dBuV/m)	Margin (dB)	Antenna Height (m)	Table Angle (Degree)	Raw Value (dBuV)	Correction Factor (dB/m)
1	5040.00	56.8 PK	74.0	-17.2	2.59 H	330	54.6	2.2
2	5040.00	45.5 AV	54.0	-8.5	2.59 H	330	43.3	2.2
3	5150.00	56.1 PK	74.0	-17.9	2.59 H	330	53.7	2.4
4	5150.00	45.3 AV	54.0	-8.7	2.59 H	330	42.9	2.4
5	*5260.00	108.6 PK			2.59 H	330	68.7	39.9
6	*5260.00	100.2 AV			2.59 H	330	60.3	39.9
7	#10520.00	54.6 PK	68.2	-13.6	2.85 H	150	46.9	7.7
Antenna Polarity & Test Distance : Vertical at 3 m								
No	Frequency (MHz)	Emission Level (dBuV/m)	Limit (dBuV/m)	Margin (dB)	Antenna Height (m)	Table Angle (Degree)	Raw Value (dBuV)	Correction Factor (dB/m)
1	5040.00	60.5 PK	74.0	-13.5	1.46 V	170	58.3	2.2
2	5040.00	50.9 AV	54.0	-3.1	1.46 V	170	48.7	2.2
3	5150.00	58.6 PK	74.0	-15.4	1.46 V	170	56.2	2.4
4	5150.00	46.1 AV	54.0	-7.9	1.46 V	170	43.7	2.4
5	*5260.00	119.7 PK			1.46 V	170	79.8	39.9
6	*5260.00	110.1 AV			1.46 V	170	70.2	39.9
7	#10520.00	54.2 PK	68.2	-14.0	1.35 V	315	46.5	7.7

Remarks:

1. Emission Level(dBuV/m) = Raw Value(dBuV) + Correction Factor(dB/m).
2. Correction Factor(dB/m) = Antenna Factor(dB/m) + Cable Factor(dB) – Pre-Amplifier Factor(dB).
3. Margin value = Emission Level – Limit value.
4. The other emission levels were very low against the limit.
5. " * " : Fundamental frequency.
6. " # " : The radiated frequency is out of the restricted band.

RF Mode	TX 802.11ax (HE20)	Channel	CH 60 : 5300 MHz
Frequency Range	1GHz ~ 40GHz	Detector Function	Peak (PK) Average (AV)

Antenna Polarity & Test Distance : Horizontal at 3 m								
No	Frequency (MHz)	Emission Level (dBuV/m)	Limit (dBuV/m)	Margin (dB)	Antenna Height (m)	Table Angle (Degree)	Raw Value (dBuV)	Correction Factor (dB/m)
1	5040.00	57.1 PK	74.0	-16.9	2.46 H	300	54.9	2.2
2	5040.00	45.8 AV	54.0	-8.2	2.46 H	300	43.6	2.2
3	*5300.00	109.9 PK			2.46 H	300	70.0	39.9
4	*5300.00	101.1 AV			2.46 H	300	61.2	39.9
5	10600.00	54.8 PK	74.0	-19.2	2.90 H	138	47.0	7.8
6	10600.00	44.6 AV	54.0	-9.4	2.90 H	138	36.8	7.8
Antenna Polarity & Test Distance : Vertical at 3 m								
No	Frequency (MHz)	Emission Level (dBuV/m)	Limit (dBuV/m)	Margin (dB)	Antenna Height (m)	Table Angle (Degree)	Raw Value (dBuV)	Correction Factor (dB/m)
1	5040.00	58.2 PK	74.0	-15.8	1.62 V	184	56.0	2.2
2	5040.00	52.9 AV	54.0	-1.1	1.62 V	184	50.7	2.2
3	*5300.00	121.7 PK			1.62 V	171	81.8	39.9
4	*5300.00	110.6 AV			1.62 V	171	70.7	39.9
5	10600.00	55.0 PK	74.0	-19.0	1.33 V	310	47.2	7.8
6	10600.00	44.9 AV	54.0	-9.1	1.33 V	310	37.1	7.8

Remarks:

1. Emission Level(dBuV/m) = Raw Value(dBuV) + Correction Factor(dB/m).
2. Correction Factor(dB/m) = Antenna Factor(dB/m) + Cable Factor(dB) – Pre-Amplifier Factor(dB).
3. Margin value = Emission Level – Limit value.
4. The other emission levels were very low against the limit.
5. " * ": Fundamental frequency.

RF Mode	TX 802.11ax (HE20)	Channel	CH 64 : 5320 MHz
Frequency Range	1GHz ~ 40GHz	Detector Function	Peak (PK) Average (AV)

Antenna Polarity & Test Distance : Horizontal at 3 m								
No	Frequency (MHz)	Emission Level (dBuV/m)	Limit (dBuV/m)	Margin (dB)	Antenna Height (m)	Table Angle (Degree)	Raw Value (dBuV)	Correction Factor (dB/m)
1	5040.00	57.9 PK	74.0	-16.1	2.37 H	303	55.7	2.2
2	5040.00	45.6 AV	54.0	-8.4	2.37 H	303	43.4	2.2
3	*5320.00	112.1 PK			2.37 H	303	72.3	39.8
4	*5320.00	101.4 AV			2.37 H	303	61.6	39.8
5	5350.00	57.2 PK	74.0	-16.8	2.37 H	303	55.2	2.0
6	5350.00	45.4 AV	54.0	-8.6	2.37 H	303	43.4	2.0
7	10640.00	54.8 PK	74.0	-19.2	2.73 H	169	46.8	8.0
8	10640.00	44.6 AV	54.0	-9.4	2.73 H	169	36.6	8.0
Antenna Polarity & Test Distance : Vertical at 3 m								
No	Frequency (MHz)	Emission Level (dBuV/m)	Limit (dBuV/m)	Margin (dB)	Antenna Height (m)	Table Angle (Degree)	Raw Value (dBuV)	Correction Factor (dB/m)
1	5040.00	59.8 PK	74.0	-14.2	1.62 V	184	57.6	2.2
2	5040.00	53.0 AV	54.0	-1.0	1.62 V	184	50.8	2.2
3	*5320.00	120.4 PK			1.62 V	184	80.6	39.8
4	*5320.00	110.4 AV			1.62 V	184	70.6	39.8
5	5350.00	56.9 PK	74.0	-17.1	1.62 V	184	54.9	2.0
6	5350.00	46.4 AV	54.0	-7.6	1.62 V	184	44.4	2.0
7	10640.00	55.1 PK	74.0	-18.9	1.39 V	326	47.1	8.0
8	10640.00	44.8 AV	54.0	-9.2	1.39 V	326	36.8	8.0

Remarks:

1. Emission Level(dBuV/m) = Raw Value(dBuV) + Correction Factor(dB/m).
2. Correction Factor(dB/m) = Antenna Factor(dB/m) + Cable Factor(dB) – Pre-Amplifier Factor(dB).
3. Margin value = Emission Level – Limit value.
4. The other emission levels were very low against the limit.
5. " * " : Fundamental frequency.

RF Mode	TX 802.11ax (HE20)	Channel	CH 100 : 5500 MHz
Frequency Range	1GHz ~ 40GHz	Detector Function	Peak (PK) Average (AV)

Antenna Polarity & Test Distance : Horizontal at 3 m								
No	Frequency (MHz)	Emission Level (dBuV/m)	Limit (dBuV/m)	Margin (dB)	Antenna Height (m)	Table Angle (Degree)	Raw Value (dBuV)	Correction Factor (dB/m)
1	5460.00	56.0 PK	74.0	-18.0	2.32 H	336	53.9	2.1
2	5460.00	45.6 AV	54.0	-8.4	2.32 H	336	43.5	2.1
3	#5470.00	57.6 PK	68.2	-10.6	2.32 H	336	55.5	2.1
4	*5500.00	107.8 PK			2.32 H	336	67.5	40.3
5	*5500.00	97.8 AV			2.32 H	336	57.5	40.3
6	11000.00	54.2 PK	74.0	-19.8	2.61 H	149	46.7	7.5
7	11000.00	44.1 AV	54.0	-9.9	2.61 H	149	36.6	7.5
Antenna Polarity & Test Distance : Vertical at 3 m								
No	Frequency (MHz)	Emission Level (dBuV/m)	Limit (dBuV/m)	Margin (dB)	Antenna Height (m)	Table Angle (Degree)	Raw Value (dBuV)	Correction Factor (dB/m)
1	5460.00	57.2 PK	74.0	-16.8	1.95 V	200	55.1	2.1
2	5460.00	46.4 AV	54.0	-7.6	1.95 V	200	44.3	2.1
3	#5470.00	57.6 PK	68.2	-10.6	1.95 V	200	55.5	2.1
4	*5500.00	119.3 PK			1.95 V	200	79.0	40.3
5	*5500.00	109.9 AV			1.95 V	200	69.6	40.3
6	11000.00	54.4 PK	74.0	-19.6	1.29 V	306	46.9	7.5
7	11000.00	44.5 AV	54.0	-9.5	1.29 V	306	37.0	7.5

Remarks:

1. Emission Level(dBuV/m) = Raw Value(dBuV) + Correction Factor(dB/m).
2. Correction Factor(dB/m) = Antenna Factor(dB/m) + Cable Factor(dB) – Pre-Amplifier Factor(dB).
3. Margin value = Emission Level – Limit value.
4. The other emission levels were very low against the limit.
5. " * " : Fundamental frequency.
6. " # " : The radiated frequency is out of the restricted band.

RF Mode	TX 802.11ax (HE20)	Channel	CH 116 : 5580 MHz
Frequency Range	1GHz ~ 40GHz	Detector Function	Peak (PK) Average (AV)

Antenna Polarity & Test Distance : Horizontal at 3 m								
No	Frequency (MHz)	Emission Level (dBuV/m)	Limit (dBuV/m)	Margin (dB)	Antenna Height (m)	Table Angle (Degree)	Raw Value (dBuV)	Correction Factor (dB/m)
1	*5580.00	108.0 PK			2.50 H	335	67.5	40.5
2	*5580.00	98.6 AV			2.50 H	335	58.1	40.5
3	11160.00	55.3 PK	74.0	-18.7	2.59 H	331	46.8	8.5
4	11160.00	45.1 AV	54.0	-8.9	2.59 H	331	36.6	8.5
Antenna Polarity & Test Distance : Vertical at 3 m								
No	Frequency (MHz)	Emission Level (dBuV/m)	Limit (dBuV/m)	Margin (dB)	Antenna Height (m)	Table Angle (Degree)	Raw Value (dBuV)	Correction Factor (dB/m)
1	*5580.00	120.0 PK			1.77 V	201	79.5	40.5
2	*5580.00	110.6 AV			1.77 V	201	70.1	40.5
3	11160.00	55.7 PK	74.0	-18.3	1.42 V	319	47.2	8.5
4	11160.00	45.6 AV	54.0	-8.4	1.42 V	319	37.1	8.5

Remarks:

1. Emission Level(dBuV/m) = Raw Value(dBuV) + Correction Factor(dB/m).
2. Correction Factor(dB/m) = Antenna Factor(dB/m) + Cable Factor(dB) – Pre-Amplifier Factor(dB).
3. Margin value = Emission Level – Limit value.
4. The other emission levels were very low against the limit.
5. " * " : Fundamental frequency.

RF Mode	TX 802.11ax (HE20)	Channel	CH 140 : 5700 MHz
Frequency Range	1GHz ~ 40GHz	Detector Function	Peak (PK) Average (AV)

Antenna Polarity & Test Distance : Horizontal at 3 m								
No	Frequency (MHz)	Emission Level (dBuV/m)	Limit (dBuV/m)	Margin (dB)	Antenna Height (m)	Table Angle (Degree)	Raw Value (dBuV)	Correction Factor (dB/m)
1	*5700.00	107.3 PK			2.30 H	349	66.2	41.1
2	*5700.00	98.2 AV			2.30 H	349	57.1	41.1
3	#5725.00	58.3 PK	68.2	-9.9	2.30 H	349	55.1	3.2
4	11400.00	55.2 PK	74.0	-18.8	2.60 H	166	46.8	8.4
5	11400.00	44.9 AV	54.0	-9.1	2.60 H	166	36.5	8.4

Antenna Polarity & Test Distance : Vertical at 3 m								
No	Frequency (MHz)	Emission Level (dBuV/m)	Limit (dBuV/m)	Margin (dB)	Antenna Height (m)	Table Angle (Degree)	Raw Value (dBuV)	Correction Factor (dB/m)
1	*5700.00	119.6 PK			1.74 V	183	78.5	41.1
2	*5700.00	110.3 AV			1.74 V	183	69.2	41.1
3	#5725.00	59.9 PK	68.2	-8.3	1.74 V	183	56.7	3.2
4	11400.00	55.3 PK	74.0	-18.7	1.49 V	326	46.9	8.4
5	11400.00	45.4 AV	54.0	-8.6	1.49 V	326	37.0	8.4

Remarks:

1. Emission Level(dBuV/m) = Raw Value(dBuV) + Correction Factor(dB/m).
2. Correction Factor(dB/m) = Antenna Factor(dB/m) + Cable Factor(dB) – Pre-Amplifier Factor(dB).
3. Margin value = Emission Level – Limit value.
4. The other emission levels were very low against the limit.
5. " * " : Fundamental frequency.
6. " # " : The radiated frequency is out of the restricted band.

RF Mode	TX 802.11ax (HE20)	Channel	CH 149 : 5745 MHz
Frequency Range	1GHz ~ 40GHz	Detector Function	Peak (PK) Average (AV)

Antenna Polarity & Test Distance : Horizontal at 3 m								
No	Frequency (MHz)	Emission Level (dBuV/m)	Limit (dBuV/m)	Margin (dB)	Antenna Height (m)	Table Angle (Degree)	Raw Value (dBuV)	Correction Factor (dB/m)
1	#5648.40	57.1 PK	68.2	-11.1	2.54 H	345	54.2	2.9
2	*5745.00	114.0 PK			2.54 H	345	72.7	41.3
3	*5745.00	103.9 AV			2.54 H	345	62.6	41.3
4	#5936.80	57.7 PK	68.2	-10.5	2.54 H	345	54.2	3.5
5	11490.00	55.6 PK	74.0	-18.4	2.81 H	142	47.1	8.5
6	11490.00	45.7 AV	54.0	-8.3	2.81 H	142	37.2	8.5
7	#17235.00	63.0 PK	68.2	-5.2	3.08 H	175	53.3	9.7

Antenna Polarity & Test Distance : Vertical at 3 m								
No	Frequency (MHz)	Emission Level (dBuV/m)	Limit (dBuV/m)	Margin (dB)	Antenna Height (m)	Table Angle (Degree)	Raw Value (dBuV)	Correction Factor (dB/m)
1	#5612.80	56.6 PK	68.2	-11.6	1.60 V	177	53.9	2.7
2	*5745.00	123.1 PK			1.60 V	360	81.8	41.3
3	*5745.00	113.1 AV			1.60 V	360	71.8	41.3
4	#5947.60	59.2 PK	68.2	-9.0	1.60 V	177	55.6	3.6
5	11490.00	56.1 PK	74.0	-17.9	1.28 V	318	47.6	8.5
6	11490.00	46.3 AV	54.0	-7.7	1.28 V	318	37.8	8.5
7	#17235.00	63.6 PK	68.2	-4.6	1.03 V	281	53.9	9.7

Remarks:

1. Emission Level(dBuV/m) = Raw Value(dBuV) + Correction Factor(dB/m).
2. Correction Factor(dB/m) = Antenna Factor(dB/m) + Cable Factor(dB) – Pre-Amplifier Factor(dB).
3. Margin value = Emission Level – Limit value.
4. The other emission levels were very low against the limit.
5. " * " : Fundamental frequency.
6. " # " : The radiated frequency is out of the restricted band.

RF Mode	TX 802.11ax (HE20)	Channel	CH 157 : 5785 MHz
Frequency Range	1GHz ~ 40GHz	Detector Function	Peak (PK) Average (AV)

Antenna Polarity & Test Distance : Horizontal at 3 m								
No	Frequency (MHz)	Emission Level (dBuV/m)	Limit (dBuV/m)	Margin (dB)	Antenna Height (m)	Table Angle (Degree)	Raw Value (dBuV)	Correction Factor (dB/m)
1	#5608.40	57.3 PK	68.2	-10.9	2.72 H	344	54.7	2.6
2	*5785.00	114.7 PK			2.72 H	344	73.2	41.5
3	*5785.00	104.6 AV			2.72 H	344	63.1	41.5
4	#5964.80	58.5 PK	68.2	-9.7	2.72 H	344	54.9	3.6
5	11570.00	58.6 PK	74.0	-15.4	2.84 H	151	49.8	8.8
6	11570.00	46.4 AV	54.0	-7.6	2.84 H	151	37.6	8.8
7	#17355.00	63.6 PK	68.2	-4.6	3.26 H	176	53.5	10.1

Antenna Polarity & Test Distance : Vertical at 3 m								
No	Frequency (MHz)	Emission Level (dBuV/m)	Limit (dBuV/m)	Margin (dB)	Antenna Height (m)	Table Angle (Degree)	Raw Value (dBuV)	Correction Factor (dB/m)
1	#5644.00	58.0 PK	68.2	-10.2	1.47 V	178	55.1	2.9
2	*5785.00	125.0 PK			1.47 V	178	83.5	41.5
3	*5785.00	113.8 AV			1.47 V	178	72.3	41.5
4	#5975.60	59.0 PK	68.2	-9.2	1.47 V	178	55.4	3.6
5	11570.00	57.1 PK	74.0	-16.9	1.46 V	341	48.3	8.8
6	11570.00	46.7 AV	54.0	-7.3	1.46 V	341	37.9	8.8
7	#17355.00	64.7 PK	68.2	-3.5	1.01 V	279	54.6	10.1

Remarks:

1. Emission Level(dBuV/m) = Raw Value(dBuV) + Correction Factor(dB/m).
2. Correction Factor(dB/m) = Antenna Factor(dB/m) + Cable Factor(dB) – Pre-Amplifier Factor(dB).
3. Margin value = Emission Level – Limit value.
4. The other emission levels were very low against the limit.
5. " * " : Fundamental frequency.
6. " # " : The radiated frequency is out of the restricted band.

RF Mode	TX 802.11ax (HE20)	Channel	CH 165 : 5825 MHz
Frequency Range	1GHz ~ 40GHz	Detector Function	Peak (PK) Average (AV)

Antenna Polarity & Test Distance : Horizontal at 3 m								
No	Frequency (MHz)	Emission Level (dBuV/m)	Limit (dBuV/m)	Margin (dB)	Antenna Height (m)	Table Angle (Degree)	Raw Value (dBuV)	Correction Factor (dB/m)
1	#5645.60	57.7 PK	68.2	-10.5	2.58 H	343	54.8	2.9
2	*5825.00	114.3 PK			2.58 H	343	72.7	41.6
3	*5825.00	103.1 AV			2.58 H	343	61.5	41.6
4	#5938.40	58.9 PK	68.2	-9.3	2.58 H	343	55.4	3.5
5	11650.00	57.4 PK	74.0	-16.6	2.80 H	144	48.6	8.8
6	11650.00	46.8 AV	54.0	-7.2	2.80 H	144	38.0	8.8
7	#17475.00	63.3 PK	68.2	-4.9	3.02 H	187	53.1	10.2
Antenna Polarity & Test Distance : Vertical at 3 m								
No	Frequency (MHz)	Emission Level (dBuV/m)	Limit (dBuV/m)	Margin (dB)	Antenna Height (m)	Table Angle (Degree)	Raw Value (dBuV)	Correction Factor (dB/m)
1	#5631.60	60.8 PK	68.2	-7.4	1.48 V	180	58.0	2.8
2	*5825.00	124.5 PK			1.48 V	180	82.9	41.6
3	*5825.00	114.5 AV			1.48 V	180	72.9	41.6
4	#5977.60	59.9 PK	68.2	-8.3	1.40 V	180	56.3	3.6
5	11650.00	57.9 PK	74.0	-16.1	1.49 V	315	49.1	8.8
6	11650.00	47.0 AV	54.0	-7.0	1.49 V	315	38.2	8.8
7	#17475.00	66.7 PK	68.2	-1.5	1.00 V	274	56.5	10.2

Remarks:

1. Emission Level(dBuV/m) = Raw Value(dBuV) + Correction Factor(dB/m).
2. Correction Factor(dB/m) = Antenna Factor(dB/m) + Cable Factor(dB) – Pre-Amplifier Factor(dB).
3. Margin value = Emission Level – Limit value.
4. The other emission levels were very low against the limit.
5. " * " : Fundamental frequency.
6. " # " : The radiated frequency is out of the restricted band.

RF Mode	TX 802.11ax (HE40)	Channel	CH 38 : 5190 MHz
Frequency Range	1GHz ~ 40GHz	Detector Function	Peak (PK) Average (AV)

Antenna Polarity & Test Distance : Horizontal at 3 m								
No	Frequency (MHz)	Emission Level (dBuV/m)	Limit (dBuV/m)	Margin (dB)	Antenna Height (m)	Table Angle (Degree)	Raw Value (dBuV)	Correction Factor (dB/m)
1	5040.00	56.5 PK	74.0	-17.5	2.38 H	331	54.3	2.2
2	5040.00	45.7 AV	54.0	-8.3	2.38 H	331	43.5	2.2
3	5150.00	58.0 PK	74.0	-16.0	2.52 H	330	55.6	2.4
4	5150.00	46.5 AV	54.0	-7.5	2.38 H	331	44.1	2.4
5	*5190.00	107.9 PK			2.38 H	331	68.0	39.9
6	*5190.00	97.3 AV			2.38 H	331	57.4	39.9
7	#10380.00	54.8 PK	68.2	-13.4	3.08 H	133	46.7	8.1

Antenna Polarity & Test Distance : Vertical at 3 m								
No	Frequency (MHz)	Emission Level (dBuV/m)	Limit (dBuV/m)	Margin (dB)	Antenna Height (m)	Table Angle (Degree)	Raw Value (dBuV)	Correction Factor (dB/m)
1	5040.00	60.1 PK	74.0	-13.9	1.75 V	175	57.9	2.2
2	5040.00	51.5 AV	54.0	-2.5	1.75 V	175	49.3	2.2
3	5150.00	62.4 PK	74.0	-11.6	1.75 V	175	60.0	2.4
4	5150.00	52.0 AV	54.0	-2.0	1.75 V	175	49.6	2.4
5	*5190.00	114.5 PK			1.75 V	175	74.6	39.9
6	*5190.00	106.1 AV			1.75 V	175	66.2	39.9
7	#10380.00	55.1 PK	68.2	-13.1	1.08 V	318	47.0	8.1

Remarks:

1. Emission Level(dBuV/m) = Raw Value(dBuV) + Correction Factor(dB/m).
2. Correction Factor(dB/m) = Antenna Factor(dB/m) + Cable Factor(dB) – Pre-Amplifier Factor(dB).
3. Margin value = Emission Level – Limit value.
4. The other emission levels were very low against the limit.
5. " * " : Fundamental frequency.
6. " # " : The radiated frequency is out of the restricted band.

RF Mode	TX 802.11ax (HE40)	Channel	CH 46 : 5230 MHz
Frequency Range	1GHz ~ 40GHz	Detector Function	Peak (PK) Average (AV)

Antenna Polarity & Test Distance : Horizontal at 3 m								
No	Frequency (MHz)	Emission Level (dBuV/m)	Limit (dBuV/m)	Margin (dB)	Antenna Height (m)	Table Angle (Degree)	Raw Value (dBuV)	Correction Factor (dB/m)
1	5040.00	56.6 PK	74.0	-17.4	2.46 H	334	54.4	2.2
2	5040.00	45.8 AV	54.0	-8.2	2.46 H	334	43.6	2.2
3	*5230.00	105.2 PK			2.46 H	334	65.3	39.9
4	*5230.00	96.3 AV			2.46 H	334	56.4	39.9
5	5350.00	55.3 PK	74.0	-18.7	2.46 H	334	53.3	2.0
6	5350.00	45.5 AV	54.0	-8.5	2.46 H	334	43.5	2.0
7	#10460.00	54.6 PK	68.2	-13.6	2.99 H	123	46.8	7.8

Antenna Polarity & Test Distance : Vertical at 3 m								
No	Frequency (MHz)	Emission Level (dBuV/m)	Limit (dBuV/m)	Margin (dB)	Antenna Height (m)	Table Angle (Degree)	Raw Value (dBuV)	Correction Factor (dB/m)
1	5040.00	57.8 PK	74.0	-16.2	1.66 V	160	55.6	2.2
2	5040.00	46.8 AV	54.0	-7.2	1.66 V	160	44.6	2.2
3	*5230.00	115.6 PK			1.66 V	160	75.7	39.9
4	*5230.00	106.3 AV			1.66 V	160	66.4	39.9
5	5350.00	56.3 PK	74.0	-17.7	1.66 V	160	54.3	2.0
6	5350.00	47.7 AV	54.0	-6.3	1.66 V	160	45.7	2.0
7	#10460.00	55.6 PK	68.2	-12.6	1.13 V	311	47.8	7.8

Remarks:

1. Emission Level(dBuV/m) = Raw Value(dBuV) + Correction Factor(dB/m).
2. Correction Factor(dB/m) = Antenna Factor(dB/m) + Cable Factor(dB) – Pre-Amplifier Factor(dB).
3. Margin value = Emission Level – Limit value.
4. The other emission levels were very low against the limit.
5. " * " : Fundamental frequency.
6. " # " : The radiated frequency is out of the restricted band.

RF Mode	TX 802.11ax (HE40)	Channel	CH 54 : 5270 MHz
Frequency Range	1GHz ~ 40GHz	Detector Function	Peak (PK) Average (AV)

Antenna Polarity & Test Distance : Horizontal at 3 m								
No	Frequency (MHz)	Emission Level (dBuV/m)	Limit (dBuV/m)	Margin (dB)	Antenna Height (m)	Table Angle (Degree)	Raw Value (dBuV)	Correction Factor (dB/m)
1	5040.00	56.7 PK	74.0	-17.3	2.47 H	334	54.5	2.2
2	5040.00	45.6 AV	54.0	-8.4	2.47 H	334	43.4	2.2
3	*5270.00	107.0 PK			2.47 H	334	67.1	39.9
4	*5270.00	98.4 AV			2.47 H	334	58.5	39.9
5	5350.00	56.2 PK	74.0	-17.8	2.47 H	334	54.2	2.0
6	5350.00	45.4 AV	54.0	-8.6	2.47 H	334	43.4	2.0
7	#10540.00	54.5 PK	68.2	-13.7	2.61 H	327	46.8	7.7
Antenna Polarity & Test Distance : Vertical at 3 m								
No	Frequency (MHz)	Emission Level (dBuV/m)	Limit (dBuV/m)	Margin (dB)	Antenna Height (m)	Table Angle (Degree)	Raw Value (dBuV)	Correction Factor (dB/m)
1	5040.00	57.3 PK	74.0	-16.7	1.56 V	185	55.1	2.2
2	5040.00	53.0 AV	54.0	-1.0	1.56 V	185	50.8	2.2
3	5150.00	57.2 PK	74.0	-16.8	1.56 V	185	54.8	2.4
4	5150.00	45.6 AV	54.0	-8.4	1.56 V	185	43.2	2.4
5	*5270.00	117.2 PK			1.56 V	185	77.3	39.9
6	*5270.00	107.8 AV			1.56 V	185	67.9	39.9
7	#10540.00	54.8 PK	68.2	-13.4	1.47 V	322	47.1	7.7

Remarks:

1. Emission Level(dBuV/m) = Raw Value(dBuV) + Correction Factor(dB/m).
2. Correction Factor(dB/m) = Antenna Factor(dB/m) + Cable Factor(dB) – Pre-Amplifier Factor(dB).
3. Margin value = Emission Level – Limit value.
4. The other emission levels were very low against the limit.
5. " * " : Fundamental frequency.
6. " # " : The radiated frequency is out of the restricted band.

RF Mode	TX 802.11ax (HE40)	Channel	CH 62 : 5310 MHz
Frequency Range	1GHz ~ 40GHz	Detector Function	Peak (PK) Average (AV)

Antenna Polarity & Test Distance : Horizontal at 3 m								
No	Frequency (MHz)	Emission Level (dBuV/m)	Limit (dBuV/m)	Margin (dB)	Antenna Height (m)	Table Angle (Degree)	Raw Value (dBuV)	Correction Factor (dB/m)
1	5040.00	57.5 PK	74.0	-16.5	2.57 H	335	55.3	2.2
2	5040.00	45.6 AV	54.0	-8.4	2.57 H	335	43.4	2.2
3	*5310.00	106.5 PK			2.57 H	335	66.7	39.8
4	*5310.00	97.2 AV			2.57 H	335	57.4	39.8
5	5350.00	57.0 PK	74.0	-17.0	2.57 H	335	55.0	2.0
6	5350.00	45.4 AV	54.0	-8.6	2.57 H	335	43.4	2.0
7	10620.00	54.6 PK	74.0	-19.4	2.87 H	148	46.7	7.9
8	10620.00	44.5 AV	54.0	-9.5	2.87 H	148	36.6	7.9
Antenna Polarity & Test Distance : Vertical at 3 m								
No	Frequency (MHz)	Emission Level (dBuV/m)	Limit (dBuV/m)	Margin (dB)	Antenna Height (m)	Table Angle (Degree)	Raw Value (dBuV)	Correction Factor (dB/m)
1	5040.00	58.7 PK	74.0	-15.3	1.75 V	168	56.5	2.2
2	5040.00	53.0 AV	54.0	-1.0	1.75 V	168	50.8	2.2
3	*5310.00	117.1 PK			1.75 V	168	77.3	39.8
4	*5310.00	108.1 AV			1.75 V	168	68.3	39.8
5	5350.00	59.9 PK	74.0	-14.1	1.75 V	168	57.9	2.0
6	5350.00	48.2 AV	54.0	-5.8	1.75 V	168	46.2	2.0
7	10620.00	54.7 PK	74.0	-19.3	1.49 V	329	46.8	7.9
8	10620.00	44.7 AV	54.0	-9.3	1.49 V	329	36.8	7.9

Remarks:

1. Emission Level(dBuV/m) = Raw Value(dBuV) + Correction Factor(dB/m).
2. Correction Factor(dB/m) = Antenna Factor(dB/m) + Cable Factor(dB) – Pre-Amplifier Factor(dB).
3. Margin value = Emission Level – Limit value.
4. The other emission levels were very low against the limit.
5. " * " : Fundamental frequency.

RF Mode	TX 802.11ax (HE40)	Channel	CH 102 : 5510 MHz
Frequency Range	1GHz ~ 40GHz	Detector Function	Peak (PK) Average (AV)

Antenna Polarity & Test Distance : Horizontal at 3 m								
No	Frequency (MHz)	Emission Level (dBuV/m)	Limit (dBuV/m)	Margin (dB)	Antenna Height (m)	Table Angle (Degree)	Raw Value (dBuV)	Correction Factor (dB/m)
1	5460.00	56.8 PK	74.0	-17.2	2.33 H	336	54.7	2.1
2	5460.00	45.4 AV	54.0	-8.6	2.33 H	336	43.3	2.1
3	#5470.00	57.1 PK	68.2	-11.1	2.33 H	336	55.0	2.1
4	*5510.00	106.6 PK			2.33 H	336	66.3	40.3
5	*5510.00	95.7 AV			2.33 H	336	55.4	40.3
6	11020.00	54.1 PK	74.0	-19.9	2.73 H	171	46.5	7.6
7	11020.00	44.6 AV	54.0	-9.4	2.73 H	171	37.0	7.6
Antenna Polarity & Test Distance : Vertical at 3 m								
No	Frequency (MHz)	Emission Level (dBuV/m)	Limit (dBuV/m)	Margin (dB)	Antenna Height (m)	Table Angle (Degree)	Raw Value (dBuV)	Correction Factor (dB/m)
1	5460.00	60.2 PK	74.0	-13.8	1.91 V	205	58.1	2.1
2	5460.00	47.7 AV	54.0	-6.3	1.91 V	205	45.6	2.1
3	#5470.00	62.8 PK	68.2	-5.4	1.91 V	205	60.7	2.1
4	*5510.00	119.0 PK			1.91 V	205	78.7	40.3
5	*5510.00	107.6 AV			1.91 V	205	67.3	40.3
6	11020.00	54.5 PK	74.0	-19.5	1.47 V	325	46.9	7.6
7	11020.00	44.7 AV	54.0	-9.3	1.47 V	325	37.1	7.6

Remarks:

1. Emission Level(dBuV/m) = Raw Value(dBuV) + Correction Factor(dB/m).
2. Correction Factor(dB/m) = Antenna Factor(dB/m) + Cable Factor(dB) – Pre-Amplifier Factor(dB).
3. Margin value = Emission Level – Limit value.
4. The other emission levels were very low against the limit.
5. " * " : Fundamental frequency.
6. " # " : The radiated frequency is out of the restricted band.

RF Mode	TX 802.11ax (HE40)	Channel	CH 110 : 5550 MHz
Frequency Range	1GHz ~ 40GHz	Detector Function	Peak (PK) Average (AV)

Antenna Polarity & Test Distance : Horizontal at 3 m								
No	Frequency (MHz)	Emission Level (dBuV/m)	Limit (dBuV/m)	Margin (dB)	Antenna Height (m)	Table Angle (Degree)	Raw Value (dBuV)	Correction Factor (dB/m)
1	*5550.00	107.2 PK			2.51 H	335	66.7	40.5
2	*5550.00	97.0 AV			2.51 H	335	56.5	40.5
3	11100.00	55.4 PK	74.0	-18.6	2.77 H	149	47.1	8.3
4	11100.00	45.2 AV	54.0	-8.8	2.77 H	149	36.9	8.3
Antenna Polarity & Test Distance : Vertical at 3 m								
No	Frequency (MHz)	Emission Level (dBuV/m)	Limit (dBuV/m)	Margin (dB)	Antenna Height (m)	Table Angle (Degree)	Raw Value (dBuV)	Correction Factor (dB/m)
1	*5550.00	116.4 PK			1.83 V	181	75.9	40.5
2	*5550.00	107.4 AV			1.83 V	181	66.9	40.5
3	11100.00	55.6 PK	74.0	-18.4	1.44 V	325	47.3	8.3
4	11100.00	45.5 AV	54.0	-8.5	1.44 V	325	37.2	8.3

Remarks:

1. Emission Level(dBuV/m) = Raw Value(dBuV) + Correction Factor(dB/m).
2. Correction Factor(dB/m) = Antenna Factor(dB/m) + Cable Factor(dB) – Pre-Amplifier Factor(dB).
3. Margin value = Emission Level – Limit value.
4. The other emission levels were very low against the limit.
5. " * " : Fundamental frequency.

RF Mode	TX 802.11ax (HE40)	Channel	CH 134 : 5670 MHz
Frequency Range	1GHz ~ 40GHz	Detector Function	Peak (PK) Average (AV)

Antenna Polarity & Test Distance : Horizontal at 3 m								
No	Frequency (MHz)	Emission Level (dBuV/m)	Limit (dBuV/m)	Margin (dB)	Antenna Height (m)	Table Angle (Degree)	Raw Value (dBuV)	Correction Factor (dB/m)
1	*5670.00	105.5 PK			2.54 H	338	64.5	41.0
2	*5670.00	96.3 AV			2.54 H	338	55.3	41.0
3	#5725.00	57.7 PK	68.2	-10.5	2.54 H	338	54.5	3.2
4	11340.00	55.3 PK	74.0	-18.7	2.80 H	163	46.8	8.5
5	11340.00	45.4 AV	54.0	-8.6	2.80 H	163	36.9	8.5

Antenna Polarity & Test Distance : Vertical at 3 m								
No	Frequency (MHz)	Emission Level (dBuV/m)	Limit (dBuV/m)	Margin (dB)	Antenna Height (m)	Table Angle (Degree)	Raw Value (dBuV)	Correction Factor (dB/m)
1	*5670.00	118.5 PK			1.80 V	198	77.5	41.0
2	*5670.00	108.3 AV			1.80 V	198	67.3	41.0
3	#5725.00	61.6 PK	68.2	-6.6	1.80 V	198	58.4	3.2
4	11340.00	55.5 PK	74.0	-18.5	1.32 V	317	47.0	8.5
5	11340.00	45.6 AV	54.0	-8.4	1.32 V	317	37.1	8.5

Remarks:

1. Emission Level(dBuV/m) = Raw Value(dBuV) + Correction Factor(dB/m).
2. Correction Factor(dB/m) = Antenna Factor(dB/m) + Cable Factor(dB) – Pre-Amplifier Factor(dB).
3. Margin value = Emission Level – Limit value.
4. The other emission levels were very low against the limit.
5. " * " : Fundamental frequency.
6. " # " : The radiated frequency is out of the restricted band.

RF Mode	TX 802.11ax (HE40)	Channel	CH 151 : 5755 MHz
Frequency Range	1GHz ~ 40GHz	Detector Function	Peak (PK) Average (AV)

Antenna Polarity & Test Distance : Horizontal at 3 m								
No	Frequency (MHz)	Emission Level (dBuV/m)	Limit (dBuV/m)	Margin (dB)	Antenna Height (m)	Table Angle (Degree)	Raw Value (dBuV)	Correction Factor (dB/m)
1	#5608.00	57.1 PK	68.2	-11.1	2.37 H	343	54.5	2.6
2	*5755.00	112.1 PK			2.37 H	343	70.8	41.3
3	*5755.00	103.0 AV			2.37 H	343	61.7	41.3
4	#5988.80	57.4 PK	68.2	-10.8	2.37 H	343	53.7	3.7
5	11510.00	56.1 PK	74.0	-17.9	2.82 H	132	47.5	8.6
6	11510.00	45.5 AV	54.0	-8.5	2.82 H	132	36.9	8.6

Antenna Polarity & Test Distance : Vertical at 3 m								
No	Frequency (MHz)	Emission Level (dBuV/m)	Limit (dBuV/m)	Margin (dB)	Antenna Height (m)	Table Angle (Degree)	Raw Value (dBuV)	Correction Factor (dB/m)
1	#5643.60	58.9 PK	68.2	-9.3	1.34 V	191	56.0	2.9
2	*5755.00	121.3 PK			1.34 V	191	80.0	41.3
3	*5755.00	111.9 AV			1.34 V	191	70.6	41.3
4	#5952.00	59.6 PK	68.2	-8.6	1.34 V	191	56.0	3.6
5	11510.00	56.4 PK	74.0	-17.6	1.48 V	328	47.8	8.6
6	11510.00	45.6 AV	54.0	-8.4	1.48 V	328	37.0	8.6

Remarks:

1. Emission Level(dBuV/m) = Raw Value(dBuV) + Correction Factor(dB/m).
2. Correction Factor(dB/m) = Antenna Factor(dB/m) + Cable Factor(dB) – Pre-Amplifier Factor(dB).
3. Margin value = Emission Level – Limit value.
4. The other emission levels were very low against the limit.
5. " * " : Fundamental frequency.
6. " # " : The radiated frequency is out of the restricted band.

RF Mode	TX 802.11ax (HE40)	Channel	CH 159 : 5795 MHz
Frequency Range	1GHz ~ 40GHz	Detector Function	Peak (PK) Average (AV)

Antenna Polarity & Test Distance : Horizontal at 3 m								
No	Frequency (MHz)	Emission Level (dBuV/m)	Limit (dBuV/m)	Margin (dB)	Antenna Height (m)	Table Angle (Degree)	Raw Value (dBuV)	Correction Factor (dB/m)
1	#5610.80	58.4 PK	68.2	-9.8	2.39 H	329	55.8	2.6
2	*5795.00	111.7 PK			2.39 H	329	70.1	41.6
3	*5795.00	102.4 AV			2.39 H	329	60.8	41.6
4	#5963.60	58.1 PK	68.2	-10.1	2.39 H	329	54.5	3.6
5	11590.00	56.8 PK	74.0	-17.2	2.78 H	158	48.0	8.8
6	11590.00	46.3 AV	54.0	-7.7	2.78 H	158	37.5	8.8

Antenna Polarity & Test Distance : Vertical at 3 m								
No	Frequency (MHz)	Emission Level (dBuV/m)	Limit (dBuV/m)	Margin (dB)	Antenna Height (m)	Table Angle (Degree)	Raw Value (dBuV)	Correction Factor (dB/m)
1	#5604.00	59.1 PK	68.2	-9.1	1.64 V	167	56.5	2.6
2	*5795.00	122.1 PK			1.64 V	167	80.5	41.6
3	*5795.00	112.7 AV			1.64 V	167	71.1	41.6
4	#5984.80	59.1 PK	68.2	-9.1	1.64 V	167	55.4	3.7
5	11590.00	57.1 PK	74.0	-16.9	1.39 V	299	48.3	8.8
6	11590.00	46.4 AV	54.0	-7.6	1.39 V	299	37.6	8.8

Remarks:

1. Emission Level(dBuV/m) = Raw Value(dBuV) + Correction Factor(dB/m).
2. Correction Factor(dB/m) = Antenna Factor(dB/m) + Cable Factor(dB) – Pre-Amplifier Factor(dB).
3. Margin value = Emission Level – Limit value.
4. The other emission levels were very low against the limit.
5. " * " : Fundamental frequency.
6. " # " : The radiated frequency is out of the restricted band.

RF Mode	TX 802.11ax (HE80)	Channel	CH 42 : 5210 MHz
Frequency Range	1GHz ~ 40GHz	Detector Function	Peak (PK) Average (AV)

Antenna Polarity & Test Distance : Horizontal at 3 m								
No	Frequency (MHz)	Emission Level (dBuV/m)	Limit (dBuV/m)	Margin (dB)	Antenna Height (m)	Table Angle (Degree)	Raw Value (dBuV)	Correction Factor (dB/m)
1	5040.00	56.5 PK	74.0	-17.5	2.24 H	332	54.3	2.2
2	5040.00	45.6 AV	54.0	-8.4	2.24 H	332	43.4	2.2
3	5150.00	55.7 PK	74.0	-18.3	2.24 H	332	53.3	2.4
4	5150.00	45.8 AV	54.0	-8.2	2.24 H	332	43.4	2.4
5	*5210.00	101.8 PK			2.24 H	332	61.9	39.9
6	*5210.00	93.0 AV			2.24 H	332	53.1	39.9
7	5350.00	55.5 PK	74.0	-18.5	2.24 H	332	53.5	2.0
8	5350.00	45.2 AV	54.0	-8.8	2.24 H	332	43.2	2.0
9	#10420.00	54.8 PK	68.2	-13.4	3.19 H	135	46.8	8.0
Antenna Polarity & Test Distance : Vertical at 3 m								
No	Frequency (MHz)	Emission Level (dBuV/m)	Limit (dBuV/m)	Margin (dB)	Antenna Height (m)	Table Angle (Degree)	Raw Value (dBuV)	Correction Factor (dB/m)
1	5040.00	58.0 PK	74.0	-16.0	1.61 V	202	55.8	2.2
2	5040.00	49.5 AV	54.0	-4.5	1.61 V	202	47.3	2.2
3	5150.00	60.7 PK	74.0	-13.3	1.61 V	202	58.3	2.4
4	5150.00	49.7 AV	54.0	-4.3	1.61 V	202	47.3	2.4
5	*5210.00	111.2 PK			1.61 V	202	71.3	39.9
6	*5210.00	102.0 AV			1.61 V	202	62.1	39.9
7	5350.00	57.0 PK	74.0	-17.0	1.61 V	202	55.0	2.0
8	5350.00	46.0 AV	54.0	-8.0	1.61 V	202	44.0	2.0
9	#10420.00	55.6 PK	68.2	-12.6	1.16 V	314	47.6	8.0

Remarks:

1. Emission Level(dBuV/m) = Raw Value(dBuV) + Correction Factor(dB/m).
2. Correction Factor(dB/m) = Antenna Factor(dB/m) + Cable Factor(dB) – Pre-Amplifier Factor(dB).
3. Margin value = Emission Level – Limit value.
4. The other emission levels were very low against the limit.
5. " * ": Fundamental frequency.
6. " # ": The radiated frequency is out of the restricted band.

RF Mode	TX 802.11ax (HE80)	Channel	CH 58 : 5290 MHz
Frequency Range	1GHz ~ 40GHz	Detector Function	Peak (PK) Average (AV)

Antenna Polarity & Test Distance : Horizontal at 3 m								
No	Frequency (MHz)	Emission Level (dBuV/m)	Limit (dBuV/m)	Margin (dB)	Antenna Height (m)	Table Angle (Degree)	Raw Value (dBuV)	Correction Factor (dB/m)
1	5150.00	56.7 PK	74.0	-17.3	2.62 H	334	54.3	2.4
2	5150.00	45.9 AV	54.0	-8.1	2.62 H	334	43.5	2.4
3	*5290.00	107.0 PK			2.62 H	334	67.1	39.9
4	*5290.00	95.9 AV			2.62 H	334	56.0	39.9
5	5350.00	56.4 PK	74.0	-17.6	2.62 H	334	54.4	2.0
6	5350.00	45.4 AV	54.0	-8.6	2.62 H	334	43.4	2.0
7	#10580.00	54.6 PK	68.2	-13.6	2.88 H	162	46.9	7.7
Antenna Polarity & Test Distance : Vertical at 3 m								
No	Frequency (MHz)	Emission Level (dBuV/m)	Limit (dBuV/m)	Margin (dB)	Antenna Height (m)	Table Angle (Degree)	Raw Value (dBuV)	Correction Factor (dB/m)
1	5150.00	58.5 PK	74.0	-15.5	1.55 V	183	56.1	2.4
2	5150.00	47.4 AV	54.0	-6.6	1.55 V	183	45.0	2.4
3	*5290.00	115.4 PK			1.55 V	183	75.5	39.9
4	*5290.00	105.7 AV			1.55 V	183	65.8	39.9
5	5350.00	63.0 PK	74.0	-11.0	1.55 V	183	61.0	2.0
6	5350.00	49.4 AV	54.0	-4.6	1.55 V	183	47.4	2.0
7	#10580.00	54.9 PK	68.2	-13.3	1.39 V	305	47.2	7.7

Remarks:

1. Emission Level(dBuV/m) = Raw Value(dBuV) + Correction Factor(dB/m).
2. Correction Factor(dB/m) = Antenna Factor(dB/m) + Cable Factor(dB) – Pre-Amplifier Factor(dB).
3. Margin value = Emission Level – Limit value.
4. The other emission levels were very low against the limit.
5. " * " : Fundamental frequency.
6. " # " : The radiated frequency is out of the restricted band.

RF Mode	TX 802.11ax (HE80)	Channel	CH 106 : 5530 MHz
Frequency Range	1GHz ~ 40GHz	Detector Function	Peak (PK) Average (AV)

Antenna Polarity & Test Distance : Horizontal at 3 m								
No	Frequency (MHz)	Emission Level (dBuV/m)	Limit (dBuV/m)	Margin (dB)	Antenna Height (m)	Table Angle (Degree)	Raw Value (dBuV)	Correction Factor (dB/m)
1	5460.00	57.6 PK	74.0	-16.4	2.27 H	336	55.5	2.1
2	5460.00	46.0 AV	54.0	-8.0	2.27 H	336	43.9	2.1
3	#5470.00	58.5 PK	68.2	-9.7	2.27 H	336	56.4	2.1
4	*5530.00	103.2 PK			2.27 H	336	62.8	40.4
5	*5530.00	93.9 AV			2.27 H	336	53.5	40.4
6	#5725.00	58.4 PK	68.2	-9.8	2.27 H	336	55.2	3.2
7	11060.00	54.6 PK	74.0	-19.4	2.91 H	169	46.6	8.0
8	11060.00	44.8 AV	54.0	-9.2	2.91 H	169	36.8	8.0
Antenna Polarity & Test Distance : Vertical at 3 m								
No	Frequency (MHz)	Emission Level (dBuV/m)	Limit (dBuV/m)	Margin (dB)	Antenna Height (m)	Table Angle (Degree)	Raw Value (dBuV)	Correction Factor (dB/m)
1	5460.00	61.2 PK	74.0	-12.8	1.89 V	200	59.1	2.1
2	5460.00	52.3 AV	54.0	-1.7	1.89 V	200	50.2	2.1
3	#5470.00	63.1 PK	68.2	-5.1	1.89 V	200	61.0	2.1
4	*5530.00	113.9 PK			1.89 V	200	73.5	40.4
5	*5530.00	104.5 AV			1.89 V	200	64.1	40.4
6	#5725.00	58.2 PK	68.2	-10.0	1.89 V	200	55.0	3.2
7	11060.00	54.9 PK	74.0	-19.1	1.45 V	315	46.9	8.0
8	11060.00	45.0 AV	54.0	-9.0	1.45 V	315	37.0	8.0

Remarks:

1. Emission Level(dBuV/m) = Raw Value(dBuV) + Correction Factor(dB/m).
2. Correction Factor(dB/m) = Antenna Factor(dB/m) + Cable Factor(dB) – Pre-Amplifier Factor(dB).
3. Margin value = Emission Level – Limit value.
4. The other emission levels were very low against the limit.
5. " * ": Fundamental frequency.
6. " # ": The radiated frequency is out of the restricted band.

RF Mode	TX 802.11ax (HE80)	Channel	CH 122 : 5610 MHz
Frequency Range	1GHz ~ 40GHz	Detector Function	Peak (PK) Average (AV)

Antenna Polarity & Test Distance : Horizontal at 3 m								
No	Frequency (MHz)	Emission Level (dBuV/m)	Limit (dBuV/m)	Margin (dB)	Antenna Height (m)	Table Angle (Degree)	Raw Value (dBuV)	Correction Factor (dB/m)
1	5460.00	56.2 PK	74.0	-17.8	2.00 H	338	54.1	2.1
2	5460.00	45.3 AV	54.0	-8.7	2.00 H	338	43.2	2.1
3	#5470.00	56.8 PK	68.2	-11.4	2.00 H	338	54.7	2.1
4	*5610.00	103.0 PK			2.00 H	338	62.4	40.6
5	*5610.00	93.7 AV			2.00 H	338	53.1	40.6
6	#5725.00	57.9 PK	68.2	-10.3	2.00 H	338	54.7	3.2
7	11220.00	55.4 PK	74.0	-18.6	2.90 H	158	46.7	8.7
8	11220.00	45.3 AV	54.0	-8.7	2.90 H	158	36.6	8.7
Antenna Polarity & Test Distance : Vertical at 3 m								
No	Frequency (MHz)	Emission Level (dBuV/m)	Limit (dBuV/m)	Margin (dB)	Antenna Height (m)	Table Angle (Degree)	Raw Value (dBuV)	Correction Factor (dB/m)
1	5460.00	57.0 PK	74.0	-17.0	1.93 V	197	54.9	2.1
2	5460.00	46.4 AV	54.0	-7.6	1.93 V	197	44.3	2.1
3	#5470.00	57.4 PK	68.2	-10.8	1.93 V	197	55.3	2.1
4	*5610.00	115.6 PK			1.93 V	197	75.0	40.6
5	*5610.00	105.1 AV			1.93 V	197	64.5	40.6
6	#5725.00	58.7 PK	68.2	-9.5	1.93 V	197	55.5	3.2
7	11220.00	55.6 PK	74.0	-18.4	1.40 V	308	46.9	8.7
8	11220.00	45.5 AV	54.0	-8.5	1.40 V	308	36.8	8.7

Remarks:

1. Emission Level(dBuV/m) = Raw Value(dBuV) + Correction Factor(dB/m).
2. Correction Factor(dB/m) = Antenna Factor(dB/m) + Cable Factor(dB) – Pre-Amplifier Factor(dB).
3. Margin value = Emission Level – Limit value.
4. The other emission levels were very low against the limit.
5. " * ": Fundamental frequency.
6. " # ": The radiated frequency is out of the restricted band.

RF Mode	TX 802.11ax (HE80)	Channel	CH 155 : 5775 MHz
Frequency Range	1GHz ~ 40GHz	Detector Function	Peak (PK) Average (AV)

Antenna Polarity & Test Distance : Horizontal at 3 m								
No	Frequency (MHz)	Emission Level (dBuV/m)	Limit (dBuV/m)	Margin (dB)	Antenna Height (m)	Table Angle (Degree)	Raw Value (dBuV)	Correction Factor (dB/m)
1	#5639.20	58.5 PK	68.2	-9.7	2.35 H	344	55.6	2.9
2	#5650.00	59.1 PK	68.2	-9.1	2.35 H	344	56.2	2.9
3	*5775.00	108.4 PK			2.35 H	344	66.9	41.5
4	*5775.00	98.2 AV			2.35 H	344	56.7	41.5
5	#5925.00	58.4 PK	68.2	-9.8	2.35 H	344	54.9	3.5
6	#5930.80	58.3 PK	68.2	-9.9	2.35 H	344	54.8	3.5
7	11550.00	55.8 PK	74.0	-18.2	2.90 H	137	47.1	8.7
8	11550.00	45.3 AV	54.0	-8.7	2.90 H	137	36.6	8.7
Antenna Polarity & Test Distance : Vertical at 3 m								
No	Frequency (MHz)	Emission Level (dBuV/m)	Limit (dBuV/m)	Margin (dB)	Antenna Height (m)	Table Angle (Degree)	Raw Value (dBuV)	Correction Factor (dB/m)
1	#5646.80	66.1 PK	68.2	-2.1	1.45 V	182	63.2	2.9
2	#5650.00	67.2 PK	68.2	-1.0	1.45 V	182	64.3	2.9
3	*5775.00	119.3 PK			1.45 V	182	77.8	41.5
4	*5775.00	108.6 AV			1.45 V	182	67.1	41.5
5	#5925.00	62.5 PK	68.2	-5.7	1.45 V	182	59.0	3.5
6	#5928.00	61.5 PK	68.2	-6.7	1.45 V	182	58.0	3.5
7	11550.00	56.2 PK	74.0	-17.8	1.29 V	318	47.5	8.7
8	11550.00	45.8 AV	54.0	-8.2	1.29 V	318	37.1	8.7

Remarks:

1. Emission Level(dBuV/m) = Raw Value(dBuV) + Correction Factor(dB/m).
2. Correction Factor(dB/m) = Antenna Factor(dB/m) + Cable Factor(dB) – Pre-Amplifier Factor(dB).
3. Margin value = Emission Level – Limit value.
4. The other emission levels were very low against the limit.
5. " * ": Fundamental frequency.
6. " # ": The radiated frequency is out of the restricted band.

RF Mode	TX 802.11ax (HE160)	Channel	CH 50 : 5250 MHz
Frequency Range	1GHz ~ 40GHz	Detector Function	Peak (PK) Average (AV)

Antenna Polarity & Test Distance : Horizontal at 3 m								
No	Frequency (MHz)	Emission Level (dBuV/m)	Limit (dBuV/m)	Margin (dB)	Antenna Height (m)	Table Angle (Degree)	Raw Value (dBuV)	Correction Factor (dB/m)
1	5150.00	59.0 PK	74.0	-15.0	2.37 H	333	56.6	2.4
2	5150.00	46.3 AV	54.0	-7.7	2.37 H	333	43.9	2.4
3	*5250.00	99.6 PK			2.37 H	333	59.7	39.9
4	*5250.00	89.5 AV			2.37 H	333	49.6	39.9
5	5350.00	56.2 PK	74.0	-17.8	2.37 H	333	54.2	2.0
6	5350.00	45.6 AV	54.0	-8.4	2.37 H	333	43.6	2.0
7	#10500.00	55.3 PK	68.2	-12.9	1.42 H	330	47.6	7.7
Antenna Polarity & Test Distance : Vertical at 3 m								
No	Frequency (MHz)	Emission Level (dBuV/m)	Limit (dBuV/m)	Margin (dB)	Antenna Height (m)	Table Angle (Degree)	Raw Value (dBuV)	Correction Factor (dB/m)
1	5150.00	61.7 PK	74.0	-12.3	1.31 V	190	59.3	2.4
2	5150.00	50.6 AV	54.0	-3.4	1.31 V	190	48.2	2.4
3	*5250.00	108.8 PK			1.31 V	190	68.9	39.9
4	*5250.00	97.9 AV			1.31 V	190	58.0	39.9
5	5350.00	57.9 PK	74.0	-16.1	1.31 V	190	55.9	2.0
6	5350.00	46.7 AV	54.0	-7.3	1.31 V	190	44.7	2.0
7	#10500.00	55.3 PK	68.2	-12.9	1.36 V	307	47.6	7.7

Remarks:

1. Emission Level(dBuV/m) = Raw Value(dBuV) + Correction Factor(dB/m).
2. Correction Factor(dB/m) = Antenna Factor(dB/m) + Cable Factor(dB) – Pre-Amplifier Factor(dB).
3. Margin value = Emission Level – Limit value.
4. The other emission levels were very low against the limit.
5. " * " : Fundamental frequency.
6. " # " : The radiated frequency is out of the restricted band.

RF Mode	TX 802.11ax (HE160)	Channel	CH 114 : 5570 MHz
Frequency Range	1GHz ~ 40GHz	Detector Function	Peak (PK) Average (AV)

Antenna Polarity & Test Distance : Horizontal at 3 m								
No	Frequency (MHz)	Emission Level (dBuV/m)	Limit (dBuV/m)	Margin (dB)	Antenna Height (m)	Table Angle (Degree)	Raw Value (dBuV)	Correction Factor (dB/m)
1	5460.00	55.3 PK	74.0	-18.7	2.66 H	331	53.2	2.1
2	5460.00	47.0 AV	54.0	-7.0	2.66 H	331	44.9	2.1
3	#5470.00	57.5 PK	68.2	-10.7	2.66 H	331	55.4	2.1
4	*5570.00	98.0 PK			2.66 H	331	57.5	40.5
5	*5570.00	89.5 AV			2.66 H	331	49.0	40.5
6	#5725.00	58.8 PK	68.2	-9.4	2.66 H	331	55.6	3.2
7	11140.00	56.4 PK	74.0	-17.6	2.69 H	171	48.0	8.4
8	11140.00	45.3 AV	54.0	-8.7	2.69 H	171	36.9	8.4
Antenna Polarity & Test Distance : Vertical at 3 m								
No	Frequency (MHz)	Emission Level (dBuV/m)	Limit (dBuV/m)	Margin (dB)	Antenna Height (m)	Table Angle (Degree)	Raw Value (dBuV)	Correction Factor (dB/m)
1	5460.00	63.6 PK	74.0	-10.4	1.73 V	201	61.5	2.1
2	5460.00	52.6 AV	54.0	-1.4	1.73 V	201	50.5	2.1
3	#5470.00	64.9 PK	68.2	-3.3	1.73 V	201	62.8	2.1
4	*5570.00	107.0 PK			1.73 V	201	66.5	40.5
5	*5570.00	98.9 AV			1.73 V	201	58.4	40.5
6	#5725.00	59.6 PK	68.2	-8.6	1.73 V	201	56.4	3.2
7	11140.00	57.1 PK	74.0	-16.9	1.49 V	322	48.7	8.4
8	11140.00	45.6 AV	54.0	-8.4	1.49 V	322	37.2	8.4

Remarks:

1. Emission Level(dBuV/m) = Raw Value(dBuV) + Correction Factor(dB/m).
2. Correction Factor(dB/m) = Antenna Factor(dB/m) + Cable Factor(dB) – Pre-Amplifier Factor(dB).
3. Margin value = Emission Level – Limit value.
4. The other emission levels were very low against the limit.
5. " * ": Fundamental frequency.
6. " # ": The radiated frequency is out of the restricted band.

Below 1GHz Worst-Case Data:

RF Mode	TX 802.11ax (HE40)	Channel	CH 159 : 5795 MHz
Frequency Range	30MHz ~ 1GHz	Detector Function	Quasi-Peak (QP)
Test Mode	A		

Antenna Polarity & Test Distance : Horizontal at 3 m								
No	Frequency (MHz)	Emission Level (dBuV/m)	Limit (dBuV/m)	Margin (dB)	Antenna Height (m)	Table Angle (Degree)	Raw Value (dBuV)	Correction Factor (dB/m)
1	48.28	18.2 QP	40.0	-21.8	1.00 H	257	36.4	-18.2
2	145.28	22.0 QP	43.5	-21.5	1.50 H	77	40.5	-18.5
3	226.81	17.4 QP	46.0	-28.6	1.50 H	73	38.7	-21.3
4	256.33	20.4 QP	46.0	-25.6	1.00 H	355	39.9	-19.5
5	297.10	18.3 QP	46.0	-27.7	1.50 H	318	36.2	-17.9
6	730.09	24.7 QP	46.0	-21.3	1.50 H	37	33.6	-8.9

Remarks:

1. Emission Level(dBuV/m) = Raw Value(dBuV) + Correction Factor(dB/m)
2. Correction Factor(dB/m) = Antenna Factor(dB/m) + Cable Factor(dB) – Pre-Amplifier Factor(dB)
3. Margin value = Emission Level – Limit value
4. The other emission levels were very low against the limit of frequency range 30MHz~1000MHz.
5. The emission levels were very low against the limit of frequency range 9kHz~30MHz: the amplitude of spurious emissions attenuated more than 20 dB below the permissible value to be report.

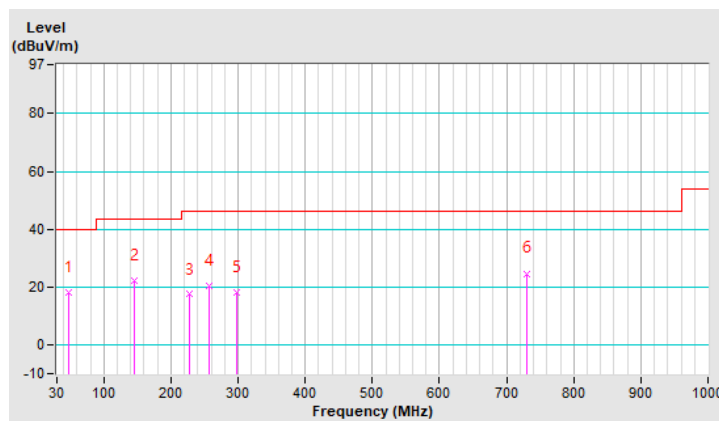

RF Mode	TX 802.11ax (HE40)	Channel	CH 159 : 5795 MHz
Frequency Range	30MHz ~ 1GHz	Detector Function	Quasi-Peak (QP)
Test Mode	A		

Antenna Polarity & Test Distance : Vertical at 3 m								
No	Frequency (MHz)	Emission Level (dBuV/m)	Limit (dBuV/m)	Margin (dB)	Antenna Height (m)	Table Angle (Degree)	Raw Value (dBuV)	Correction Factor (dB/m)
1	48.28	34.5 QP	40.0	-5.5	1.50 V	61	52.7	-18.2
2	73.58	21.8 QP	40.0	-18.2	1.00 V	271	43.3	-21.5
3	256.33	25.5 QP	46.0	-20.5	1.00 V	105	45.0	-19.5
4	297.10	25.3 QP	46.0	-20.7	1.00 V	350	43.2	-17.9
5	479.86	25.3 QP	46.0	-20.7	1.50 V	186	38.8	-13.5
6	746.96	29.1 QP	46.0	-16.9	1.00 V	338	37.4	-8.3

Remarks:

1. Emission Level(dBuV/m) = Raw Value(dBuV) + Correction Factor(dB/m)
2. Correction Factor(dB/m) = Antenna Factor(dB/m) + Cable Factor(dB) – Pre-Amplifier Factor(dB)
3. Margin value = Emission Level – Limit value
4. The other emission levels were very low against the limit of frequency range 30MHz~1000MHz.
5. The emission levels were very low against the limit of frequency range 9kHz~30MHz: the amplitude of spurious emissions attenuated more than 20 dB below the permissible value to be report.

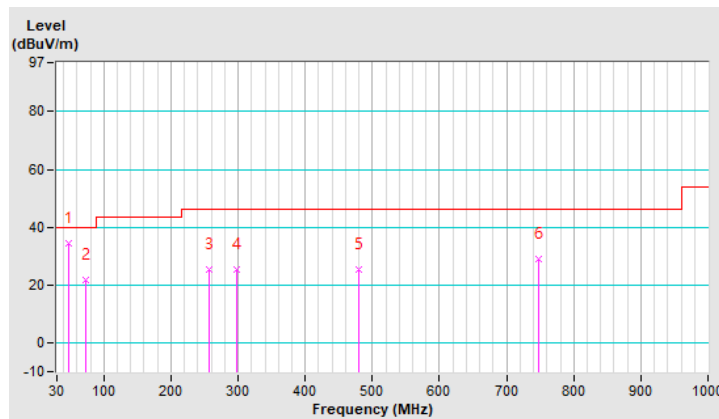

RF Mode	TX 802.11ax (HE40)	Channel	CH 159 : 5795 MHz
Frequency Range	30MHz ~ 1GHz	Detector Function	Quasi-Peak (QP)
Test Mode	B		

Antenna Polarity & Test Distance : Horizontal at 3 m

No	Frequency (MHz)	Emission Level (dBuV/m)	Limit (dBuV/m)	Margin (dB)	Antenna Height (m)	Table Angle (Degree)	Raw Value (dBuV)	Correction Factor (dB/m)
1	70.77	14.2 QP	40.0	-25.8	1.50 H	267	34.8	-20.6
2	145.28	19.6 QP	43.5	-23.9	1.01 H	46	38.1	-18.5
3	254.93	19.0 QP	46.0	-27.0	1.01 H	121	38.5	-19.5
4	297.10	18.5 QP	46.0	-27.5	1.50 H	246	36.4	-17.9
5	479.86	21.3 QP	46.0	-24.7	1.01 H	293	34.8	-13.5
6	782.10	28.7 QP	46.0	-17.3	1.01 H	93	36.8	-8.1

Remarks:

1. Emission Level(dBuV/m) = Raw Value(dBuV) + Correction Factor(dB/m)
2. Correction Factor(dB/m) = Antenna Factor(dB/m) + Cable Factor(dB) – Pre-Amplifier Factor(dB)
3. Margin value = Emission Level – Limit value
4. The other emission levels were very low against the limit of frequency range 30MHz~1000MHz.
5. The emission levels were very low against the limit of frequency range 9kHz~30MHz: the amplitude of spurious emissions attenuated more than 20 dB below the permissible value to be report.

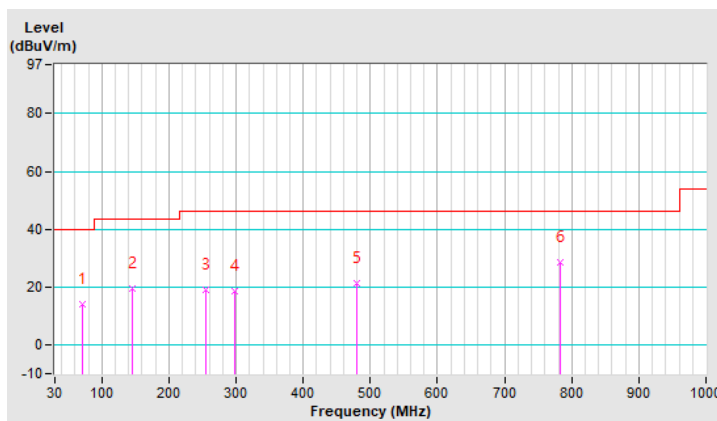

RF Mode	TX 802.11ax (HE40)	Channel	CH 159 : 5795 MHz
Frequency Range	30MHz ~ 1GHz	Detector Function	Quasi-Peak (QP)
Test Mode	B		

Antenna Polarity & Test Distance : Vertical at 3 m								
No	Frequency (MHz)	Emission Level (dBuV/m)	Limit (dBuV/m)	Margin (dB)	Antenna Height (m)	Table Angle (Degree)	Raw Value (dBuV)	Correction Factor (dB/m)
1	52.49	21.5 QP	40.0	-18.5	1.00 V	298	39.8	-18.3
2	72.17	20.6 QP	40.0	-19.4	1.00 V	260	41.7	-21.1
3	256.33	24.2 QP	46.0	-21.8	1.49 V	115	43.7	-19.5
4	297.10	25.8 QP	46.0	-20.2	1.49 V	348	43.7	-17.9
5	479.86	24.8 QP	46.0	-21.2	1.00 V	346	38.3	-13.5
6	782.10	33.0 QP	46.0	-13.0	1.49 V	206	41.1	-8.1

Remarks:

1. Emission Level(dBuV/m) = Raw Value(dBuV) + Correction Factor(dB/m)
2. Correction Factor(dB/m) = Antenna Factor(dB/m) + Cable Factor(dB) – Pre-Amplifier Factor(dB)
3. Margin value = Emission Level – Limit value
4. The other emission levels were very low against the limit of frequency range 30MHz~1000MHz.
5. The emission levels were very low against the limit of frequency range 9kHz~30MHz: the amplitude of spurious emissions attenuated more than 20 dB below the permissible value to be report.

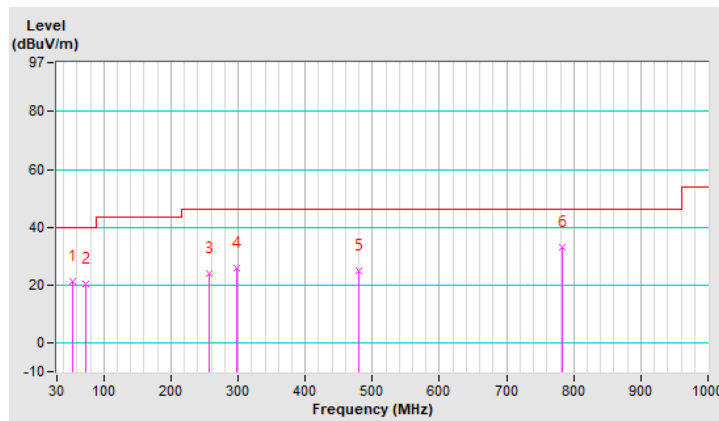

4.2 Conducted Emission Measurement

4.2.1 Limits of Conducted Emission Measurement

Frequency (MHz)	Conducted Limit (dBuV)	
	Quasi-peak	Average
0.15 - 0.5	66 - 56	56 - 46
0.50 - 5.0	56	46
5.0 - 30.0	60	50

Note: 1. The lower limit shall apply at the transition frequencies.

2. The limit decreases in line with the logarithm of the frequency in the range of 0.15 to 0.50MHz.

4.2.2 Test Instruments

Description & Manufacturer	Model No.	Serial No.	Cal. Date	Cal. Due
Test Receiver ROHDE & SCHWARZ	ESCI	100613	Dec. 04, 2020	Dec. 03, 2021
RF signal cable Woken	5D-FB	Cable-cond1-01	Jan. 16, 2021	Jan. 15, 2022
LISN ROHDE & SCHWARZ (EUT)	ENV216	101826	Feb. 25, 2021	Feb. 24, 2022
LISN ROHDE & SCHWARZ (Peripheral)	ESH3-Z5	100311	Sep. 07, 2021	Sep. 06, 2022
Software ADT	BV ADT_Cond_ V7.3.7.4	NA	NA	NA

Note: 1. The calibration interval of the above test instruments is 12 months and the calibrations are traceable to NML/ROC and NIST/USA.

2. The test was performed in HwaYa Shielded Room 1(Conduction 1).

3. The VCCI Site Registration No. is C-12040.

4.2.3 Test Procedures

- The EUT was placed 0.4 meters from the conducting wall of the shielded room with EUT being connected to the power mains through a line impedance stabilization network (LISN). Other support units were connected to the power mains through another LISN. The two LISNs provide 50 ohm/ 50uH of coupling impedance for the measuring instrument.
- Both lines of the power mains connected to the EUT were checked for maximum conducted interference.
- The frequency range from 150kHz to 30MHz was searched. Emission levels under (Limit - 20dB) was not recorded.

Note: The resolution bandwidth and video bandwidth of test receiver is 9kHz for quasi-peak detection (QP) and average detection (AV) at frequency 0.15MHz-30MHz.

4.2.4 Deviation from Test Standard

No deviation.

4.2.5 Test Setup

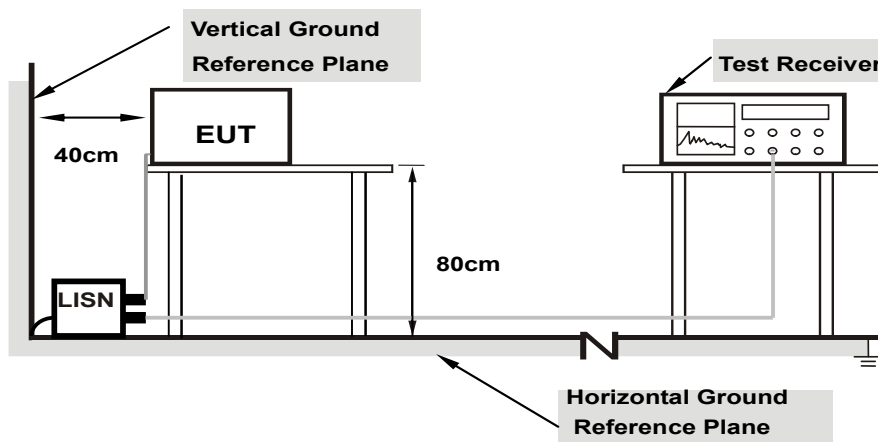

Note: 1.Support units were connected to second LISN.

For the actual test configuration, please refer to the attached file (Test Setup Photo).

4.2.6 EUT Operating Conditions

Same as 4.1.6.

4.2.7 Test Results

Worst-case data:

802.11ax (HE40)

Phase	Line (L)	Detector Function	Quasi-Peak (QP) / Average (AV)
Test Mode	A		

No	Freq. [MHz]	Corr. Factor (dB)	Reading Value [dB (uV)]		Emission Level [dB (uV)]		Limit [dB (uV)]		Margin (dB)	
			Q.P.	AV.	Q.P.	AV.	Q.P.	AV.	Q.P.	AV.
			1	0.15000	9.71	31.63	12.96	41.34	22.67	66.00
2	0.20523	9.71	28.54	10.49	38.25	20.20	63.40	53.40	-25.15	-33.20
3	0.24744	9.71	25.82	10.37	35.53	20.08	61.84	51.84	-26.31	-31.76
4	0.41252	9.73	23.38	16.65	33.11	26.38	57.60	47.60	-24.49	-21.22
5	0.53400	9.74	22.30	3.78	32.04	13.52	56.00	46.00	-23.96	-32.48
6	1.19276	9.76	28.36	3.86	38.12	13.62	56.00	46.00	-17.88	-32.38

Remarks:

1. Q.P. and AV. are abbreviations of quasi-peak and average individually.
2. The emission levels of other frequencies were very low against the limit.
3. Margin value = Emission level - Limit value
4. Correction factor = Insertion loss + Cable loss
5. Emission Level = Correction Factor + Reading Value.

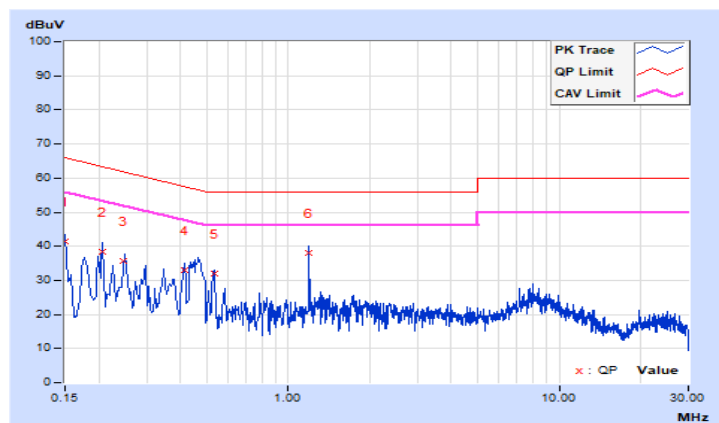

Phase	Neutral (N)	Detector Function	Quasi-Peak (QP) / Average (AV)
Test Mode	A		

No	Freq. [MHz]	Corr. Factor (dB)	Reading Value [dB (uV)]		Emission Level [dB (uV)]		Limit [dB (uV)]		Margin (dB)	
			Q.P.	AV.	Q.P.	AV.	Q.P.	AV.	Q.P.	AV.
			1	0.16755	9.77	29.94	20.82	39.71	30.59	65.08
2	0.18421	9.77	35.59	21.59	45.36	31.36	64.29	54.29	-18.93	-22.93
3	0.32373	9.78	28.16	10.54	37.94	20.32	59.61	49.61	-21.67	-29.29
4	0.37126	9.79	28.24	23.39	38.03	33.18	58.47	48.47	-20.44	-15.29
5	0.43945	9.79	33.28	24.62	43.07	34.41	57.07	47.07	-14.00	-12.66
6	0.46567	9.79	35.04	22.99	44.83	32.78	56.59	46.59	-11.76	-13.81

Remarks:

1. Q.P. and AV. are abbreviations of quasi-peak and average individually.
2. The emission levels of other frequencies were very low against the limit.
3. Margin value = Emission level - Limit value
4. Correction factor = Insertion loss + Cable loss
5. Emission Level = Correction Factor + Reading Value.

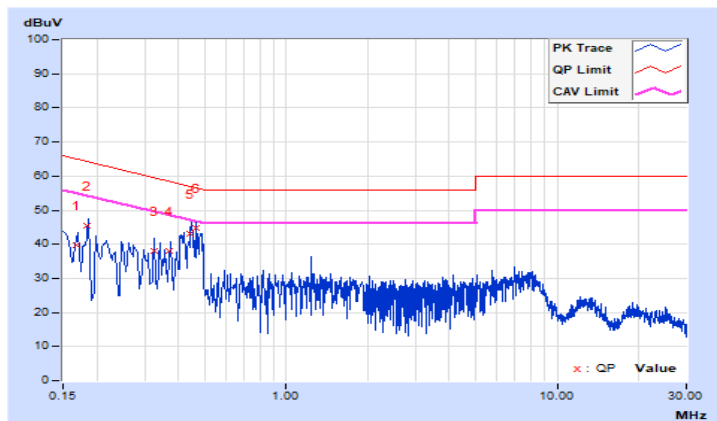

Phase	Line (L)	Detector Function	Quasi-Peak (QP) / Average (AV)
Test Mode	B		

No	Freq. [MHz]	Corr. Factor (dB)	Reading Value [dB (uV)]		Emission Level [dB (uV)]		Limit [dB (uV)]		Margin (dB)	
			Q.P.	AV.	Q.P.	AV.	Q.P.	AV.	Q.P.	AV.
			1	0.16148	9.71	32.87	15.58	42.58	25.29	65.39
2	0.17400	9.71	31.19	14.37	40.90	24.08	64.77	54.77	-23.87	-30.69
3	0.21000	9.71	28.60	11.21	38.31	20.92	63.21	53.21	-24.90	-32.29
4	0.33400	9.72	26.26	11.97	35.98	21.69	59.35	49.35	-23.37	-27.66
5	0.36600	9.73	30.08	19.37	39.81	29.10	58.59	48.59	-18.78	-19.49
6	0.40600	9.73	22.98	7.93	32.71	17.66	57.73	47.73	-25.02	-30.07

Remarks:

1. Q.P. and AV. are abbreviations of quasi-peak and average individually.
2. The emission levels of other frequencies were very low against the limit.
3. Margin value = Emission level - Limit value
4. Correction factor = Insertion loss + Cable loss
5. Emission Level = Correction Factor + Reading Value.

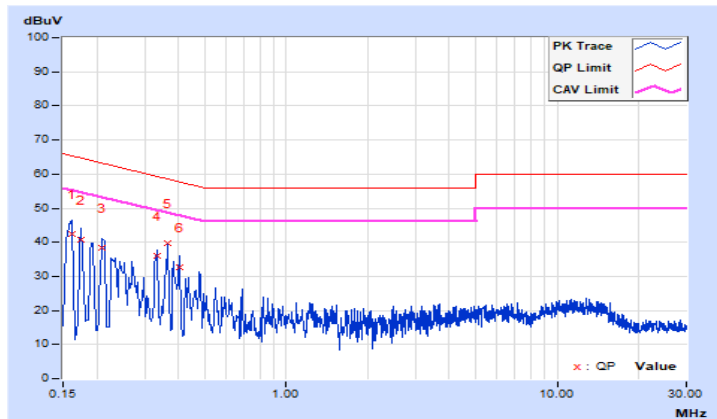

Phase	Neutral (N)	Detector Function	Quasi-Peak (QP) / Average (AV)
Test Mode	B		

No	Freq. [MHz]	Corr. Factor (dB)	Reading Value [dB (uV)]		Emission Level [dB (uV)]		Limit [dB (uV)]		Margin (dB)	
			Q.P.	AV.	Q.P.	AV.	Q.P.	AV.	Q.P.	AV.
			1	0.16600	9.77	27.60	19.85	37.37	29.62	65.16
2	0.43000	9.79	29.86	8.21	39.65	18.00	57.25	47.25	-17.60	-29.25
3	0.52600	9.80	35.95	20.87	45.75	30.67	56.00	46.00	-10.25	-15.33
4	0.65400	9.80	33.17	20.76	42.97	30.56	56.00	46.00	-13.03	-15.44
5	0.72200	9.81	30.85	15.70	40.66	25.51	56.00	46.00	-15.34	-20.49
6	1.04600	9.82	26.36	13.36	36.18	23.18	56.00	46.00	-19.82	-22.82

Remarks:

1. Q.P. and AV. are abbreviations of quasi-peak and average individually.
2. The emission levels of other frequencies were very low against the limit.
3. Margin value = Emission level - Limit value
4. Correction factor = Insertion loss + Cable loss
5. Emission Level = Correction Factor + Reading Value.

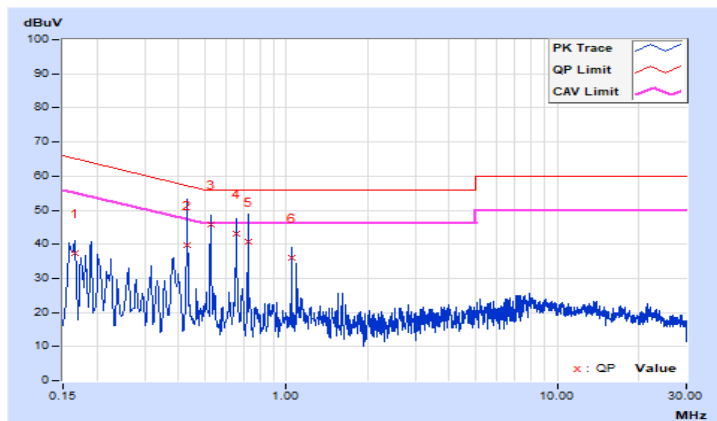

4.3 Transmit Power Measurement

4.3.1 Limits of Transmit Power Measurement

Operation Band	EUT Category		Limit
U-NII-1		Outdoor Access Point	1 Watt (30 dBm) (Max. e.i.r.p \leq 125mW(21 dBm) at any elevation angle above 30 degrees as measured from the horizon)
		Fixed point-to-point Access Point	1 Watt (30 dBm)
	√	Indoor Access Point	1 Watt (30 dBm)
		Mobile and Portable client device	250mW (24 dBm)
U-NII-2A		√	250mW (24 dBm) or 11 dBm+10 log B*
U-NII-2C		√	250mW (24 dBm) or 11 dBm+10 log B*
U-NII-3		√	1 Watt (30 dBm)

*B is the 26 dB emission bandwidth in megahertz

Per KDB 662911 Method of conducted output power measurement on IEEE 802.11 devices,

Array Gain = 0 dB (i.e., no array gain) for $N_{ANT} \leq 4$;

Array Gain = 0 dB (i.e., no array gain) for channel widths ≥ 40 MHz for any N_{ANT} ;

Array Gain = $5 \log(N_{ANT}/N_{SS})$ dB or 3 dB, whichever is less for 20-MHz channel widths with $N_{ANT} \geq 5$.

For power measurements on all other devices: Array Gain = $10 \log(N_{ANT}/N_{SS})$ dB.

4.3.2 Test Setup

For Power Output

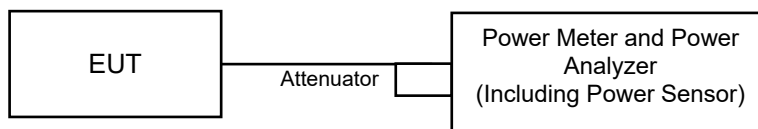

For 26dB Bandwidth

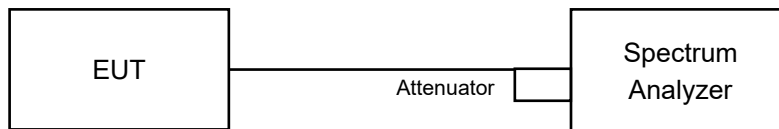

4.3.3 Test Instruments

Refer to section 4.1.2 to get information of above instrument.

4.3.4 Test Procedure

For Average Power Measurement

Method PM is used to perform output power measurement, trigger and gating function of wide band power meter is enabled to measure max output power of TX on burst and set the detector to average. Duty factor is not added to measured value.

For 26dB Bandwidth

- a. Set RBW = approximately 1% of the emission bandwidth.
- b. Set the VBW > RBW.
- c. Detector = Peak.
- d. Trace mode = max hold.
- e. Measure the maximum width of the emission that is 26 dB down from the peak of the emission. Compare this with the RBW setting of the analyzer. Readjust RBW and repeat measurement as needed until the RBW/EBW ratio is approximately 1%.

4.3.5 Deviation from Test Standard

No deviation.

4.3.6 EUT Operating Conditions

The software provided by client to enable the EUT under transmission condition continuously at lowest, middle and highest channel frequencies individually.

4.3.7 Test Result

Power Output:

CDD Mode

802.11a

Chan.	Freq. (MHz)	Maximum Conducted Power (dBm)		Total Power (mW)	Total Power (dBm)	Power Limit (dBm)	Pass / Fail
		Chain 0	Chain 1				
36	5180	23.34	23.32	430.557	26.34	30.00	Pass
40	5200	23.97	23.72	484.964	26.86	30.00	Pass
48	5240	24.33	24.12	529.245	27.24	30.00	Pass
52	5260	19.77	19.44	182.744	22.62	23.95	Pass
60	5300	19.65	19.48	180.973	22.58	23.82	Pass
64	5320	19.69	19.41	180.408	22.56	23.79	Pass
100	5500	19.57	19.38	177.269	22.49	23.92	Pass
116	5580	19.62	19.53	181.365	22.59	23.96	Pass
140	5700	19.78	19.57	185.634	22.69	23.91	Pass
149	5745	24.31	23.99	520.385	27.16	30.00	Pass
157	5785	24.24	24.01	517.228	27.14	30.00	Pass
165	5825	24.25	24.12	524.299	27.20	30.00	Pass

Note:

For U-NII-2A, U-NII-2C Band:

Chain 0

1. $11\text{dBm} + 10\log(19.80) = 23.96 < 24\text{dBm}$
2. $11\text{dBm} + 10\log(19.73) = 23.95 < 24\text{dBm}$
3. $11\text{dBm} + 10\log(19.70) = 23.94 < 24\text{dBm}$
4. $11\text{dBm} + 10\log(19.78) = 23.96 < 24\text{dBm}$
5. $11\text{dBm} + 10\log(19.89) = 23.98 < 24\text{dBm}$
6. $11\text{dBm} + 10\log(19.81) = 23.96 < 24\text{dBm}$

Chain 1

1. $11\text{dBm} + 10\log(19.76) = 23.95 < 24\text{dBm}$
2. $11\text{dBm} + 10\log(19.18) = 23.82 < 24\text{dBm}$
3. $11\text{dBm} + 10\log(19.03) = 23.79 < 24\text{dBm}$
4. $11\text{dBm} + 10\log(19.62) = 23.92 < 24\text{dBm}$
5. $11\text{dBm} + 10\log(19.79) = 23.96 < 24\text{dBm}$
6. $11\text{dBm} + 10\log(19.58) = 23.91 < 24\text{dBm}$

802.11ax (HE20)

Chan.	Freq. (MHz)	Maximum Conducted Power (dBm)		Total Power (mW)	Total Power (dBm)	Power Limit (dBm)	Pass / Fail
		Chain 0	Chain 1				
36	5180	22.18	22.08	326.632	25.14	30.00	Pass
40	5200	22.77	23.49	412.592	26.16	30.00	Pass
48	5240	24.02	23.96	501.234	27.00	30.00	Pass
52	5260	19.68	19.26	177.230	22.49	24.00	Pass
60	5300	19.52	19.35	175.636	22.45	24.00	Pass
64	5320	19.60	19.28	175.924	22.45	24.00	Pass
100	5500	19.54	19.11	171.420	22.34	24.00	Pass
116	5580	19.55	19.26	174.491	22.42	24.00	Pass
140	5700	19.69	19.38	179.807	22.55	24.00	Pass
149	5745	24.01	23.71	486.731	26.87	30.00	Pass
157	5785	24.12	23.68	491.572	26.92	30.00	Pass
165	5825	24.03	23.65	484.669	26.85	30.00	Pass

Note:

For U-NII-2A, U-NII-2C Band:

Chain 0

1. $11\text{dBm} + 10\log(21.11) = 24.24 > 24\text{dBm}$
2. $11\text{dBm} + 10\log(21.14) = 24.25 > 24\text{dBm}$
3. $11\text{dBm} + 10\log(21.18) = 24.25 > 24\text{dBm}$
4. $11\text{dBm} + 10\log(21.23) = 24.26 > 24\text{dBm}$
5. $11\text{dBm} + 10\log(21.26) = 24.27 > 24\text{dBm}$
6. $11\text{dBm} + 10\log(21.15) = 24.25 > 24\text{dBm}$

Chain 1

1. $11\text{dBm} + 10\log(20.91) = 24.20 > 24\text{dBm}$
2. $11\text{dBm} + 10\log(21.00) = 24.22 > 24\text{dBm}$
3. $11\text{dBm} + 10\log(20.96) = 24.21 > 24\text{dBm}$
4. $11\text{dBm} + 10\log(20.89) = 24.19 > 24\text{dBm}$
5. $11\text{dBm} + 10\log(21.08) = 24.23 > 24\text{dBm}$
6. $11\text{dBm} + 10\log(20.95) = 24.21 > 24\text{dBm}$

802.11ax (HE40)

Chan.	Freq. (MHz)	Maximum Conducted Power (dBm)		Total Power (mW)	Total Power (dBm)	Power Limit (dBm)	Pass / Fail
		Chain 0	Chain 1				
38	5190	18.71	18.67	147.923	21.70	30.00	Pass
46	5230	19.05	18.99	159.603	22.03	30.00	Pass
54	5270	20.85	20.57	235.644	23.72	24.00	Pass
62	5310	20.73	20.41	228.205	23.58	24.00	Pass
102	5510	20.78	20.47	231.104	23.64	24.00	Pass
110	5550	20.80	20.51	232.687	23.67	24.00	Pass
134	5670	20.79	20.52	232.670	23.67	24.00	Pass
151	5755	25.22	25.02	650.347	28.13	30.00	Pass
159	5795	25.24	25.08	656.302	28.17	30.00	Pass

Note:

For U-NII-2A, U-NII-2C Band:

Chain 0

1. $11\text{dBm} + 10\log(41.59) = 27.18 > 24\text{dBm}$
2. $11\text{dBm} + 10\log(41.44) = 27.17 > 24\text{dBm}$
3. $11\text{dBm} + 10\log(41.63) = 27.19 > 24\text{dBm}$
4. $11\text{dBm} + 10\log(41.71) = 27.20 > 24\text{dBm}$
5. $11\text{dBm} + 10\log(41.43) = 27.17 > 24\text{dBm}$

Chain 1

1. $11\text{dBm} + 10\log(41.61) = 27.19 > 24\text{dBm}$
2. $11\text{dBm} + 10\log(41.70) = 27.20 > 24\text{dBm}$
3. $11\text{dBm} + 10\log(41.50) = 27.18 > 24\text{dBm}$
4. $11\text{dBm} + 10\log(41.58) = 27.18 > 24\text{dBm}$
5. $11\text{dBm} + 10\log(41.69) = 27.20 > 24\text{dBm}$

802.11ax (HE80)

Chan.	Freq. (MHz)	Maximum Conducted Power (dBm)		Total Power (mW)	Total Power (dBm)	Power Limit (dBm)	Pass / Fail
		Chain 0	Chain 1				
42	5210	18.07	18.27	131.264	21.18	30.00	Pass
58	5290	20.71	20.55	231.262	23.64	24.00	Pass
106	5530	20.33	19.93	206.296	23.14	24.00	Pass
122	5610	20.72	20.58	232.320	23.66	24.00	Pass
155	5775	23.51	23.47	446.719	26.50	30.00	Pass

Note:

For U-NII-2A, U-NII-2C Band:

Chain 0

1. $11\text{dBm} + 10\log(82.59) = 30.16 > 24\text{dBm}$
2. $11\text{dBm} + 10\log(82.33) = 30.15 > 24\text{dBm}$
3. $11\text{dBm} + 10\log(82.27) = 30.15 > 24\text{dBm}$

Chain 1

1. $11\text{dBm} + 10\log(82.62) = 30.17 > 24\text{dBm}$
2. $11\text{dBm} + 10\log(82.61) = 30.17 > 24\text{dBm}$
3. $11\text{dBm} + 10\log(82.07) = 30.14 > 24\text{dBm}$

802.11ax (HE160)

Chan.	Freq. (MHz)	Maximum Conducted Power (dBm)		Total Power (mW)	Total Power (dBm)	Power Limit (dBm)	Pass / Fail
		Chain 0	Chain 1				
*50	5250 (For U-NII-1)	16.22	16.20	83.566	19.22	30.00	Pass
*50	5250 (For U-NII-2A)	15.68	16.15	78.193	18.93	24.00	Pass
114	5570	17.31	17.24	106.793	20.29	24.00	Pass

Note:

For U-NII-2A, U-NII-2C Band:

Chain 0

1. $11\text{dBm} + 10\log(83.64) = 30.22 > 24\text{dBm}$
2. $11\text{dBm} + 10\log(168.16) = 33.25 > 24\text{dBm}$

Chain 1

1. $11\text{dBm} + 10\log(83.21) = 30.20 > 24\text{dBm}$
2. $11\text{dBm} + 10\log(167.42) = 33.23 > 24\text{dBm}$

Beamforming Mode

802.11ax (HE20)

Chan.	Freq. (MHz)	Maximum Conducted Power (dBm)		Total Power (mW)	Total Power (dBm)	Power Limit (dBm)	Pass / Fail
		Chain 0	Chain 1				
36	5180	22.18	22.08	326.632	25.14	29.43	Pass
40	5200	22.77	23.49	412.592	26.16	29.43	Pass
48	5240	24.02	23.96	501.234	27.00	29.43	Pass
52	5260	19.68	19.26	177.230	22.49	23.43	Pass
60	5300	19.52	19.35	175.636	22.45	23.43	Pass
64	5320	19.60	19.28	175.924	22.45	23.43	Pass
100	5500	19.54	19.11	171.420	22.34	23.21	Pass
116	5580	19.55	19.26	174.491	22.42	23.21	Pass
140	5700	19.69	19.38	179.807	22.55	23.21	Pass
149	5745	24.01	23.71	486.731	26.87	29.21	Pass
157	5785	24.12	23.68	491.572	26.92	29.21	Pass
165	5825	24.03	23.65	484.669	26.85	29.21	Pass

Note:

1. For U-NII-1, Directional gain = $10 \log[(10^{G1/20} + 10^{G2/20} + \dots + 10^{GN/20})^2/2] = 6.57\text{dBi} > 6\text{dBi}$, so the limit shall be reduced to $30-(6.57-6) = 29.43\text{dBm}$.
2. For U-NII-2A, Directional gain = $10 \log[(10^{G1/20} + 10^{G2/20} + \dots + 10^{GN/20})^2/2] = 6.57\text{dBi} > 6\text{dBi}$, so the limit shall be reduced to $24-(6.57-6) = 23.43\text{dBm}$.
3. For U-NII-2C, Directional gain = $10 \log[(10^{G1/20} + 10^{G2/20} + \dots + 10^{GN/20})^2/2] = 6.79\text{dBi} > 6\text{dBi}$, so the limit shall be reduced to $24-(6.79-6) = 23.21\text{dBm}$.
4. For U-NII-3, Directional gain = $10 \log[(10^{G1/20} + 10^{G2/20} + \dots + 10^{GN/20})^2/2] = 6.79\text{dBi} > 6\text{dBi}$, so the limit shall be reduced to $30-(6.79-6) = 29.21\text{dBm}$.

Note:

For U-NII-2A, U-NII-2C Band:

Chain 0

1. $11\text{dBm} + 10\log(21.11) = 24.24 > 24\text{dBm}$
2. $11\text{dBm} + 10\log(21.14) = 24.25 > 24\text{dBm}$
3. $11\text{dBm} + 10\log(21.18) = 24.25 > 24\text{dBm}$
4. $11\text{dBm} + 10\log(21.23) = 24.26 > 24\text{dBm}$
5. $11\text{dBm} + 10\log(21.26) = 24.27 > 24\text{dBm}$
6. $11\text{dBm} + 10\log(21.15) = 24.25 > 24\text{dBm}$

Chain 1

1. $11\text{dBm} + 10\log(20.91) = 24.20 > 24\text{dBm}$
2. $11\text{dBm} + 10\log(21.00) = 24.22 > 24\text{dBm}$
3. $11\text{dBm} + 10\log(20.96) = 24.21 > 24\text{dBm}$
4. $11\text{dBm} + 10\log(20.89) = 24.19 > 24\text{dBm}$
5. $11\text{dBm} + 10\log(21.08) = 24.23 > 24\text{dBm}$
6. $11\text{dBm} + 10\log(20.95) = 24.21 > 24\text{dBm}$

802.11ax (HE40)

Chan.	Freq. (MHz)	Maximum Conducted Power (dBm)		Total Power (mW)	Total Power (dBm)	Power Limit (dBm)	Pass / Fail
		Chain 0	Chain 1				
38	5190	18.71	18.67	147.923	21.70	29.43	Pass
46	5230	19.05	18.99	159.603	22.03	29.43	Pass
54	5270	20.31	20.04	208.324	23.19	23.43	Pass
62	5310	20.21	19.93	203.355	23.08	23.43	Pass
102	5510	20.22	19.96	204.279	23.10	23.21	Pass
110	5550	20.25	19.97	205.237	23.12	23.21	Pass
134	5670	20.24	20.01	205.912	23.14	23.21	Pass
151	5755	25.22	25.02	650.347	28.13	29.21	Pass
159	5795	25.24	25.08	656.302	28.17	29.21	Pass

Note:

1. For U-NII-1, Directional gain = $10 \log[(10^{G1/20} + 10^{G2/20} + \dots + 10^{GN/20})^2/2] = 6.57\text{dBi} > 6\text{dBi}$, so the limit shall be reduced to $30-(6.57-6) = 29.43\text{dBm}$.
2. For U-NII-2A, Directional gain = $10 \log[(10^{G1/20} + 10^{G2/20} + \dots + 10^{GN/20})^2/2] = 6.57\text{dBi} > 6\text{dBi}$, so the limit shall be reduced to $24-(6.57-6) = 23.43\text{dBm}$.
3. For U-NII-2C, Directional gain = $10 \log[(10^{G1/20} + 10^{G2/20} + \dots + 10^{GN/20})^2/2] = 6.79\text{dBi} > 6\text{dBi}$, so the limit shall be reduced to $24-(6.79-6) = 23.21\text{dBm}$.
4. For U-NII-3, Directional gain = $10 \log[(10^{G1/20} + 10^{G2/20} + \dots + 10^{GN/20})^2/2] = 6.79\text{dBi} > 6\text{dBi}$, so the limit shall be reduced to $30-(6.79-6) = 29.21\text{dBm}$.

Note:

For U-NII-2A, U-NII-2C Band:

Chain 0

1. $11\text{dBm} + 10\log(41.59) = 27.18 > 24\text{dBm}$
2. $11\text{dBm} + 10\log(41.44) = 27.17 > 24\text{dBm}$
3. $11\text{dBm} + 10\log(41.63) = 27.19 > 24\text{dBm}$
4. $11\text{dBm} + 10\log(41.71) = 27.20 > 24\text{dBm}$
5. $11\text{dBm} + 10\log(41.43) = 27.17 > 24\text{dBm}$

Chain 1

1. $11\text{dBm} + 10\log(41.61) = 27.19 > 24\text{dBm}$
2. $11\text{dBm} + 10\log(41.70) = 27.20 > 24\text{dBm}$
3. $11\text{dBm} + 10\log(41.50) = 27.18 > 24\text{dBm}$
4. $11\text{dBm} + 10\log(41.58) = 27.18 > 24\text{dBm}$
5. $11\text{dBm} + 10\log(41.69) = 27.20 > 24\text{dBm}$

802.11ax (HE80)

Chan.	Freq. (MHz)	Maximum Conducted Power (dBm)		Total Power (mW)	Total Power (dBm)	Power Limit (dBm)	Pass / Fail
		Chain 0	Chain 1				
42	5210	18.07	18.27	131.264	21.18	29.43	Pass
58	5290	20.15	20.03	204.207	23.10	23.43	Pass
106	5530	20.33	19.93	206.296	23.14	23.21	Pass
122	5610	20.17	20.06	205.383	23.13	23.21	Pass
155	5775	23.51	23.47	446.719	26.50	29.21	Pass

Note:

1. For U-NII-1, Directional gain = $10 \log[(10^{G1/20} + 10^{G2/20} + \dots + 10^{GN/20})^2/2] = 6.57\text{dBi} > 6\text{dBi}$, so the limit shall be reduced to $30-(6.57-6) = 29.43\text{dBm}$.
2. For U-NII-2A, Directional gain = $10 \log[(10^{G1/20} + 10^{G2/20} + \dots + 10^{GN/20})^2/2] = 6.57\text{dBi} > 6\text{dBi}$, so the limit shall be reduced to $24-(6.57-6) = 23.43\text{dBm}$.
3. For U-NII-2C, Directional gain = $10 \log[(10^{G1/20} + 10^{G2/20} + \dots + 10^{GN/20})^2/2] = 6.79\text{dBi} > 6\text{dBi}$, so the limit shall be reduced to $24-(6.79-6) = 23.21\text{dBm}$.
4. For U-NII-3, Directional gain = $10 \log[(10^{G1/20} + 10^{G2/20} + \dots + 10^{GN/20})^2/2] = 6.79\text{dBi} > 6\text{dBi}$, so the limit shall be reduced to $30-(6.79-6) = 29.21\text{dBm}$.

Note:

For U-NII-2A, U-NII-2C Band:

Chain 0

1. $11\text{dBm} + 10\log(82.59) = 30.16 > 24\text{dBm}$
2. $11\text{dBm} + 10\log(82.33) = 30.15 > 24\text{dBm}$
3. $11\text{dBm} + 10\log(82.27) = 30.15 > 24\text{dBm}$

Chain 1

1. $11\text{dBm} + 10\log(82.62) = 30.17 > 24\text{dBm}$
2. $11\text{dBm} + 10\log(82.61) = 30.17 > 24\text{dBm}$
3. $11\text{dBm} + 10\log(82.07) = 30.14 > 24\text{dBm}$

802.11ax (HE160)

Chan.	Freq. (MHz)	Maximum Conducted Power (dBm)		Total Power (mW)	Total Power (dBm)	Power Limit (dBm)	Pass / Fail
		Chain 0	Chain 1				
*50	5250 (For U-NII-1)	16.22	16.20	83.566	19.22	29.43	Pass
*50	5250 (For U-NII-2A)	15.68	16.15	78.193	18.93	23.43	Pass
114	5570	17.31	17.24	106.793	20.29	23.21	Pass

Note:

1. For U-NII-1, Directional gain = $10 \log[(10^{G1/20} + 10^{G2/20} + \dots + 10^{GN/20})^2/2] = 6.57\text{dBi} > 6\text{dBi}$, so the limit shall be reduced to $30 - (6.57 - 6) = 29.43\text{dBm}$.
2. For U-NII-2A, Directional gain = $10 \log[(10^{G1/20} + 10^{G2/20} + \dots + 10^{GN/20})^2/2] = 6.57\text{dBi} > 6\text{dBi}$, so the limit shall be reduced to $24 - (6.57 - 6) = 23.43\text{dBm}$.
3. For U-NII-2C, Directional gain = $10 \log[(10^{G1/20} + 10^{G2/20} + \dots + 10^{GN/20})^2/2] = 6.79\text{dBi} > 6\text{dBi}$, so the limit shall be reduced to $24 - (6.79 - 6) = 23.21\text{dBm}$.

Note:

For U-NII-2A, U-NII-2C Band:

Chain 0

1. $11\text{dBm} + 10\log(83.64) = 30.22 > 24\text{dBm}$
2. $11\text{dBm} + 10\log(168.16) = 33.25 > 24\text{dBm}$

Chain 1

1. $11\text{dBm} + 10\log(83.21) = 30.20 > 24\text{dBm}$
2. $11\text{dBm} + 10\log(167.42) = 33.23 > 24\text{dBm}$

26dB Bandwidth:

802.11a

Chan.	Freq. (MHz)	26dBc Bandwidth (MHz)	
		Chain 0	Chain 1
52	5260	19.80	19.76
60	5300	19.73	19.18
64	5320	19.70	19.03
100	5500	19.78	19.62
116	5580	19.89	19.79
140	5700	19.81	19.58

802.11ax (HE20)

Chan.	Freq. (MHz)	26dBc Bandwidth (MHz)	
		Chain 0	Chain 1
52	5260	21.11	20.91
60	5300	21.14	21.00
64	5320	21.18	20.96
100	5500	21.23	20.89
116	5580	21.26	21.08
140	5700	21.15	20.95

802.11ax (HE40)

Chan.	Freq. (MHz)	26dBc Bandwidth (MHz)	
		Chain 0	Chain 1
54	5270	41.59	41.61
62	5310	41.44	41.70
102	5510	41.63	41.50
110	5550	41.71	41.58
134	5670	41.43	41.69

802.11ax (HE80)

Chan.	Freq. (MHz)	26dBc Bandwidth (MHz)	
		Chain 0	Chain 1
58	5290	82.59	82.62
106	5530	82.33	82.61
122	5610	82.27	82.07

802.11ax (HE160)

Chan.	Freq. (MHz)	26dBc Bandwidth (MHz)	
		Chain 0	Chain 1
50 (U-NII-1 Band)	5250	83.78	83.71
50 (U-NII-2A Band)	5250	83.64	83.21
114	5570	168.16	167.42

Spectrum Plot of Worst Value

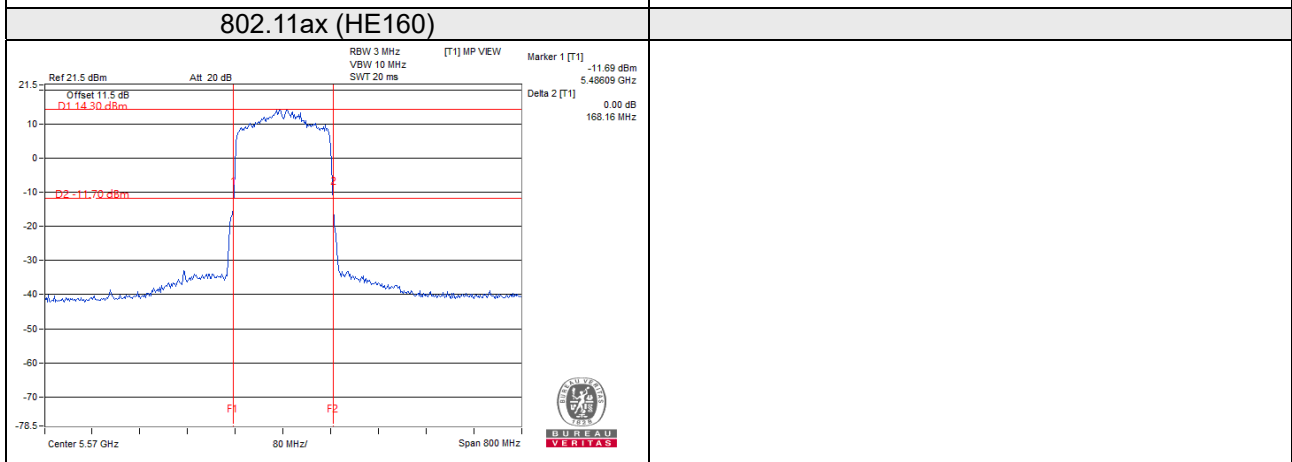
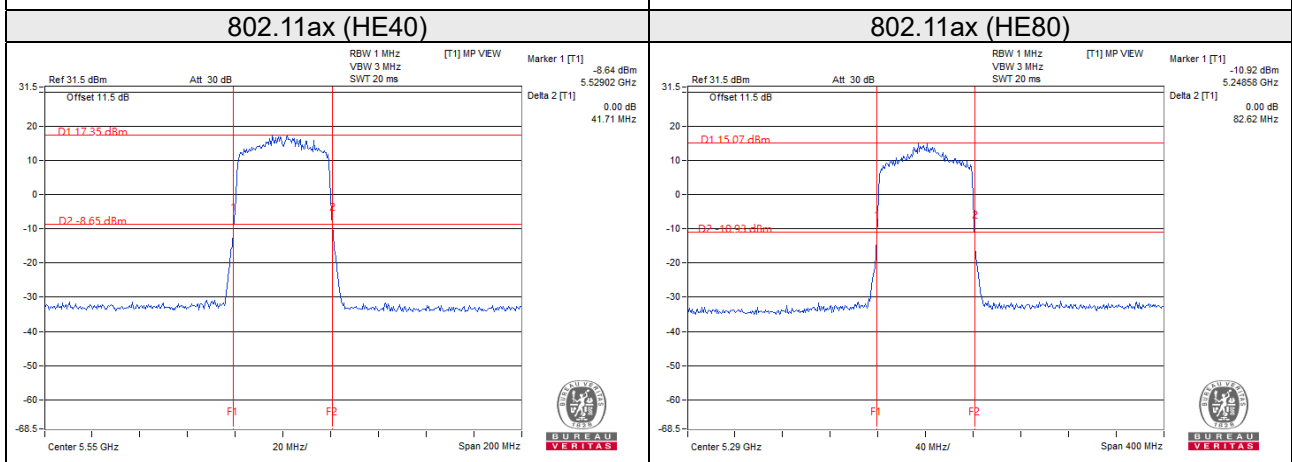
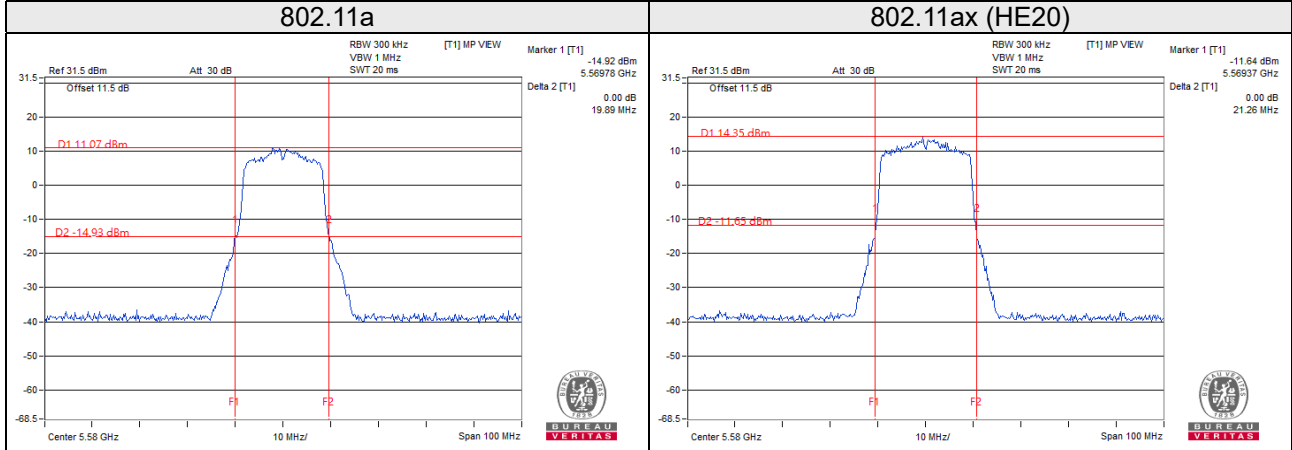

EUT Maximum Conducted Power

CDD Mode

802.11a

Frequency Band (MHz)	Max. Power	
	Output Power (mW)	Output Power (dBm)
5250~5350	182.744	22.62
5470~5725	185.634	22.69

802.11ax (HE20)

Frequency Band (MHz)	Max. Power	
	Output Power (mW)	Output Power (dBm)
5250~5350	177.230	22.49
5470~5725	179.807	22.55

802.11ax (HE40)

Frequency Band (MHz)	Max. Power	
	Output Power (mW)	Output Power (dBm)
5250~5350	235.644	23.72
5470~5725	232.687	23.67

802.11ax (HE80)

Frequency Band (MHz)	Max. Power	
	Output Power (mW)	Output Power (dBm)
5250~5350	231.262	23.64
5470~5725	232.320	23.66

802.11ax (HE160)

Frequency Band (MHz)	Max. Power	
	Output Power (mW)	Output Power (dBm)
5250~5350	78.193	18.93
5470~5725	106.793	20.29

Beamforming Mode

802.11ax (HE20)

Frequency Band (MHz)	Max. Power	
	Output Power (mW)	Output Power (dBm)
5250~5350	177.230	22.49
5470~5725	179.807	22.55

802.11ax (HE40)

Frequency Band (MHz)	Max. Power	
	Output Power (mW)	Output Power (dBm)
5250~5350	208.324	23.19
5470~5725	205.912	23.14

802.11ax (HE80)

Frequency Band (MHz)	Max. Power	
	Output Power (mW)	Output Power (dBm)
5250~5350	204.207	23.10
5470~5725	206.296	23.14

802.11ax (HE160)

Frequency Band (MHz)	Max. Power	
	Output Power (mW)	Output Power (dBm)
5250~5350	78.193	18.93
5470~5725	106.793	20.29

4.4 Occupied Bandwidth Measurement

4.4.1 Test Setup

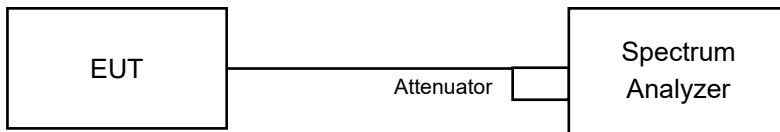

4.4.2 Test Instruments

Refer to section 4.1.2 to get information of above instrument.

4.4.3 Test Procedure

The transmitter output was connected to the spectrum analyzer through an attenuator. The bandwidth of the fundamental frequency was measured by spectrum analyzer with resolution bandwidth in the range of 1% to 5% of the anticipated emission bandwidth, and a video bandwidth at least 3x the resolution bandwidth and set the detector to sampling. The width of a frequency band such that, below the lower and above the upper frequency limits, the mean powers emitted are each equal to a specified percentage 0.5 %of the total mean power of a given emission.

4.4.4 Test Result

802.11a

Chan.	Freq. (MHz)	Occupied Bandwidth (MHz)	
		Chain 0	Chain 1
36	5180	16.44	16.32
40	5200	16.32	16.32
48	5240	16.32	16.32
52	5260	16.32	16.32
60	5300	16.44	16.32
64	5320	16.32	16.20
100	5500	16.32	16.32
116	5580	16.32	16.32
140	5700	16.32	16.32
149	5745	16.44	16.32
157	5785	16.44	16.32
165	5825	16.32	16.44

802.11ax (HE20)

Chan.	Freq. (MHz)	Occupied Bandwidth (MHz)	
		Chain 0	Chain 1
36	5180	18.84	18.84
40	5200	18.84	18.84
48	5240	18.84	18.84
52	5260	18.84	18.84
60	5300	18.84	18.84
64	5320	18.84	18.84
100	5500	18.84	18.84
116	5580	18.84	18.84
140	5700	18.84	18.84
149	5745	18.84	18.84
157	5785	18.84	18.84
165	5825	18.84	18.84

802.11ax (HE40)

Chan.	Freq. (MHz)	Occupied Bandwidth (MHz)	
		Chain 0	Chain 1
38	5190	37.80	37.80
46	5230	37.80	37.80
54	5270	37.80	37.80
62	5310	37.80	37.92
102	5510	37.80	37.80
110	5550	37.80	37.80
134	5670	37.80	37.80
151	5755	37.80	37.92
159	5795	37.80	37.80

802.11ax (HE80)

Chan.	Freq. (MHz)	Occupied Bandwidth (MHz)	
		Chain 0	Chain 1
42	5210	76.80	76.80
58	5290	76.80	76.80
106	5530	76.80	76.80
122	5610	76.80	76.80
155	5775	77.04	76.56

802.11ax (HE160)

Chan.	Freq. (MHz)	Occupied Bandwidth (MHz)	
		Chain 0	Chain 1
50 (U-NII-1 Band)	5250	77.76	77.76
50 (U-NII-2A Band)	5250	76.80	76.80
114	5570	155.52	154.56

Spectrum Plot of Worst Value

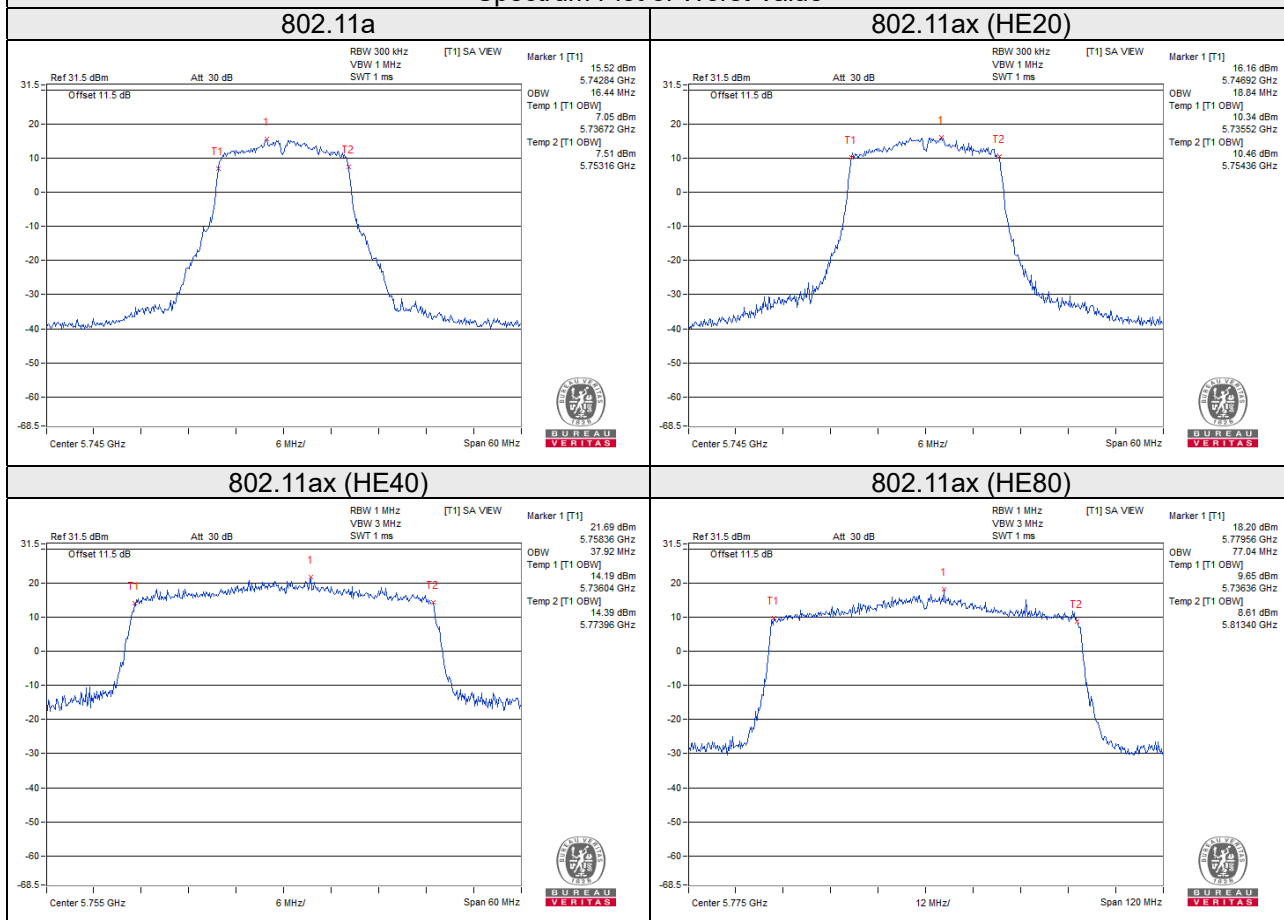

802.11ax (HE160)

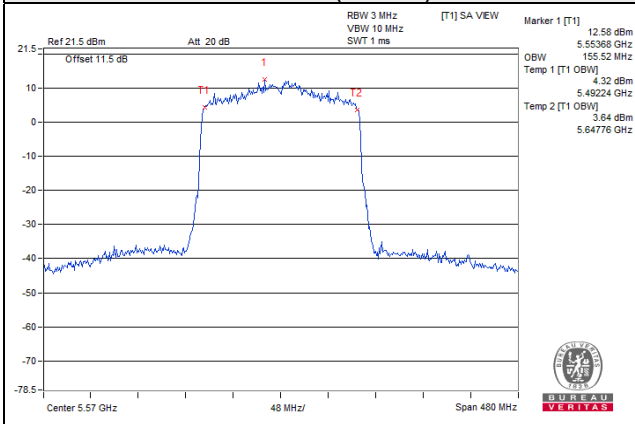

Spectrum Plot for near By DFS Band

802.11a / Chain 0 / CH 48

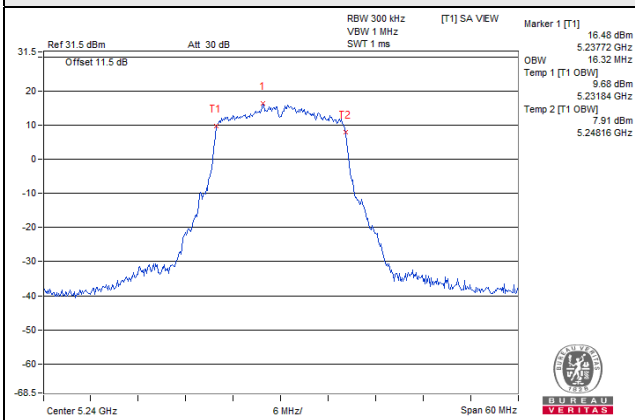

802.11a / Chain 1 / CH 48

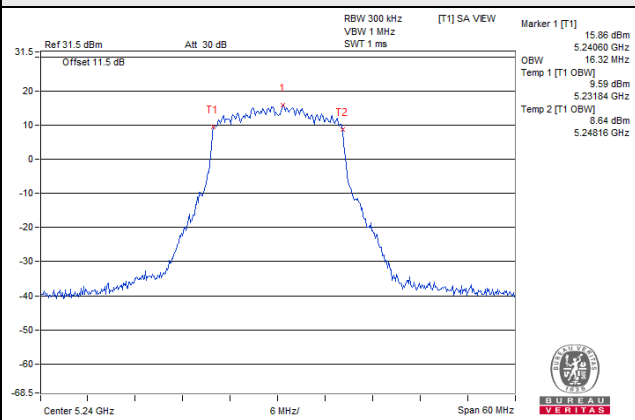

802.11ax (HE20) / Chain 0 / CH 48

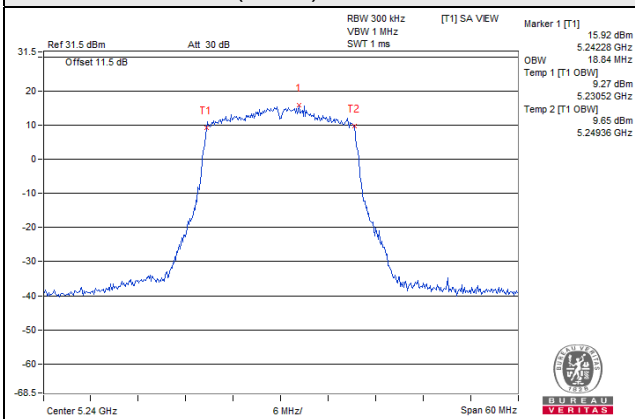

802.11ax (HE20) / Chain 1 / CH 48

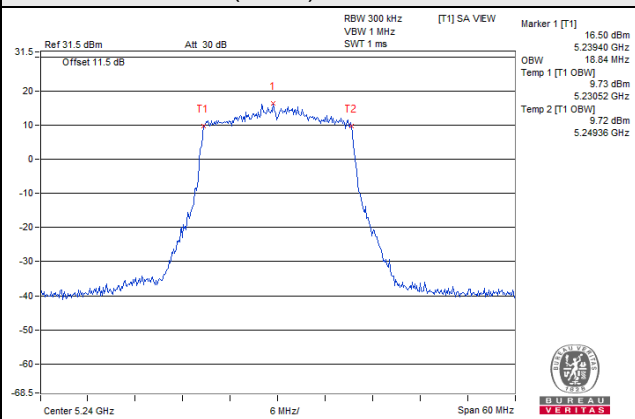

802.11ax (HE40) / Chain 0 / CH 46

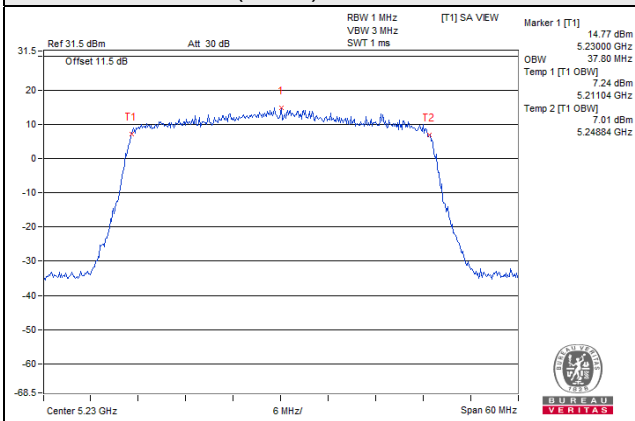

802.11ax (HE40) / Chain 1 / CH 46

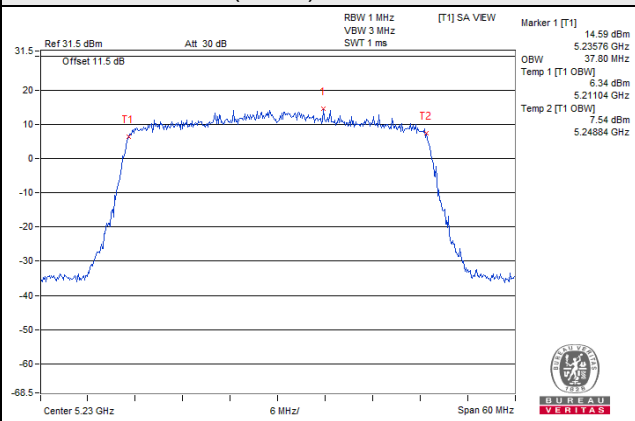

802.11ax (HE80) / Chain 0 / CH 42

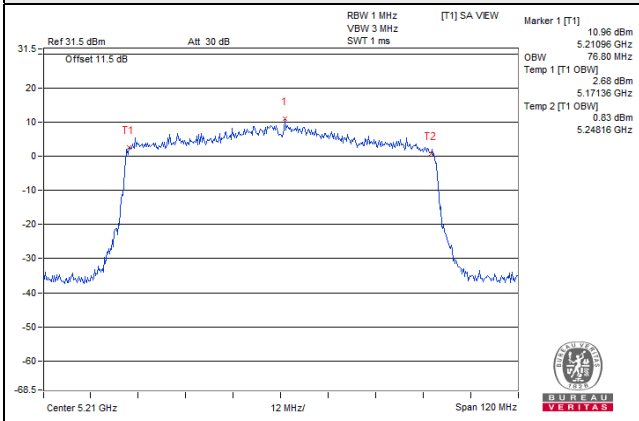

802.11ax (HE80) / Chain 1 / CH 42

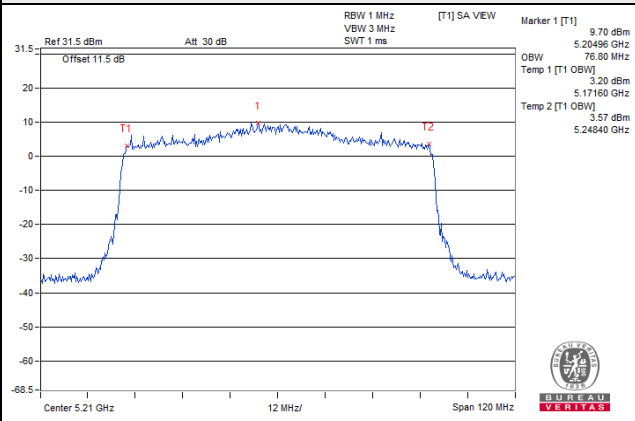

Spectrum Plot for near By DFS Band

802.11a / Chain 0 / CH 149

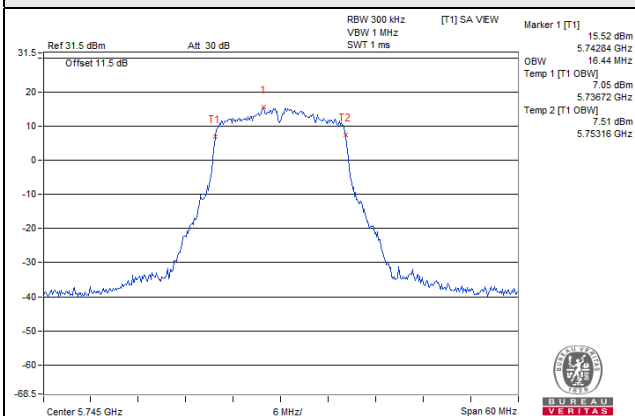

802.11a / Chain 1 / CH 149

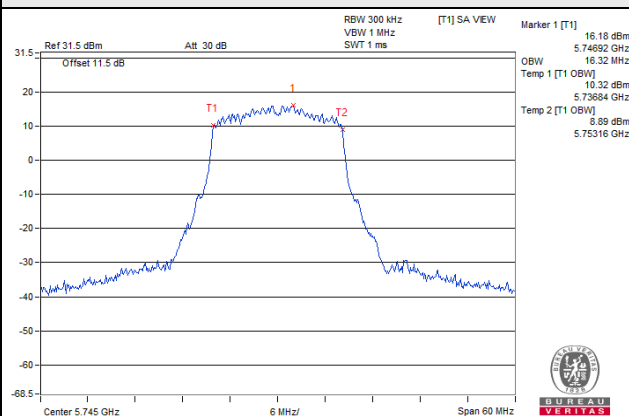

802.11ax (HE20) / Chain 0 / CH 149

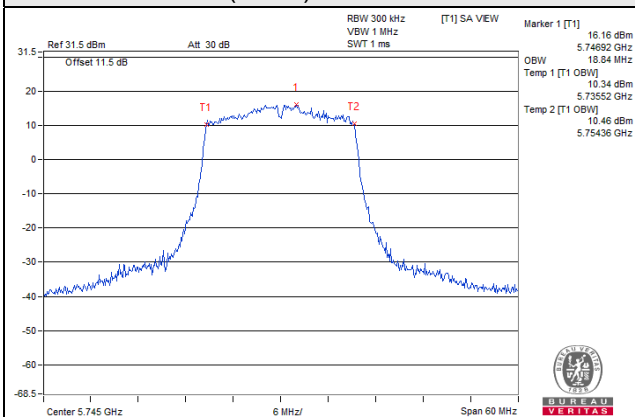

802.11ax (HE20) / Chain 1 / CH 149

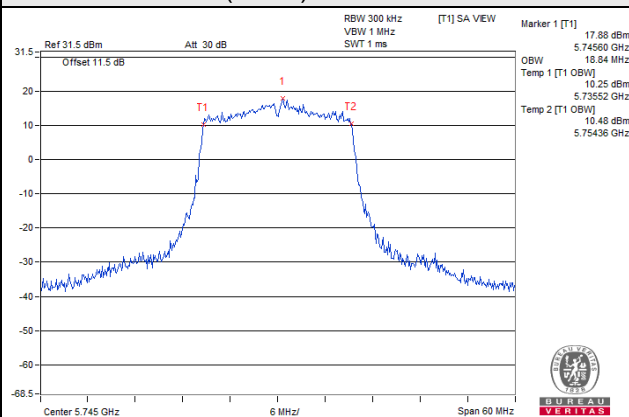

802.11ax (HE40) / Chain 0 / CH 151

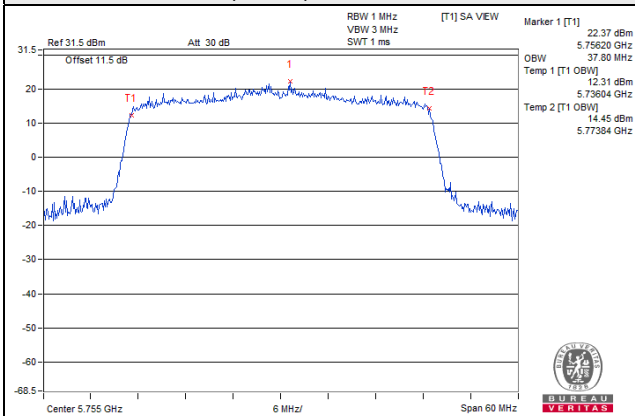

802.11ax (HE40) / Chain 1 / CH 151

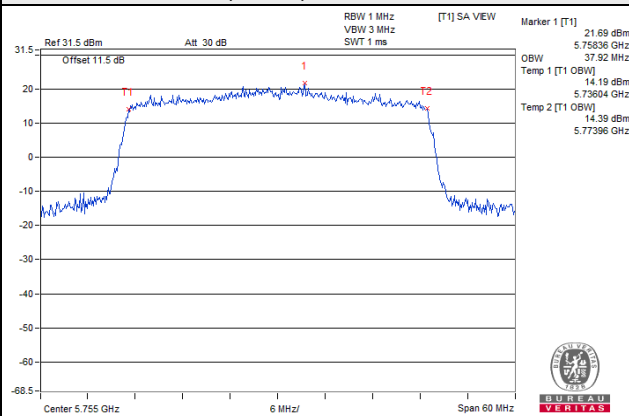

802.11ax (HE80) / Chain 0 / CH 155

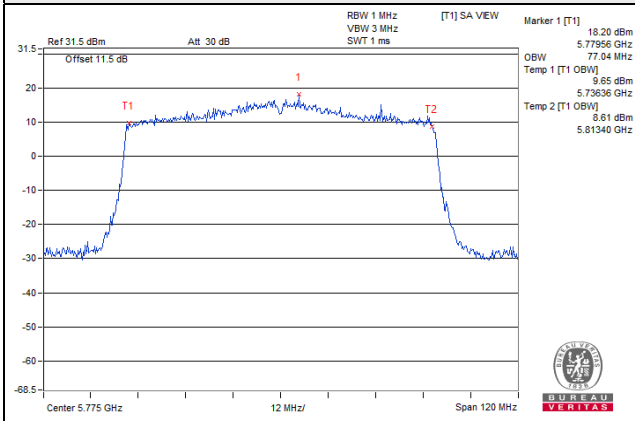

802.11ax (HE80) / Chain 1 / CH 155

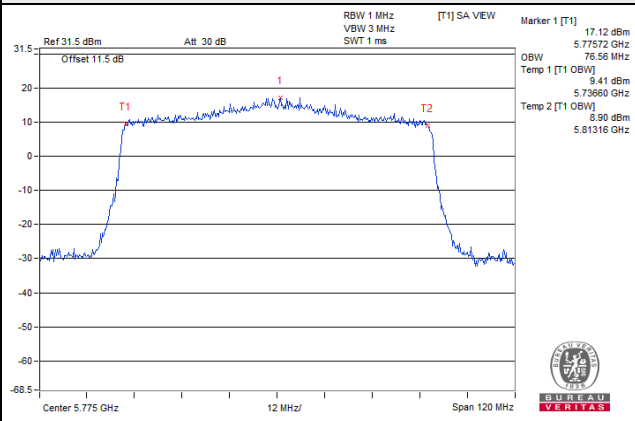

4.5 Peak Power Spectral Density Measurement

4.5.1 Limits of Peak Power Spectral Density Measurement

Operation Band	EUT Category		Limit
U-NII-1		Outdoor Access Point	17dBm/ MHz
		Fixed point-to-point Access Point	
	√	Indoor Access Point	
		Mobile and Portable client device	11dBm/ MHz
U-NII-2A	√		11dBm/ MHz
U-NII-2C	√		11dBm/ MHz
U-NII-3	√		30dBm/ 500kHz

4.5.2 Test Setup

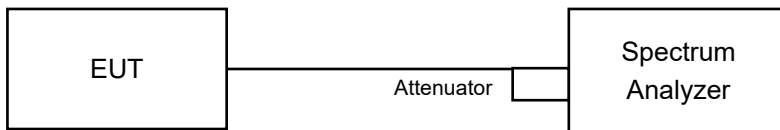

4.5.3 Test Instruments

Refer to section 4.1.2 to get information of above instrument.

4.5.4 Test Procedures

For U-NII-1, U-NII-2A and U-NII-2C band:

Duty cycle of test signal is < 98%

Using method SA-2

- Set span to encompass the entire emission bandwidth (EBW) of the signal.
- Set RBW = 1MHz, Set VBW \geq 3 MHz, Detector = RMS
- Set Channel power measure = 1MHz
- Sweep time = auto, trigger set to "free run".
- Trace average at least 100 traces in power averaging mode.
- Record the max value and add $10 \log (1/\text{duty cycle})$

For U-NII-3 band:

Duty cycle of test signal is < 98%

- a. Set span to encompass the entire emission bandwidth (EBW) of the signal.
- b. Set RBW = 300 kHz, Set VBW \geq 1 MHz, Detector = RMS
- c. Use the peak marker function to determine the maximum power level in any 300 kHz band segment within the fundamental EBW.
- d. Scale the observed power level to an equivalent value in 500 kHz by adjusting (increasing) the measured power by a bandwidth correction factor (BWCF) where $BWCF = 10\log(500 \text{ kHz} / 300 \text{ kHz})$
- e. Sweep time = auto, trigger set to "free run".
- f. Trace average at least 100 traces in power averaging mode.
- g. Record the max value and add $10 \log (1/\text{duty cycle})$

4.5.5 Deviation from Test Standard

No deviation.

4.5.6 EUT Operating Conditions

Same as 4.3.6.

4.5.7 Test Results

For U-NII-1, U-NII-2A and U-NII-2C band:

802.11a

Chan.	Freq. (MHz)	PSD w/o Duty Factor (dBm/MHz)		Duty Factor (dB)	Total PSD with Duty Factor (dBm/MHz)	Max. Limit (dBm/MHz)	Pass / Fail
		Chain 0	Chain 1				
36	5180	10.58	10.61	0.35	13.95	16.43	Pass
40	5200	11.26	11.05	0.35	14.51	16.43	Pass
48	5240	11.75	11.43	0.35	14.95	16.43	Pass
52	5260	6.82	6.57	0.35	10.05	10.43	Pass
60	5300	6.90	6.71	0.35	10.16	10.43	Pass
64	5320	7.07	7.03	0.35	10.41	10.43	Pass
100	5500	6.58	6.84	0.35	10.07	10.21	Pass
116	5580	6.86	6.79	0.35	10.18	10.21	Pass
140	5700	6.79	6.81	0.35	10.16	10.21	Pass

Note:

- Method E) 2) a) of power density measurement of KDB 662911 is using for calculating total power density. Total power density is summing entire spectra across corresponding frequency bins on the various outputs by computer.
- For U-NII-1 band: Directional gain = $10 \log[(10^{G1/20} + 10^{G2/20} + \dots + 10^{GN/20})^2/2] = 6.57\text{dBi} > 6\text{dBi}$, so the power density limit shall be reduced to $17-(6.57-6) = 16.43\text{dBm}$.
For U-NII-2A band: Directional gain = $10 \log[(10^{G1/20} + 10^{G2/20} + \dots + 10^{GN/20})^2/2] = 6.57\text{dBi} > 6\text{dBi}$, so the power density limit shall be reduced to $11-(6.57-6) = 10.43\text{dBm}$.
For U-NII-2C band: Directional gain = $10 \log[(10^{G1/20} + 10^{G2/20} + \dots + 10^{GN/20})^2/2] = 6.79\text{dBi} > 6\text{dBi}$, so the power density limit shall be reduced to $11-(6.79-6) = 10.21\text{dBm}$.
- Refer to section 3.3 for duty cycle spectrum plot.

802.11ax (HE20)

Chan.	Freq. (MHz)	PSD w/o Duty Factor (dBm/MHz)		Duty Factor (dB)	Total PSD with Duty Factor (dBm/MHz)	Max. Limit (dBm/MHz)	Pass / Fail
		Chain 0	Chain 1				
36	5180	9.25	9.30	0.42	12.70	16.43	Pass
40	5200	8.93	9.43	0.42	12.62	16.43	Pass
48	5240	11.36	11.11	0.42	14.66	16.43	Pass
52	5260	6.44	6.71	0.42	10.00	10.43	Pass
60	5300	6.92	7.05	0.42	10.41	10.43	Pass
64	5320	6.75	7.04	0.42	10.33	10.43	Pass
100	5500	6.52	6.59	0.42	9.98	10.21	Pass
116	5580	6.28	6.70	0.42	9.92	10.21	Pass
140	5700	6.42	6.63	0.42	9.95	10.21	Pass

Note:

- Method E) 2) a) of power density measurement of KDB 662911 is using for calculating total power density. Total power density is summing entire spectra across corresponding frequency bins on the various outputs by computer.
- For U-NII-1 band: Directional gain = $10 \log[(10^{G1/20} + 10^{G2/20} + \dots + 10^{GN/20})^2/2] = 6.57\text{dBi} > 6\text{dBi}$, so the power density limit shall be reduced to $17-(6.57-6) = 16.43\text{dBm}$.
For U-NII-2A band: Directional gain = $10 \log[(10^{G1/20} + 10^{G2/20} + \dots + 10^{GN/20})^2/2] = 6.57\text{dBi} > 6\text{dBi}$, so the power density limit shall be reduced to $11-(6.57-6) = 10.43\text{dBm}$.
For U-NII-2C band: Directional gain = $10 \log[(10^{G1/20} + 10^{G2/20} + \dots + 10^{GN/20})^2/2] = 6.79\text{dBi} > 6\text{dBi}$, so the power density limit shall be reduced to $11-(6.79-6) = 10.21\text{dBm}$.
- Refer to section 3.3 for duty cycle spectrum plot.

802.11ax (HE40)

Chan.	Freq. (MHz)	PSD w/o Duty Factor (dBm/MHz)		Duty Factor (dB)	Total PSD with Duty Factor (dBm/MHz)	Max. Limit (dBm/MHz)	Pass / Fail
		Chain 0	Chain 1				
38	5190	2.76	2.80	0.42	6.21	16.43	Pass
46	5230	3.56	3.09	0.42	6.76	16.43	Pass
54	5270	3.89	4.10	0.42	7.42	10.43	Pass
62	5310	4.36	4.35	0.42	7.78	10.43	Pass
102	5510	3.99	3.87	0.42	7.36	10.21	Pass
110	5550	3.95	4.00	0.42	7.40	10.21	Pass
134	5670	4.57	4.20	0.42	7.82	10.21	Pass

Note:

- Method E) 2) a) of power density measurement of KDB 662911 is using for calculating total power density. Total power density is summing entire spectra across corresponding frequency bins on the various outputs by computer.
- For U-NII-1 band: Directional gain = $10 \log[(10^{G1/20} + 10^{G2/20} + \dots + 10^{GN/20})^2/2] = 6.57\text{dBi} > 6\text{dBi}$, so the power density limit shall be reduced to $17-(6.57-6) = 16.43\text{dBm}$.
For U-NII-2A band: Directional gain = $10 \log[(10^{G1/20} + 10^{G2/20} + \dots + 10^{GN/20})^2/2] = 6.57\text{dBi} > 6\text{dBi}$, so the power density limit shall be reduced to $11-(6.57-6) = 10.43\text{dBm}$.
For U-NII-2C band: Directional gain = $10 \log[(10^{G1/20} + 10^{G2/20} + \dots + 10^{GN/20})^2/2] = 6.79\text{dBi} > 6\text{dBi}$, so the power density limit shall be reduced to $11-(6.79-6) = 10.21\text{dBm}$.
- Refer to section 3.3 for duty cycle spectrum plot.

802.11ax (HE80)

Chan.	Freq. (MHz)	PSD w/o Duty Factor (dBm/MHz)		Duty Factor (dB)	Total PSD with Duty Factor (dBm/MHz)	Max. Limit (dBm/MHz)	Pass / Fail
		Chain 0	Chain 1				
42	5210	-1.43	-0.77	0.41	2.34	16.43	Pass
58	5290	0.93	0.79	0.41	4.28	10.43	Pass
106	5530	1.30	1.32	0.41	4.73	10.21	Pass
122	5610	1.95	1.31	0.41	5.07	10.21	Pass

Note:

- Method E) 2) a) of power density measurement of KDB 662911 is using for calculating total power density. Total power density is summing entire spectra across corresponding frequency bins on the various outputs by computer.
- For U-NII-1 band: Directional gain = $10 \log[(10^{G1/20} + 10^{G2/20} + \dots + 10^{GN/20})^2/2] = 6.57\text{dBi} > 6\text{dBi}$, so the power density limit shall be reduced to $17-(6.57-6) = 16.43\text{dBm}$.
For U-NII-2A band: Directional gain = $10 \log[(10^{G1/20} + 10^{G2/20} + \dots + 10^{GN/20})^2/2] = 6.57\text{dBi} > 6\text{dBi}$, so the power density limit shall be reduced to $11-(6.57-6) = 10.43\text{dBm}$.
For U-NII-2C band: Directional gain = $10 \log[(10^{G1/20} + 10^{G2/20} + \dots + 10^{GN/20})^2/2] = 6.79\text{dBi} > 6\text{dBi}$, so the power density limit shall be reduced to $11-(6.79-6) = 10.21\text{dBm}$.
- Refer to section 3.3 for duty cycle spectrum plot.

802.11ax (HE160)

Chan.	Freq. (MHz)	PSD w/o Duty Factor (dBm/MHz)		Duty Factor (dB)	Total PSD with Duty Factor (dBm/MHz)	Max. Limit (dBm/MHz)	Pass / Fail
		Chain 0	Chain 1				
50 (U-NII-1 Band)	5250	-1.72	-1.54	0.44	1.82	16.43	Pass
50 (U-NII-2A Band)	5250	-3.92	-4.81	0.44	-0.89	10.43	Pass
114	5570	-5.46	-5.47	0.44	-2.01	10.21	Pass

Note:

- Method E) 2) a) of power density measurement of KDB 662911 is using for calculating total power density. Total power density is summing entire spectra across corresponding frequency bins on the various outputs by computer.
- For U-NII-1 band: Directional gain = $10 \log[(10^{G1/20} + 10^{G2/20} + \dots + 10^{GN/20})^2/2] = 6.57\text{dBi} > 6\text{dBi}$, so the power density limit shall be reduced to $17-(6.57-6) = 16.43\text{dBm}$.
For U-NII-2A band: Directional gain = $10 \log[(10^{G1/20} + 10^{G2/20} + \dots + 10^{GN/20})^2/2] = 6.57\text{dBi} > 6\text{dBi}$, so the power density limit shall be reduced to $11-(6.57-6) = 10.43\text{dBm}$.
For U-NII-2C band: Directional gain = $10 \log[(10^{G1/20} + 10^{G2/20} + \dots + 10^{GN/20})^2/2] = 6.79\text{dBi} > 6\text{dBi}$, so the power density limit shall be reduced to $11-(6.79-6) = 10.21\text{dBm}$.
- Refer to section 3.3 for duty cycle spectrum plot.

Spectrum Plot of Worst Value

802.11a / Chain 0 / CH 48

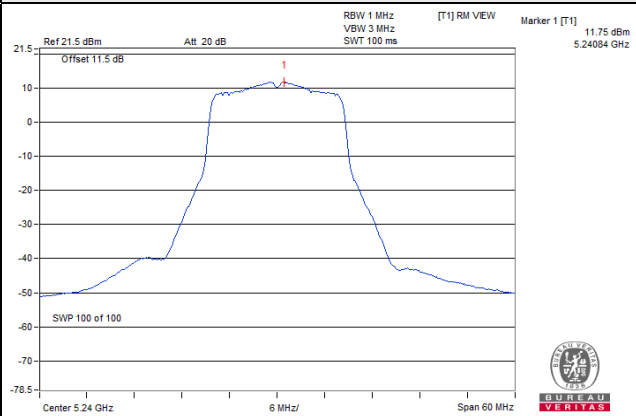

802.11ax (HE20) / Chain 0 / CH 48

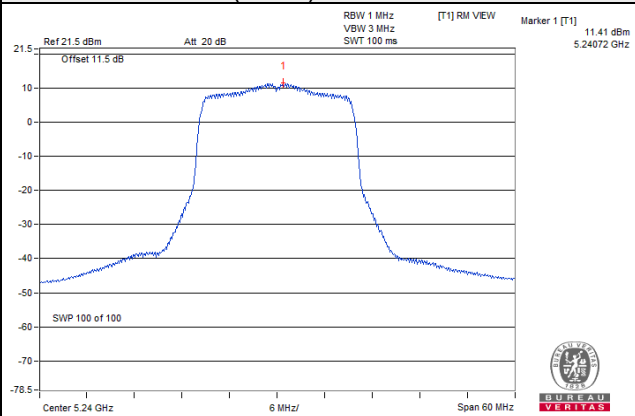

802.11ax (HE40) / Chain 0 / CH 134

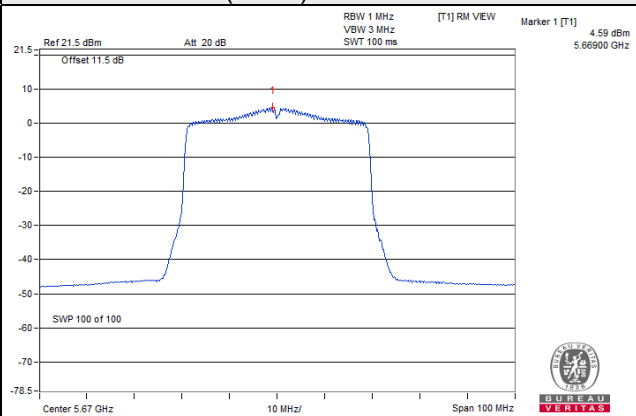

802.11ax (HE80) / Chain 0 / CH 122

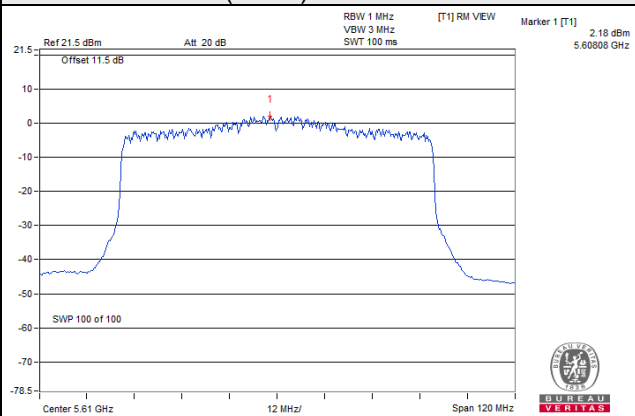

802.11ax (HE160) / Chain 1 / CH 50

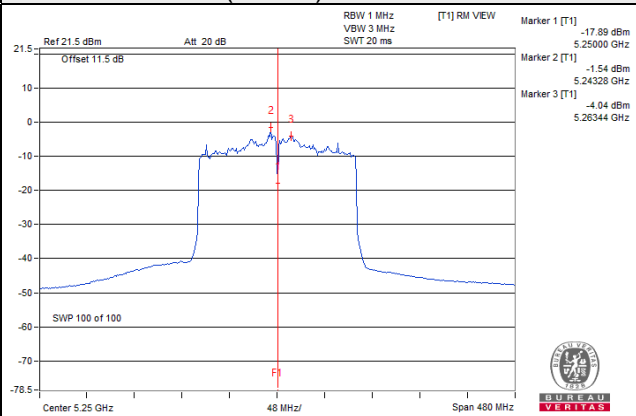

For U-NII-3 band:

802.11a

TX chain	Chan.	Freq. (MHz)	PSD W/O Duty Factor		10 log (N=2) dB	Duty Factor (dB)	Total PSD With Duty Factor (dBm/500kHz)	Limit (dBm/500kHz)	Pass / Fail
			(dBm/300kHz)	(dBm/500kHz)					
0	149	5745	2.90	5.12	3.01	0.35	8.48	29.21	Pass
	157	5785	3.27	5.49	3.01	0.35	8.85	29.21	Pass
	165	5825	3.18	5.40	3.01	0.35	8.76	29.21	Pass
1	149	5745	3.51	5.73	3.01	0.35	9.09	29.21	Pass
	157	5785	3.54	5.76	3.01	0.35	9.12	29.21	Pass
	165	5825	3.60	5.82	3.01	0.35	9.18	29.21	Pass

Note:

1. Method E) 2) c) of power density measurement of KDB 662911 is using for calculating total power density.
2. Directional gain = $10 \log[(10^{G1/20} + 10^{G2/20} + \dots + 10^{GN/20})^2/2] = 6.79\text{dBi} > 6\text{dBi}$, so the power density limit shall be reduced to $30-(6.79-6) = 29.21\text{dBm}$.
3. Refer to section 3.3 for duty cycle spectrum plot.

802.11ax (HE20)

TX chain	Chan.	Freq. (MHz)	PSD W/O Duty Factor		10 log (N=2) dB	Duty Factor (dB)	Total PSD With Duty Factor (dBm/500kHz)	Limit (dBm/500kHz)	Pass / Fail
			(dBm/300kHz)	(dBm/500kHz)					
0	149	5745	0.88	3.10	3.01	0.42	6.53	29.21	Pass
	157	5785	0.21	2.43	3.01	0.42	5.86	29.21	Pass
	165	5825	0.09	2.31	3.01	0.42	5.74	29.21	Pass
1	149	5745	0.83	3.05	3.01	0.42	6.48	29.21	Pass
	157	5785	1.35	3.57	3.01	0.42	7.00	29.21	Pass
	165	5825	0.37	2.59	3.01	0.42	6.02	29.21	Pass

Note:

1. Method E) 2) c) of power density measurement of KDB 662911 is using for calculating total power density.
2. Directional gain = $10 \log[(10^{G1/20} + 10^{G2/20} + \dots + 10^{GN/20})^2/2] = 6.79\text{dBi} > 6\text{dBi}$, so the power density limit shall be reduced to $30-(6.79-6) = 29.21\text{dBm}$.
3. Refer to section 3.3 for duty cycle spectrum plot.

802.11ax (HE40)

TX chain	Chan.	Freq. (MHz)	PSD W/O Duty Factor		10 log (N=2) dB	Duty Factor (dB)	Total PSD With Duty Factor (dBm/500kHz)	Limit (dBm/500kHz)	Pass / Fail
			(dBm/300kHz)	(dBm/500kHz)					
0	151	5755	-1.04	1.18	3.01	0.42	4.61	29.21	Pass
	159	5795	-1.39	0.83	3.01	0.42	4.26	29.21	Pass
1	151	5755	-1.10	1.12	3.01	0.42	4.55	29.21	Pass
	159	5795	-1.42	0.80	3.01	0.42	4.23	29.21	Pass

Note:

1. Method E) 2) c) of power density measurement of KDB 662911 is using for calculating total power density.
2. Directional gain = $10 \log[(10^{G1/20} + 10^{G2/20} + \dots + 10^{GN/20})^2/2] = 6.79\text{dBi} > 6\text{dBi}$, so the power density limit shall be reduced to $30-(6.79-6) = 29.21\text{dBm}$.
3. Refer to section 3.3 for duty cycle spectrum plot.

802.11ax (HE80)

TX chain	Chan.	Freq. (MHz)	PSD W/O Duty Factor		10 log (N=2) dB	Duty Factor (dB)	Total PSD With Duty Factor (dBm/500kHz)	Limit (dBm/500kHz)	Pass / Fail
			(dBm/300kHz)	(dBm/500kHz)					
0	155	5775	-5.53	-3.31	3.01	0.41	0.11	29.21	Pass
1	155	5775	-5.65	-3.43	3.01	0.41	-0.01	29.21	Pass

Note:

1. Method E) 2) c) of power density measurement of KDB 662911 is using for calculating total power density.
2. Directional gain = $10 \log[(10^{G1/20} + 10^{G2/20} + \dots + 10^{GN/20})^2/2] = 6.79\text{dBi} > 6\text{dBi}$, so the power density limit shall be reduced to $30-(6.79-6) = 29.21\text{dBm}$.
3. Refer to section 3.3 for duty cycle spectrum plot.

Spectrum Plot of Worst Value

802.11a

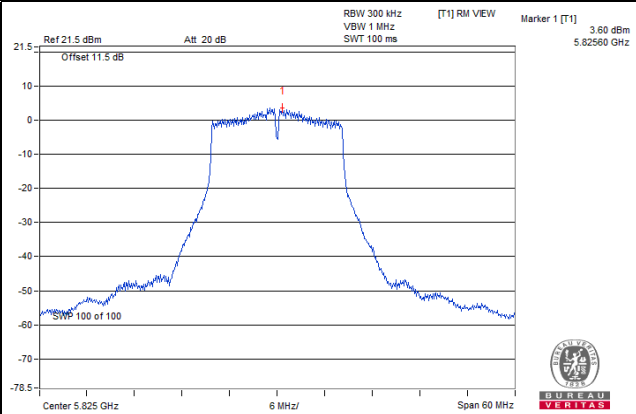

802.11ax (HE20)

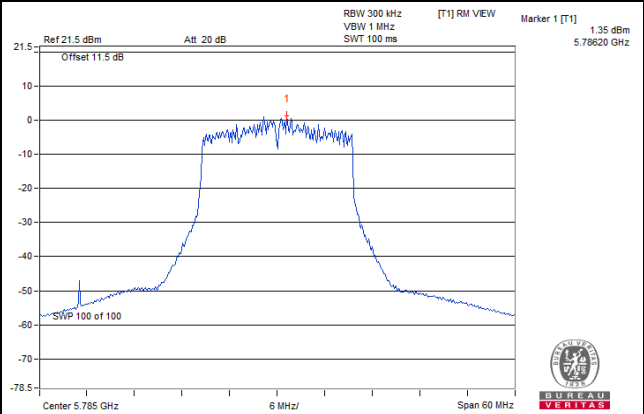

802.11ax (HE40)

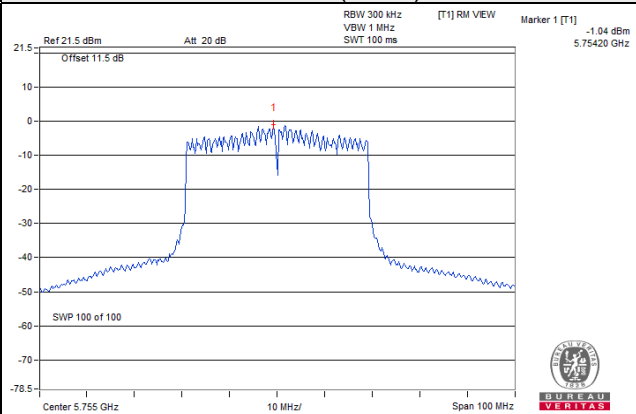

802.11ax (HE80)

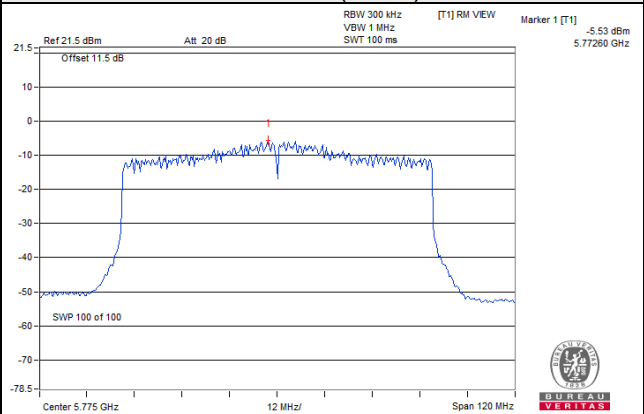

4.6 Frequency Stability

4.6.1 Limits of Frequency Stability Measurement

The frequency of the carrier signal shall be maintained within band of operation

4.6.2 Test Setup

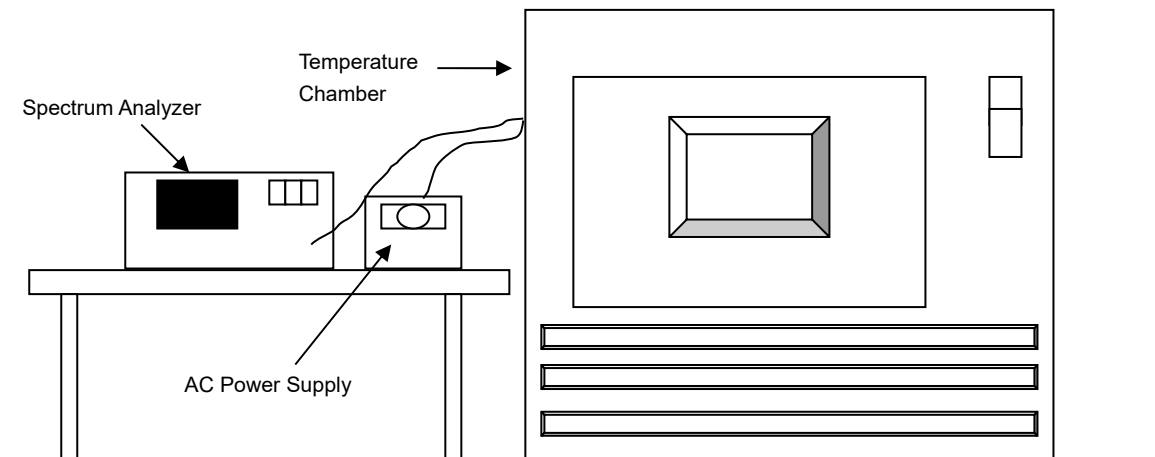

4.6.3 Test Instruments

Description & Manufacturer	Model No.	Serial No.	Cal. Date	Cal. Due
Spectrum Analyzer ROHDE & SCHWARZ	FSP40	100040	Sep. 15, 2021	Sep. 14, 2022
WIT Standard Temperature And Humidity Chamber	TH-4S-C	W981030	Jun. 01, 2021	May 31, 2022
Digital Multimeter Fluke	87-III	70360742	Jun. 24, 2021	Jun. 23, 2022
AC Power Supply Extech	CFW-105	E000603	NA	NA

Note: 1. The calibration interval of the above test instruments is 12 months and the calibrations are traceable to NML/ROC and NIST/USA.

4.6.4 Test Procedure

- The EUT was placed inside the environmental test chamber and powered by nominal AC voltage.
- Turn the EUT on and couple its output to a spectrum analyzer.
- Turn the EUT off and set the chamber to the highest temperature specified.
- Allow sufficient time (approximately 30 min) for the temperature of the chamber to stabilize, turn the EUT on and measure the operating frequency after 2, 5, and 10 minutes.
- Repeat step 2 and 3 with the temperature chamber set to the lowest temperature.
- The test chamber was allowed to stabilize at +20 degree C for a minimum of 30 minutes. The supply voltage was then adjusted on the EUT from 85% to 115% and the frequency record.

4.6.5 Deviation from Test Standard

No deviation.

4.6.6 EUT Operating Condition

Set the EUT transmit at un-modulation mode to test frequency stability.

4.6.7 Test Results

Frequency Stability Versus Temp.									
Operating Frequency: 5180MHz									
Temp. (°C)	Power Supply (Vac)	0 Minute		2 Minute		5 Minute		10 Minute	
		Measured Frequency (MHz)	Result	Measured Frequency (MHz)	Result	Measured Frequency (MHz)	Result	Measured Frequency (MHz)	Result
40	120	5179.9966	PASS	5179.9952	PASS	5179.9936	PASS	5179.9940	PASS
30	120	5180.0136	PASS	5180.0136	PASS	5180.0150	PASS	5180.0111	PASS
20	120	5179.9970	PASS	5179.9935	PASS	5179.9950	PASS	5179.9975	PASS
10	120	5180.0184	PASS	5180.0188	PASS	5180.0147	PASS	5180.0173	PASS
0	120	5179.9962	PASS	5179.9935	PASS	5179.9931	PASS	5179.9969	PASS

Frequency Stability Versus Voltage									
Operating Frequency: 5180MHz									
Temp. (°C)	Power Supply (Vac)	0 Minute		2 Minute		5 Minute		10 Minute	
		Measured Frequency (MHz)	Result	Measured Frequency (MHz)	Result	Measured Frequency (MHz)	Result	Measured Frequency (MHz)	Result
20	138	5179.9960	PASS	5179.9928	PASS	5179.9956	PASS	5179.9971	PASS
	120	5179.9970	PASS	5179.9935	PASS	5179.9950	PASS	5179.9975	PASS
	102	5179.9979	PASS	5179.9930	PASS	5179.9957	PASS	5179.9979	PASS

4.7 6dB Bandwidth Measurement

4.7.1 Limits of 6dB Bandwidth Measurement

The minimum of 6dB Bandwidth Measurement is 0.5MHz.

4.7.2 Test Setup

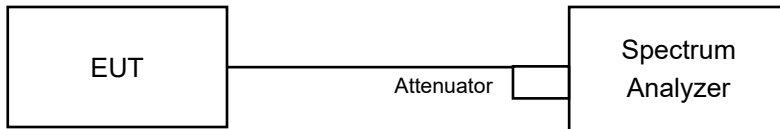

4.7.3 Test Instruments

Refer to section 4.1.2 to get information of above instrument.

4.7.4 Test Procedure

- Set resolution bandwidth (RBW) = 100kHz
- Set the video bandwidth (VBW) $\geq 3 \times$ RBW, Detector = Peak.
- Trace mode = max hold.
- Sweep = auto couple.
- Measure the maximum width of the emission that is constrained by the frequencies associated with the two amplitude points (upper and lower) that are attenuated by 6 dB relative to the maximum level measured in the fundamental emission

4.7.5 Deviation from Test Standard

No deviation.

4.7.6 EUT Operating Condition

The software provided by client to enable the EUT under transmission condition continuously at lowest, middle and highest channel frequencies individually.

4.7.7 Test Results

802.11a

Channel	Frequency (MHz)	6dB Bandwidth (MHz)		Minimum Limit (MHz)	Pass / Fail
		Chain 0	Chain 1		
149	5745	15.19	15.18	0.5	Pass
157	5785	15.18	15.16	0.5	Pass
165	5825	15.17	15.17	0.5	Pass

802.11ax (HE20)

Channel	Frequency (MHz)	6dB Bandwidth (MHz)		Minimum Limit (MHz)	Pass / Fail
		Chain 0	Chain 1		
149	5745	15.91	15.16	0.5	Pass
157	5785	15.60	15.20	0.5	Pass
165	5825	16.14	15.61	0.5	Pass

802.11ax (HE40)

Channel	Frequency (MHz)	6dB Bandwidth (MHz)		Minimum Limit (MHz)	Pass / Fail
		Chain 0	Chain 1		
151	5755	34.21	35.20	0.5	Pass
159	5795	35.90	36.01	0.5	Pass

802.11ax (HE80)

Channel	Frequency (MHz)	6dB Bandwidth (MHz)		Minimum Limit (MHz)	Pass / Fail
		Chain 0	Chain 1		
155	5775	71.46	73.96	0.5	Pass

Spectrum Plot of Worst Value

802.11a

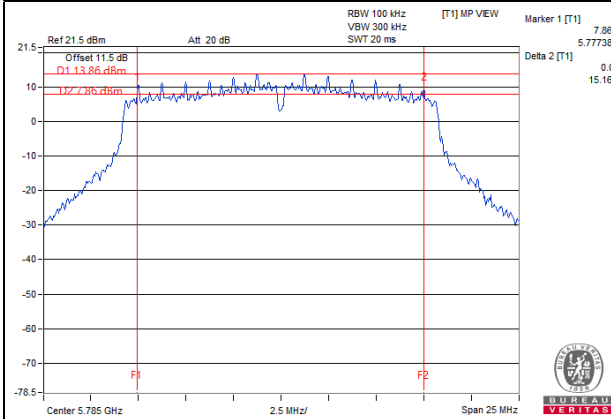

802.11ax (HE20)

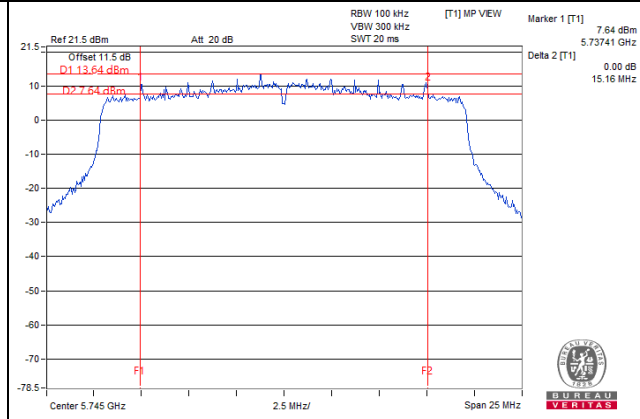

802.11ax (HE40)

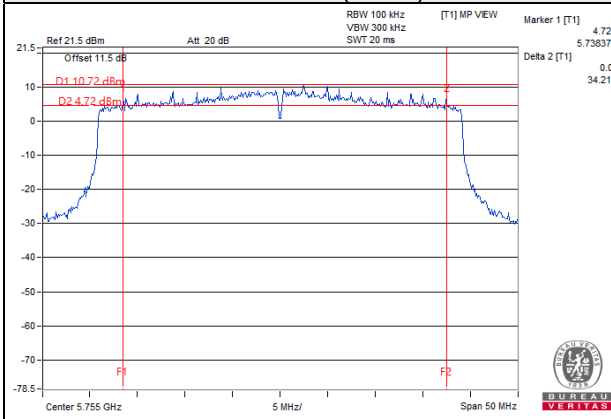

802.11ax (HE80)

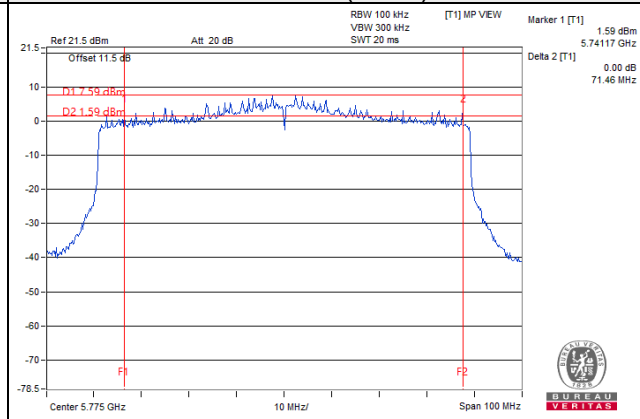

5 Pictures of Test Arrangements

Please refer to the attached file (Test Setup Photo).

Annex A- Radiated out of Band Emission (OOBE) Measurement (For U-NII-3 band)

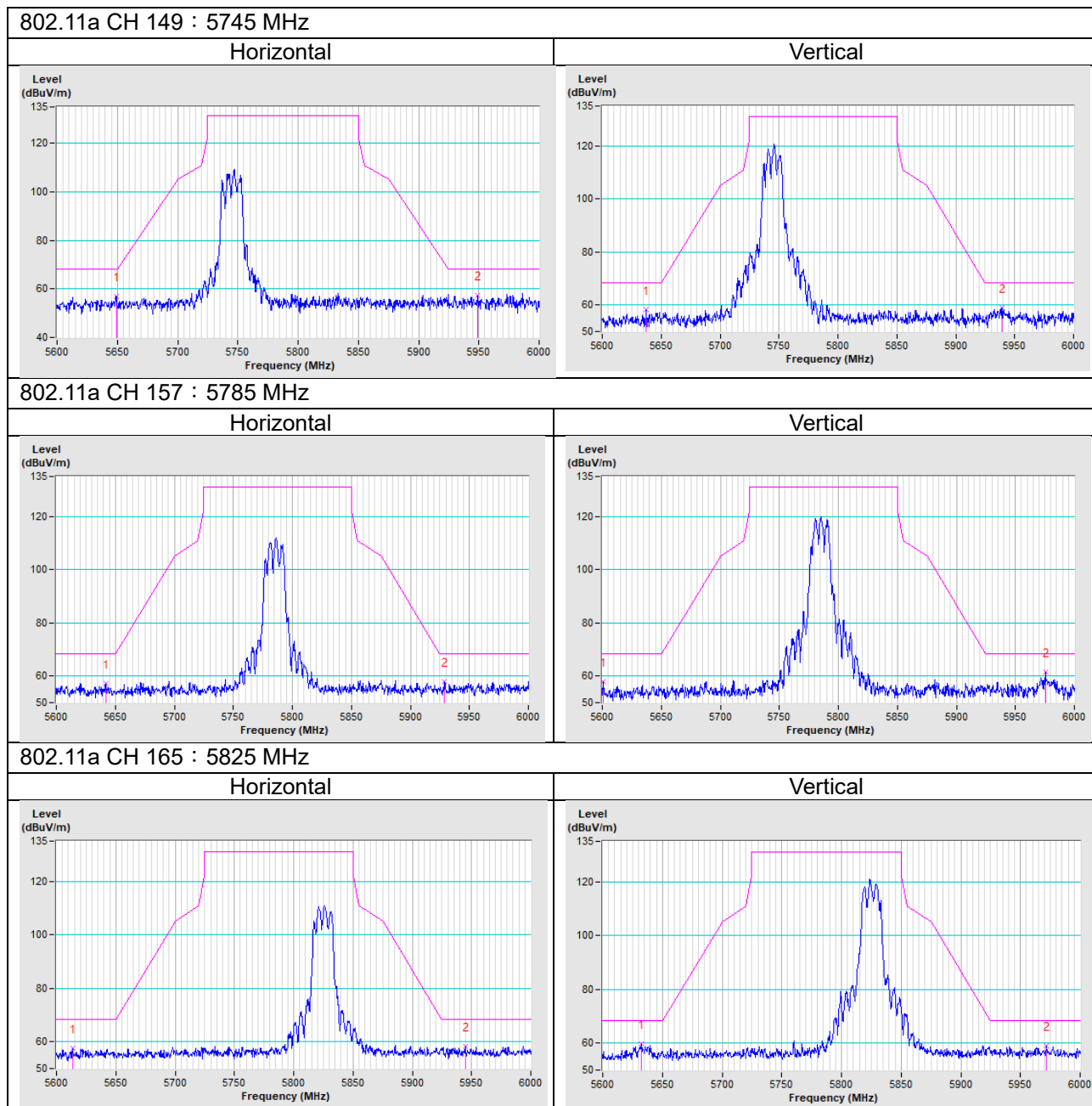

802.11ax (HE20) CH 149 : 5745 MHz

Horizontal

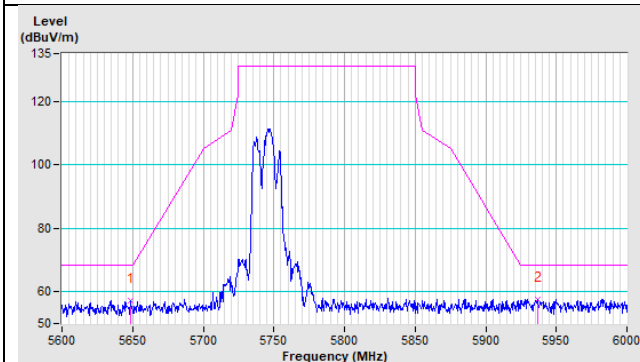

Vertical

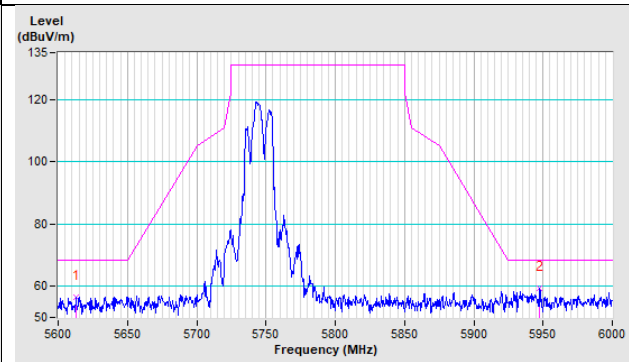

802.11ax (HE20) CH 157 : 5785 MHz

Horizontal

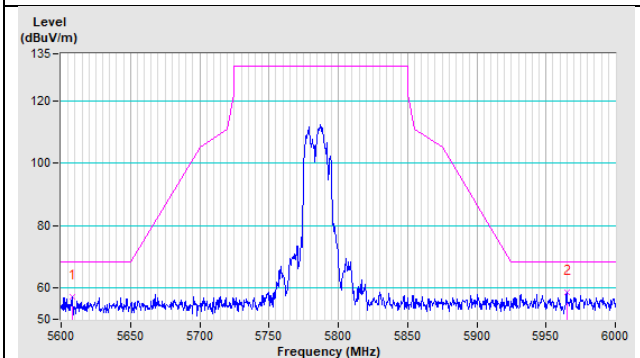

Vertical

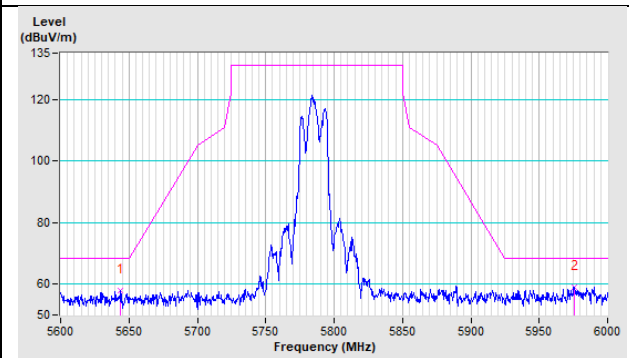

802.11ax (HE20) CH 165 : 5825 MHz

Horizontal

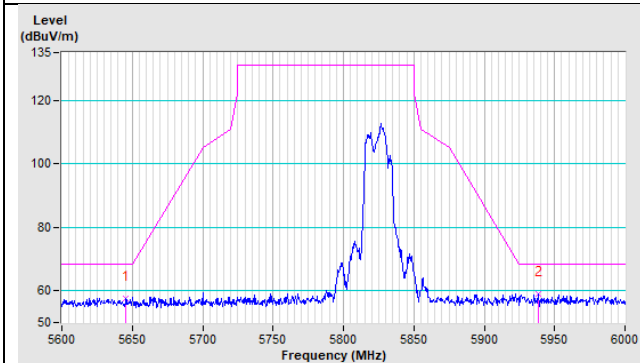

Vertical

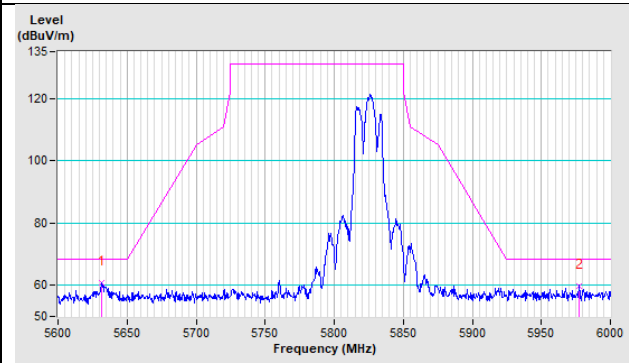

802.11ax (HE40) CH 151 : 5755 MHz

Horizontal

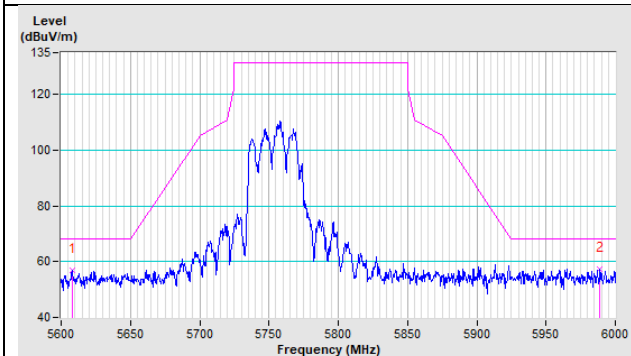

Vertical

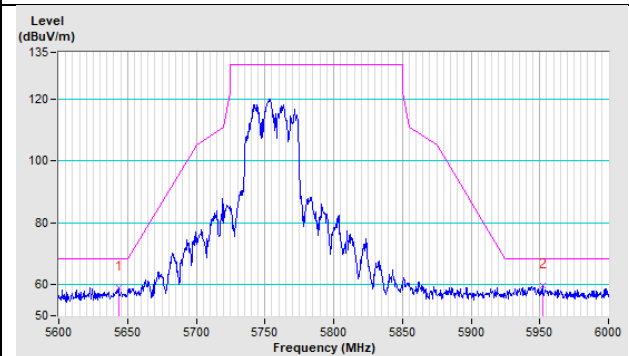

802.11ax (HE40) CH 159 : 5795 MHz

Horizontal

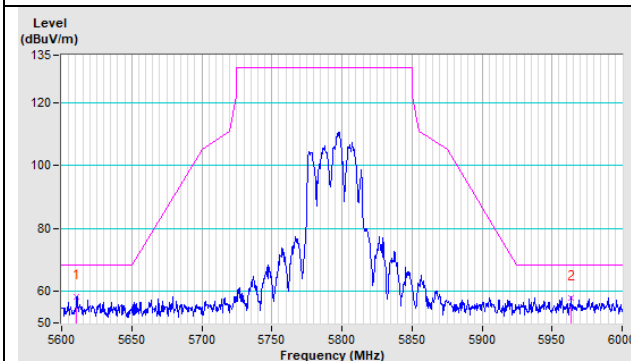

Vertical

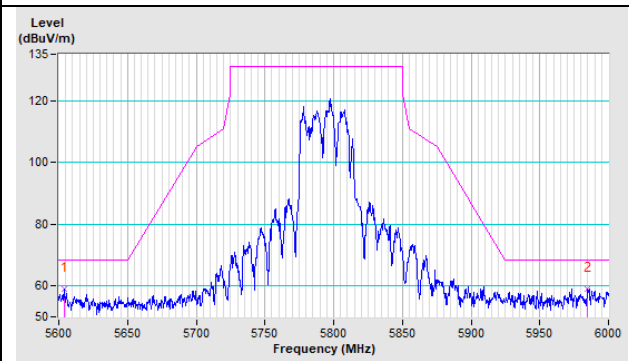

802.11ax (HE80) CH 155 : 5775 MHz

Horizontal

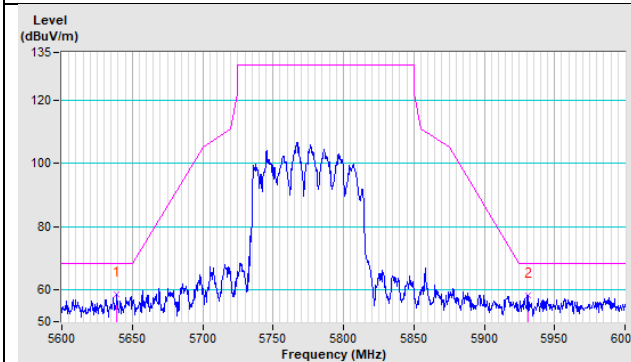

Vertical

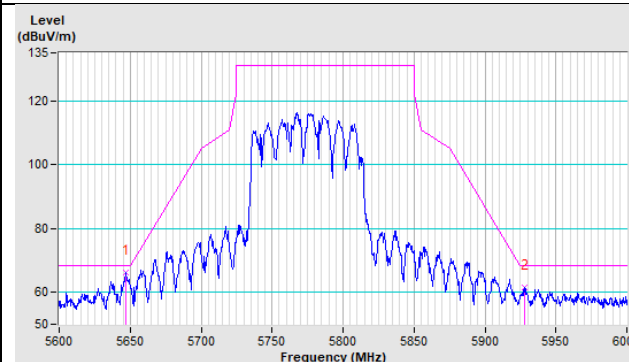

Annex B- Band Edge Measurement

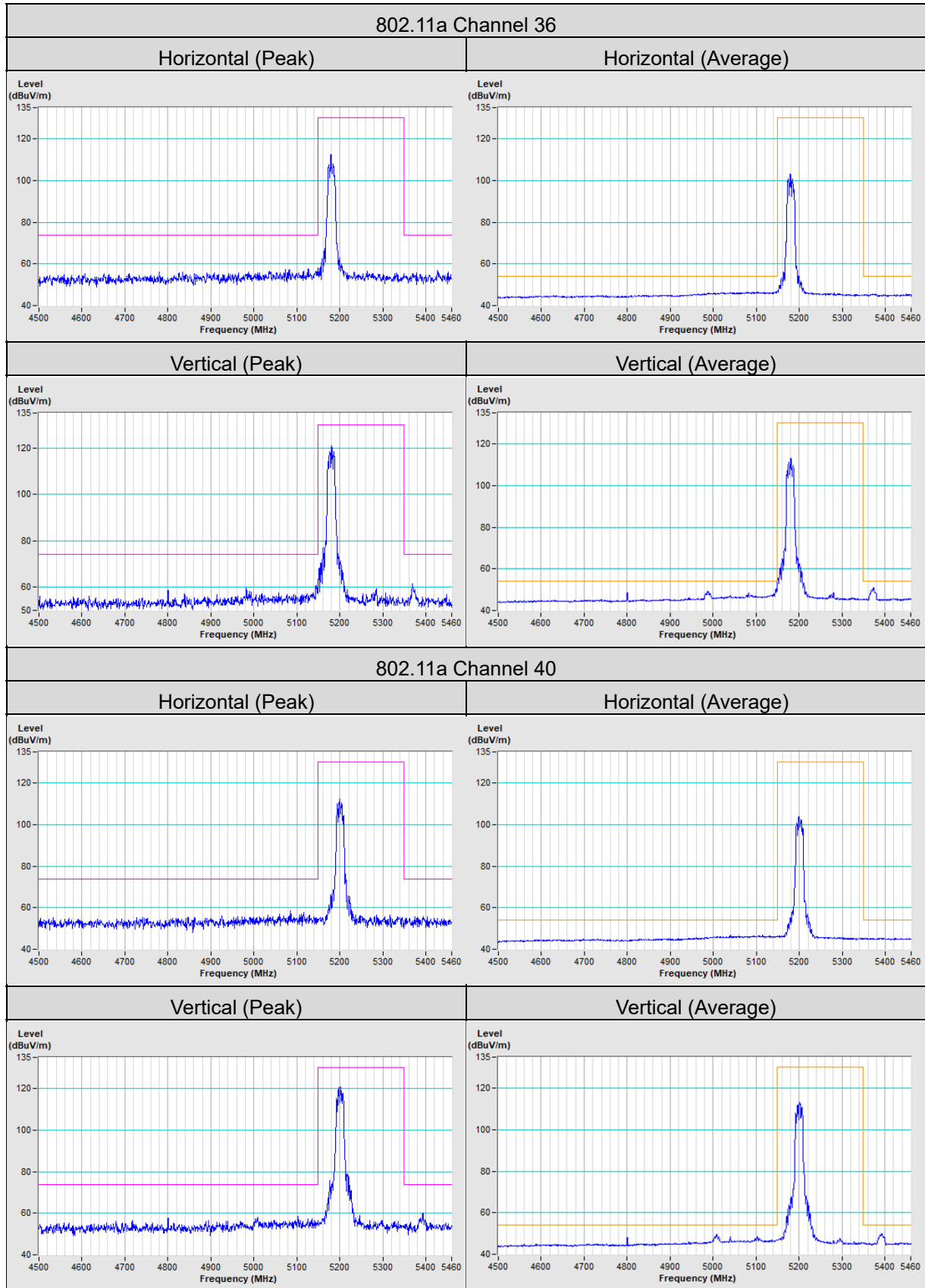

802.11a Channel 48

Horizontal (Peak) Horizontal (Average)

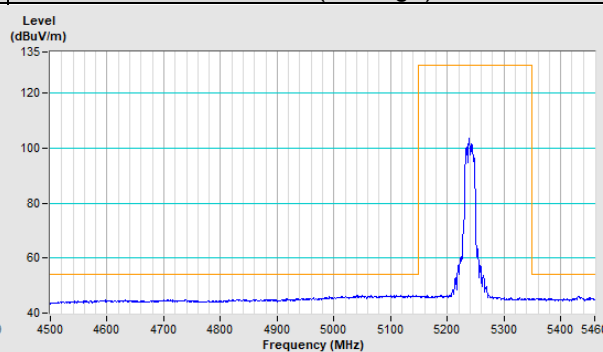
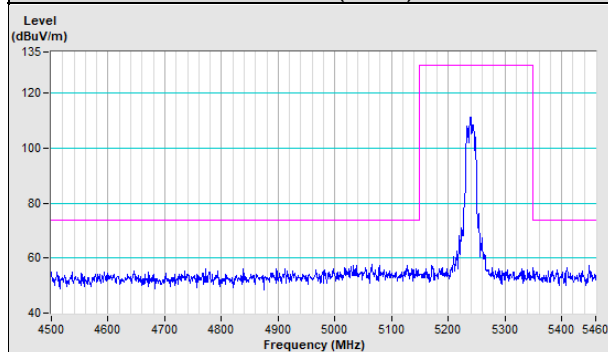

Vertical (Peak) Vertical (Average)

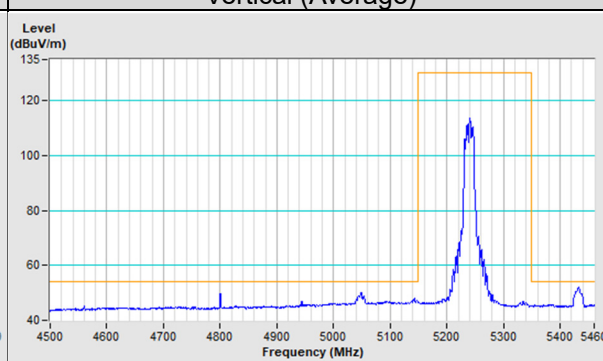
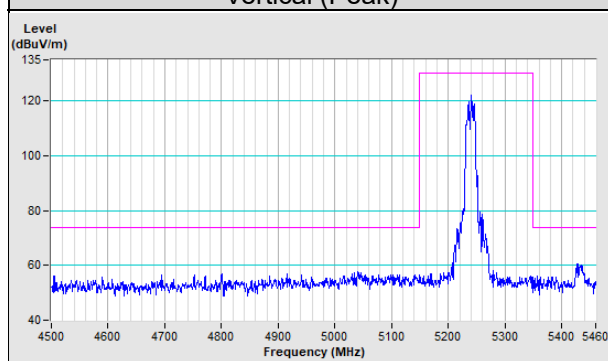

802.11a Channel 52

Horizontal (Peak) Horizontal (Average)

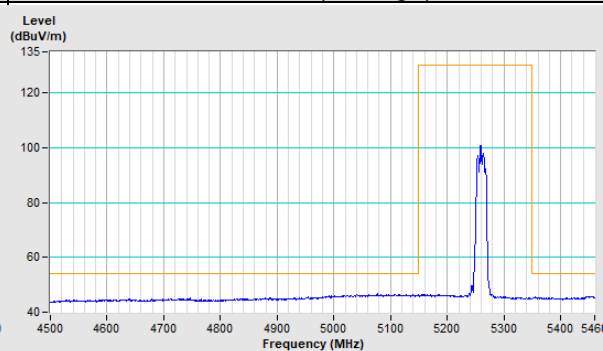
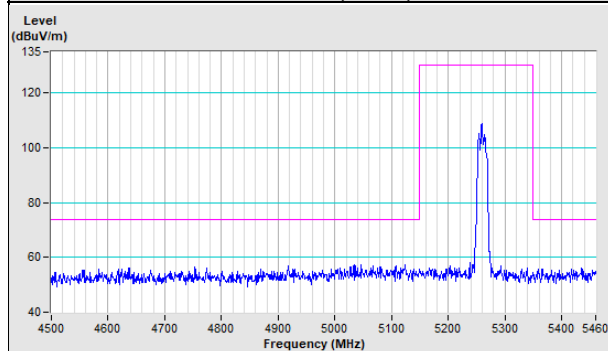

Vertical (Peak) Vertical (Average)

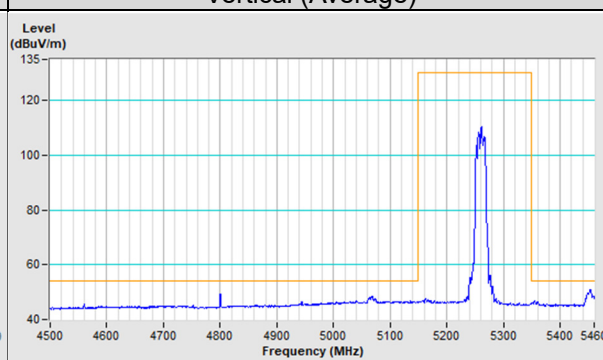
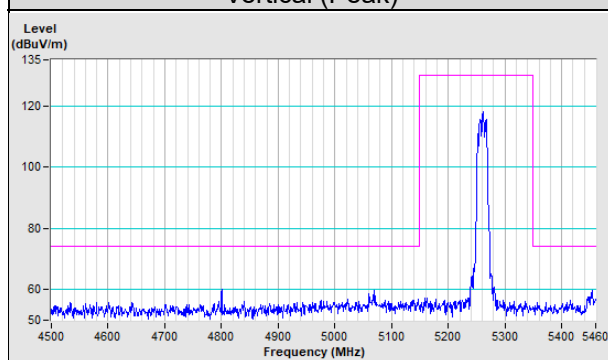

802.11a Channel 60

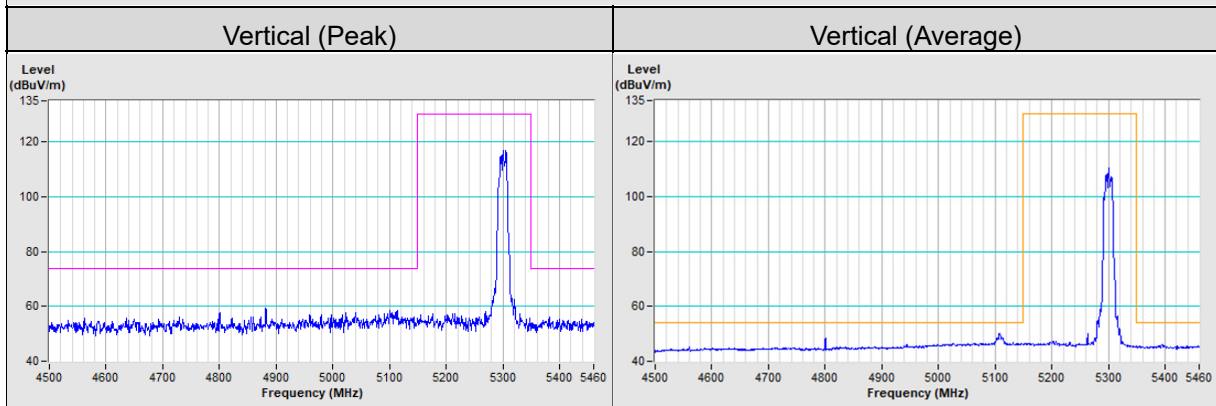
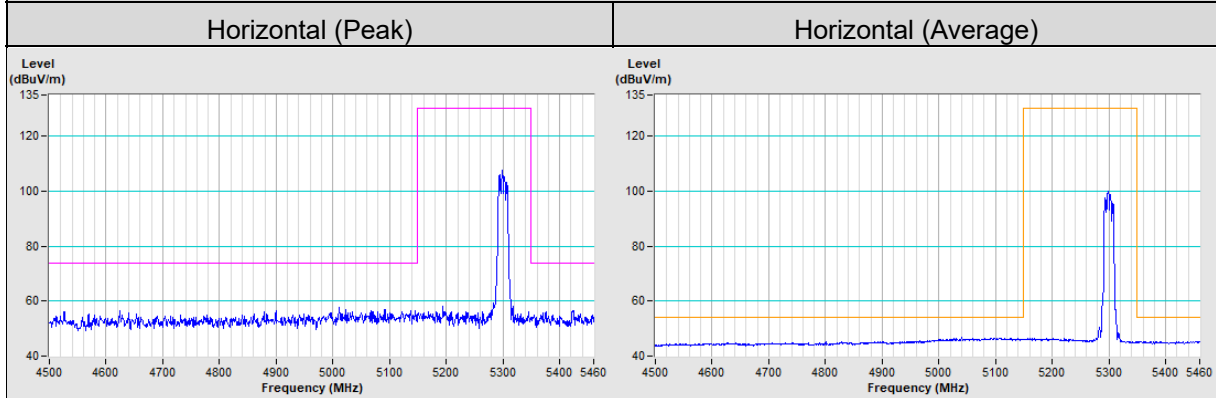

802.11a Channel 64

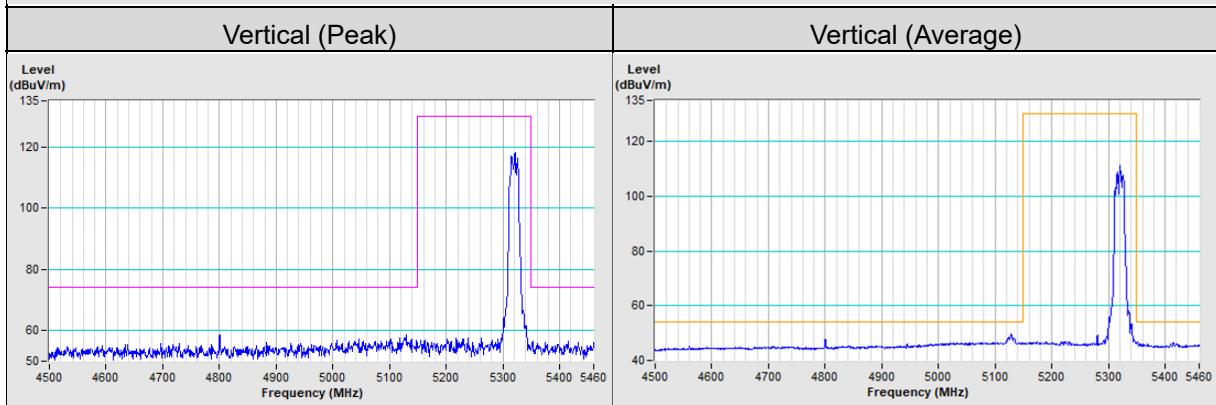
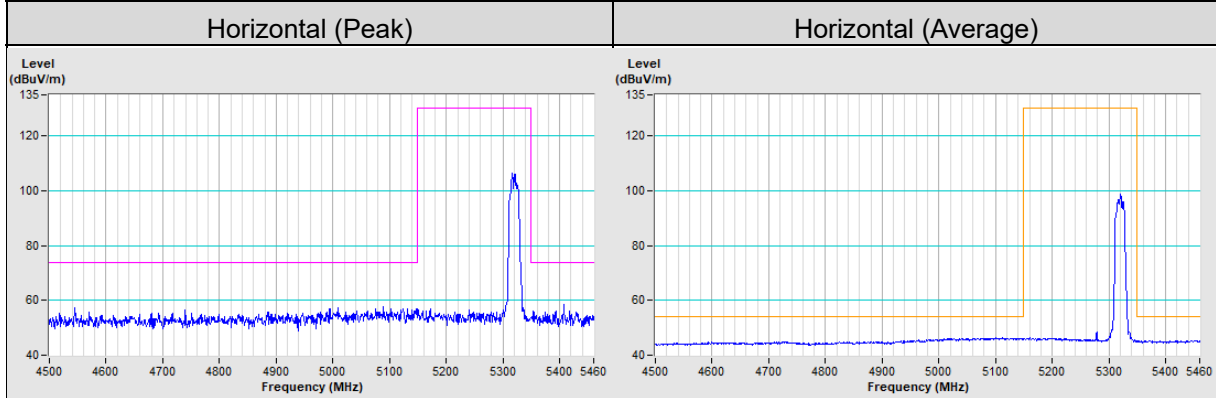

802.11a Channel 100

Horizontal (Peak)	Horizontal (Average)
-------------------	----------------------

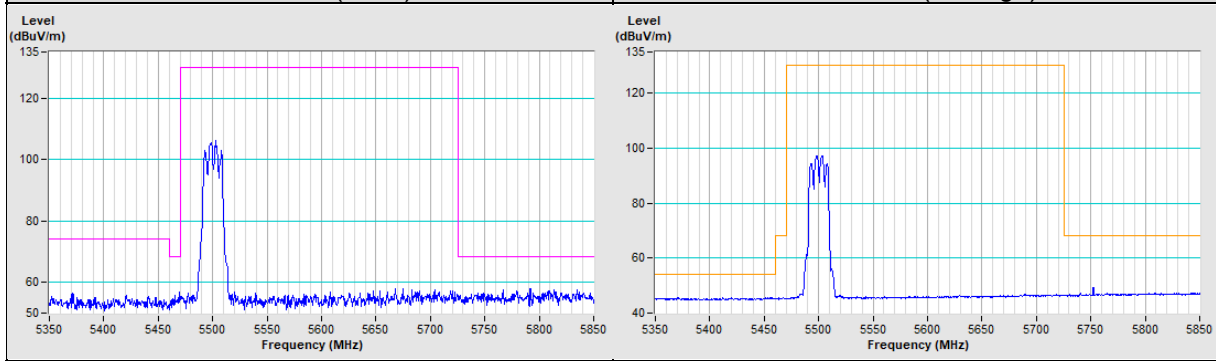

Vertical (Peak)	Vertical (Average)
-----------------	--------------------

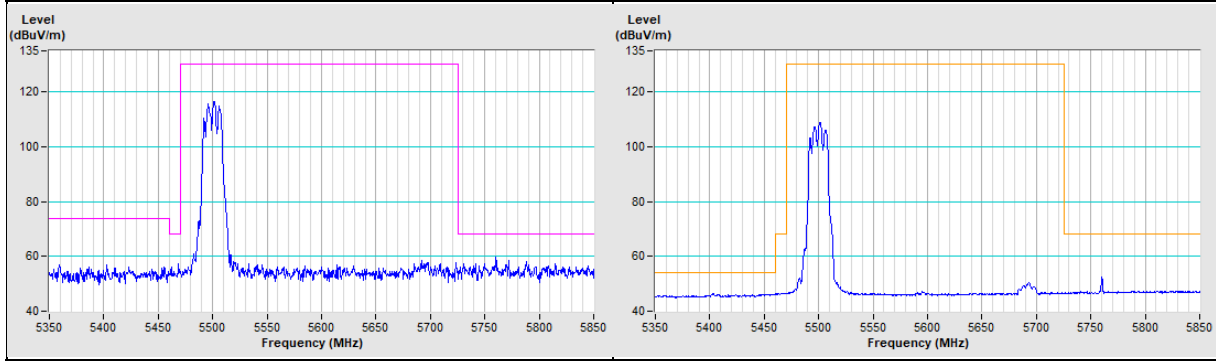

802.11a Channel 140

Horizontal (Peak)	Vertical (Peak)
-------------------	-----------------

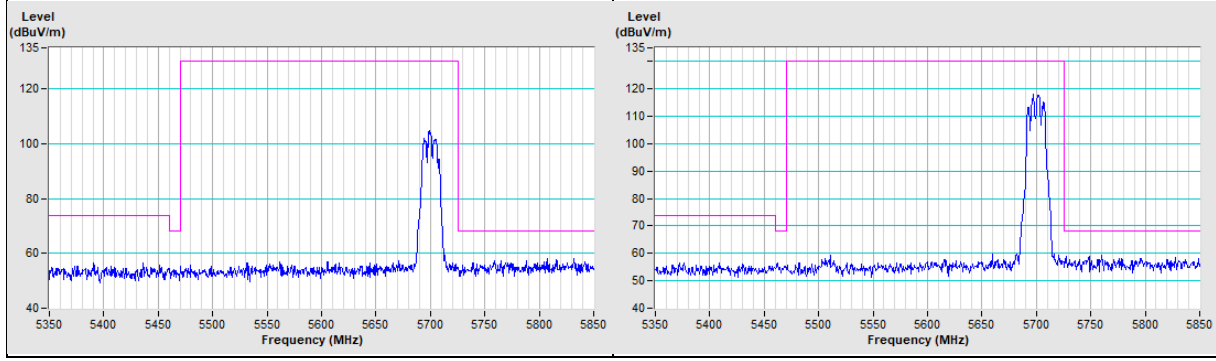

802.11ax (HE20) Channel 36

Horizontal (Peak)

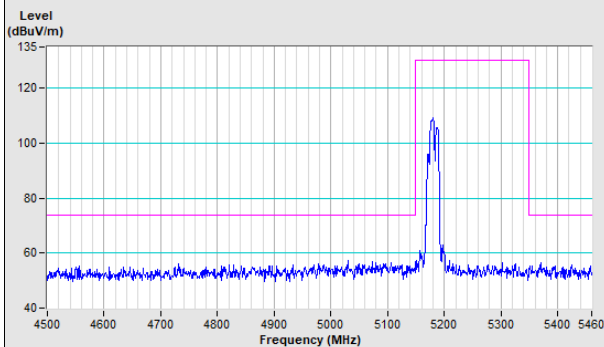

Horizontal (Average)

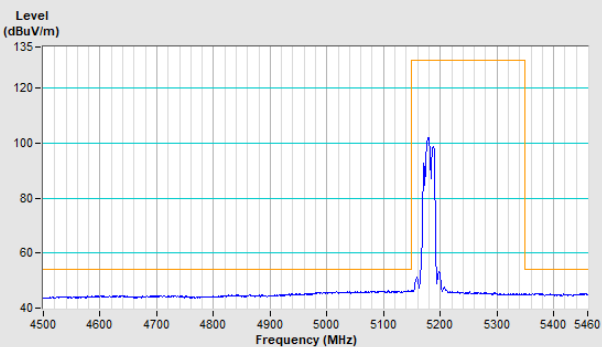

Vertical (Peak)

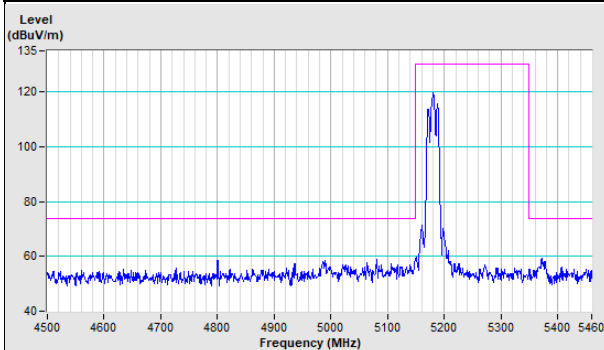

Vertical (Average)

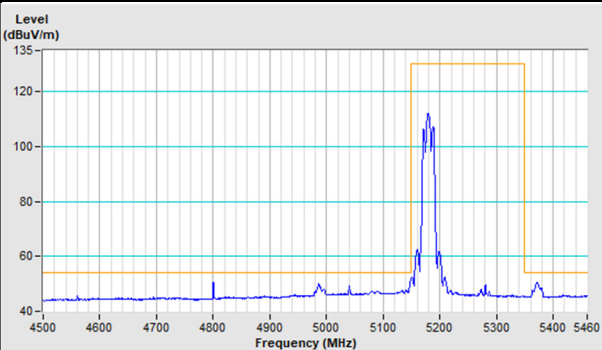

802.11ax (HE20) Channel 40

Horizontal (Peak)

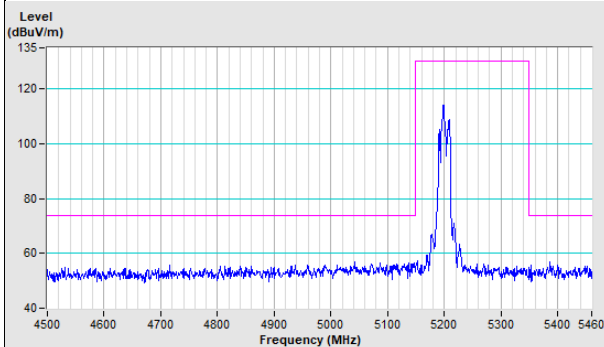

Horizontal (Average)

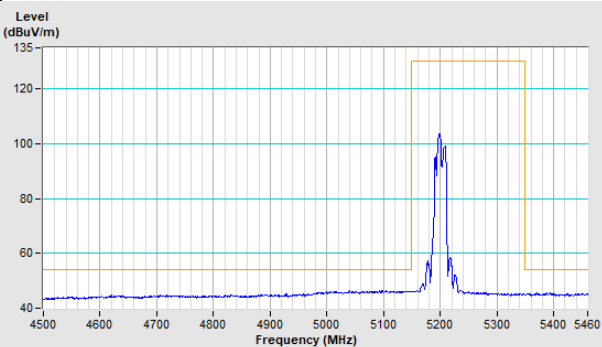

Vertical (Peak)

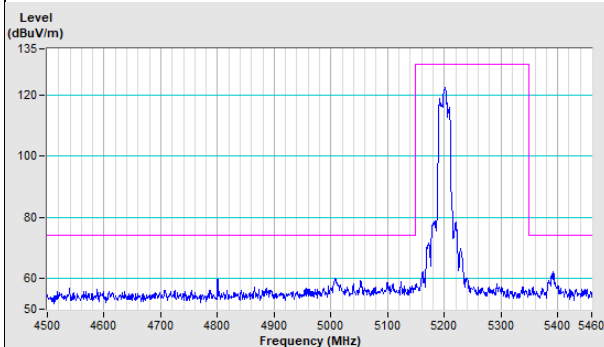

Vertical (Average)

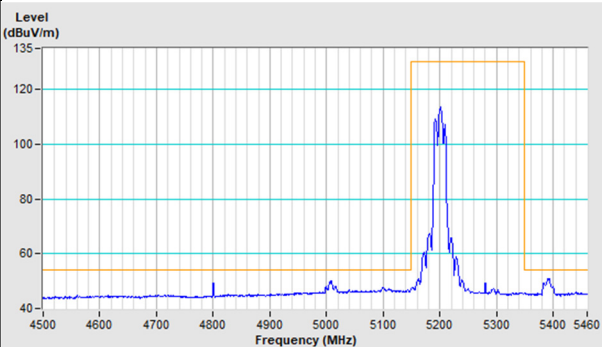

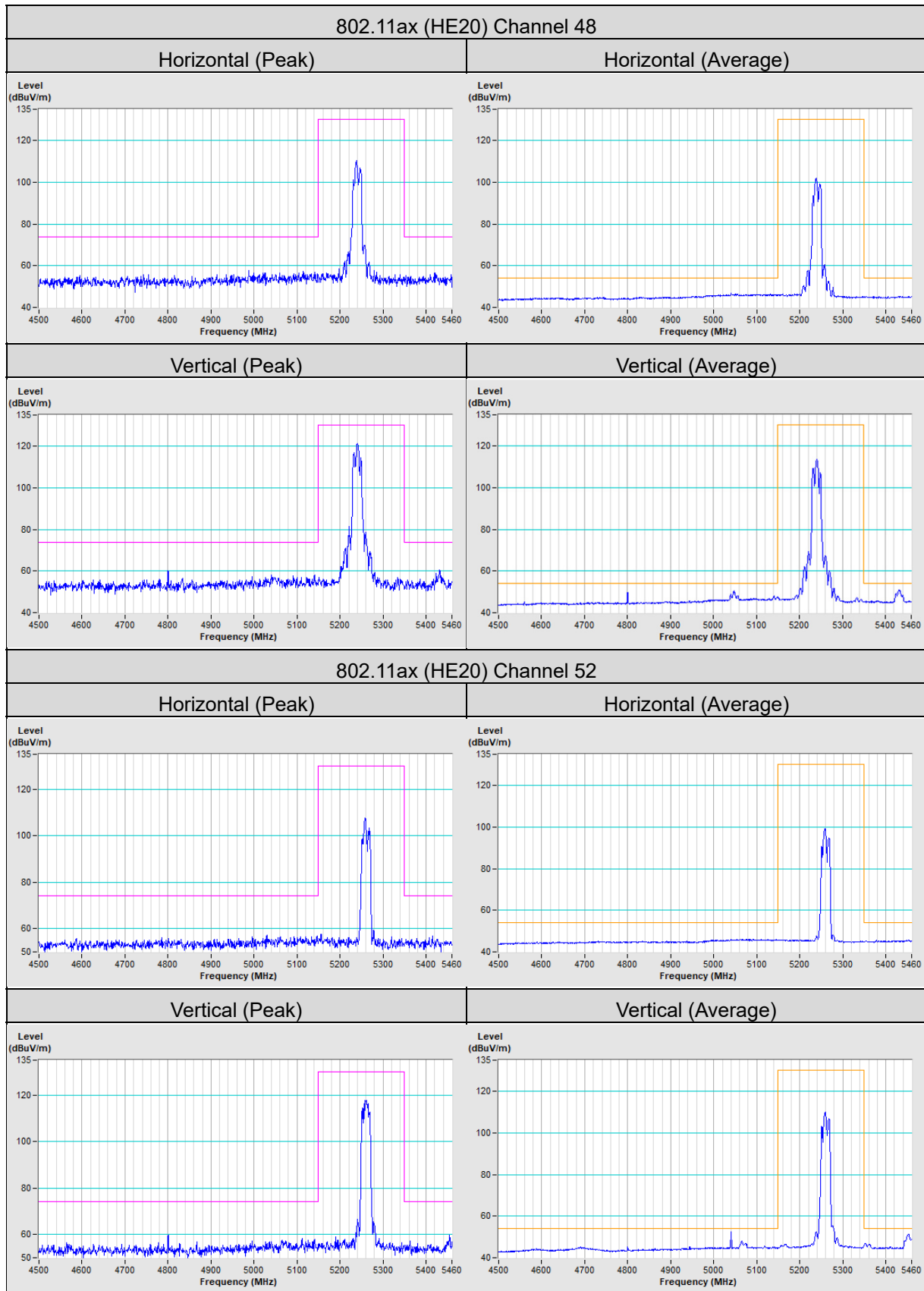

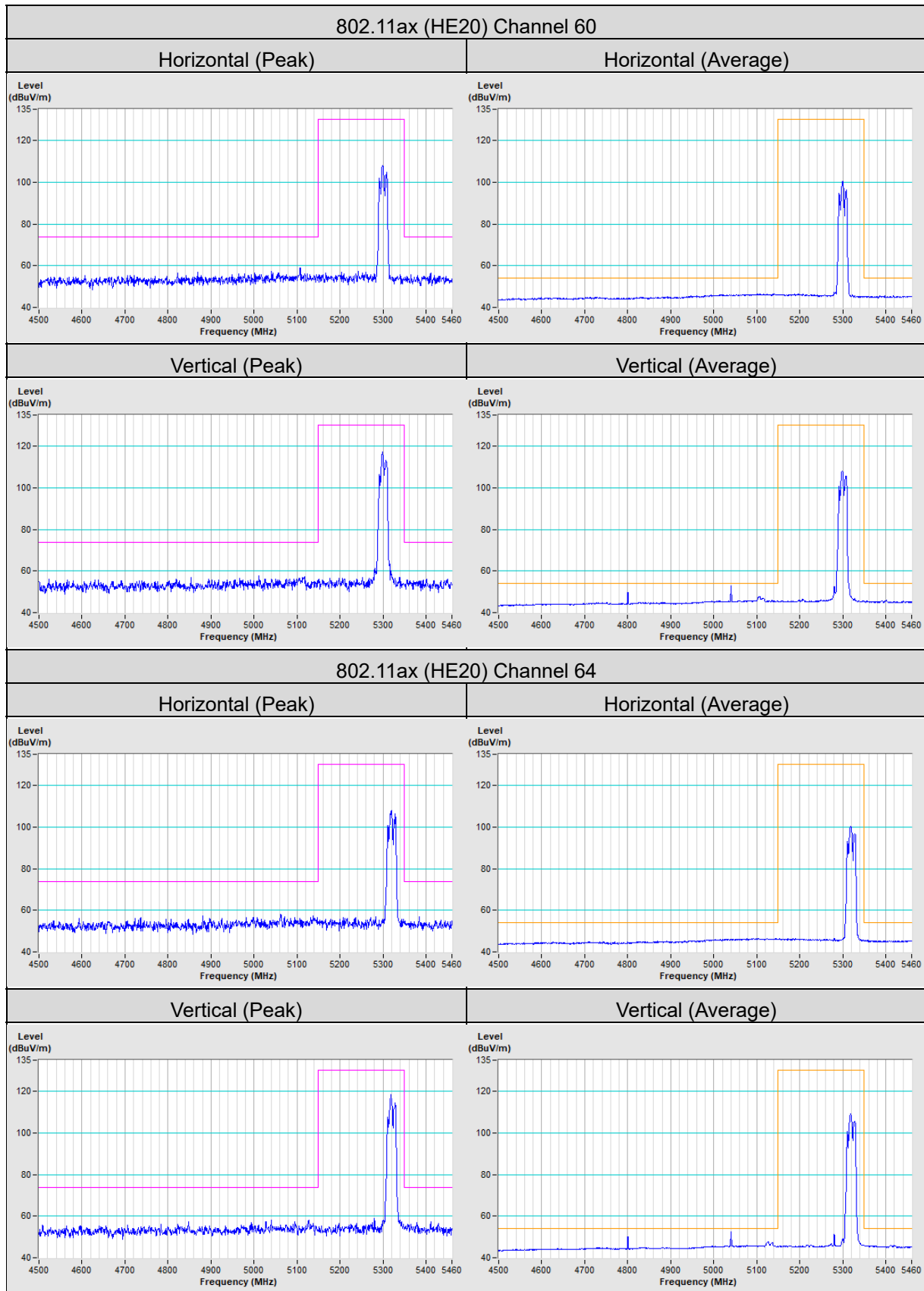

802.11ax (HE20) Channel 100

Horizontal (Peak)	Horizontal (Average)
--------------------------	-----------------------------

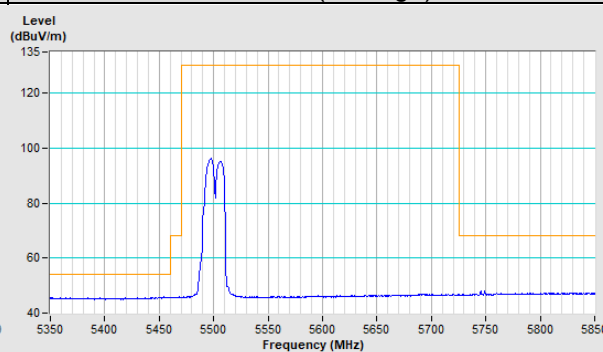
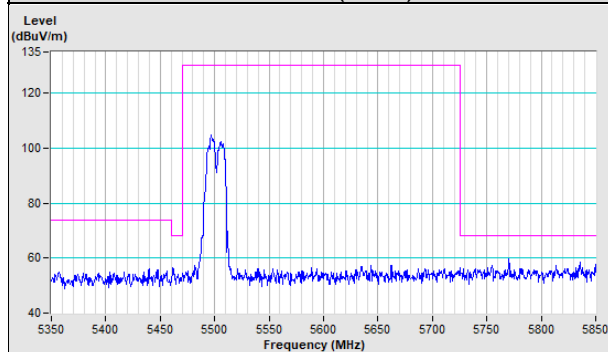

Vertical (Peak)	Vertical (Average)
------------------------	---------------------------

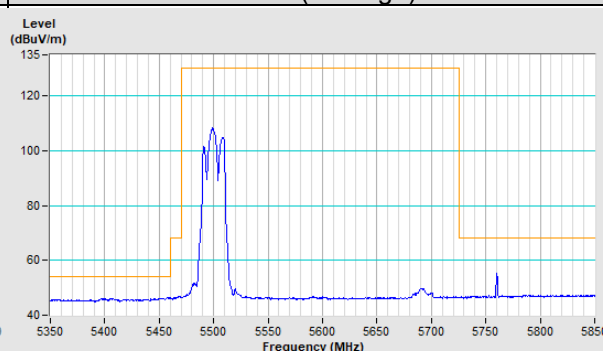
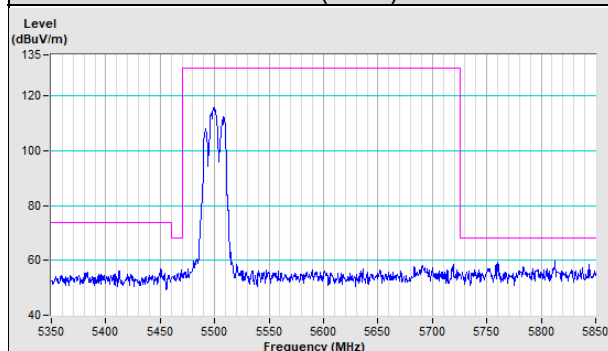

802.11ax (HE20) Channel 140

Horizontal (Peak)	Vertical (Peak)
--------------------------	------------------------

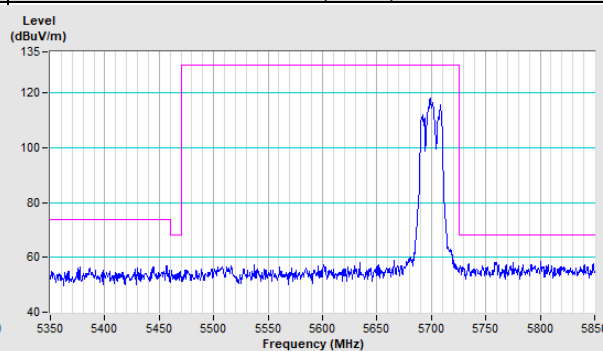
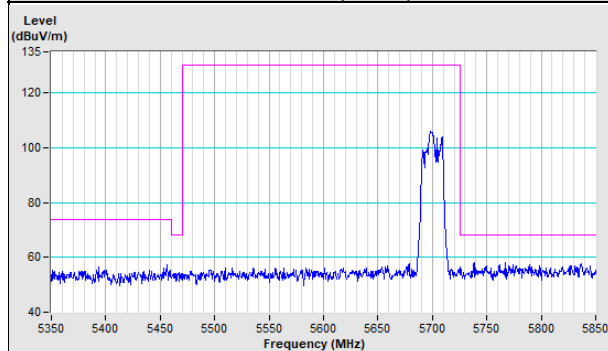

802.11ax (HE40) Channel 38

Horizontal (Peak)	Horizontal (Average)
--------------------------	-----------------------------

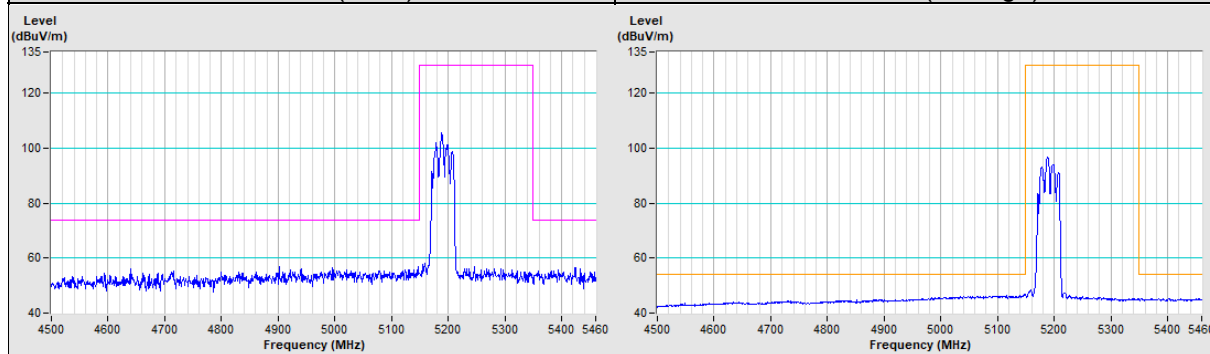

Vertical (Peak)	Vertical (Average)
------------------------	---------------------------

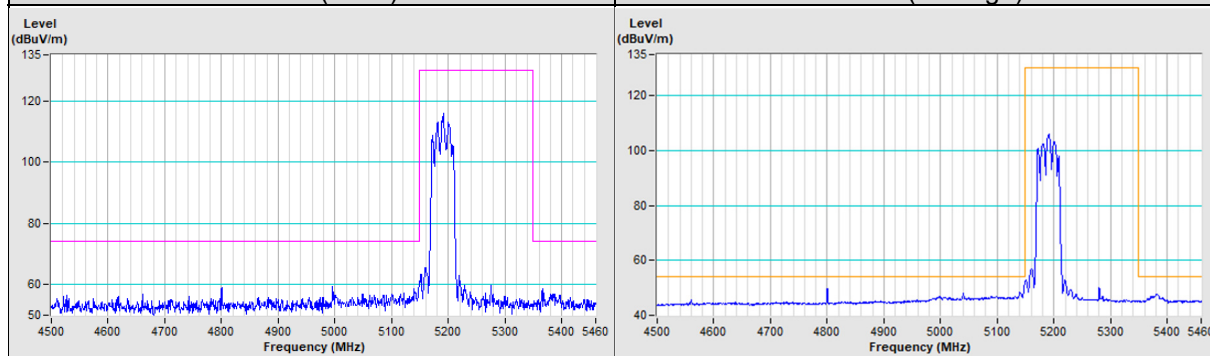

802.11ax (HE40) Channel 46

Horizontal (Peak)	Horizontal (Average)
--------------------------	-----------------------------

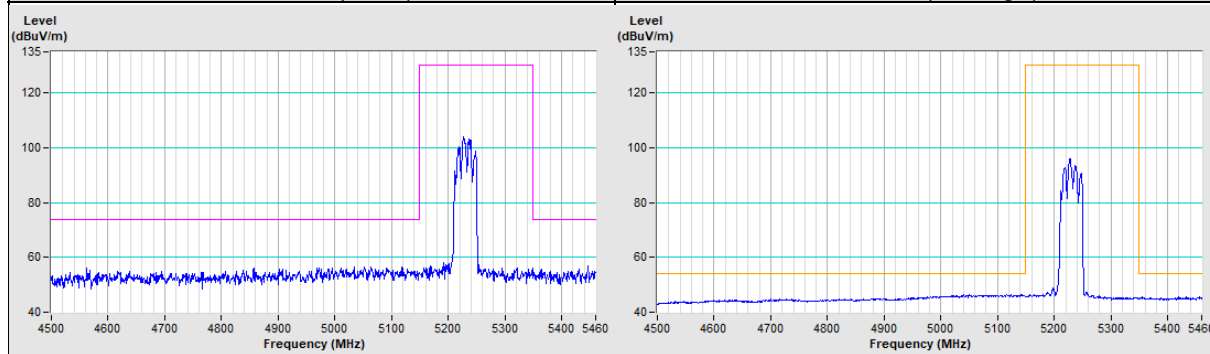

Vertical (Peak)	Vertical (Average)
------------------------	---------------------------

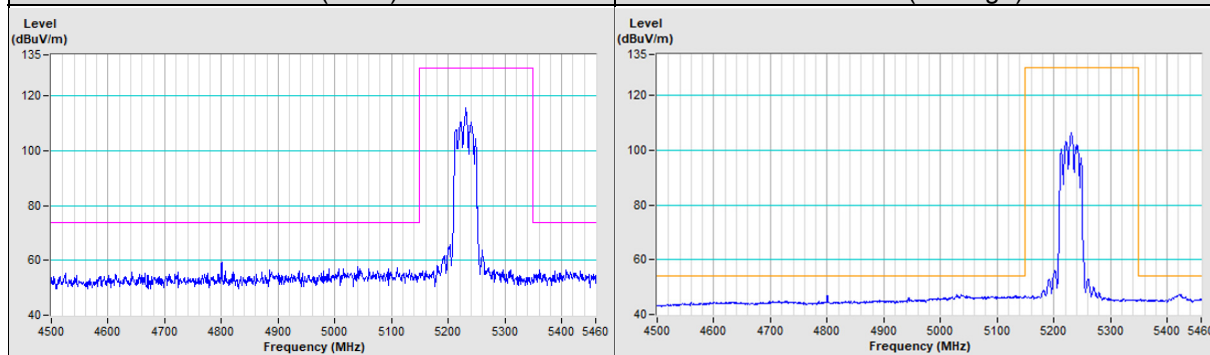

802.11ax (HE40) Channel 54

Horizontal (Peak)

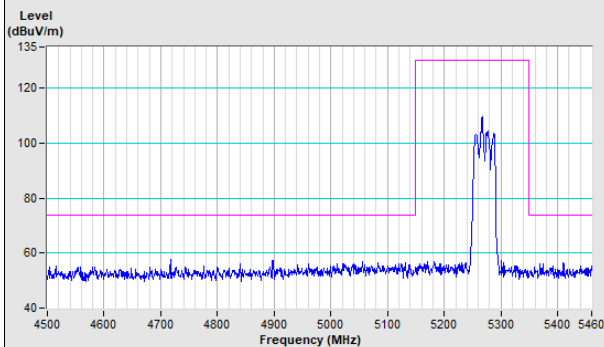

Horizontal (Average)

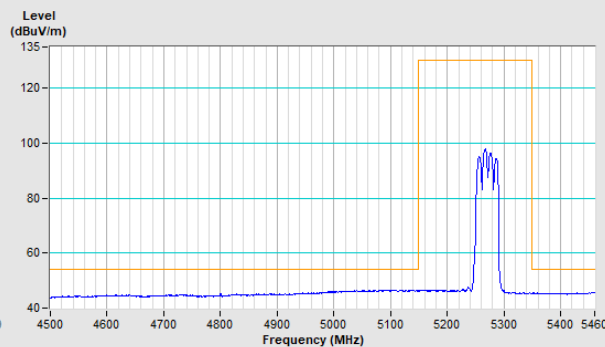

Vertical (Peak)

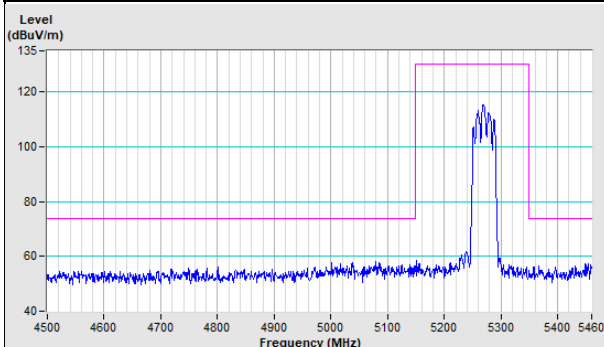

Vertical (Average)

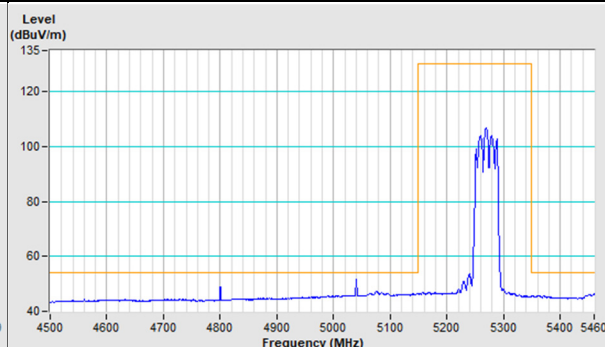

802.11ax (HE40) Channel 62

Horizontal (Peak)

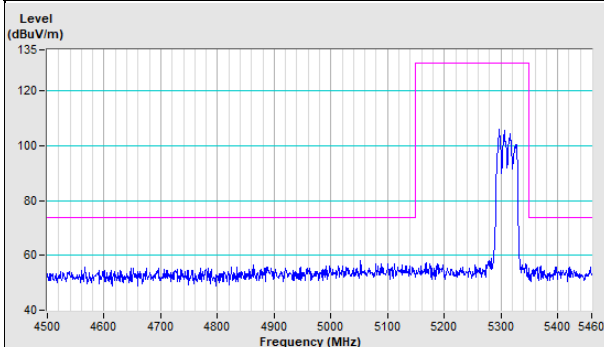

Horizontal (Average)

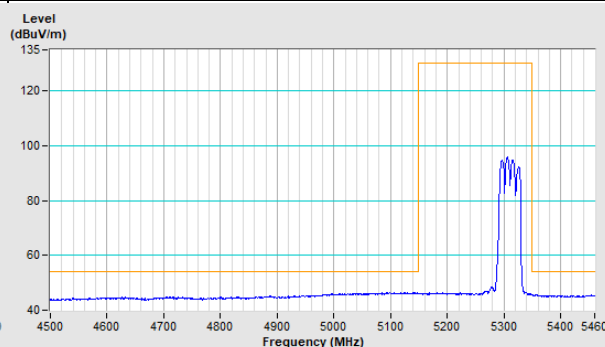

Vertical (Peak)

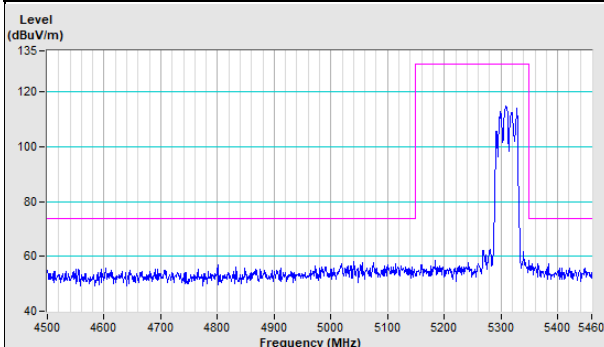

Vertical (Average)

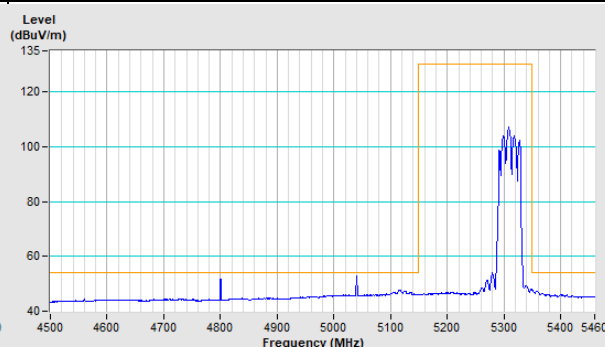

802.11ax (HE40) Channel 102

Horizontal (Peak)

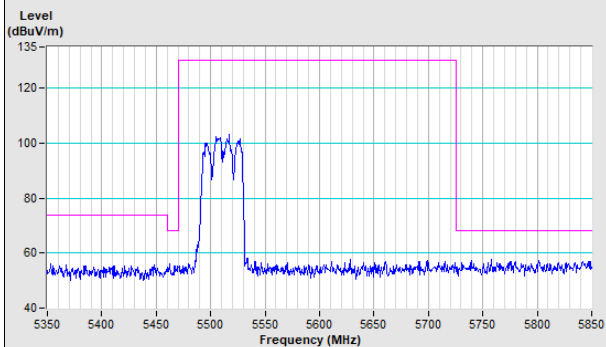

Horizontal (Average)

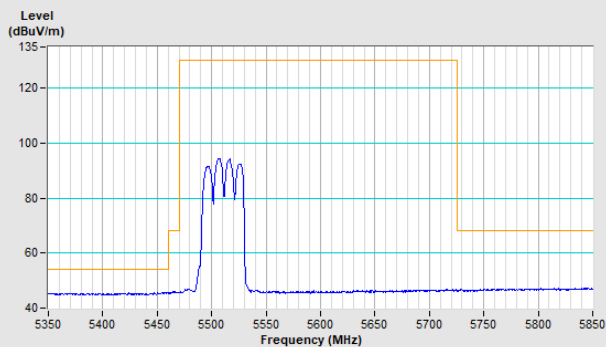

Vertical (Peak)

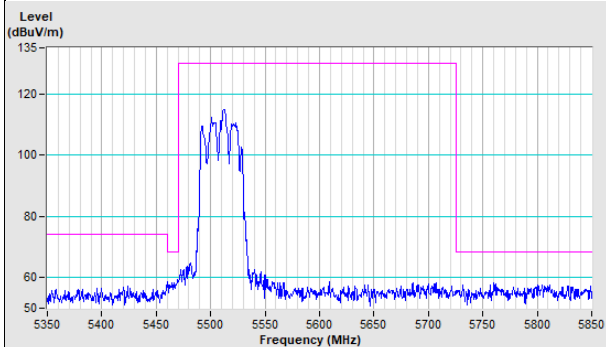

Vertical (Average)

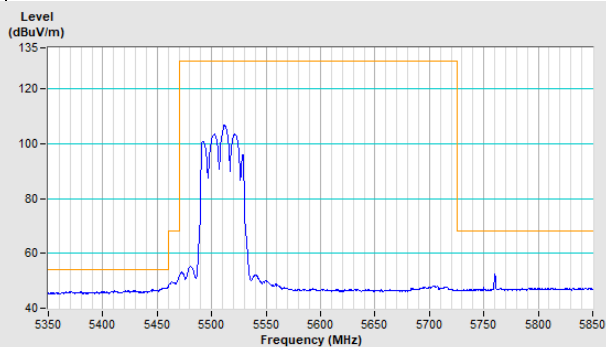

802.11ax (HE40) Channel 134

Horizontal (Peak)

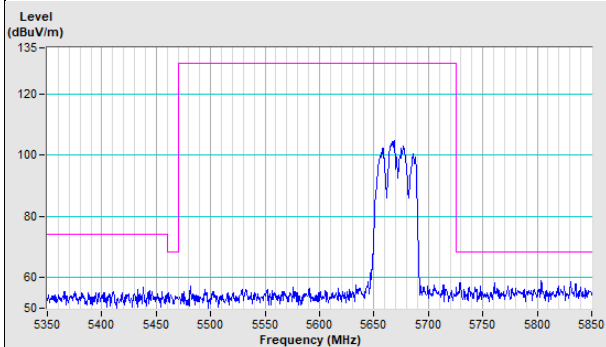

Vertical (Peak)

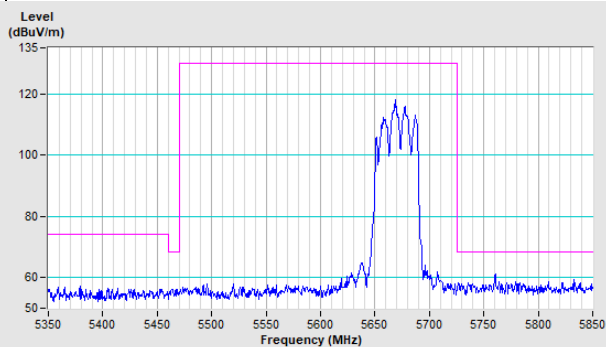

802.11ax (HE80) Channel 42

Horizontal (Peak)	Horizontal (Average)
--------------------------	-----------------------------

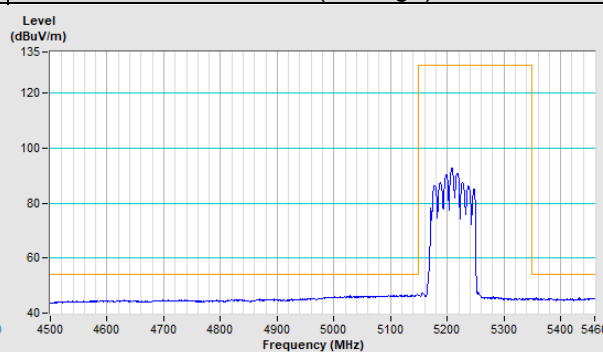
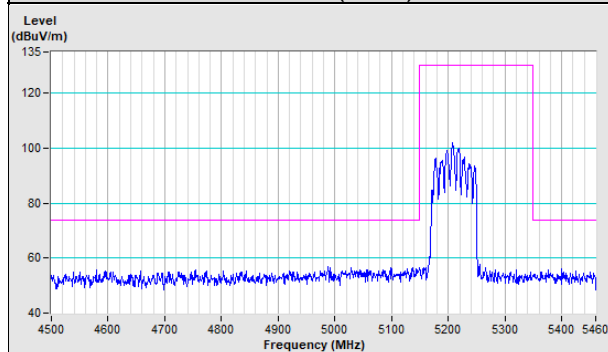

Vertical (Peak)	Vertical (Average)
------------------------	---------------------------

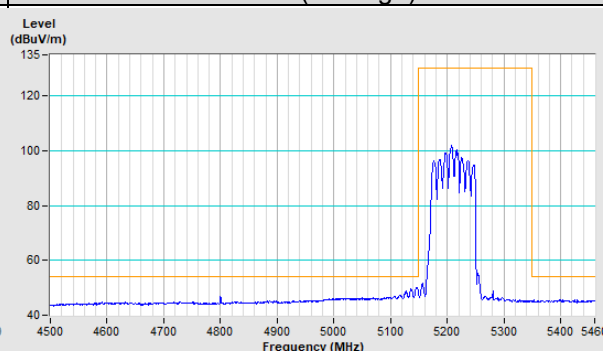
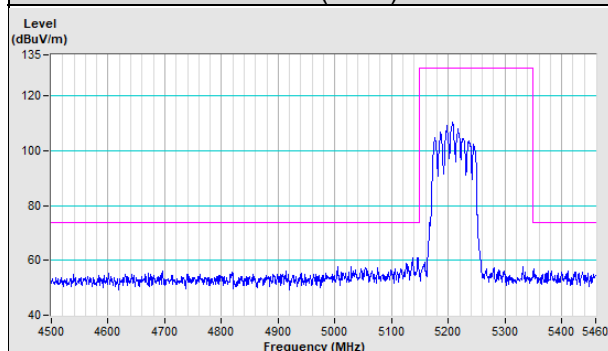

802.11ax (HE80) Channel 58

Horizontal (Peak)	Horizontal (Average)
--------------------------	-----------------------------

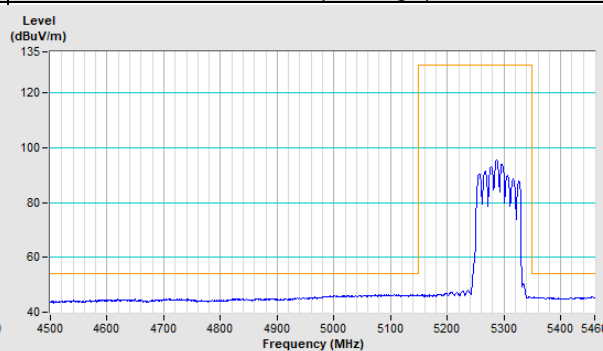
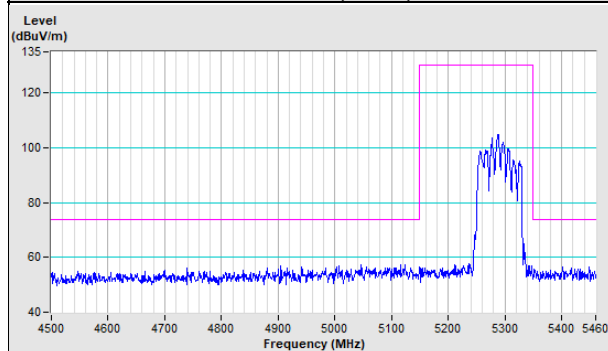

Vertical (Peak)	Vertical (Average)
------------------------	---------------------------

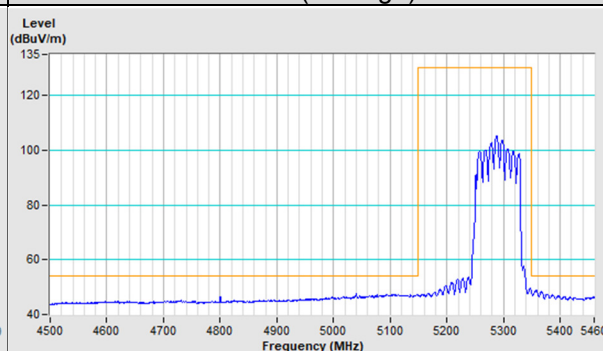
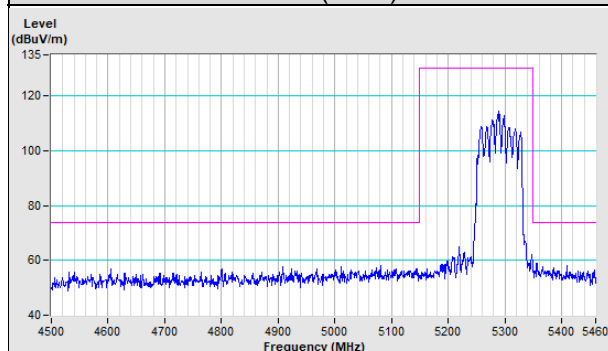

802.11ax (HE80) Channel 106

Horizontal (Peak)

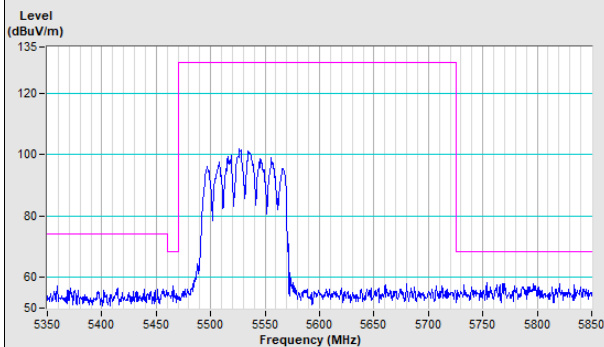

Horizontal (Average)

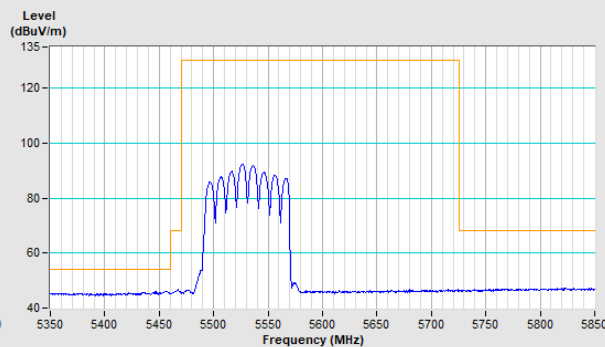

Vertical (Peak)

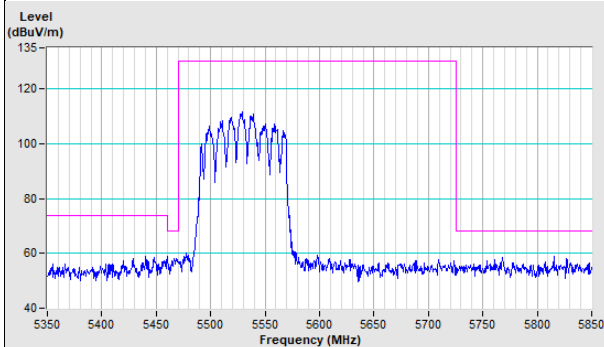

Vertical (Average)

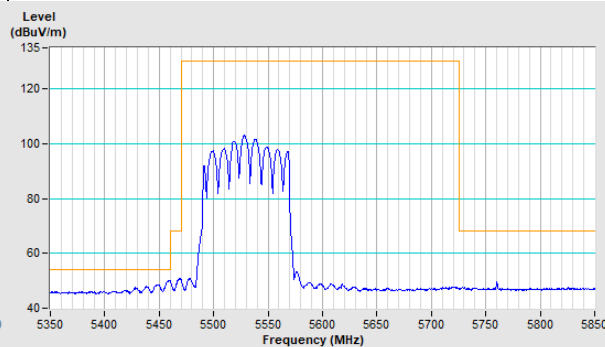

802.11ax (HE80) Channel 122

Horizontal (Peak)

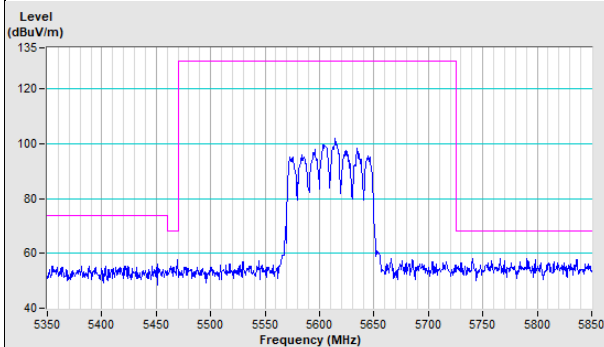

Horizontal (Average)

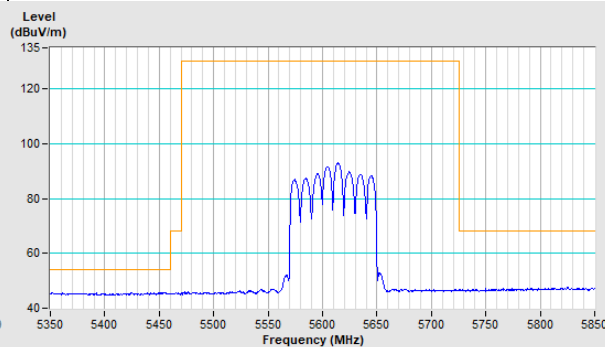

Vertical (Peak)

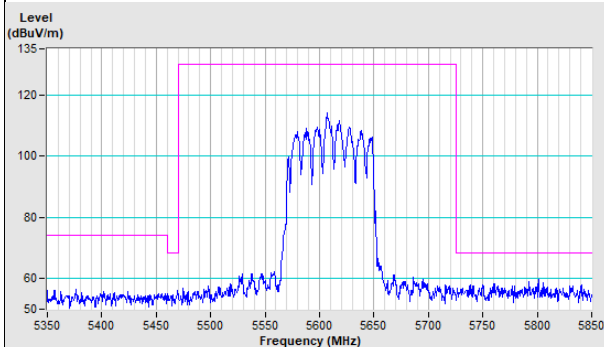

Vertical (Average)

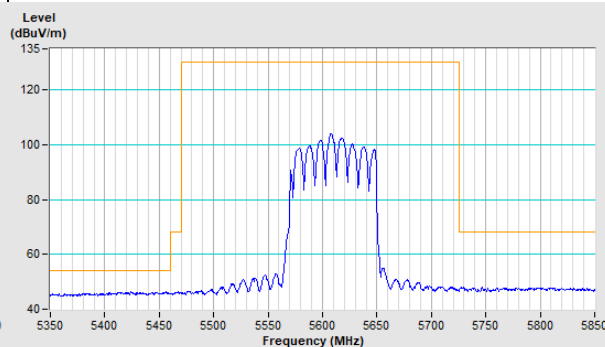

802.11ax (HE160) Channel 50

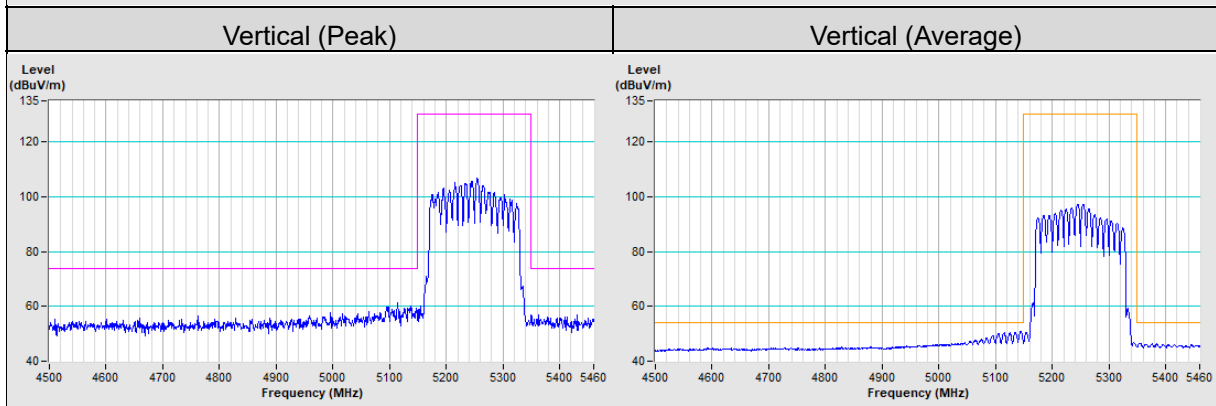
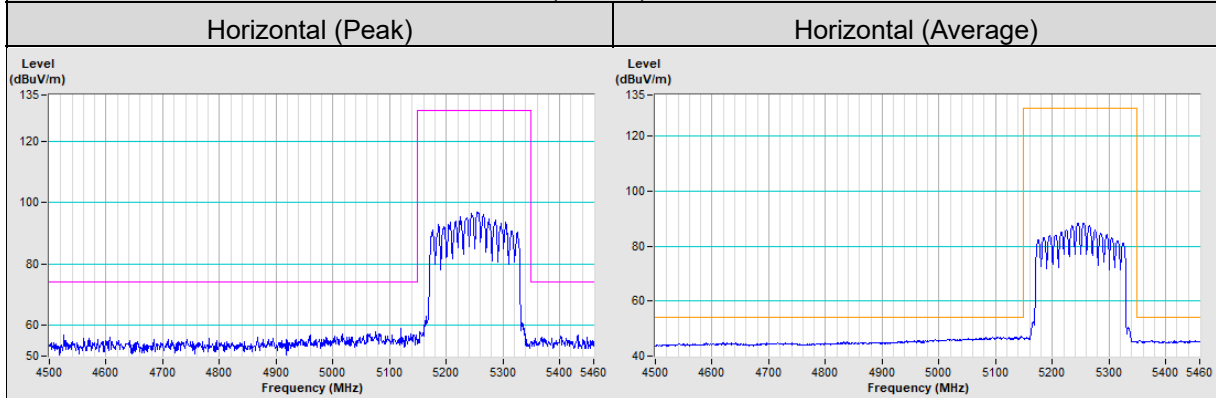

802.11ax (HE160) Channel 114

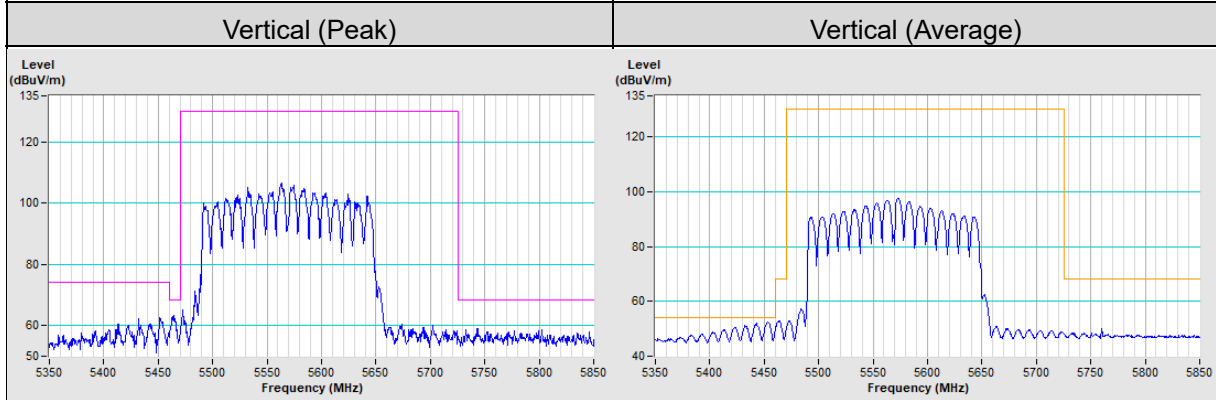
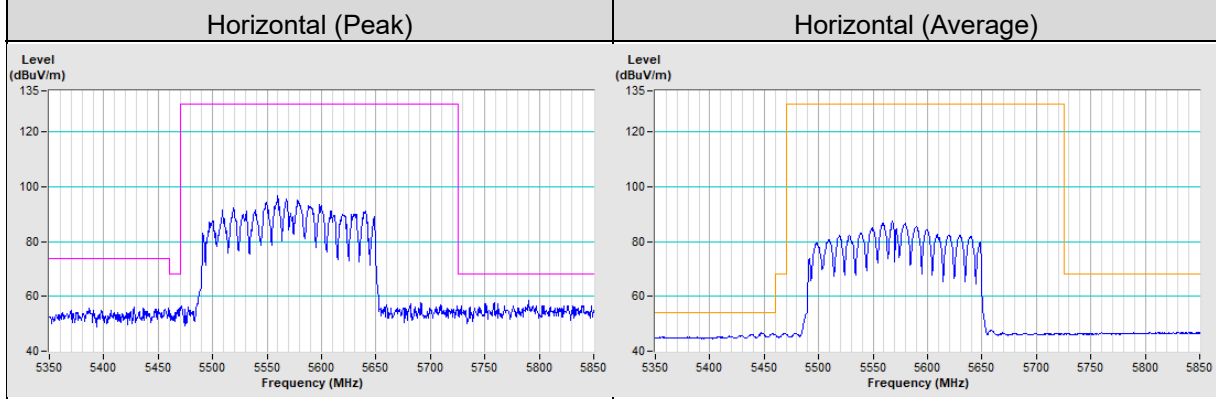

Appendix – Information of the Testing Laboratories

We, Bureau Veritas Consumer Products Services (H.K.) Ltd., Taoyuan Branch, were founded in 1988 to provide our best service in EMC, Radio, Telecom and Safety consultation. Our laboratories are FCC recognized accredited test firms and accredited and approved according to ISO/IEC 17025.

If you have any comments, please feel free to contact us at the following:

Lin Kou EMC/RF Lab

Tel: 886-2-26052180

Fax: 886-2-26051924

Hsin Chu EMC/RF/Telecom Lab

Tel: 886-3-6668565

Fax: 886-3-6668323

Hwa Ya EMC/RF/Safety Lab

Tel: 886-3-3183232

Fax: 886-3-3270892

Email: service.adt@tw.bureauveritas.com

Web Site: www.bureauveritas-adt.com

The address and road map of all our labs can be found in our web site also.

--- END ---