



RADIO TEST REPORT

FCC ID : 2AYRA-03812
Equipment : Linksys Classic Micro Router 5
Brand Name : LINKSYS
Model Name : E5450
Applicant : Linksys USA, Inc.
121 Theory, Irvine, CA. 92617, USA
Manufacturer : Linksys USA, Inc.
121 Theory, Irvine, CA. 92617, USA
Standard : 47 CFR FCC Part 15.407

The product was received on Oct. 31, 2018, and testing was started from Oct. 31, 2018 and completed on Oct. 16, 2023. We, Sporton International Inc. Hsinchu Laboratory, would like to declare that the tested sample has been evaluated in accordance with the procedures given in ANSI C63.10-2013 and shown compliance with the applicable technical standards.

The test results in this report apply exclusively to the tested model / sample. Without written approval of Sporton International Inc. Hsinchu Laboratory, the test report shall not be reproduced except in full.



Approved by: Sam Chen

Sporton International Inc. Hsinchu Laboratory
No.8, Ln. 724, Bo'ai St., Zhubei City, Hsinchu County 302010, Taiwan (R.O.C.)



Table of Contents

History of this test report.....3

Summary of Test Result.....4

1 General Description5

1.1 Information.....5

1.2 Testing Applied Standards9

1.3 Testing Location Information.....9

1.4 Measurement Uncertainty10

2 Test Configuration of EUT11

2.1 Test Channel Mode11

2.2 The Worst Case Measurement Configuration.....12

2.3 EUT Operation during Test13

2.4 Accessories14

2.5 Support Equipment.....14

2.6 Test Setup Diagram15

3 Transmitter Test Result18

3.1 AC Power-line Conducted Emissions18

3.2 Emission Bandwidth.....20

3.3 Maximum Conducted Output Power21

3.4 Peak Power Spectral Density.....23

3.5 Unwanted Emissions.....26

4 Test Equipment and Calibration Data30

Appendix A. Test Results of AC Power-line Conducted Emissions

Appendix B. Test Results of Emission Bandwidth

Appendix C. Test Results of Maximum Conducted Output Power

Appendix D. Test Results of Peak Power Spectral Density

Appendix E. Test Results of Unwanted Emissions

Appendix F. Test Results of Radiated Emission Co-location

Appendix G. Test Photos

Photographs of EUT v01



Summary of Test Result

Report Clause	Ref Std. Clause	Test Items	Result (PASS/FAIL)	Remark
1.1.2	15.203	Antenna Requirement	PASS	-
3.1	15.207	AC Power-line Conducted Emissions	PASS	-
3.2	15.407(a)	Emission Bandwidth	PASS	-
3.3	15.407(a)	Maximum Conducted Output Power	PASS	-
3.4	15.407(a)	Peak Power Spectral Density	PASS	-
3.5	15.407(b)	Unwanted Emissions	PASS	-

Note: Reference to Sporton Project No.: 8N1905

Conformity Assessment Condition:

1. The test results (PASS/FAIL) with all measurement uncertainty excluded are presented against the regulation limits or in accordance with the requirements stipulated by the applicant/manufacturer who shall bear all the risks of non-compliance that may potentially occur if measurement uncertainty is taken into account.
2. The measurement uncertainty please refer to each test result in the chapter "Measurement Uncertainty".

Disclaimer:

The product specifications of the EUT presented in the test report that may affect the test assessments are declared by the manufacturer who shall take full responsibility for the authenticity.

Reviewed by: Sam Chen

Report Producer: Lavender Zeng



1 General Description

1.1 Information

1.1.1 RF General Information

Frequency Range (MHz)	IEEE Std. 802.11	Ch. Frequency (MHz)	Channel Number
5150-5250	a, n (HT20), ac (VHT20)	5180-5240	36-48 [4]
5725-5850		5745-5825	149-165 [5]
5150-5250	n (HT40), ac (VHT40)	5190-5230	38-46 [2]
5725-5850		5755-5795	151-159 [2]
5150-5250	ac (VHT80)	5210	42 [1]
5725-5850		5775	155 [1]

Band	Mode	BWch (MHz)	Nant
5.15-5.25GHz	802.11a	20	2TX
5.15-5.25GHz	802.11a-BF	20	2TX
5.15-5.25GHz	802.11n HT20	20	2TX
5.15-5.25GHz	802.11n HT20-BF	20	2TX
5.15-5.25GHz	802.11ac VHT20	20	2TX
5.15-5.25GHz	802.11ac VHT20-BF	20	2TX
5.15-5.25GHz	802.11n HT40	40	2TX
5.15-5.25GHz	802.11n HT40-BF	40	2TX
5.15-5.25GHz	802.11ac VHT40	40	2TX
5.15-5.25GHz	802.11ac VHT40-BF	40	2TX
5.15-5.25GHz	802.11ac VHT80	80	2TX
5.15-5.25GHz	802.11ac VHT80-BF	80	2TX
5.725-5.85GHz	802.11a	20	2TX
5.725-5.85GHz	802.11a-BF	20	2TX
5.725-5.85GHz	802.11n HT20	20	2TX
5.725-5.85GHz	802.11n HT20-BF	20	2TX
5.725-5.85GHz	802.11ac VHT20	20	2TX
5.725-5.85GHz	802.11ac VHT20-BF	20	2TX
5.725-5.85GHz	802.11n HT40	40	2TX
5.725-5.85GHz	802.11n HT40-BF	40	2TX
5.725-5.85GHz	802.11ac VHT40	40	2TX
5.725-5.85GHz	802.11ac VHT40-BF	40	2TX
5.725-5.85GHz	802.11ac VHT80	80	2TX
5.725-5.85GHz	802.11ac VHT80-BF	80	2TX



Note:

- ♦ 11a, HT20 and HT40 use a combination of OFDM-BPSK, QPSK, 16QAM, 64QAM modulation.
- ♦ VHT20, VHT40, VHT80 use a combination of OFDM-BPSK, QPSK, 16QAM, 64QAM, 256QAM modulation.
- ♦ BWch is the nominal channel bandwidth.

1.1.2 Antenna Information

Ant.	Brand	Model Name	Antenna Type	Connector	Gain (dBi)	
					2.4Gz	5GHz
1	FIT	4TS4009-A0001-JH	Dipole Antenna	I-PEX	2.52	3.37
2	FIT	4TS4009-A0002JH	Dipole Antenna	I-PEX	2.53	3.28

Note 1: The above information was declared by manufacturer.

Note 2: The EUT has two antennas.

For WLAN 2.4GHz (2TX/2RX):

Ant. 1 (Port 1) and Ant. 2 (Port 2) could transmit/receive simultaneously.

For WLAN 5GHz (2TX/2RX):

Ant. 1 (Port 1) and Ant. 2 (Port 2) could transmit/receive simultaneously.



Note 3: Directional gain information

Type	Maximum Output Power	Power Spectral Density
Non-BF	Directional gain = Max.gain + array gain. For power measurements on IEEE 802.11 devices Array Gain = 0 dB (i.e., no array gain) for N ANT ≤ 4	$DirectionalGain = 10 \cdot \log \left[\frac{\sum_{j=1}^{N_{ANT}} \left[\sum_{k=1}^{N_{ANT}} \xi_{j,k} \right]^2}{N_{ANT}} \right]$
BF	$DirectionalGain = 10 \cdot \log \left[\frac{\sum_{j=1}^{N_{ANT}} \left[\sum_{k=1}^{N_{ANT}} \xi_{j,k} \right]^2}{N_{ANT}} \right]$	$DirectionalGain = 10 \cdot \log \left[\frac{\sum_{j=1}^{N_{ANT}} \left[\sum_{k=1}^{N_{ANT}} \xi_{j,k} \right]^2}{N_{ANT}} \right]$

Ex.

Directional Gain (NSS1) formula :

$$DirectionalGain = 10 \cdot \log \left[\frac{\sum_{j=1}^{N_{ANT}} \left[\sum_{k=1}^{N_{ANT}} \xi_{j,k} \right]^2}{N_{ANT}} \right]$$

$$NSS1(g1,1) = 10^{G1/20} ; NSS1(g1,2) = 10^{G2/20} ; NSS1(g1,2) = 10^{G3/20} ; NSS1(g1,2) = 10^{G4/20}$$

$$g_{j,k} = (Nss1(g1,1) + Nss1(g1,2) + Nss1(g1,3) + Nss1(g1,4))^2$$

$$DG = 10 \log[(Nss1(g1,1) + Nss1(g1,2) + Nss1(g1,3) + Nss1(g1,4))^2 / N_{ANT}] => 10$$

$$\log[(10^{G1/20} + 10^{G2/20} + 10^{G3/20} + 10^{G4/20})^2 / N_{ANT}]$$

Where ;

$$2.4G \ G1 = 2.52 \text{ dBi} ; G2 = 2.53 \text{ dBi} ;$$

$$5G \ UNII-1 \ G1 = 3.37 \text{ dBi} ; G2 = 3.28 \text{ dBi} ;$$

$$5G \ UNII-3 \ G1 = 3.37 \text{ dBi} ; G2 = 3.28 \text{ dBi} ;$$

$$2.4G \ DG = 5.54 \text{ dBi}$$

$$5G \ UNII-1 \ DG = 6.34 \text{ dBi}$$

$$5G \ UNII-3 \ DG = 6.34 \text{ dBi}$$



1.1.3 Mode Test Duty Cycle

Mode	DC	DCF(dB)	T(s)	VBW(Hz) ≥ 1/T
802.11a-BF	0.889	0.511	1.453m	1k
802.11ac VHT20-BF	0.937	0.283	3.618m	300
802.11ac VHT40-BF	0.938	0.278	4.058m	300
802.11ac VHT80-BF	0.927	0.329	4.008m	300

1.1.4 EUT Operational Condition

EUT Power Type	From Power Adapter			
Beamforming Function	<input checked="" type="checkbox"/>	With beamforming for 802.11a/n/ac in 5GHz	<input type="checkbox"/>	Without beamforming
Function	<input type="checkbox"/>	Outdoor P2M	<input checked="" type="checkbox"/>	Indoor P2M
	<input type="checkbox"/>	Fixed P2P	<input type="checkbox"/>	Client
Test Software Version	QATool_1.0.3.4			

Note: The above information was declared by manufacturer.



1.2 Testing Applied Standards

According to the specifications of the manufacturer, the EUT must comply with the requirements of the following standards:

- ◆ 47 CFR FCC Part 15.407
- ◆ ANSI C63.10-2013
- ◆ FCC KDB 789033 D02 v02r01

The following reference test guidance is not within the scope of accreditation of TAF.

- ◆ FCC KDB 662911 D01 v02r01
- ◆ FCC KDB 412172 D01 v01r01
- ◆ FCC KDB 414788 D01 v01r01

1.3 Testing Location Information

Testing Location Information	
Test Lab. : Sporton International Inc. Hsinchu Laboratory	
Hsinchu	ADD: No.8, Ln. 724, Bo'ai St., Zhubei City, Hsinchu County 302010, Taiwan (R.O.C.)
(TAF: 3787)	TEL: 886-3-656-9065 FAX: 886-3-656-9085
	Test site Designation No. TW3787 with FCC.
	Conformity Assessment Body Identifier (CABID) TW3787 with ISED.

Test Condition	Test Site No.	Test Engineer	Test Environment (°C / %)	Test Date
RF Conducted	TH01-CB	Paul Chen	22 / 64	Nov. 23, 2018 ~ Dec. 04, 2018
Radiated (Below 1GHz)	03CH04-CB	Jackson Peng	22-23 / 56-57	Sep. 22, 2023 ~ Sep. 23, 2023
Radiated (Above 1GHz)	03CH01-CB	Stim Sung	22 / 54	Oct. 31, 2018 ~ Dec. 01, 2018
AC Conduction	CO01-CB	Elvin Yeh	22~23 / 60~61	Sep. 14, 2023 ~ Oct. 16, 2023

The tested sample of the AC power-line conducted emissions and Unwanted Emissions Below 1GHz test item was received on Aug. 30, 2023.



1.4 Measurement Uncertainty

ISO/IEC 17025 requires that an estimate of the measurement uncertainties associated with the emissions test results be included in the report. The measurement uncertainties given below are based on a 95% confidence level (based on a coverage factor (k=2)

Test Date Before Jun. 01, 2023

Test Items	Uncertainty	Remark
Radiated Emission (1GHz ~ 18GHz)	3.7 dB	Confidence levels of 95%
Radiated Emission (18GHz ~ 40GHz)	3.5 dB	Confidence levels of 95%
Conducted Emission	1.7 dB	Confidence levels of 95%
Output Power Measurement	1.33 dB	Confidence levels of 95%
Power Density Measurement	1.27 dB	Confidence levels of 95%
Bandwidth Measurement	9.74 x10 ⁻⁸	Confidence levels of 95%

Test Date After May 31, 2023

Test Items	Uncertainty	Remark
Conducted Emission (150kHz ~ 30MHz)	3.4 dB	Confidence levels of 95%
Radiated Emission (9kHz ~ 30MHz)	3.7 dB	Confidence levels of 95%
Radiated Emission (30MHz ~ 1,000MHz)	5.1 dB	Confidence levels of 95%



2 Test Configuration of EUT

2.1 Test Channel Mode

Mode	PowerSetting
802.11a-BF_Nss1,(6Mbps)_2TX	-
5180MHz	27
5200MHz	30
5240MHz	35
5745MHz	35
5785MHz	35
5825MHz	30
802.11ac VHT20-BF_Nss1,(MCS0)_2TX	-
5180MHz	29
5200MHz	34
5240MHz	35
5745MHz	30
5785MHz	30
5825MHz	30
802.11ac VHT40-BF_Nss1,(MCS0)_2TX	-
5190MHz	18
5230MHz	35
5755MHz	35
5795MHz	35
802.11ac VHT80-BF_Nss1,(MCS0)_2TX	-
5210MHz	15
5775MHz	28

Note:

- ♦ VHT20/VHT40 covers HT20/HT40, due to same modulation. The power setting for 802.11n HT20 and HT40 are the same or lower than 802.11ac VHT20 and VHT40.
- ♦ There are two modes of EUT for 802.11a/n/ac in 5GHz. One is beamforming mode, and the other is non-beamforming mode, after evaluating, beamforming mode has been evaluated to be the worst case, so it was selected to test and record in this test report.



2.2 The Worst Case Measurement Configuration

The Worst Case Mode for Following Conformance Tests	
Tests Item	AC power-line conducted emissions
Condition	AC power-line conducted measurement for line and neutral Test Voltage: 120Vac / 60Hz
Operating Mode	Normal Link
1	EUT + Adapter 1
2	EUT + Adapter 2 + US plug
3	EUT + Adapter 3
For operating mode 1 is the worst case and it was record in this test report.	

The Worst Case Mode for Following Conformance Tests	
Tests Item	Emission Bandwidth Maximum Conducted Output Power Peak Power Spectral Density Unwanted Emissions
Test Condition	Conducted measurement at transmit chains

The Worst Case Mode for Following Conformance Tests	
Tests Item	Unwanted Emissions
Test Condition	Radiated measurement If EUT consist of multiple antenna assembly (multiple antenna are used in EUT regardless of spatial multiplexing MIMO configuration), the radiated test should be performed with highest antenna gain of each antenna type.
Operating Mode < 1GHz	Normal Link
After evaluating, "Z axis" generated the worst test result, So the measurement will follow this same test configuration.	
1	EUT in Z axis + Adapter 1
2	EUT in Z axis + Adapter 2 + US plug
3	EUT in Z axis + Adapter 3
For operating mode 3 is the worst case and it was record in this test report.	
Operating Mode > 1GHz	CTX
After evaluating, "Z axis" generated the worst test result, So the measurement will follow this same test configuration.	
1	EUT in Z axis



The Worst Case Mode for Following Conformance Tests	
Tests Item	Simultaneous Transmission Analysis - Radiated Emission Co-location
Test Condition	Radiated measurement
Operating Mode	Normal Link
After evaluating, "Z axis" generated the worst test result, So the measurement will follow this same test configuration.	
1	EUT in Z axis with WLAN 2.4GHz + WLAN 5GHz
Refer to Appendix F for Radiated Emission Co-location.	

The Worst Case Mode for Following Conformance Tests	
Tests Item	Simultaneous Transmission Analysis - Co-location RF Exposure Evaluation
Operating Mode	
1	WLAN 2.4GHz + WLAN 5GHz
Refer to Sporton Test Report No.: FA8N1905-05 for Co-location RF Exposure Evaluation.	

2.3 EUT Operation during Test

For CTX Mode:

During the test, the following programs under WIN XP were executed.

The program was executed as follows:

1. During the test, the EUT operation to normal function.
2. Executed command fixed test channel under DOS.
3. Executed "Lantest.exe" to link with the remote workstation to transmit and receive packet by WLAN module and transmit duty cycle no less than 98%.

For Normal Link:

During the test, the EUT operation to normal function.



2.4 Accessories

Accessories			
Power	Brand	Model	Rating
Adapter 1 (Fixed plug)	Ktec	KSAS0051200050VUD	Input: 100-240V ~ 50/60Hz, 0.18A Output: 12V, 0.5A
Adapter 2 (Removable plug)	Ktec	KSA-6W-120050D5D	Input: 100-240V ~ 50/60Hz, 0.18A Output: 12.0V, 0.5A, 6.0W
Adapter 3 (Fixed plug)	Ktec	KSA-6W-120050VUD	Input: 100-240V ~ 50/60Hz, 0.18A Output: 12V, 0.5A
Others			
US plug*1 (for Adapter 2 use)			
RJ-45 cable*1, Non-shielded, 0.88m			

2.5 Support Equipment

For AC Conduction:

Support Equipment				
No.	Equipment	Brand Name	Model Name	FCC ID
A	WAN NB	DELL	E6430	N/A
B	LAN NB	DELL	E6430	N/A
C	2.4G NB	DELL	E6430	N/A
D	5G NB	DELL	E6430	N/A

For Radiated (below 1GHz):

Support Equipment				
No.	Equipment	Brand Name	Model Name	FCC ID
A	LAN NB	DELL	E4300	N/A
B	WAN NB	DELL	E4300	N/A
C	2.4G NB	DELL	E4300	N/A
D	5G NB	DELL	E4300	N/A

For Radiated (above 1GHz) and RF Conducted:

Support Equipment				
No.	Equipment	Brand Name	Model Name	FCC ID
A	NB	DELL	E4300	N/A
B	NB	DELL	E4300	N/A
C	WLAN module	Boardcom	BCM943162ZP	QDS-BRCM1075

2.6 Test Setup Diagram

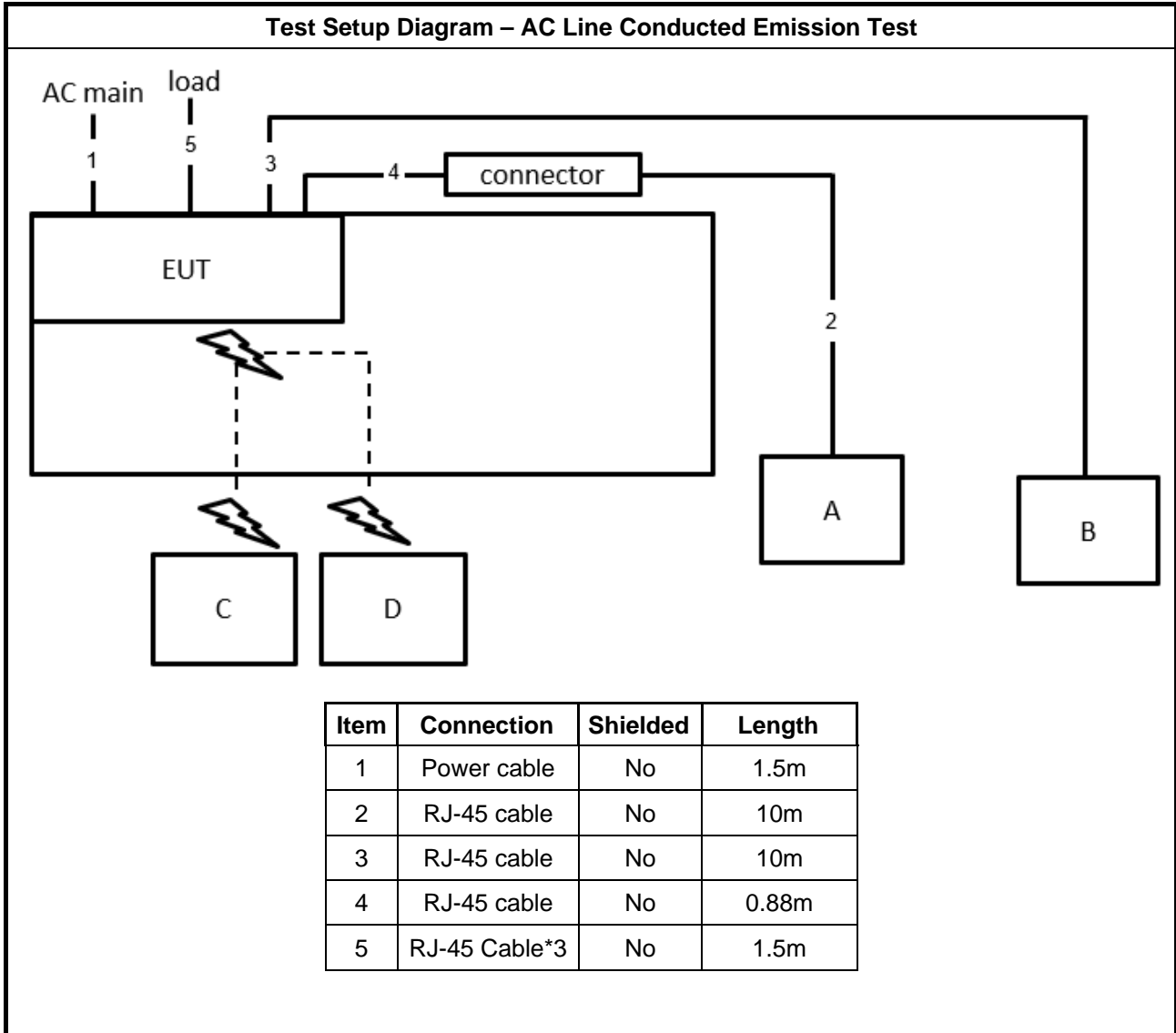

Test Setup Diagram - Radiated Test < 1GHz

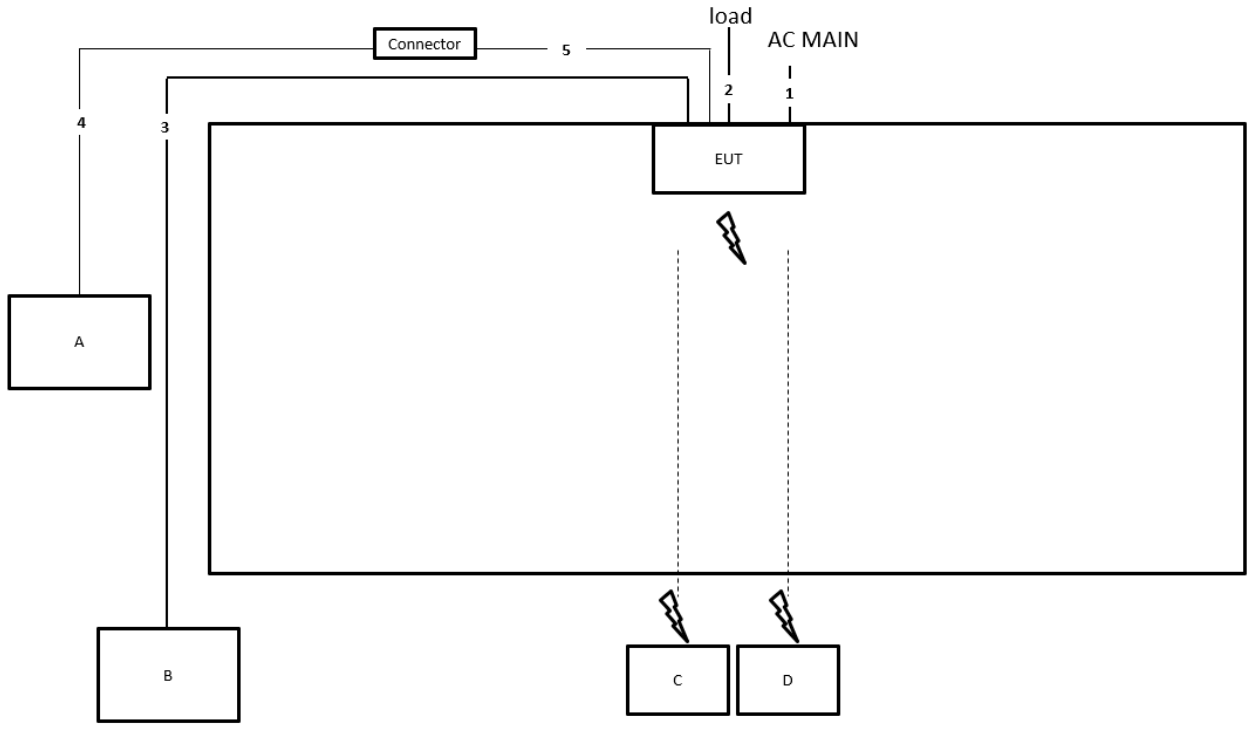

Item	Connection	Shielded	Length
1	Power cable	No	1.5m
2	RJ-45 cable*3	No	1m
3	RJ-45 cable	No	10m
4	RJ-45 cable	No	10m
5	RJ-45 cable	No	0.88m

Test Setup Diagram - Radiated Test > 1GHz

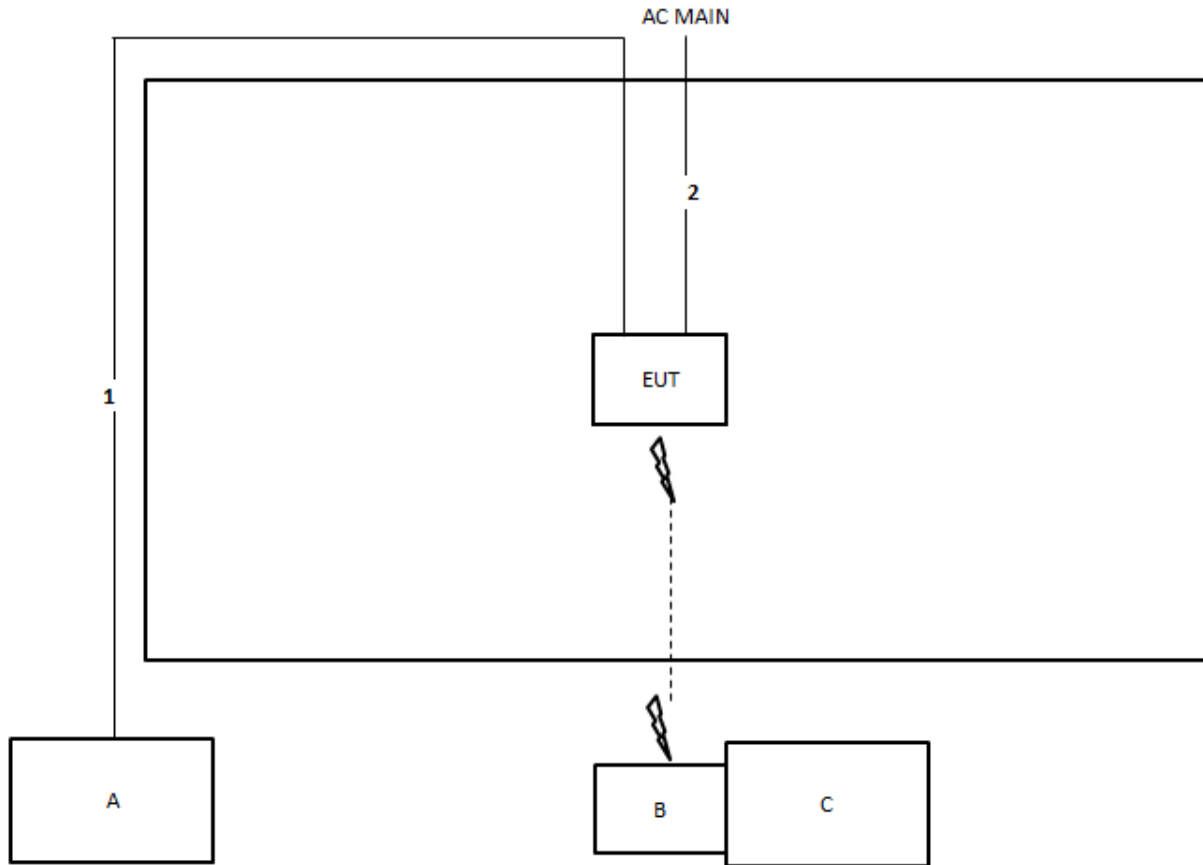

Item	Connection	Shielded	Length
1	RJ-45 cable	No	10m
2	Power cable	No	3.8m



3 Transmitter Test Result

3.1 AC Power-line Conducted Emissions

3.1.1 AC Power-line Conducted Emissions Limit

AC Power-line Conducted Emissions Limit		
Frequency Emission (MHz)	Quasi-Peak	Average
0.15-0.5	66 - 56 *	56 - 46 *
0.5-5	56	46
5-30	60	50

Note 1: * Decreases with the logarithm of the frequency.

3.1.2 Measuring Instruments

Refer a test equipment and calibration data table in this test report.

3.1.3 Test Procedures

Test Method
<input checked="" type="checkbox"/> Refer as ANSI C63.10-2013, clause 6.2 for AC power-line conducted emissions.

3.1.4 Test Setup

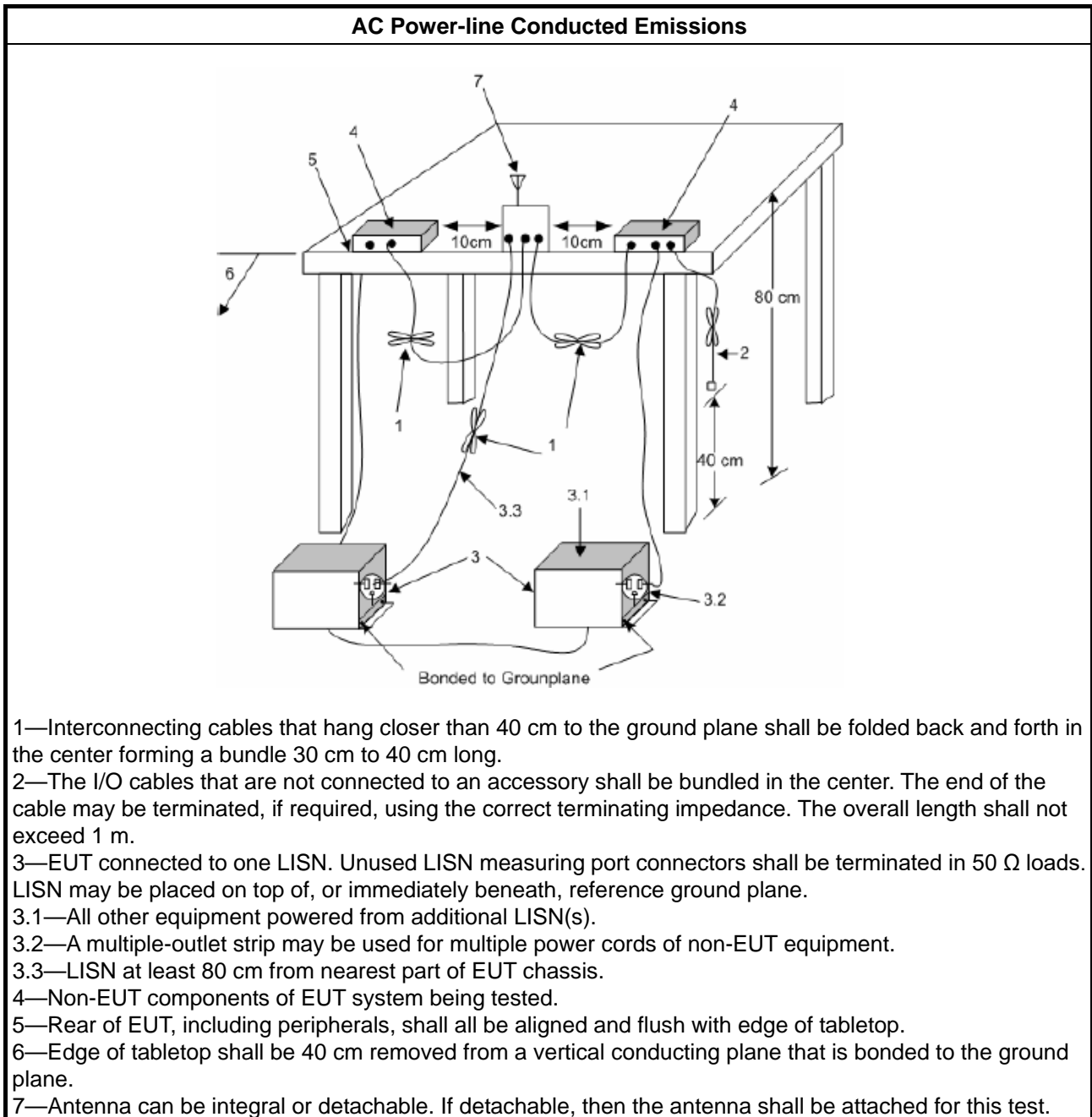

3.1.5 Measurement Results Calculation

The measured Level is calculated using:

- a. Corrected Reading: LISN Factor (LISN) + Attenuator (AT/AUX) + Cable Loss (CL) + Read Level (Raw) = Level
- b. Margin = -Limit + Level

3.1.6 Test Result of AC Power-line Conducted Emissions

Refer as Appendix A

3.2 Emission Bandwidth

3.2.1 Emission Bandwidth Limit

Emission Bandwidth Limit	
UNII Devices	
<input checked="" type="checkbox"/>	For the 5.15-5.25 GHz band, N/A
<input type="checkbox"/>	For the 5.25-5.35 GHz band, the maximum conducted output power shall not exceed the lesser of 250 mW or 11 dBm + 10 log B, where B is the 26 dB emission bandwidth in MHz.
<input type="checkbox"/>	For the 5.47-5.725 GHz band, the maximum conducted output power shall not exceed the lesser of 250 mW or 11 dBm + 10 log B, where B is the 26 dB emission bandwidth in MHz.
<input checked="" type="checkbox"/>	For the 5.725-5.85 GHz band, 6 dB emission bandwidth \geq 500kHz.
LE-LAN Devices	
<input type="checkbox"/>	For the band 5.15-5.25 GHz, the maximum e.i.r.p. shall not exceed 200 mW or 10 + 10 log B, dBm, whichever power is less. B is the 99% emission bandwidth in MHz.
<input type="checkbox"/>	For the 5.25-5.35 GHz band, the maximum e.i.r.p. shall not exceed 1.0 W or 17 + 10 log B, dBm, whichever power is less. B is the 99% emission bandwidth in MHz
<input type="checkbox"/>	For the 5.47-5.6 GHz band and 5.65-5.725 GHz band, the maximum e.i.r.p. shall not exceed 1.0 W or 17 + 10 log B, dBm, whichever power is less. B is the 99% emission bandwidth in MHz
<input type="checkbox"/>	For the 5.725-5.85 GHz band, 6 dB emission bandwidth \geq 500kHz.

3.2.2 Measuring Instruments

Refer a test equipment and calibration data table in this test report.

3.2.3 Test Procedures

Test Method							
<ul style="list-style-type: none"> ▪ For the emission bandwidth shall be measured using one of the options below: <table border="1" style="width: 100%; border-collapse: collapse;"> <tr> <td style="width: 30px;"><input checked="" type="checkbox"/></td> <td>Refer as FCC KDB 789033, clause C for EBW and clause D for OBW measurement.</td> </tr> <tr> <td><input type="checkbox"/></td> <td>Refer as ANSI C63.10, clause 6.9.1 for occupied bandwidth testing.</td> </tr> <tr> <td><input type="checkbox"/></td> <td>Refer as IC RSS-Gen, clause 4.6 for bandwidth testing.</td> </tr> </table> 		<input checked="" type="checkbox"/>	Refer as FCC KDB 789033, clause C for EBW and clause D for OBW measurement.	<input type="checkbox"/>	Refer as ANSI C63.10, clause 6.9.1 for occupied bandwidth testing.	<input type="checkbox"/>	Refer as IC RSS-Gen, clause 4.6 for bandwidth testing.
<input checked="" type="checkbox"/>	Refer as FCC KDB 789033, clause C for EBW and clause D for OBW measurement.						
<input type="checkbox"/>	Refer as ANSI C63.10, clause 6.9.1 for occupied bandwidth testing.						
<input type="checkbox"/>	Refer as IC RSS-Gen, clause 4.6 for bandwidth testing.						

3.2.4 Test Setup

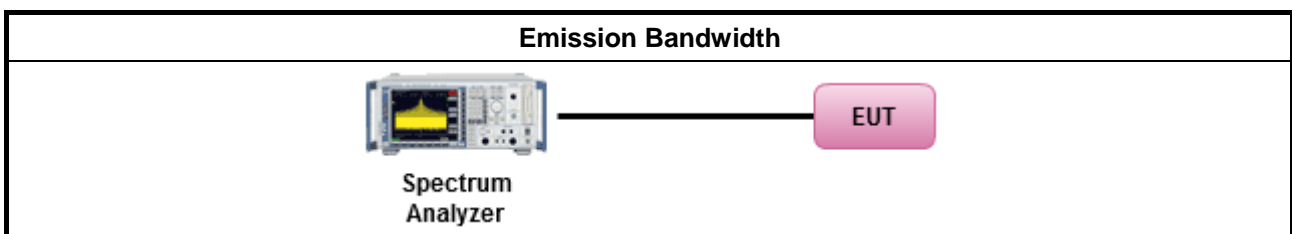

3.2.5 Test Result of Emission Bandwidth

Refer as Appendix B



3.3 Maximum Conducted Output Power

3.3.1 Maximum Conducted Output Power Limit

Maximum Conducted Output Power Limit	
UNII Devices	
<input checked="" type="checkbox"/>	For the 5.15-5.25 GHz band:
<input type="checkbox"/>	<ul style="list-style-type: none"> ▪ Outdoor AP: the maximum conducted output power (P_{Out}) shall not exceed the lesser of 1 W. If $G_{TX} > 6$ dBi, then $P_{Out} = 30 - (G_{TX} - 6)$. e.i.r.p. at any elevation angle above 30 degrees $\leq 125mW$ [21dBm] ▪ Indoor AP: the maximum conducted output power (P_{Out}) shall not exceed the lesser of 1 W. If $G_{TX} > 6$ dBi, then $P_{Out} = 30 - (G_{TX} - 6)$ ▪ Point-to-point AP: the maximum conducted output power (P_{Out}) shall not exceed the lesser of 1 W. If $G_{TX} > 23$ dBi, then $P_{Out} = 30 - (G_{TX} - 23)$. ▪ Mobile or Portable Client: the maximum conducted output power (P_{Out}) shall not exceed the lesser of 250 mW. If $G_{TX} > 6$ dBi, then $P_{Out} = 24 - (G_{TX} - 6)$.
<input type="checkbox"/>	For the 5.25-5.35 GHz band, the maximum conducted output power (P_{Out}) shall not exceed the lesser of 250 mW or $11 \text{ dBm} + 10 \log B$, where B is the 26 dB emission bandwidth in MHz. If $G_{TX} > 6$ dBi, then $P_{Out} = 24 - (G_{TX} - 6)$.
<input type="checkbox"/>	For the 5.47-5.725 GHz band, the maximum conducted output power (P_{Out}) shall not exceed the lesser of 250 mW or $11 \text{ dBm} + 10 \log B$, where B is the 26 dB emission bandwidth in MHz. If $G_{TX} > 6$ dBi, then $P_{Out} = 24 - (G_{TX} - 6)$.
<input checked="" type="checkbox"/>	For the 5.725-5.85 GHz band:
<input type="checkbox"/>	<ul style="list-style-type: none"> ▪ Point-to-multipoint systems (P2M): the maximum conducted output power (P_{Out}) shall not exceed the lesser of 1 W. If $G_{TX} > 6$ dBi, then $P_{Out} = 30 - (G_{TX} - 6)$. ▪ Point-to-point systems (P2P): the maximum conducted output power (P_{Out}) shall not exceed the lesser of 1 W.
LE-LAN Devices	
<input type="checkbox"/>	For the 5.15-5.25 GHz band, the maximum e.i.r.p. shall not exceed 200 mW or $10 + 10 \log B$, dBm, whichever power is less. B is the 99% emission bandwidth in MHz.
<input type="checkbox"/>	For the 5.25-5.35 GHz band, the maximum e.i.r.p. shall not exceed 1.0 W or $17 + 10 \log B$, dBm, whichever power is less. B is the 99% emission bandwidth in MHz
<input type="checkbox"/>	For the 5.47-5.6 GHz band and 5.65-5.725 GHz band, the maximum e.i.r.p. shall not exceed 1.0 W or $17 + 10 \log B$, dBm, whichever power is less. B is the 99% emission bandwidth in MHz
<input type="checkbox"/>	For the 5.725-5.85 GHz band:
<input type="checkbox"/>	<ul style="list-style-type: none"> ▪ Point-to-multipoint systems (P2M): the maximum conducted output power (P_{Out}) shall not exceed the lesser of 1 W. If $G_{TX} > 6$ dBi, then $P_{Out} = 30 - (G_{TX} - 6)$. ▪ Point-to-point systems (P2P): the maximum conducted output power (P_{Out}) shall not exceed the lesser of 1 W.
P_{Out} = maximum conducted output power in dBm, G_{TX} = the maximum transmitting antenna directional gain in dBi.	

3.3.2 Measuring Instruments

Refer a test equipment and calibration data table in this test report.

3.3.3 Test Procedures

Test Method	
<ul style="list-style-type: none"> ▪ Maximum Conducted Output Power 	
Average over on/off periods with duty factor	
<input type="checkbox"/> Refer as FCC KDB 789033, clause E Method SA-2 (spectral trace averaging).	
<input type="checkbox"/> Refer as FCC KDB 789033, clause E Method SA-2 Alt. (RMS detection with slow sweep speed)	
Wideband RF power meter and average over on/off periods with duty factor	
<input checked="" type="checkbox"/> Refer as FCC KDB 789033, clause E Method PM-G (using an RF average power meter).	
<ul style="list-style-type: none"> ▪ For conducted measurement. 	
<ul style="list-style-type: none"> ▪ If the EUT supports multiple transmit chains using options given below: Refer as FCC KDB 662911, In-band power measurements. Using the measure-and-sum approach, measured all transmit ports individually. Sum the power (in linear power units e.g., mW) of all ports for each individual sample and save them. 	
<ul style="list-style-type: none"> ▪ If multiple transmit chains, EIRP calculation could be following as methods: $P_{total} = P_1 + P_2 + \dots + P_n$ (calculated in linear unit [mW] and transfer to log unit [dBm]) $EIRP_{total} = P_{total} + DG$ 	

3.3.4 Test Setup

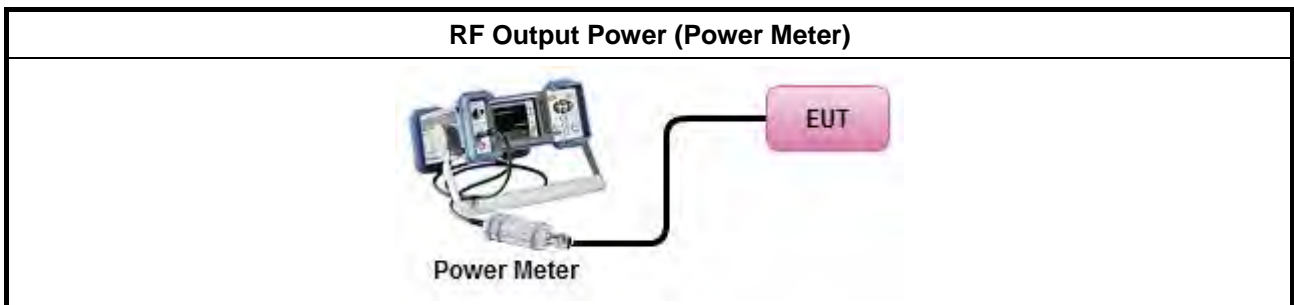

3.3.5 Test Result of Maximum Conducted Output Power

Refer as Appendix C



3.4 Peak Power Spectral Density

3.4.1 Peak Power Spectral Density Limit

Peak Power Spectral Density Limit	
UNII Devices	
<input checked="" type="checkbox"/> For the 5.15-5.25 GHz band:	
	<ul style="list-style-type: none"> ▪ Outdoor AP: the peak power spectral density (PPSD) shall not exceed the lesser of 17dBm/MHz. If $G_{TX} > 6$ dBi, then $P_{Out} = 17 - (G_{TX} - 6)$. ▪ Indoor AP: the peak power spectral density (PPSD) shall not exceed the lesser of 17dBm/MHz. If $G_{TX} > 6$ dBi, then $P_{Out} = 17 - (G_{TX} - 6)$. ▪ Point-to-point AP: the peak power spectral density (PPSD) shall not exceed the lesser of 17dBm/MHz. If $G_{TX} > 23$ dBi, then $P_{Out} = 17 - (G_{TX} - 23)$. ▪ Mobile or Portable Client: the peak power spectral density (PPSD) ≤ 11 dBm/MHz. If $G_{TX} > 6$ dBi, then $PPSD = 11 - (G_{TX} - 6)$.
<input type="checkbox"/> For the 5.25-5.35 GHz band, the peak power spectral density (PPSD) ≤ 11 dBm/MHz. If $G_{TX} > 6$ dBi, then $PPSD = 11 - (G_{TX} - 6)$.	
<input type="checkbox"/> For the 5.47-5.725 GHz band, the peak power spectral density (PPSD) ≤ 11 dBm/MHz. If $G_{TX} > 6$ dBi, then $PPSD = 11 - (G_{TX} - 6)$.	
<input checked="" type="checkbox"/> For the 5.725-5.85 GHz band:	
	<ul style="list-style-type: none"> ▪ Point-to-multipoint systems (P2M): the peak power spectral density (PPSD) ≤ 30 dBm/500kHz. If $G_{TX} > 6$ dBi, then $PPSD = 30 - (G_{TX} - 6)$. ▪ Point-to-point systems (P2P): the peak power spectral density (PPSD) ≤ 30 dBm/500kHz.
LE-LAN Devices	
<input type="checkbox"/> For the 5.15-5.25 GHz band, the e.i.r.p. peak power spectral density (PPSD) ≤ 10 dBm/MHz.	
<input type="checkbox"/> For the 5.25-5.35 GHz band, the peak power spectral density (PPSD) ≤ 11 dBm/MHz.	
	<ul style="list-style-type: none"> ▪ e.i.r.p. greater than 200 mW shall comply with the following e.i.r.p. at different elevations, where θ is the angle above the local horizontal plane (of the Earth) as shown below: -13 dBW/MHz for $0^\circ \leq \theta < 8^\circ$; -13 - 0.716 (θ-8) dBW/MHz for $8^\circ \leq \theta < 40^\circ$ -35.9 - 1.22 (θ-40) dBW/MHz for $40^\circ \leq \theta \leq 45^\circ$; -42 dBW/MHz for $\theta > 45^\circ$
<input type="checkbox"/> For the 5.47-5.6 GHz band and 5.65-5.725 GHz band, the peak power spectral density (PPSD) ≤ 11 dBm/MHz.	
<input type="checkbox"/> For the 5.725-5.85 GHz band:	
	<ul style="list-style-type: none"> ▪ Point-to-multipoint systems (P2M): the peak power spectral density (PPSD) ≤ 30 dBm/500kHz. If $G_{TX} > 6$ dBi, then $PPSD = 30 - (G_{TX} - 6)$. ▪ Point-to-point systems (P2P): the peak power spectral density (PPSD) ≤ 30 dBm/500kHz.
<p>PPSD = peak power spectral density that he same method as used to determine the conducted output power shall be used to determine the power spectral density. And power spectral density in dBm/MHz G_{TX} = the maximum transmitting antenna directional gain in dBi.</p>	



3.4.2 Measuring Instruments

Refer a test equipment and calibration data table in this test report.

3.4.3 Test Procedures

Test Method	
<ul style="list-style-type: none"> ▪ Peak power spectral density procedures that the same method as used to determine the conducted output power shall be used to determine the peak power spectral density and use the peak search function on the spectrum analyzer to find the peak of the spectrum. For the peak power spectral density shall be measured using below options: 	
	<input type="checkbox"/> Refer as FCC KDB 789033, F)5) power spectral density can be measured using resolution bandwidths < 1 MHz provided that the results are integrated over 1 MHz bandwidth [duty cycle ≥ 98% or external video / power trigger]
	<input checked="" type="checkbox"/> Refer as FCC KDB 789033, clause E Method SA-1 (spectral trace averaging).
	<input type="checkbox"/> Refer as FCC KDB 789033, clause E Method SA-1 Alt. (RMS detection with slow sweep speed) duty cycle < 98% and average over on/off periods with duty factor
	<input checked="" type="checkbox"/> Refer as FCC KDB 789033, clause E Method SA-2 (spectral trace averaging).
	<input type="checkbox"/> Refer as FCC KDB 789033, clause E Method SA-2 Alt. (RMS detection with slow sweep speed)
<ul style="list-style-type: none"> ▪ For conducted measurement. 	
	<ul style="list-style-type: none"> ▪ If the EUT supports multiple transmit chains using options given below:
	<input checked="" type="checkbox"/> Option 1: Measure and sum the spectra across the outputs. Refer as FCC KDB 662911, In-band power spectral density (PSD). Sample all transmit ports simultaneously using a spectrum analyzer for each transmit port. Where the trace bin-by-bin of each transmit port summing can be performed. (i.e., in the first spectral bin of output 1 is summed with that in the first spectral bin of output 2 and that from the first spectral bin of output 3, and so on up to the NTX output to obtain the value for the first frequency bin of the summed spectrum.). Add up the amplitude (power) values for the different transmit chains and use this as the new data trace.
	<input type="checkbox"/> Option 2: Measure and sum spectral maxima across the outputs. With this technique, spectra are measured at each output of the device at the required resolution bandwidth. The maximum value (peak) of each spectrum is determined. These maximum values are then summed mathematically in linear power units across the outputs. These operations shall be performed separately over frequency spans that have different out-of-band or spurious emission limits,
	<input type="checkbox"/> Option 3: Measure and add 10 log(N) dB, where N is the number of transmit chains. Refer as FCC KDB 662911, In-band power spectral density (PSD). Performed at each transmit chains and each transmit chains shall be compared with the limit have been reduced with 10 log(N). Or each transmit chains shall be add 10 log(N) to compared with the limit.
	<ul style="list-style-type: none"> ▪ If multiple transmit chains, EIRP PPSD calculation could be following as methods: $PPSD_{total} = PPSD_1 + PPSD_2 + \dots + PPSD_n$ (calculated in linear unit [mW] and transfer to log unit [dBm]) $EIRP_{total} = PPSD_{total} + DG$

3.4.4 Test Setup

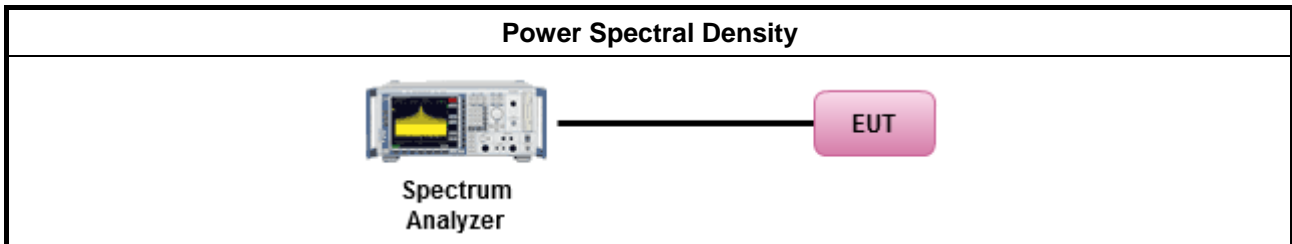

3.4.5 Test Result of Peak Power Spectral Density

Refer as Appendix D



3.5 Unwanted Emissions

3.5.1 Transmitter Unwanted Emissions Limit

Unwanted emissions below 1 GHz and restricted band emissions above 1GHz limit			
Frequency Range (MHz)	Field Strength (uV/m)	Field Strength (dBuV/m)	Measure Distance (m)
0.009~0.490	2400/F(kHz)	48.5 - 13.8	300
0.490~1.705	24000/F(kHz)	33.8 - 23	30
1.705~30.0	30	29	30
30~88	100	40	3
88~216	150	43.5	3
216~960	200	46	3
Above 960	500	54	3

Note 1: Test distance for frequencies at or above 30 MHz, measurements may be performed at a distance other than the limit distance provided they are not performed in the near field and the emissions to be measured can be detected by the measurement equipment. When performing measurements at a distance other than that specified, the results shall be extrapolated to the specified distance using an extrapolation factor of 20 dB/decade (inverse of linear distance for field-strength measurements, inverse of linear distance-squared for power-density measurements).

Note 2: Test distance for frequencies at below 30 MHz, measurements may be performed at a distance closer than the EUT limit distance; however, an attempt should be made to avoid making measurements in the near field. When performing measurements below 30 MHz at a closer distance than the limit distance, the results shall be extrapolated to the specified distance by either making measurements at a minimum of two or more distances on at least one radial to determine the proper extrapolation factor or by using the square of an inverse linear distance extrapolation factor (40 dB/decade). The test report shall specify the extrapolation method used to determine compliance of the EUT.

Note 3: Using the distance of 1m during the test for above 18 GHz, and the test value to correct for the distance factor at 3m.

Un-restricted band emissions above 1GHz Limit	
Operating Band	Limit
<input checked="" type="checkbox"/> 5.15 - 5.25 GHz	e.i.r.p. -27 dBm [68.2 dBuV/m@3m]
<input type="checkbox"/> 5.25 - 5.35 GHz	e.i.r.p. -27 dBm [68.2 dBuV/m@3m]
<input type="checkbox"/> 5.47 - 5.725 GHz	e.i.r.p. -27 dBm [68.2 dBuV/m@3m]
<input checked="" type="checkbox"/> 5.725 - 5.85 GHz	all emissions shall be limited to a level of -27 dBm/MHz at 75 MHz or more above or below the band edge increasing linearly to 10 dBm/MHz at 25 MHz above or below the band edge, and from 25 MHz above or below the band edge increasing linearly to a level of 15.6 dBm/MHz at 5 MHz above or below the band edge, and from 5 MHz above or below the band edge increasing linearly to a level of 27 dBm/MHz at the band edge.

Note 1: Measurements may be performed at a distance other than the limit distance provided they are not performed in the near field and the emissions to be measured can be detected by the measurement equipment. When performing measurements at a distance other than that specified, the results shall be extrapolated to the specified distance using an extrapolation factor of 20 dB/decade (inverse of



linear distance for field-strength measurements, inverse of linear distance-squared for power-density measurements).

3.5.2 Measuring Instruments

Refer a test equipment and calibration data table in this test report.

3.5.3 Test Procedures

Test Method	
	<ul style="list-style-type: none"> ▪ Measurements may be performed at a distance other than the limit distance provided they are not performed in the near field and the emissions to be measured can be detected by the measurement equipment. Measurements shall not be performed at a distance greater than 30 m for frequencies above 30 MHz, unless it can be further demonstrated that measurements at a distance of 30 m or less are impractical. When performing measurements at a distance other than that specified, the results shall be extrapolated to the specified distance using an extrapolation factor of 20 dB/decade (inverse of linear distance for field-strength measurements, inverse of linear distance-squared for power-density measurements).
	<ul style="list-style-type: none"> ▪ The average emission levels shall be measured in [duty cycle ≥ 98 or duty factor].
	<ul style="list-style-type: none"> ▪ For the transmitter unwanted emissions shall be measured using following options below: <ul style="list-style-type: none"> ▪ Refer as FCC KDB 789033, clause G)2) for unwanted emissions into non-restricted bands. ▪ Refer as FCC KDB 789033, clause G)1) for unwanted emissions into restricted bands.
	<ul style="list-style-type: none"> <input type="checkbox"/> Refer as FCC KDB 789033, G)6) Method AD (Trace Averaging). <input checked="" type="checkbox"/> Refer as FCC KDB 789033, G)6) Method VB (Reduced VBW). <input type="checkbox"/> Refer as ANSI C63.10, clause 11.12.2.5.3 (Reduced VBW). VBW ≥ 1/T, where T is pulse time. <input type="checkbox"/> Refer as ANSI C63.10, clause 7.5 average value of pulsed emissions. <input checked="" type="checkbox"/> Refer as FCC KDB 789033, clause G)5) measurement procedure peak limit. <input type="checkbox"/> Refer as ANSI C63.10, clause 4.1.4.2.2 measurement procedure peak limit.
	<ul style="list-style-type: none"> ▪ For radiated measurement. <ul style="list-style-type: none"> ▪ Refer as ANSI C63.10, clause 6.4 for radiated emissions below 30 MHz and test distance is 3m. ▪ Refer as ANSI C63.10, clause 6.5 for radiated emissions 30 MHz to 1 GHz and test distance is 3m. ▪ Refer as ANSI C63.10, clause 6.6 for radiated emissions above 1GHz.
	<ul style="list-style-type: none"> ▪ The any unwanted emissions level shall not exceed the fundamental emission level.
	<ul style="list-style-type: none"> ▪ All amplitude of spurious emissions that are attenuated by more than 20 dB below the permissible value has no need to be reported.

3.5.4 Test Setup

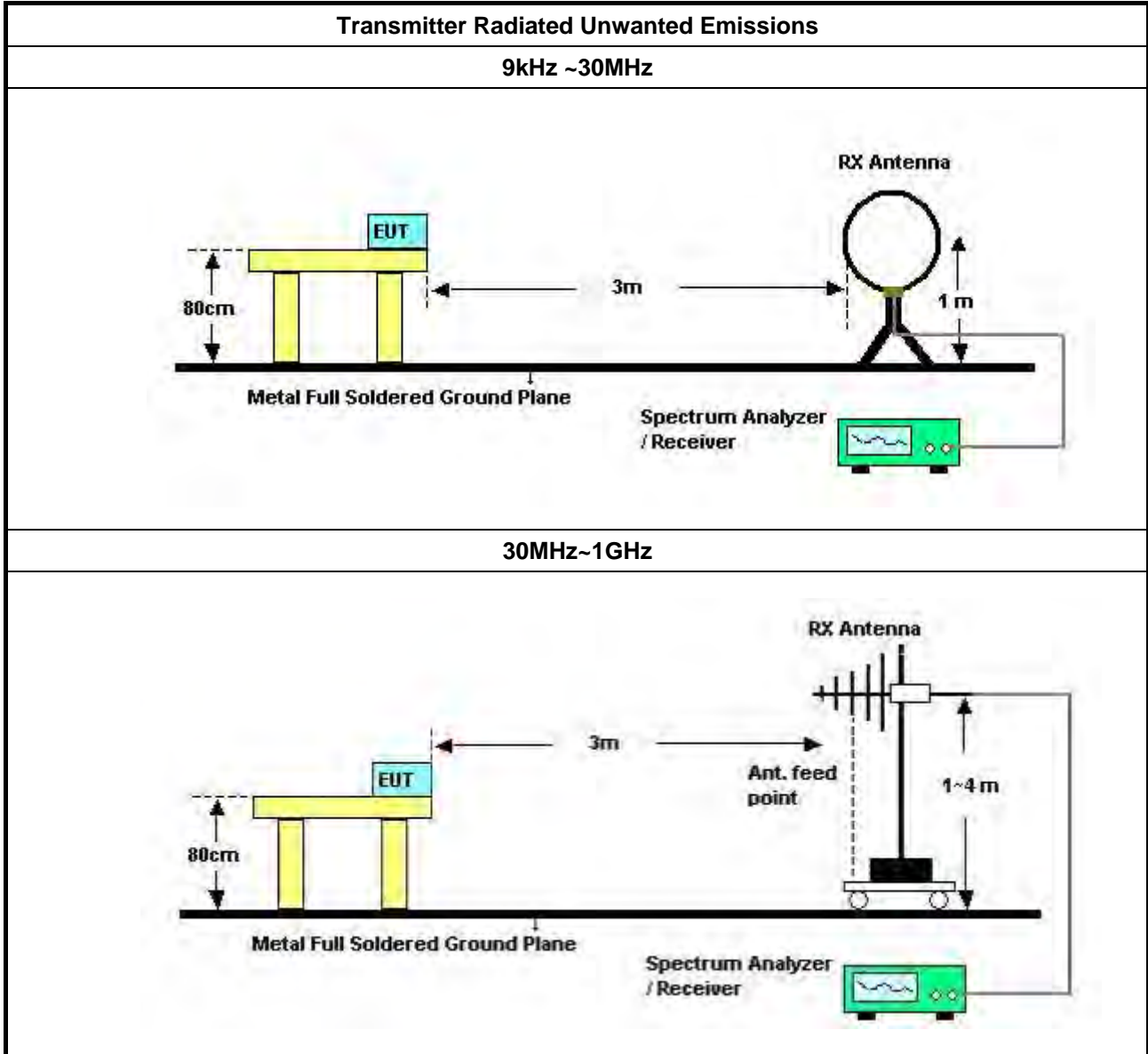

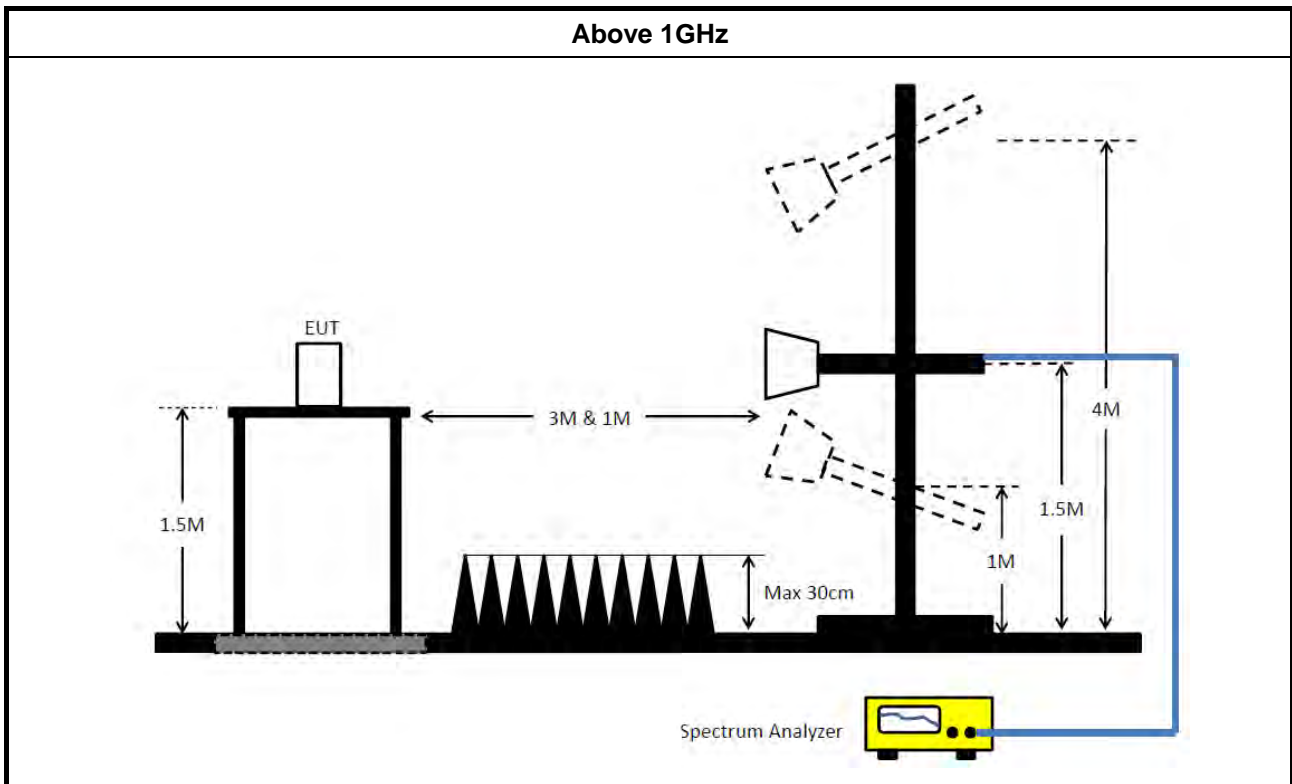

3.5.5 Measurement Results Calculation

The measured Level is calculated using:

Corrected Reading: Antenna factor (AF) + Cable loss (CL) + Read level (Raw) - Preamp factor (PA)(if applicable) = Level.

3.5.6 Transmitter Unwanted Emissions (Below 30MHz)

All amplitude of spurious emissions that are attenuated by more than 20 dB below the permissible value has no need to be reported.

The radiated emissions were investigated from 9 kHz or the lowest frequency generated within the device, up to the 10 harmonic or 40 GHz, whichever is appropriate.

3.5.7 Test Result of Transmitter Unwanted Emissions

Refer as Appendix E



4 Test Equipment and Calibration Data

Instrument	Manufacturer	Model No.	Serial No.	Characteristics	Calibration Date	Calibration Due Date	Remark
EMI Receiver	Agilent	N9038A	My52260123	9kHz ~ 8.4GHz	Feb. 20, 2023	Feb. 19, 2024	Conduction (CO01-CB)
LISN	F.C.C.	FCC-LISN-50-16-2	04083	150kHz ~ 100MHz	Feb. 16, 2023	Feb. 15, 2024	Conduction (CO01-CB)
LISN	Schwarzbeck	NSLK 8127	8127647	9kHz ~ 30MHz	Apr. 27, 2023	Apr. 26, 2024	Conduction (CO01-CB)
Pulse Limiter	Rohde&Schwarz	ESH3-Z2	100430	9kHz ~ 30MHz	Feb. 09, 2023	Feb. 08, 2024	Conduction (CO01-CB)
COND Cable	Woken	Cable	Low cable-CO01	9kHz ~ 30MHz	Oct. 18, 2022	Oct. 17, 2023	Conduction (CO01-CB)
Software	SPORTON	SENSE	V5.10	-	N.C.R.	N.C.R.	Conduction (CO01-CB)
Loop Antenna	Teseq	HLA 6120	31244	9kHz - 30 MHz	Mar. 23, 2023	Mar. 22, 2024	Radiation (03CH04-CB)
3m Semi Anechoic Chamber NSA	TDK	SAC-3M	03CH04-CB	30 MHz ~ 1 GHz	Aug. 01, 2023	Jul. 31, 2024	Radiation (03CH04-CB)
BILOG ANTENNA with 6 dB attenuator	Schaffner & EMC1	CBL6112B & N-6-06	22021&AT-N0 607	30MHz ~ 1GHz	Oct. 08, 2022	Oct. 07, 2023	Radiation (03CH04-CB)
Pre-Amplifier	EMCI	EMC330N	980391	20MHz ~ 3GHz	May 23, 2023	May 22, 2024	Radiation (03CH04-CB)
Spectrum Analyzer	R&S	FSP40	100142	9kHz~40GHz	Mar. 21, 2023	Mar. 20, 2024	Radiation (03CH04-CB)
EMI Test Receiver	R&S	ESCS	826547/017	9kHz ~ 2.75GHz	Jun. 13, 2023	Jun. 12, 2024	Radiation (03CH04-CB)
RF Cable-low	Woken	RG402	Low Cable-03+67	30MHz - 1GHz	Oct. 03, 2022	Oct. 02, 2023	Radiation (03CH04-CB)
Test Software	SPORTON	SENSE	V5.10	-	N.C.R.	N.C.R.	Radiation (03CH04-CB)
Horn Antenna	EMCO	3115	9610-4976	1GHz ~ 18GHz	Apr. 25, 2018	Apr. 24, 2019	Radiation (03CH01-CB)
Horn Antenna	Schwarzbeck	BBHA 9170	BBHA9170252	15GHz ~ 40GHz	Jun. 28, 2018	Jun. 27, 2019	Radiation (03CH01-CB)
Pre-Amplifier	Agilent	8449B	3008A02310	1GHz ~ 26.5GHz	Jan. 09, 2018	Jan. 08, 2019	Radiation (03CH01-CB)
Pre-Amplifier	MITEQ	TTA1840-35-HG	1864479	18GHz ~ 40GHz	Jul. 04, 2018	Jul. 03, 2019	Radiation (03CH01-CB)
Spectrum analyzer	R&S	FSP40	100080	9kHz~40GHz	Oct. 03, 2018	Oct. 02, 2019	Radiation (03CH01-CB)
RF Cable-high	Woken	High Cable-16	N/A	1 GHz ~ 18 GHz	Oct. 08, 2018	Oct. 07, 2019	Radiation (03CH01-CB)
RF Cable-high	Woken	High Cable-16+17	N/A	1 GHz ~ 18 GHz	Oct. 08, 2018	Oct. 07, 2019	Radiation (03CH01-CB)
RF Cable-high	Woken	High Cable-40G#1	N/A	18GHz ~ 40 GHz	Jul. 27, 2018	Jul. 26, 2019	Radiation (03CH01-CB)



Instrument	Manufacturer	Model No.	Serial No.	Characteristics	Calibration Date	Calibration Due Date	Remark
RF Cable-high	Woken	High Cable-40G#2	N/A	18GHz ~ 40 GHz	Jul. 27, 2018	Jul. 26, 2019	Radiation (03CH01-CB)
Test Software	Audix	E3	6.2009-10-7	-	N.C.R.	N.C.R.	Radiation (03CH01-CB)
Test Software	SPORTON	SENSE	V5.10	-	N.C.R.	N.C.R.	Radiation (03CH01-CB)
Spectrum analyzer	R&S	FSV40	100979	9kHz~40GHz	Dec. 21, 2017	Dec. 20, 2018	Conducted (TH01-CB)
RF Cable-high	Woken	RG402	High Cable-06	1 GHz ~26.5 GHz	Oct. 08, 2018	Oct. 07, 2019	Conducted (TH01-CB)
RF Cable-high	Woken	RG402	High Cable-07	1 GHz ~26.5 GHz	Oct. 08, 2018	Oct. 07, 2019	Conducted (TH01-CB)
RF Cable-high	Woken	RG402	High Cable-08	1 GHz ~26.5 GHz	Oct. 08, 2018	Oct. 07, 2019	Conducted (TH01-CB)
RF Cable-high	Woken	RG402	High Cable-09	1 GHz ~26.5 GHz	Oct. 08, 2018	Oct. 07, 2019	Conducted (TH01-CB)
RF Cable-high	Woken	RG402	High Cable-10	1 GHz ~26.5 GHz	Oct. 08, 2018	Oct. 07, 2019	Conducted (TH01-CB)
RF Cable-high	Woken	RG402	High Cable-28	1 GHz ~26.5 GHz	Nov. 19, 2018	Nov. 18, 2019	Conducted (TH01-CB)
Test Software	SPORTON	SENSE	V5.10	-	N.C.R.	N.C.R.	Conducted (TH01-CB)

Note: Calibration Interval of instruments listed above is one year.

N.C.R means Non-Calibration required.



Summary

Mode	Result	Type	Freq (Hz)	Level (dBuV)	Limit (dBuV)	Margin (dB)	Condition
Mode 1	Pass	AV	352.5k	45.68	48.91	-3.23	Line

Mode 1

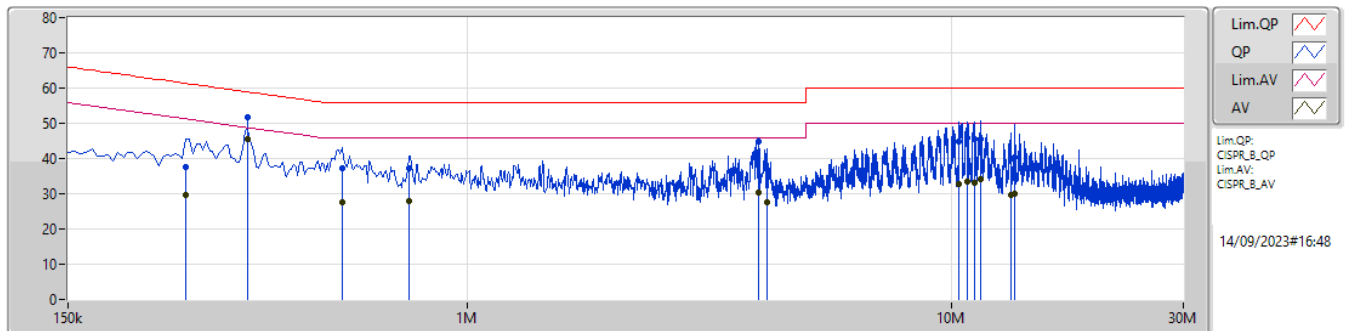

Type	Freq (Hz)	Level (dBuV)	Limit (dBuV)	Margin (dB)	Factor (dB)	Condition	Comment	Raw (dBuV)	LISN (dB)	CL (dB)	AT (dB)
QP	262.5k	37.66	61.35	-23.69	10.01	Line	-	27.65	0.08	0.05	9.88
AV	262.5k	29.57	51.35	-21.78	10.01	Line	-	19.56	0.08	0.05	9.88
QP	352.5k	51.60	58.91	-7.31	10.04	Line	-	41.56	0.09	0.06	9.89
AV	352.5k	45.68	48.91	-3.23	10.04	Line	"Worst"	35.64	0.09	0.06	9.89
QP	550.5k	37.07	56.00	-18.93	10.05	Line	-	27.02	0.10	0.05	9.90
AV	550.5k	27.74	46.00	-18.26	10.05	Line	-	17.69	0.10	0.05	9.90
QP	757.5k	37.35	56.00	-18.65	10.05	Line	-	27.30	0.10	0.05	9.90
AV	757.5k	28.03	46.00	-17.97	10.05	Line	-	17.98	0.10	0.05	9.90
QP	3.993M	44.70	56.00	-11.30	10.18	Line	-	34.52	0.17	0.10	9.91
AV	3.993M	30.46	46.00	-15.54	10.18	Line	-	20.28	0.17	0.10	9.91
QP	4.16M	36.96	56.00	-19.04	10.18	Line	-	26.78	0.17	0.10	9.91
AV	4.16M	27.47	46.00	-18.53	10.18	Line	-	17.29	0.17	0.10	9.91
QP	10.307M	44.80	60.00	-15.20	10.35	Line	-	34.45	0.25	0.16	9.94
AV	10.307M	32.59	50.00	-17.41	10.35	Line	-	22.24	0.25	0.16	9.94
QP	10.752M	45.97	60.00	-14.03	10.37	Line	-	35.60	0.26	0.16	9.95
AV	10.752M	33.32	50.00	-16.68	10.37	Line	-	22.95	0.26	0.16	9.95
QP	11.121M	45.41	60.00	-14.59	10.37	Line	-	35.04	0.26	0.16	9.95
AV	11.121M	33.22	50.00	-16.78	10.37	Line	-	22.85	0.26	0.16	9.95
QP	11.463M	45.66	60.00	-14.34	10.37	Line	-	35.29	0.26	0.16	9.95
AV	11.463M	34.10	50.00	-15.90	10.37	Line	-	23.73	0.26	0.16	9.95
QP	13.218M	39.94	60.00	-20.06	10.41	Line	-	29.53	0.27	0.17	9.97
AV	13.218M	29.53	50.00	-20.47	10.41	Line	-	19.12	0.27	0.17	9.97
QP	13.497M	40.36	60.00	-19.64	10.41	Line	-	29.95	0.27	0.17	9.97
AV	13.497M	29.99	50.00	-20.01	10.41	Line	-	19.58	0.27	0.17	9.97

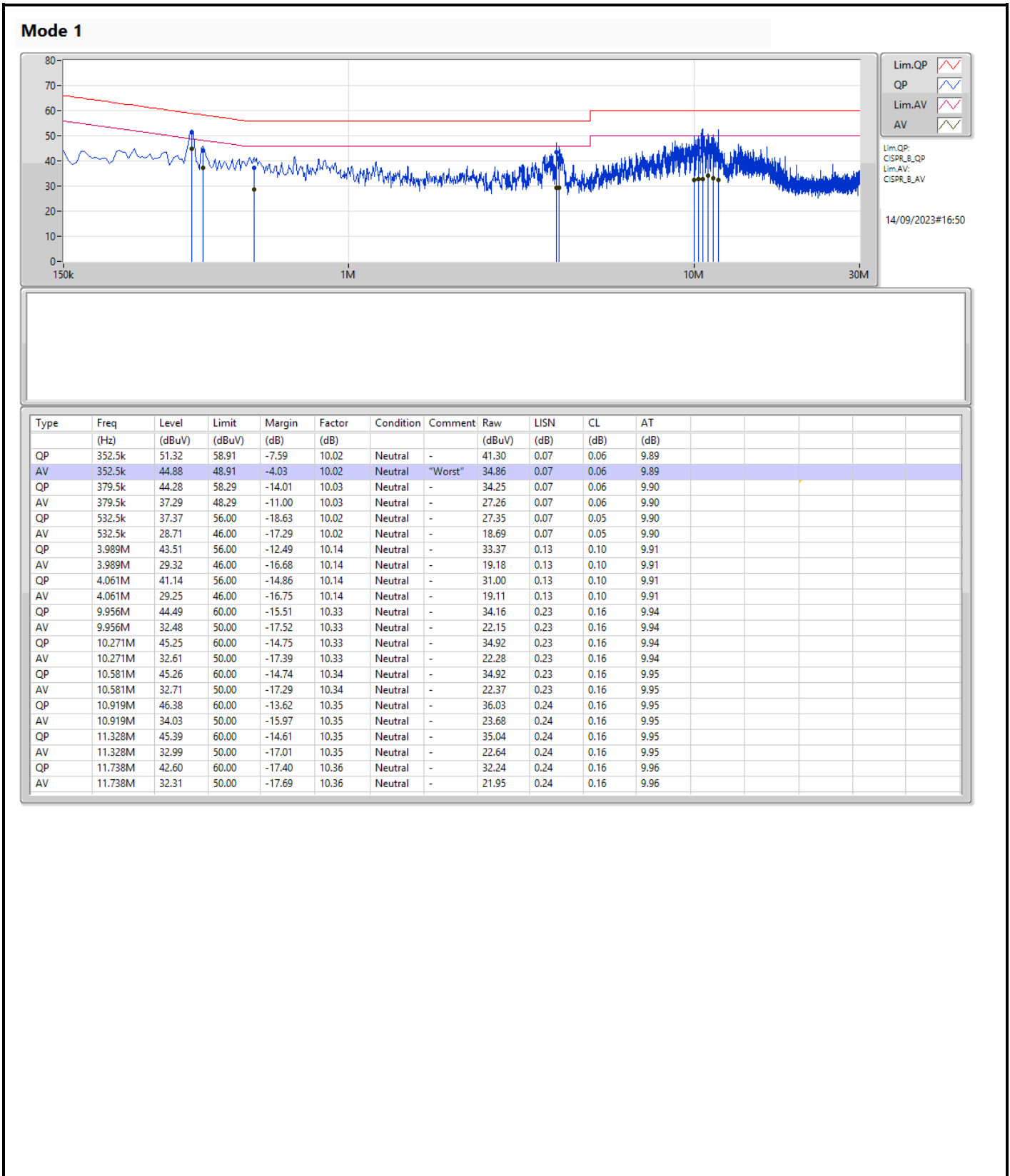



Summary

Mode	Max-N dB (Hz)	Max-OBW (Hz)	ITU-Code	Min-N dB (Hz)	Min-OBW (Hz)
5.15-5.25GHz	-	-	-	-	-
802.11a-BF_Nss1,(6Mbps)_2TX	36.45M	16.792M	16M8D1D	24.05M	16.517M
802.11ac VHT20-BF_Nss1,(MCS0)_2TX	43.6M	21.489M	21M5D1D	29.975M	16.592M
802.11ac VHT40-BF_Nss1,(MCS0)_2TX	47.5M	36.182M	36M2D1D	40.2M	35.932M
802.11ac VHT80-BF_Nss1,(MCS0)_2TX	79.5M	74.863M	74M9D1D	79.3M	74.663M
5.725-5.85GHz	-	-	-	-	-
802.11a-BF_Nss1,(6Mbps)_2TX	16.3M	27.736M	27M7D1D	15.125M	16.567M
802.11ac VHT20-BF_Nss1,(MCS0)_2TX	17.625M	18.341M	18M3D1D	16.075M	17.466M
802.11ac VHT40-BF_Nss1,(MCS0)_2TX	35.7M	36.732M	36M7D1D	31.2M	36.432M
802.11ac VHT80-BF_Nss1,(MCS0)_2TX	72.2M	75.562M	75M6D1D	70M	75.162M

Max-N dB = Maximum 6dB down bandwidth for 5.725-5.85GHz band / Maximum 26dB down bandwidth for other band;

Max-OBW = Maximum 99% occupied bandwidth;

Min-N dB = Minimum 6dB down bandwidth for 5.725-5.85GHz band / Maximum 26dB down bandwidth for other band;

Min-OBW = Minimum 99% occupied bandwidth;

Result

Mode	Result	Limit (Hz)	Port 1-N dB (Hz)	Port 1-OBW (Hz)	Port 2-N dB (Hz)	Port 2-OBW (Hz)
802.11a-BF_Nss1,(6Mbps)_2TX	-	-	-	-	-	-
5180MHz	Pass	Inf	29.225M	16.592M	24.05M	16.517M
5200MHz	Pass	Inf	36.45M	16.792M	30.55M	16.767M
5240MHz	Pass	Inf	36.3M	16.692M	34.875M	16.542M
5745MHz	Pass	500k	16.275M	22.639M	15.75M	27.736M
5785MHz	Pass	500k	15.125M	22.089M	16.125M	23.813M
5825MHz	Pass	500k	16.025M	16.567M	16.3M	16.667M
802.11ac VHT20-BF_Nss1,(MCS0)_2TX	-	-	-	-	-	-
5180MHz	Pass	Inf	29.975M	16.592M	31.275M	16.642M
5200MHz	Pass	Inf	43.6M	20.065M	42.65M	21.489M
5240MHz	Pass	Inf	38.575M	18.291M	39.925M	19.99M
5745MHz	Pass	500k	16.325M	17.591M	16.575M	17.591M
5785MHz	Pass	500k	17.625M	18.341M	17.5M	17.791M
5825MHz	Pass	500k	16.075M	17.541M	16.375M	17.466M
802.11ac VHT40-BF_Nss1,(MCS0)_2TX	-	-	-	-	-	-
5190MHz	Pass	Inf	40.2M	36.082M	40.45M	35.932M
5230MHz	Pass	Inf	44.4M	36.082M	47.5M	36.182M
5755MHz	Pass	500k	35.7M	36.532M	32.55M	36.632M
5795MHz	Pass	500k	34.95M	36.432M	31.2M	36.732M
802.11ac VHT80-BF_Nss1,(MCS0)_2TX	-	-	-	-	-	-
5210MHz	Pass	Inf	79.3M	74.663M	79.5M	74.863M
5775MHz	Pass	500k	72.2M	75.162M	70M	75.562M

Port X-N dB = Port X 6dB down bandwidth for 5.725-5.85GHz band / 26dB down bandwidth for other band

Port X-OBW = Port X 99% occupied bandwidth;

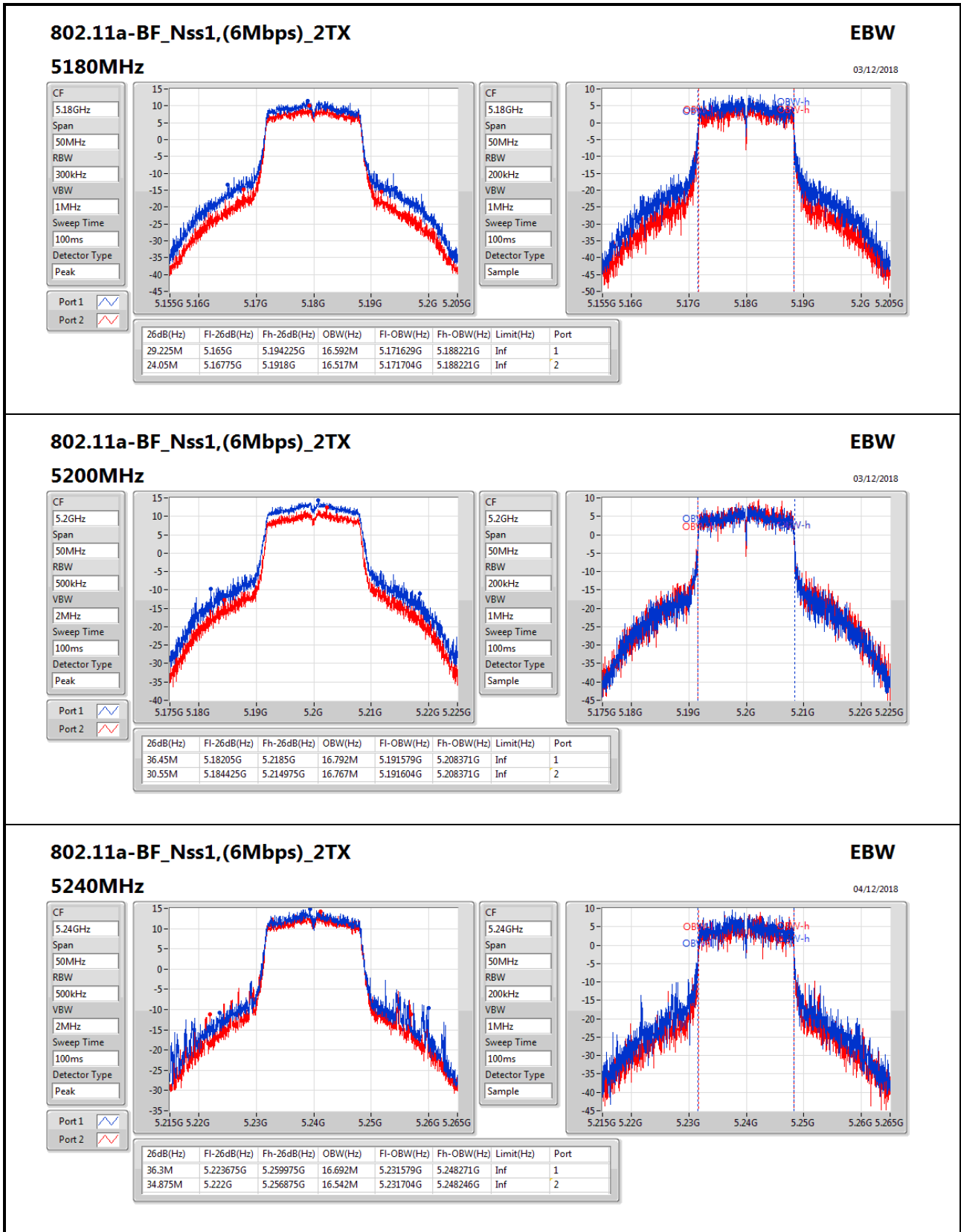

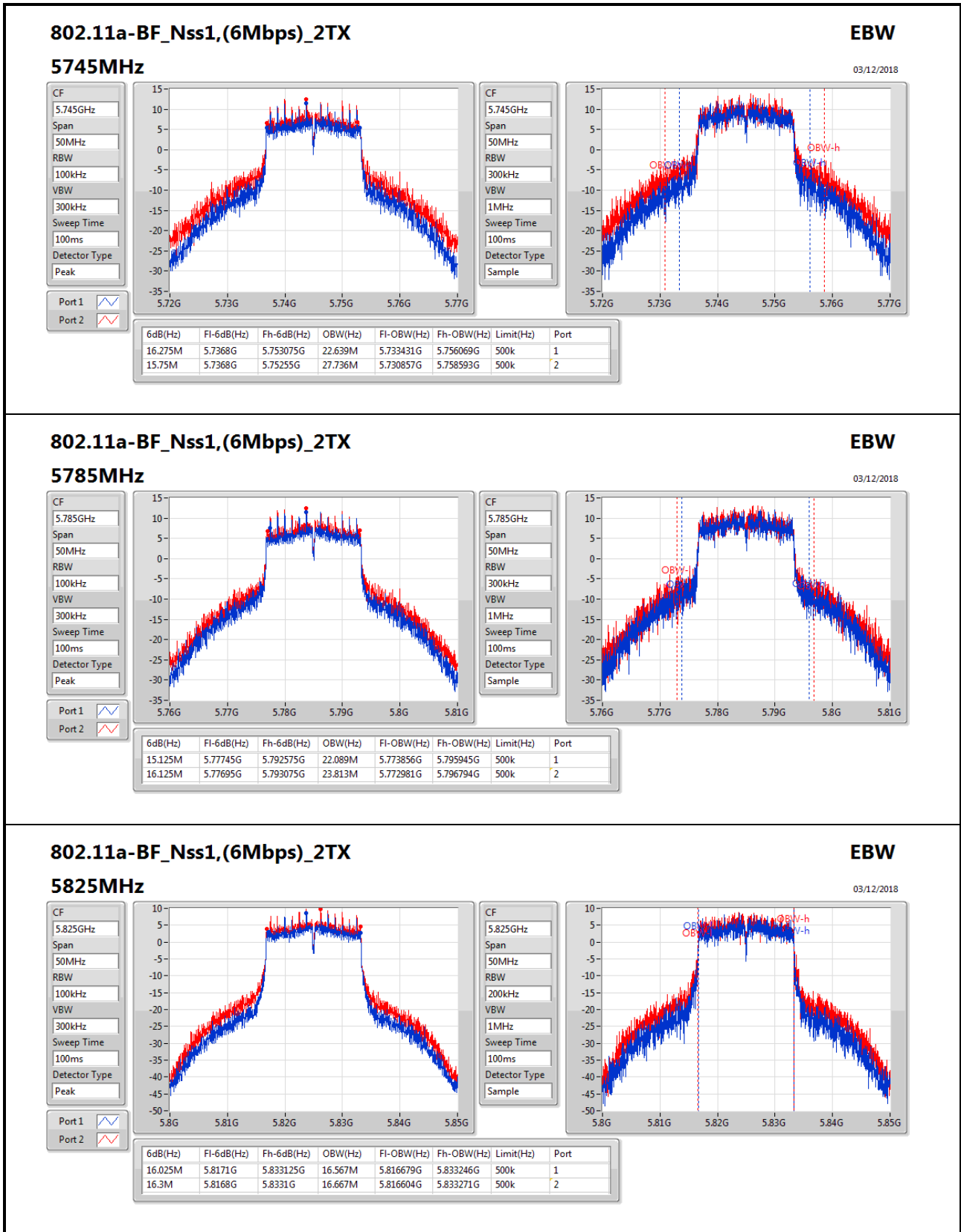

802.11ac VHT20-BF_Nss1,(MCS0)_2TX

EBW

5180MHz

03/12/2018

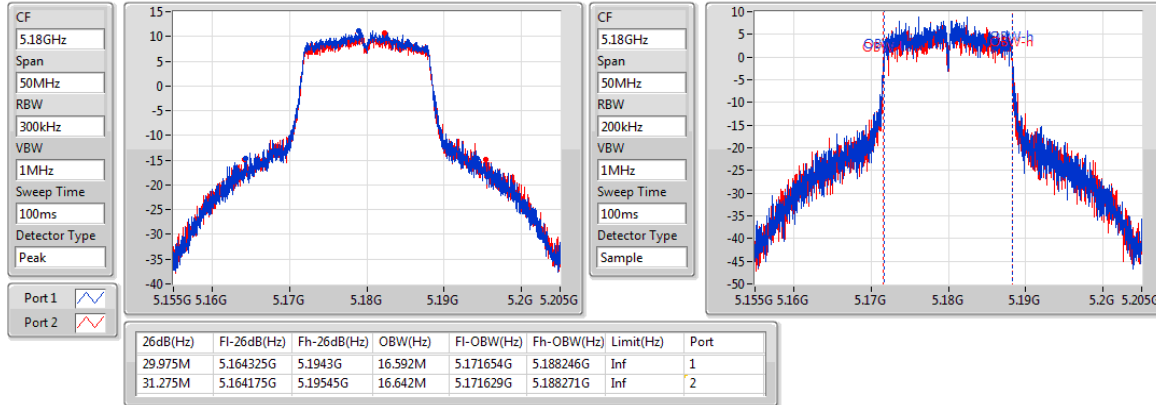

802.11ac VHT20-BF_Nss1,(MCS0)_2TX

EBW

5200MHz

03/12/2018

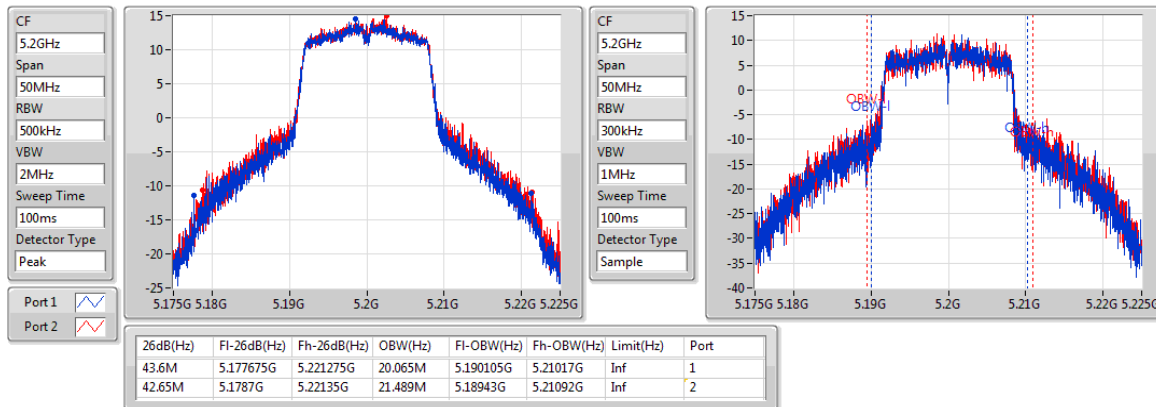

802.11ac VHT20-BF_Nss1,(MCS0)_2TX

EBW

5240MHz

03/12/2018

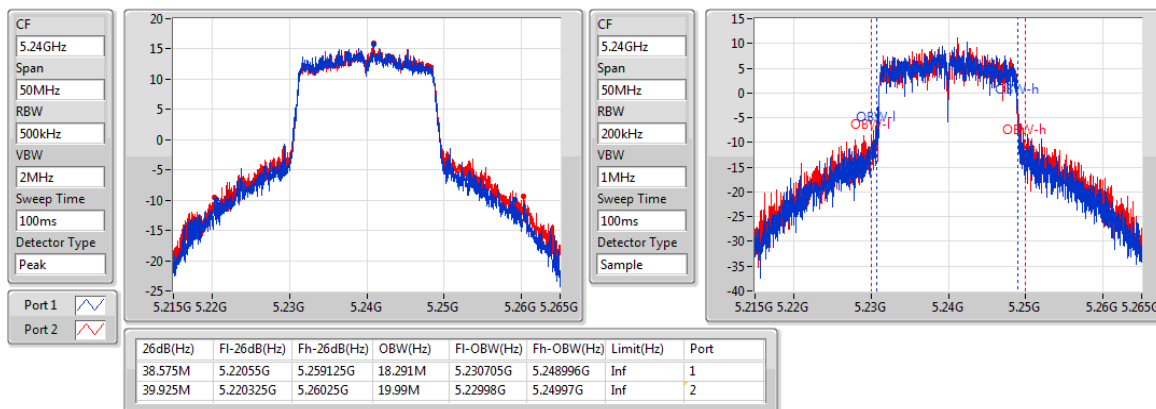

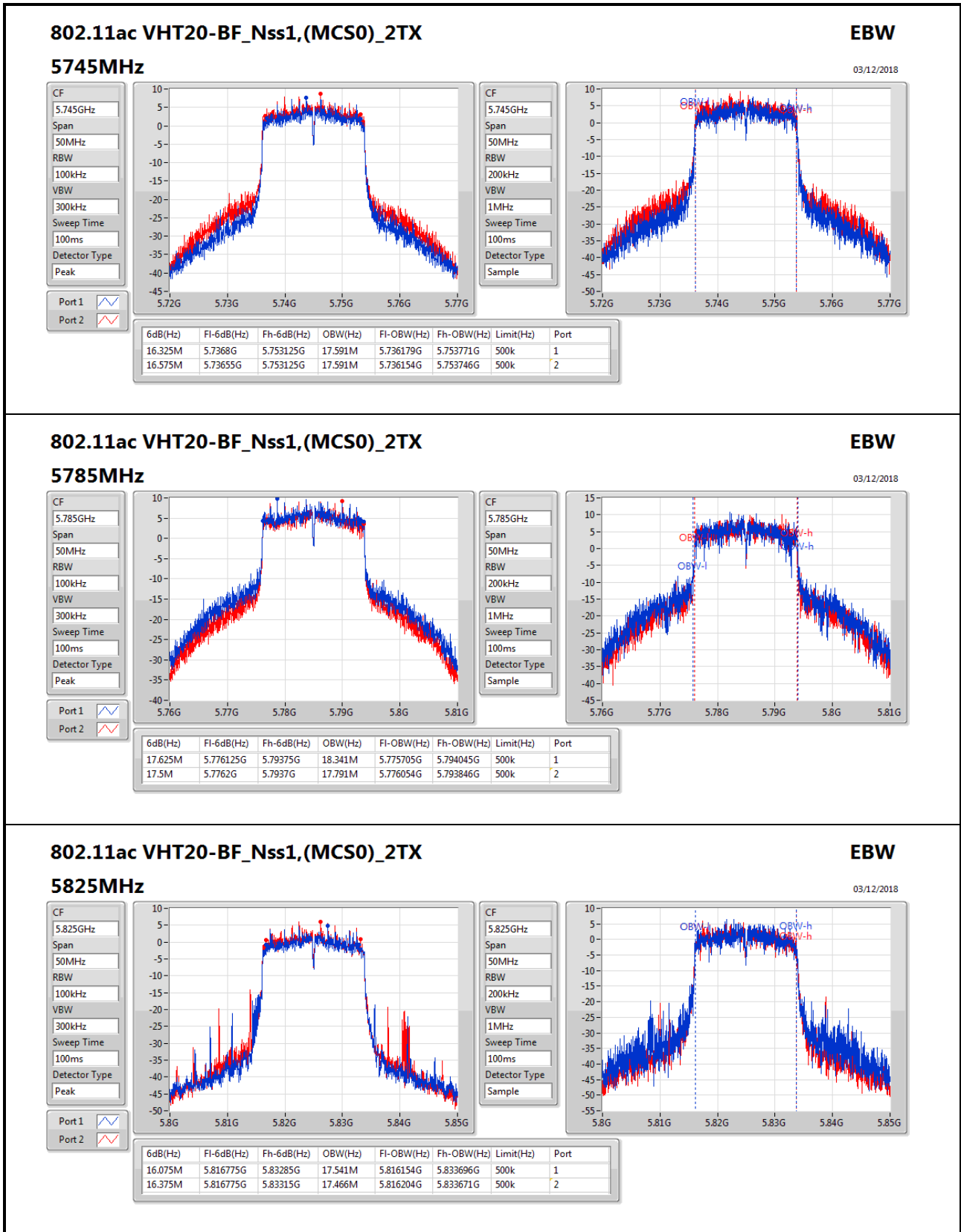
802.11ac VHT20-BF_Nss1,(MCS0)_2TX
EBW

03/12/2018

5825MHz

CF: 5.825GHz
Span: 50MHz
RBW: 100kHz
VBW: 300kHz
Sweep Time: 100ms
Detector Type: Peak

Port 1:

Port 2:

CF: 5.825GHz
Span: 50MHz
RBW: 200kHz
VBW: 1MHz
Sweep Time: 100ms
Detector Type: Sample

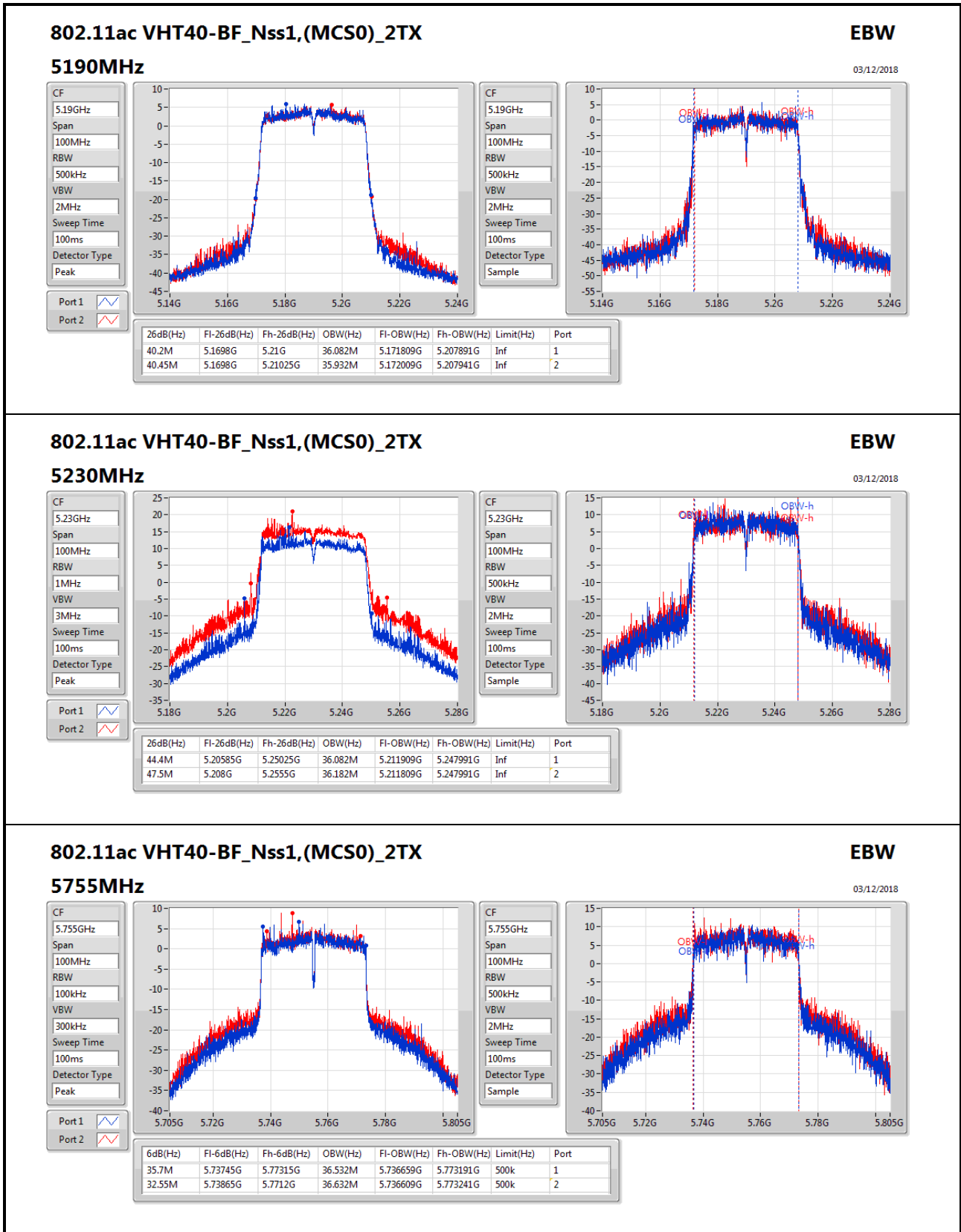

802.11ac VHT40-BF_Nss1,(MCS0)_2TX

EBW

5795MHz

03/12/2018

CF
5.795GHz
Span
100MHz
RBW
100kHz
VBW
300kHz
Sweep Time
100ms
Detector Type
Peak

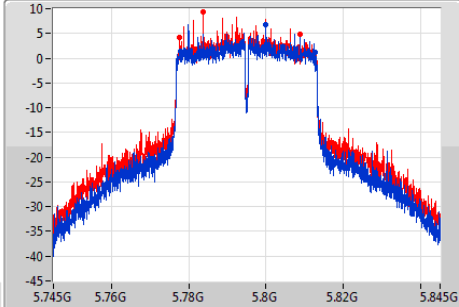

CF
5.795GHz
Span
100MHz
RBW
500kHz
VBW
2MHz
Sweep Time
100ms
Detector Type
Sample

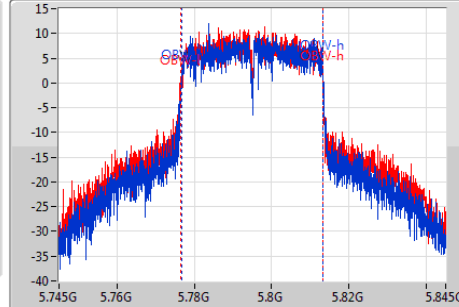

6dB(Hz)	Fl-6dB(Hz)	Fh-6dB(Hz)	OBW(Hz)	Fl-OBW(Hz)	Fh-OBW(Hz)	Limit(Hz)	Port
34.95M	5.77775G	5.8127G	36.432M	5.776709G	5.813141G	500k	1
31.2M	5.77755G	5.80875G	36.732M	5.776509G	5.813241G	500k	2

802.11ac VHT80-BF_Nss1,(MCS0)_2TX

EBW

5210MHz

03/12/2018

CF
5.21GHz
Span
200MHz
RBW
1MHz
VBW
3MHz
Sweep Time
100ms
Detector Type
Peak

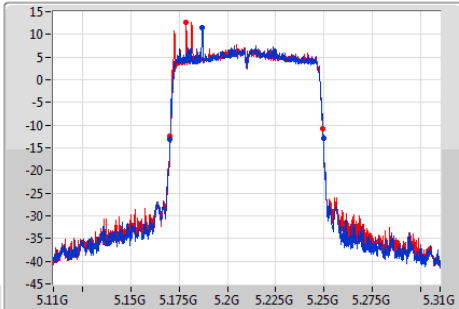

CF
5.21GHz
Span
200MHz
RBW
1MHz
VBW
3MHz
Sweep Time
100ms
Detector Type
Sample

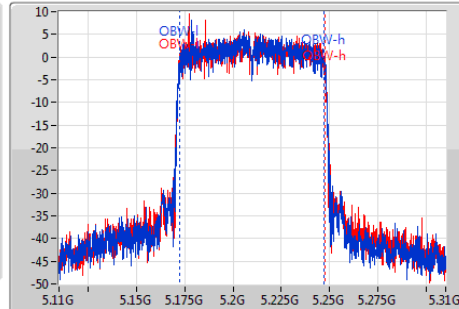

26dB(Hz)	Fl-26dB(Hz)	Fh-26dB(Hz)	OBW(Hz)	Fl-OBW(Hz)	Fh-OBW(Hz)	Limit(Hz)	Port
79.3M	5.1704G	5.2497G	74.663M	5.172619G	5.247281G	Inf	1
79.5M	5.17G	5.2495G	74.863M	5.172519G	5.247381G	Inf	2

802.11ac VHT80-BF_Nss1,(MCS0)_2TX

EBW

5775MHz

03/12/2018

CF
5.775GHz
Span
200MHz
RBW
100kHz
VBW
300kHz
Sweep Time
100ms
Detector Type
Peak

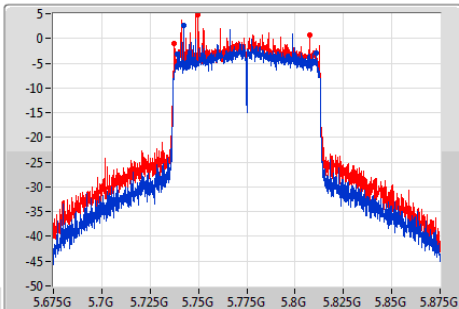

CF
5.775GHz
Span
200MHz
RBW
1MHz
VBW
3MHz
Sweep Time
100ms
Detector Type
Sample

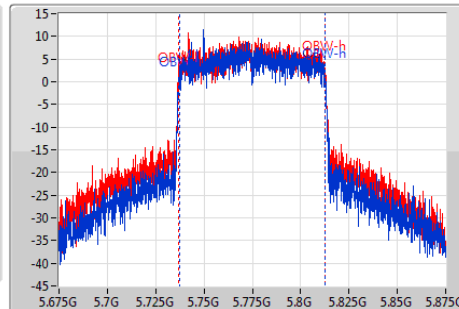

6dB(Hz)	Fl-6dB(Hz)	Fh-6dB(Hz)	OBW(Hz)	Fl-OBW(Hz)	Fh-OBW(Hz)	Limit(Hz)	Port
72.2M	5.739G	5.8112G	75.162M	5.737319G	5.812481G	500k	1
70M	5.7375G	5.8075G	75.562M	5.737019G	5.812581G	500k	2



Summary

Mode	Total Power (dBm)	Total Power (W)
5.15-5.25GHz	-	-
802.11a-BF_Nss1,(6Mbps)_2TX	24.53	0.28379
802.11ac VHT20-BF_Nss1,(MCS0)_2TX	24.16	0.26062
802.11ac VHT40-BF_Nss1,(MCS0)_2TX	24.33	0.27102
802.11ac VHT80-BF_Nss1,(MCS0)_2TX	16.73	0.04710
5.725-5.85GHz	-	-
802.11a-BF_Nss1,(6Mbps)_2TX	24.41	0.27606
802.11ac VHT20-BF_Nss1,(MCS0)_2TX	23.31	0.21429
802.11ac VHT40-BF_Nss1,(MCS0)_2TX	23.94	0.24774
802.11ac VHT80-BF_Nss1,(MCS0)_2TX	21.29	0.13459



Result

Mode	Result	DG (dBi)	Port 1 (dBm)	Port 2 (dBm)	Total Power (dBm)	Power Limit (dBm)
802.11a-BF_Nss1,(6Mbps)_2TX	-	-	-	-	-	-
5180MHz	Pass	6.34	19.20	18.98	22.10	29.66
5200MHz	Pass	6.34	20.20	20.25	23.24	29.66
5240MHz	Pass	6.34	21.70	21.33	24.53	29.66
5745MHz	Pass	6.34	21.40	21.20	24.31	29.66
5785MHz	Pass	6.34	21.60	21.20	24.41	29.66
5825MHz	Pass	6.34	20.46	20.42	23.45	29.66
802.11ac VHT20-BF_Nss1,(MCS0)_2TX	-	-	-	-	-	-
5180MHz	Pass	6.34	18.70	19.01	21.87	29.66
5200MHz	Pass	6.34	20.80	20.74	23.78	29.66
5240MHz	Pass	6.34	21.20	21.09	24.16	29.66
5745MHz	Pass	6.34	20.40	20.20	23.31	29.66
5785MHz	Pass	6.34	20.12	19.87	23.01	29.66
5825MHz	Pass	6.34	19.20	19.03	22.13	29.66
802.11ac VHT40-BF_Nss1,(MCS0)_2TX	-	-	-	-	-	-
5190MHz	Pass	6.34	14.69	13.82	17.29	29.66
5230MHz	Pass	6.34	21.46	21.18	24.33	29.66
5755MHz	Pass	6.34	21.08	20.77	23.94	29.66
5795MHz	Pass	6.34	20.79	20.27	23.55	29.66
802.11ac VHT80-BF_Nss1,(MCS0)_2TX	-	-	-	-	-	-
5210MHz	Pass	6.34	14.08	13.32	16.73	29.66
5775MHz	Pass	6.34	18.64	17.88	21.29	29.66

DG = Directional Gain; **Port X** = Port X output power



Summary

Mode	PD (dBm/RBW)
5.15-5.25GHz	-
802.11a-BF_Nss1,(6Mbps)_2TX	10.97
802.11ac VHT20-BF_Nss1,(MCS0)_2TX	11.35
802.11ac VHT40-BF_Nss1,(MCS0)_2TX	8.45
802.11ac VHT80-BF_Nss1,(MCS0)_2TX	-1.74
5.725-5.85GHz	-
802.11a-BF_Nss1,(6Mbps)_2TX	11.20
802.11ac VHT20-BF_Nss1,(MCS0)_2TX	8.43
802.11ac VHT40-BF_Nss1,(MCS0)_2TX	6.66
802.11ac VHT80-BF_Nss1,(MCS0)_2TX	2.03

RBW = 500kHz for 5.725-5.85GHz band / 1MHz for other band;



Result

Mode	Result	DG (dBi)	Port 1 (dBm/RBW)	Port 2 (dBm/RBW)	PD (dBm/RBW)	PD Limit (dBm/RBW)
802.11a-BF_Nss1,(6Mbps)_2TX	-	-	-	-	-	-
5180MHz	Pass	6.34	7.22	5.48	9.42	16.66
5200MHz	Pass	6.34	7.97	8.10	10.95	16.66
5240MHz	Pass	6.34	8.18	8.23	10.97	16.66
5745MHz	Pass	6.34	7.60	8.61	11.09	29.66
5785MHz	Pass	6.34	7.83	8.84	11.20	29.66
5825MHz	Pass	6.34	5.39	5.96	8.59	29.66
802.11ac VHT20-BF_Nss1,(MCS0)_2TX	-	-	-	-	-	-
5180MHz	Pass	6.34	5.91	6.44	9.12	16.66
5200MHz	Pass	6.34	8.56	8.15	11.35	16.66
5240MHz	Pass	6.34	7.98	8.04	10.98	16.66
5745MHz	Pass	6.34	4.38	5.30	7.79	29.66
5785MHz	Pass	6.34	5.66	5.25	8.43	29.66
5825MHz	Pass	6.34	3.20	2.97	5.98	29.66
802.11ac VHT40-BF_Nss1,(MCS0)_2TX	-	-	-	-	-	-
5190MHz	Pass	6.34	-3.01	-1.43	0.77	16.66
5230MHz	Pass	6.34	5.57	5.50	8.45	16.66
5755MHz	Pass	6.34	3.18	4.07	6.66	29.66
5795MHz	Pass	6.34	3.23	4.10	6.59	29.66
802.11ac VHT80-BF_Nss1,(MCS0)_2TX	-	-	-	-	-	-
5210MHz	Pass	6.34	-5.02	-4.40	-1.74	16.66
5775MHz	Pass	6.34	-1.56	-0.40	2.03	29.66

DG = Directional Gain; RBW = 500kHz for 5.725-5.85GHz band / 1MHz for other band;

PD = trace bin-by-bin of each transmits port summing can be performed maximum power density; Port X = Port Xpower density;

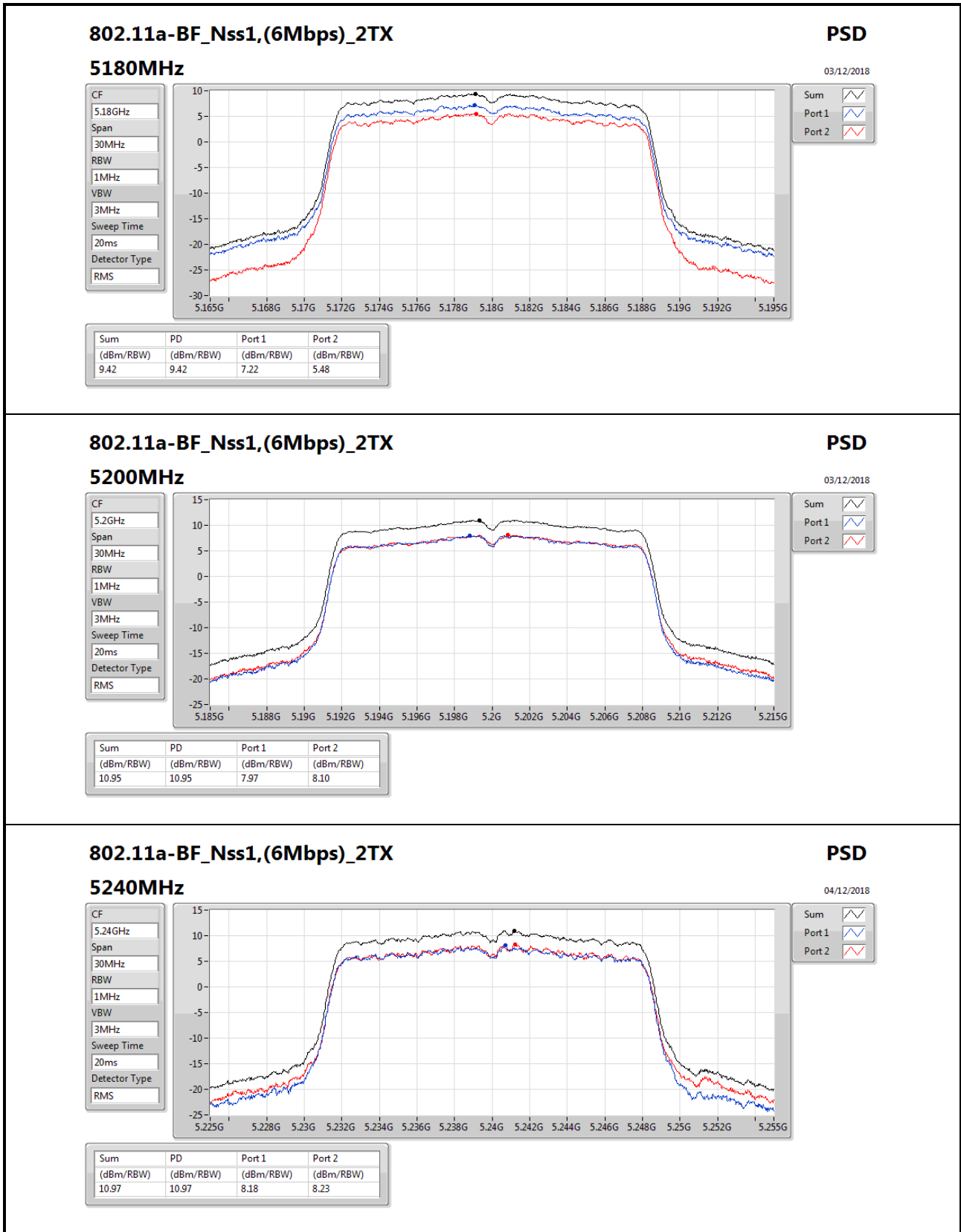

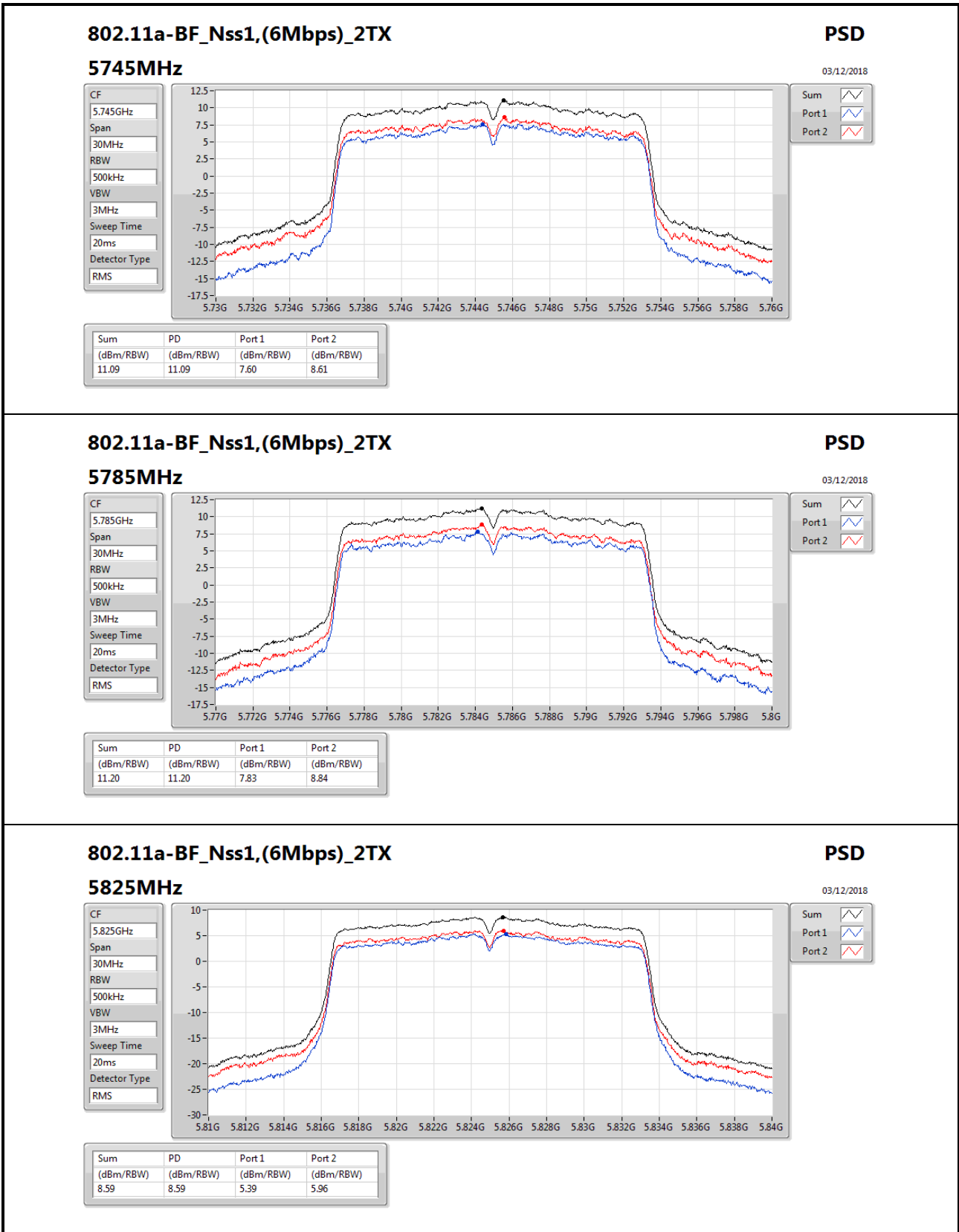

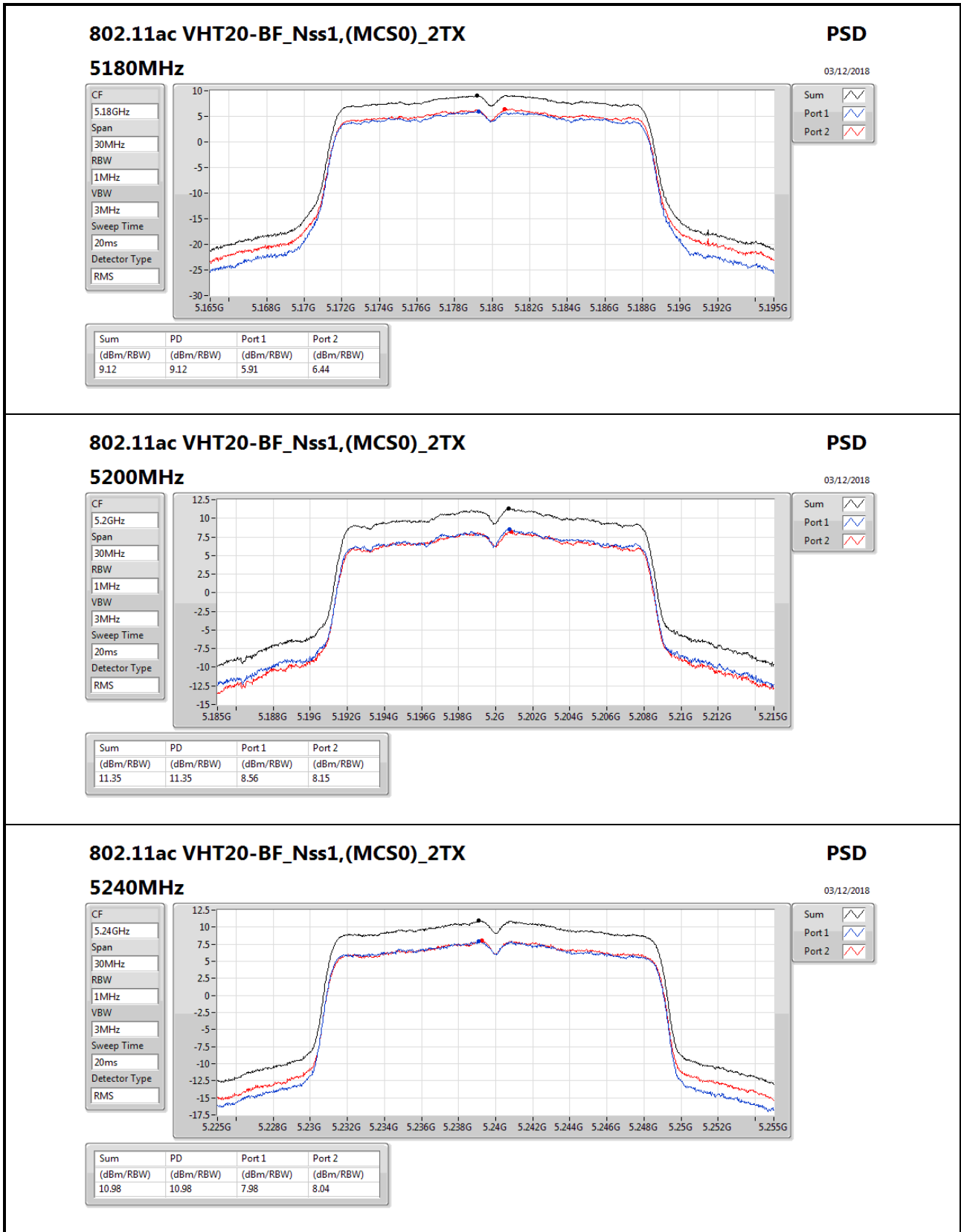

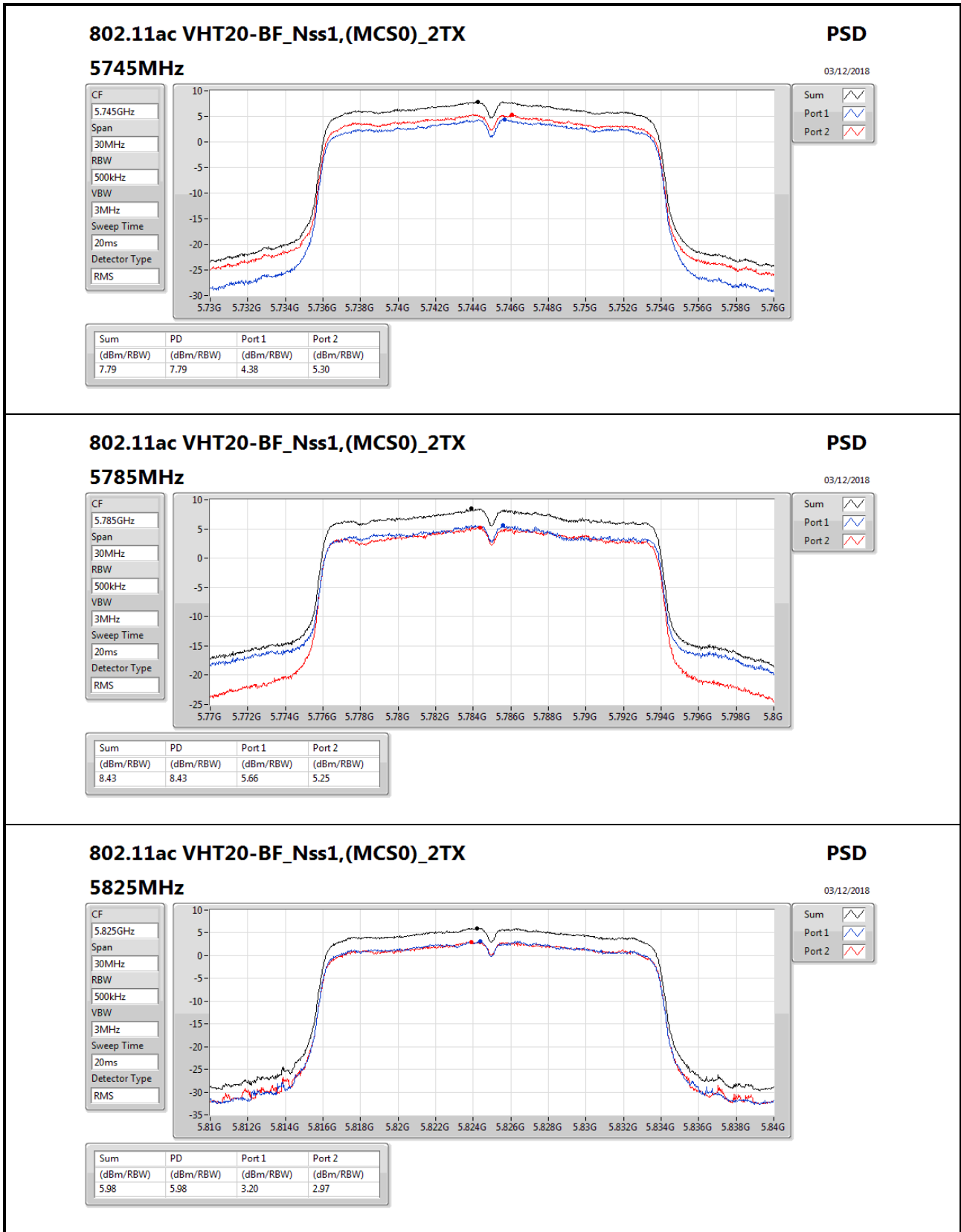

802.11ac VHT20-BF_Nss1,(MCS0)_2TX

5825MHz

PSD

03/12/2018

CF

5.825GHz

Span

30MHz

RBW

500kHz

VBW

3MHz

Sweep Time

20ms

Detector Type

RMS



Sum

Port 1

Port 2

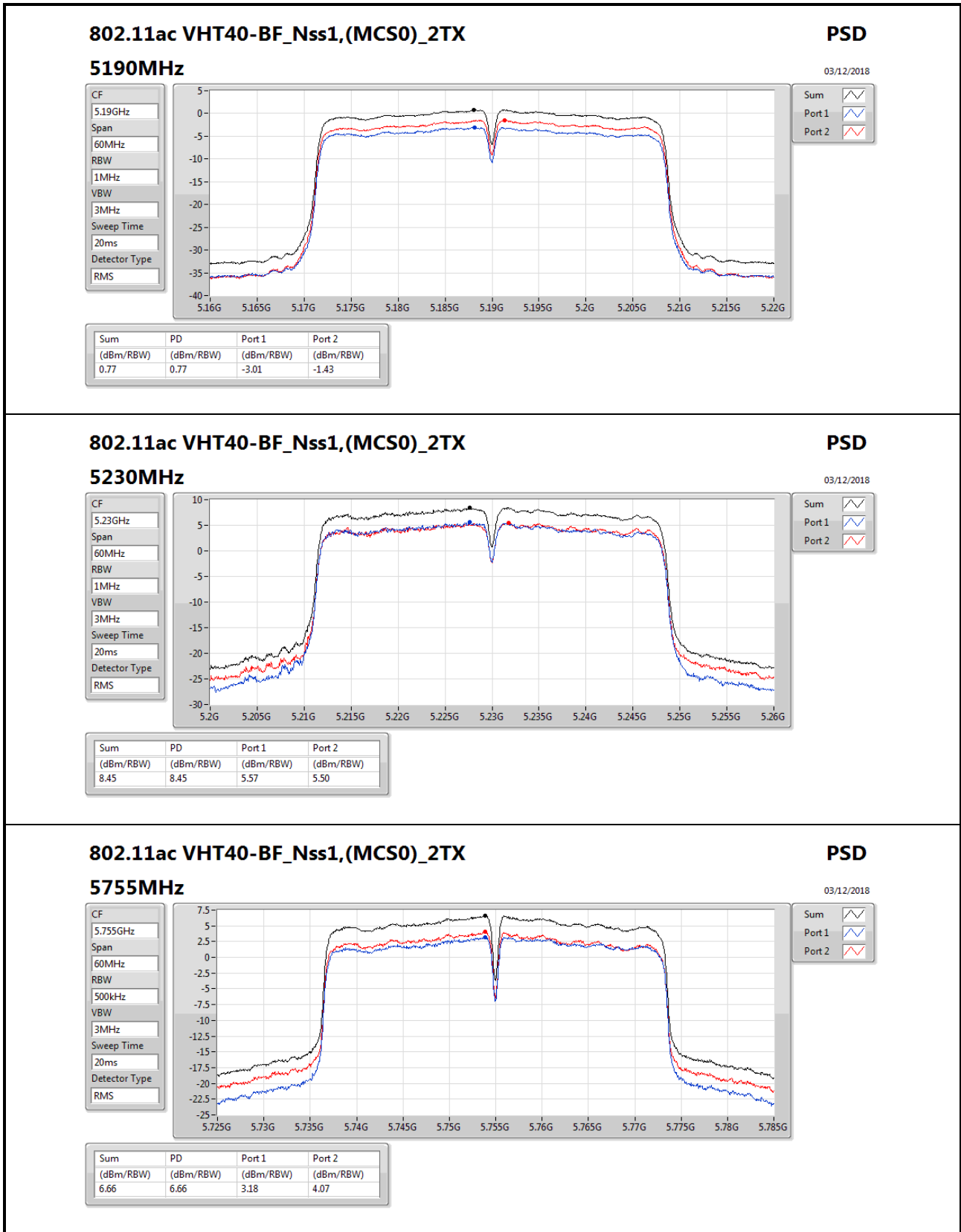

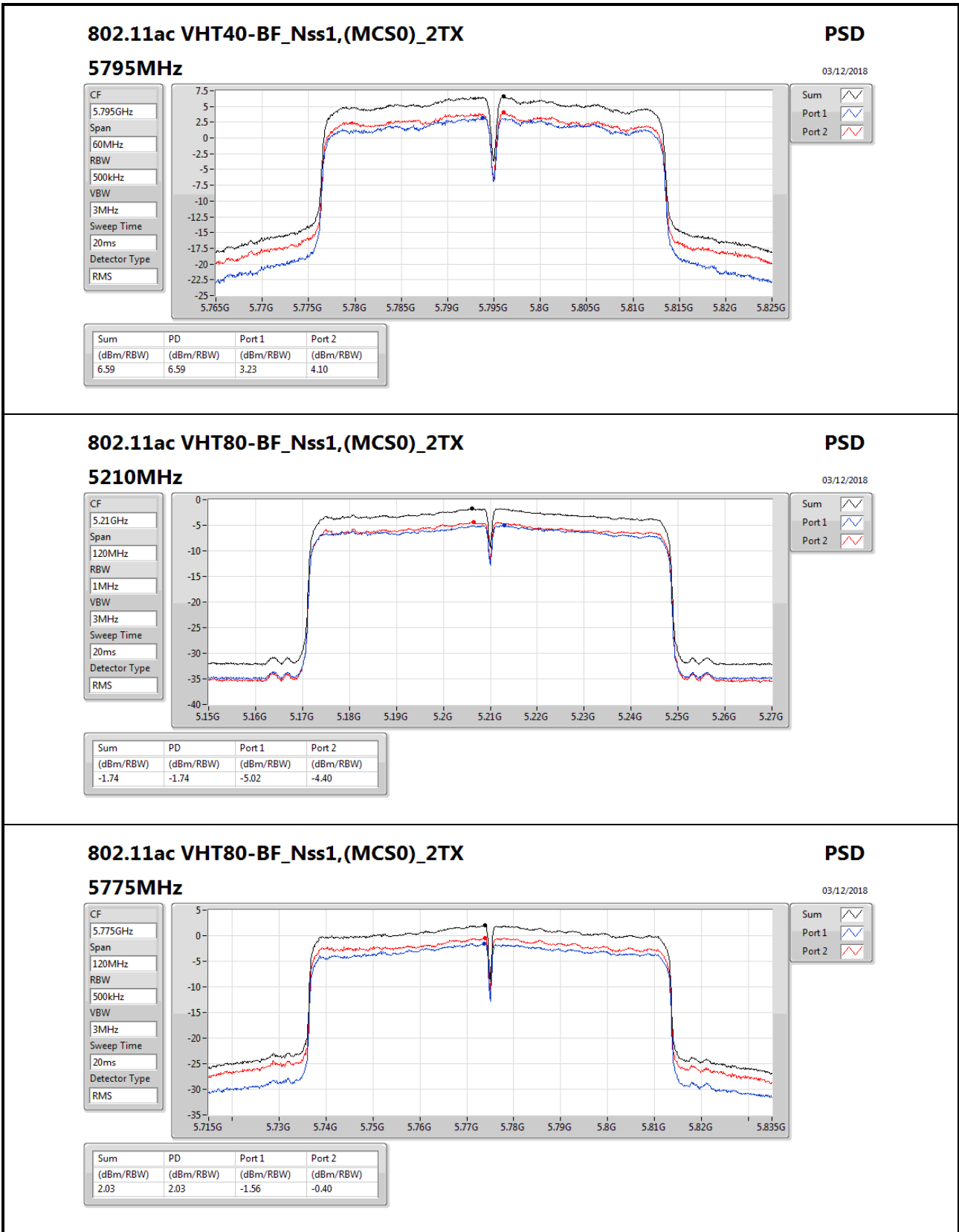



Summary

Mode	Result	Type	Freq (Hz)	Level (dBuV/m)	Limit (dBuV/m)	Margin (dB)	Condition
Mode 3	Pass	QP	55.22M	36.84	40.00	-3.16	Vertical

Mode 3

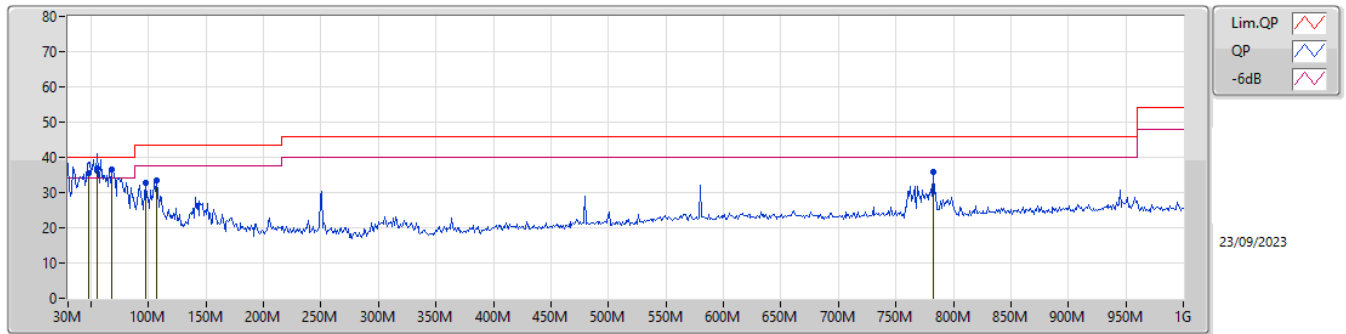

Type	Freq (Hz)	Level (dBuV/m)	Limit (dBuV/m)	Margin (dB)	Factor (dB/m)	Dist (m)	Condition	Azimuth (°)	Height (m)	Comment	Raw (dBuV/m)	AF (dB/m)	CL (dB)	PA (dB)
QP	47.46M	35.61	40.00	-4.39	-15.39	3	Vertical	113	1.00	-	51.00	15.37	0.76	31.52
QP	55.22M	36.84	40.00	-3.16	-17.46	3	Vertical	0	1.00	"Worst"	54.30	13.39	0.83	31.68
PK	67.83M	36.71	40.00	-3.29	-17.94	3	Vertical	20	1.00	-	54.65	12.89	0.91	31.74
PK	97.9M	32.60	43.50	-10.90	-14.15	3	Vertical	172	1.00	-	46.75	16.34	1.08	31.57
PK	106.63M	33.41	43.50	-10.09	-12.93	3	Vertical	163	1.00	-	46.34	17.51	1.13	31.57
PK	782.72M	36.00	46.00	-10.00	-3.48	3	Vertical	106	1.50	-	39.48	25.78	3.04	32.30





Summary

Mode	Result	Type	Freq (Hz)	Level (dBuV/m)	Limit (dBuV/m)	Margin (dB)	Factor (dB)	Dist (m)	Condition	Azimuth (°)	Height (m)	Comments
5.15-5.25GHz	-	-	-	-	-	-	-	-	-	-	-	-
802.11a-BF_Nss1,(6Mbps)_2TX	Pass	AV	5.15G	52.96	54.00	-1.04	7.27	3	Vertical	340	1.80	-

802.11a-BF_Nss1,(6Mbps)_2TX

27/11/2018

5180MHz_TX

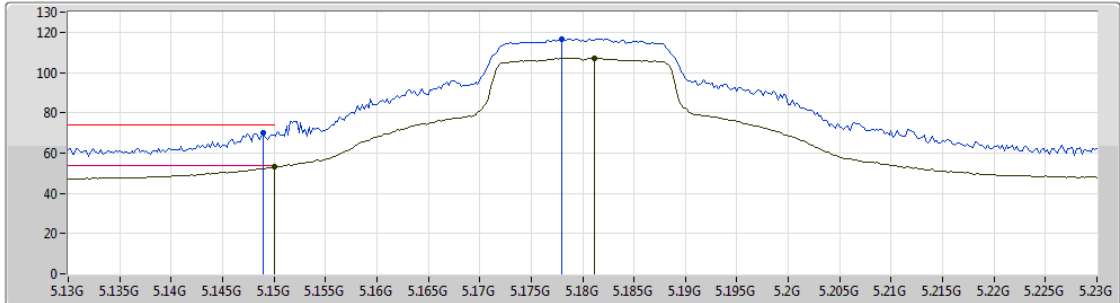

EUT_Z_2TX
Setting 27
06-W-3-10
FSP

Type	Freq (Hz)	Level (dBuV/m)	Limit (dBuV/m)	Margin (dB)	Factor (dB)	Dist (m)	Condition	Azimuth (°)	Height (m)	Comments
PK	5.149G	69.90	74.00	-4.10	7.27	3	Vertical	340	1.80	-
AV	5.15G	52.96	54.00	-1.04	7.27	3	Vertical	340	1.80	-
PK	5.178G	116.67	Inf	-Inf	7.33	3	Vertical	340	1.80	-
AV	5.1812G	107.19	Inf	-Inf	7.33	3	Vertical	340	1.80	-

802.11a-BF_Nss1,(6Mbps)_2TX

27/11/2018

5180MHz_TX

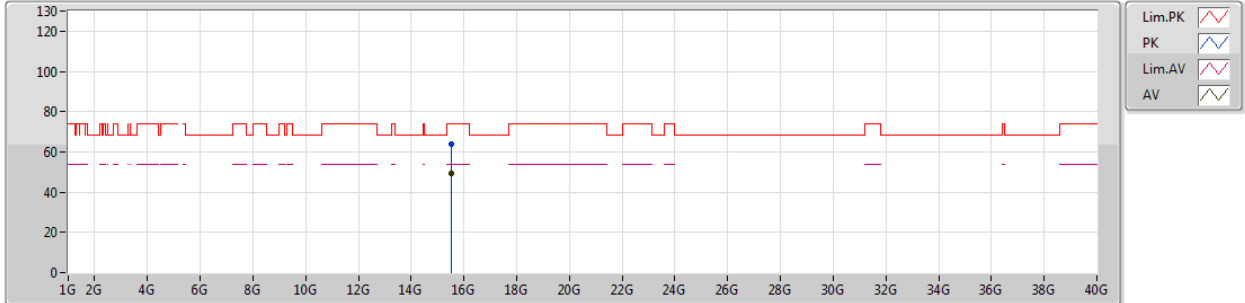

EUT_Z_2TX
Setting 27
06-W-3
FSP

Type	Freq	Level	Limit	Margin	Factor	Dist	Condition	Azimuth	Height	Comments
	(Hz)	(dBuV/m)	(dBuV/m)	(dB)	(dB)	(m)		(°)	(m)	
PK	15.54198G	63.71	74.00	-10.29	17.22	3	Vertical	71	2.03	-
AV	15.54024G	49.48	54.00	-4.52	17.23	3	Vertical	71	2.03	-

802.11a-BF_Nss1,(6Mbps)_2TX

27/11/2018

5180MHz_TX

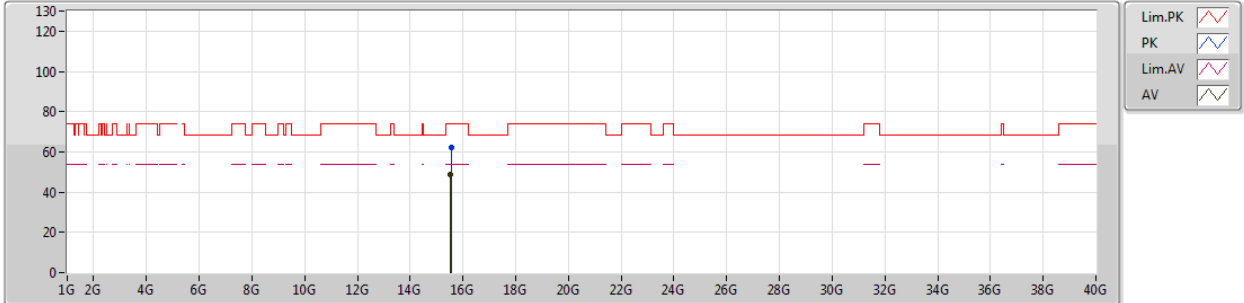

EUT_Z_2TX
Setting 27
06-W-3
FSP

Type	Freq	Level	Limit	Margin	Factor	Dist	Condition	Azimuth	Height	Comments
	(Hz)	(dBuV/m)	(dBuV/m)	(dB)	(dB)	(m)		(°)	(m)	
PK	15.54546G	62.27	74.00	-11.73	17.22	3	Horizontal	40	2.61	-
AV	15.5406G	48.62	54.00	-5.38	17.23	3	Horizontal	40	2.61	-

802.11a-BF_Nss1,(6Mbps)_2TX

28/11/2018

5200MHz_TX

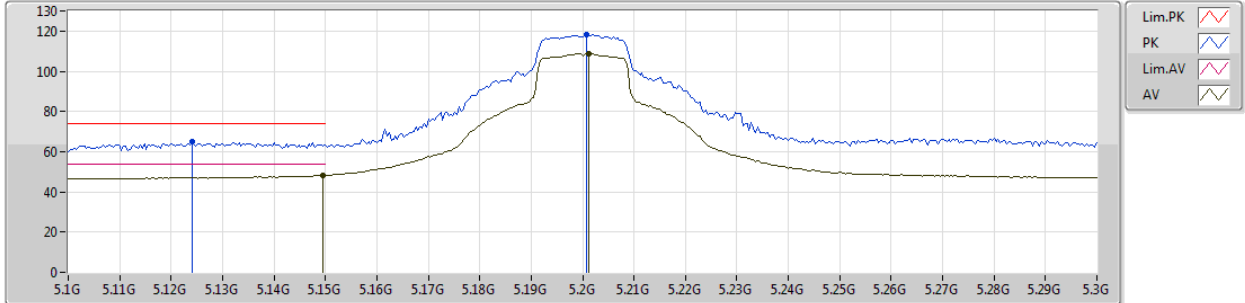

EUT_Z_2TX
Setting 30
06-W-3-10
FSP

Type	Freq (Hz)	Level (dBuV/m)	Limit (dBuV/m)	Margin (dB)	Factor (dB)	Dist (m)	Condition	Azimuth (°)	Height (m)	Comments
PK	5.124G	64.75	74.00	-9.25	7.23	3	Vertical	339	1.81	-
AV	5.1496G	48.37	54.00	-5.63	7.27	3	Vertical	339	1.81	-
PK	5.2008G	118.14	Inf	-Inf	7.36	3	Vertical	339	1.81	-
AV	5.2012G	108.72	Inf	-Inf	7.36	3	Vertical	339	1.81	-

802.11a-BF_Nss1,(6Mbps)_2TX

28/11/2018

5200MHz_TX

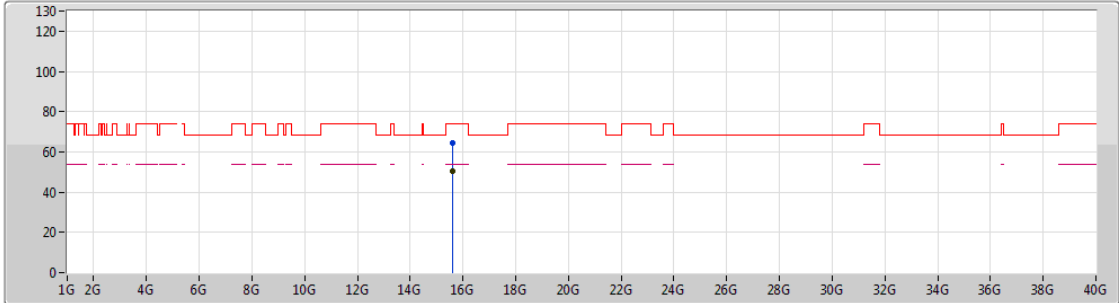

Lim.PK
 PK
 Lim.AV
 AV

EUT_Z_2TX
Setting 30
06-W-3
FSP

Type	Freq (Hz)	Level (dBuV/m)	Limit (dBuV/m)	Margin (dB)	Factor (dB)	Dist (m)	Condition	Azimuth (°)	Height (m)	Comments
PK	15.60102G	64.29	74.00	-9.71	17.15	3	Vertical	343	2.77	-
AV	15.60072G	50.65	54.00	-3.35	17.15	3	Vertical	343	2.77	-

802.11a-BF_Nss1,(6Mbps)_2TX

28/11/2018

5200MHz_TX

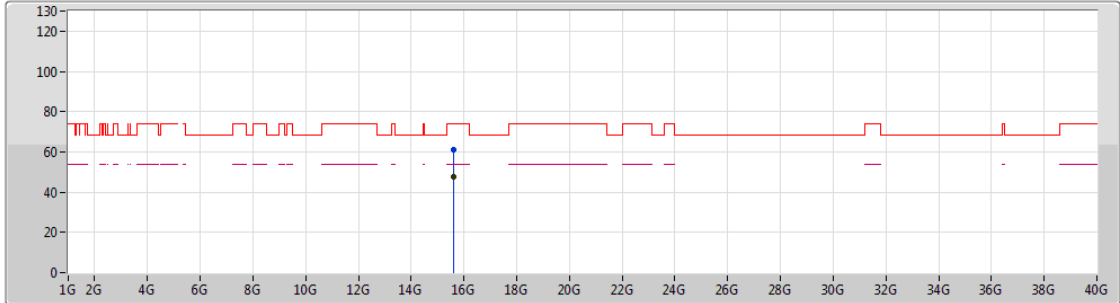

Lim.PK
 PK
 Lim.AV
 AV

EUT_Z_2TX
Setting 30
06-W-3
FSP

Type	Freq (Hz)	Level (dBuV/m)	Limit (dBuV/m)	Margin (dB)	Factor (dB)	Dist (m)	Condition	Azimuth (°)	Height (m)	Comments
PK	15.61062G	61.04	74.00	-12.96	17.13	3	Horizontal	1	1.50	-
AV	15.5883G	47.39	54.00	-6.61	17.17	3	Horizontal	1	1.50	-

802.11a-BF_Nss1,(6Mbps)_2TX

28/11/2018

5240MHz_TX

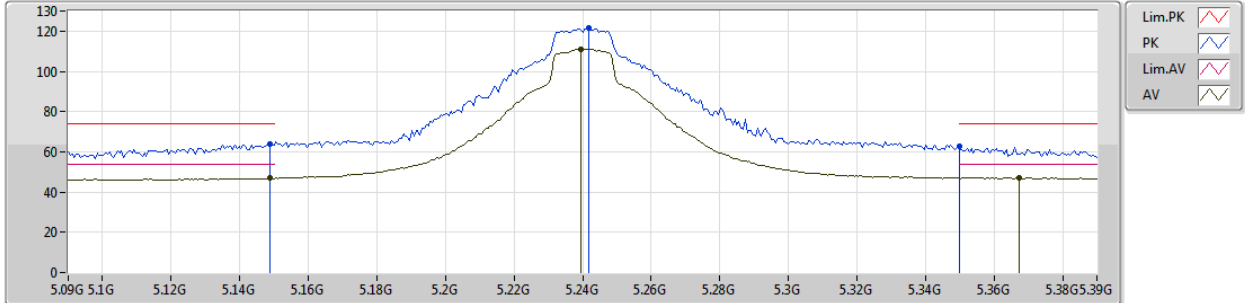

EUT_Z_2TX
Setting 35
06-W-3-10
FSP

Type	Freq (Hz)	Level (dBuV/m)	Limit (dBuV/m)	Margin (dB)	Factor (dB)	Dist (m)	Condition	Azimuth (°)	Height (m)	Comments
PK	5.1488G	63.92	74.00	-10.08	7.27	3	Vertical	344	1.87	-
AV	5.1488G	46.82	54.00	-7.18	7.27	3	Vertical	344	1.87	-
PK	5.2418G	121.42	Inf	-Inf	7.42	3	Vertical	344	1.87	-
AV	5.2394G	111.05	Inf	-Inf	7.40	3	Vertical	344	1.87	-
PK	5.35G	62.49	74.00	-11.51	7.55	3	Vertical	344	1.87	-
AV	5.3672G	47.19	54.00	-6.81	7.57	3	Vertical	344	1.87	-

802.11a-BF_Nss1,(6Mbps)_2TX

28/11/2018

5240MHz_TX

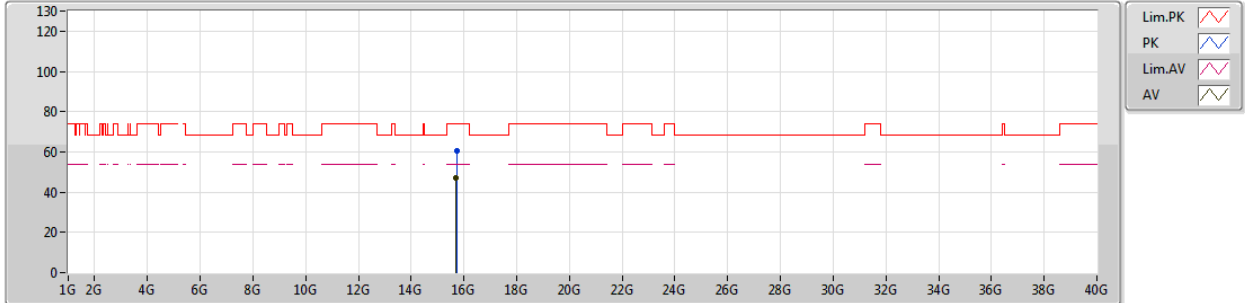

EUT_Z_2TX
Setting 35
06-W-3
FSP

Type	Freq (Hz)	Level (dBuV/m)	Limit (dBuV/m)	Margin (dB)	Factor (dB)	Dist (m)	Condition	Azimuth (°)	Height (m)	Comments
PK	15.71892G	60.63	74.00	-13.37	16.91	3	Vertical	96	2.95	-
AV	15.71022G	46.79	54.00	-7.21	16.92	3	Vertical	96	2.95	-

802.11a-BF_Nss1,(6Mbps)_2TX

28/11/2018

5240MHz_TX

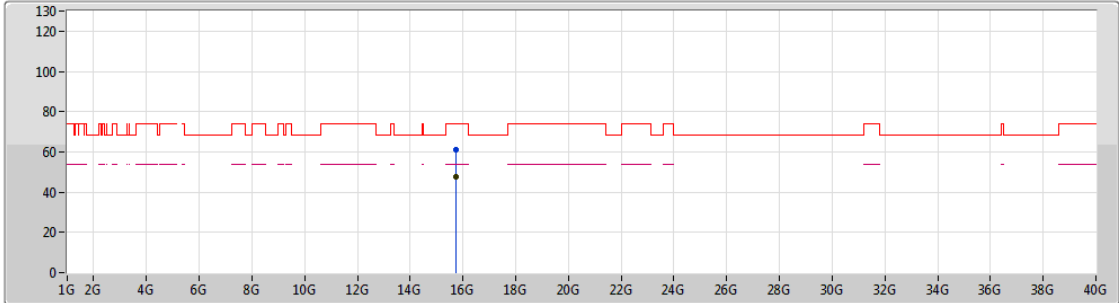

Lim.PK
 PK
 Lim.AV
 AV

EUT_Z_2TX
Setting 35
04-E-4
FSP

Type	Freq (Hz)	Level (dBuV/m)	Limit (dBuV/m)	Margin (dB)	Factor (dB)	Dist (m)	Condition	Azimuth (°)	Height (m)	Comments
PK	15.71936G	61.22	74.00	-12.78	15.91	3	Horizontal	58	1.34	-
AV	15.71728G	47.80	54.00	-6.20	15.92	3	Horizontal	58	1.34	-

802.11a-BF_Nss1,(6Mbps)_2TX

27/11/2018

5745MHz_TX

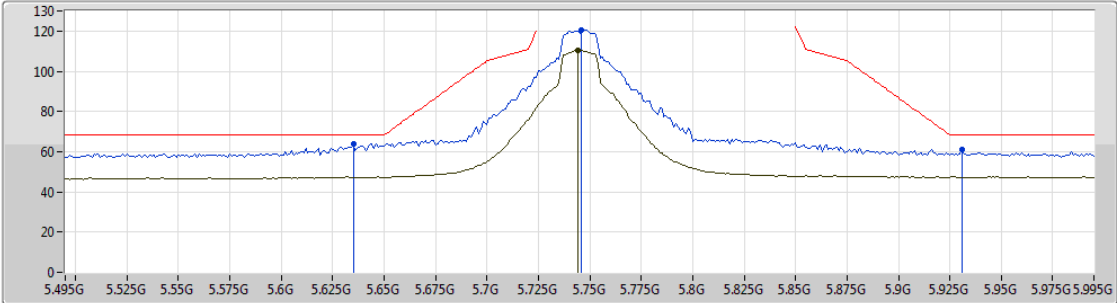

Lim.PK
 PK
 Lim.AV
 AV

EUT_Z_2TX
Setting 35
06-W-3-10
FSP

Type	Freq (Hz)	Level (dBuV/m)	Limit (dBuV/m)	Margin (dB)	Factor (dB)	Dist (m)	Condition	Azimuth (°)	Height (m)	Comments
PK	5.635G	63.97	68.20	-4.23	8.01	3	Vertical	21	1.93	-
PK	5.746G	120.56	Inf	-Inf	8.18	3	Vertical	21	1.93	-
AV	5.744G	110.30	Inf	-Inf	8.18	3	Vertical	21	1.93	-
PK	5.931G	60.94	68.20	-7.26	8.57	3	Vertical	21	1.93	-

802.11a-BF_Nss1,(6Mbps)_2TX

27/11/2018

5745MHz_TX

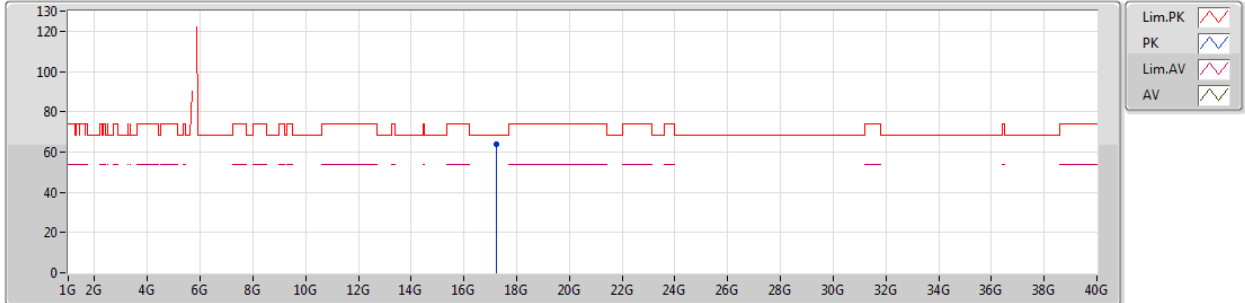

EUT_Z_2TX
Setting 35
06-W-3
FSP

Type	Freq	Level	Limit	Margin	Factor	Dist	Condition	Azimuth	Height	Comments
	(Hz)	(dBuV/m)	(dBuV/m)	(dB)	(dB)	(m)		(°)	(m)	
PK	17.24712G	64.02	68.20	-4.18	21.39	3	Vertical	2	1.50	-

802.11a-BF_Nss1,(6Mbps)_2TX

28/11/2018

5745MHz_TX

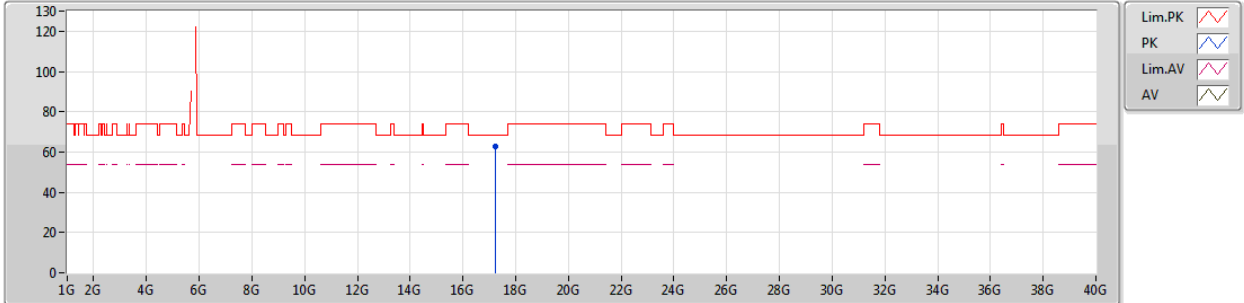

EUT_Z_2TX
Setting 35
04-E-4
FSP

Type	Freq	Level	Limit	Margin	Factor	Dist	Condition	Azimuth	Height	Comments
	(Hz)	(dBuV/m)	(dBuV/m)	(dB)	(dB)	(m)		(°)	(m)	
PK	17.24448G	62.95	68.20	-5.25	18.17	3	Horizontal	109	2.94	-

802.11a-BF_Nss1,(6Mbps)_2TX

28/11/2018

5785MHz_TX

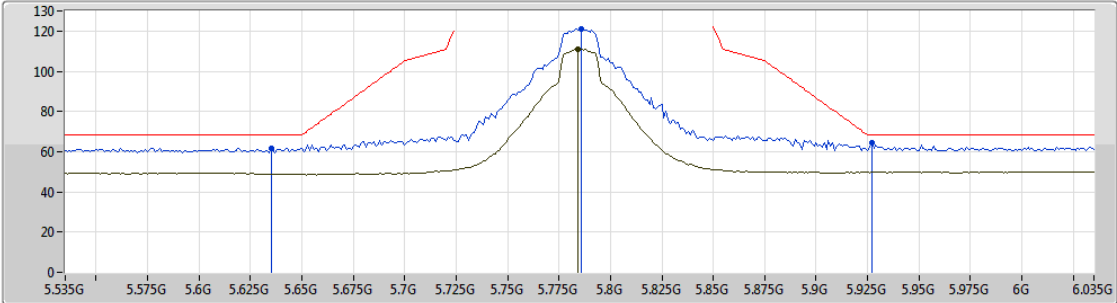

Lim.PK
 PK
 Lim.AV
 AV

EUT_Z_2TX
Setting 35
04-E-4-10
FSP

Type	Freq (Hz)	Level (dBuV/m)	Limit (dBuV/m)	Margin (dB)	Factor (dB)	Dist (m)	Condition	Azimuth (°)	Height (m)	Comments
PK	5.635G	61.88	68.20	-6.32	9.33	3	Vertical	9	2.08	-
PK	5.786G	121.26	Inf	-Inf	9.40	3	Vertical	9	2.08	-
AV	5.784G	111.03	Inf	-Inf	9.40	3	Vertical	9	2.08	-
PK	5.927G	64.33	68.20	-3.87	10.21	3	Vertical	9	2.08	-

802.11a-BF_Nss1,(6Mbps)_2TX

28/11/2018

5785MHz_TX

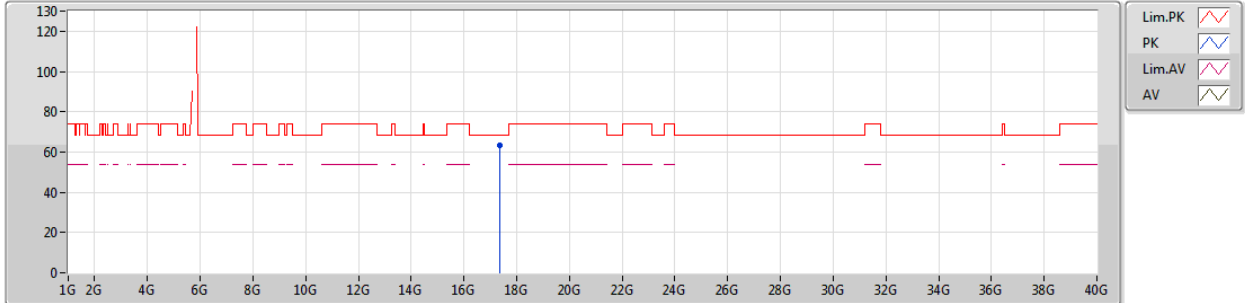

EUT_Z_2TX
Setting 35
04-E-4
FSP

Type	Freq	Level	Limit	Margin	Factor	Dist	Condition	Azimuth	Height	Comments
	(Hz)	(dBuV/m)	(dBuV/m)	(dB)	(dB)	(m)		(°)	(m)	
PK	17.35544G	63.32	68.20	-4.88	18.35	3	Vertical	163	2.96	-

802.11a-BF_Nss1,(6Mbps)_2TX

28/11/2018

5785MHz_TX

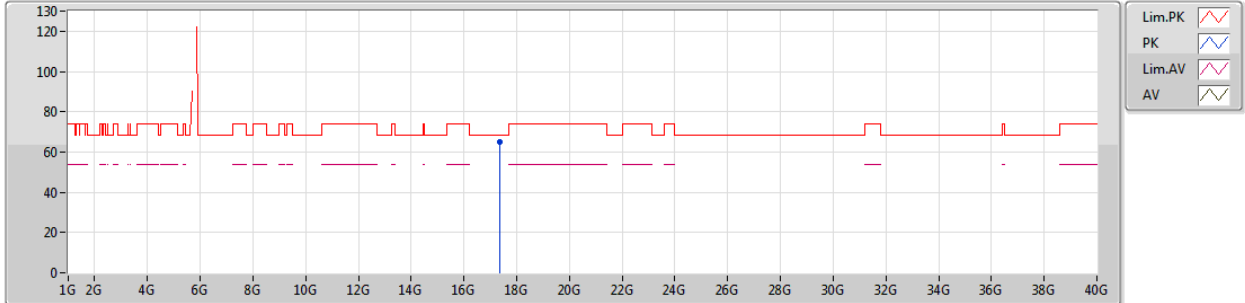

EUT_Z_2TX
Setting 35
04-E-4
FSP

Type	Freq (Hz)	Level (dBuV/m)	Limit (dBuV/m)	Margin (dB)	Factor (dB)	Dist (m)	Condition	Azimuth (°)	Height (m)	Comments
PK	17.3522G	65.17	68.20	-3.03	18.33	3	Horizontal	68	2.92	-

802.11a-BF_Nss1,(6Mbps)_2TX

27/11/2018

5825MHz_TX

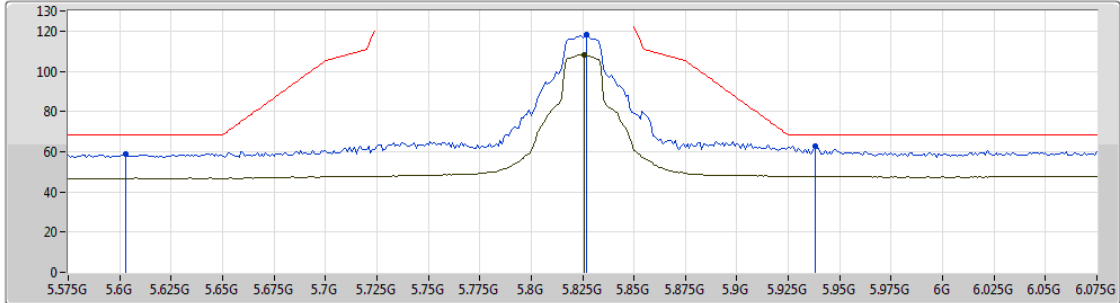

Lim.PK
 PK
 Lim.AV
 AV

EUT_Z_2TX
 Setting 30
 06-W-3-10
 FSP

Type	Freq (Hz)	Level (dBuV/m)	Limit (dBuV/m)	Margin (dB)	Factor (dB)	Dist (m)	Condition	Azimuth (°)	Height (m)	Comments
PK	5.603G	58.90	68.20	-9.30	7.95	3	Vertical	357	1.88	-
PK	5.827G	118.22	Inf	-Inf	8.33	3	Vertical	357	1.88	-
AV	5.826G	108.13	Inf	-Inf	8.33	3	Vertical	357	1.88	-
PK	5.938G	62.98	68.20	-5.22	8.58	3	Vertical	357	1.88	-

802.11a-BF_Nss1,(6Mbps)_2TX

27/11/2018

5825MHz_TX

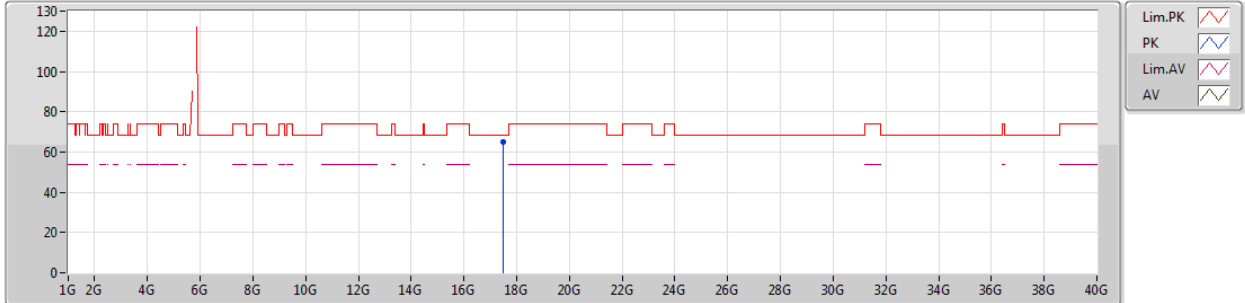

EUT_Z_2TX
Setting 30
06-W-3
FSP

Type	Freq (Hz)	Level (dBuV/m)	Limit (dBuV/m)	Margin (dB)	Factor (dB)	Dist (m)	Condition	Azimuth (°)	Height (m)	Comments
PK	17.47422G	64.95	68.20	-3.25	22.29	3	Vertical	33	2.97	-

802.11a-BF_Nss1,(6Mbps)_2TX

28/11/2018

5825MHz_TX

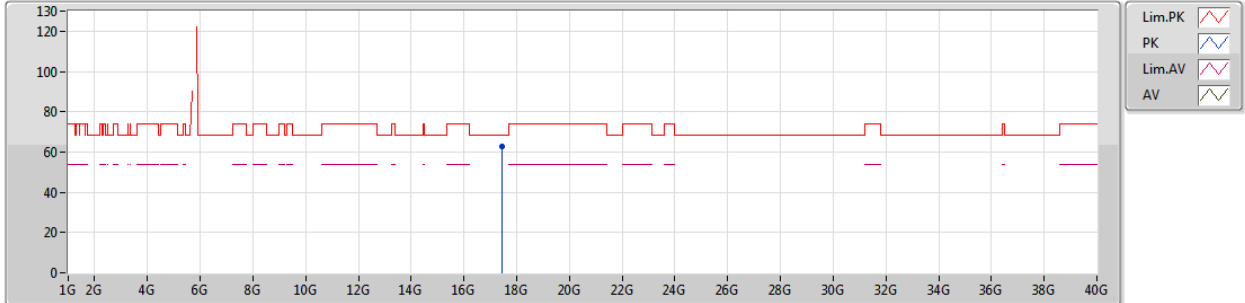

EUT_Z_2TX
Setting 30
04-E-4
FSP

Type	Freq	Level	Limit	Margin	Factor	Dist	Condition	Azimuth	Height	Comments
	(Hz)	(dBuV/m)	(dBuV/m)	(dB)	(dB)	(m)		(°)	(m)	
PK	17.4583G	62.93	68.20	-5.27	18.50	3	Horizontal	164	1.50	-

802.11ac VHT20-BF_Nss1,(MCS0)_2TX

27/11/2018

5180MHz_TX

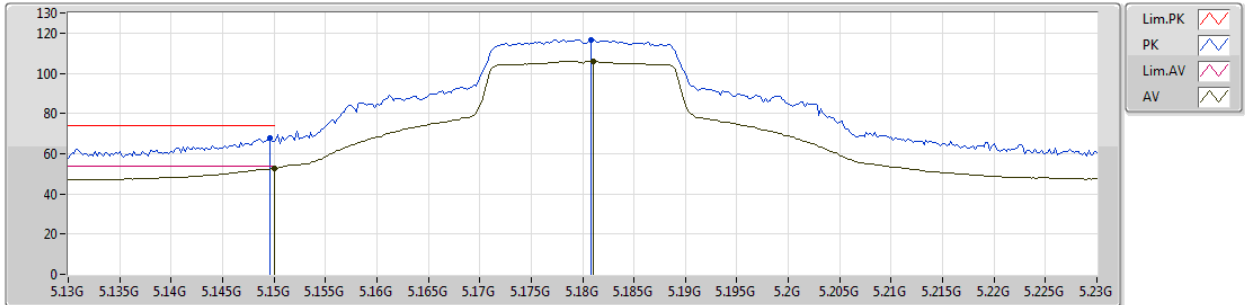

EUT_Z_2TX
Setting 29
06-W-3-10
FSP

Type	Freq (Hz)	Level (dBuV/m)	Limit (dBuV/m)	Margin (dB)	Factor (dB)	Dist (m)	Condition	Azimuth (°)	Height (m)	Comments
PK	5.1496G	67.64	74.00	-6.36	7.27	3	Vertical	22	2.09	-
AV	5.15G	52.63	54.00	-1.37	7.27	3	Vertical	22	2.09	-
PK	5.1808G	116.44	Inf	-Inf	7.33	3	Vertical	22	2.09	-
AV	5.181G	106.05	Inf	-Inf	7.33	3	Vertical	22	2.09	-

802.11ac VHT20-BF_Nss1,(MCS0)_2TX

27/11/2018

5180MHz_TX

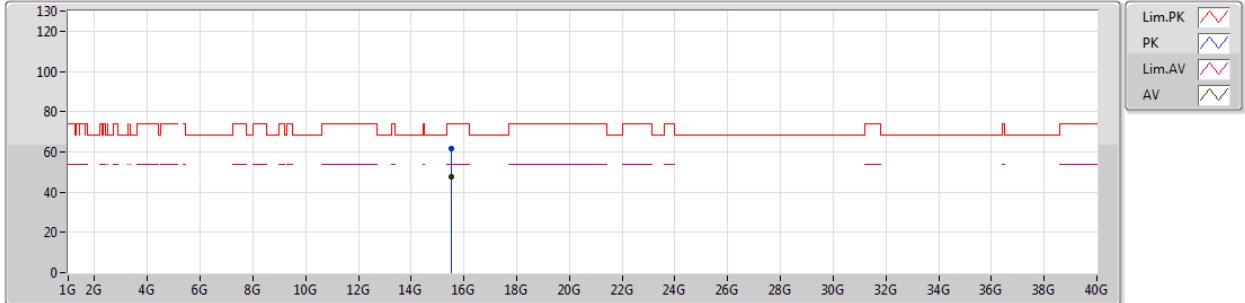

EUT_Z_2TX
Setting 29
06-W-3
FSP

Type	Freq	Level	Limit	Margin	Factor	Dist	Condition	Azimuth	Height	Comments
	(Hz)	(dBuV/m)	(dBuV/m)	(dB)	(dB)	(m)		(°)	(m)	
PK	15.53934G	61.68	74.00	-12.32	17.23	3	Vertical	325	2.02	-
AV	15.53712G	47.64	54.00	-6.36	17.23	3	Vertical	325	2.02	-

802.11ac VHT20-BF_Nss1,(MCS0)_2TX

27/11/2018

5180MHz_TX

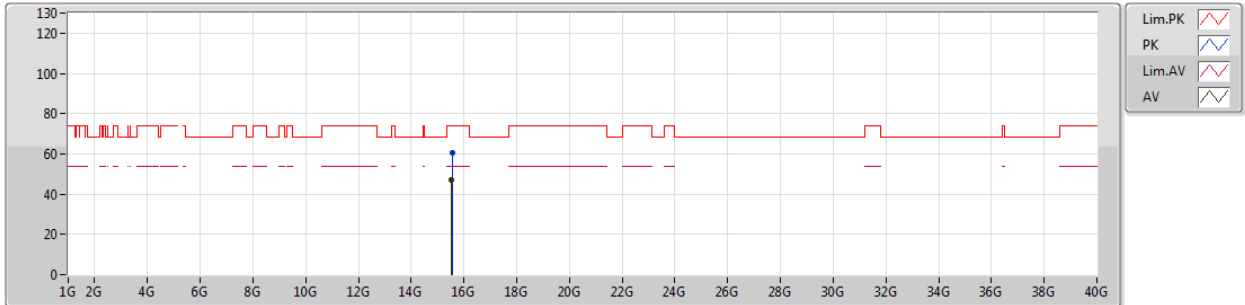

EUT_Z_2TX
Setting 29
06-W-3
FSP

Type	Freq (Hz)	Level (dBuV/m)	Limit (dBuV/m)	Margin (dB)	Factor (dB)	Dist (m)	Condition	Azimuth (°)	Height (m)	Comments
PK	15.54828G	60.52	74.00	-13.48	17.21	3	Horizontal	170	2.51	-
AV	15.53226G	46.90	54.00	-7.10	17.24	3	Horizontal	170	2.51	-

802.11ac VHT20-BF_Nss1,(MCS0)_2TX

27/11/2018

5200MHz_TX

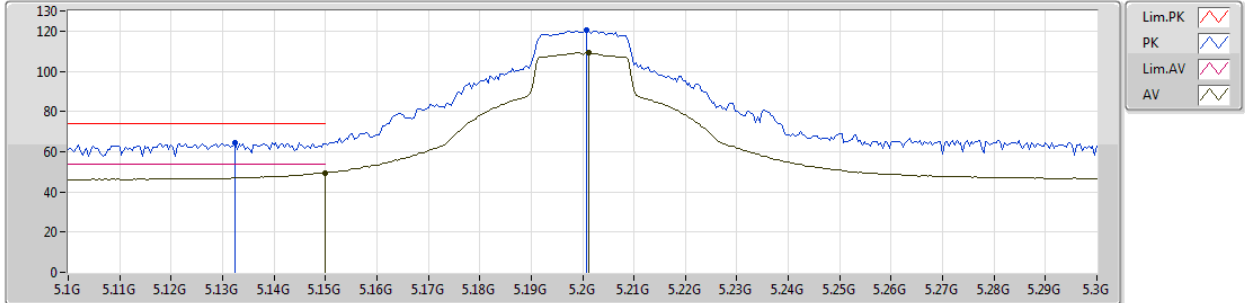

EUT_Z_2TX
Setting 34
06-W-3-10
FSP

Type	Freq (Hz)	Level (dBuV/m)	Limit (dBuV/m)	Margin (dB)	Factor (dB)	Dist (m)	Condition	Azimuth (°)	Height (m)	Comments
PK	5.1324G	64.41	74.00	-9.59	7.25	3	Vertical	340	1.78	-
AV	5.15G	49.43	54.00	-4.57	7.27	3	Vertical	340	1.78	-
PK	5.2008G	120.46	Inf	-Inf	7.36	3	Vertical	340	1.78	-
AV	5.2012G	109.25	Inf	-Inf	7.36	3	Vertical	340	1.78	-

802.11ac VHT20-BF_Nss1,(MCS0)_2TX

27/11/2018

5200MHz_TX

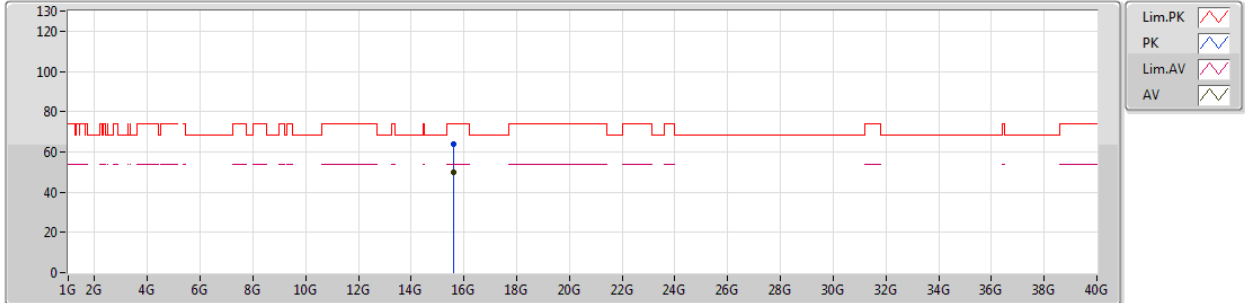

EUT_Z_2TX
Setting 34
06-W-3
FSP

Type	Freq	Level	Limit	Margin	Factor	Dist	Condition	Azimuth	Height	Comments
	(Hz)	(dBuV/m)	(dBuV/m)	(dB)	(dB)	(m)		(°)	(m)	
PK	15.6048G	63.70	74.00	-10.30	17.15	3	Vertical	356	2.42	-
AV	15.59964G	50.08	54.00	-3.92	17.15	3	Vertical	356	2.42	-

802.11ac VHT20-BF_Nss1,(MCS0)_2TX

28/11/2018

5200MHz_TX

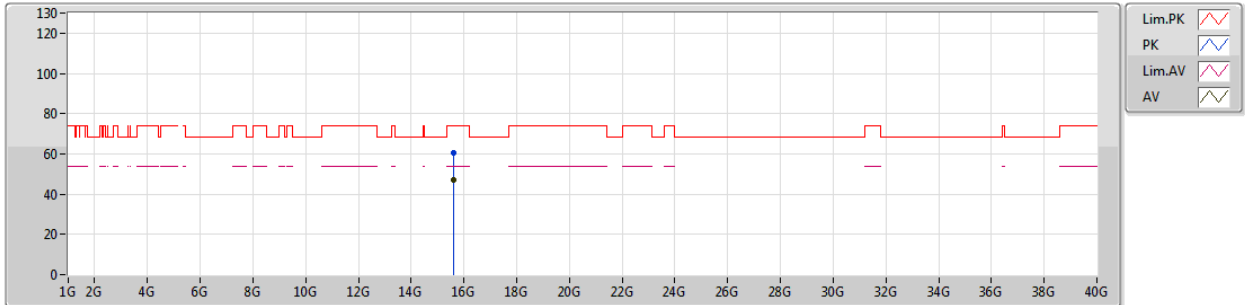

EUT_Z_2TX
Setting 34
04-E-4
FSP

Type	Freq (Hz)	Level (dBuV/m)	Limit (dBuV/m)	Margin (dB)	Factor (dB)	Dist (m)	Condition	Azimuth (°)	Height (m)	Comments
PK	15.597G	60.67	74.00	-13.33	15.97	3	Horizontal	120	1.06	-
AV	15.60564G	46.93	54.00	-7.07	15.98	3	Horizontal	120	1.06	-

802.11ac VHT20-BF_Nss1,(MCS0)_2TX

27/11/2018

5240MHz_TX

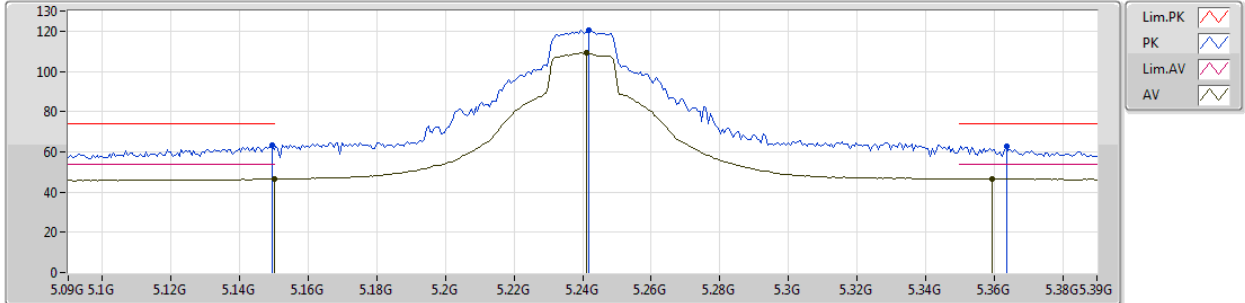

EUT_Z_2TX
Setting 35
06-W-3-10
FSP

Type	Freq (Hz)	Level (dBuV/m)	Limit (dBuV/m)	Margin (dB)	Factor (dB)	Dist (m)	Condition	Azimuth (°)	Height (m)	Comments
PK	5.1494G	63.29	74.00	-10.71	7.27	3	Vertical	356	1.95	-
AV	5.15G	46.36	54.00	-7.64	7.27	3	Vertical	356	1.95	-
PK	5.2418G	120.68	Inf	-Inf	7.42	3	Vertical	356	1.95	-
AV	5.2412G	109.05	Inf	-Inf	7.40	3	Vertical	356	1.95	-
PK	5.3636G	62.73	74.00	-11.27	7.57	3	Vertical	356	1.95	-
AV	5.3594G	46.63	54.00	-7.37	7.57	3	Vertical	356	1.95	-

802.11ac VHT20-BF_Nss1,(MCS0)_2TX

27/11/2018

5240MHz_TX

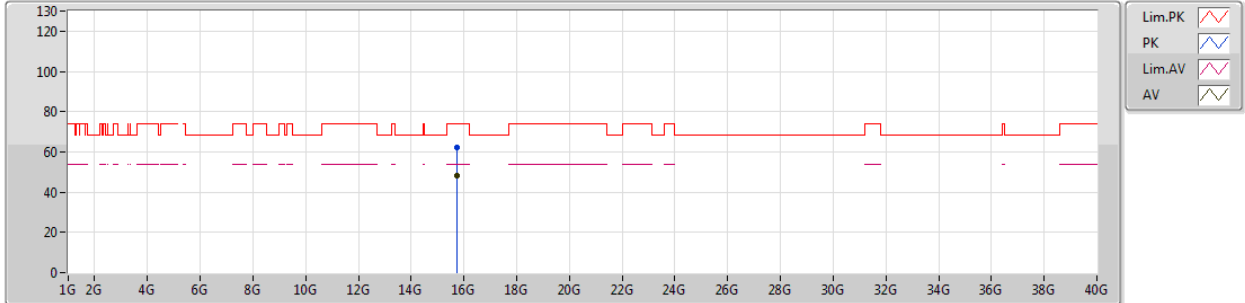

EUT_Z_2TX
Setting 35
06-W-3
FSP

Type	Freq	Level	Limit	Margin	Factor	Dist	Condition	Azimuth	Height	Comments
	(Hz)	(dBuV/m)	(dBuV/m)	(dB)	(dB)	(m)		(°)	(m)	
PK	15.7263G	62.08	74.00	-11.92	16.91	3	Vertical	0	2.78	-
AV	15.71988G	48.01	54.00	-5.99	16.91	3	Vertical	0	2.78	-

802.11ac VHT20-BF_Nss1,(MCS0)_2TX

28/11/2018

5240MHz_TX

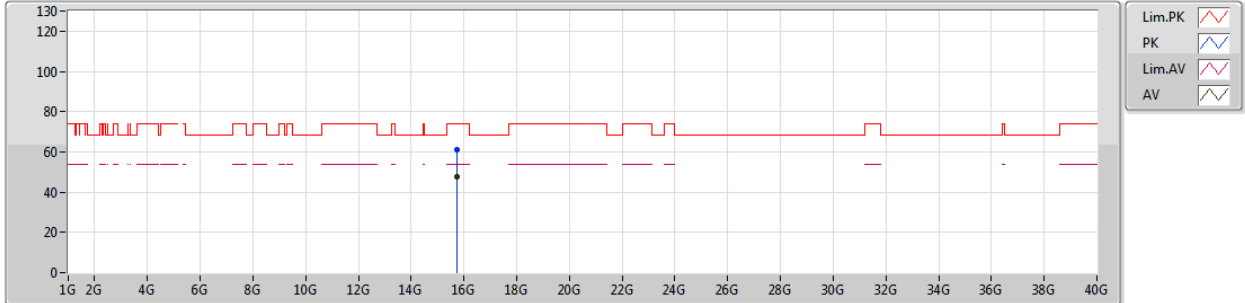

EUT_Z_2TX
Setting 35
04-E-4
FSP





Type	Freq (Hz)	Level (dBuV/m)	Limit (dBuV/m)	Margin (dB)	Factor (dB)	Dist (m)	Condition	Azimuth (°)	Height (m)	Comments
PK	15.7243G	61.32	74.00	-12.68	15.91	3	Horizontal	121	1.50	-
AV	15.7422G	47.36	54.00	-6.64	15.90	3	Horizontal	121	1.50	-

802.11ac VHT20-BF_Nss1,(MCS0)_2TX

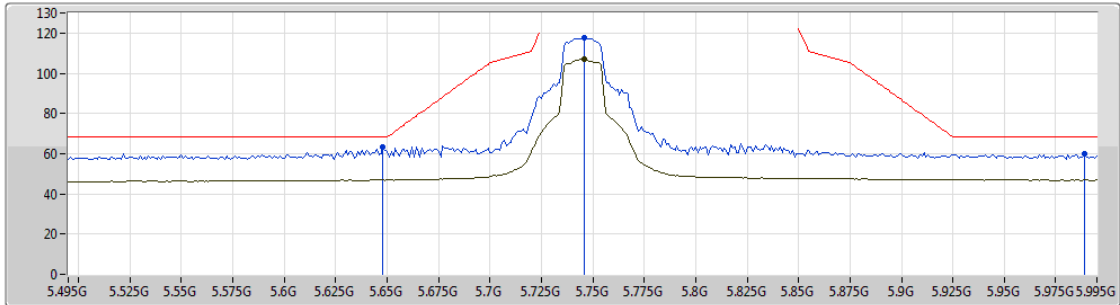
28/11/2018

5745MHz_TX



Lim.PK 
 PK 
 Lim.AV 
 AV 

EUT_Z_2TX
Setting 30
06-W-3-10
FSP

Type	Freq (Hz)	Level (dBuV/m)	Limit (dBuV/m)	Margin (dB)	Factor (dB)	Dist (m)	Condition	Azimuth (°)	Height (m)	Comments
PK	5.648G	63.07	68.20	-5.13	8.03	3	Vertical	358	1.98	-
PK	5.746G	117.55	Inf	-Inf	8.18	3	Vertical	358	1.98	-
AV	5.746G	106.81	Inf	-Inf	8.18	3	Vertical	358	1.98	-
PK	5.989G	59.80	68.20	-8.40	8.69	3	Vertical	358	1.98	-

802.11ac VHT20-BF_Nss1,(MCS0)_2TX

28/11/2018

5745MHz_TX

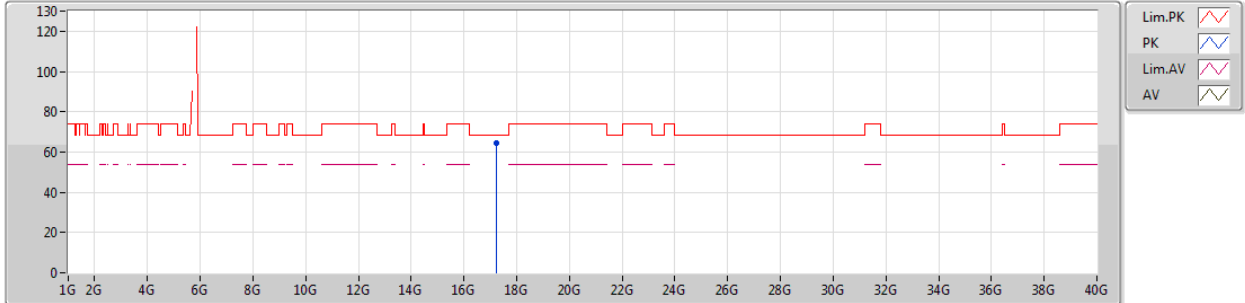

EUT_Z_2TX
Setting 30
06-W-3
FSP

Type	Freq	Level	Limit	Margin	Factor	Dist	Condition	Azimuth	Height	Comments
	(Hz)	(dBuV/m)	(dBuV/m)	(dB)	(dB)	(m)		(°)	(m)	
PK	17.23158G	64.59	68.20	-3.61	21.33	3	Vertical	94	1.50	-

802.11ac VHT20-BF_Nss1,(MCS0)_2TX

28/11/2018

5745MHz_TX

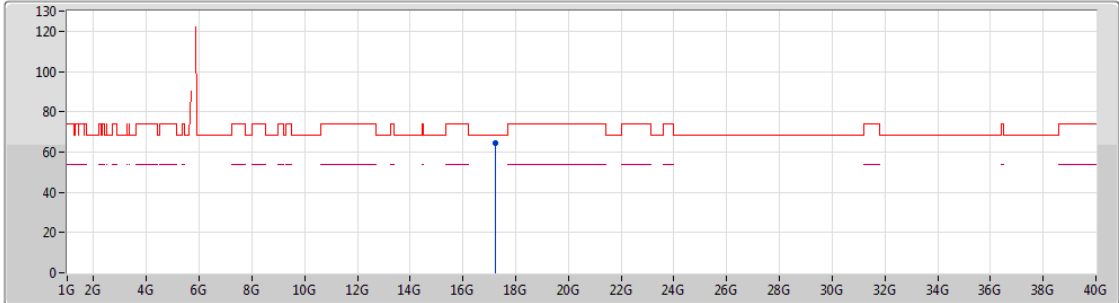

Lim.PK
 PK
 Lim.AV
 AV

EUT_Z_2TX
Setting 30
06-W-3
FSP

Type	Freq (Hz)	Level (dBuV/m)	Limit (dBuV/m)	Margin (dB)	Factor (dB)	Dist (m)	Condition	Azimuth (°)	Height (m)	Comments
PK	17.2395G	64.36	68.20	-3.84	21.36	3	Horizontal	14	1.06	-

802.11ac VHT20-BF_Nss1,(MCS0)_2TX

28/11/2018

5785MHz_TX

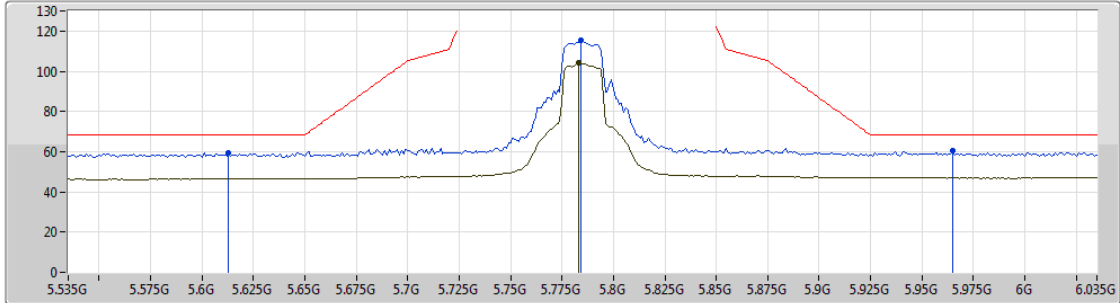

Lim.PK
 PK
 Lim.AV
 AV

EUT_Z_2TX
Setting 30
06-W-3-10
FSP

Type	Freq (Hz)	Level (dBuV/m)	Limit (dBuV/m)	Margin (dB)	Factor (dB)	Dist (m)	Condition	Azimuth (°)	Height (m)	Comments
PK	5.613G	59.41	68.20	-8.79	7.98	3	Vertical	0	1.89	-
PK	5.784G	115.32	Inf	-Inf	8.25	3	Vertical	0	1.89	-
AV	5.783G	104.01	Inf	-Inf	8.25	3	Vertical	0	1.89	-
PK	5.965G	60.58	68.20	-7.62	8.64	3	Vertical	0	1.89	-

802.11ac VHT20-BF_Nss1,(MCS0)_2TX

28/11/2018

5785MHz_TX

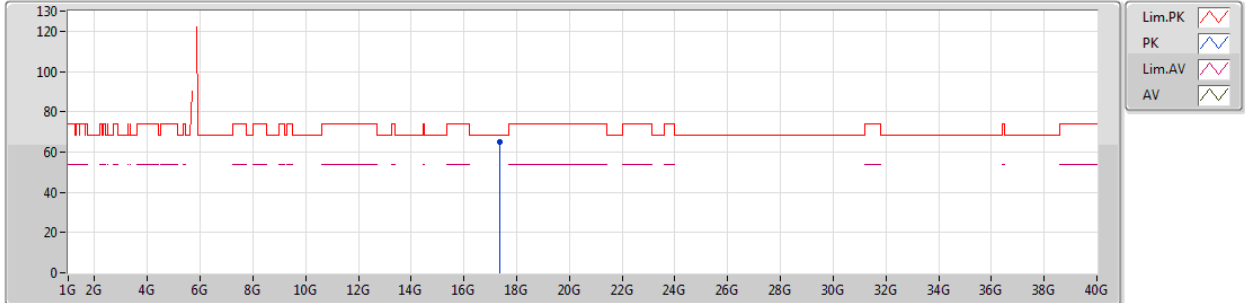

EUT_Z_2TX
Setting 30
06-W-3
FSP

Type	Freq	Level	Limit	Margin	Factor	Dist	Condition	Azimuth	Height	Comments
	(Hz)	(dBuV/m)	(dBuV/m)	(dB)	(dB)	(m)		(°)	(m)	
PK	17.34036G	65.08	68.20	-3.12	21.76	3	Vertical	358	1.50	-

802.11ac VHT20-BF_Nss1,(MCS0)_2TX

28/11/2018

5785MHz_TX

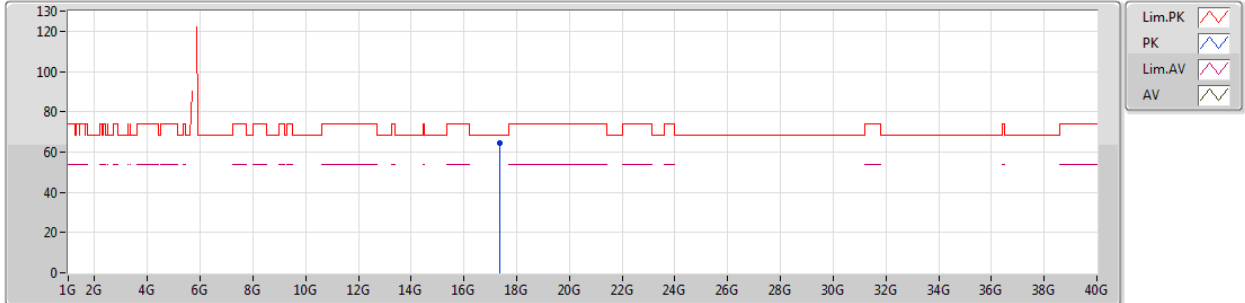

EUT_Z_2TX
Setting 30
06-W-3
FSP

Type	Freq (Hz)	Level (dBuV/m)	Limit (dBuV/m)	Margin (dB)	Factor (dB)	Dist (m)	Condition	Azimuth (°)	Height (m)	Comments
PK	17.3442G	64.65	68.20	-3.55	21.78	3	Horizontal	188	1.51	-

802.11ac VHT20-BF_Nss1,(MCS0)_2TX

28/11/2018

5825MHz_TX

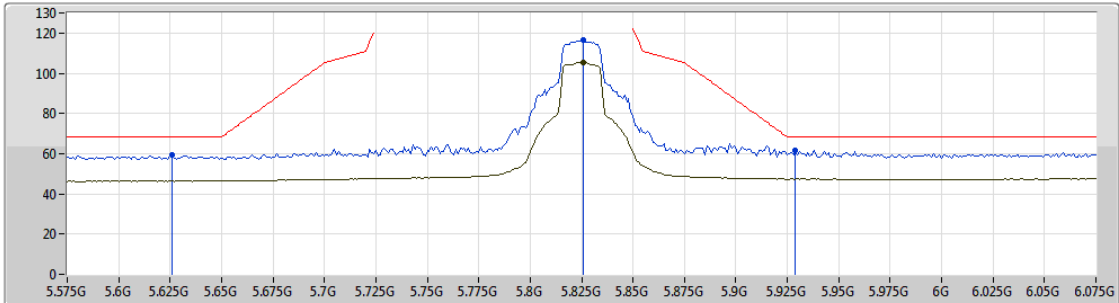

Lim.PK
 PK
 Lim.AV
 AV

EUT_Z_2TX
Setting 30
06-W-3-10
FSP

Type	Freq (Hz)	Level (dBuV/m)	Limit (dBuV/m)	Margin (dB)	Factor (dB)	Dist (m)	Condition	Azimuth (°)	Height (m)	Comments
PK	5.626G	59.22	68.20	-8.98	7.99	3	Vertical	316	2.24	-
PK	5.826G	116.71	Inf	-Inf	8.33	3	Vertical	316	2.24	-
AV	5.826G	105.44	Inf	-Inf	8.33	3	Vertical	316	2.24	-
PK	5.929G	61.85	68.20	-6.35	8.56	3	Vertical	316	2.24	-

802.11ac VHT20-BF_Nss1,(MCS0)_2TX

28/11/2018

5825MHz_TX

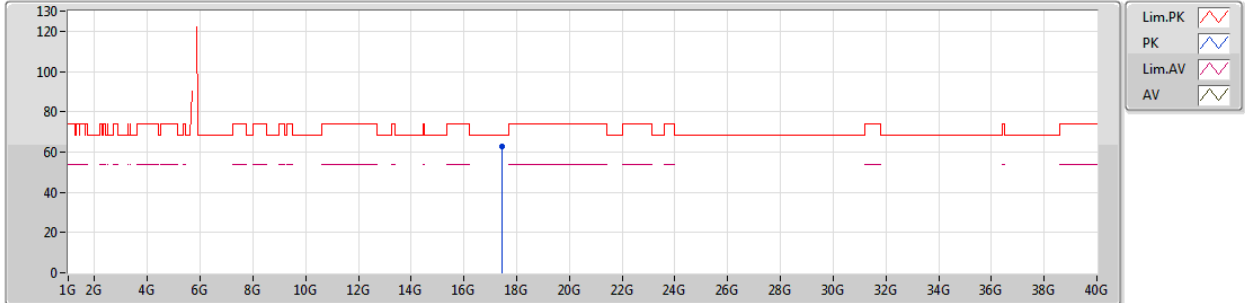

EUT_Z_2TX
Setting 30
04-E-4
FSP

Type	Freq	Level	Limit	Margin	Factor	Dist	Condition	Azimuth	Height	Comments
	(Hz)	(dBuV/m)	(dBuV/m)	(dB)	(dB)	(m)		(°)	(m)	
PK	17.4558G	62.97	68.20	-5.23	18.50	3	Vertical	130	1.50	-

802.11ac VHT20-BF_Nss1,(MCS0)_2TX

28/11/2018

5825MHz_TX

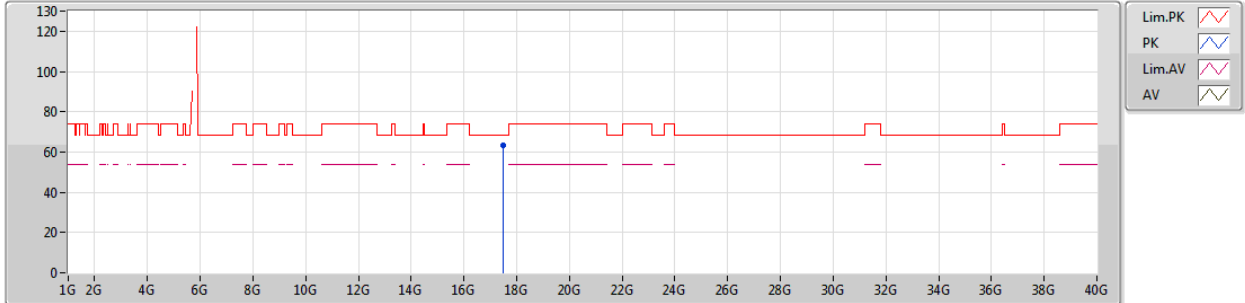

EUT_Z_2TX
Setting 30
04-E-4
FSP

Type	Freq (Hz)	Level (dBuV/m)	Limit (dBuV/m)	Margin (dB)	Factor (dB)	Dist (m)	Condition	Azimuth (°)	Height (m)	Comments
PK	17.4921G	63.21	68.20	-4.99	18.55	3	Horizontal	359	1.50	-

802.11ac VHT40-BF_Nss1,(MCS0)_2TX

28/11/2018

5190MHz_TX

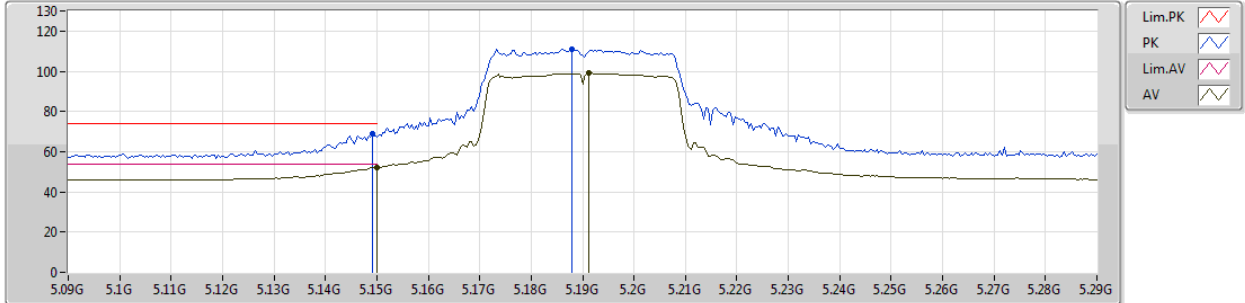

EUT_Z_2TX
Setting 18
06-W-3-10
FSP

Type	Freq (Hz)	Level (dBuV/m)	Limit (dBuV/m)	Margin (dB)	Factor (dB)	Dist (m)	Condition	Azimuth (°)	Height (m)	Comments
PK	5.1492G	68.79	74.00	-5.21	7.27	3	Vertical	352	1.68	-
AV	5.15G	52.03	54.00	-1.97	7.27	3	Vertical	352	1.68	-
PK	5.188G	111.07	Inf	-Inf	7.34	3	Vertical	352	1.68	-
AV	5.1912G	99.13	Inf	-Inf	7.34	3	Vertical	352	1.68	-

802.11ac VHT40-BF_Nss1,(MCS0)_2TX

28/11/2018

5190MHz_TX

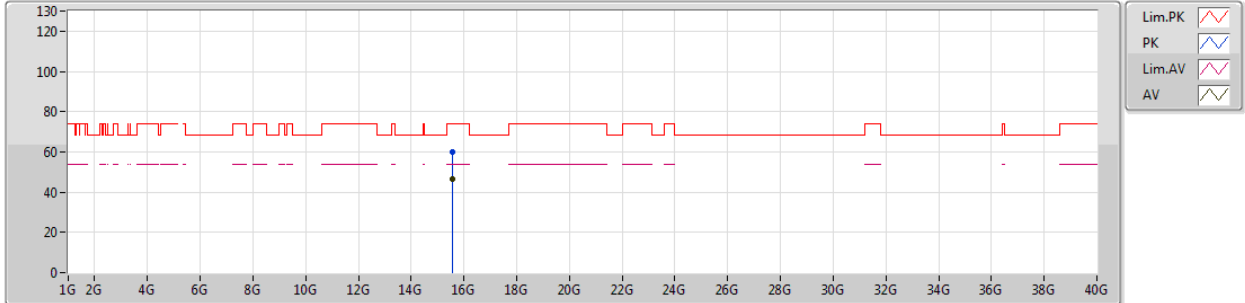

EUT_Z_2TX
Setting 18
06-W-3
FSP

Type	Freq	Level	Limit	Margin	Factor	Dist	Condition	Azimuth	Height	Comments
	(Hz)	(dBuV/m)	(dBuV/m)	(dB)	(dB)	(m)		(°)	(m)	
PK	15.57228G	60.12	74.00	-13.88	17.18	3	Vertical	351	2.67	-
AV	15.55728G	46.53	54.00	-7.47	17.20	3	Vertical	351	2.67	-

802.11ac VHT40-BF_Nss1,(MCS0)_2TX

28/11/2018

5190MHz_TX

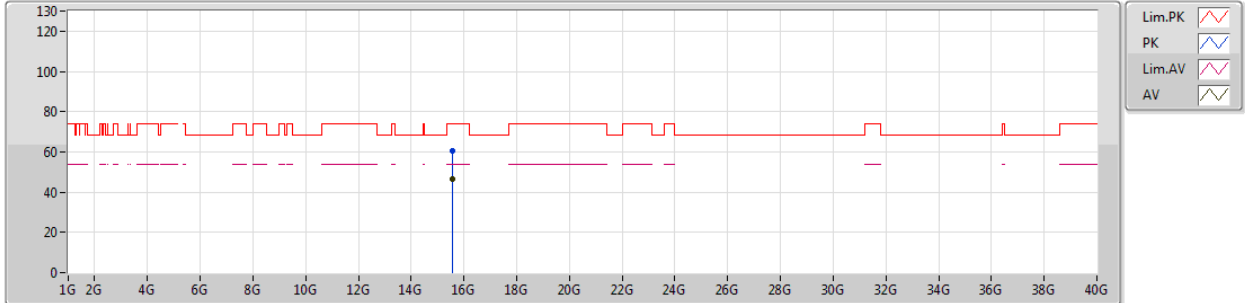

EUT_Z_2TX
Setting 18
06-W-3
FSP

Type	Freq (Hz)	Level (dBuV/m)	Limit (dBuV/m)	Margin (dB)	Factor (dB)	Dist (m)	Condition	Azimuth (°)	Height (m)	Comments
PK	15.56616G	60.44	74.00	-13.56	17.19	3	Horizontal	338	1.50	-
AV	15.55722G	46.41	54.00	-7.59	17.20	3	Horizontal	338	1.50	-

802.11ac VHT40-BF_Nss1,(MCS0)_2TX

28/11/2018

5230MHz_TX

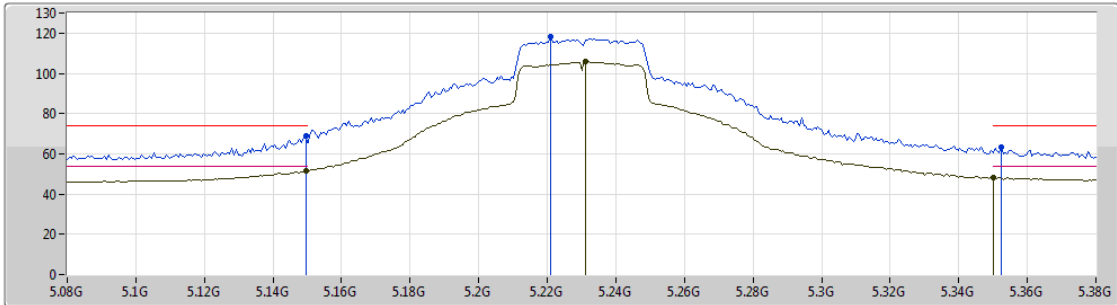

- Lim.PK
- PK
- Lim.AV
- AV

EUT_Z_2TX
Setting 35
06-W-3-10
FSP

Type	Freq (Hz)	Level (dBuV/m)	Limit (dBuV/m)	Margin (dB)	Factor (dB)	Dist (m)	Condition	Azimuth (°)	Height (m)	Comments
PK	5.1496G	68.66	74.00	-5.34	7.27	3	Vertical	19	2.03	-
AV	5.1496G	51.50	54.00	-2.50	7.27	3	Vertical	19	2.03	-
PK	5.221G	118.33	Inf	-Inf	7.38	3	Vertical	19	2.03	-
AV	5.2312G	105.84	Inf	-Inf	7.40	3	Vertical	19	2.03	-
PK	5.3524G	63.20	74.00	-10.80	7.55	3	Vertical	19	2.03	-
AV	5.35G	48.22	54.00	-5.78	7.55	3	Vertical	19	2.03	-

802.11ac VHT40-BF_Nss1,(MCS0)_2TX

28/11/2018

5230MHz_TX

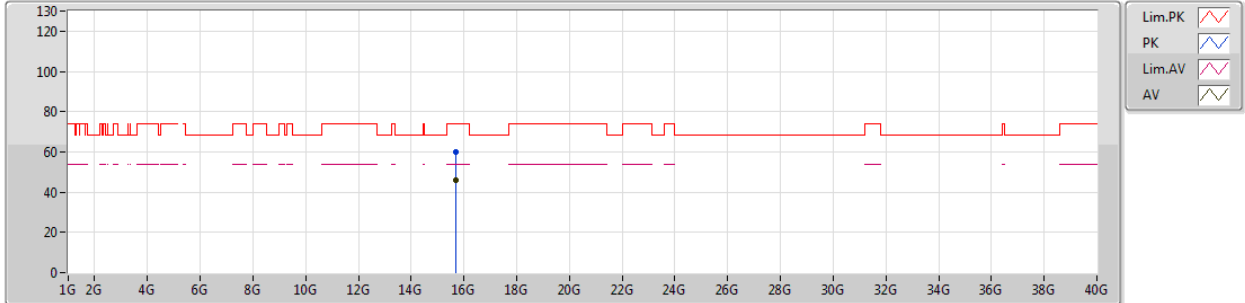

EUT_Z_2TX
Setting 35
06-W-3
FSP

Type	Freq	Level	Limit	Margin	Factor	Dist	Condition	Azimuth	Height	Comments
	(Hz)	(dBuV/m)	(dBuV/m)	(dB)	(dB)	(m)		(°)	(m)	
PK	15.68568G	59.96	74.00	-14.04	16.98	3	Vertical	71	2.14	-
AV	15.68586G	46.20	54.00	-7.80	16.98	3	Vertical	71	2.14	-

802.11ac VHT40-BF_Nss1,(MCS0)_2TX

28/11/2018

5230MHz_TX

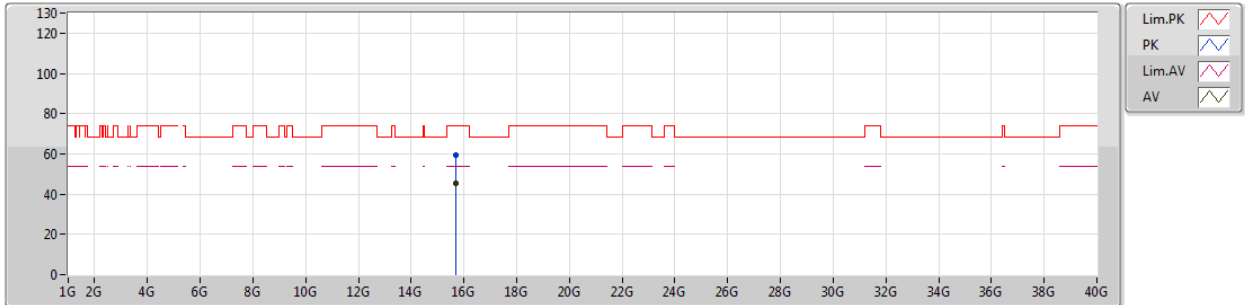

EUT_Z_2TX
Setting 35
06-W-3
FSP

Type	Freq (Hz)	Level (dBuV/m)	Limit (dBuV/m)	Margin (dB)	Factor (dB)	Dist (m)	Condition	Azimuth (°)	Height (m)	Comments
PK	15.68934G	59.38	74.00	-14.62	16.97	3	Horizontal	98	1.50	-
AV	15.675G	45.48	54.00	-8.52	16.99	3	Horizontal	98	1.50	-



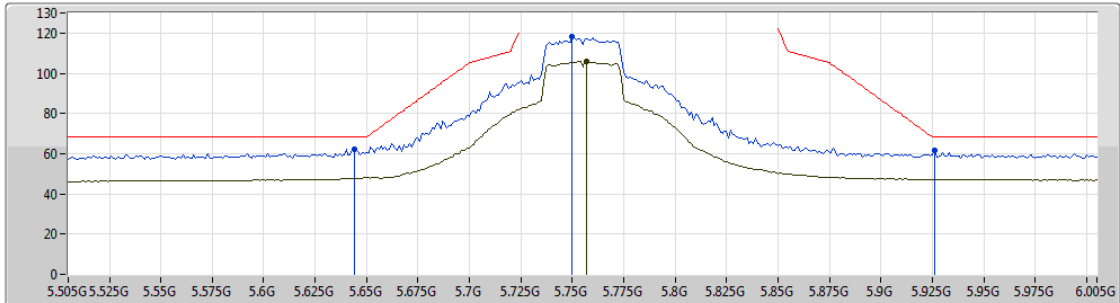

802.11ac VHT40-BF_Nss1,(MCS0)_2TX

28/11/2018

5755MHz_TX



Legend for the spectrum plot:

- Lim.PK 
- PK 
- Lim.AV 
- AV 

EUT_Z_2TX
Setting 35
06-W-3-10
FSP

Type	Freq (Hz)	Level (dBuV/m)	Limit (dBuV/m)	Margin (dB)	Factor (dB)	Dist (m)	Condition	Azimuth (°)	Height (m)	Comments
PK	5.644G	62.31	68.20	-5.89	8.02	3	Vertical	356	1.98	-
PK	5.75G	118.21	Inf	-Inf	8.19	3	Vertical	356	1.98	-
AV	5.75G	106.04	Inf	-Inf	8.20	3	Vertical	356	1.98	-
PK	5.926G	61.53	68.20	-6.67	8.56	3	Vertical	356	1.98	-

802.11ac VHT40-BF_Nss1,(MCS0)_2TX

28/11/2018

5755MHz_TX

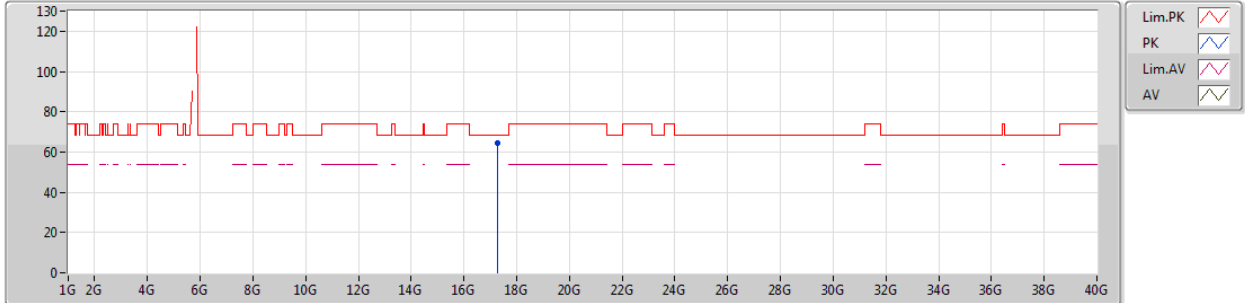

EUT_Z_2TX
Setting 35
06-W-3
FSP

Type	Freq	Level	Limit	Margin	Factor	Dist	Condition	Azimuth	Height	Comments
	(Hz)	(dBuV/m)	(dBuV/m)	(dB)	(dB)	(m)		(°)	(m)	
PK	17.25384G	64.42	68.20	-3.78	21.41	3	Vertical	260	1.89	-

802.11ac VHT40-BF_Nss1,(MCS0)_2TX

28/11/2018

5755MHz_TX

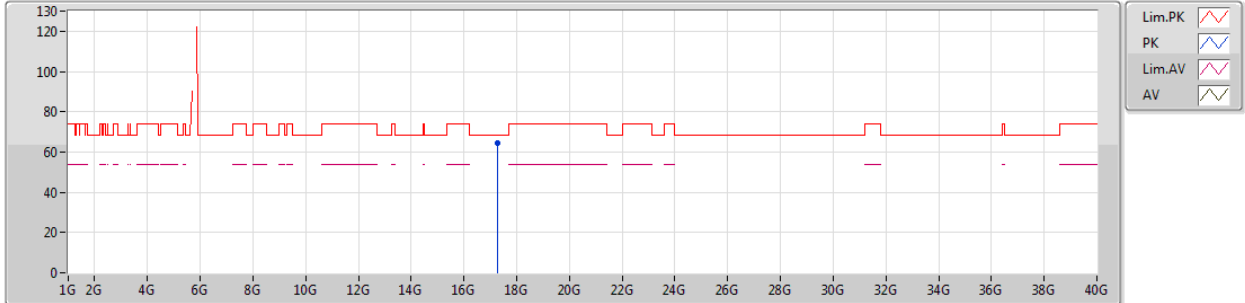

EUT_Z_2TX
Setting 35
06-W-3
FSP

Type	Freq (Hz)	Level (dBuV/m)	Limit (dBuV/m)	Margin (dB)	Factor (dB)	Dist (m)	Condition	Azimuth (°)	Height (m)	Comments
PK	17.25792G	64.17	68.20	-4.03	21.43	3	Horizontal	3	2.90	-

802.11ac VHT40-BF_Nss1,(MCS0)_2TX

28/11/2018

5795MHz_TX

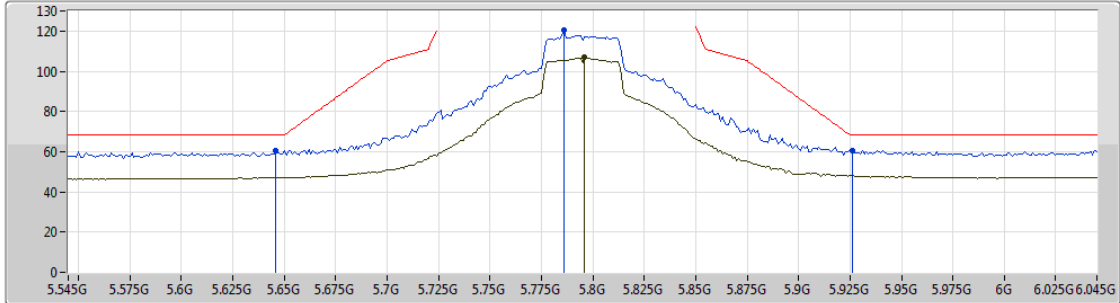

Lim.PK
 PK
 Lim.AV
 AV

EUT_Z_2TX
Setting 35
06-W-3-10
FSP

Type	Freq (Hz)	Level (dBuV/m)	Limit (dBuV/m)	Margin (dB)	Factor (dB)	Dist (m)	Condition	Azimuth (°)	Height (m)	Comments
PK	5.646G	60.40	68.20	-7.80	8.02	3	Vertical	6	2.06	-
PK	5.786G	120.34	Inf	-Inf	8.25	3	Vertical	6	2.06	-
AV	5.796G	106.75	Inf	-Inf	8.26	3	Vertical	6	2.06	-
PK	5.926G	60.62	68.20	-7.58	8.56	3	Vertical	6	2.06	-

802.11ac VHT40-BF_Nss1,(MCS0)_2TX

28/11/2018

5795MHz_TX

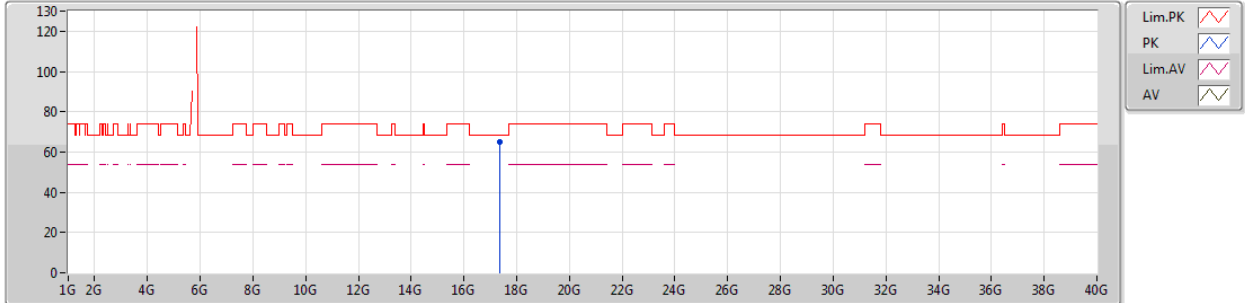

EUT_Z_2TX
Setting 35
06-W-3
FSP

Type	Freq (Hz)	Level (dBuV/m)	Limit (dBuV/m)	Margin (dB)	Factor (dB)	Dist (m)	Condition	Azimuth (°)	Height (m)	Comments
PK	17.37144G	65.15	68.20	-3.05	21.88	3	Vertical	10	1.05	-

802.11ac VHT40-BF_Nss1,(MCS0)_2TX

28/11/2018

5795MHz_TX

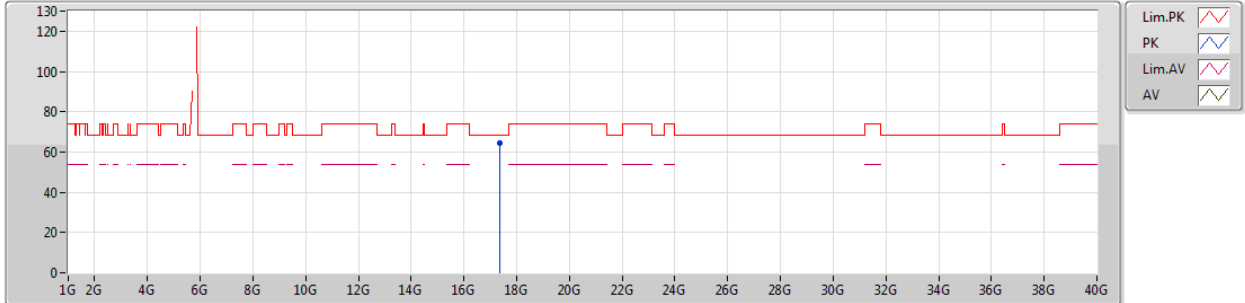

EUT_Z_2TX
Setting 35
06-W-3
FSP

Type	Freq (Hz)	Level (dBuV/m)	Limit (dBuV/m)	Margin (dB)	Factor (dB)	Dist (m)	Condition	Azimuth (°)	Height (m)	Comments
PK	17.3763G	64.64	68.20	-3.56	21.91	3	Horizontal	68	2.89	-

802.11ac VHT80-BF_Nss1,(MCS0)_2TX

28/11/2018

5210MHz_TX

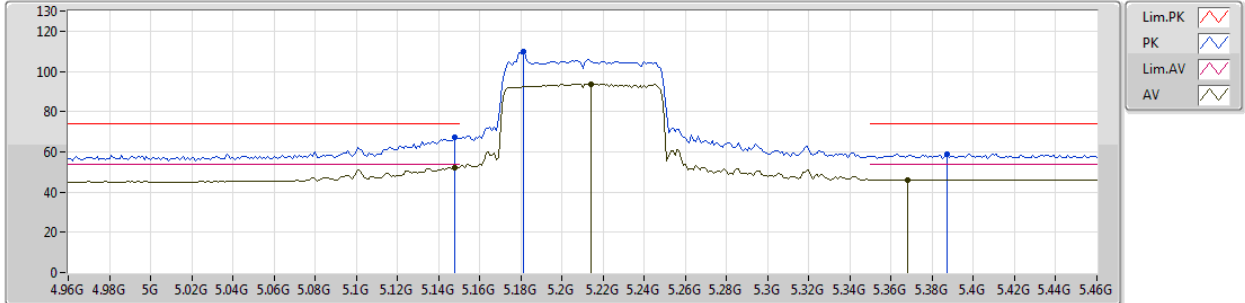

EUT_Z_2TX
Setting 15
06-W-3-10
FSP

Type	Freq (Hz)	Level (dBuV/m)	Limit (dBuV/m)	Margin (dB)	Factor (dB)	Dist (m)	Condition	Azimuth (°)	Height (m)	Comments
PK	5.148G	67.12	74.00	-6.88	7.27	3	Vertical	322	2.02	-
AV	5.148G	52.31	54.00	-1.69	7.27	3	Vertical	322	2.02	-
PK	5.181G	109.82	Inf	-Inf	7.33	3	Vertical	322	2.02	-
AV	5.214G	93.85	Inf	-Inf	7.38	3	Vertical	322	2.02	-
PK	5.387G	58.82	74.00	-15.18	7.59	3	Vertical	322	2.02	-
AV	5.368G	46.19	54.00	-7.81	7.57	3	Vertical	322	2.02	-

802.11ac VHT80-BF_Nss1,(MCS0)_2TX

28/11/2018

5210MHz_TX

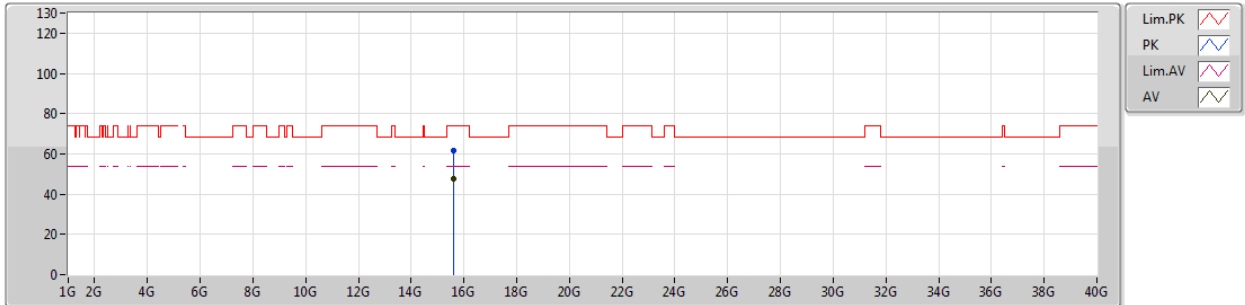

EUT_Z_2TX
Setting 15
06-W-3
FSP

Type	Freq	Level	Limit	Margin	Factor	Dist	Condition	Azimuth	Height	Comments
	(Hz)	(dBuV/m)	(dBuV/m)	(dB)	(dB)	(m)		(°)	(m)	
PK	15.6204G	61.56	74.00	-12.44	17.11	3	Vertical	145	1.50	-
AV	15.6174G	47.47	54.00	-6.53	17.12	3	Vertical	145	1.50	-

802.11ac VHT80-BF_Nss1,(MCS0)_2TX

28/11/2018

5210MHz_TX

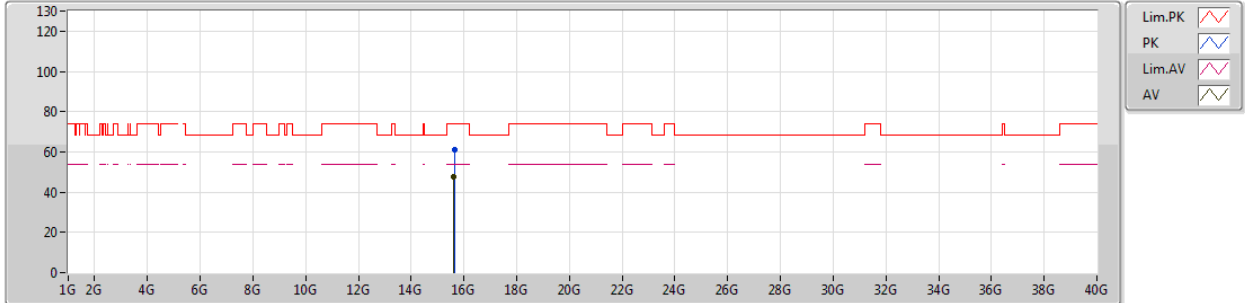

EUT_Z_2TX
Setting 15
06-W-3
FSP

Type	Freq	Level	Limit	Margin	Factor	Dist	Condition	Azimuth	Height	Comments
	(Hz)	(dBuV/m)	(dBuV/m)	(dB)	(dB)	(m)		(°)	(m)	
PK	15.63144G	61.31	74.00	-12.69	17.08	3	Horizontal	173	1.50	-
AV	15.615G	47.48	54.00	-6.52	17.12	3	Horizontal	173	1.50	-

802.11ac VHT80-BF_Nss1,(MCS0)_2TX

28/11/2018

5775MHz_TX

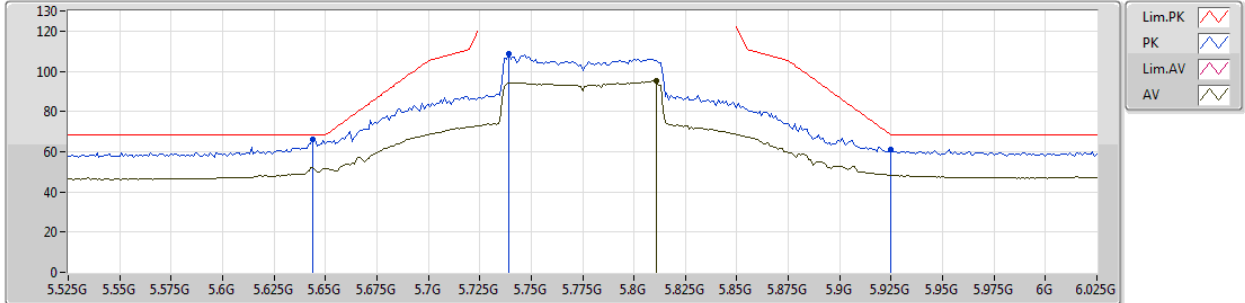

EUT_Z_2TX
Setting 28
06-W-3-10
FSP

Type	Freq (Hz)	Level (dBuV/m)	Limit (dBuV/m)	Margin (dB)	Factor (dB)	Dist (m)	Condition	Azimuth (°)	Height (m)	Comments
PK	5.644G	65.99	68.20	-2.21	8.02	3	Vertical	360	2.02	-
PK	5.739G	108.61	Inf	-Inf	8.16	3	Vertical	360	2.02	-
AV	5.811G	95.17	Inf	-Inf	8.30	3	Vertical	360	2.02	-
PK	5.925G	61.28	68.20	-6.92	8.56	3	Vertical	360	2.02	-

802.11ac VHT80-BF_Nss1,(MCS0)_2TX

28/11/2018

5775MHz_TX

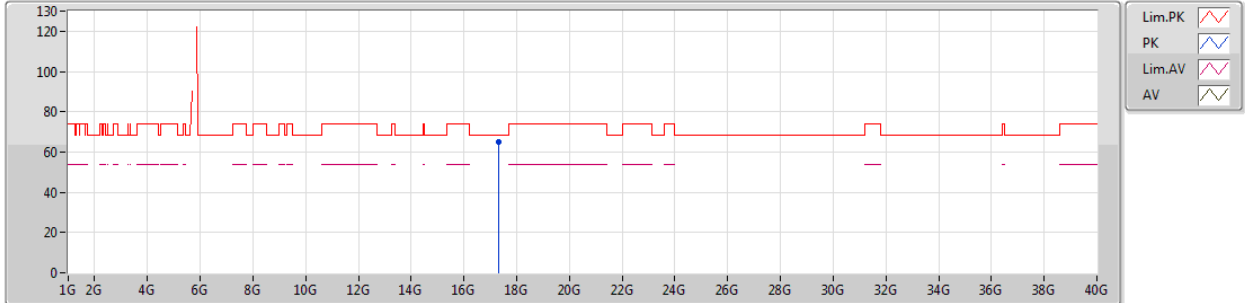

EUT_Z_2TX
Setting 28
06-W-3
FSP

Type	Freq	Level	Limit	Margin	Factor	Dist	Condition	Azimuth	Height	Comments
	(Hz)	(dBuV/m)	(dBuV/m)	(dB)	(dB)	(m)		(°)	(m)	
PK	17.32488G	64.85	68.20	-3.35	21.70	3	Vertical	163	2.60	-

802.11ac VHT80-BF_Nss1,(MCS0)_2TX

28/11/2018

5775MHz_TX

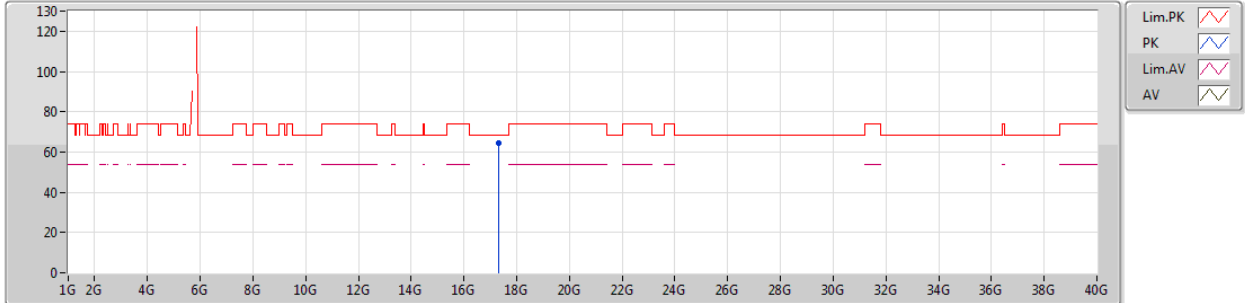

EUT_Z_2TX
Setting 28
06-W-3
FSP

Type	Freq	Level	Limit	Margin	Factor	Dist	Condition	Azimuth	Height	Comments
	(Hz)	(dBuV/m)	(dBuV/m)	(dB)	(dB)	(m)		(°)	(m)	
PK	17.3265G	64.49	68.20	-3.71	21.71	3	Horizontal	315	2.88	-

