



RADIO TEST REPORT

FCC ID : 2AYRA-03795
Equipment : Linksys Velop Micro-Mesh 6
Brand Name : LINKSYS
Model Name : LN1200, LN1210, LN1215
Applicant : Linksys USA, Inc.
121 Theory, Irvine, CA. 92617, USA
Standard : 47 CFR FCC Part 15.247

The product was received on Aug. 09, 2023, and testing was started from Aug. 14, 2023 and completed on Oct. 12, 2023. We, Sporton International Inc. Hsinchu Laboratory, would like to declare that the tested sample has been evaluated in accordance with the procedures given in ANSI C63.10-2013 and shown compliance with the applicable technical standards.

The test results in this report apply exclusively to the tested model / sample. Without written approval of Sporton International Inc. Hsinchu Laboratory, the test report shall not be reproduced except in full.

Approved by: Sam Chen

Sporton International Inc. Hsinchu Laboratory

No.8, Ln. 724, Bo'ai St., Zhubei City, Hsinchu County 302010, Taiwan (R.O.C.)



Table of Contents

History of this test report.....3

Summary of Test Result.....4

1 General Description5

1.1 Information.....5

1.2 Applicable Standards8

1.3 Testing Location Information8

1.4 Measurement Uncertainty8

2 Test Configuration of EUT9

2.1 Test Channel Mode9

2.2 The Worst Case Measurement Configuration10

2.3 EUT Operation during Test11

2.4 Accessories11

2.5 Support Equipment.....12

2.6 Test Setup Diagram13

3 Transmitter Test Result15

3.1 AC Power-line Conducted Emissions15

3.2 DTS Bandwidth17

3.3 Maximum Conducted Output Power18

3.4 Power Spectral Density21

3.5 Emissions in Non-restricted Frequency Bands23

3.6 Emissions in Restricted Frequency Bands.....24

4 Test Equipment and Calibration Data28

Appendix A. Test Results of AC Power-line Conducted Emissions

Appendix B. Test Results of DTS Bandwidth

Appendix C. Test Results of Maximum Conducted Output Power

Appendix D. Test Results of Power Spectral Density

Appendix E. Test Results of Emissions in Non-restricted Frequency Bands

Appendix F. Test Results of Emissions in Restricted Frequency Bands

Appendix G. Test Photos

Photographs of EUT v01



History of this test report

Report No.	Version	Description	Issued Date
FR380908AB	01	Initial issue of report	Dec. 01, 2023



Summary of Test Result

Report Clause	Ref Std. Clause	Test Items	Result (PASS/FAIL)	Remark
1.1.2	15.203	Antenna Requirement	PASS	-
3.1	15.207	AC Power-line Conducted Emissions	PASS	-
3.2	15.247(a)	DTS Bandwidth	PASS	-
3.3	15.247(b)	Maximum Conducted Output Power	PASS	-
3.4	15.247(e)	Power Spectral Density	PASS	-
3.5	15.247(d)	Emissions in Non-restricted Frequency Bands	PASS	-
3.6	15.247(d)	Emissions in Restricted Frequency Bands	PASS	-

Conformity Assessment Condition:

1. The test results (PASS/FAIL) with all measurement uncertainty excluded are presented against the regulation limits or in accordance with the requirements stipulated by the applicant/matrixufacturer who shall bear all the risks of non-compliance that may potentially occur if measurement uncertainty is taken into account.
2. The measurement uncertainty please refer to each test result in the chapter "Measurement Uncertainty".

Disclaimer:

The product specifications of the EUT presented in the test report that may affect the test assessments are declared by the manufacturer who shall take full responsibility for the authenticity.

Reviewed by: **Sam Chen**

Report Producer: **Lavender Zeng**



1 General Description

1.1 Information

1.1.1 RF General Information

Frequency Range (MHz)	Bluetooth Mode	Ch. Frequency (MHz)	Channel Number
2400-2483.5	LE	2402-2480	0-39 [40]

Band	Mode	BWch (MHz)	Nant
2.4-2.4835GHz	BT-LE(1Mbps)	1.0	1TX
2.4-2.4835GHz	BT-LE(2Mbps)	2.0	1TX

Note:

- ♦ Bluetooth LE uses a GFSK modulation.
- ♦ BWch is the nominal channel bandwidth.

1.1.2 Antenna Information

Ant.	Port			Brand	Model Name	Antenna Type	Connector	Gain (dBi)
	2.4GHz	5GHz	Bluetooth					
1	2	1	-	Galtronics	02102140-07935C1	PCB Antenna	U.FL	Note 1
2	1	2	-	Galtronics	02102140-07935C2	PCB Antenna	U.FL	
3	-	-	1	Gemtek	WRTQ-387AX	Printed Antenna	N/A	

Note 1:

Ant.	Gain (dBi)					
	2.4GHz	5GHz UNII 1	5GHz UNII 2A	5GHz UNII 2C	5GHz UNII 3	Bluetooth
1	3.35	4.90	4.90	4.92	4.92	-
2	3.72	4.70	4.70	4.79	4.79	-
3	-	-	-	-	-	2.82

Note 2: The above information was declared by manufacturer.



Note 3: Directional gain information

Type	Maximum Output Power	Power Spectral Density
Non-BF	Directional gain = Max.gain + array gain. For power measurements on IEEE 802.11 devices Array Gain = 0 dB (i.e., no array gain) for N ANT ≤ 4	$DirectionalGain = 10 \cdot \log \left[\frac{\sum_{j=1}^{N_{ANT}} \left[\sum_{k=1}^{N_{ANT}} \xi_{j,k} \right]^2}{N_{ANT}} \right]$
BF	$DirectionalGain = 10 \cdot \log \left[\frac{\sum_{j=1}^{N_{ANT}} \left[\sum_{k=1}^{N_{ANT}} \xi_{j,k} \right]^2}{N_{ANT}} \right]$	$DirectionalGain = 10 \cdot \log \left[\frac{\sum_{j=1}^{N_{ANT}} \left[\sum_{k=1}^{N_{ANT}} \xi_{j,k} \right]^2}{N_{ANT}} \right]$

Ex.

Directional Gain (NSS1) formula :

$$DirectionalGain = 10 \cdot \log \left[\frac{\sum_{j=1}^{N_{ANT}} \left[\sum_{k=1}^{N_{ANT}} \xi_{j,k} \right]^2}{N_{ANT}} \right]$$

$$NSS1(g1,1) = 10^{G1/20} ; NSS1(g1,2) = 10^{G2/20} ;$$

$$g_{j,k} = (NSS1(g1,1) + NSS1(g1,2))^2$$

$$DG = 10 \log[(NSS1(g1,1) + NSS1(g1,2))^2 / N_{ANT}] \Rightarrow 10 \log[(10^{G1/20} + 10^{G2/20})^2 / N_{ANT}]$$

Where ;

2.4G G1= 3.35 dBi ; G2= 3.72 dBi ;DG= 6.55dBi

5G UNII-1 G1= 4.9 dBi ; G2= 4.7 dBi ;DG= 7.81dBi

5G UNII-2A G1= 4.9 dBi ; G2= 4.7 dBi ;DG= 7.81dBi

5G UNII-2C G1= 4.92 dBi ; G2= 4.79 dBi ;DG= 7.87dBi

5G UNII-3 G1= 4.92 dBi ; G2= 4.79 dBi ;DG= 7.87dBi

Note 4: For 2.4GHz function:

For IEEE 802.11b/g/n/VHT/ax (2TX/2RX):

Port 1 and Port 2 can be used as transmitting/receiving antenna.

Port 1 and Port 2 could transmit/receive simultaneously.

For 5GHz function:

For IEEE 802.11a/n/ac/ax (2TX/2RX):

Port 1 and Port 2 can be used as transmitting/receiving antenna.

Port 1 and Port 2 could transmit/receive simultaneously.

For Bluetooth function:

For Bluetooth mode (1TX/1RX):

Only Port 1 can be use as transmit and receive antenna.



1.1.3 Mode Test Duty Cycle

Mode	DC	DCF(dB)	T(s)	VBW(Hz) ≥ 1/T
BT-LE(1Mbps)	0.628	2.02	393.75u	3k
BT-LE(2Mbps)	0.335	4.75	210u	10k

Note:

- ◆ DC is Duty Cycle.
- ◆ DCF is Duty Cycle Factor.

1.1.4 EUT Operational Condition

EUT Power Type	From Power Adapter			
Function	<input checked="" type="checkbox"/> Point-to-multipoint	<input type="checkbox"/> Point-to-point		
Test Software Version	QRCT 4.0.210.0			
Support Mode	<input checked="" type="checkbox"/> LE 1M PHY: 1 Mb/s			
	<input type="checkbox"/> LE Coded PHY (S=2): 500 Kb/s			
	<input type="checkbox"/> LE Coded PHY (S=8): 125 Kb/s			
	<input checked="" type="checkbox"/> LE 2M PHY: 2 Mb/s			

Note: The above information was declared by manufacturer.

1.1.5 Table for Multiple Listing

The model names in the following table are all refer to the identical product.

Model Name	Description
LN1200	All the models are identical, the difference model served as marketing strategy.
LN1210	
LN1215	

Note 1: From the above models, model: LN1200 was selected as representative model for the test and its data was recorded in this report.

Note 2: The above information was declared by manufacturer.



1.2 Applicable Standards

According to the specifications of the manufacturer, the EUT must comply with the requirements of the following standards:

- ♦ 47 CFR FCC Part 15.247
- ♦ ANSI C63.10-2013

The following reference test guidance is not within the scope of accreditation of TAF.

- ♦ FCC KDB 558074 D01 v05r02
- ♦ FCC KDB 414788 D01 v01r01

1.3 Testing Location Information

Testing Location Information	
Test Lab. : Sporton International Inc. Hsinchu Laboratory	
Hsinchu (TAF: 3787)	ADD: No.8, Ln. 724, Bo'ai St., Zhubei City, Hsinchu County 302010, Taiwan (R.O.C.) TEL: 886-3-656-9065 FAX: 886-3-656-9085 Test site Designation No. TW3787 with FCC. Conformity Assessment Body Identifier (CABID) TW3787 with ISED.

Test Condition	Test Site No.	Test Engineer	Test Environment (°C / %)	Test Date
RF Conducted	TH03-CB	Nyle Chang	24.2-25.3 / 57-69	Aug. 14, 2023 ~ Sep. 26, 2023
Radiated (Below 1GHz)	03CH01-CB	Mark Hsu	22.4-23.5 / 55-58	Aug. 15, 2023 ~ Oct. 12, 2023
Radiated (Above 1GHz)	03CH02-CB	Mark Hsu	21-22 / 55-58	Aug. 15, 2023 ~ Oct. 12, 2023
	03CH06-CB		22.7-23.8 / 56-59	
AC Conduction	CO01-CB	Elvin Yeh	22-23 / 55-56	Sep. 28, 2023

1.4 Measurement Uncertainty

ISO/IEC 17025 requires that an estimate of the measurement uncertainties associated with the emissions test results be included in the report. The measurement uncertainties given below are based on a 95% confidence level (based on a coverage factor (k=2))

Test Items	Uncertainty	Remark
Conducted Emission (150kHz ~ 30MHz)	3.4 dB	Confidence levels of 95%
Radiated Emission (9kHz ~ 30MHz)	3.7 dB	Confidence levels of 95%
Radiated Emission (30MHz ~ 1,000MHz)	5.1 dB	Confidence levels of 95%
Radiated Emission (1GHz ~ 18GHz)	4.1 dB	Confidence levels of 95%
Radiated Emission (18GHz ~ 40GHz)	4.2 dB	Confidence levels of 95%
Conducted Emission	3.1 dB	Confidence levels of 95%
Output Power Measurement	0.8 dB	Confidence levels of 95%
Power Density Measurement	3.1 dB	Confidence levels of 95%
Bandwidth Measurement	2.2%	Confidence levels of 95%



2 Test Configuration of EUT

2.1 Test Channel Mode

Mode	Power Setting
BT-LE(1Mbps)	-
2402MHz	default
2404MHz	default
2440MHz	default
2478MHz	default
2480MHz	default
BT-LE(2Mbps)	-
2402MHz	default
2404MHz	default
2440MHz	default
2478MHz	default
2480MHz	default



2.2 The Worst Case Measurement Configuration

The Worst Case Mode for Following Conformance Tests	
Tests Item	AC power-line conducted emissions
Condition	AC power-line conducted measurement for line and neutral Test Voltage: 120Vac / 60Hz
Operating Mode	Normal Link
1	EUT + Adapter 1
2	EUT + Adapter 2
3	EUT + Adapter 3
For operating mode 1 is the worst case and it was record in this test report.	

The Worst Case Mode for Following Conformance Tests	
Tests Item	DTS Bandwidth Maximum Conducted Output Power Power Spectral Density Emissions in Non-restricted Frequency Bands
Test Condition	Conducted measurement at transmit chains

The Worst Case Mode for Following Conformance Tests	
Tests Item	Emissions in Restricted Frequency Bands
Test Condition	Radiated measurement If EUT consist of multiple antenna assembly (multiple antenna are used in EUT regardless of spatial multiplexing MIMO configuration), the radiated test should be performed with highest antenna gain of each antenna type.
Operating Mode < 1GHz	CTX
Afrer evaluating, "Z axis" generated the worst test result, so the measurement will follow this same test configuration.	
1	EUT in Z axis + WLAN 2.4GHz + Adapter 1
2	EUT in Z axis + WLAN 2.4GHz + Adapter 2
3	EUT in Z axis + WLAN 2.4GHz + Adapter 3
Mode 1 ha been evaluated to be the worst case between Mode 1~3, thus measurement for Mode 4~5 will follow this same test mode.	
4	EUT in Z axis + WLAN 5GHz + Adapter 1
5	EUT in Z axis + Bluetooth + Adapter 1
For operating mode 1 is the worst case and it was record in this test report.	
Operating Mode > 1GHz	CTX
Afrer evaluating, "Z axis" generated the worst test result, so the measurement will follow this same test configuration.	
1	EUT in Z axis



The Worst Case Mode for Following Conformance Tests	
Tests Item	Simultaneous Transmission Analysis - Co-location RF Exposure Evaluation
Operating Mode	
1	Bluetooth + WLAN 2.4GHz + WLAN 5GHz
Refer to Sporton Test Report No.: FA380908 for Co-location RF Exposure Evaluation.	

2.3 EUT Operation during Test

For CTX Mode:

The EUT was programmed to be in continuously transmitting mode.

For Normal Link:

During the test, the EUT operation to normal function.

2.4 Accessories

Accessories			
Power	Brand	Model	Rating
Adapter 1 (Fixed plug)	Ktec	KSA-18W-050300VU	Input: 100-240V ~ 50/60Hz, 0.5A Output: 5.0V, 3.0A
Adapter 2 (Fixed plug)	MOSO	MSA-C3000IC5.0-18P-US	Input: 100-240V ~ 50/60Hz, 0.7A max. Output: 5.0V, 3A
Adapter 3 (Removable plug)	Ktec	KSA-18W-050300D5	Input: 100-240V ~ 50/60Hz, 0.5A Output: 5.0V, 3.0A, 15.0W
Others			
Plug*1 (for Adapter 3 use)			



2.5 Support Equipment

For AC Conduction:

Support Equipment				
No.	Equipment	Brand Name	Model Name	FCC ID
A	Device AP	LINKSYS	ELM	N/A
B	Device NB	DELL	E6430	N/A
C	2.4G NB	DELL	E6430	N/A
D	5G NB	DELL	E6430	N/A
E	Smart phone	Samsung	Galaxy J2	N/A

For Radiated and RF Conducted:

Support Equipment				
No.	Equipment	Brand Name	Model Name	FCC ID
A	NB	DELL	E4300	N/A
B	Test Fixture	Linksys	ESK-B21-7400R	N/A
C	Test Fixture	Linksys	N/A	N/A

2.6 Test Setup Diagram

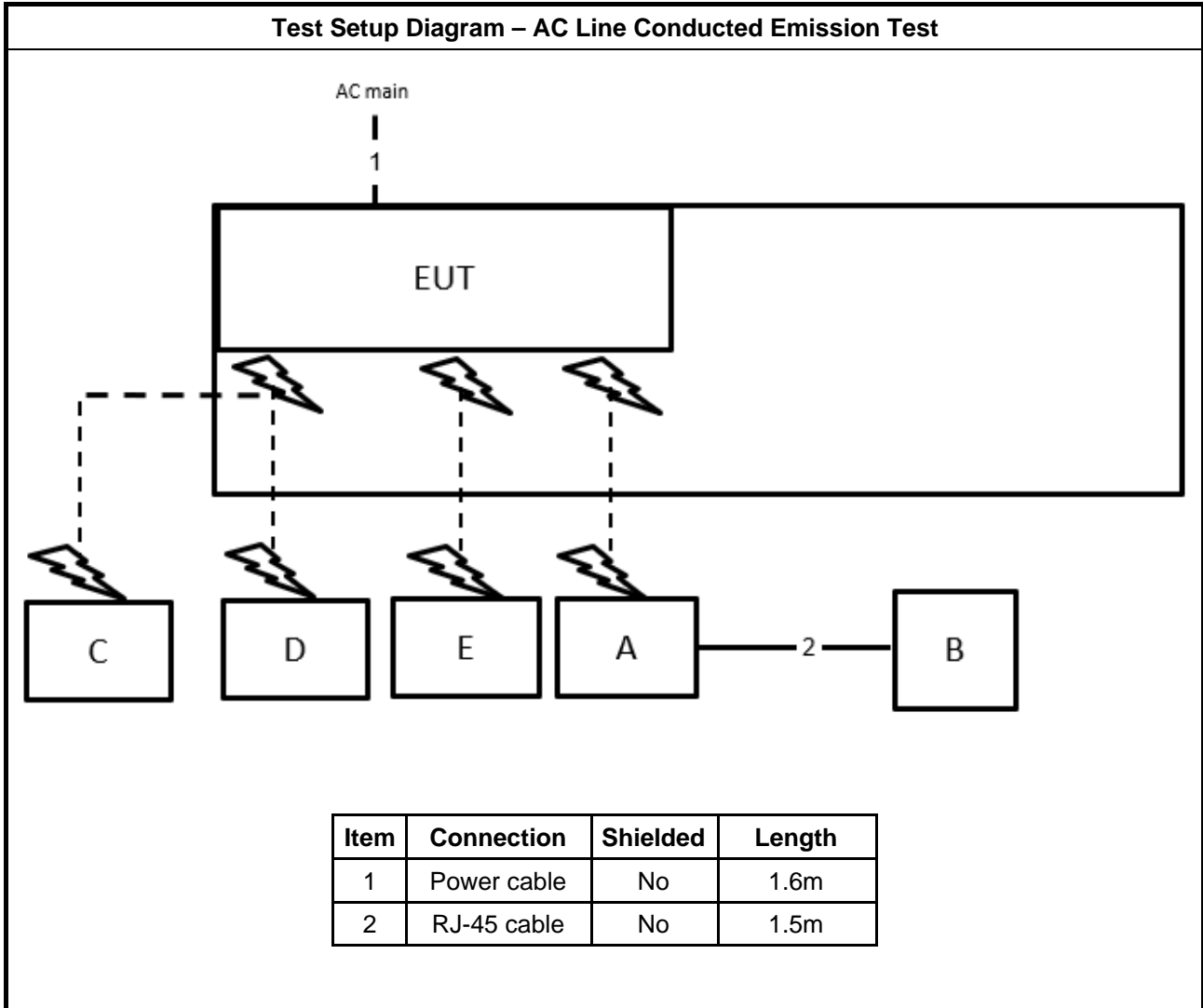

Test Setup Diagram - Radiated Test

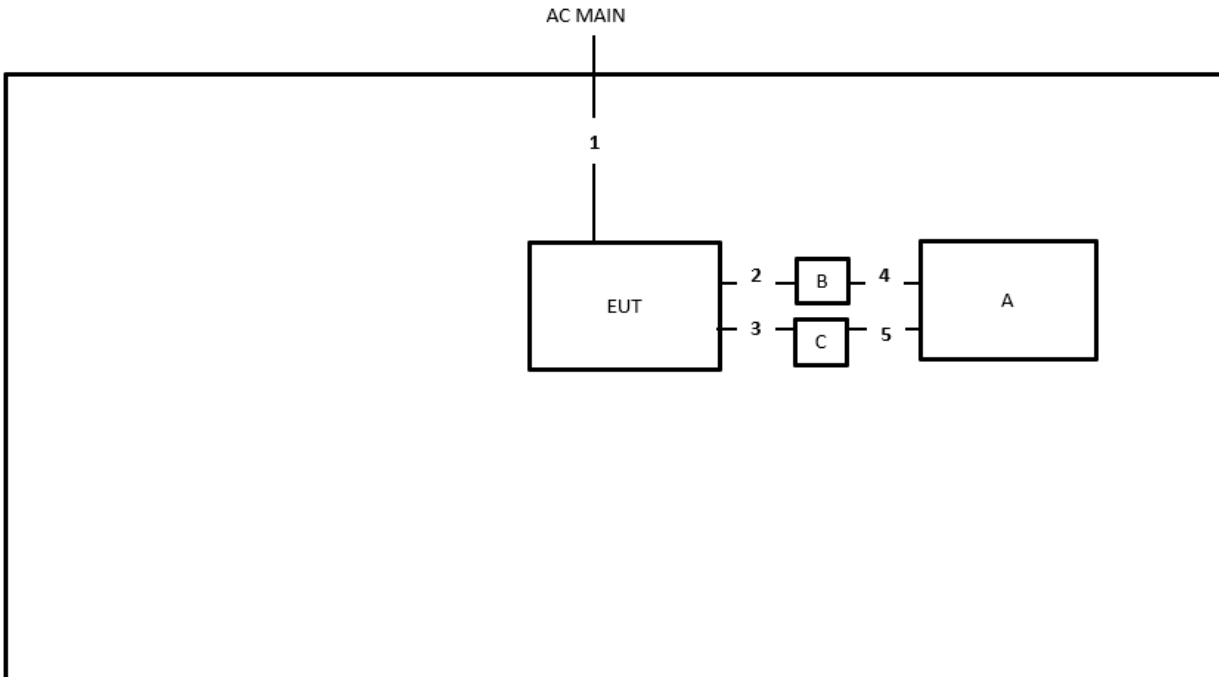

Item	Connection	Shielded	Length
1	Power cable	No	1.6m
2	Console cable	No	0.03m
3	Console cable	No	0.03m
4	RJ-45 cable	No	1m
5	USB cable	Yes	1m



3 Transmitter Test Result

3.1 AC Power-line Conducted Emissions

3.1.1 AC Power-line Conducted Emissions Limit

AC Power-line Conducted Emissions Limit		
Frequency Emission (MHz)	Quasi-Peak	Average
0.15-0.5	66 - 56 *	56 - 46 *
0.5-5	56	46
5-30	60	50

Note 1: * Decreases with the logarithm of the frequency.

3.1.2 Measuring Instruments

Refer a test equipment and calibration data table in this test report.

3.1.3 Test Procedures

Test Method
▪ Refer as ANSI C63.10-2013, clause 6.2 for AC power-line conducted emissions.

3.1.4 Test Setup

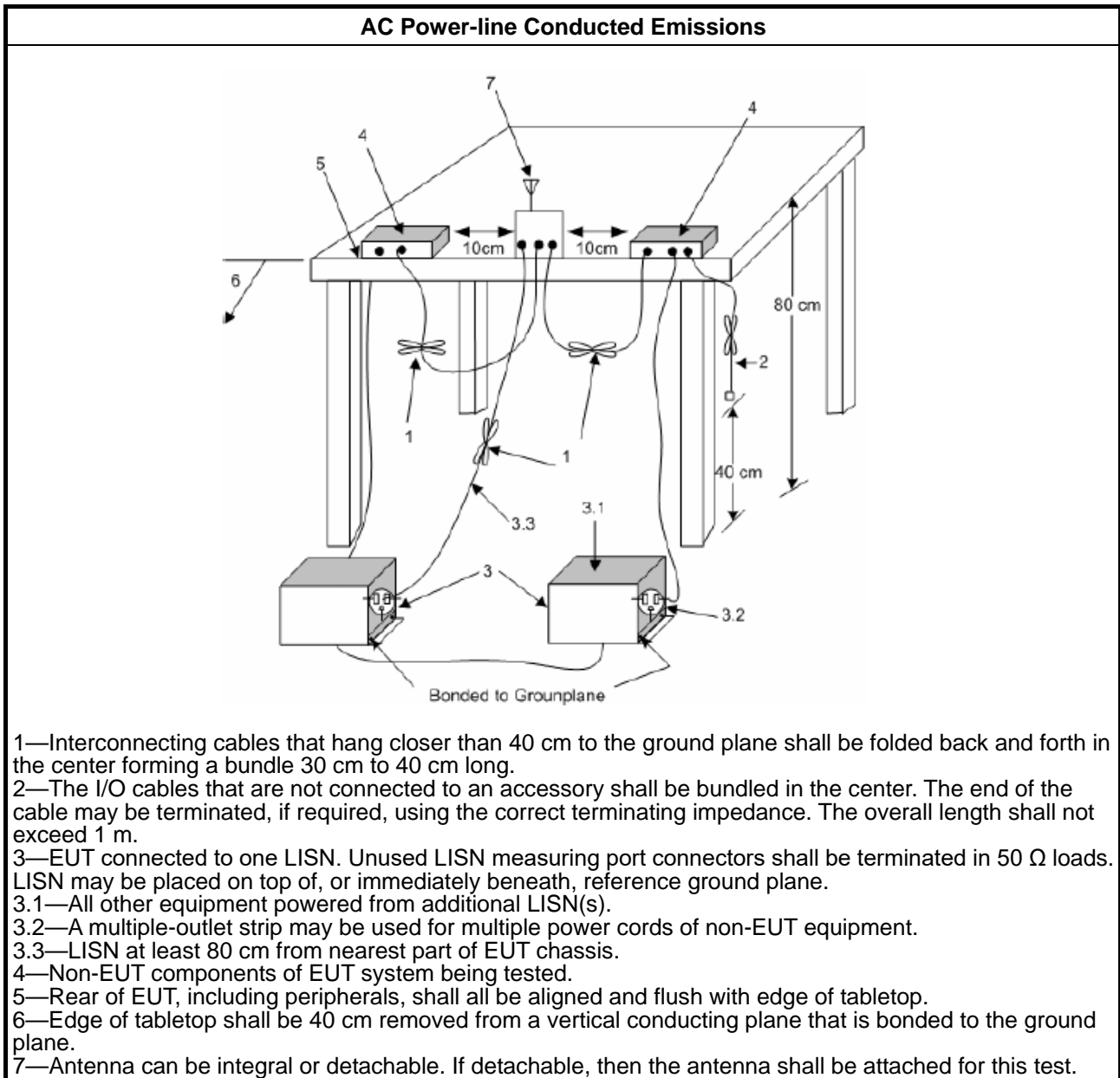

1.1.1. Measurement Results Calculation

The measured Level is calculated using:

- a. Corrected Reading: LISN Factor (LISN) + Attenuator (AT/AUX) + Cable Loss (CL) + Read Level (Raw) = Level
- b. Margin = -Limit + Level

3.1.5 Test Result of AC Power-line Conducted Emissions

Refer as Appendix A

3.2 DTS Bandwidth

3.2.1 6dB Bandwidth Limit

6dB Bandwidth Limit
Systems using digital modulation techniques:
<ul style="list-style-type: none"> ▪ 6 dB bandwidth \geq 500 kHz.

3.2.2 Measuring Instruments

Refer a test equipment and calibration data table in this test report.

3.2.3 Test Procedures

Test Method
<ul style="list-style-type: none"> ▪ For the emission bandwidth shall be measured using one of the options below:
<input checked="" type="checkbox"/> Refer as FCC KDB 558074, clause 8.2 & C63.10 clause 11.8.1 Option 1 for 6 dB bandwidth measurement.
<input type="checkbox"/> Refer as FCC KDB 558074, clause 8.2 & C63.10 clause 11.8.2 Option 2 for 6 dB bandwidth measurement.
<input type="checkbox"/> Refer as ANSI C63.10, clause 6.9.1 for occupied bandwidth testing.

3.2.4 Test Setup

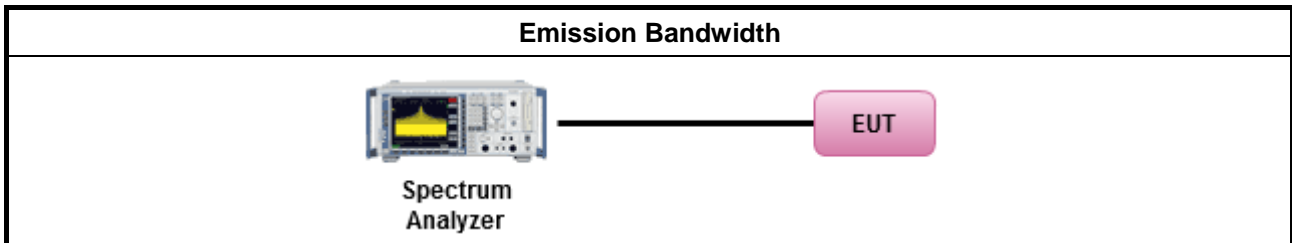

3.2.5 Test Result of Emission Bandwidth

Refer as Appendix B



3.3 Maximum Conducted Output Power

3.3.1 Maximum Conducted Output Power Limit

Maximum Conducted Output Power Limit	
	<ul style="list-style-type: none">▪ If $G_{TX} \leq 6$ dBi, then $P_{Out} \leq 30$ dBm (1 W)
	<ul style="list-style-type: none">▪ Point-to-multipoint systems (P2M): If $G_{TX} > 6$ dBi, then $P_{Out} = 30 - (G_{TX} - 6)$ dBm
	<ul style="list-style-type: none">▪ Point-to-point systems (P2P): If $G_{TX} > 6$ dBi, then $P_{Out} = 30 - (G_{TX} - 6)/3$ dBm
	<ul style="list-style-type: none">▪ Smart antenna system (SAS):
	<ul style="list-style-type: none">- Single beam: If $G_{TX} > 6$ dBi, then $P_{Out} = 30 - (G_{TX} - 6)/3$ dBm
	<ul style="list-style-type: none">- Overlap beam: If $G_{TX} > 6$ dBi, then $P_{Out} = 30 - (G_{TX} - 6)/3$ dBm
	<ul style="list-style-type: none">- Aggregate power on all beams: If $G_{TX} > 6$ dBi, then $P_{Out} = 30 - (G_{TX} - 6)/3 + 8$ dB dBm
P_{Out} = maximum peak conducted output power or maximum conducted output power in dBm, G_{TX} = the maximum transmitting antenna directional gain in dBi.	

3.3.2 Measuring Instruments

Refer a test equipment and calibration data table in this test report.



3.3.3 Test Procedures

Test Method	
<ul style="list-style-type: none"> ▪ Maximum Peak Conducted Output Power 	
	<input type="checkbox"/> Refer as FCC KDB 558074, clause 8.3.1.1 & C63.10 clause 11.9.1.1 (RBW ≥ EBW method).
	<input type="checkbox"/> Refer as FCC KDB 558074, clause 8.3.1.3 & C63.10 clause 11.9.1.3 (peak power meter).
<ul style="list-style-type: none"> ▪ Maximum Conducted Output Power 	
[duty cycle ≥ 98% or external video / power trigger]	
	<input type="checkbox"/> Refer as FCC KDB 558074, clause 8.3.2.2 & C63.10 clause 11.9.2.2.2 Method AVGSA-1.
	<input type="checkbox"/> Refer as FCC KDB 558074, clause 8.3.2.2 & C63.10 clause 11.9.2.2.3 Method AVGSA-1A. (alternative)
duty cycle < 98% and average over on/off periods with duty factor	
	<input type="checkbox"/> Refer as FCC KDB 558074, clause 8.3.2.2 & C63.10 clause 11.9.2.2.4 Method AVGSA-2.
	<input type="checkbox"/> Refer as FCC KDB 558074, clause 8.3.2.2 & C63.10 clause 11.9.2.2.5 Method AVGSA-2A (alternative)
	<input type="checkbox"/> Refer as FCC KDB 558074, clause 8.3.2.2 & C63.10 clause 11.9.2.2.6 Method AVGSA-3
	<input type="checkbox"/> Refer as FCC KDB 558074, clause 8.3.2.2 & C63.10 clause 11.9.2.2.7 Method AVGSA-3A (alternative)
Measurement using a power meter (PM)	
	<input type="checkbox"/> Refer as FCC KDB 558074, clause 8.3.2.3 & C63.10 clause 11.9.2.3.1 Method AVGPM (using an RF average power meter).
	<input checked="" type="checkbox"/> Refer as FCC KDB 558074, clause 8.3.2.3 & C63.10 clause 11.9.2.3.2 Method AVGPM-G (using an gate RF average power meter).
<ul style="list-style-type: none"> ▪ For conducted measurement. 	
	<ul style="list-style-type: none"> ▪ If the EUT supports multiple transmit chains using options given below: Refer as FCC KDB 662911, In-band power measurements. Using the measure-and-sum approach, measured all transmit ports individually. Sum the power (in linear power units e.g., mW) of all ports for each individual sample and save them.
	<ul style="list-style-type: none"> ▪ If multiple transmit chains, EIRP calculation could be following as methods: $P_{total} = P_1 + P_2 + \dots + P_n$ (calculated in linear unit [mW] and transfer to log unit [dBm]) $EIRP_{total} = P_{total} + DG$

3.3.4 Test Setup

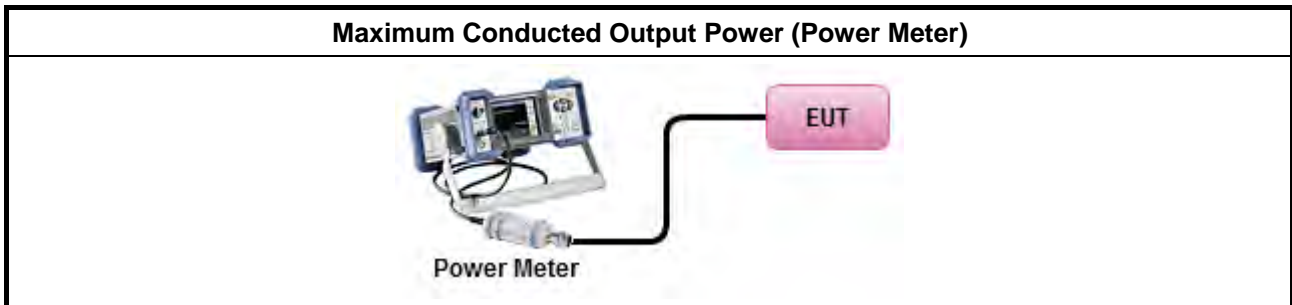

3.3.5 Test Result of Maximum Conducted Output Power

Refer as Appendix C



3.4 Power Spectral Density

3.4.1 Power Spectral Density Limit

Power Spectral Density Limit
<ul style="list-style-type: none"> Power Spectral Density (PSD) ≤ 8 dBm/3kHz

3.4.2 Measuring Instruments

Refer a test equipment and calibration data table in this test report.

3.4.3 Test Procedures

Test Method
<ul style="list-style-type: none"> Peak power spectral density procedures that the same method as used to determine the conducted output power. If maximum peak conducted output power was measured to demonstrate compliance to the output power limit, then the peak PSD procedure below (Method PKPSD) shall be used. If maximum conducted output power was measured to demonstrate compliance to the output power limit, then one of the average PSD procedures shall be used, as applicable based on the following criteria (the peak PSD procedure is also an acceptable option).
<input checked="" type="checkbox"/> Refer as FCC KDB 558074, clause 8.4 & C63.10 clause 11.10 Method Max. PSD. [duty cycle ≥ 98% or external video / power trigger]
<ul style="list-style-type: none"> For conducted measurement.
<ul style="list-style-type: none"> If The EUT supports multiple transmit chains using options given below: <ul style="list-style-type: none"> <input type="checkbox"/> Option 1: Measure and sum the spectra across the outputs. Refer as FCC KDB 662911, In-band power spectral density (PSD). Sample all transmit ports simultaneously using a spectrum analyzer for each transmit port. Where the trace bin-by-bin of each transmit port summing can be performed. (i.e., in the first spectral bin of output 1 is summed with that in the first spectral bin of output 2 and that from the first spectral bin of output 3, and so on up to the NTX output to obtain the value for the first frequency bin of the summed spectrum.). Add up the amplitude (power) values for the different transmit chains and use this as the new data trace. <input type="checkbox"/> Option 2: Measure and sum spectral maxima across the outputs. With this technique, spectra are measured at each output of the device at the required resolution bandwidth. The maximum value (peak) of each spectrum is determined. These maximum values are then summed mathematically in linear power units across the outputs. These operations shall be performed separately over frequency spans that have different out-of-band or spurious emission limits, <input type="checkbox"/> Option 3: Measure and add 10 log(N) dB, where N is the number of transmit chains. Refer as FCC KDB 662911, In-band power spectral density (PSD). Performed at each transmit chains and each transmit chains shall be compared with the limit have been reduced with 10 log(N). Or each transmit chains shall be add 10 log(N) to compared with the limit.

3.4.4 Test Setup

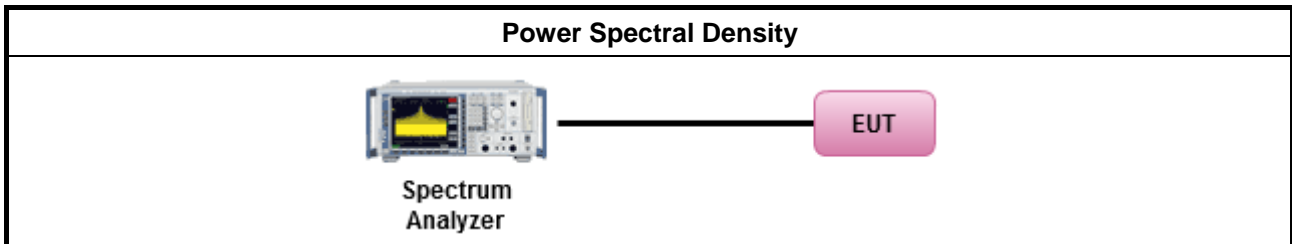

3.4.5 Test Result of Power Spectral Density

Refer as Appendix D

3.5 Emissions in Non-restricted Frequency Bands

3.5.1 Emissions in Non-restricted Frequency Bands Limit

Un-restricted Band Emissions Limit	
RF output power procedure	Limit (dBc)
Peak output power procedure	20
Average output power procedure	30

Note 1: If the peak output power procedure is used to measure the fundamental emission power to demonstrate compliance to requirements, then the peak conducted output power measured within any 100 kHz outside the authorized frequency band shall be attenuated by at least 20 dB relative to the maximum measured in-band peak PSD level.

Note 2: If the average output power procedure is used to measure the fundamental emission power to demonstrate compliance to requirements, then the power in any 100 kHz outside of the authorized frequency band shall be attenuated by at least 30 dB relative to the maximum measured in-band average PSD level.

3.5.2 Measuring Instruments

Refer a test equipment and calibration data table in this test report.

3.5.3 Test Procedures

Test Method
<ul style="list-style-type: none"> Refer as FCC KDB 558074, clause 8.5 for unwanted emissions into non-restricted bands.

3.5.4 Test Setup

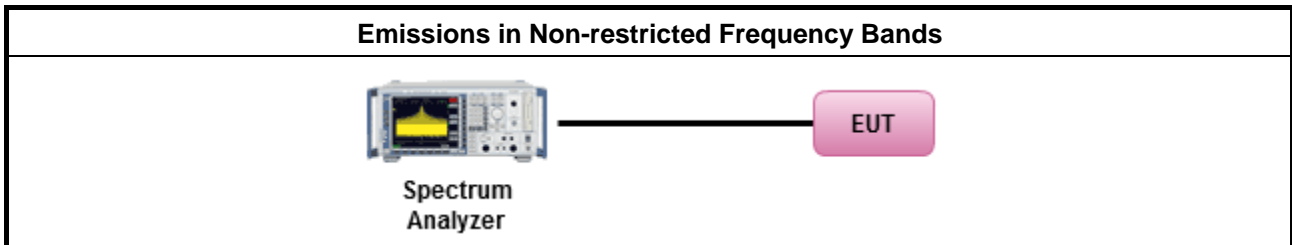

3.5.5 Test Result of Emissions in Non-restricted Frequency Bands

Refer as Appendix E



3.6 Emissions in Restricted Frequency Bands

3.6.1 Emissions in Restricted Frequency Bands Limit

Restricted Band Emissions Limit			
Frequency Range (MHz)	Field Strength (uV/m)	Field Strength (dBuV/m)	Measure Distance (m)
0.009~0.490	2400/F(kHz)	48.5 - 13.8	300
0.490~1.705	24000/F(kHz)	33.8 - 23	30
1.705~30.0	30	29	30
30~88	100	40	3
88~216	150	43.5	3
216~960	200	46	3
Above 960	500	54	3

Note 1: Test distance for frequencies at or above 30 MHz, measurements may be performed at a distance other than the limit distance provided they are not performed in the near field and the emissions to be measured can be detected by the measurement equipment. When performing measurements at a distance other than that specified, the results shall be extrapolated to the specified distance using an extrapolation factor of 20 dB/decade (inverse of linear distance for field-strength measurements, inverse of linear distance-squared for power-density measurements).

Note 2: Test distance for frequencies at below 30 MHz, measurements may be performed at a distance closer than the EUT limit distance; however, an attempt should be made to avoid making measurements in the near field. When performing measurements below 30 MHz at a closer distance than the limit distance, the results shall be extrapolated to the specified distance by either making measurements at a minimum of two or more distances on at least one radial to determine the proper extrapolation factor or by using the square of an inverse linear distance extrapolation factor (40 dB / decade). The test report shall specify the extrapolation method used to determine compliance of the EUT.

Note 3: Using the distance of 1m during the test for above 18 GHz, and the test value to correct for the distance factor at 3m.

3.6.2 Measuring Instruments

Refer a test equipment and calibration data table in this test report.



3.6.3 Test Procedures

Test Method	
<ul style="list-style-type: none"> ▪ The average emission levels shall be measured in [duty cycle \geq 98 or duty factor]. 	
<ul style="list-style-type: none"> ▪ Refer as ANSI C63.10, clause 6.10.3 band-edge testing shall be performed at the lowest frequency channel and highest frequency channel within the allowed operating band. 	
<ul style="list-style-type: none"> ▪ For the transmitter unwanted emissions shall be measured using following options below: 	
	<ul style="list-style-type: none"> ▪ Refer as FCC KDB 558074, clause 8.6 for unwanted emissions into restricted bands.
	<input type="checkbox"/> Refer as FCC KDB 558074, clause 8.6 & C63.10 clause 11.12.2.5.1(trace averaging for duty cycle \geq 98%).
	<input type="checkbox"/> Refer as FCC KDB 558074, clause 8.6 & C63.10 clause 11.12.2.5.2(trace averaging + duty factor).
	<input checked="" type="checkbox"/> Refer as FCC KDB 558074, clause 8.6 & C63.10 clause 11.12.2.5.3(Reduced VBW \geq 1/T).
	<input type="checkbox"/> Refer as ANSI C63.10, clause 11.12.2.5.3 (Reduced VBW). VBW \geq 1/T, where T is pulse time.
	<input type="checkbox"/> Refer as ANSI C63.10, clause 7.5 average value of pulsed emissions.
	<input checked="" type="checkbox"/> Refer as FCC KDB 558074, clause 8.6 & C63.10 clause 11.12.2.4 measurement procedure peak limit.
<ul style="list-style-type: none"> ▪ For the transmitter band-edge emissions shall be measured using following options below: 	
	<ul style="list-style-type: none"> ▪ Refer as FCC KDB 558074 clause 8.7 & c63.10 clause 11.13.1, When the performing peak or average radiated measurements, emissions within 2 MHz of the authorized band edge may be measured using the marker-delta method described below.
	<ul style="list-style-type: none"> ▪ Refer as FCC KDB 558074, clause 8.7 (ANSI C63.10, clause 6.10.6) for marker-delta method for band-edge measurements.
	<ul style="list-style-type: none"> ▪ Refer as FCC KDB 558074, clause 8.7 for narrower resolution bandwidth (100kHz) using the band power and summing the spectral levels (i.e., 1 MHz).
	<ul style="list-style-type: none"> ▪ For conducted unwanted emissions into restricted bands (absolute emission limits). Devices with multiple transmit chains using options given below: (1) Measure and sum the spectra across the outputs or (2) Measure and add 10 log(N) dB
	<ul style="list-style-type: none"> ▪ For FCC KDB 662911 The methodology described here may overestimate array gain, thereby resulting in apparent failures to satisfy the out-of-band limits even if the device is actually compliant. In such cases, compliance may be demonstrated by performing radiated tests around the frequencies at which the apparent failures occurred.

3.6.4 Test Setup

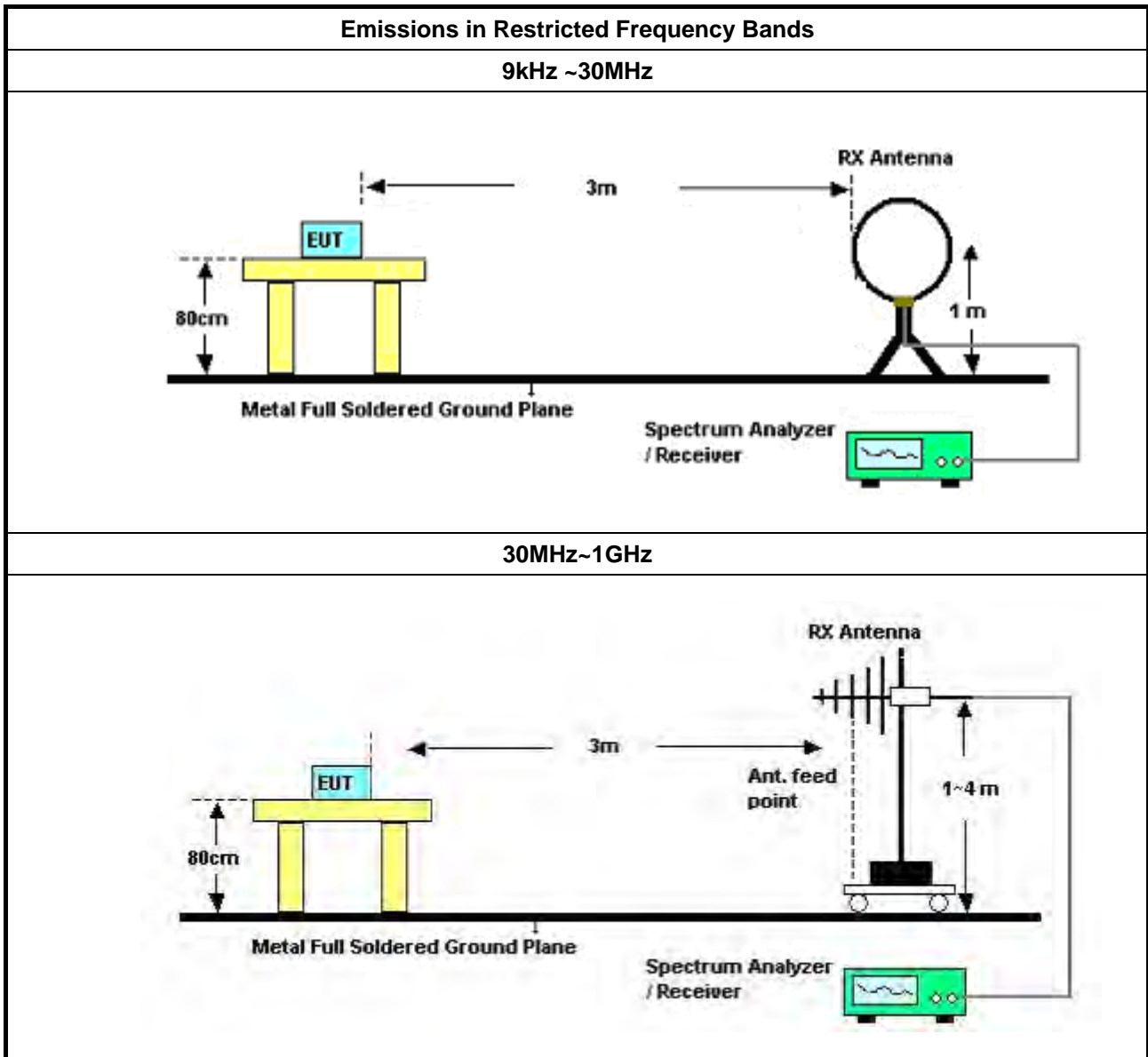

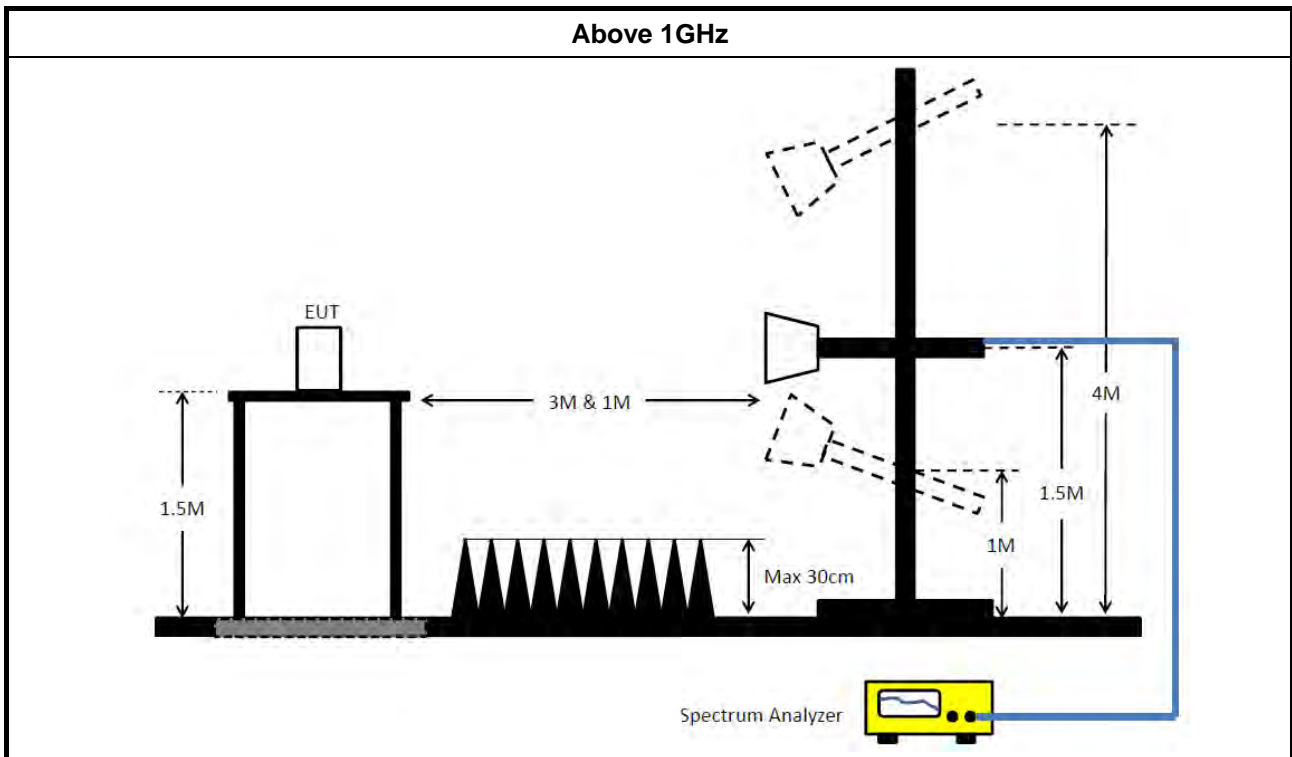

3.6.5 Measurement Results Calculation

The measured Level is calculated using:

Corrected Reading: Antenna factor (AF) + Cable loss (CL) + Read level (Raw) - Preamp factor (PA)(if applicable) = Level.

3.6.6 Emissions in Restricted Frequency Bands (Below 30MHz)

There is a comparison data of both open-field test site and alternative test site - semi-Anechoic chamber according to KDB414788 Radiated Test Site, and the result came out very similar.

All amplitude of spurious emissions that are attenuated by more than 20 dB below the permissible value has no need to be reported.

The radiated emissions were investigated from 9 kHz or the lowest frequency generated within the device, up to the 10th harmonic or 40 GHz, whichever is appropriate.

3.6.7 Test Result of Emissions in Restricted Frequency Bands

Refer as Appendix F



4 Test Equipment and Calibration Data

Instrument	Brand	Model No.	Serial No.	Characteristics	Calibration Date	Calibration Due Date	Remark
EMI Receiver	Agilent	N9038A	My52260123	9kHz ~ 8.4GHz	Feb. 20, 2023	Feb. 19, 2024	Conduction (CO01-CB)
LISN	F.C.C.	FCC-LISN-50-16-2	04083	150kHz ~ 100MHz	Feb. 16, 2023	Feb. 15, 2024	Conduction (CO01-CB)
LISN	Schwarzbeck	NSLK 8127	8127647	9kHz ~ 30MHz	Apr. 27, 2023	Apr. 26, 2024	Conduction (CO01-CB)
Pulse Limiter	Rohde&Schwarz	ESH3-Z2	100430	9kHz ~ 30MHz	Feb. 09, 2023	Feb. 08, 2024	Conduction (CO01-CB)
COND Cable	Woken	Cable	Low cable-CO01	9kHz ~ 30MHz	Oct. 18, 2022	Oct. 17, 2023	Conduction (CO01-CB)
Software	SPORTON	SENSE	V5.10	-	N.C.R.	N.C.R.	Conduction (CO01-CB)
Loop Antenna	Teseq	HLA 6120	31244	9kHz - 30 MHz	Mar. 23, 2023	Mar. 22, 2024	Radiation (03CH01-CB)
3m Semi Anechoic Chamber NSA	TDK	SAC-3M	03CH01-CB	30 MHz ~ 1 GHz	Jan. 16, 2023	Jan. 15, 2024	Radiation (03CH01-CB)
BILOG ANTENNA with 6dB Attenuator	TESEQ & EMC1	CBL6112D N-6-06	37880 & AT-N0609	20MHz ~ 2GHz	Feb. 19, 2023	Feb. 18, 2024	Radiation (03CH01-CB)
Pre-Amplifier	SGH	SGH0301	20230109-2	10M~1GHz	Jun. 23, 2023	Jun. 22, 2024	Radiation (03CH01-CB)
Signal Analyzer	R&S	FSV3044	101437	10kHz ~ 44GHz	Nov. 29, 2022	Nov. 29, 2023	Radiation (03CH01-CB)
EMI Test Receiver	R&S	ESCS	826547/017	9kHz ~ 2.75GHz	Jun. 13, 2023	Jun. 12, 2024	Radiation (03CH01-CB)
RF Cable-low	Woken	RG402	Low Cable-16+17	30 MHz ~ 1 GHz	Oct. 03, 2022	Oct. 02, 2023	Radiation (03CH01-CB)
RF Cable-low	Woken	RG402	Low Cable-16+17	30 MHz ~ 1 GHz	Oct. 02, 2023	Oct. 01, 2024	Radiation (03CH01-CB)
Test Software	SPORTON	SENSE	V5.10	-	N.C.R.	N.C.R.	Radiation (03CH01-CB)
3m Semi Anechoic Chamber VSWR	RIKEN	SAC-3M	03CH02-CB	1GHz ~18GHz	Mar. 25, 2023	Mar. 24, 2024	Radiation (03CH02-CB)
Horn Antenna	EMCO	3115	9610-4976	1GHz ~ 18GHz	Apr. 18, 2023	Apr. 17, 2024	Radiation (03CH02-CB)
Horn Antenna	SCHWARZBECK	BBHA 9170	BBHA9170507	15GHz ~ 40GHz	Jun. 28, 2023	Jun. 27, 2024	Radiation (03CH02-CB)
Pre-Amplifier	Agilent	83017A	MY39501305	1GHz ~ 26.5GHz	Jun. 30, 2023	Jun. 29, 2024	Radiation (03CH02-CB)
Pre-Amplifier	SGH	SGH184	20221107-3	18GHz ~ 40GHz	Nov. 16, 2022	Nov. 15, 2023	Radiation (03CH02-CB)
Spectrum analyzer	R&S	FSU	100015	9kHz~26GHz	Dec. 05, 2022	Dec. 04, 2023	Radiation (03CH02-CB)
RF Cable-high	Woken	RG402	High Cable-18	1GHz ~ 18GHz	Oct. 03, 2022	Oct. 02, 2023	Radiation (03CH02-CB)
RF Cable-high	Woken	RG402	High Cable-18	1GHz ~ 18GHz	Oct. 02, 2023	Oct. 01, 2024	Radiation (03CH02-CB)



Instrument	Brand	Model No.	Serial No.	Characteristics	Calibration Date	Calibration Due Date	Remark
RF Cable-high	Woken	RG402	High Cable-18+19	1GHz ~ 18GHz	Oct. 03, 2022	Oct. 02, 2023	Radiation (03CH02-CB)
RF Cable-high	Woken	RG402	High Cable-18+19	1GHz ~ 18GHz	Oct. 02, 2023	Oct. 01, 2024	Radiation (03CH02-CB)
High Cable	Woken	WCA0929M	40G#5+6	1GHz ~ 40 GHz	Dec. 07, 2022	Dec. 06, 2023	Radiation (03CH02-CB)
High Cable	Woken	WCA0929M	40G#5	1GHz ~ 40 GHz	Dec. 07, 2022	Dec. 06, 2023	Radiation (03CH02-CB)
High Cable	Woken	WCA0929M	40G#6	1GHz ~ 40 GHz	Dec. 07, 2022	Dec. 06, 2023	Radiation (03CH02-CB)
Test Software	SPORTON	SENSE	V5.10	-	N.C.R.	N.C.R.	Radiation (03CH02-CB)
3m Semi Anechoic Chamber VSWR	TDK	SAC-3M	03CH01-CB	1GHz ~18GHz 3m	May 05, 2023	May 04, 2024	Radiation (03CH06-CB)
Horn Antenna	SCHWARZBECK	BBHA9120D	BBHA 9120D-1292	1GHz~18GHz	Jul. 31, 2023	Jul. 30, 2024	Radiation (03CH06-CB)
Horn Antenna	SCHWARZBECK	BBHA 9170	BBHA9170507	15GHz ~ 40GHz	Jun. 28, 2023	Jun. 27, 2024	Radiation (03CH06-CB)
Pre-Amplifier	Agilent	83017A	MY53270064	0.5GHz ~ 26.5GHz	Aug. 01, 2023	Jul. 31, 2024	Radiation (03CH06-CB)
Pre-Amplifier	SGH	SGH184	20221107-3	18GHz ~ 40GHz	Nov. 16, 2022	Nov. 15, 2023	Radiation (03CH06-CB)
Spectrum analyzer	R&S	FSP40	100080	9kHz~40GHz	Dec. 21, 2022	Dec. 20, 2023	Radiation (03CH06-CB)
RF Cable-high	Woken	RG402	High Cable-05+68	1GHz~18GHz	Aug. 15, 2023	Aug. 14, 2024	Radiation (03CH06-CB)
High Cable	Woken	WCA0929M	40G#5+6	1GHz ~ 40 GHz	Dec. 07, 2022	Dec. 06, 2023	Radiation (03CH06-CB)
High Cable	Woken	WCA0929M	40G#5	1GHz ~ 40 GHz	Dec. 07, 2022	Dec. 06, 2023	Radiation (03CH06-CB)
High Cable	Woken	WCA0929M	40G#6	1GHz ~ 40 GHz	Dec. 07, 2022	Dec. 06, 2023	Radiation (03CH06-CB)
Test Software	SPORTON	SENSE	V5.10	-	N.C.R.	N.C.R.	Radiation (03CH06-CB)
Spectrum analyzer	R&S	FSV40	101028	9kHz~40GHz	Dec. 30, 2022	Dec. 29, 2023	Conducted (TH03-CB)
Power Sensor	Anritsu	MA2411B	1531344	300MHz~40GHz	Aug. 01, 2023	Jul. 31, 2024	Conducted (TH03-CB)
Power Meter	Anritsu	ML2495A	1728002	300MHz~40GHz	Aug. 01, 2023	Jul. 31, 2024	Conducted (TH03-CB)
RF Cable	Woken	RG402	High Cable-11	30MHz ~18 GHz	Feb. 14, 2023	Feb. 13, 2024	Conducted (TH03-CB)
RF Cable	Woken	RG402	High Cable-12	30MHz ~18 GHz	Feb. 14, 2023	Feb. 13, 2024	Conducted (TH03-CB)
RF Cable	Woken	RG402	High Cable-13	30MHz ~18 GHz	Feb. 14, 2023	Feb. 13, 2024	Conducted (TH03-CB)
RF Cable-high	Woken	RG402	High Cable-14	1 GHz ~18 GHz	Oct. 03, 2022	Oct. 02, 2023	Conducted (TH03-CB)



Instrument	Brand	Model No.	Serial No.	Characteristics	Calibration Date	Calibration Due Date	Remark
RF Cable-high	Woken	RG402	High Cable-15	1 GHz –18 GHz	Oct. 03, 2022	Oct. 02, 2023	Conducted (TH03-CB)
Switch	SPTCB	SP-SWI	SWI-03	1 GHz –26.5 GHz	Oct. 04, 2022	Oct. 03, 2023	Conducted (TH03-CB)
Test Software	SPORTON	SENSE	V5.10	-	N.C.R.	N.C.R.	Conducted (TH03-CB)

Note: Calibration Interval of instruments listed above is one year.
N.C.R means Non-Calibration required.



Summary

Mode	Result	Type	Freq (Hz)	Level (dBuV)	Limit (dBuV)	Margin (dB)	Condition
Mode 1	Pass	AV	483k	35.30	46.29	-10.99	Neutral

Mode 1

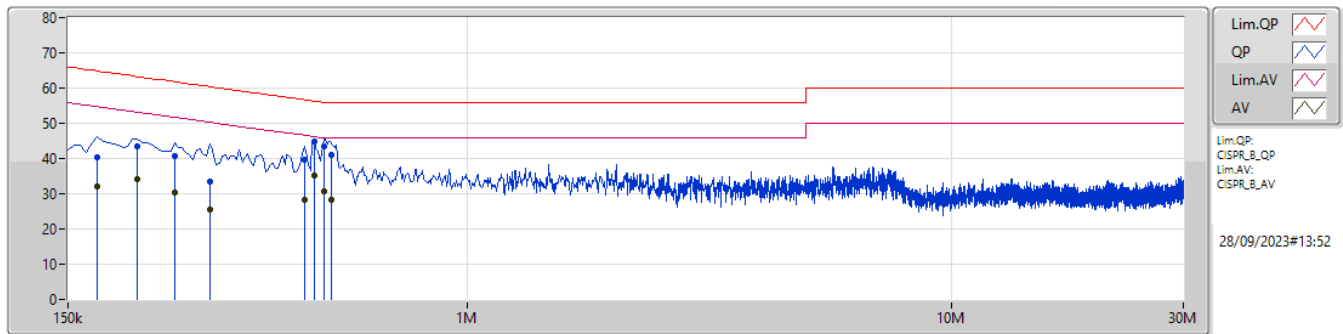

Type	Freq (Hz)	Level (dBuV)	Limit (dBuV)	Margin (dB)	Factor (dB)	Condition	Comment	Raw (dBuV)	LISN (dB)	CL (dB)	AT (dB)
QP	172.5k	40.50	64.83	-24.33	10.00	Line	-	30.50	0.09	0.04	9.87
AV	172.5k	32.06	54.83	-22.77	10.00	Line	-	22.06	0.09	0.04	9.87
QP	208.5k	43.57	63.27	-19.70	9.98	Line	-	33.59	0.08	0.04	9.86
AV	208.5k	34.19	53.27	-19.08	9.98	Line	-	24.21	0.08	0.04	9.86
QP	249k	40.59	61.79	-21.20	10.00	Line	-	30.59	0.08	0.05	9.87
AV	249k	30.28	51.79	-21.51	10.00	Line	-	20.28	0.08	0.05	9.87
QP	294k	33.31	60.42	-27.11	10.02	Line	-	23.29	0.09	0.05	9.88
AV	294k	25.53	50.42	-24.89	10.02	Line	-	15.51	0.09	0.05	9.88
QP	460.5k	39.75	56.69	-16.94	10.05	Line	-	29.70	0.09	0.06	9.90
AV	460.5k	28.30	46.69	-18.39	10.05	Line	-	18.25	0.09	0.06	9.90
QP	483k	44.71	56.29	-11.58	10.05	Line	-	34.66	0.09	0.06	9.90
AV	483k	35.26	46.29	-11.03	10.05	Line	"Worst"	25.21	0.09	0.06	9.90
QP	505.5k	43.50	56.00	-12.50	10.05	Line	-	33.45	0.10	0.05	9.90
AV	505.5k	30.75	46.00	-15.25	10.05	Line	-	20.70	0.10	0.05	9.90
QP	523.5k	40.87	56.00	-15.13	10.05	Line	-	30.82	0.10	0.05	9.90
AV	523.5k	28.17	46.00	-17.83	10.05	Line	-	18.12	0.10	0.05	9.90

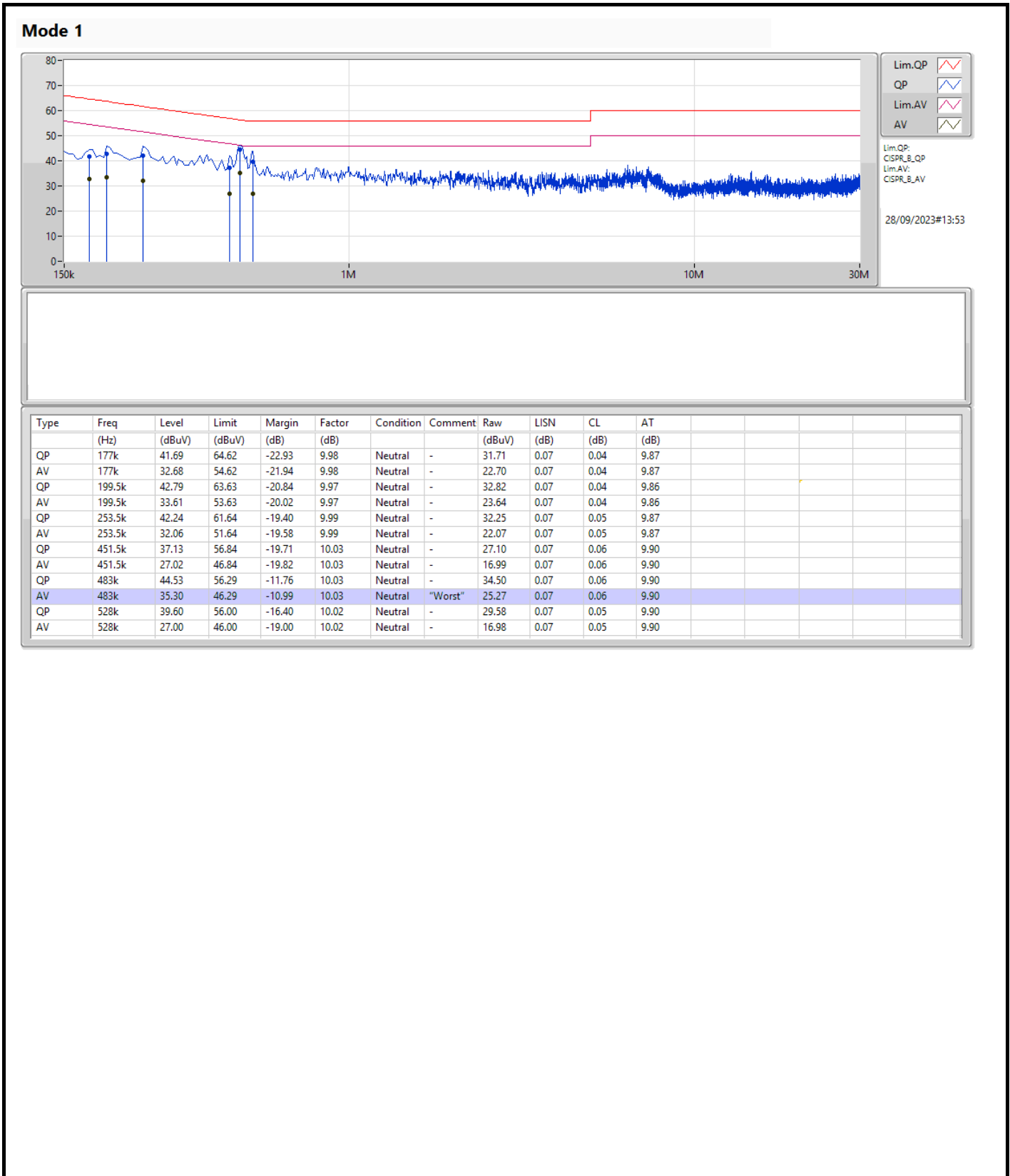



Summary

Mode	Max-N dB (Hz)	Max-OBW (Hz)	ITU-Code	Min-N dB (Hz)	Min-OBW (Hz)
2.4-2.4835GHz	-	-	-	-	-
BT-LE(1Mbps)	676.25k	1.023M	1M02F1D	675k	1.018M
BT-LE(2Mbps)	1.158M	2.008M	2M01F1D	1.155M	2.004M

Max-N dB = Maximum 6dB down bandwidth; Max-OBW = Maximum 99% occupied bandwidth;
Min-N dB = Minimum 6dB down bandwidth; Min-OBW = Minimum 99% occupied bandwidth



Result

Mode	Result	Limit (Hz)	Port 1-N dB (Hz)	Port 1-OBW (Hz)
BT-LE(1Mbps)	-	-	-	-
2402MHz	Pass	500k	676.25k	1.023M
2440MHz	Pass	500k	675k	1.019M
2480MHz	Pass	500k	675k	1.018M
BT-LE(2Mbps)	-	-	-	-
2402MHz	Pass	500k	1.158M	2.004M
2440MHz	Pass	500k	1.155M	2.006M
2480MHz	Pass	500k	1.158M	2.008M

Port X-N dB = Port X 6dB down bandwidth;
Port X-OBW = Port X 99% occupied bandwidth

2.4-2.4835GHz_BT-LE(1Mbps)

EBW-DTS

2402MHz

05/09/2023

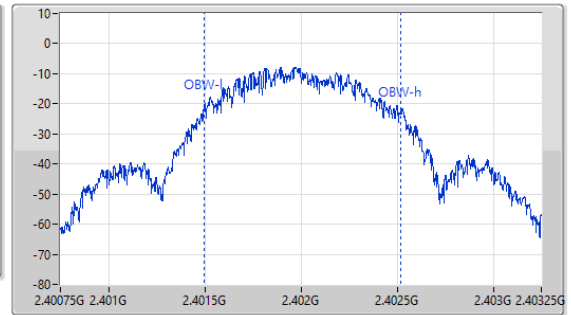
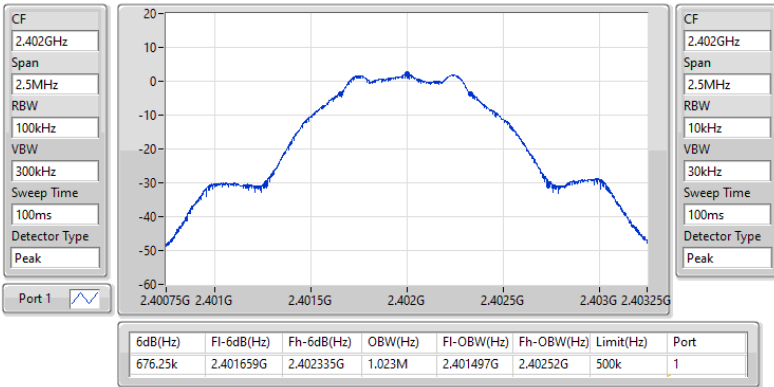

2.4-2.4835GHz_BT-LE(1Mbps)

EBW-DTS

2440MHz

05/09/2023

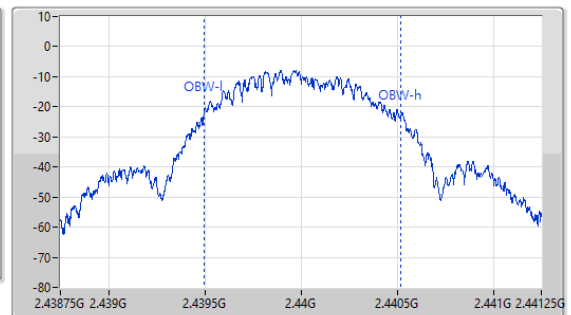
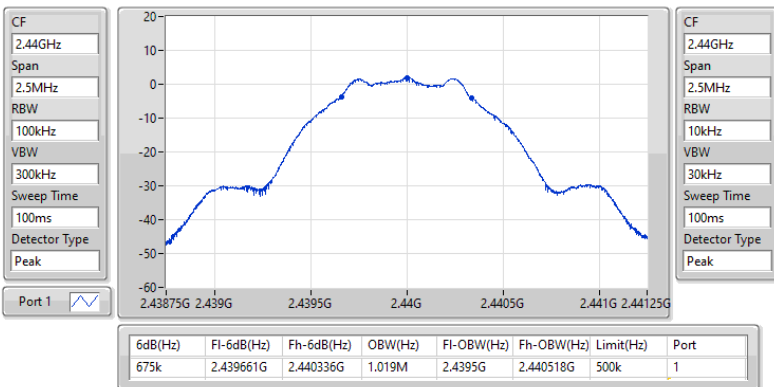

2.4-2.4835GHz_BT-LE(1Mbps)

EBW-DTS

2480MHz

05/09/2023

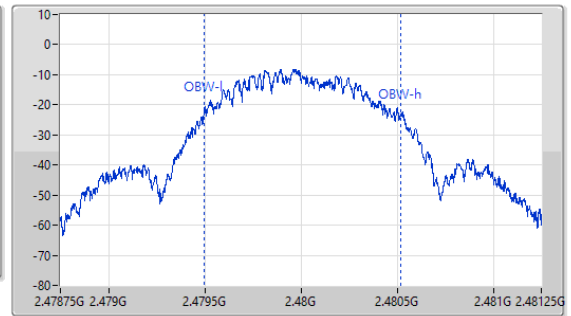
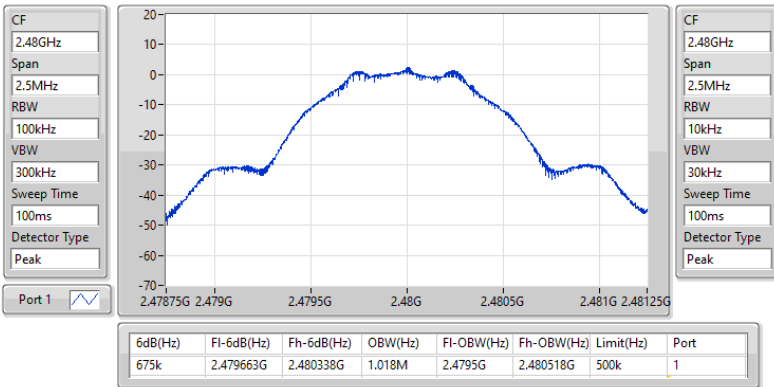

2.4-2.4835GHz_BT-LE(2Mbps)

EBW-DTS

2402MHz

05/09/2023

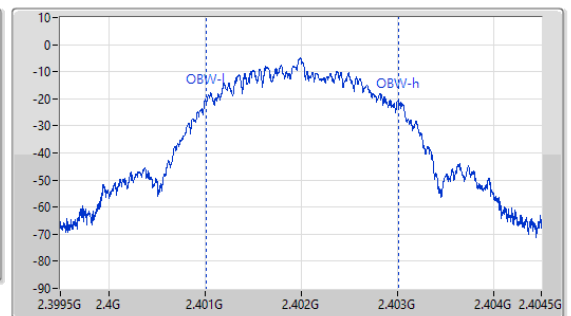
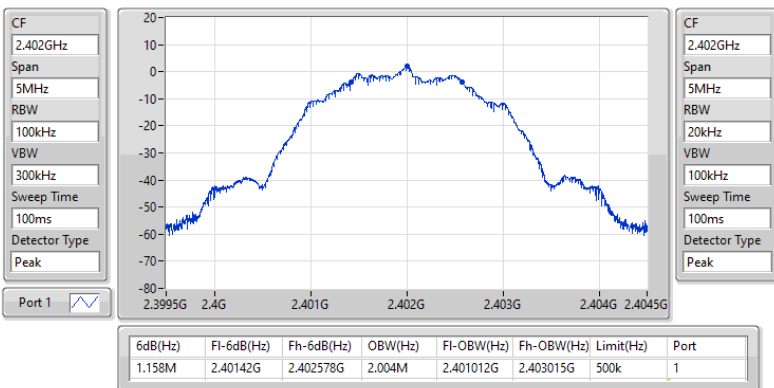

2.4-2.4835GHz_BT-LE(2Mbps)

EBW-DTS

2440MHz

05/09/2023

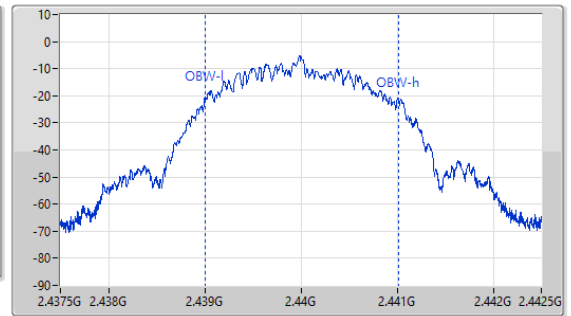
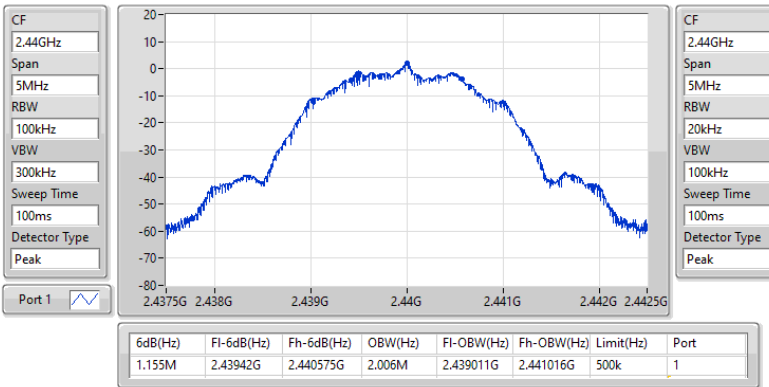

2.4-2.4835GHz_BT-LE(2Mbps)

EBW-DTS

2480MHz

05/09/2023

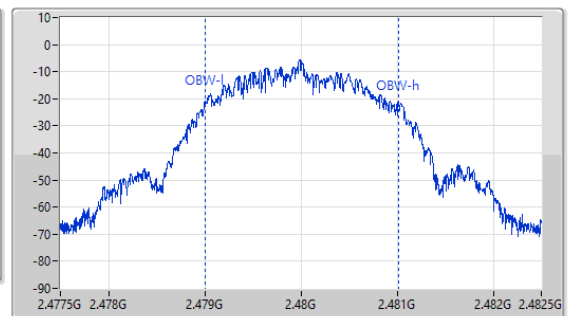
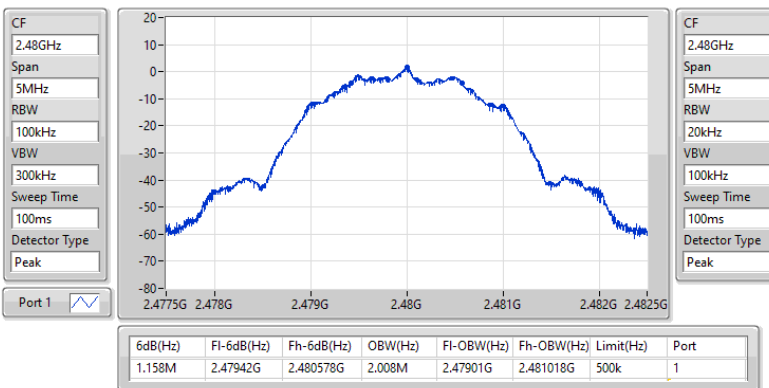



Summary

Mode	Total Power (dBm)	Power (W)
2.4-2.4835GHz	-	-
BT-LE(1Mbps)	1.84	0.00153
BT-LE(2Mbps)	1.33	0.00136



Result

Mode	Result	DG (dBi)	Total Power (dBm)	Power Limit (dBm)
BT-LE(1Mbps)	-	-	-	-
2402MHz	Pass	2.82	1.84	30.00
2440MHz	Pass	2.82	1.60	30.00
2480MHz	Pass	2.82	1.30	30.00
BT-LE(2Mbps)	-	-	-	-
2402MHz	Pass	2.82	1.33	30.00
2440MHz	Pass	2.82	1.06	30.00
2480MHz	Pass	2.82	0.66	30.00

DG = Directional Gain; Port X = Port X output power



Summary

Mode	PD (dBm/RBW)
2.4-2.4835GHz	-
BT-LE(1Mbps)	-12.44
BT-LE(2Mbps)	-15.03

RBW = 3kHz:



Result

Mode	Result	DG (dBi)	PD (dBm/RBW)	PD Limit (dBm/RBW)
BT-LE(1Mbps)	-	-	-	-
2402MHz	Pass	2.82	-12.44	8.00
2404MHz				
2440MHz	Pass	2.82	-12.51	8.00
2478MHz				
2480MHz	Pass	2.82	-12.84	8.00
BT-LE(2Mbps)	-	-	-	-
2402MHz	Pass	2.82	-15.03	8.00
2404MHz				
2440MHz	Pass	2.82	-15.30	8.00
2478MHz				
2480MHz	Pass	2.82	-15.62	8.00

DG = Directional Gain; RBW = 3kHz;
PD = trace bin-by-bin of each transmits port summing can be performed maximum power density; Port X = Port X Power Density;

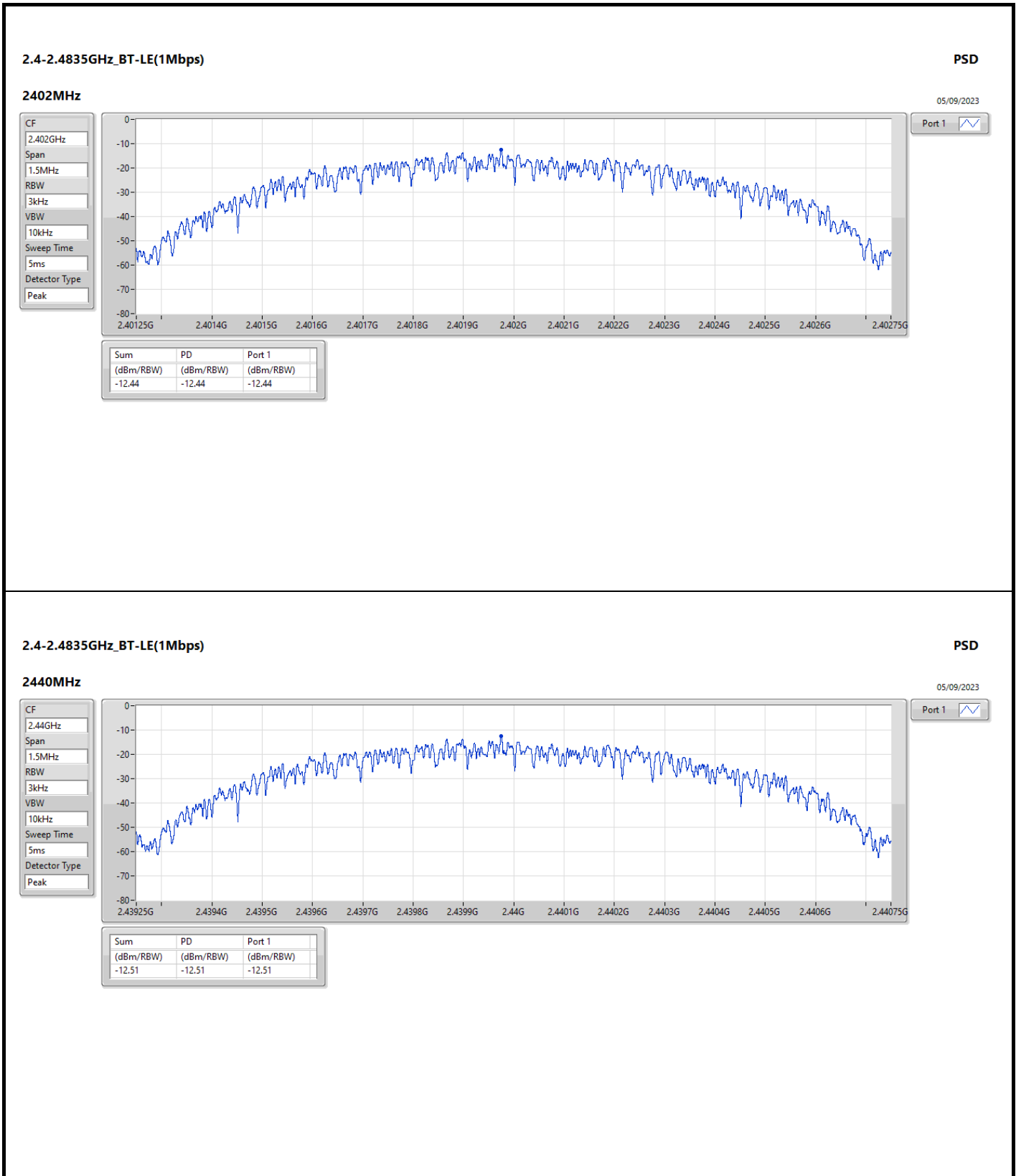

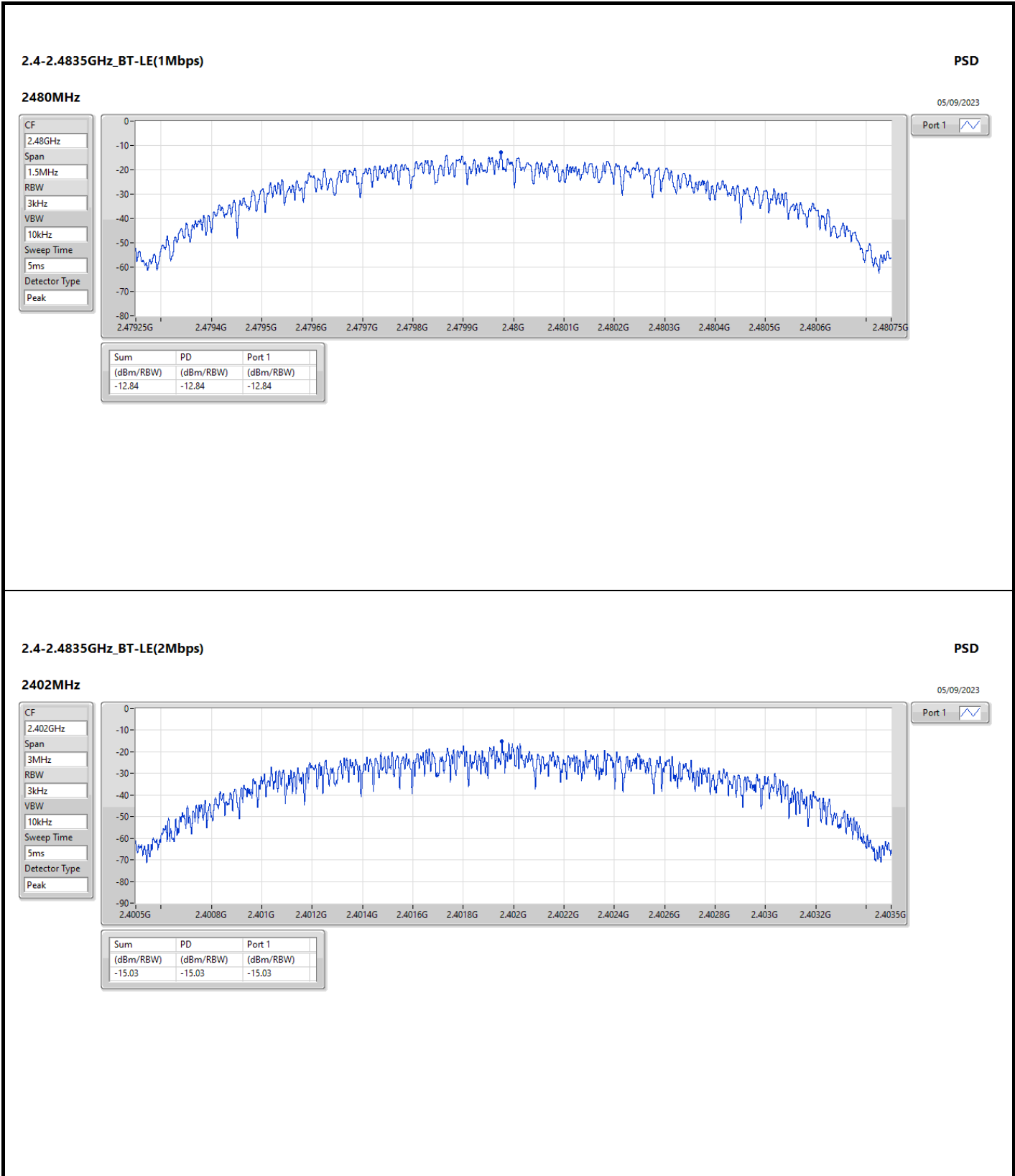

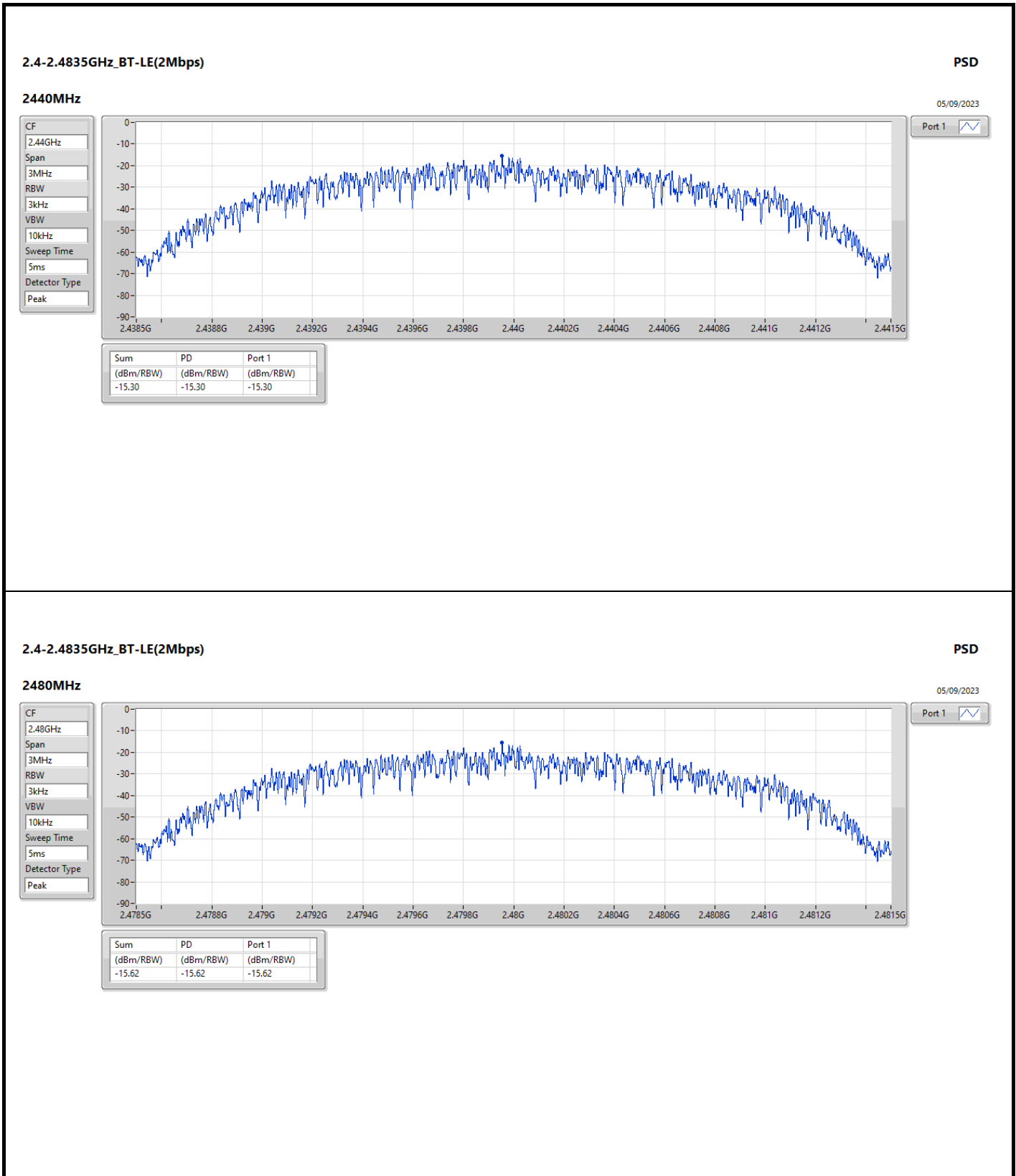



Summary

Mode	Result	Ref (Hz)	Ref (dBm)	Limit (dBm)	Freq (Hz)	Level (dBm)	Freq (Hz)	Level (dBm)	Freq (Hz)	Level (dBm)	Freq (Hz)	Level (dBm)	Freq (Hz)	Level (dBm)	Port
2.4-2.4835GHz	-	-	-	-	-	-	-	-	-	-	-	-	-	-	-
BT-LE(1Mbps)	Pass	2.402G	2.10	-27.90	2.1779G	-53.79	2.39456G	-50.50	2.4G	-54.18	2.50282G	-51.63	21.92642G	-47.71	1
BT-LE(2Mbps)	Pass	2.402G	1.75	-28.25	44.1M	-54.17	2.4G	-43.11	2.4G	-42.48	2.5003G	-50.95	21.69864G	-47.05	1



Result

Mode	Result	Ref (Hz)	Ref (dBm)	Limit (dBm)	Freq (Hz)	Level (dBm)	Freq (Hz)	Level (dBm)	Freq (Hz)	Level (dBm)	Freq (Hz)	Level (dBm)	Freq (Hz)	Level (dBm)	Port
BT-LE(1Mbps)	-	-	-	-	-	-	-	-	-	-	-	-	-	-	-
2402MHz	Pass	2.402G	2.10	-27.90	2.1779G	-53.79	2.39456G	-50.50	2.4G	-54.18	2.50282G	-51.63	21.92642G	-47.71	1
2440MHz	Pass	2.402G	2.10	-27.90	40.58M	-54.06	2.39104G	-50.51	2.4G	-56.93	2.5007G	-51.30	21.58334G	-47.18	1
2480MHz	Pass	2.402G	2.10	-27.90	1.87123G	-53.59	2.39972G	-51.41	2.4G	-56.32	2.5005G	-51.00	21.68739G	-46.39	1
BT-LE(2Mbps)	-	-	-	-	-	-	-	-	-	-	-	-	-	-	-
2402MHz	Pass	2.402G	1.75	-28.25	44.1M	-54.17	2.4G	-43.11	2.4G	-42.48	2.5003G	-50.95	21.69864G	-47.05	1
2440MHz	Pass	2.402G	1.75	-28.25	2.15793G	-53.72	2.3916G	-51.67	2.4G	-57.08	2.50162G	-51.28	21.76332G	-46.42	1
2480MHz	Pass	2.402G	1.75	-28.25	2.06393G	-54.07	2.39908G	-49.33	2.4G	-56.78	2.50062G	-51.59	21.65646G	-47.66	1

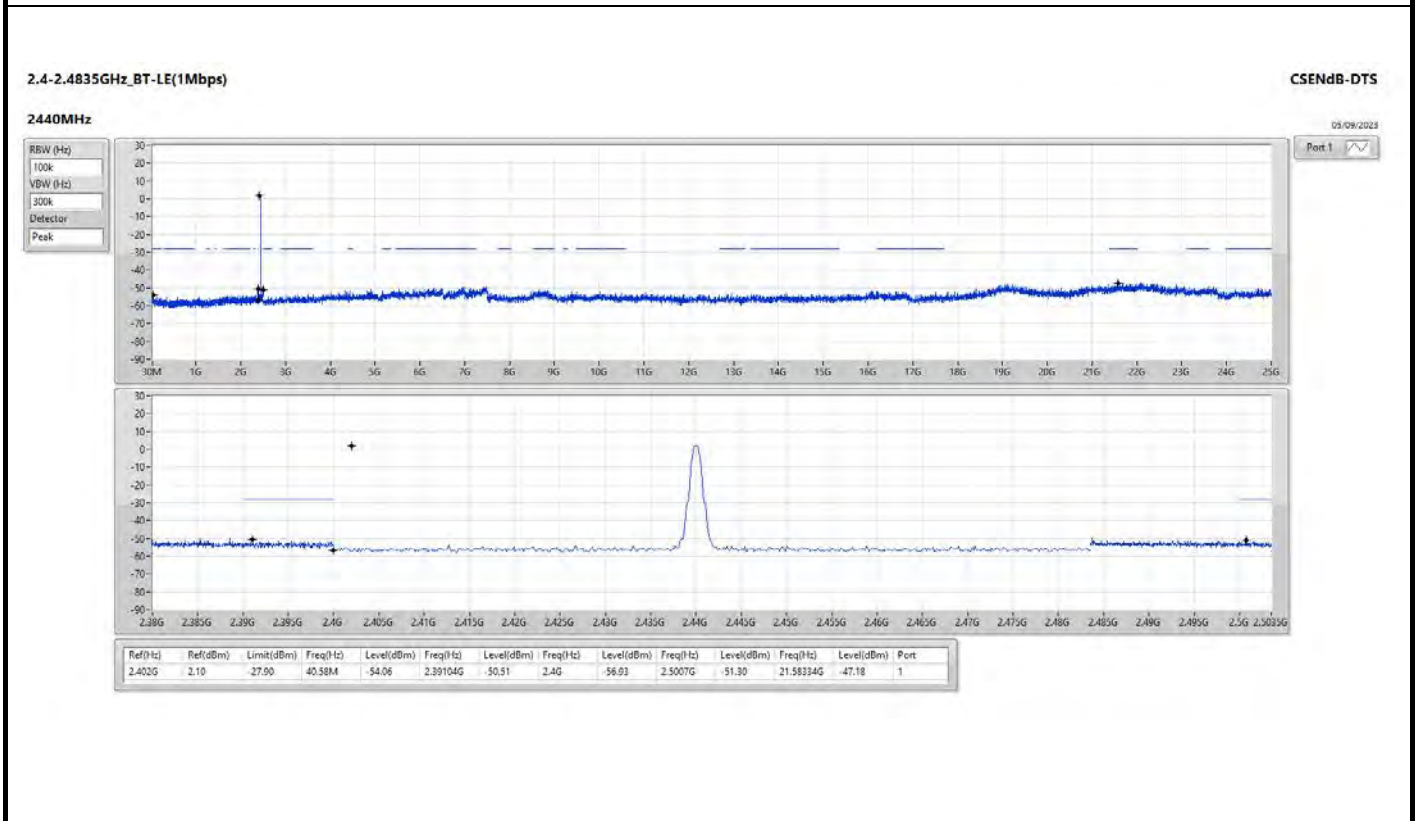
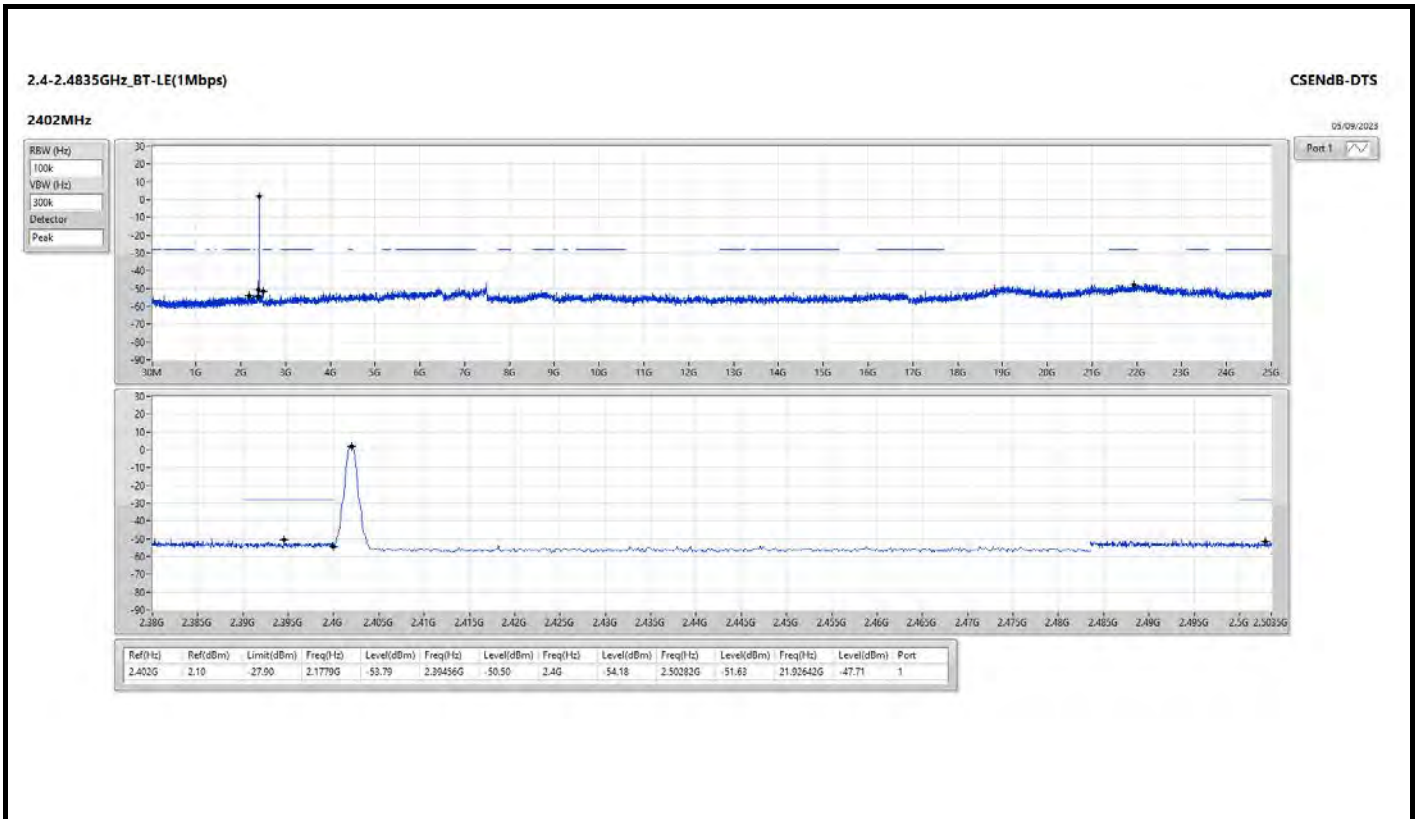

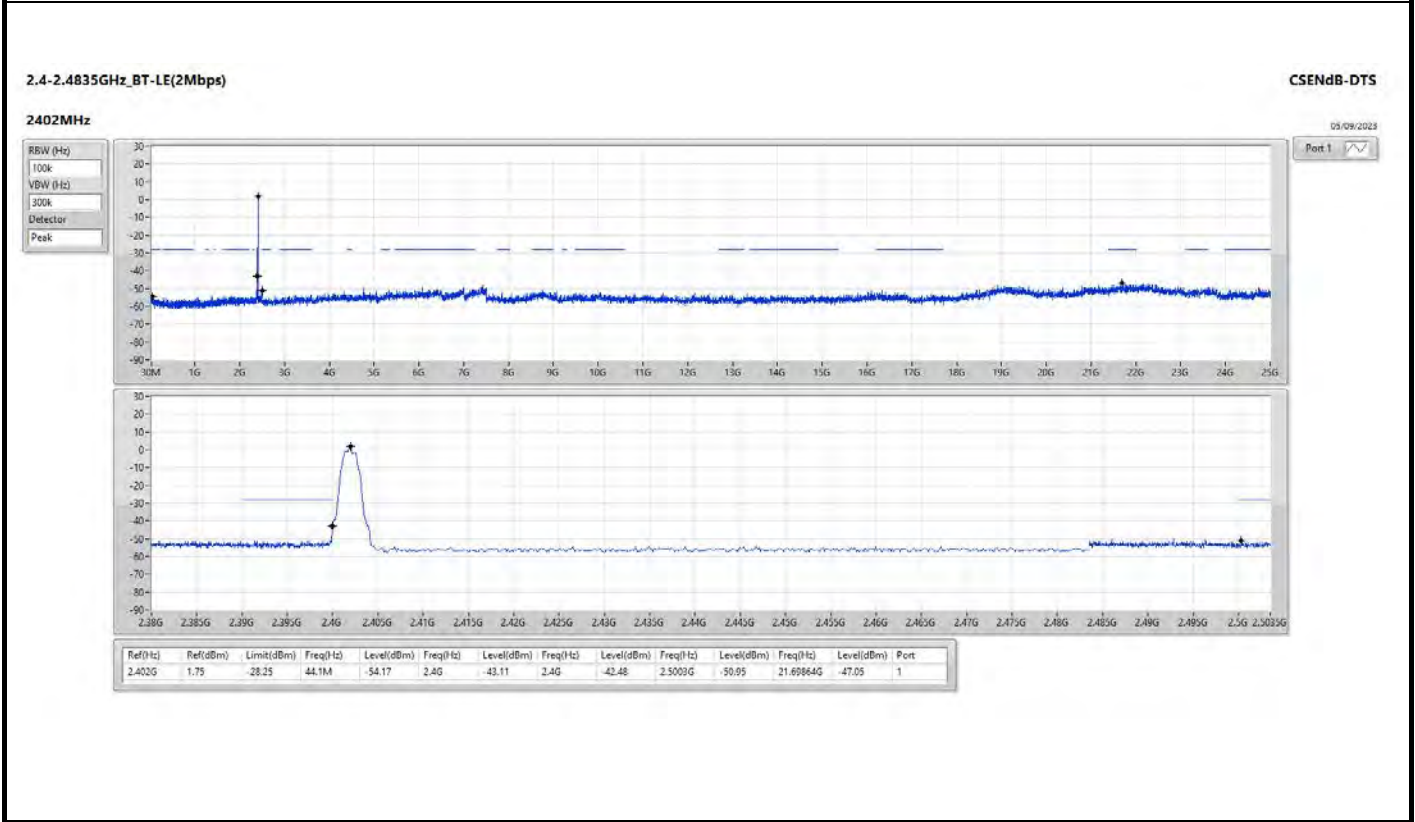
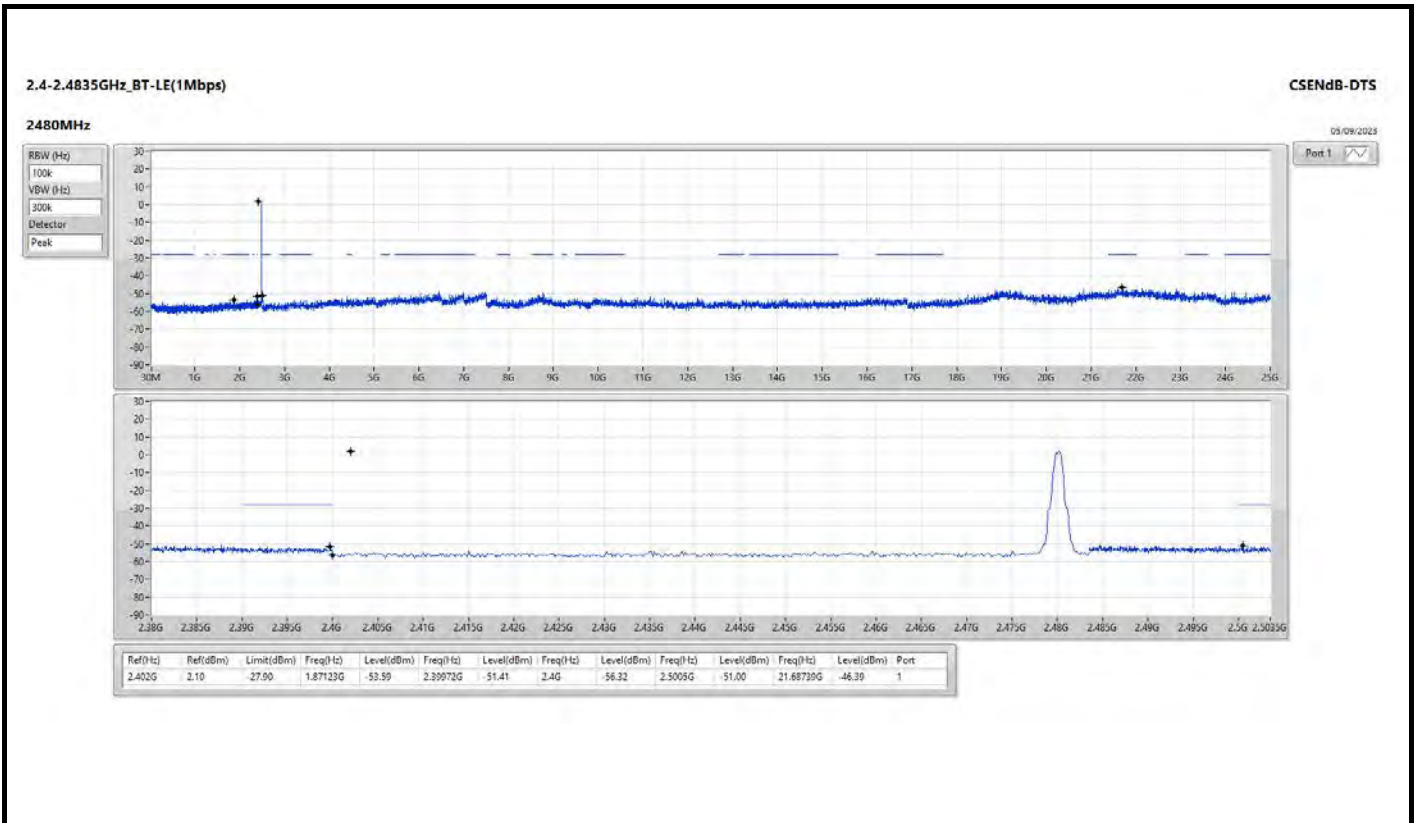

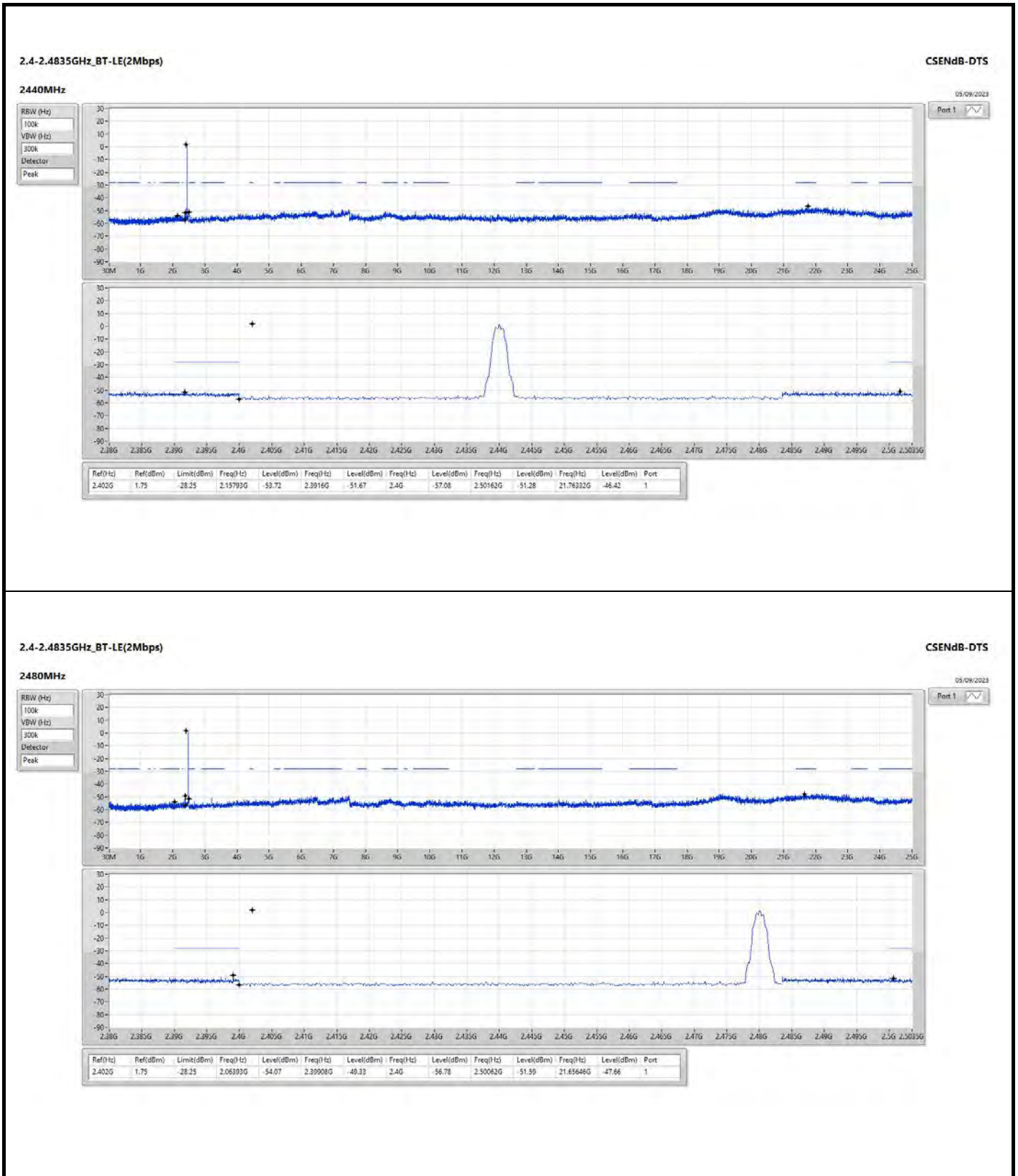



Summary

Mode	Result	Type	Freq (Hz)	Level (dBuV/m)	Limit (dBuV/m)	Margin (dB)	Condition
Mode 1	Pass	PK	65.89M	33.88	40.00	-6.12	Horizontal

Mode 1

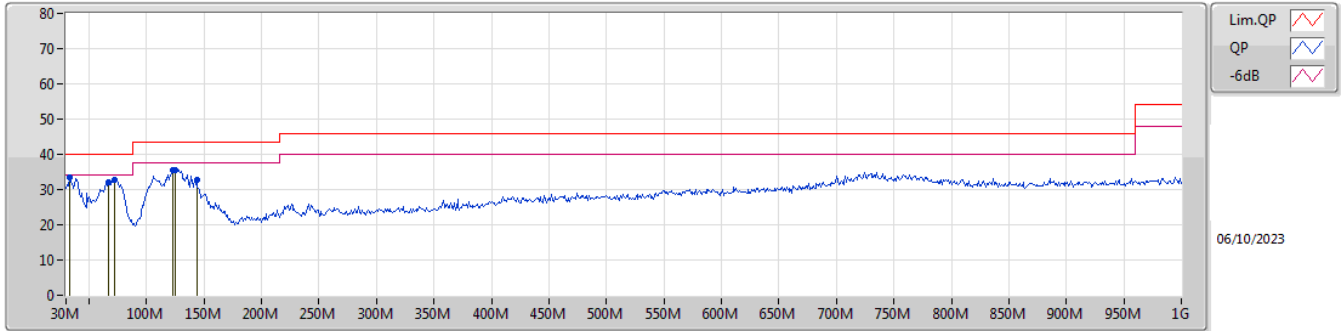

Type	Freq (Hz)	Level (dBuV/m)	Limit (dBuV/m)	Margin (dB)	Factor (dB/m)	Dist (m)	Condition	Azimuth (°)	Height (m)	Comment	Raw (dBuV/m)	AF (dB/m)	CL (dB)	PA (dB)
PK	32.91M	33.33	40.00	-6.67	-21.37	3	Vertical	105	1.00	"Worst"	54.70	22.25	0.70	44.32
PK	66.86M	31.94	40.00	-8.06	-32.32	3	Vertical	174	3.00	-	64.26	11.39	0.92	44.63
PK	71.71M	32.63	40.00	-7.37	-32.15	3	Vertical	0	1.25	-	64.78	11.48	0.98	44.61
PK	123.12M	35.45	43.50	-8.05	-26.18	3	Vertical	179	1.00	-	61.63	17.20	1.25	44.63
PK	125.06M	35.47	43.50	-8.03	-26.25	3	Vertical	192	1.25	-	61.72	17.11	1.26	44.62
PK	143.49M	32.60	43.50	-10.90	-27.20	3	Vertical	141	1.00	-	59.80	16.06	1.33	44.59

Mode 1

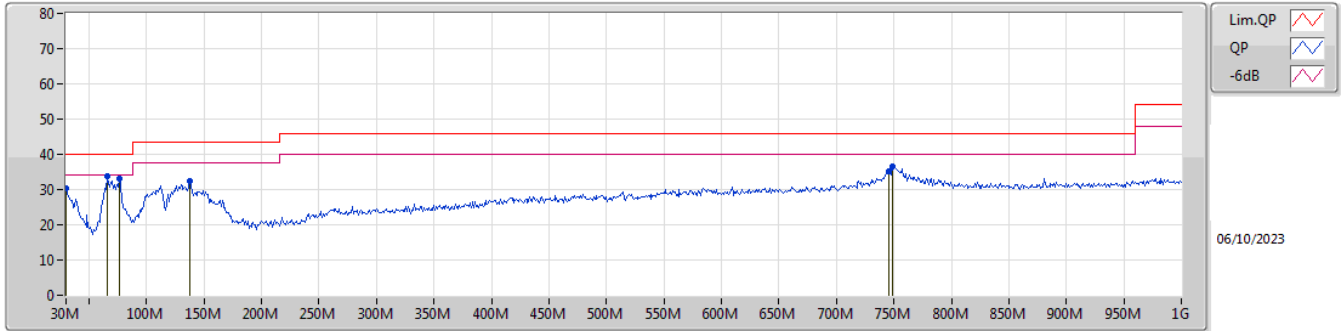

Type	Freq (Hz)	Level (dBuV/m)	Limit (dBuV/m)	Margin (dB)	Factor (dB/m)	Dist (m)	Condition	Azimuth (°)	Height (m)	Comment	Raw (dBuV/m)	AF (dB/m)	CL (dB)	PA (dB)
PK	30M	30.42	40.00	-9.58	-19.56	3	Horizontal	68	3.00	-	49.98	24.08	0.68	44.32
PK	65.89M	33.88	40.00	-6.12	-32.34	3	Horizontal	78	3.00	"Worst"	66.22	11.38	0.91	44.63
PK	76.56M	33.06	40.00	-6.94	-31.88	3	Horizontal	128	3.00	-	64.94	11.72	1.00	44.60
PK	137.67M	32.46	43.50	-11.04	-26.89	3	Horizontal	114	2.00	-	59.35	16.40	1.31	44.60
PK	745.86M	35.31	46.00	-10.69	-16.03	3	Horizontal	288	1.00	-	51.34	24.66	2.93	43.62
PK	748.77M	36.70	46.00	-9.30	-15.98	3	Horizontal	110	1.00	-	52.68	24.71	2.93	43.62



Summary

Mode	Result	Type	Freq (Hz)	Level (dBuV/m)	Limit (dBuV/m)	Margin (dB)	Dist (m)	Condition	Azimuth (°)	Height (m)	Comments
2.4-2.4835GHz	-	-	-	-	-	-	-	-	-	-	-
BT-LE(2Mbps)	Pass	AV	2.4835G	49.30	54.00	-4.70	3	Horizontal	53	2.59	-

2.4-2.4835GHz_BT-LE(1Mbps)

2402MHz_TX

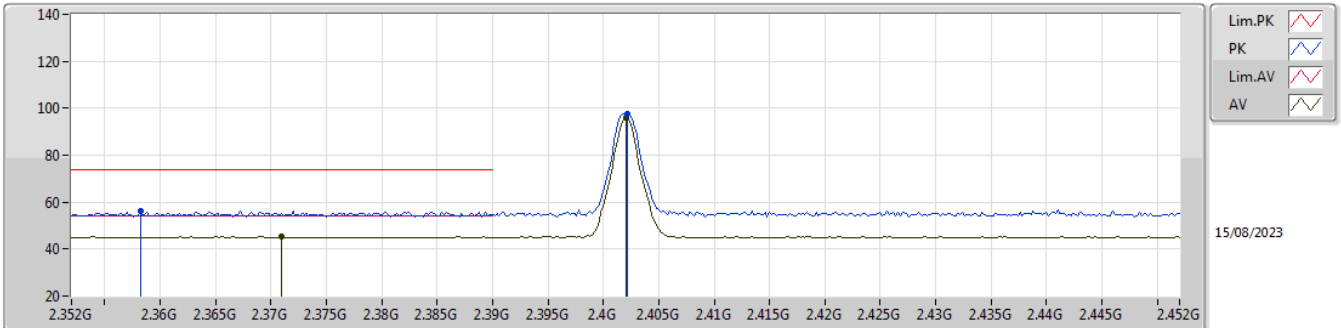

EUT_Z_1TX
Setting Default
06-D-M-2

Type	Freq (Hz)	Level (dBuV/m)	Limit (dBuV/m)	Margin (dB)	Raw (dBuV)	Dist (m)	Condition	Azimuth (°)	Height (m)	Comment	AF (dB)	CL (dB)	PA (dB)
PK	2.3582G	56.40	74.00	-17.60	24.37	3	Vertical	87	1.00	-	27.23	4.80	-
AV	2.371G	45.35	54.00	-8.65	13.24	3	Vertical	87	1.00	-	27.28	4.83	-
PK	2.4022G	97.41	Inf	-Inf	65.11	3	Vertical	87	1.00	-	27.40	4.90	-
AV	2.402G	96.02	Inf	-Inf	63.72	3	Vertical	87	1.00	-	27.40	4.90	-

2.4-2.4835GHz_BT-LE(1Mbps)

2402MHz_TX

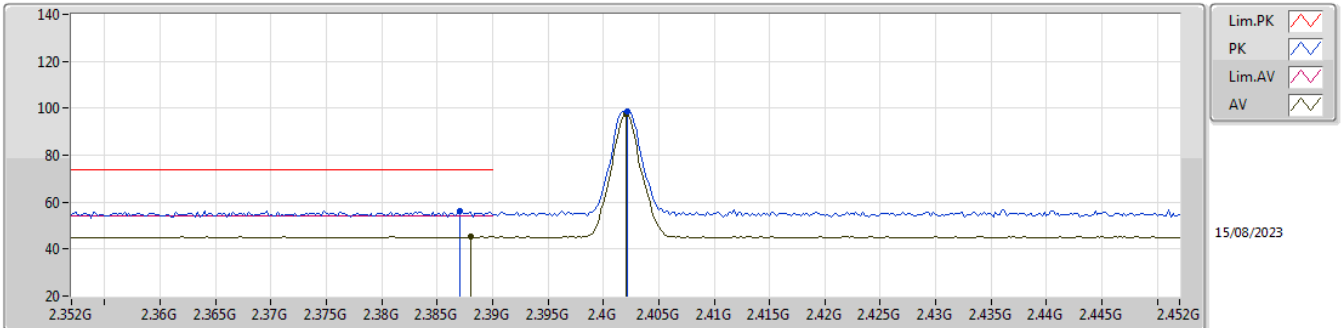

EUT_Z_1TX
Setting Default
06-D-M-2

Type	Freq (Hz)	Level (dBuV/m)	Limit (dBuV/m)	Margin (dB)	Raw (dBuV)	Dist (m)	Condition	Azimuth (°)	Height (m)	Comment	AF (dB)	CL (dB)	PA (dB)
PK	2.387G	56.15	74.00	-17.85	23.93	3	Horizontal	44	1.04	-	27.35	4.87	-
AV	2.388G	45.59	54.00	-8.41	13.37	3	Horizontal	44	1.04	-	27.35	4.87	-
PK	2.402G	98.85	Inf	-Inf	66.55	3	Horizontal	44	1.04	-	27.40	4.90	-
AV	2.402G	97.47	Inf	-Inf	65.17	3	Horizontal	44	1.04	-	27.40	4.90	-

2.4-2.4835GHz_BT-LE(1Mbps)

2402MHz_TX

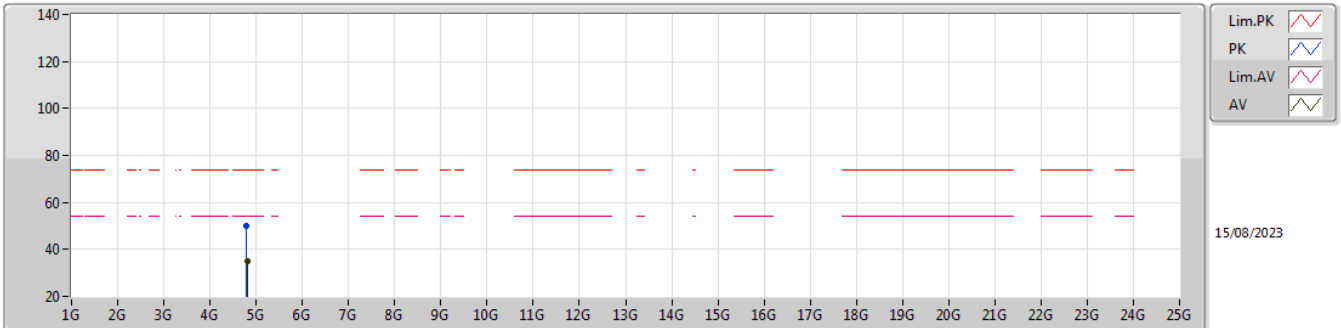

EUT_Z_1TX
Setting Default
06-D-M-2

Type	Freq (Hz)	Level (dBuV/m)	Limit (dBuV/m)	Margin (dB)	Raw (dBuV)	Dist (m)	Condition	Azimuth (°)	Height (m)	Comment	AF (dB)	CL (dB)	PA (dB)
PK	4.79412G	49.77	74.00	-24.23	42.42	3	Vertical	132	1.49	-	32.08	6.69	31.42
AV	4.80376G	35.16	54.00	-18.84	27.76	3	Vertical	132	1.49	-	32.12	6.70	31.42

2.4-2.4835GHz_BT-LE(1Mbps)

2402MHz_TX

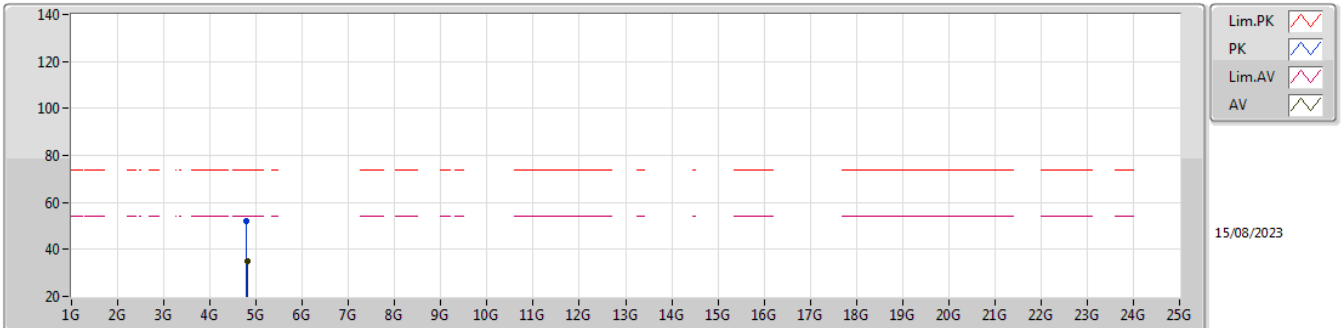

EUT_Z_1TX
Setting Default
06-D-M-2

Type	Freq (Hz)	Level (dBuV/m)	Limit (dBuV/m)	Margin (dB)	Raw (dBuV)	Dist (m)	Condition	Azimuth (°)	Height (m)	Comment	AF (dB)	CL (dB)	PA (dB)
PK	4.79668G	52.24	74.00	-21.76	44.88	3	Horizontal	249	1.09	-	32.09	6.69	31.42
AV	4.80356G	35.23	54.00	-18.77	27.83	3	Horizontal	249	1.09	-	32.12	6.70	31.42

2.4-2.4835GHz_BT-LE(1Mbps)

2440MHz_TX

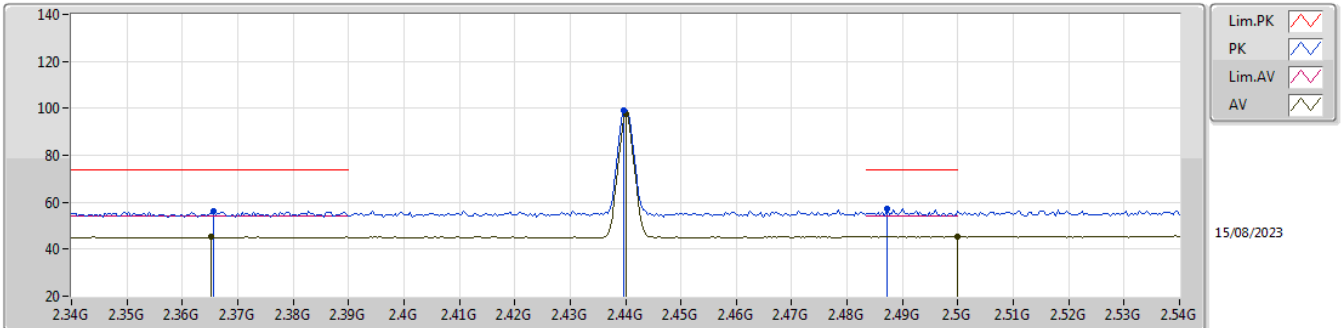

EUT_Z_1TX
Setting Default
06-D-M-2

Type	Freq (Hz)	Level (dBuV/m)	Limit (dBuV/m)	Margin (dB)	Raw (dBuV)	Dist (m)	Condition	Azimuth (°)	Height (m)	Comment	AF (dB)	CL (dB)	PA (dB)
PK	2.3656G	56.35	74.00	-17.65	24.28	3	Vertical	88	1.80	-	27.26	4.81	-
AV	2.3652G	45.17	54.00	-8.83	13.10	3	Vertical	88	1.80	-	27.26	4.81	-
PK	2.4396G	99.21	Inf	-Inf	66.85	3	Vertical	88	1.80	-	27.48	4.88	-
AV	2.44G	97.84	Inf	-Inf	65.48	3	Vertical	88	1.80	-	27.48	4.88	-
PK	2.4872G	57.31	74.00	-16.69	24.73	3	Vertical	88	1.80	-	27.72	4.86	-
AV	2.5G	45.53	54.00	-8.47	12.88	3	Vertical	88	1.80	-	27.80	4.85	-

2.4-2.4835GHz_BT-LE(1Mbps)

2440MHz_TX

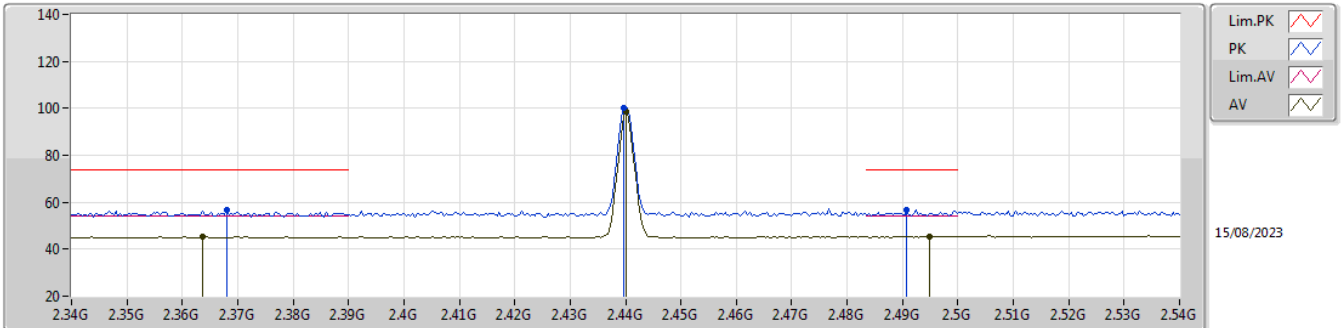

EUT_Z_1TX
Setting Default
06-D-M-2

Type	Freq (Hz)	Level (dBuV/m)	Limit (dBuV/m)	Margin (dB)	Raw (dBuV)	Dist (m)	Condition	Azimuth (°)	Height (m)	Comment	AF (dB)	CL (dB)	PA (dB)
PK	2.368G	56.73	74.00	-17.27	24.64	3	Horizontal	55	2.66	-	27.27	4.82	-
AV	2.3636G	45.23	54.00	-8.77	13.17	3	Horizontal	55	2.66	-	27.25	4.81	-
PK	2.4396G	100.16	Inf	-Inf	67.80	3	Horizontal	55	2.66	-	27.48	4.88	-
AV	2.44G	98.65	Inf	-Inf	66.29	3	Horizontal	55	2.66	-	27.48	4.88	-
PK	2.4908G	56.61	74.00	-17.39	24.02	3	Horizontal	55	2.66	-	27.74	4.85	-
AV	2.4948G	45.41	54.00	-8.59	12.79	3	Horizontal	55	2.66	-	27.77	4.85	-

2.4-2.4835GHz_BT-LE(1Mbps)

2440MHz_TX

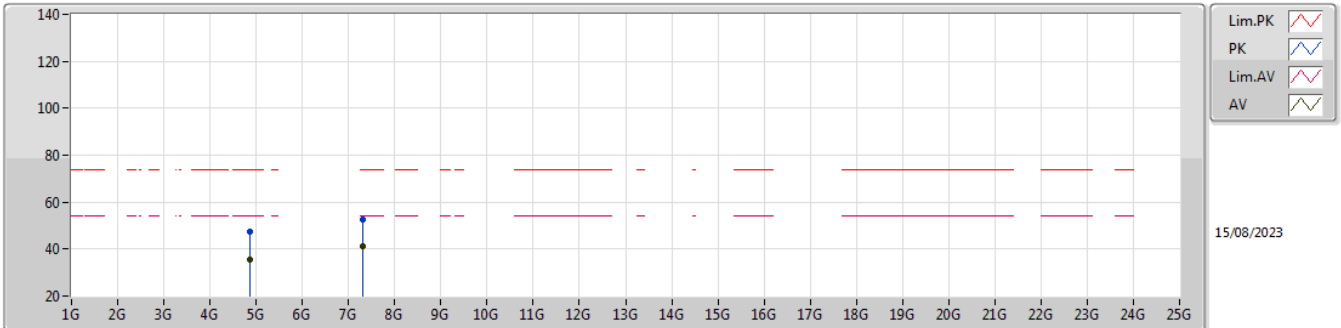

EUT_Z_1TX
Setting Default
06-D-M-2

Type	Freq (Hz)	Level (dBuV/m)	Limit (dBuV/m)	Margin (dB)	Raw (dBuV)	Dist (m)	Condition	Azimuth (°)	Height (m)	Comment	AF (dB)	CL (dB)	PA (dB)
PK	4.8748G	47.54	74.00	-26.46	39.71	3	Vertical	31	2.95	-	32.50	6.70	31.37
AV	4.8738G	35.47	54.00	-18.53	27.64	3	Vertical	31	2.95	-	32.50	6.70	31.37
PK	7.31384G	52.83	74.00	-21.17	40.84	3	Vertical	350	1.41	-	36.74	7.86	32.61
AV	7.3118G	41.19	54.00	-12.81	29.18	3	Vertical	350	1.41	-	36.75	7.86	32.60

2.4-2.4835GHz_BT-LE(1Mbps)

2440MHz_TX

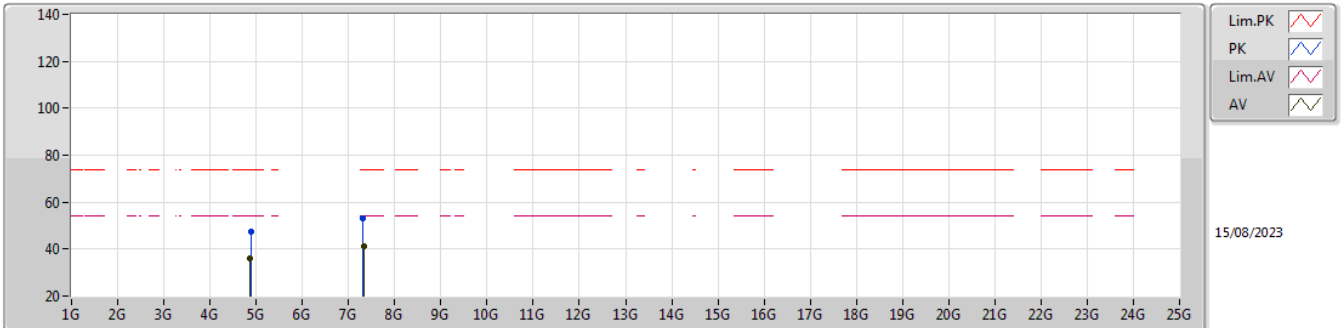

EUT_Z_1TX
Setting Default
06-D-M-2

Type	Freq (Hz)	Level (dBuV/m)	Limit (dBuV/m)	Margin (dB)	Raw (dBuV)	Dist (m)	Condition	Azimuth (°)	Height (m)	Comment	AF (dB)	CL (dB)	PA (dB)
PK	4.8838G	47.28	74.00	-26.72	39.40	3	Horizontal	135	2.97	-	32.54	6.70	31.36
AV	4.87148G	35.90	54.00	-18.10	28.08	3	Horizontal	135	2.97	-	32.49	6.70	31.37
PK	7.31236G	53.35	74.00	-20.65	41.34	3	Horizontal	212	2.89	-	36.75	7.86	32.60
AV	7.32968G	41.03	54.00	-12.97	29.12	3	Horizontal	212	2.89	-	36.68	7.86	32.63

2.4-2.4835GHz_BT-LE(1Mbps)

2480MHz_TX

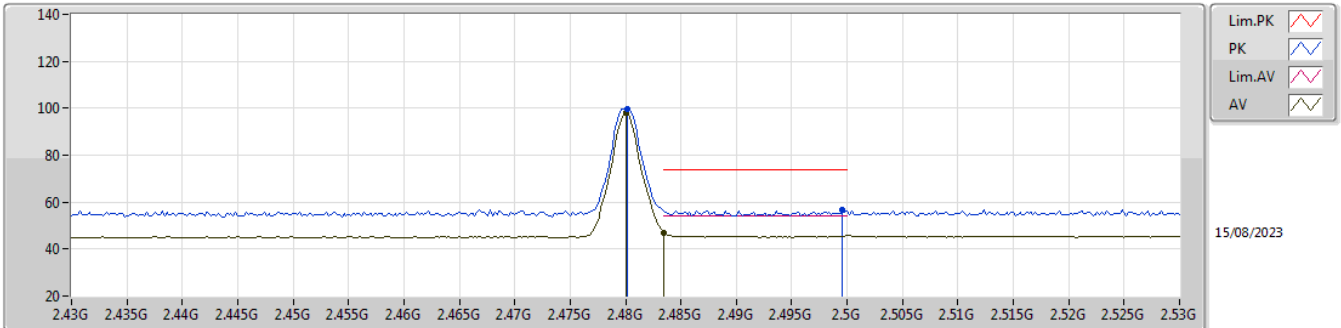

EUT_Z_1TX
Setting Default
06-D-M-2

Type	Freq (Hz)	Level (dBuV/m)	Limit (dBuV/m)	Margin (dB)	Raw (dBuV)	Dist (m)	Condition	Azimuth (°)	Height (m)	Comment	AF (dB)	CL (dB)	PA (dB)
PK	2.4802G	99.63	Inf	-Inf	67.09	3	Vertical	88	1.75	-	27.68	4.86	-
AV	2.48G	98.28	Inf	-Inf	65.74	3	Vertical	88	1.75	-	27.68	4.86	-
PK	2.4996G	56.52	74.00	-17.48	23.87	3	Vertical	88	1.75	-	27.80	4.85	-
AV	2.4835G	47.12	54.00	-6.88	14.56	3	Vertical	88	1.75	-	27.70	4.86	-

2.4-2.4835GHz_BT-LE(1Mbps)

2480MHz_TX

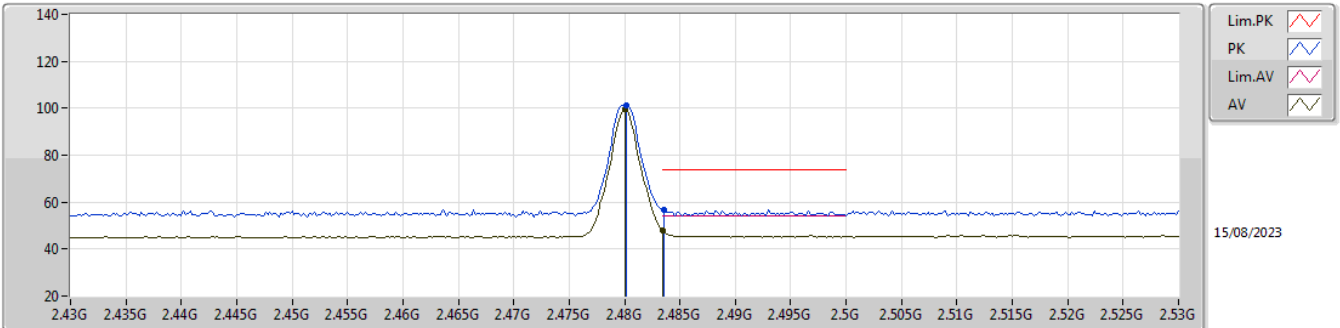

EUT_Z_1TX
Setting Default
06-D-M-2

Type	Freq (Hz)	Level (dBuV/m)	Limit (dBuV/m)	Margin (dB)	Raw (dBuV)	Dist (m)	Condition	Azimuth (°)	Height (m)	Comment	AF (dB)	CL (dB)	PA (dB)
PK	2.4802G	101.04	Inf	-Inf	68.50	3	Horizontal	48	1.06	-	27.68	4.86	-
AV	2.48G	99.71	Inf	-Inf	67.17	3	Horizontal	48	1.06	-	27.68	4.86	-
PK	2.4836G	56.81	74.00	-17.19	24.25	3	Horizontal	48	1.06	-	27.70	4.86	-
AV	2.4835G	47.93	54.00	-6.07	15.37	3	Horizontal	48	1.06	-	27.70	4.86	-

2.4-2.4835GHz_BT-LE(1Mbps)

2480MHz_TX

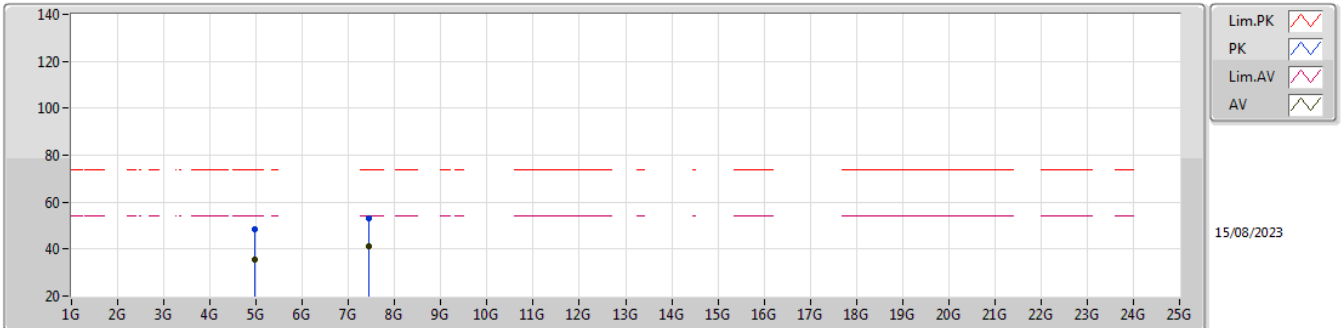

EUT_Z_1TX
Setting Default
06-D-M-2

Type	Freq (Hz)	Level (dBuV/m)	Limit (dBuV/m)	Margin (dB)	Raw (dBuV)	Dist (m)	Condition	Azimuth (°)	Height (m)	Comment	AF (dB)	CL (dB)	PA (dB)
PK	4.95824G	48.24	74.00	-25.76	39.92	3	Vertical	212	1.64	-	32.93	6.70	31.31
AV	4.96996G	35.52	54.00	-18.48	27.14	3	Vertical	212	1.64	-	32.98	6.70	31.30
PK	7.43504G	52.94	74.00	-21.06	41.70	3	Vertical	289	2.82	-	36.03	7.99	32.78
AV	7.43288G	40.95	54.00	-13.05	29.71	3	Vertical	289	2.82	-	36.03	7.98	32.77

2.4-2.4835GHz_BT-LE(1Mbps)

2480MHz_TX

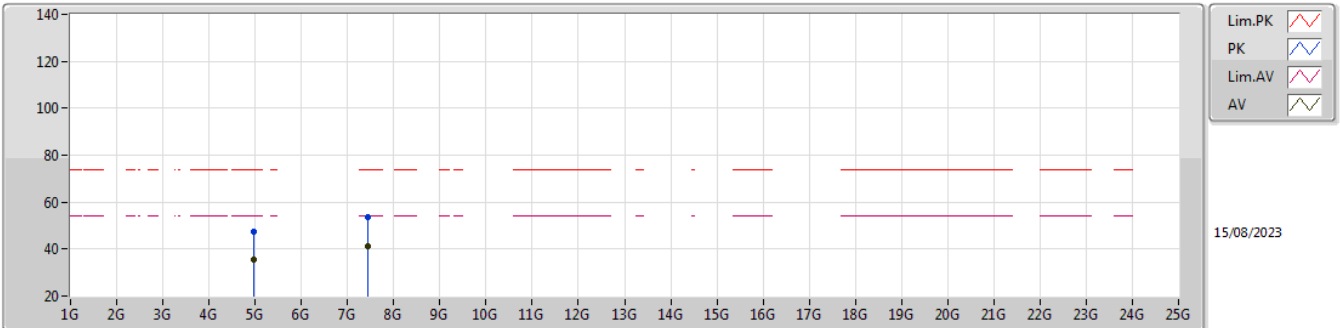

EUT_Z_1TX
Setting Default
06-D-M-2

Type	Freq (Hz)	Level (dBuV/m)	Limit (dBuV/m)	Margin (dB)	Raw (dBuV)	Dist (m)	Condition	Azimuth (°)	Height (m)	Comment	AF (dB)	CL (dB)	PA (dB)
PK	4.95732G	47.44	74.00	-26.56	39.12	3	Horizontal	42	2.40	-	32.93	6.70	31.31
AV	4.96764G	35.56	54.00	-18.44	27.19	3	Horizontal	42	2.40	-	32.97	6.70	31.30
PK	7.43616G	53.64	74.00	-20.36	42.40	3	Horizontal	133	1.63	-	36.03	7.99	32.78
AV	7.4316G	41.09	54.00	-12.91	29.84	3	Horizontal	133	1.63	-	36.04	7.98	32.77

2.4-2.4835GHz_BT-LE(2Mbps)

2402MHz_TX

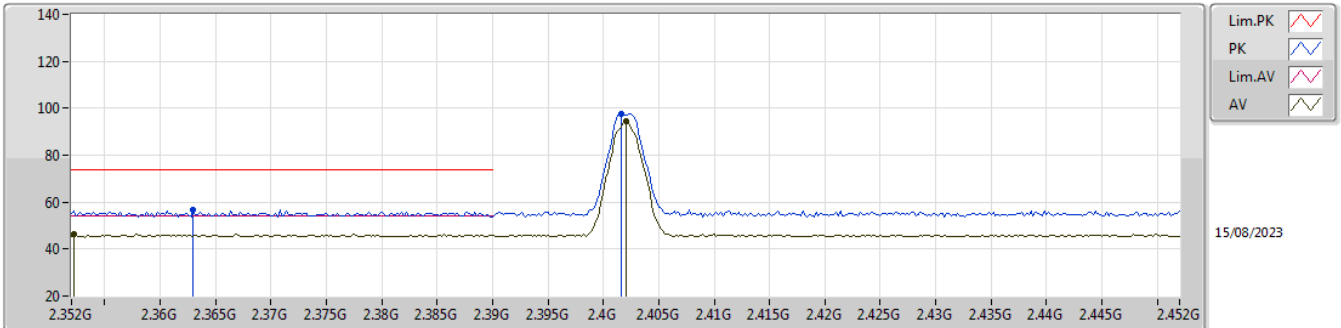





EUT_Z_1TX
Setting Default
06-D-M-2

Type	Freq (Hz)	Level (dBuV/m)	Limit (dBuV/m)	Margin (dB)	Raw (dBuV)	Dist (m)	Condition	Azimuth (°)	Height (m)	Comment	AF (dB)	CL (dB)	PA (dB)
PK	2.363G	56.52	74.00	-17.48	24.46	3	Vertical	87	1.00	-	27.25	4.81	-
AV	2.3522G	46.40	54.00	-7.60	14.41	3	Vertical	87	1.00	-	27.21	4.78	-
PK	2.4016G	97.39	Inf	-Inf	65.09	3	Vertical	87	1.00	-	27.40	4.90	-
AV	2.402G	94.47	Inf	-Inf	62.17	3	Vertical	87	1.00	-	27.40	4.90	-

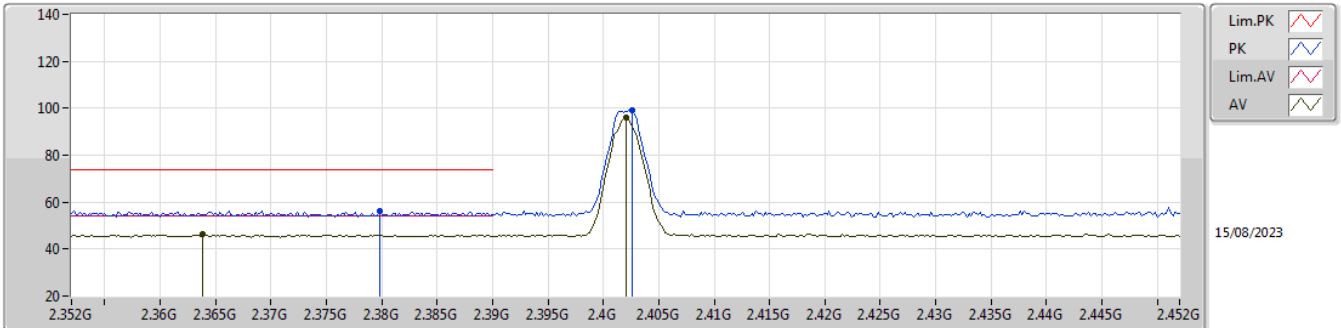
2.4-2.4835GHz_BT-LE(2Mbps)

2402MHz_TX



Lim.PK 
 PK 
 Lim.AV 
 AV 

15/08/2023

EUT_Z_1TX
 Setting Default
 06-D-M-2

Type	Freq (Hz)	Level (dBuV/m)	Limit (dBuV/m)	Margin (dB)	Raw (dBuV)	Dist (m)	Condition	Azimuth (°)	Height (m)	Comment	AF (dB)	CL (dB)	PA (dB)
PK	2.3798G	56.37	74.00	-17.63	24.20	3	Horizontal	42	1.07	-	27.32	4.85	-
AV	2.3638G	46.33	54.00	-7.67	14.26	3	Horizontal	42	1.07	-	27.26	4.81	-
PK	2.4026G	98.94	Inf	-Inf	66.63	3	Horizontal	42	1.07	-	27.41	4.90	-
AV	2.402G	96.04	Inf	-Inf	63.74	3	Horizontal	42	1.07	-	27.40	4.90	-

2.4-2.4835GHz_BT-LE(2Mbps)

2402MHz_TX

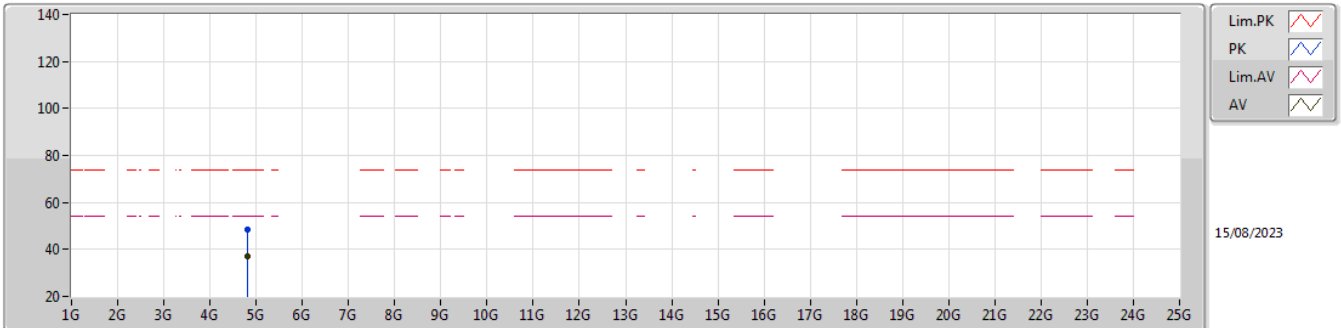

EUT_Z_1TX
Setting Default
06-D-M-2

Type	Freq (Hz)	Level (dBuV/m)	Limit (dBuV/m)	Margin (dB)	Raw (dBuV)	Dist (m)	Condition	Azimuth (°)	Height (m)	Comment	AF (dB)	CL (dB)	PA (dB)
PK	4.79972G	48.19	74.00	-25.81	40.81	3	Vertical	116	1.80	-	32.10	6.70	31.42
AV	4.80452G	36.82	54.00	-17.18	29.41	3	Vertical	116	1.80	-	32.13	6.70	31.42

2.4-2.4835GHz_BT-LE(2Mbps)

2402MHz_TX

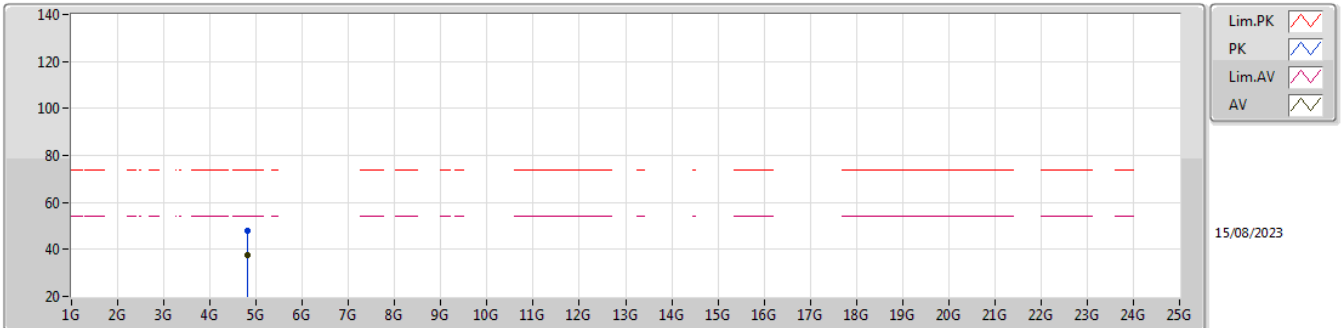

EUT_Z_1TX
Setting Default
06-D-M-2

Type	Freq (Hz)	Level (dBuV/m)	Limit (dBuV/m)	Margin (dB)	Raw (dBuV)	Dist (m)	Condition	Azimuth (°)	Height (m)	Comment	AF (dB)	CL (dB)	PA (dB)
PK	4.80748G	48.05	74.00	-25.95	40.62	3	Horizontal	325	1.00	-	32.14	6.70	31.41
AV	4.80356G	37.57	54.00	-16.43	30.17	3	Horizontal	325	1.00	-	32.12	6.70	31.42

2.4-2.4835GHz_BT-LE(2Mbps)

2440MHz_TX

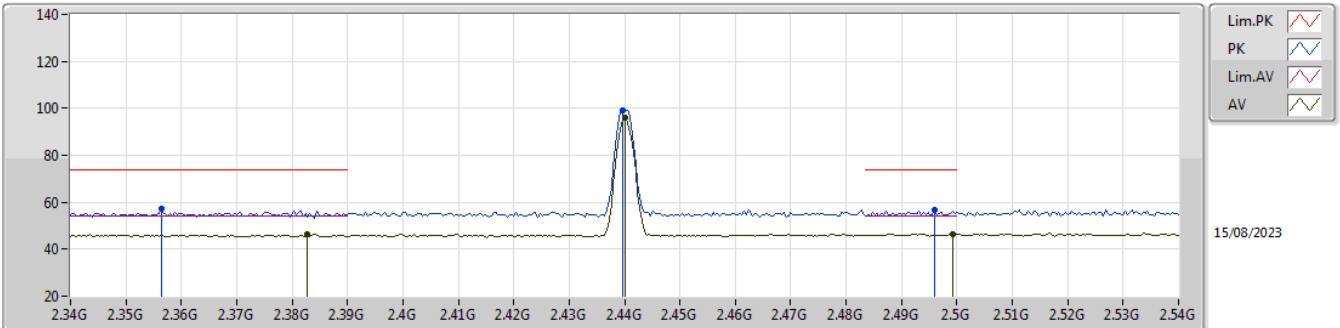

EUT_Z_1TX
Setting Default
06-D-M-2

Type	Freq (Hz)	Level (dBuV/m)	Limit (dBuV/m)	Margin (dB)	Raw (dBuV)	Dist (m)	Condition	Azimuth (°)	Height (m)	Comment	AF (dB)	CL (dB)	PA (dB)
PK	2.3564G	57.45	74.00	-16.55	25.43	3	Vertical	88	1.78	-	27.23	4.79	-
AV	2.3828G	46.36	54.00	-7.64	14.17	3	Vertical	88	1.78	-	27.33	4.86	-
PK	2.4396G	99.24	Inf	-Inf	66.88	3	Vertical	88	1.78	-	27.48	4.88	-
AV	2.44G	96.29	Inf	-Inf	63.93	3	Vertical	88	1.78	-	27.48	4.88	-
PK	2.496G	56.47	74.00	-17.53	23.84	3	Vertical	88	1.78	-	27.78	4.85	-
AV	2.4992G	46.52	54.00	-7.48	13.87	3	Vertical	88	1.78	-	27.80	4.85	-

2.4-2.4835GHz_BT-LE(2Mbps)

2440MHz_TX

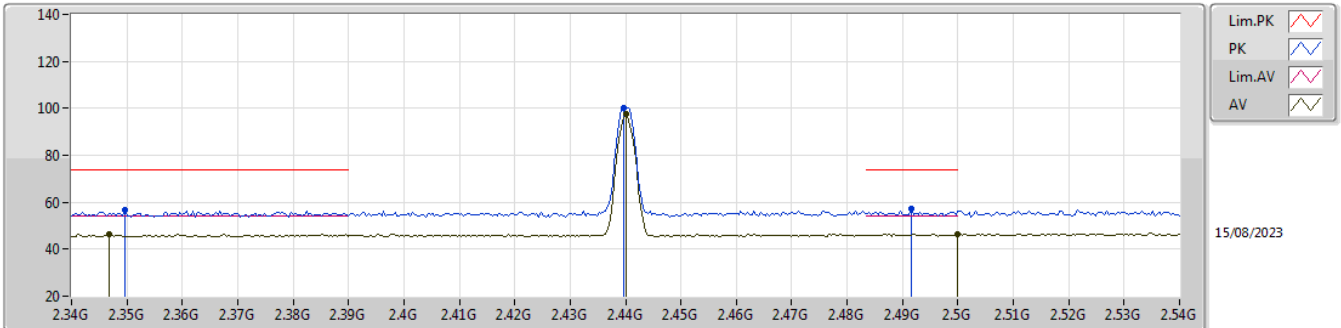

EUT_Z_1TX
Setting Default
06-D-M-2

Type	Freq (Hz)	Level (dBuV/m)	Limit (dBuV/m)	Margin (dB)	Raw (dBuV)	Dist (m)	Condition	Azimuth (°)	Height (m)	Comment	AF (dB)	CL (dB)	PA (dB)
PK	2.3496G	56.71	74.00	-17.29	24.74	3	Horizontal	51	2.65	-	27.20	4.77	-
AV	2.3468G	46.55	54.00	-7.45	14.59	3	Horizontal	51	2.65	-	27.19	4.77	-
PK	2.4396G	100.42	Inf	-Inf	68.06	3	Horizontal	51	2.65	-	27.48	4.88	-
AV	2.44G	97.37	Inf	-Inf	65.01	3	Horizontal	51	2.65	-	27.48	4.88	-
PK	2.4916G	57.12	74.00	-16.88	24.52	3	Horizontal	51	2.65	-	27.75	4.85	-
AV	2.5G	46.42	54.00	-7.58	13.77	3	Horizontal	51	2.65	-	27.80	4.85	-

2.4-2.4835GHz_BT-LE(2Mbps)

2440MHz_TX

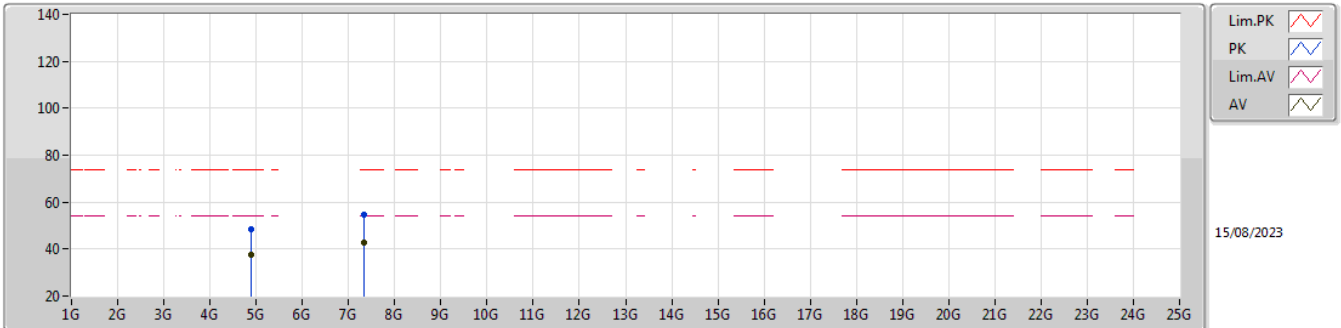

EUT_Z_1TX
Setting Default
06-D-M-2

Type	Freq (Hz)	Level (dBuV/m)	Limit (dBuV/m)	Margin (dB)	Raw (dBuV)	Dist (m)	Condition	Azimuth (°)	Height (m)	Comment	AF (dB)	CL (dB)	PA (dB)
PK	4.87936G	48.29	74.00	-25.71	40.43	3	Vertical	54	1.80	-	32.52	6.70	31.36
AV	4.88864G	37.61	54.00	-16.39	29.72	3	Vertical	54	1.80	-	32.55	6.70	31.36
PK	7.32768G	54.77	74.00	-19.23	42.85	3	Vertical	1	1.80	-	36.69	7.86	32.63
AV	7.32612G	42.99	54.00	-11.01	31.05	3	Vertical	1	1.80	-	36.70	7.86	32.62

2.4-2.4835GHz_BT-LE(2Mbps)

2440MHz_TX

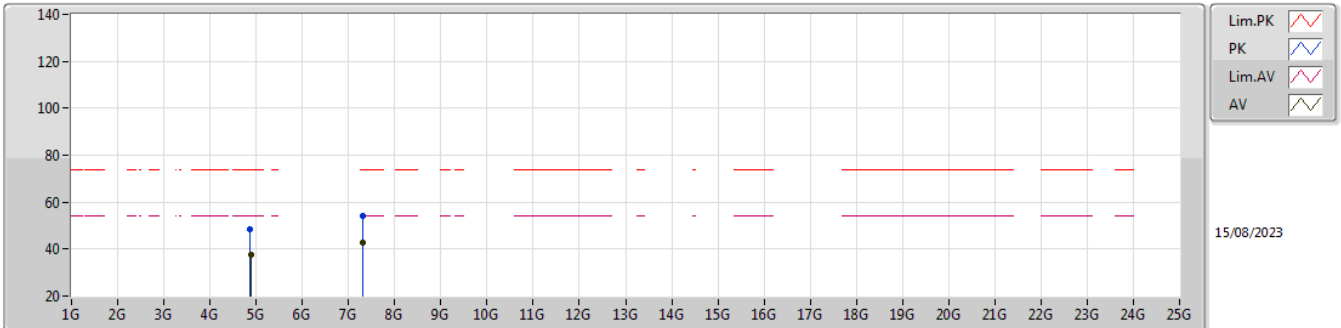

EUT_Z_1TX
Setting Default
06-D-M-2

Type	Freq (Hz)	Level (dBuV/m)	Limit (dBuV/m)	Margin (dB)	Raw (dBuV)	Dist (m)	Condition	Azimuth (°)	Height (m)	Comment	AF (dB)	CL (dB)	PA (dB)
PK	4.87576G	48.37	74.00	-25.63	40.54	3	Horizontal	279	1.80	-	32.50	6.70	31.37
AV	4.87924G	37.39	54.00	-16.61	29.53	3	Horizontal	279	1.80	-	32.52	6.70	31.36
PK	7.31304G	54.08	74.00	-19.92	42.07	3	Horizontal	11	1.80	-	36.75	7.86	32.60
AV	7.31264G	42.86	54.00	-11.14	30.85	3	Horizontal	11	1.80	-	36.75	7.86	32.60

2.4-2.4835GHz_BT-LE(2Mbps)

2480MHz_TX

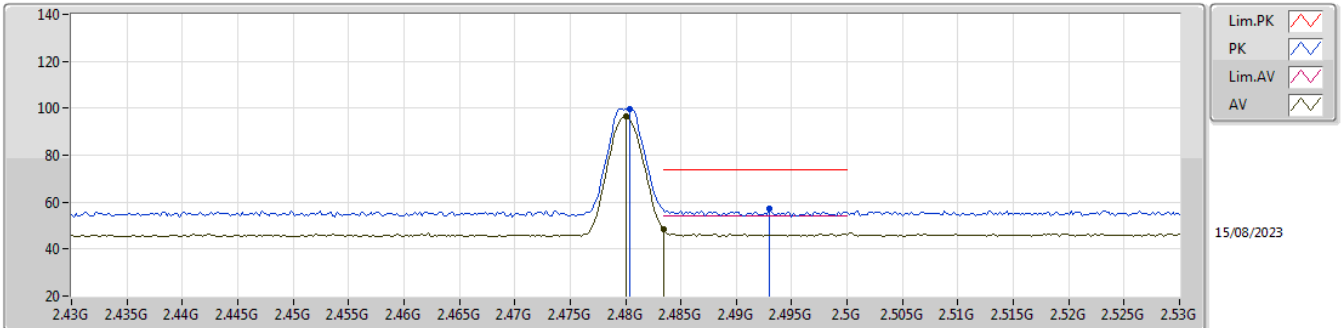

EUT_Z_1TX
Setting Default
06-D-M-2

Type	Freq (Hz)	Level (dBuV/m)	Limit (dBuV/m)	Margin (dB)	Raw (dBuV)	Dist (m)	Condition	Azimuth (°)	Height (m)	Comment	AF (dB)	CL (dB)	PA (dB)
PK	2.4804G	99.65	Inf	-Inf	67.11	3	Vertical	88	1.74	-	27.68	4.86	-
AV	2.48G	96.64	Inf	-Inf	64.10	3	Vertical	88	1.74	-	27.68	4.86	-
PK	2.493G	57.25	74.00	-16.75	24.64	3	Vertical	88	1.74	-	27.76	4.85	-
AV	2.4835G	48.53	54.00	-5.47	15.97	3	Vertical	88	1.74	-	27.70	4.86	-

2.4-2.4835GHz_BT-LE(2Mbps)

2480MHz_TX

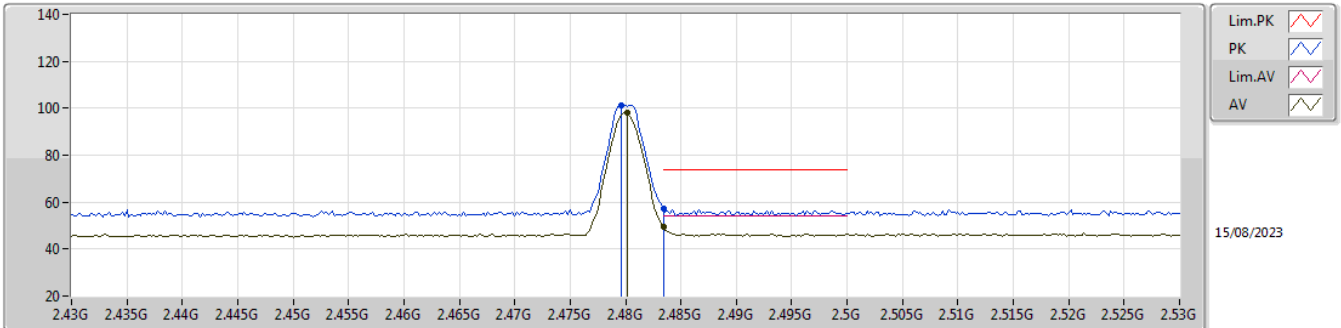

EUT_Z_1TX
Setting Default
06-D-M-2

Type	Freq (Hz)	Level (dBuV/m)	Limit (dBuV/m)	Margin (dB)	Raw (dBuV)	Dist (m)	Condition	Azimuth (°)	Height (m)	Comment	AF (dB)	CL (dB)	PA (dB)
PK	2.4796G	101.22	Inf	-Inf	68.68	3	Horizontal	53	2.59	-	27.68	4.86	-
AV	2.4802G	98.31	Inf	-Inf	65.77	3	Horizontal	53	2.59	-	27.68	4.86	-
PK	2.4835G	57.42	74.00	-16.58	24.86	3	Horizontal	53	2.59	-	27.70	4.86	-
AV	2.4835G	49.30	54.00	-4.70	16.74	3	Horizontal	53	2.59	-	27.70	4.86	-

2.4-2.4835GHz_BT-LE(2Mbps)

2480MHz_TX

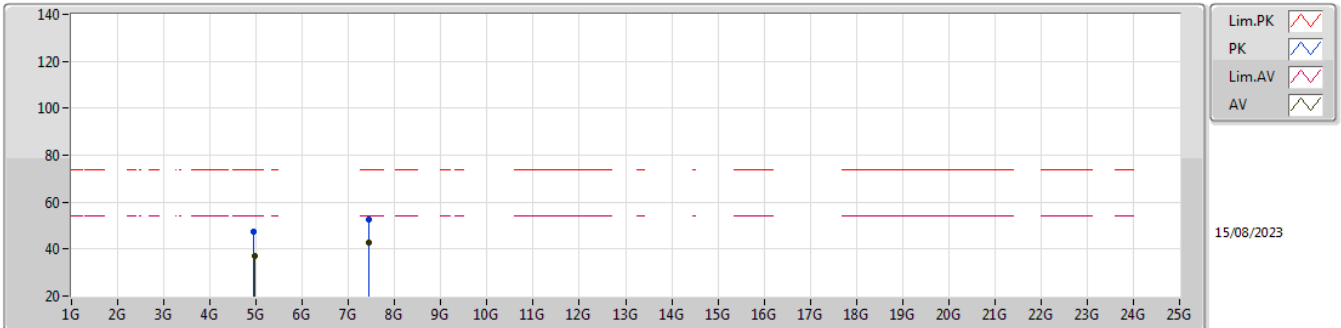

EUT_Z_1TX
Setting Default
06-D-M-2

Type	Freq (Hz)	Level (dBuV/m)	Limit (dBuV/m)	Margin (dB)	Raw (dBuV)	Dist (m)	Condition	Azimuth (°)	Height (m)	Comment	AF (dB)	CL (dB)	PA (dB)
PK	4.95G	47.50	74.00	-26.50	39.22	3	Vertical	349	2.21	-	32.90	6.70	31.32
AV	4.96828G	36.87	54.00	-17.13	28.50	3	Vertical	349	2.21	-	32.97	6.70	31.30
PK	7.43684G	52.81	74.00	-21.19	41.57	3	Vertical	107	1.34	-	36.03	7.99	32.78
AV	7.44604G	42.80	54.00	-11.20	31.56	3	Vertical	107	1.34	-	36.01	8.02	32.79

2.4-2.4835GHz_BT-LE(2Mbps)

2480MHz_TX

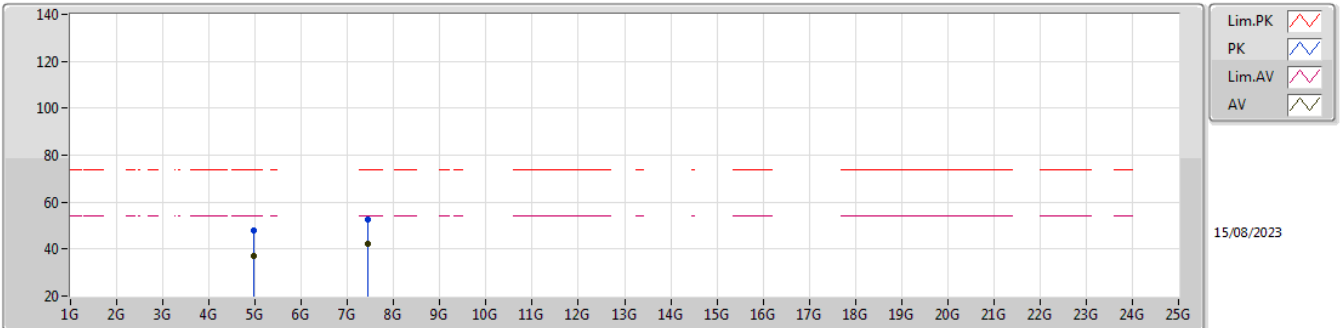

EUT_Z_1TX
Setting Default
06-D-M-2

Type	Freq (Hz)	Level (dBuV/m)	Limit (dBuV/m)	Margin (dB)	Raw (dBuV)	Dist (m)	Condition	Azimuth (°)	Height (m)	Comment	AF (dB)	CL (dB)	PA (dB)
PK	4.9698G	47.91	74.00	-26.09	39.53	3	Horizontal	298	1.87	-	32.98	6.70	31.30
AV	4.96496G	36.98	54.00	-17.02	28.62	3	Horizontal	298	1.87	-	32.96	6.70	31.30
PK	7.43136G	52.65	74.00	-21.35	41.40	3	Horizontal	112	2.99	-	36.04	7.98	32.77
AV	7.43772G	42.04	54.00	-11.96	30.81	3	Horizontal	112	2.99	-	36.02	7.99	32.78