

Yaber  
Entertainment Projector

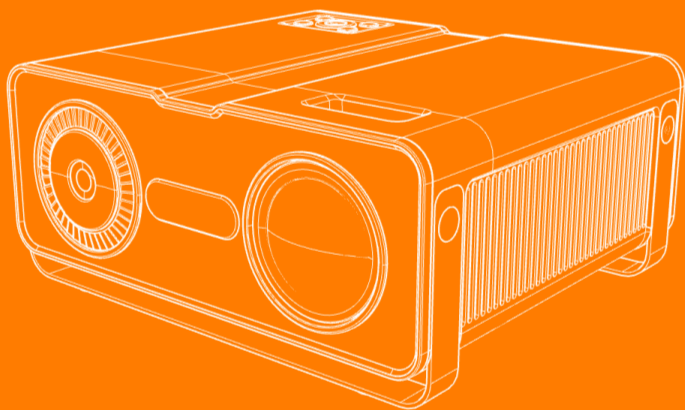

V10 Projector

# CONTENTS

YABER Lifetime Professional Support .....	01
TIPS .....	01
PACKAGE LIS .....	02
PROJECTOR SPECIFICATIONS .....	02
PROJECTOR OVERVIEW.....	03
REMOTE CONTROL .....	05
INSTALLATION .....	06
1.Installation Method .....	06
2.Projection Distance and Size .....	07
3.Install on the Ceiling .....	07
STARTING PROJECTORR.....	08
IMAGEADJUSTMENT .....	08
1.Focus Adjustment .....	08
2.Digital 4D Keystone Correction .....	09
SETTING UP THE PROJECTOR.....	09
1.Select The Input Signal Source .....	09
2.USB Disk Input Mode .....	10
3.WiFi Setting.....	12
3.1.iOS Cast(for iOS Devices) .....	13
3.2.Miracast(for Android Devices).....	14
4.Bluetooth Setting .....	15
5.Projector Image Setting .....	15
5.1.Projection Mode .....	15
5.2.Four Point Keystone Correction .....	16
5.3.Digital Zoom .....	17
6.System Update.....	18
7.Other Setting .....	19
8.Date .....	20
9.About .....	20
SIGNAL LINES CONNECTION .....	21
1.Connect USB Disk .....	21
2.Connect the Devicesvia the HDMI ports .....	21
3.Connect to the DVD Player .....	22
4.Connect to the Soundbar/Speaker .....	22

## YABER Lifetime Professional Support

Dear customer,

Thank you very much for supporting YABER!

Please read this manual thoroughly before using the projector. If you have any issues, email your order number and the problem to

[Support@yabertech.com](mailto:Support@yabertech.com). We will provide a fast solution in 24 hours.

Actually, many problems can be easily solved by setting, such as no signal, no sound, bluetooth connection failed, WiFi connection failed, dark spots, choppy animation etc. We promise all the projectors have been 100% carefully checked and packaged before shipping.

If you have any questions, could you please contact us so that the problem can be solved. And give us an opportunity to improve. We guarantee we will provide you a satisfactory solution.

Thanks for your understanding!

YABER Service Team

### TIPS:

1. Do not place projector in too warm or too cold room, because the high temperature or low temperature will shorten lifespan of the device. The working environment would be 5°C~35°C better.
2. If there are black spots on the projection screen, please don't worry, please contact [Support@yabertech.com](mailto:Support@yabertech.com) via email, we can send you a video about how to remove the dust.
3. The ventilation is equipped for the projector to work stably. Don't cover the vent with cloth, blanket or other things. Don't insert anything into the slit of the projector, or it may produce a short circuit or an electric shock to your device and cause damage.
4. The projector shall be strictly protected from strong impact, extrusion and vibration. Do not try to move and on strong impact, extrusion and vibration. Do not try to move and the internal circuit faults.
5. Lens, as the core component of the projector, is directly related to the picture definition and effect. The excessive dust thereon will affect image quality. The dirty lens shall be wiped with soft cotton cloth for the glass lens surface. Hard cloth or abrasives shall not be used.

## PACKAGE LIST

V10 Projector*1	Remote Control*1	Power Cord*1
HDMI Cable*1	3-in-1 AV Cable	Lens Cover*1
Cleaning Cloth*1	User Manual*1	Cleaning kit*1

## PROJECTOR SPECIFICATIONS

Model V10			
Native Resolution	1920*1080P	Keystone Correction	Manual Vertical & Horizontal
Display Technology	LCD	Light Source	LED
Color Game	16.7M Full	Aspect Ratio	4:3/16:9
Recommended Projection Distance	6ft-9ft	Minimum Projection Distance	4.5ft
Power Voltage	AC100-240V	Projector Weight	4lb
Picture File	JPG/JPEG/ BMP/PNG	Interfaces	HDMI*2/USB*2/3.5mm Headphone jack/AV/VGA
Projection Method	Front/Rear on Desk, Front/ Rear on Ceiling		
Video File	AVI/.MP4/.MKV/.FLV/.MOV/.3GP/.MPEG1/.MPEG2/ H.264/.XVID		
Audio File	AAC/MP2/MP3/PCM/FLAC/		

## PROJECTOR OVERVIEW

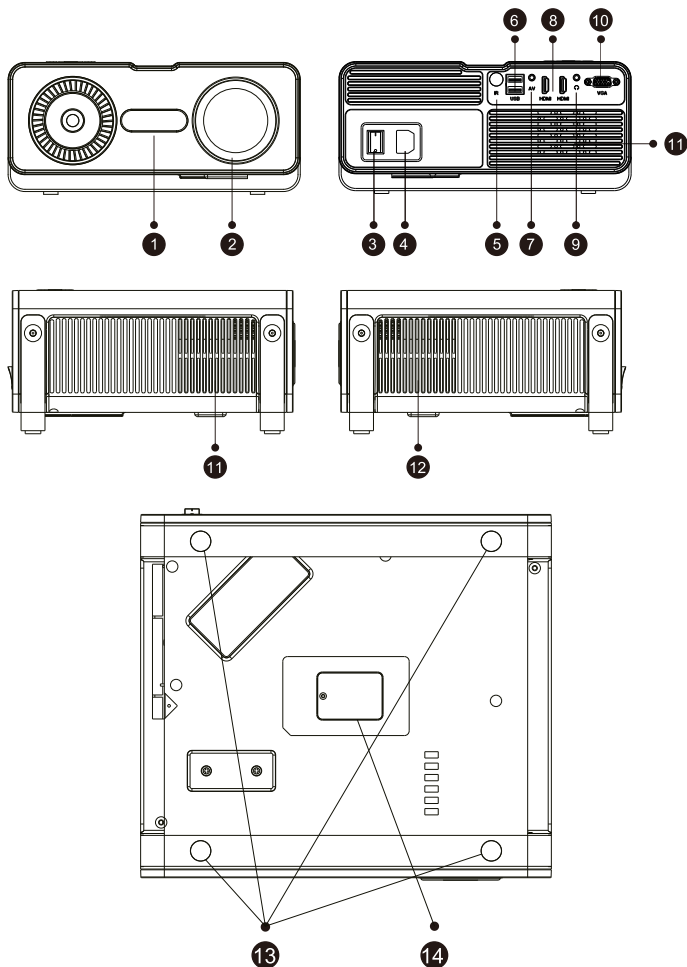

1	Yaber logo	Yaber Nameplate
2	Project lens	Optical coated glass lens
3	Power indicator	When the power is connected, the projector power indicator lights up red
4	Power Cord Port	Power Cord Port
5	IR window	Infrarot-Signalempfänger
6	USB Port	USB port1/USB port2
7	AV Port	Audio input
8	HDMI Ports	HDMI 1 input / HDMI 2 input
9	Audio output	3.5mm audio output jack
10	VGA input connector	VGA input connector
11	Air Outlet	Prevent the projector from overheating
12	Air Inlet	Circulate inside and outside air
13	Rubber Pads	Protective pads/remove to install ceiling mount
14	Dust cleaning port	When black spots and dust appear on the screen, open the Port to clean the dust

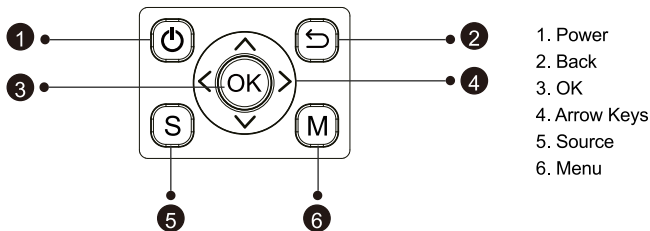

1	Power	Turn on/off the power
2	Back	Return to the previous menu
3	OK	Confirm the option
4	Arrow Keys	Used to adjust the parameter of the projector in the menu mode
5	Source	Enter the signal source selection interface
6	Menu	Enter the menu interface

## REMOTE CONTROL

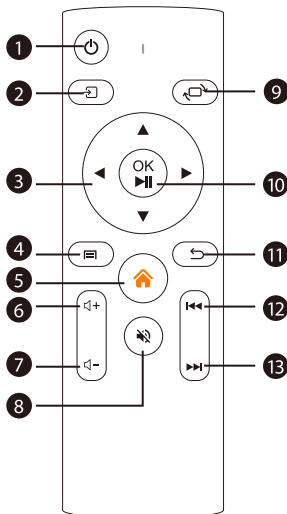

1. Power
2. Source
3. Arrow keys
4. Menu
5. Homepage
6. Volume +
7. Volume -
8. Mute
9. Picture flip
10. Confirmation key (Play and Pause)
11. Return
12. Previous
13. Next

1		Turn on/off the power
2		Select the input signal source
3		Used to adjust the parameter of the projector in the menu mode
4		Press once: Back to the menu interface Press twice in succession: select 16:9/4:3 projection screen ratio
5		Enter the home page
6		Volume up
7		Volume down
8		Close the sound
9		Picture flips
10		Confirm the option/Play or pause the video
11		Return to the previous menu
12		Switch to the previous video
13		Switch to the next video

## Note:

- 1).Install 2 pieces of AAA batteries into the remote before using it. Do not combine new batteries with old ones in remote controller, which can cause operation failure due to insufficient power supply.
- 2).When using the remote controller, please make sure that the signal transmitter of the remote controller aims at infrared signal receiver of the projector.
- 3).If you are not using the remote controller for an extended period, please take out batteries to prevent batteries leakage.

## INSTALLATION

### 1. Installation Method

The projector can be hung on the ceiling with special hanger frame, and placed on the stable desk to project the image according to the operating environment and requirements. In addition, the projector can be installed with following methods:

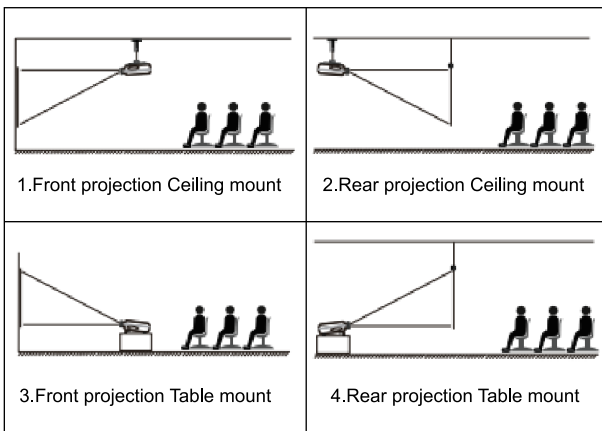

Keep the projector at a height where its lens is axial symmetry to the screen. If this is not possible, use the keystone correction function to adjust the projection image.

If you want to get a free projection screen, please contact us via [Support@yabertech.com](mailto:Support@yabertech.com)



## 2. Projection Distance and Size

Aspect Ratio: 16:9	
Distance (ft.)	Screen Size
5.6	50"
7.1	70"
10.9	100"
12.9	120"
16.4	150"

The recommended projection distance is about 9ft, the shortest projection distance is 4.5ft.

The image size depends on the distance between projector and screen, there may be 3% deviation among above listed data. Different settings cause various distances.

## 3. Install on the Ceiling

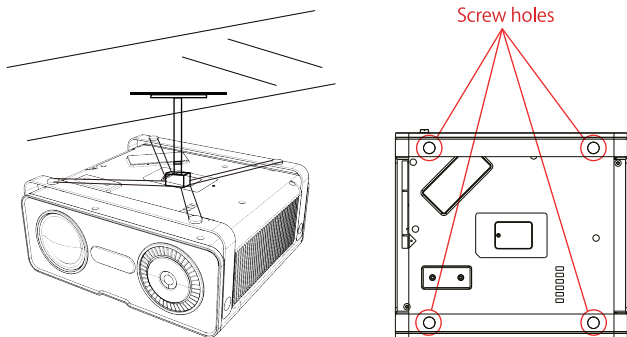

A. Please purchase an universal projector ceiling mount;

B. Remove the four rubber pads on the bottom of the projector, you will see the screw holes and use the M4 screws for installing the ceiling, and then install it.

## STARTING PROJECTOR

- 1) Press the power key on the remote or projector, the indicator light will turn Green;
- 2) Adjust the focus ring on the left side of the projector to get the best image performance; (If it is still blurry, please try to adjust the projection distance.)
- 3) Use the 4D keystone function of the projector to get a rectangle projection screen;
- 4) Connect the external device (Smart phone, iPad, Amazon Fire TV, TV box, DVD player, Computer, etc.) in the corresponding interfaces of the projector, please be sure to select the corresponding source. If you do not select the correct source, the projector will not be able to detect the signal;
- 5) Select the " ⚙️ " menu, then you can select the option [ Language ] to set your preferred language.

## IMAGE ADJUSTMENT

When using the projector for the first time, it normally displays an unclear image. This is due to the lens being out of focus or the incorrect trapezoid setting.

Please follow the below steps to correct:

### 1.Focus Adjustment

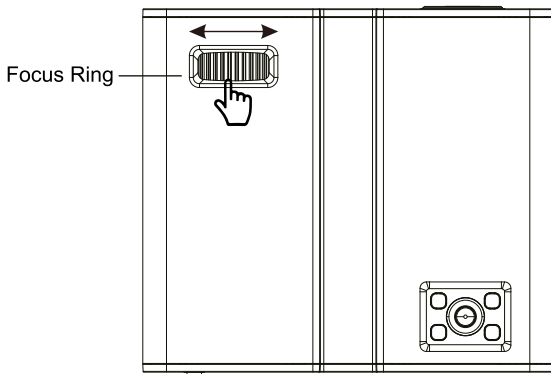

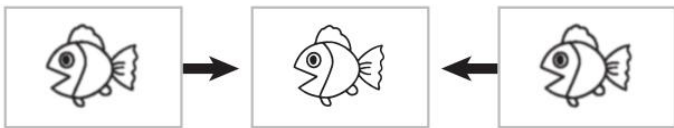

Rotate the focus ring or lens slowly. At the same time, check the focus point carefully. The best focus point for the lens would be where the image most clear.

Note: If it is still blurry, please try to adjust the projection distance.

## 2.Digital 4D Keystone Correction.

Use the digital 4D keystone correction of the projector to change the image to be rectangle(vertical and horizontal). Detail please refer the page 16 of this manual.

## SETTING UP THE PROJECTOR

The projector's home page is as follow.

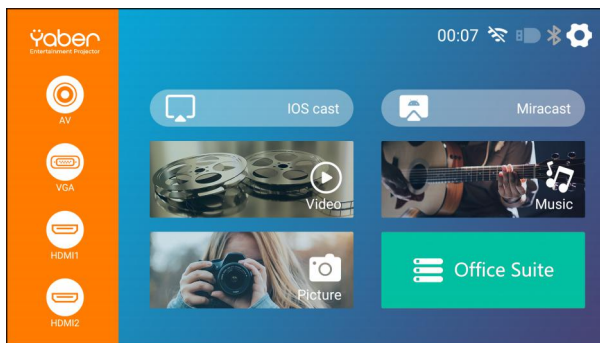

### 1.Select The Input Signal Source

Select the desired input signal source (HDMI1/HDMI2/AV) on the home-page

## 2.USB Disk Input Mode







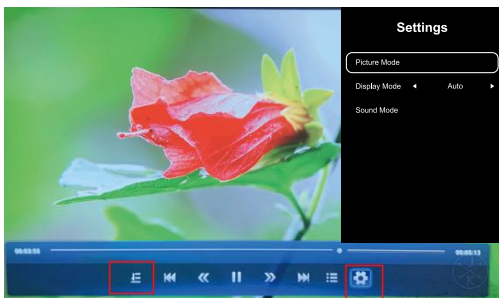

2.1.Play Movie/Music/Photo/Office Suite in the USB Disk Input Mode

- 1).Input the USB Disk, select [ Office Suite ] on the homepage and enter;
- 2).Select the option [ Movie/Music/Photo/Office Suite]
- 3).Select the desired file (or folder to enter the subfolder) in the USB disk, then press the [ OK ] button to play it.



2.2.Play Interface



Menu	Function
	Select play mode (single cycle/directory loop)
	Switch to the previous video
	Fast Backward,rewinds the video back quickly while playing it. The rewinding speed ranges from 2X to 32X
	Play or pause the current video
	Fast Forward, pushes the video to move forward quickly while playing it. The forward speed ranges from 2X to 16X
	Switch to the next video
	Select all playlists in the current folder
	TV Setting

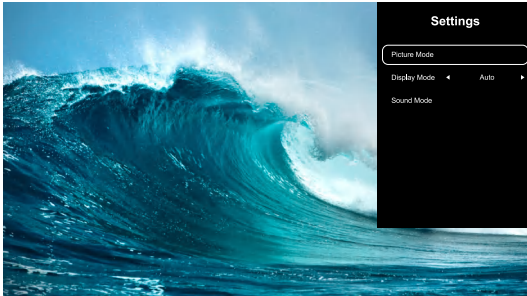

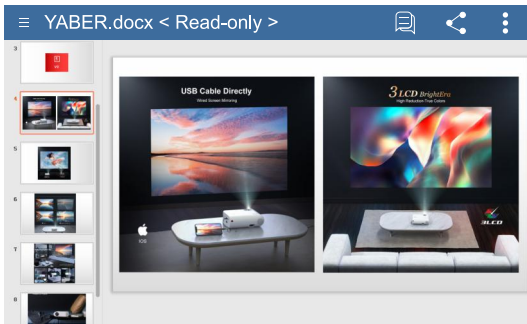

Menu	Content	Mode	Function
Picture Mode	User/Standard/Vivid/Soft	Brightness	Modify the picture parameters in the range 0-100
		Contrast	
		Saturation	
		Sharpness	
Sound Mode	Standard/News/Music/Movie/Sport/User	120Hz	Modify the sound parameters in the range 0-100
		500Hz	
		1.5KHz	
		5KHz	
		10KHz	

### 2.3.Office Suite Play Interface



By pressing the  button on the remote to enter the menus.

(Note: the Office version may be automatically updated, then the updated functions may change. Due to copyright, some functions are temporarily unavailable. Please refer to the actual version. )

Menu	Content	Function
	Invalid key, please ignore.	/
	Invalid key, please ignore.	/
	Export to PDF	Export to PDF
	Protect	/
	Start slide show	From the current slide
	Advance slides	/
	Cast Presentation	/
	Go to Slide	Quickly select the desired page
	Zoom	Fit/Fit width/Actual size
	Properties	View the properties of file
	Help	Help instructions

### 3.WiFi Setting

#### Wireless Connection

##### Warming Tips:

- ①The fluency of screen mirroring with wireless connection will be affected by the network environment. A bandwidth of 100Mbit or more is recommended when using screen mirroring.
- ②Make sure your mobile device is close to the projector when using wireless connection. A distance within 1 meter is recommended.
- ③Some mobile devices may not support screen mirroring due to the compatibility.
- ④Any questions, please feel free to email YABER via [Support@yabertech.com](mailto:Support@yabertech.com).

### 3.1.iOS Cast (for iOS Devices)

1.Go to home page -- Select the [  ] menu -- Select the [ WiFi Setting ] menu -- Open the WiFi function -- Select your home WiFi from the list – Connect the V10 projector to your home WiFi.

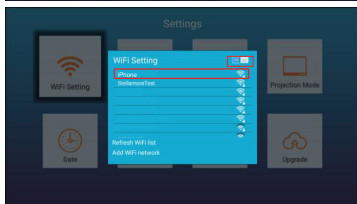
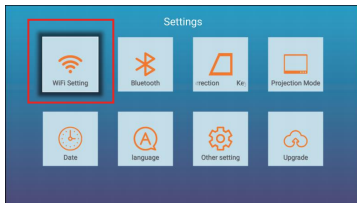
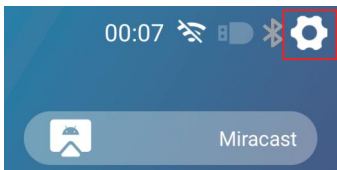

2.Back to home page -- Select [ iOS Cast ] menu -- Press the OK button to enter the [ iOS Cast ] menu.

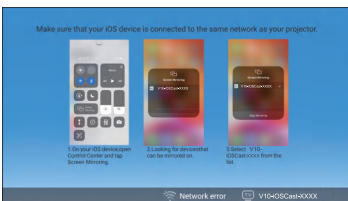
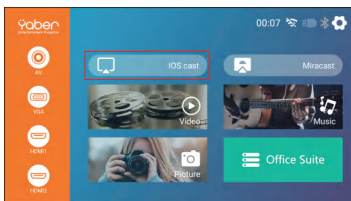

3.Select the [ Settings ] menu on your iOS device -- Turn on the [ Wi-Fi ] function -- Connect your iOS device to the same home network as the projector.

4.Open the [ Control Center ] on your iOS device -- Select the [ Screen Mirroring ] function -- Select and connect the iOS Cast receiver named [ V10-iOSCast-xxxx ] -- your iOS device screen will be displayed on the projection screen after 3 seconds.

## 3.2.Miracast (for Android Devices)

1.Go to home page -- Select the [ Miracast ] menu -- Press the OK button to enter the [ Miracast Setting ] Menu.

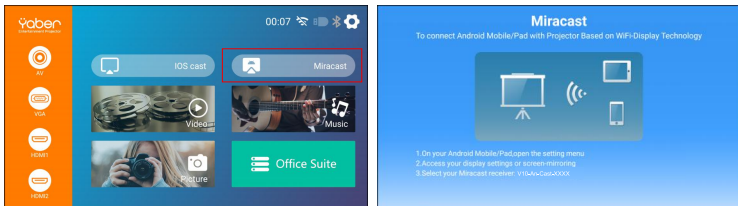

2.Select the [ Settings ] menu on your Android device -- Select the [ Screen mirroring ] function -- Select your Miracast receiver named [ V10-An-Cast-XXXX ] -- your Android device screen will be displayed on the projection screen after 3 seconds.

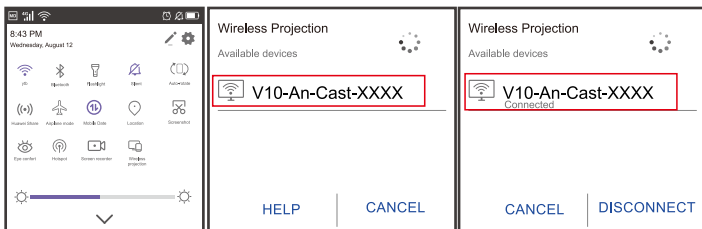

3.On your Android device, tap [ Settings ] -[ WLAN Display ] -Turn [ Wi-Fi ] ON, Connect your home WiFi.

### Note:

1.Different brands of Android phones have different operations for select Screen Mirroring Display, please refer to your phone' s manual. [ Multi-screen/Wireless display/WLAN display/Screen mirroring/Wireless projection/Smart view etc. ]

2.Not all Android phones support this function. Please make sure it is supported before use.



## 4. Bluetooth Setting

Go to home page -- Select the [  ] menu -- Select the [ Bluetooth Setting ] Option -- Open the Bluetooth function and your Bluetooth device -- Scan the Bluetooth devices nearby automatically -- Choose the Bluetooth device desired -- it will be paired and connected automatically.

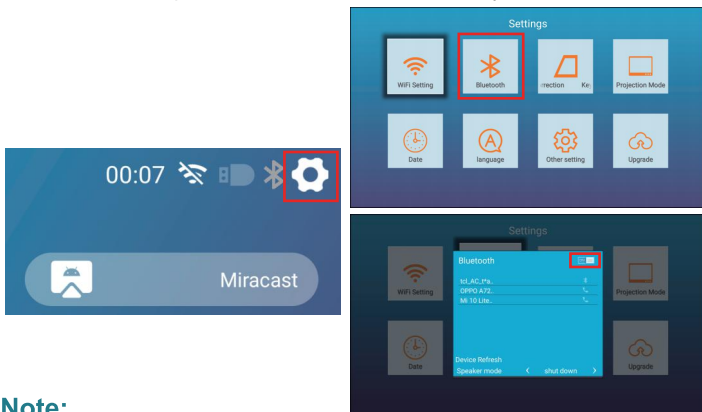

### Note:

- 1.The V10 projector is compatible with the Bluetooth headsets, Bluetooth speakers and Airpods, but not the Bluetooth keyboards or Bluetooth phones.
- 2.If you have any question, please feel free to email YABER via: support@yabertech.com

## 5.Projector Image Setting

### 5.1.Projector Mode

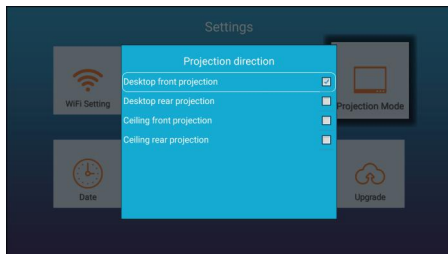

Go to home page -- Select the [  ] menu -- Select the [Projector Mode] Option---then select the four projection Direction you like.

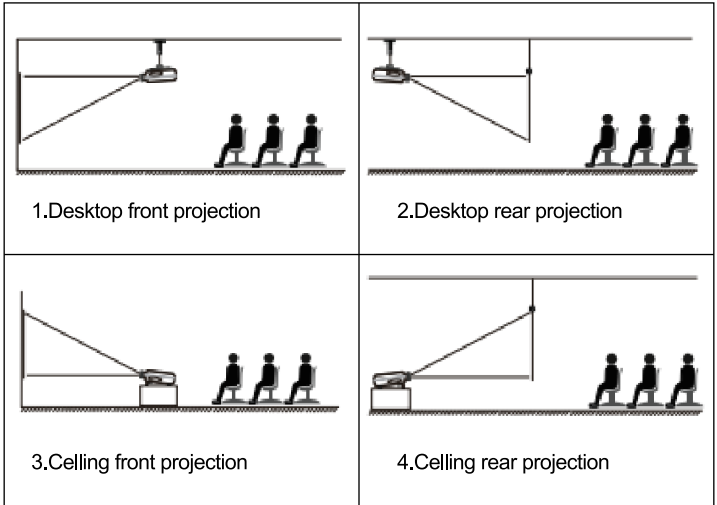

## 5.2 Four Point Keystone Correction

When the Projection screen is not rectangular,it can be adjusted by 4-poinit keystone correction.

Step 1: Go to home page -- Select the [  ] menu -- Select the [Keystone Correction] Menu;

Step 2: Press the button to select the [ 4-Point Keystone ]menu,then Press the[OK]button to enter the submenu.

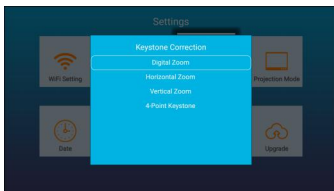

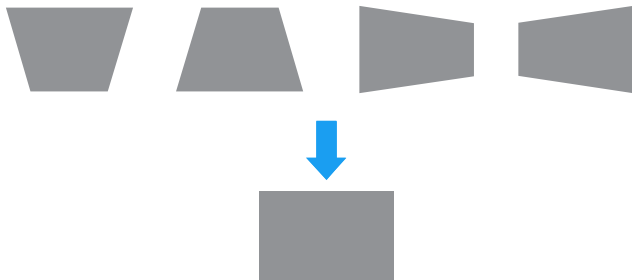

**OK Pick point** : Keep pressing the OK button on the remote control or projector, until the positioning icon  appears at the point desired, then release the button immediately.

**↔ Adjustment** : Press the arrow keys on the remote control or projector to adjust the horizontal or vertical parameters.

**↶ Back** : Press the key on the remote control to back to home page.

**☰ Reset** : Long press the MENU button on the remote to restore the original parameters.

### 5.3 Digital Zoom

Step1: Go to home page -- Select the  menu -- Select the [Keystone Correction] Menu.

Step2: Press the button to select the [Digital Zoom] menu, then Press the [OK] button to enter the submenu.

Step3: By pressing the button on the remote or projector, you can reduce the height and width of projection size up to 50%.

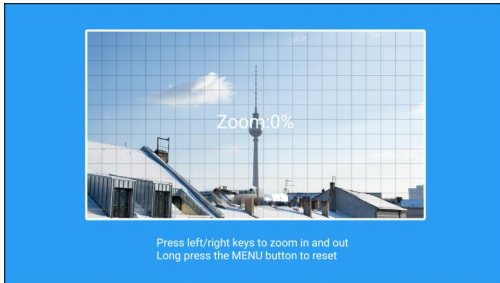
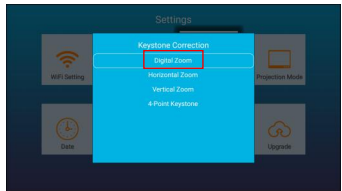
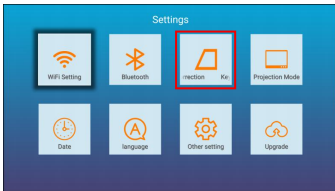

## 6.System Update

Step 1: contact Yaber to get the latest file update (Support@yabertech.com), download the software.

Step 2: Copy the software<update.zip> to the root directory of the U disk, then insert the U disk into the projector and turn on the power switch. After booting up, go to settings, system upgrades, select the U disk storing update.zip, click to confirm the upgrade, it will automatically enter the upgrade, and it will automatically restart after the upgrade is completed.

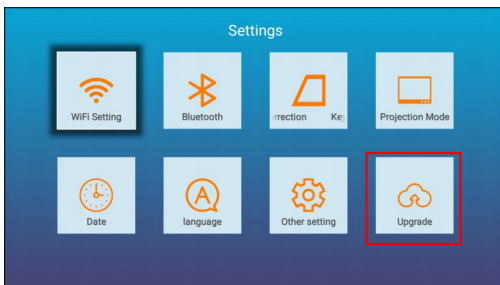

## 7.Other Setting

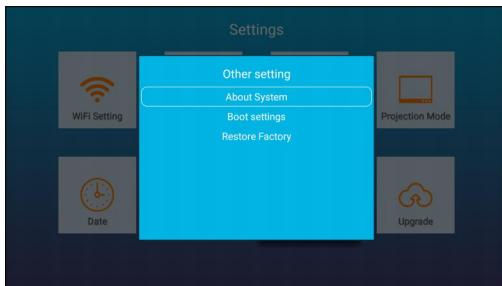
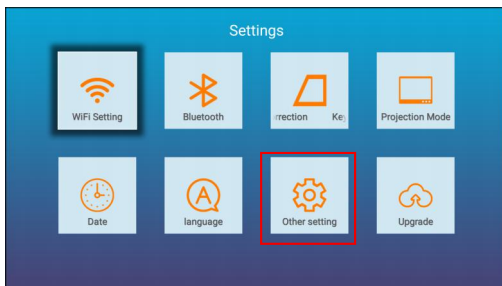

Menu	Function
About System	Detailed information about the system
Boot Settings	Set to open the home page or HDMI signal interface when powering on
Restore	Restore user operation application configuration and system setting

## 8.Date

Step1:Go to home page – Select the [  ] menu -- Select the [Date] Menu,then Press the[OK]button to enter the submenu

Step2:By pressing the button on the remote or projector, you can adjust the time and date.

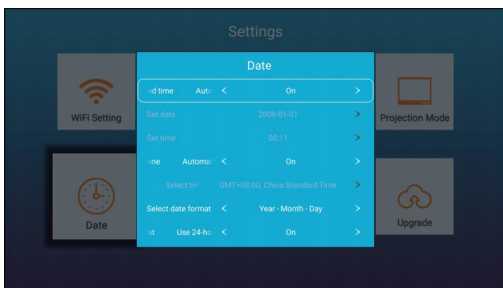
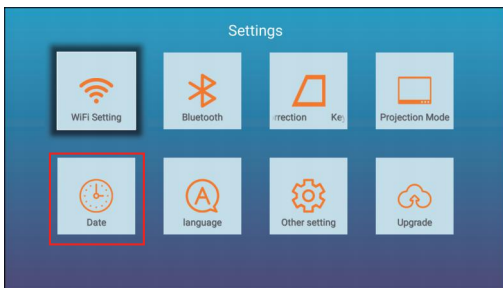

## 9.About

Menu	Content
System Version	V10-351: 2021-05-13
MAC Addressr	Ac:5d:5c:c5:d9:83

## SIGNAL LINES CONNECTION

YABER V10 projector has 7 interfaces,HDMI ports\*2/ USB ports\*2/ 3.5mm headphone output/ AV output/ VGA interface\*1.Please select the correct connecting port to connect your device(PC,Phone, DVD Player,Sound bar,USB,PS4 etc.)

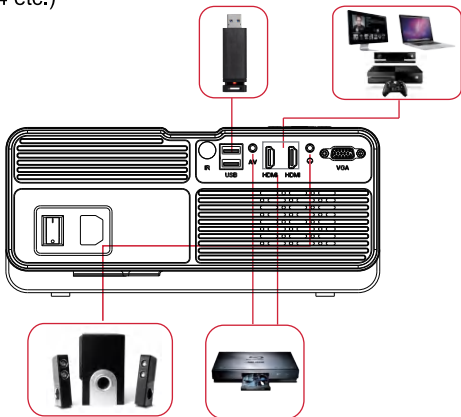

### 1.Connect USB Disk

- 1) Insert the U disk into either of the two usb input ports;
- 2) You can directly enter the start-up screen on the home page, select the option [ Movie/Music/Photo/Office Suite ]
- 3) Select the desired file (or folder to enter the subfolder) in the USB disk, then press the [ OK ] button to play it.

### 2.Connect the Devices via the HDMI ports

- 1) Connect your TV stick or laptop to any HDMI port of the projector;
- 2) Enter the home page to select the corresponding HDMI1 or HDMI2 as the signal source.

### 3.Connect to the DVD Player

Use the 3-in -1 AV cable in the package

- 1) Turn on your DVD player and the projector;
- 2) Connect the colorful female connectors to your DVD player's RCA cable with the 3-in-1 AV cable in the package;
- 3) Connect the black connector to the AV port of the projector, enter the home page to select [ AV ] as the signal source.

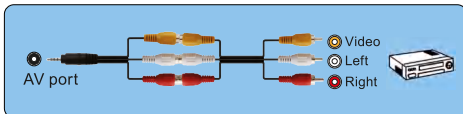
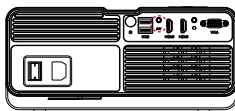

Or connect to the DVD Player with the HDMI cable in the package.

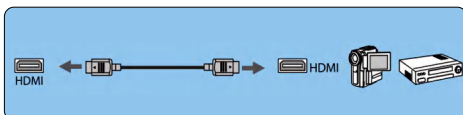
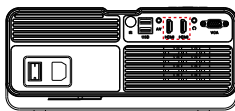

### 4.Connect to the Sound bar/Speaker

If your speaker has AUX port, please use your 3.5mm audio cable connect the projector and your speaker as the picture shows, enter the home page to select [ AV ] as the signal source.

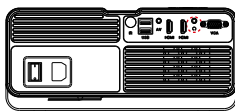

## SAFE SHUTDOWN

- 1.Press the  button on the projector or remote.
- 2.Unplug the power cord of the projector.
- 3.Cover the lens and store the projector in a cool and dry place.

## WARRANTY

Thank you so much for your purchase and support! We provide 3-year warranty for V10 projector. If you have any questions, please feel free to contact us via [Support@yabertech.com](mailto:Support@yabertech.com).



## TROUBLESHOOTING

---

Problems listed below might occur during the operation of your projector. Please refer to the possible factors which might cause the issue to do troubleshooting.

### **1. When turning on the power switch, the indicator light does not work.**

- 1) The power might not be connected well.
- 2) Check the over-heat protection system.

### **2. The remote control does not communicate with the projector.**

- 1) The power switch at the back of the projector is turned on or off?
- 2) The remote control's batteries are depleted?
- 3) Something obstructing the signal between the remote and IR
- 4) Strong light on IR directly.

### **3. No image on the screen.**

- 1) Is the channel set-up correct?
- 2) Is there an input signal ?
- 3) Is the input cable plugged well ?
- 4) Under PC mode, is the refresh rate > 75KHz ?

### **4. Blue screen,no picture,no sound.**

Input cables connected right?

### **5.Picture right, no sound.**

- 1)Input cables connected right?
- 2)Volume at min or on Mute.

### **6.Can't play the movies.**

- 1)The format of the video is right?
- 2)Files are broken?
- 3)Device is broken?

### **8. There is picture, no sound?**

The decode system doesn't match.

### **9. Can't find devices when connected with hard drive or flash drive.**

Check if the device is broken.

### **10. Auto-off after working for a while.**

- 1) The projector ventilation is blocked.
- 2) The voltage is not stable.
- 3) The over-heat protection system.

## FCC WARNING

This device complies with part 15 of the FCC Rules. Operation is subject to the following two conditions: (1) this device may not cause harmful interference, and (2) this device must accept any interference received, including interference that may cause undesired operation.

Any changes or modifications not expressly approved by the party responsible for compliance could void the user's authority to operate the equipment.

NOTE: This equipment has been tested and found to comply with the limits for a Class B digital device, pursuant to Part 15 of the FCC Rules. These limits are designed to provide reasonable protection against harmful interference in a residential installation. This equipment generates, uses and can radiate radio frequency energy and, if not installed and used in accordance with the instructions, may cause harmful interference to radio communications.

However, there is no guarantee that interference will not occur in a particular installation.

If this equipment does cause harmful interference to radio or television reception, which can be determined by turning the equipment off and on, the user is encouraged to try to correct the interference by one or more of the following measures:

- Reorient or relocate the receiving antenna.
- Increase the separation between the equipment and receiver.
- Connect the equipment into an outlet on a circuit different from that to which the receiver is connected.
- Consult the dealer or an experienced radio/TV technician for help.

To maintain compliance with FCC's RF Exposure guidelines, This equipment should be installed and operated with minimum distance between 20cm the radiator your body: Use only the supplied antenna.

**IC Caution:**

RSS-Gen Issue 5 2019"&"CNR-Gen 5 2019:

- English:

This device complies with Industry Canada licence-exempt RSS standard(s).

Operation is subject to the following two conditions: (1) This device may not cause interference, and (2) This device must accept any interference, including interference that may cause undesired operation of the device.

- French:

Le présent appareil est conforme aux CNR d'Industrie Canada applicables aux appareils radio exempts de licence. L'exploitation est autorisée aux deux conditions suivantes:

(1) l'appareil ne doit pas produire de brouillage, et

(2) l'utilisateur de l'appareil doit accepter tout brouillage radioélectrique subi, même si le brouillage est susceptible d' compromettre le fonctionnement.

Cet appareil numérique de la classe B est conforme à la norme NMB-003 du Canada. Déclaration d'exposition aux radiations Cet équipement est conforme Canada limites d'exposition aux radiations dans un environnement non contrôlé. Cet équipement doit être installé et utilisé à distance minimum de 20cm entre le radiateur et votre corps.