

Tristar Products, Inc.

TEST REPORT

SCOPE OF WORK

EMC TESTING–KJ260G-E601W

REPORT NUMBER

210106044GZU-001

ISSUE DATE

01-March-2021

[REVISED DATE]

[-----]

PAGES

86

DOCUMENT CONTROL NUMBER

FCC WIFI-d

© 2017 INTERTEK



TEST REPORT

Applicant Name & : Tristar Products, Inc.
Address : 492 Route 46 East, Fairfield, NJ 07004 USA
Manufacturing Site : JINLING ELECTRICAL APPLIANCES CO., LTD.
No. 162 Jiangcui Road, Jianghai District, Jiangmen City, G.D. China.
Intertek Report No: 210106044GZU-001
FCC ID: 2AYPRKJ260G-E601W

Test standards

47 CFR PART 15 Subpart C: 2019 section 15.247

Sample Description

Product : Air purifier
Model No. : KJ260G-E601W
Electrical Rating : 120V/60Hz, 60W, 0.5A
Serial No. : Not Labeled
Date Received : 06 January 2021
Date Test : 22 January 2021-04 February 2021
Conducted

Prepared and Checked By

Approved By:

Oscar Gao

Oscar Gao

Project Engineer

Helen Ma

Helen Ma

Team Leader

This report is for the exclusive use of Intertek's Client and is provided pursuant to the agreement between Intertek and its Client. Intertek's responsibility and liability are limited to the terms and conditions of the agreement. Intertek assumes no liability to any party, other than to the Client in accordance with the agreement, for any loss, expense or damage occasioned by the use of this report. Only the Client is authorized to permit copying or distribution of this report and then only in its entirety. Any use of the Intertek name or one of its marks for the sale or advertisement of the tested material, product or service must first be approved in writing by Intertek. The observations and test results in this report are relevant only to the sample tested. This report by itself does not imply that the material, product, or service is or has ever been under an Intertek certification program.

TEST REPORT

CONTENT

TEST REPORT 1

CONTENT 3

1.0 TEST RESULT SUMMARY 4

2.0 GENERAL DESCRIPTION..... 5

 2.1 PRODUCT DESCRIPTION 5

 2.2 RELATED SUBMITTAL(S) GRANTS 5

 2.3 TEST METHODOLOGY 6

 2.4 TEST FACILITY..... 6

3.0 SYSTEM TEST CONFIGURATION..... 6

 3.1 JUSTIFICATION 6

 3.2 EUT EXERCISING SOFTWARE..... 7

 3.3 SPECIAL ACCESSORIES..... 7

 3.4 MEASUREMENT UNCERTAINTY..... 8

 3.5 EQUIPMENT MODIFICATION 8

 3.6 SUPPORT EQUIPMENT LIST AND DESCRIPTION 9

4.0 MEASUREMENT RESULTS..... 10

 4.1 ANTENNA REQUIREMENT 10

 4.2 6 DB BANDWIDTH (DTS BANDWIDTH) 11

 4.3 DUTY CYCLE..... 18

 4.4 MAXIMUM AVERAGE CONDUCTED OUTPUT POWER..... 21

 4.5 PEAK POWER SPECTRAL DENSITY..... 23

 4.6 OUT OF BAND CONDUCTED EMISSIONS 30

 4.7 OUT OF BAND RADIATED EMISSIONS 41

 4.8 RADIATED EMISSIONS IN RESTRICTED BANDS..... 41

 4.9 BAND EDGES REQUIREMENT..... 78

 4.10 CONDUCTED EMISSION TEST..... 83

5.0 TEST EQUIPMENT LIST 86

TEST REPORT

1.0 TEST RESULT SUMMARY

Test Item	Test Requirement	Test Method	Result
Antenna Requirement	FCC PART 15 C section 15.247 (c) and Section 15.203	FCC PART 15 C section 15.247 (c) and Section 15.203	PASS
6 dB Bandwidth (DTS bandwidth)	FCC PART 15 C section 15.247 (a)(2)	ANSI C63.10: Clause 11.8	PASS
Maximum Average Conducted Output Power	FCC PART 15 C section 15.247(b)(3)	ANSI C63.10: Clause 11.9.1.2	PASS
Peak Power Spectral Density	FCC PART 15 C section 15.247(e)	ANSI C63.10: Clause 11.10.2	PASS
Out of Band Conducted Emissions	FCC PART 15 C section 15.209 & 15.247(d)	ANSI C63.10: Clause 11.11	PASS
Out of Band Radiated Emission	FCC PART 15 C section 15.209 & 15.247(d)	ANSI C63.10: Clause 11.11, 6.4, 6.5 and 6.6	N/A
Radiated Emissions in Restricted Bands	FCC PART 15 C section 15.209 & 15.247(d)	ANSI C63.10: Clause 11.12.1, 6.4, 6.5 and 6.6	PASS
Band Edges Measurement	FCC PART 15 C section 15.247 (d) & 15.205	ANSI C63.10: Clause 11.11 and 11.13	PASS
Conducted Emissions at Mains Terminals	FCC PART 15 C section 15.207	ANSI C63.10: Clause 6.2	Pass
<p>Remark: N/A: not applicable. Refer to the relative section for the details. EUT: In this whole report EUT means Equipment Under Test. Tx: In this whole report Tx (or tx) means Transmitter. Rx: In this whole report Rx (or rx) means Receiver. RF: In this whole report RF means Radio Frequency. ANSI C63.10: the detail version is ANSI C63.10:2013 in the whole report</p>			

TEST REPORT

2.0 General Description

2.1 Product Description

Operating Frequency: 2412 MHz to 2462 MHz for 802.11b/g/n(HT20)
 Type of Modulation: 802.11b: DSSS(CCK/QPSK/BPSK)
 802.11g: OFDM(BPSK/QPSK/16QAM/64QAM)
 802.11n: OFDM (BPSK/QPSK/16QAM/64QAM)
 Transmit Data Rate: 802.11b :1/2/5.5/11 Mbps
 802.11g :6/9/12/18/24/36/48/54 Mbps
 802.11n(HT20): 6.5/13/19.5/26/39/52/58.5/65 Mbps/72.2Mbps
 Number of Channels: 11 Channels for 802.11b/g/n(HT20)
 Channel Separation: 5 MHz
 Antenna Type: PCB layout
 Function: Air purifier with 2.4 GHz WIFI
 EUT Power Supply: AC 120V/60Hz
 Power cord: 1.1 m x 2 wires AC supply cable

EUT channels and frequencies list:

For 802.11b/g/n(HT20): test frequencies are lowest channel 1: 2412 MHz, middle channel 6: 2437 MHz and highest channel 11: 2462 MHz.

Channel	Frequency (MHz)	Channel	Frequency (MHz)
1	2412	7	2442
2	2417	8	2447
3	2422	9	2452
4	2427	10	2457
5	2432	11	2462
6	2437	/	

2.2 Related Submittal(s) Grants

This is an application for certification of:
 DTS- Part 15 Digital Transmission Systems (WIFI transmitter portion)

Remaining portions are subject to the following procedures:
 1. Receiver portion of WIFI: exempt from technical requirement of this Part.

TEST REPORT

2.3 Test Methodology

Both AC mains line-conducted and radiated emission measurements were performed according to the procedures in ANSI C63.10. Radiated emission measurement was performed in semi-anechoic chamber and conducted emission measurement was performed in shield room. For radiated emission measurement, preliminary scans and final tests were performed in the semi-anechoic chamber to determine the worst case modes. All radiated tests were performed at an antenna to EUT distance of 3 meters, unless stated otherwise.

2.4 Test Facility

All tests were performed at:

Intertek Testing Services Shenzhen Ltd. Guangzhou Branch
Room102/104, No 203, KeZhu Road, Science City, GETDD Guangzhou, China

Except Conducted Emissions was performed at:

Room 02, & 101/E201/E301/E401/E501/E601/E701/E801 of Room 01 1-8/F., No. 7-2. Caipin Road, Science City, GETDD, Guangzhou, Guangdong, China

A2LA Certificate Number 0078.10

Intertek Testing Services Shenzhen Ltd. Guangzhou Branch is accredited by A2LA and Listed in FCC website. FCC accredited test labs may perform both Certification testing under Parts 15 and 18 and Declaration of Conformity testing.

3.0 System Test Configuration

3.1 Justification

For emissions testing, the equipment under test (EUT) setup to transmit continuously to simplify the measurement methodology. Care was taken to ensure proper power supply voltages during testing. During testing, AC power line was manipulated to produce worst case emissions. It was powered by AC 120V/60Hz supply.

The signal is maximized through rotation. The antenna height and polarization are varied during the search for maximum signal level. The antenna height is varied from 1 to 4 meters. Radiated emissions are taken at three meters unless the signal level is too low for measurement at that distance. If necessary, a pre-amplifier is used and/or the test is conducted at a closer distance.

All readings are extrapolated back to the equivalent three meter reading using inverse scaling with distance. The spurious emissions more than 20 dB below the permissible value are not reported.

TEST REPORT

For an intentional radiator, the spectrum shall be investigated from the lowest radio frequency signal generated in the device, without going below 9 kHz, up to at least the frequency shown in the following table:

Frequency range of radiated emission measurements

Lowest frequency generated in the device	Upper frequency range of measurement
9 kHz to below 10 GHz	10 th harmonic of highest fundamental frequency or to 40 GHz, whichever is lower
At or above 10 GHz to below 30 GHz	5 th harmonic of highest fundamental frequency or to 100 GHz, whichever is lower
At or above 30 GHz	5 th harmonic of highest fundamental frequency or to 200 GHz, whichever is lower, unless otherwise specified

Number of fundamental frequencies to be tested in EUT transmit band

Frequency range in which device operates	Number of frequencies	Location in frequency range of operation
1 MHz or less	1	Middle
1 MHz to 10 MHz	2	1 near top and 1 near bottom
More than 10 MHz	3	1 near top, 1 near middle and 1 near bottom

3.2 EUT Exercising Software

Description	Manufacturer	Name	SN/Version	Supplied by
For fixing frequency	/	ESPRFTesttool	Version:2.4	Client

3.3 Special Accessories

No special accessories used.

TEST REPORT

3.4 Measurement Uncertainty

No.	Item	Measurement Uncertainty
1	20 dB Bandwidth	2.3%
	6dB Bandwidth	
	99% Bandwidth	
2	Carrier Frequencies Separated	2.3%
3	Dwell Time	1.2%
4	Maximum Peak Conducted Output Power	1.5dB
5	Peak Power Spectral Density	1.5dB
6	Out of Band Conducted Emissions	1.5dB
7	Band edges measurement	1.5dB
8	Radiated Emissions	4.7 dB (25 MHz-1 GHz)
		4.8 dB (1 GHz-18 GHz)
		5.21dB (18GZH-26GHz)
9	Conducted Emissions at Mains Terminals	2.58dB
10	Temperature	0.5 °C
11	Humidity	0.4 %
12	Time	1.2%

The measurement uncertainty describes the overall uncertainty of the given measured value during the operation of the EUT.

Measurement uncertainty is calculated in accordance with ETSI TR 100 028-2001.

The measurement uncertainty is given with a confidence of 95%, k=2.

When determining of the test conclusion, the Measurement Uncertainty of test has been considered.

Uncertainty and Compliance – Unless the standard specifically states that measured values are to be extended by the measurement uncertainty in determining compliance, all compliance determinations are based on the actual measured value

3.5 Equipment Modification

Any modifications installed previous to testing by Tristar Products, Inc. will be incorporated in each production model sold / leased in the United States.

No modifications were installed by Intertek Testing Services Shenzhen Ltd. Guangzhou Branch.

TEST REPORT

3.6 Support Equipment List and Description

The client made a continuous transmit sample for test.

This product was tested with corresponding support equipment as below:

Support Equipment

Description	Manufacturer	Model No.	SN/Version	Supplied by
Laptop	LENOVO	T430	SN:0B68191	Intertek
Fixing Frequency Board	/	CP2102	/	Client

TEST REPORT

4.0 Measurement Results

4.1 Antenna Requirement

Standard requirement:

15.203 requirement:

For intentional device. According to 15.203 an intentional radiator shall be designed to Ensure that no antenna other than that furnished by the responsible party shall be used with the device.

15.247(c) (1)(i) requirement:

(i) Systems operating in the 2400-2483.5 MHz bands that are used exclusively for fixed. Point-to-point operations may employ transmitting antennas with directional gain greater than 6 dBi provided the maximum conducted output power of the intentional radiator is reduced by 1 dB for every 3 dB that the directional gain of the antenna exceeds 6 dBi.

EUT Antenna

The antenna is a PCB layout antenna and no consideration of replacement. The best case gain of the antenna is 3dBi.

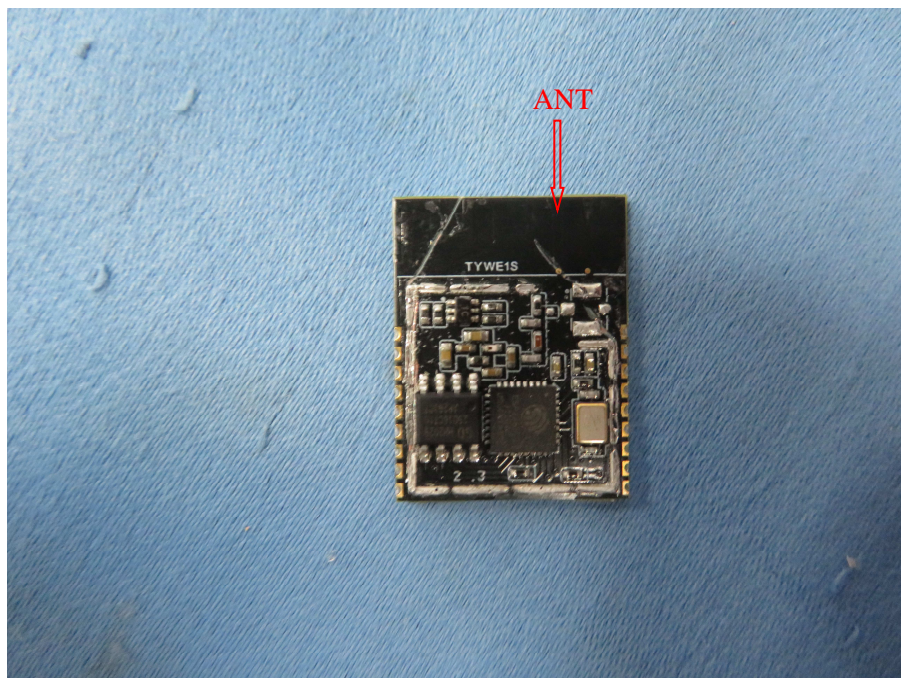

TEST REPORT

4.2 6 dB Bandwidth (DTS bandwidth)

Test Requirement:	FCC Part 15 C section 15.247 (a)(2)Systems using digital modulation techniques may operate in the 902-928 MHz, 2400-2483.5MHz, and 5725-5850 MHz bands. The minimum 6 dB bandwidth shall be at least 500 kHz.
Test Method:	ANSI C63.10: Clause 11.8
Test Status:	Pre-Scan has been conducted to determine the worst-case mode from all possible combinations between available modulations, data rates and antenna ports (if EUT with antenna diversity architecture). Following channel(s) was (were) selected for the final test as listed below.
Test Configuration:	

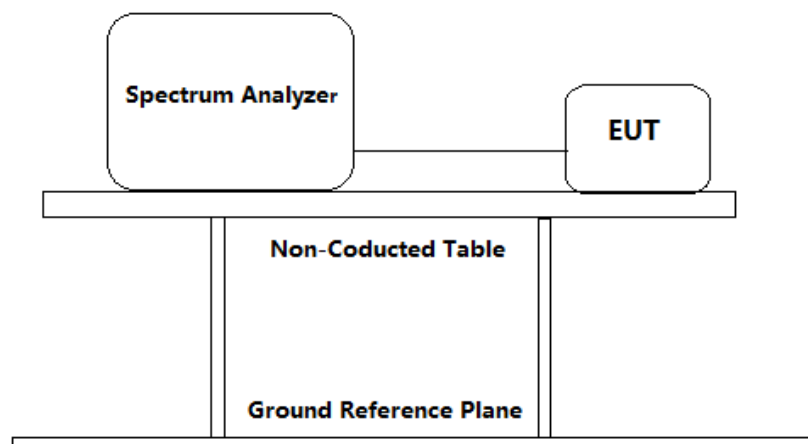

Test Procedure:

1. Remove the antenna from the EUT and then connect a low attention attenuation RF cable (cable loss =0.5 dB, with a 10dB attenuator) from the antenna port to the spectrum.
2. Set the spectrum analyzer:
 - a) Set RBW = 100 kHz
 - b) Set the VBW $\geq [3 \times \text{RBW}]$
 - c) Detector = peak.
 - d) Trace mode = max hold.
 - e) Sweep = auto couple
 - f) Allow the trace to stabilize.
 - g) Measure the maximum width of the emission that is constrained by the frequencies associated with the two outermost amplitude points (upper and lower frequencies) that are attenuated by 6 dB relative to the maximum level measured in the fundamental emission.
 - h) Span=2*BW~5*BW
3. Repeat until all the test status is investigated.

TEST REPORT

4. Report the worst case.

Used Test Equipment List

Spectrum Analyzer. Refer to Clause 5 Test Equipment List for details.

Channel No.	Frequency (MHz)	Mode	Data Rate	Measured 6dB bandwidth (MHz)	Limit	Result
1	2412	802.11b	1 Mbps	9.01	≥500KHz	Pass
6	2437		1 Mbps	8.94		Pass
11	2462		1 Mbps	9.00		Pass
1	2412	802.11g	6 Mbps	16.14		Pass
6	2437		6 Mbps	16.30		Pass
11	2462		6 Mbps	16.36		Pass
1	2412	802.11n (HT20)	6.5 Mbps	16.27		Pass
6	2437		6.5 Mbps	16.30		Pass
11	2462		6.5 Mbps	16.32		Pass

Test result: The unit does meet the FCC requirements.

TEST REPORT

Result plot as follows:

802.11b mode with 1Mbps data rate

Channel 1: 2.412GHz

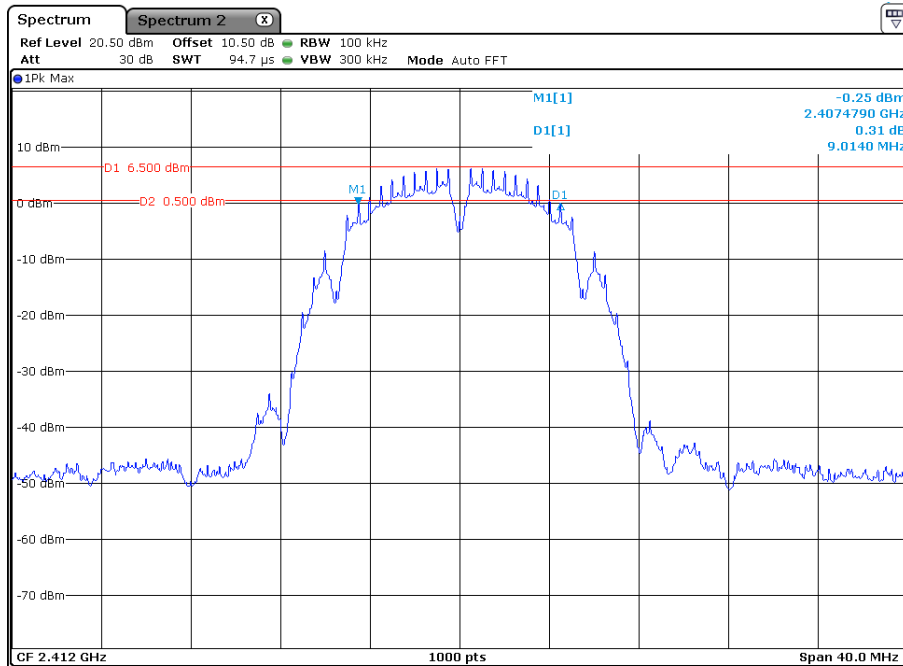

Channel 6: 2.437GHz:

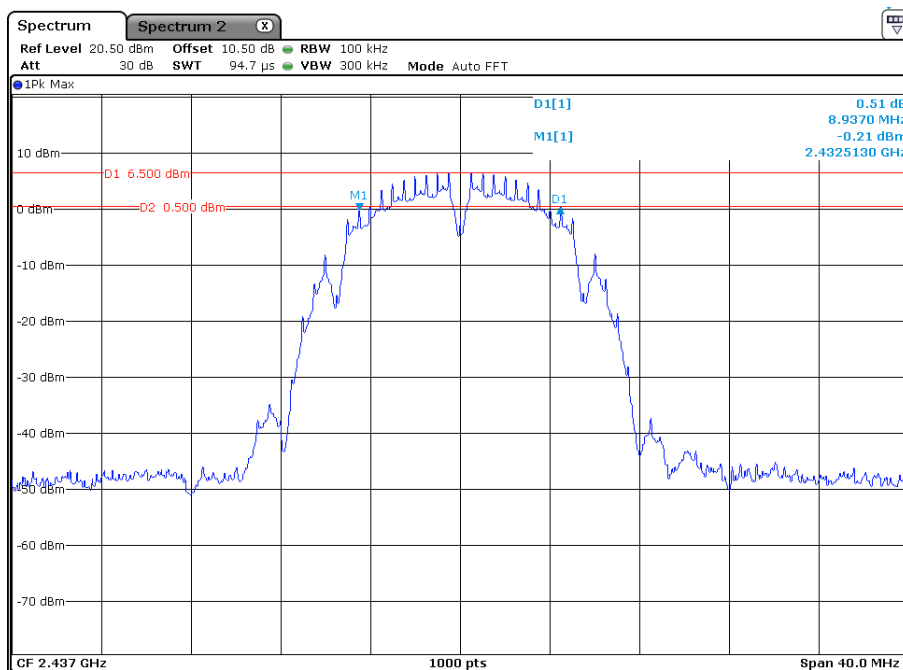

TEST REPORT

Channel 11: 2.462GHz:

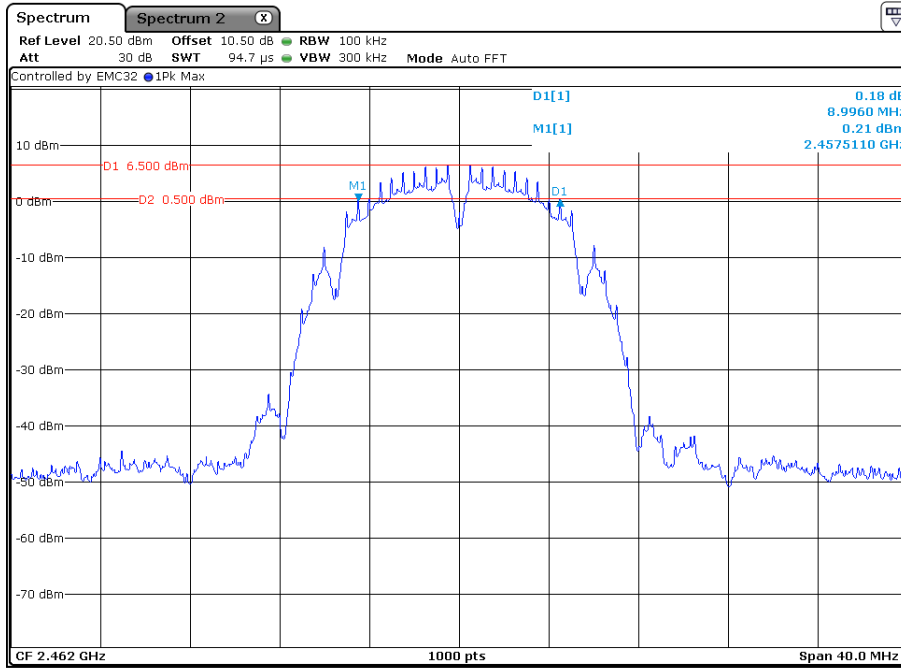

802.11g mode with 6Mbps data rate

Channel 1: 2.412GHz:

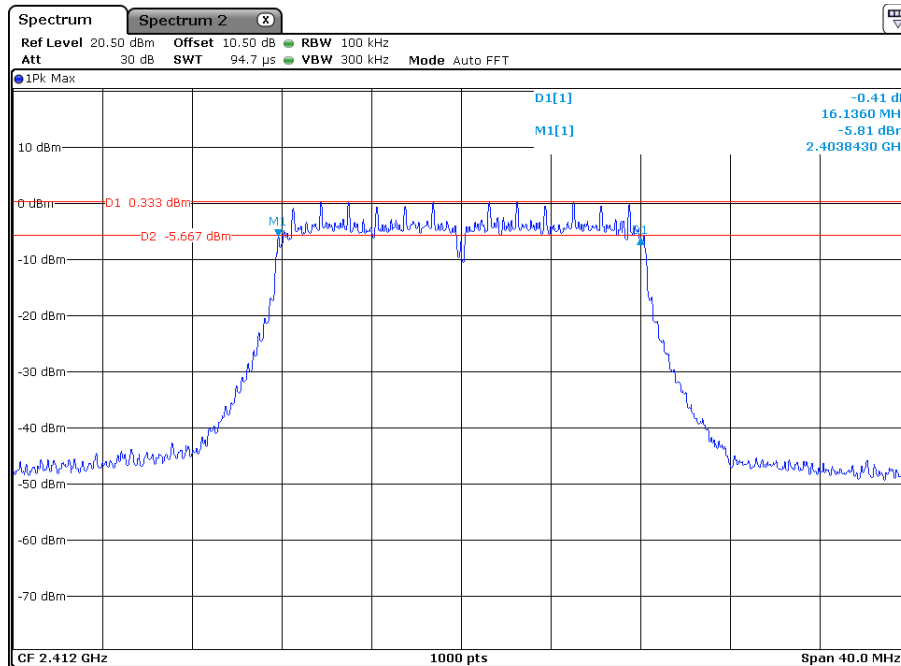

TEST REPORT

Channel 6: 2.437GHz:

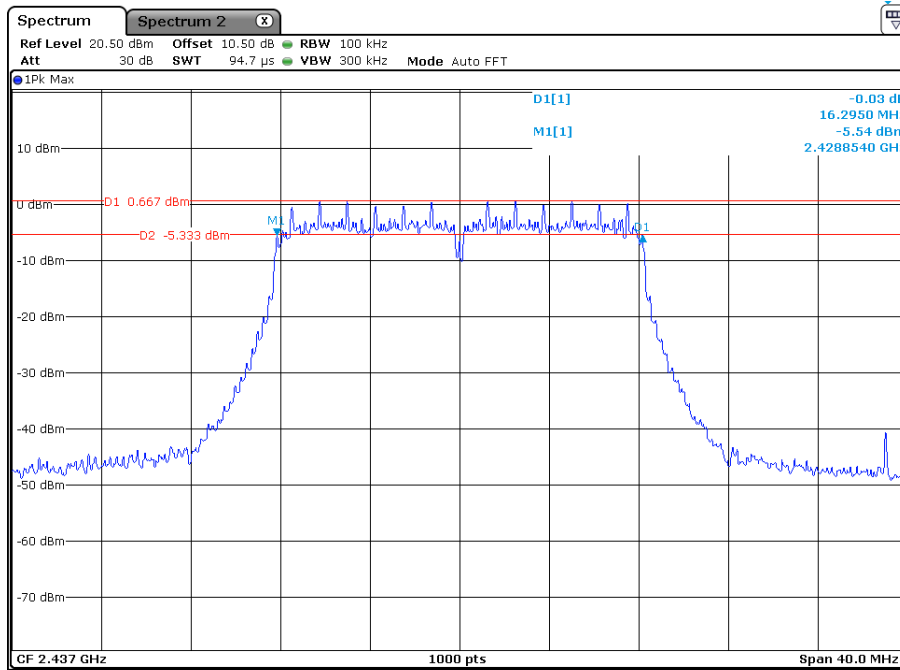

Channel 11: 2.462GHz:

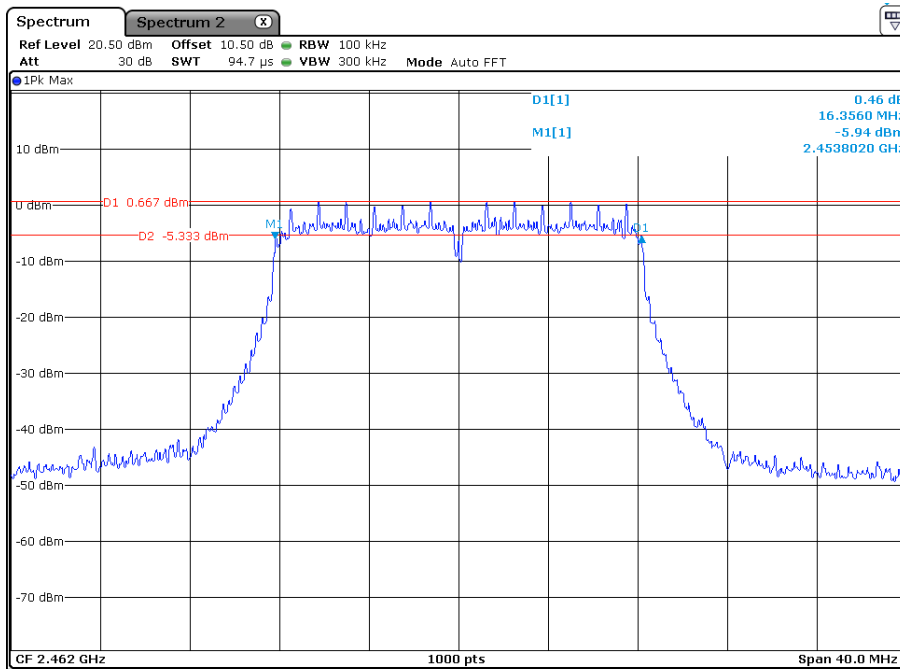

TEST REPORT

802.11n(HT20) mode with 6.5Mbps data rate

Channel 1: 2.412GHz:

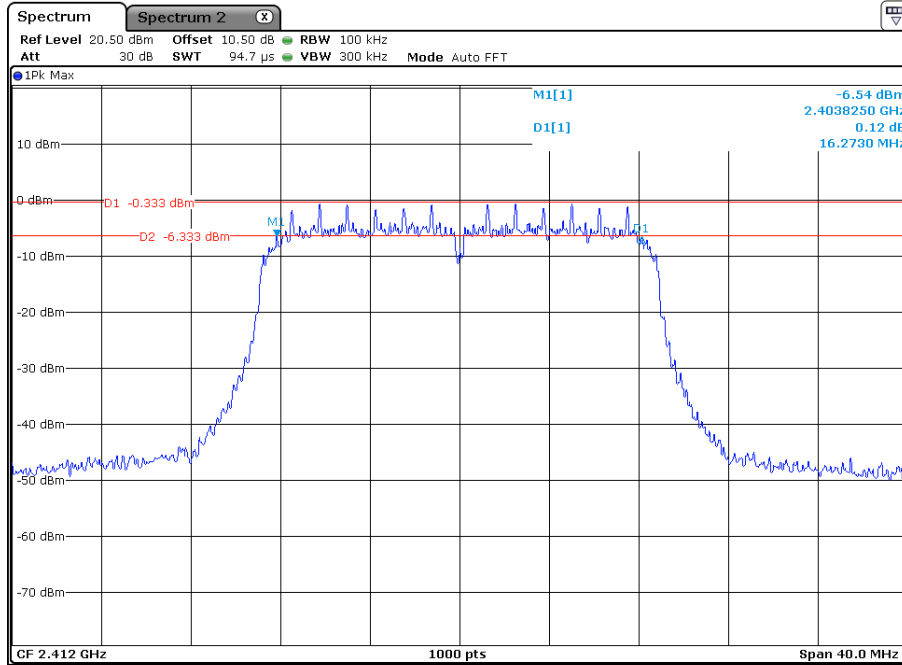

Channel 6: 2.437GHz:

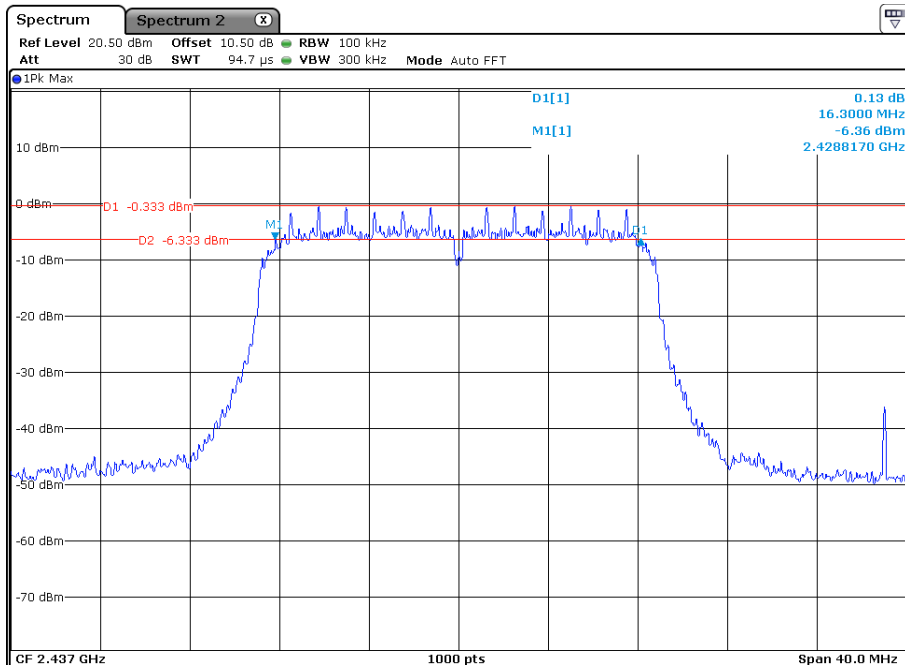

TEST REPORT

Channel 11: 2.462GHz:

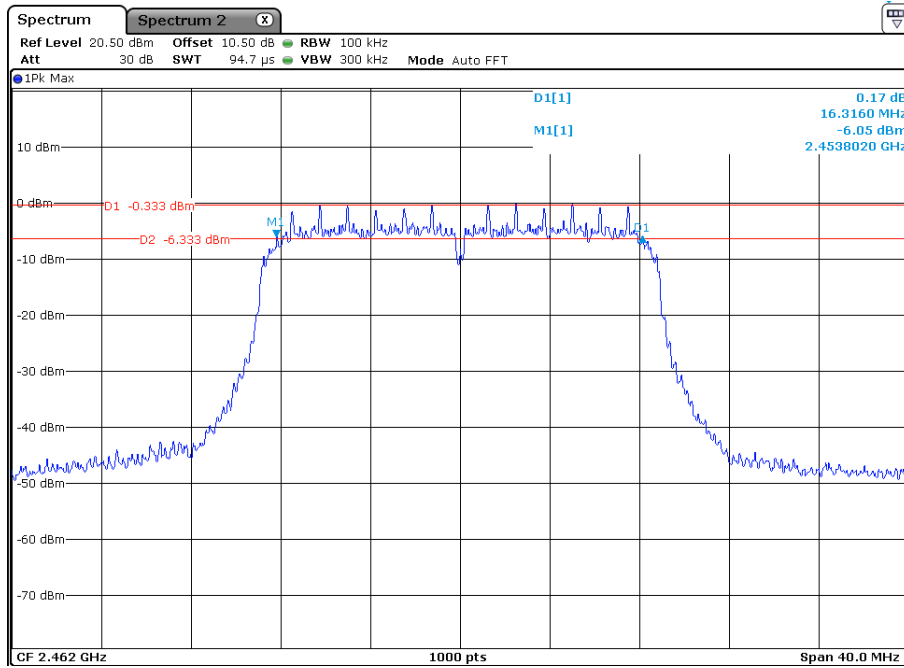

TEST REPORT

4.3 Duty Cycle

Test Requirement: FCC KDB 558074 D01 15.247 Meas Guidance v05r02, Clause 6

Test Method: ANSI C63.10: Clause 11.6

Test Status: Pre-Scan has been conducted to determine the worst-case mode from all possible combinations between available modulations, data rates and antenna ports (if EUT with antenna diversity architecture). Following channel(s) was (were) selected for the final test as listed below.

Test Configuration:

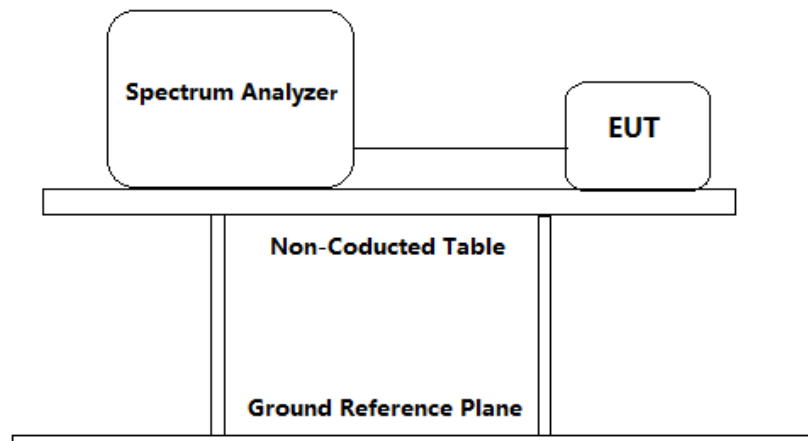

Test Procedure:

1. Remove the antenna from the EUT and then connect a low attention attenuation RF cable (cable loss =0.5dB, with a 10dB attenuator) from the antenna port to the spectrum.
2. Set the spectrum analyser:
 - a) Set the center frequency of the instrument to the center frequency of the transmission. Set the VBW \geq [3 x RBW]
 - b) Set RBW \geq OBW if possible; otherwise, set RBW to the largest available value. Span = Zero span
 - c) Set VBW \geq RBW. Set detector = peak or average. Trace mode = Free run
3. Report the worst case.

Used Test Equipment List

Spectrum Analyzer. Refer to Clause 5 Test Equipment List for details.

TEST REPORT

Test result:

Channel No.	Frequency (MHz)	Mode	On time (ms)	Period (ms)	Duty Cycle (%)
1	2412	802.11b	4.144	4.751	87.2
1	2412	802.11g	0.5919	0.7867	75.2
1	2412	802.11n (HT20)	0.5549	0.7097	78.2

Result plot as follows:

802.11b mode

Channel 1: 2412 MHz:

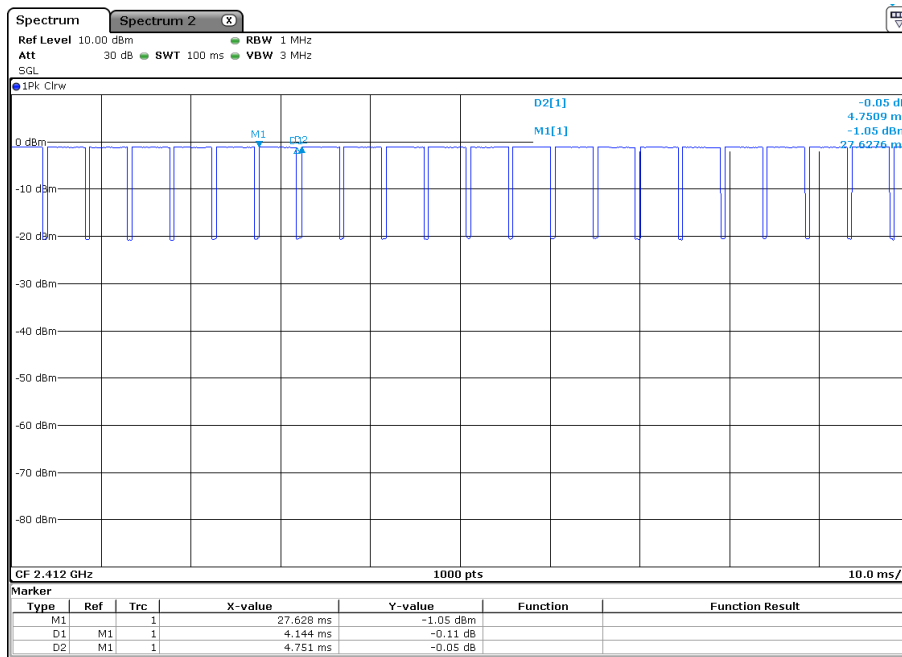

TEST REPORT

802.11g mode

Channel 1: 2412 MHz:

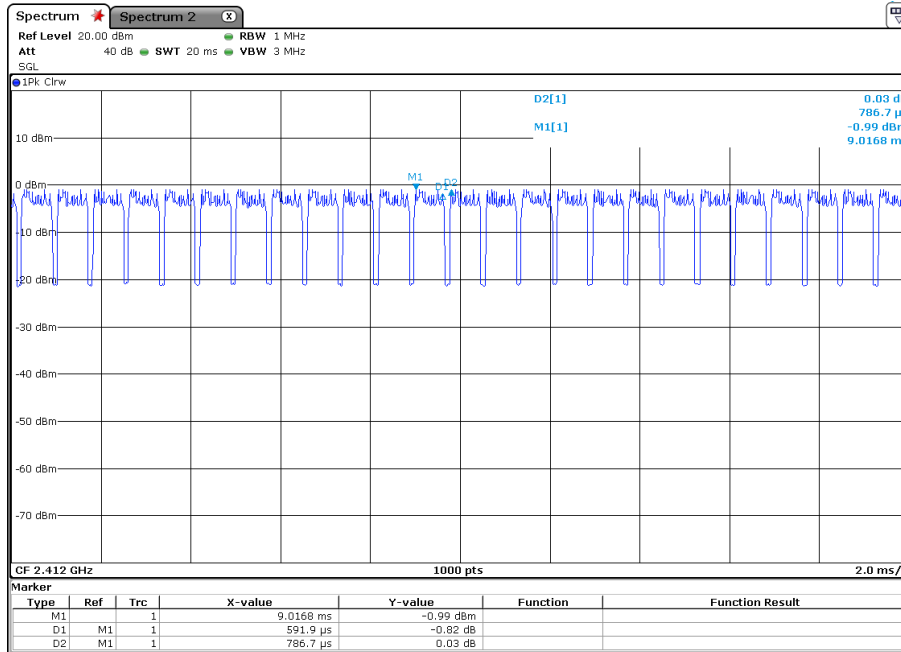

802.11n(HT 20) mode

Channel 1: 2412 MHz:

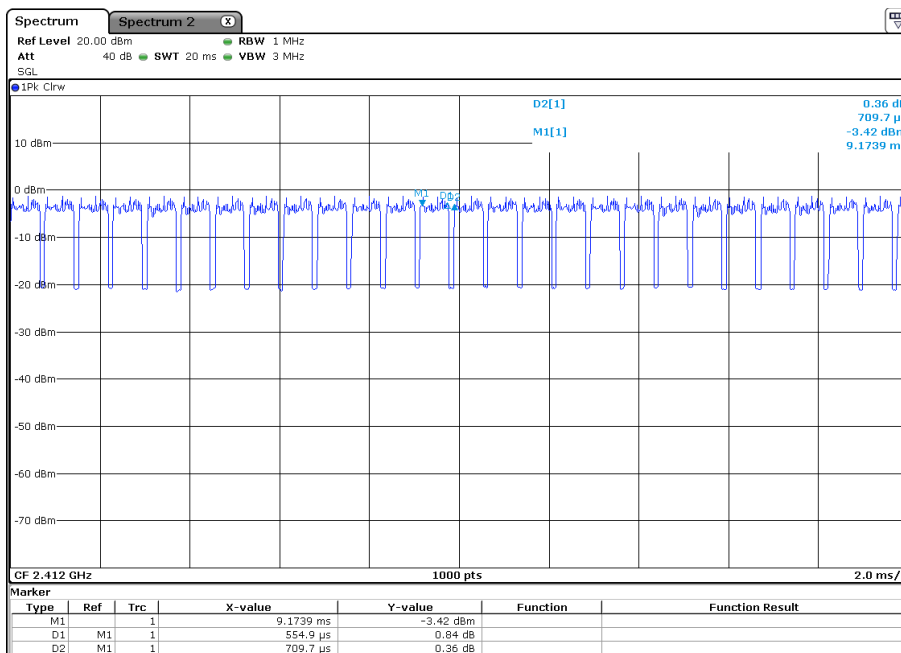

TEST REPORT

4.4 Maximum Average Conducted Output Power

Test Requirement:	FCC Part 15 C section 15.247 (b)(3) For systems using digital modulation in the 902-928 MHz, 2400-2483.5 MHz, and 5725-5850 MHz bands: 1 Watt. Except as shown in paragraph (c) of this section, if transmitting antennas of directional gain greater than 6 dBi are used, the conducted output power from the intentional radiator shall be reduced below the stated values in paragraphs (b) (1), (b) (2), and (b) (3) of this section, as appropriate, by the amount in dB that the directional gain of the antenna exceeds 6 dBi.
Test Method:	ANSI C63.10: Clause 11.9.2.3
Test Status:	Pre-Scan has been conducted to determine the worst-case mode from all possible combinations between available modulations, data rates and antenna ports (if EUT with antenna diversity architecture). Following channel(s) was (were) selected for the final test as listed below.
Test Configuration:	

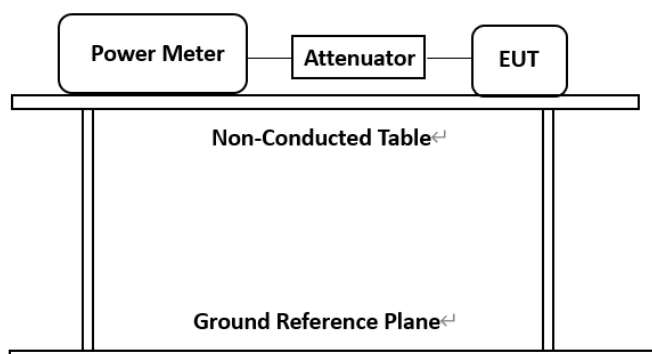

Test Procedure:

1. Remove the antenna from the EUT and then connect a low attention attenuation RF cable (cable loss =0.5 dB, with a 10dB attenuator) from the antenna port to the power meter.
2. The EUT is configured to transmit continuously or to transmit with a constant duty cycle.
3. If the EUT is transmitting at all times, it must be transmitting at its maximum power control level.
4. If the EUT does not transmit continuously, measure the duty cycle and adjust the measurement in dBm by adding $10\log(1/x)$ where x is the duty cycle of transmitter output signal. This measurement is an average over both the ON and OFF periods of the transmitter.
5. Report the worst case.

Used Test Equipment List

Spectrum Analyzer. Refer to Clause 5 Test Equipment List for details.

TEST REPORT

Test result:

Channel No.	Frequency (MHz)	Mode	Data Rate	Measured Channel Power (dBm)	Limit	Result
1	2412	802.11b	1 Mbps	15.49	1W (30dBm)	Pass
6	2437		1 Mbps	15.62		Pass
11	2462		1 Mbps	15.71		Pass
1	2412	802.11g	6 Mbps	13.13		Pass
6	2437		6 Mbps	13.51		Pass
11	2462		6 Mbps	13.54		Pass
1	2412	802.11n (HT20)	6.5 Mbps	11.76		Pass
6	2437		6.5 Mbps	11.91		Pass
11	2462		6.5 Mbps	12.04		Pass

Remark: The measured power in the table has considered the compensation of duty cycle.

The unit does meet the FCC requirements.

TEST REPORT

4.5 Peak Power Spectral Density

- Test Requirement:** FCC Part 15 C section 15.247
(e) For digitally modulated systems, the power spectral density conducted from the intentional radiator to the antenna shall not be greater than 8 dBm in any 3 kHz band during any time interval of continuous transmission.
This power spectral density shall be determined in accordance with the provisions of paragraph (b) of this section. The same method of determining the conducted output power shall be used to determine the power spectral density.
- Test Method:** ANSI C63.10: Clause 11.10.2
- Test Status:** Pre-Scan has been conducted to determine the worst-case mode from all possible combinations between available modulations, data rates and antenna ports (if EUT with antenna diversity architecture). Following channel(s) was (were) selected for the final test as listed below.
- Test Configuration:**

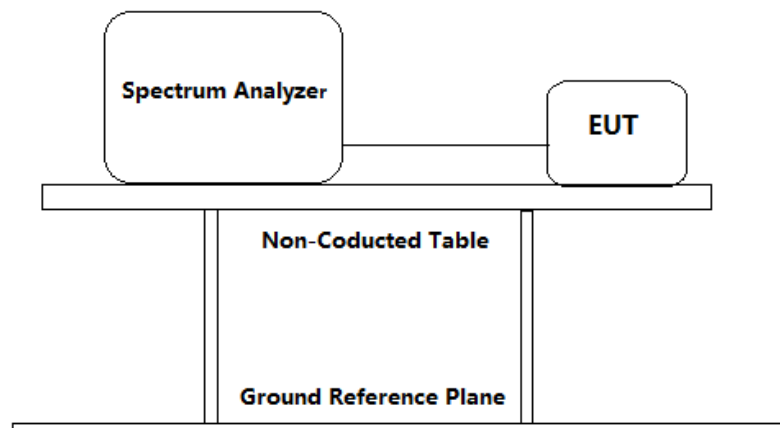

- Test Procedure:**
1. Remove the antenna from the EUT and then connect a low attention attenuation RF cable(cable loss =0.5 dB, with a 10dB attenuator) from the antenna port to the spectrum analyzer or power meter.
 2. Set the spectrum analyzer:
 - a) Set analyzer center frequency to DTS channel center frequency.
 - b) Set the span= $1.5 \times$ DTS bandwidth.
 - c) Set the RBW to $3 \text{ kHz} \leq \text{RBW} \leq 100 \text{ kHz}$.
 - d) Set the VBW $\geq [3 \times \text{RBW}]$.
 - e) Detector = peak.
 - f) Sweep time = auto couple.
 - g) Trace mode = max hold.
 - h) Allow trace to fully stabilize.
 - i) Use the peak marker function to determine the maximum amplitude level within

TEST REPORT

the RBW.

j) If measured value exceeds requirement, then reduce RBW (but no less than 3 kHz) and repeat.

3. Measure the Power Spectral Density of the test frequency with special test status.
4. Repeat until all the test status is investigated.
5. Report the worst case.

Used Test Equipment List

Spectrum Analyzer. Refer to Clause 5 Test Equipment List for details.

Test result:

Channel No.	Frequency (MHz)	Mode	Data Rate	Measured Peak Power Spectral Density (dBm/3kHz)	Limit	Result
1	2412	802.11b	1 Mbps	-9.04	8dBm/ 3 KHz	Pass
6	2437		1 Mbps	-8.44		Pass
11	2462		1 Mbps	-7.73		Pass
1	2412	802.11g	6 Mbps	-12.86		Pass
6	2437		6 Mbps	-12.77		Pass
11	2462		6 Mbps	-12.70		Pass
1	2412	802.11n (HT20)	6.5 Mbps	-13.53		Pass
6	2437		6.5 Mbps	-13.15		Pass
11	2462		6.5 Mbps	-13.12		Pass

TEST REPORT

Result plot as follows:

802.11b mode with 1Mbps data rate

Channel 1: 2.412GHz:

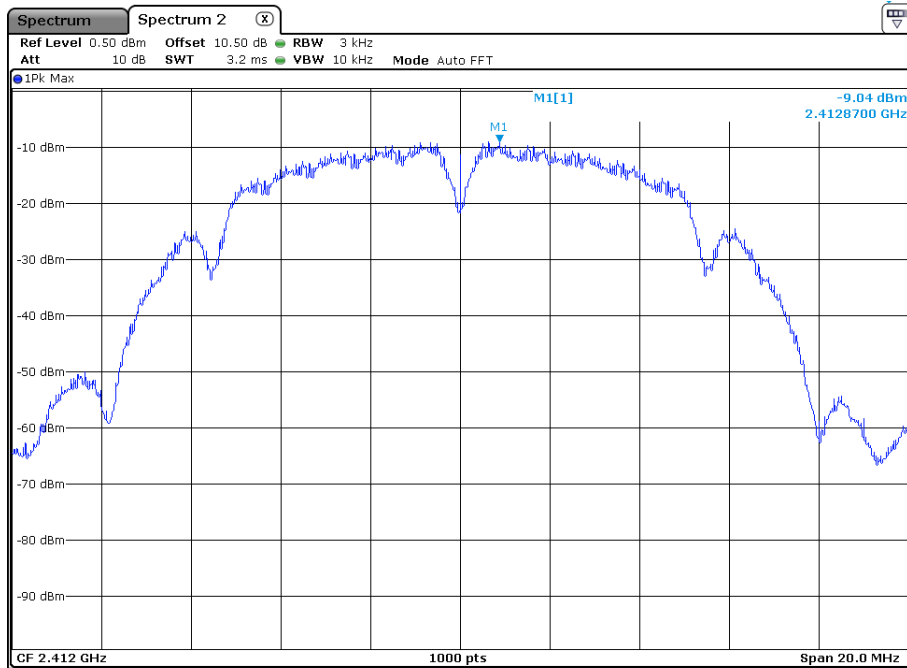

Channel 6: 2.437GHz:

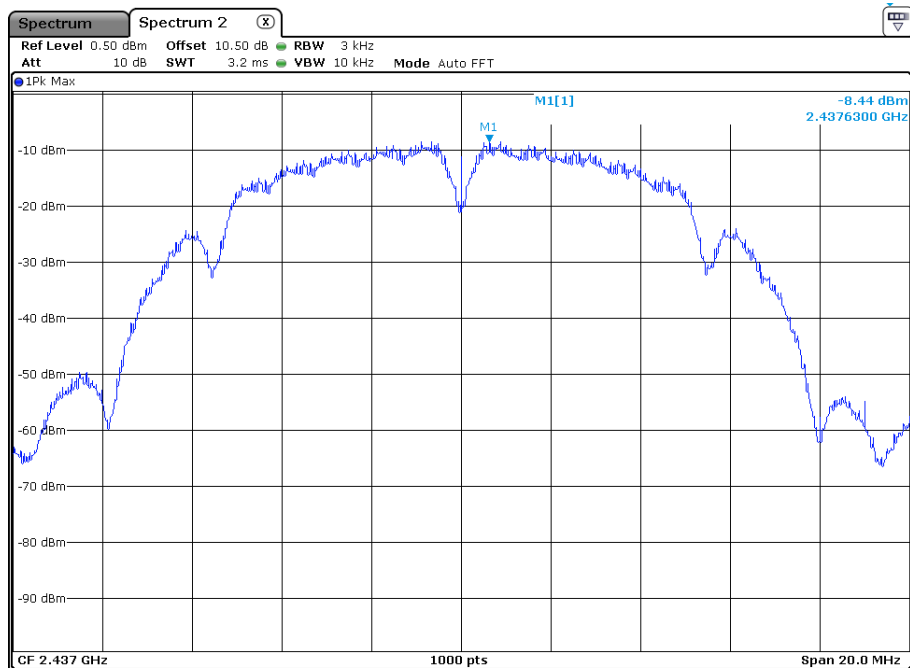

TEST REPORT

Channel 11: 2.462GHz:

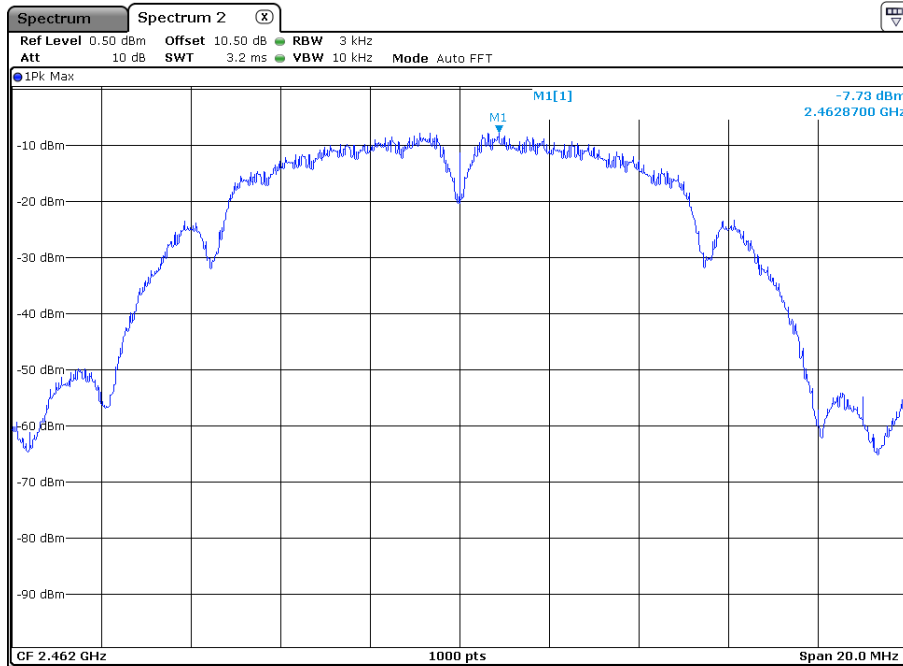

802.11g mode with 6Mbps data rate
Channel 1: 2.412GHz:

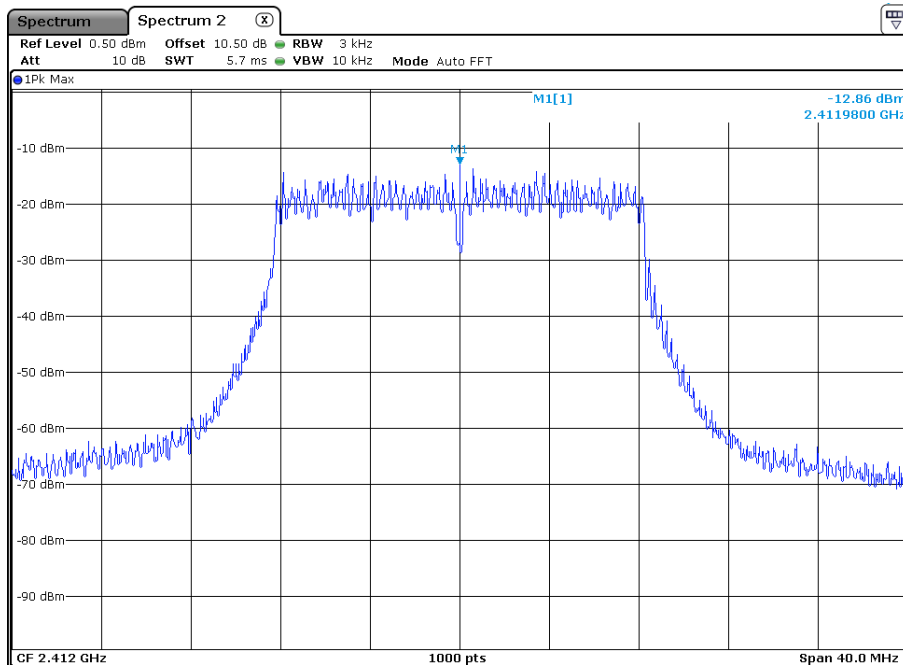

TEST REPORT

Channel 6: 2.437GHz:

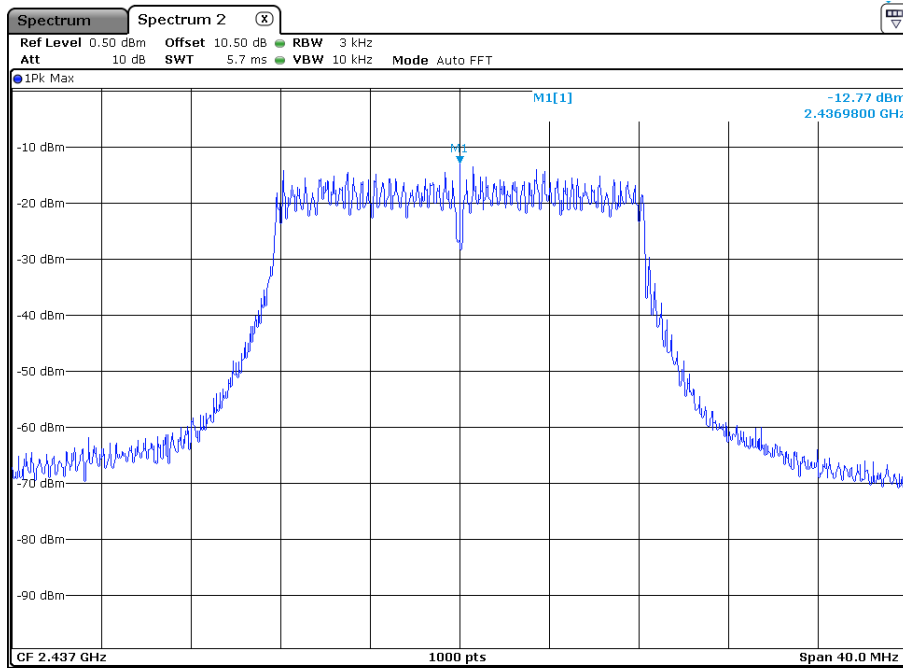

Channel 11: 2.462GHz:

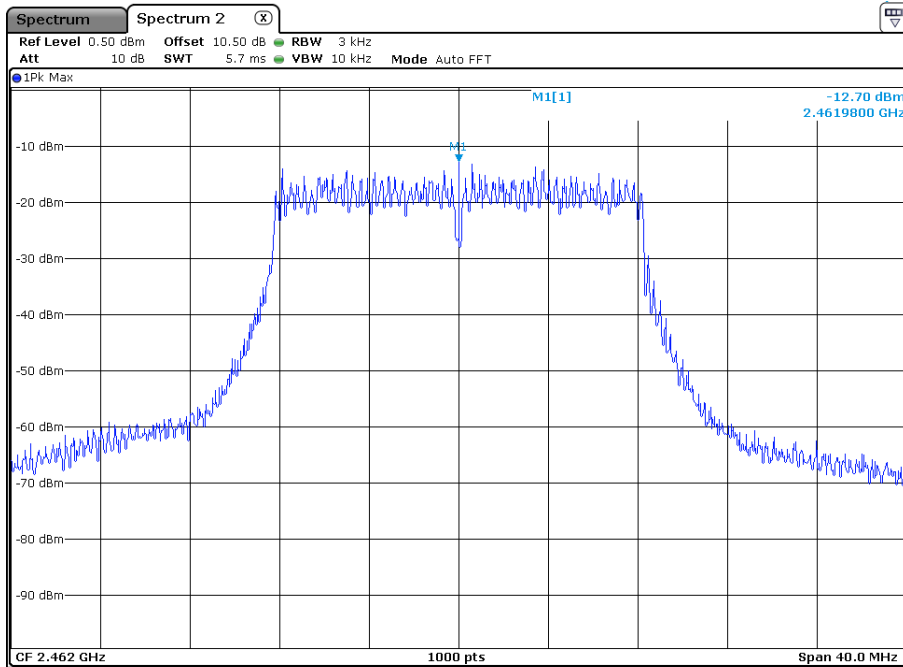

TEST REPORT

802.11n(HT20) mode with 6.5Mbps data rate

Channel 1: 2.412GHz:

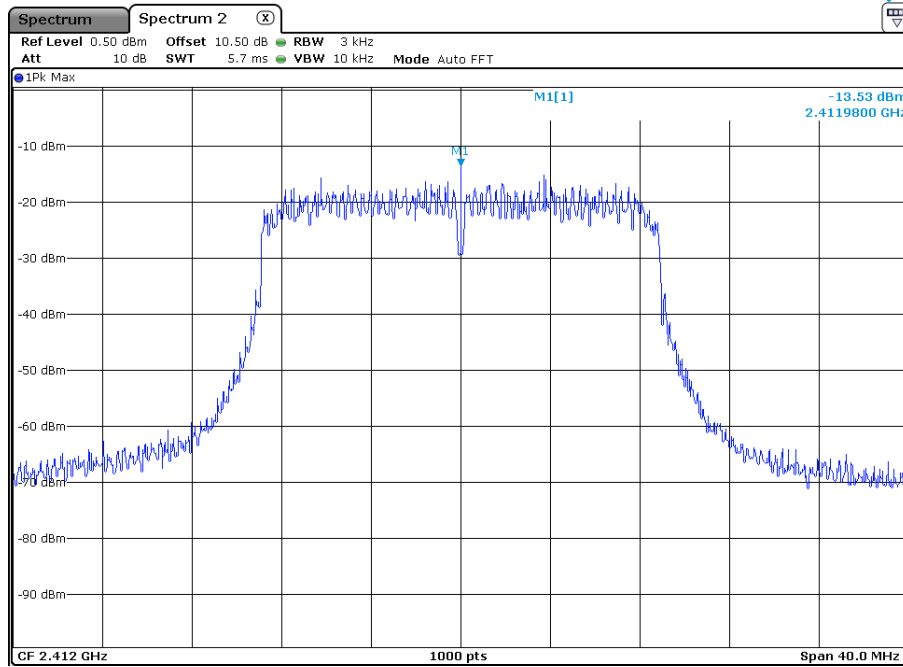

Channel 6: 2.437GHz:

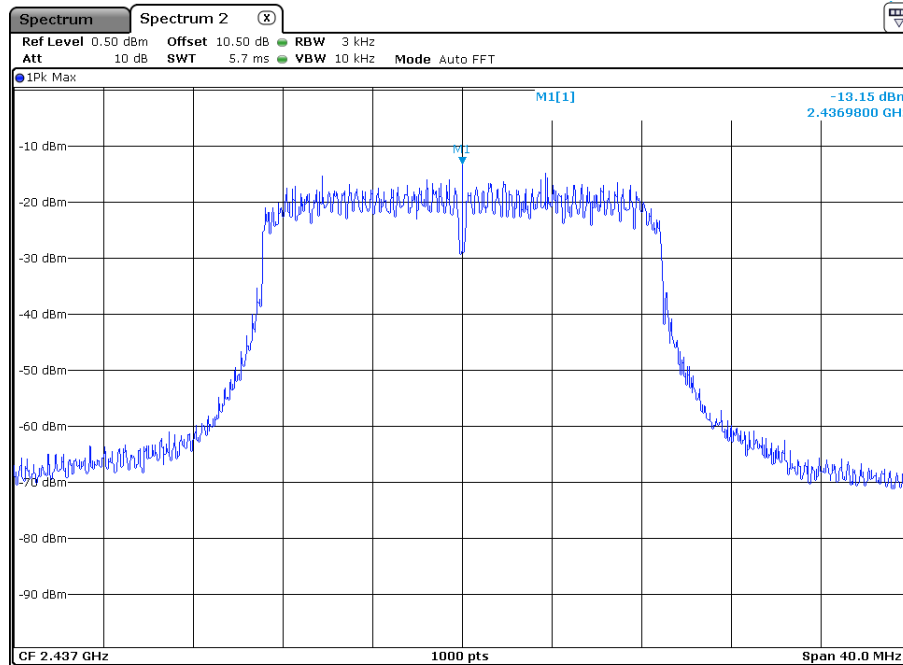

TEST REPORT

Channel 11: 2.462GHz:

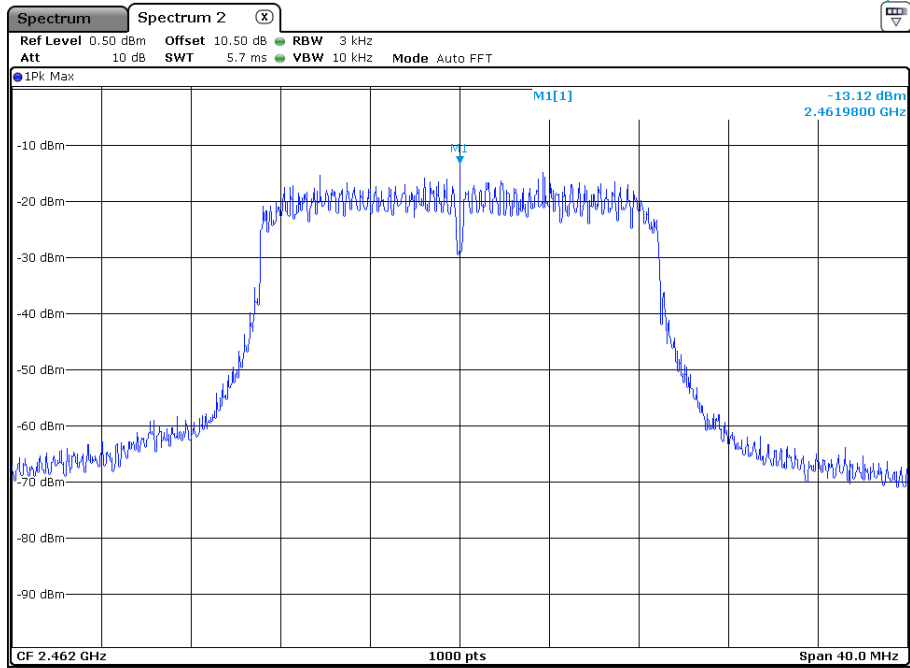

TEST REPORT

4.6 Out of Band Conducted Emissions

Test Requirement: FCC Part 15 C section 15.247

(d) In any 100 kHz bandwidth outside the frequency band in which the spread spectrum or digitally modulated intentional radiator is operating. The radio frequency power that is produced by the intentional radiator shall be at least 20 dB below that in the 100 kHz bandwidth within the band that contains the highest level of the desired power. Based on either an RF conducted or a radiated measurement. Provided the transmitter demonstrates compliance with the peak conducted power limits. If the transmitter complies with the conducted power limits based on the use of RMS averaging over a time interval, as permitted under paragraph (b)(3) of this section, the attenuation required under this paragraph shall be 30dB instead of 20dB.

Test Method: ANSI C63.10: Clause 11.11

Test Status: Pre-Scan has been conducted to determine the worst-case mode from all possible combinations between available modulations, data rates and antenna ports (if EUT with antenna diversity architecture). Following channel(s) was (were) selected for the final test as listed below.

Test Configuration:

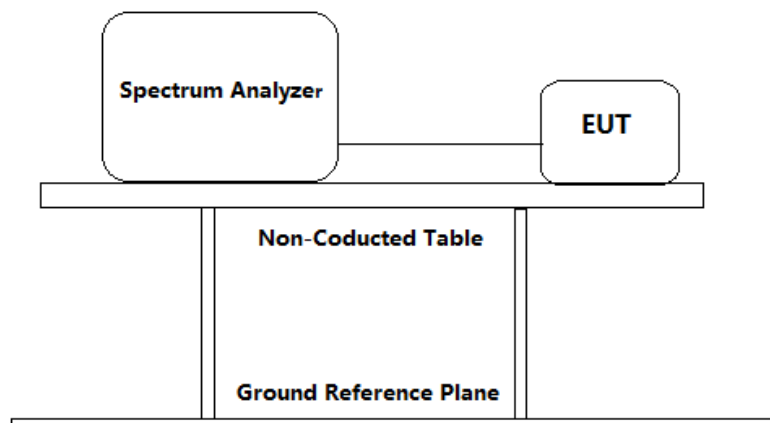

Test Procedure:

1. Remove the antenna from the EUT and then connect a low RF cable (cable loss =2dB) from the antenna port to the spectrum analyzer or power meter.
2. Establish a reference level by using the following procedure:
 - a) Set instrument center frequency to DTS channel center frequency.
 - b) Set the span to $\geq 1.5 \times$ DTS bandwidth.
 - c) Set the RBW = 100 kHz.
 - d) Set the VBW $\geq [3 \times$ RBW].
 - e) Detector = peak.
 - f) Sweep time = auto couple.
 - g) Trace mode = max hold.

TEST REPORT

- h) Allow trace to fully stabilize.
 - i) Use the peak marker function to determine the maximum PSD level.
- Note that the channel found to contain the maximum PSD level can be used to establish the reference level
- 3. Emission level measurement
 - a) Set the center frequency and span to encompass frequency range to be measured.
 - b) Set the RBW = 100 kHz.
 - c) Set the VBW $\geq [3 \times \text{RBW}]$.
 - d) Detector = peak.
 - e) Sweep time = auto couple.
 - f) Trace mode = max hold.
 - g) Allow trace to fully stabilize.
 - h) Use the peak marker function to determine the maximum amplitude level.
- 4. Measure the Conducted unwanted Emissions of the test frequency with special test status.
- 5. Repeat until all the test status is investigated.
- 6. Report the worst case.

Used Test Equipment List

Spectrum Analyzer. Refer to Clause 5 Test Equipment List for details.

TEST REPORT

Result plot as follows:

802.11b mode with 1Mbps data rate

Channel 1: 2.412GHz:

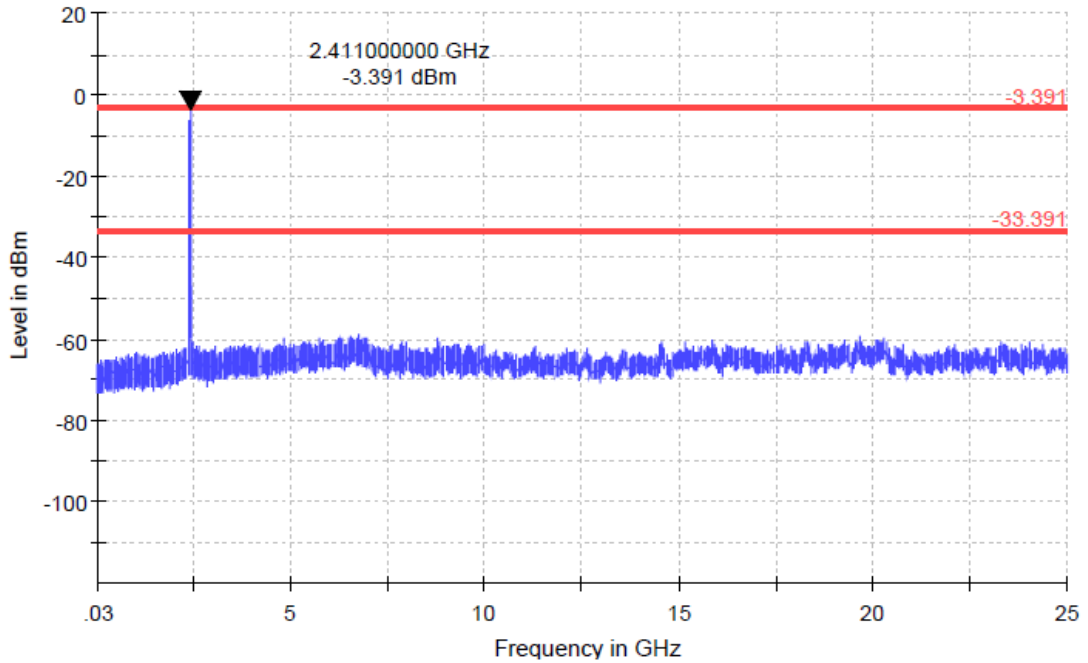

In any 100kHz bandwidth, the Conducted Spurious Emissions from 30 MHz to 25 GHz were greater than 20dB below the peak emission within the band that contains the highest level of the desired power.

TEST REPORT

Channel 6: 2.437GHz:

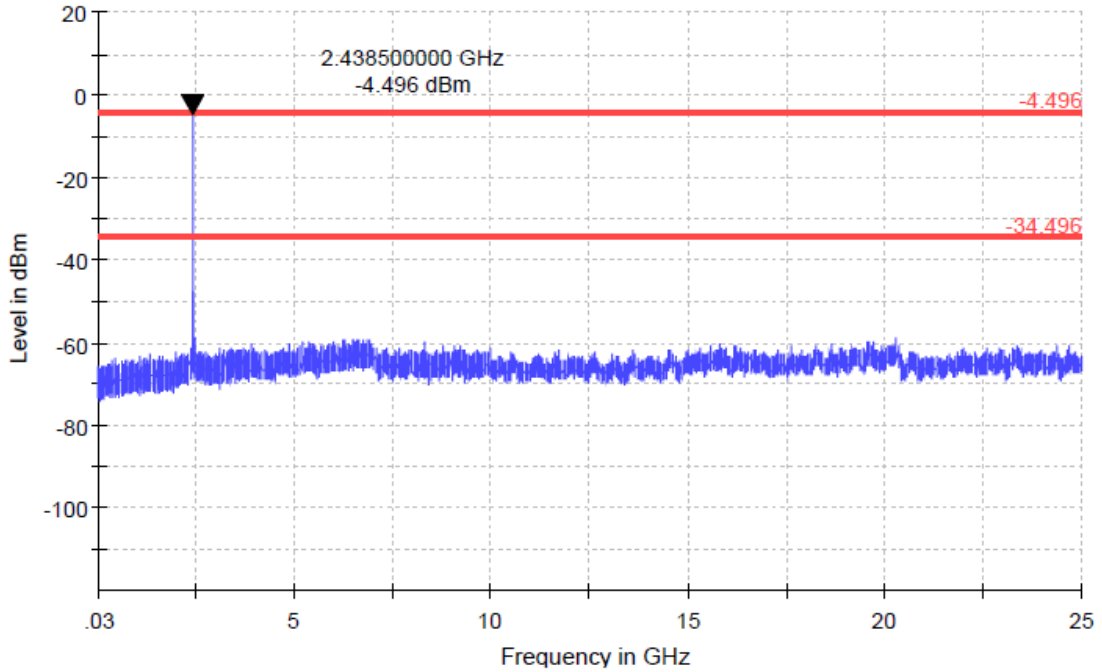

In any 100kHz bandwidth, the Conducted Spurious Emissions from 30 MHz to 25 GHz were greater than 20dB below the peak emission within the band that contains the highest level of the desired power.

TEST REPORT

Channel 11:2.462 GHz:

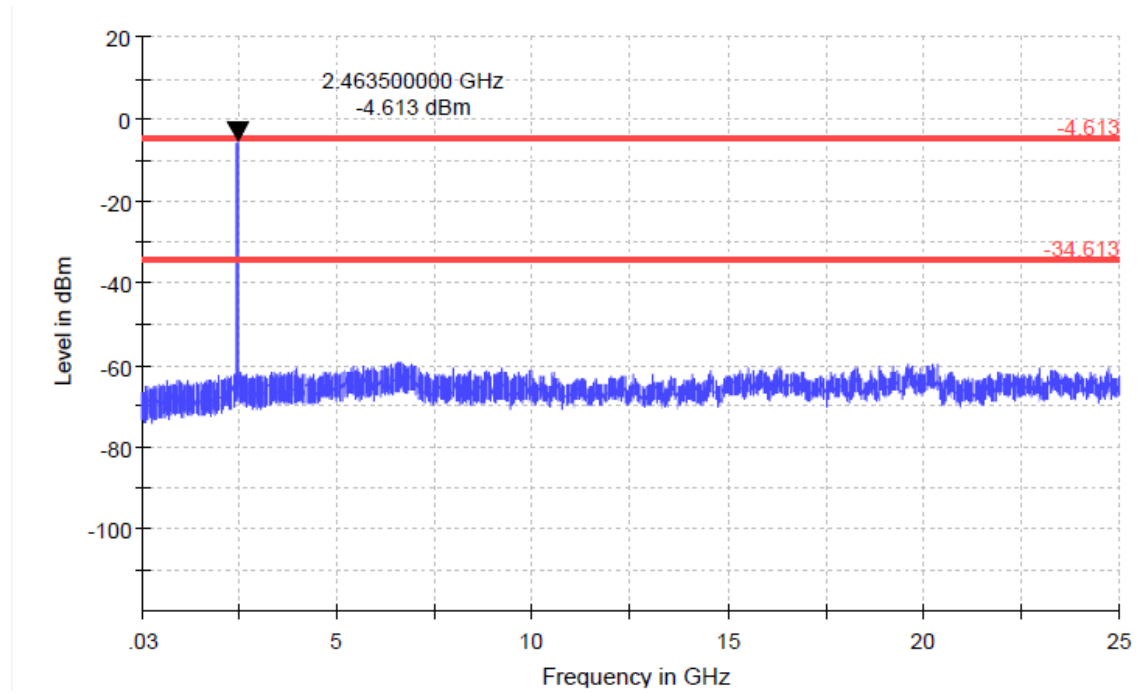

In any 100kHz bandwidth, the Conducted Spurious Emissions from 30 MHz to 25 GHz were greater than 20dB below the peak emission within the band that contains the highest level of the desired power.

TEST REPORT

802.11g mode with 6Mbps data rate

Channel 1: 2.412GHz:

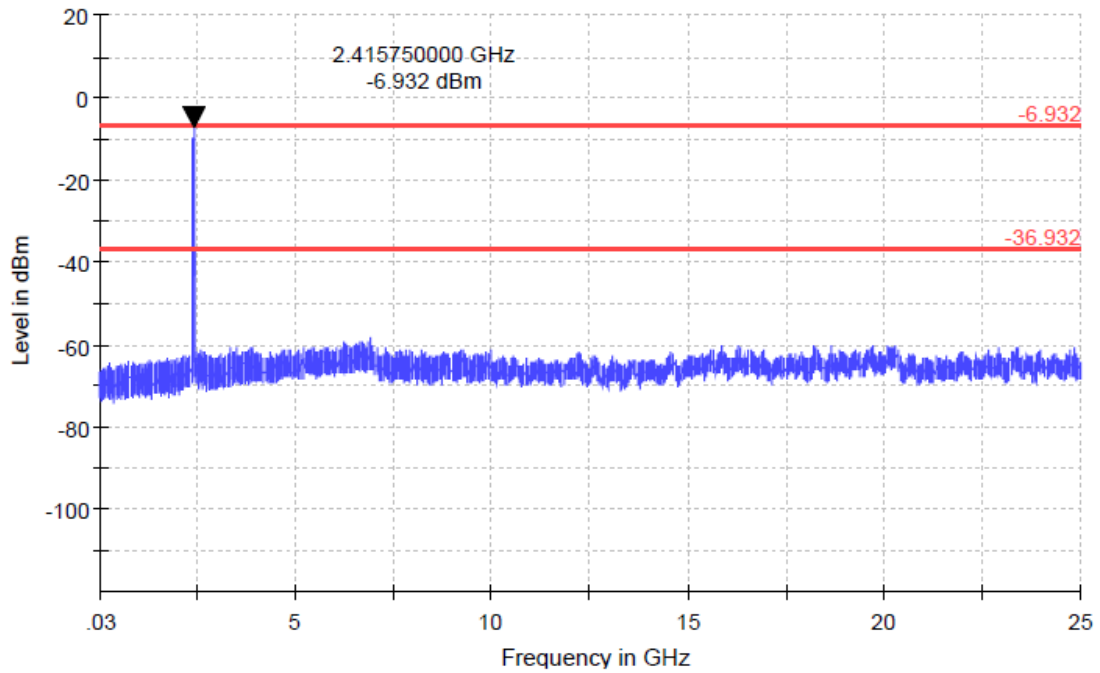

In any 100kHz bandwidth, the Conducted Spurious Emissions from 30 MHz to 25 GHz were greater than 20dB below the peak emission within the band that contains the highest level of the desired power.

TEST REPORT

Channel 6: 2.437GHz:

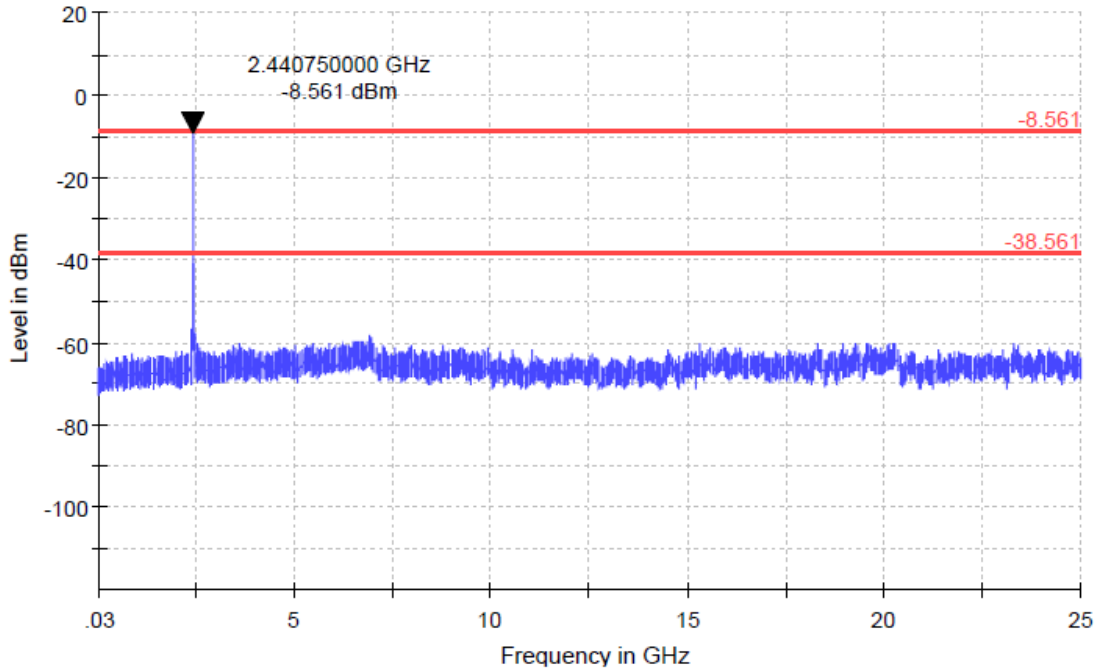

In any 100kHz bandwidth, the Conducted Spurious Emissions from 30 MHz to 25 GHz were greater than 20dB below the peak emission within the band that contains the highest level of the desired power.

TEST REPORT

Channel 11: 2.462 GHz:

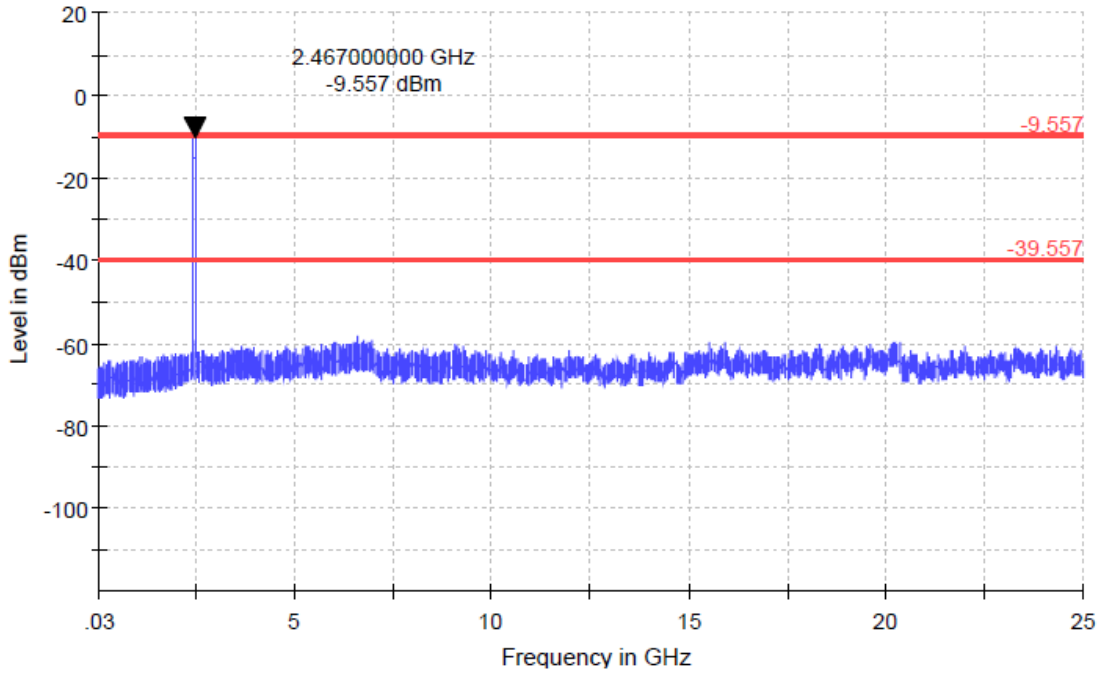

In any 100kHz bandwidth, the Conducted Spurious Emissions from 30 MHz to 25 GHz were greater than 20dB below the peak emission within the band that contains the highest level of the desired power.

TEST REPORT

802.11n(HT20) mode with 6.5Mbps data rate
Channel 1: 2.412GHz:

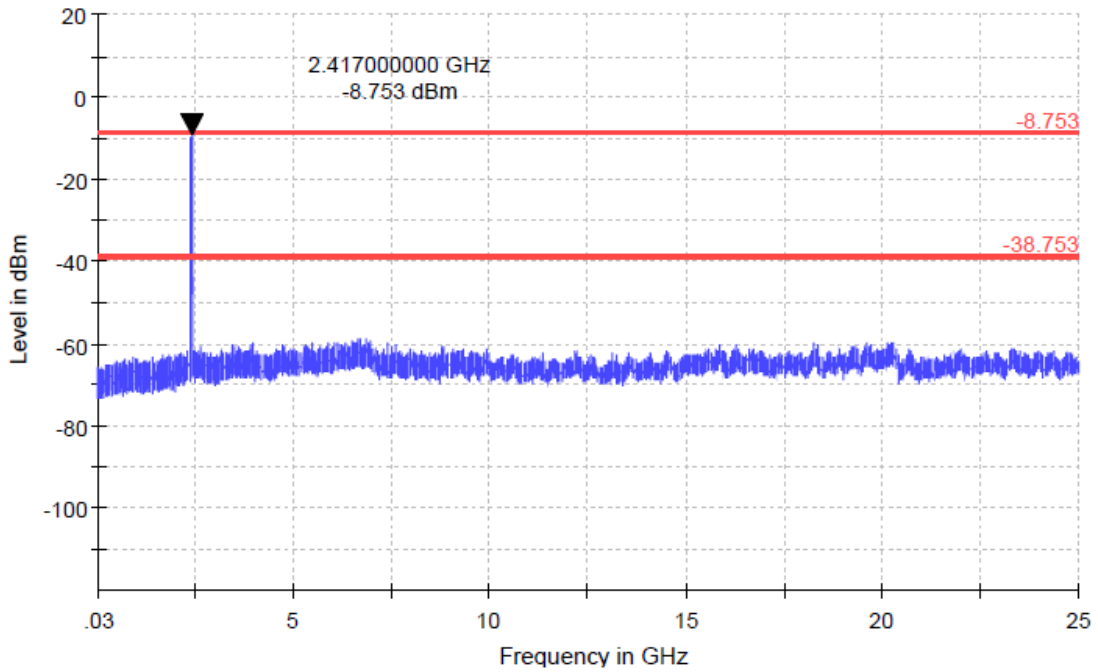

In any 100kHz bandwidth, the Conducted Spurious Emissions from 30 MHz to 25 GHz were greater than 20dB below the peak emission within the band that contains the highest level of the desired power.

TEST REPORT

Channel 6: 2.437GHz:

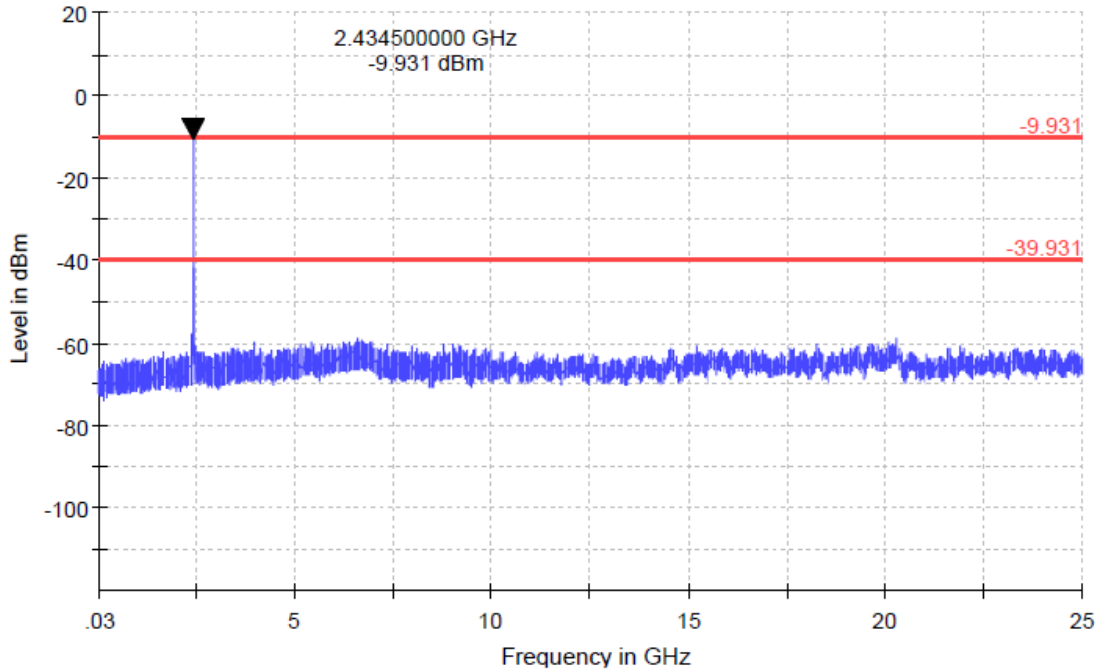

In any 100kHz bandwidth, the Conducted Spurious Emissions from 30 MHz to 25 GHz were greater than 20dB below the peak emission within the band that contains the highest level of the desired power.

TEST REPORT

Channel 11:2.462 GHz:

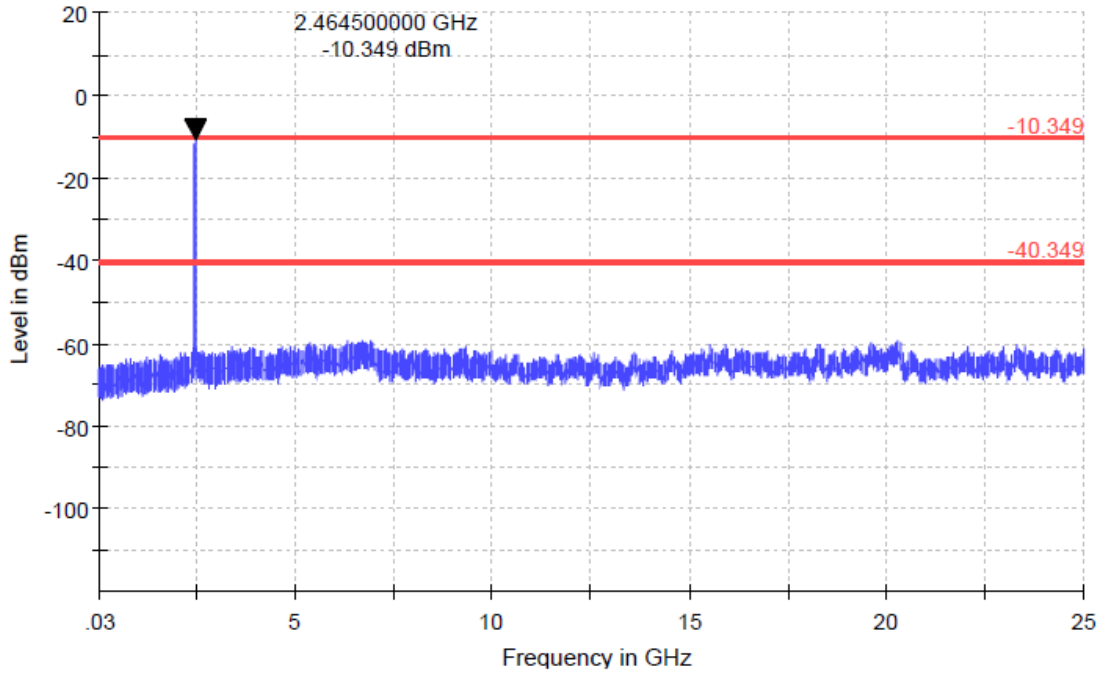

In any 100kHz bandwidth, the Conducted Spurious Emissions from 30 MHz to 25 GHz were greater than 20dB below the peak emission within the band that contains the highest level of the desired power.

TEST REPORT

4.7 Out of Band Radiated Emissions

For out of band radiated emissions into Non-Restricted Frequency Bands were performed at a 3m separation distance to determine whether these emissions complied with the 20dB attenuation requirement.

- Not required, since all emissions are more than 20dB below fundamental
 See attached data sheet

4.8 Radiated Emissions in Restricted Bands

Test Requirement:	FCC Part 15 C section 15.247 (d) In addition, radiated emissions which fall in the restricted bands, as defined in Section 15.205(a), must also comply with the radiated emission limits specified in Section 15.209(a) (see Section 15.205(c)).
Test Method:	ANSI C63.10: Clause 11.12.1, 6.4, 6.5 and 6.6
Test Status:	Pre-Scan has been conducted to determine the worst-case mode from all possible combinations between available modulations, data rates and antenna ports (if EUT with antenna diversity architecture). Following channel(s) was (were) selected for the final test as listed below.
Test site:	Measurement Distance: 3m (Semi-Anechoic Chamber)
Limit:	40.0 dB μ V/m between 30MHz & 88MHz; 43.5 dB μ V/m between 88MHz & 216MHz; 46.0 dB μ V/m between 216MHz & 960MHz; 54.0 dB μ V/m above 960MHz.
Detector:	For Peak and Quasi-Peak value: RBW = 1 MHz for $f \geq 1$ GHz, 200 Hz for 9 kHz to 150 kHz 9 kHz for 150 kHz to 30 MHz 120 kHz for 30 MHz to 1GHz VBW \geq RBW Sweep = auto Detector function = peak for $f \geq 1$ GHz, QP for $f < 1$ GHz Trace = max hold For AV value: RBW = 1 MHz for $f \geq 1$ GHz, 100 kHz for $f < 1$ GHz VBW=10 Hz Sweep = auto

TEST REPORT

Trace = max hold

Field Strength Calculation:

The field strength is calculated by adding the reading on the Spectrum Analyzer to the factors associated with preamplifiers (if any), antennas, cables, pulse desensitization and average factors (when specified limit is in average and measurements are made with peak detectors). A sample calculation is included below:

$$FS = RA + AF + CF - AG + PD + AV$$

$$FS = RA + \text{Correct Factor} + AV$$

Where:

FS = Field Strength in dB μ V/m

RA = Receiver Amplitude (including preamplifier) in dB μ V

AF = Antenna Factor in dB

CF = Cable Attenuation Factor in dB

AG = Amplifier Gain in dB

PD = Pulse Desensitization in dB

AV = Average Factor in -dB

Correct Factor = AF + CF - AG + PD

In the radiated emission table which follows, the reading shown on the data table may reflect the preamplifier gain. An example of the calculations, where the reading does not reflect the preamplifier gain, follows:

$$FS = RA + AF + CF - AG + PD + AV$$

Assume a receiver reading of 62.0 dB μ V is obtained. The antenna factor of 7.4 dB and cable factor of 1.6 dB is added. The amplifier gain of 29 dB is subtracted. The pulse desensitization factor of the spectrum analyzer was 0 dB, and the resultant average factor was -10 dB. The net field strength for comparison to the appropriate emission limit is 32 dB μ V/m.

$$RA = 62.0 \text{ dB}\mu\text{V}$$

$$AF = 7.4 \text{ dB}$$

$$CF = 1.6 \text{ dB}$$

$$AG = 29.0 \text{ dB}$$

$$PD = 0 \text{ dB}$$

$$AV = -10 \text{ dB}$$

$$\text{Correct Factor} = 7.4 + 1.6 - 29.0 + 0 = -20 \text{ dB}$$

$$FS = 62 + (-20) + (-10) = 32 \text{ dB}\mu\text{V/m}$$

TEST REPORT

Section 15.205 Restricted bands of operation.

(a) Except as shown in paragraph (d) of this section. Only spurious emissions are permitted in any of the frequency bands listed below:

MHz	MHz	MHz	GHz
0.090 - 0.110	16.42 - 16.423	399.9 - 410	4.5 - 5.15
10.495 - 0.505	16.69475 - 16.69525	608 - 614	5.35 - 5.46
2.1735 - 2.1905	16.80425 - 16.80475	960 - 1240	7.25 - 7.75
4.125 - 4.128	25.5 - 25.67	1300 - 1427	8.025 - 8.5
4.17725 - 4.17775	37.5 - 38.25	1435 - 1626.5	9.0 - 9.2
4.20725 - 4.20775	73 - 74.6	1645.5 - 1646.5	9.3 - 9.5
6.215 - 6.218	74.8 - 75.2	1660 - 1710	10.6 - 12.7
6.26775 - 6.26825	108 - 121.94	1718.8 - 1722.2	13.25 - 13.4
6.31175 - 6.31225	123 - 138	2200 - 2300	14.47 - 14.5
8.291 - 8.294	149.9 - 150.05	2310 - 2390	15.35 - 16.2
8.362 - 8.366	156.52475 -	2483.5 - 2500	17.7 - 21.4
8.37625 - 8.38675	156.52525	2655 - 2900	22.01 - 23.12
8.41425 - 8.41475	156.7 - 156.9	3260 - 3267	23.6 - 24.0
12.29 - 12.293	162.0125 - 167.17	3332 - 3339	31.2 - 31.8
12.51975 - 12.52025	167.72 - 173.2	3345.8 - 3358	36.43 - 36.5
12.57675 - 12.57725	240 - 285	3600 - 4400	
13.36 - 13.41	322 - 335.4		

Test Configuration:

1) 9 kHz to 30 MHz emissions:

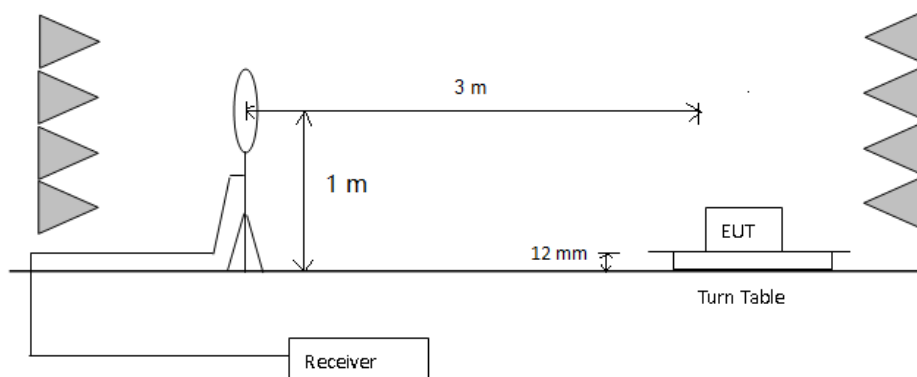

TEST REPORT

2) 30 MHz to 1 GHz emissions:

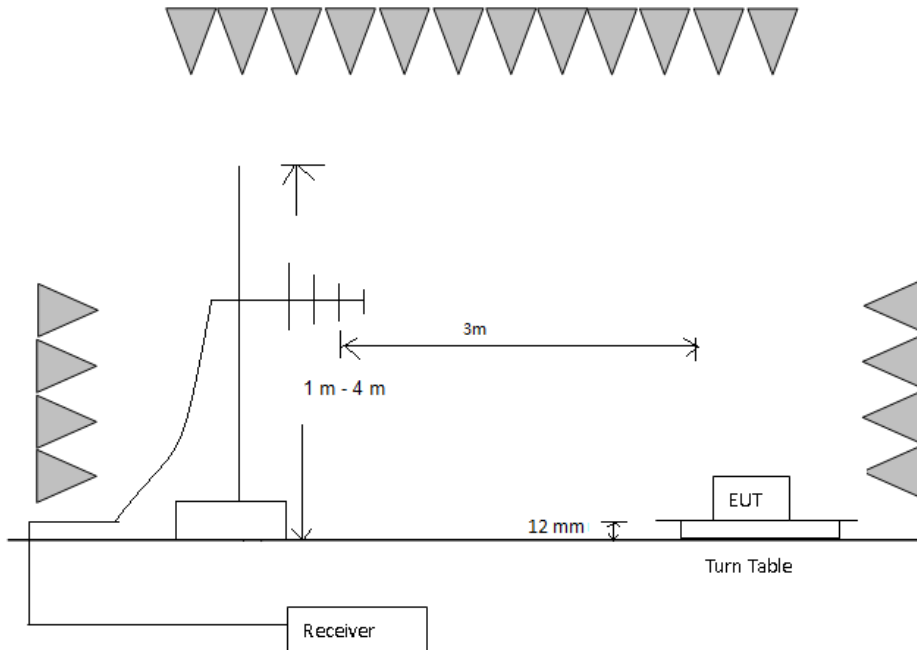

3) 1 GHz to 40 GHz emissions:

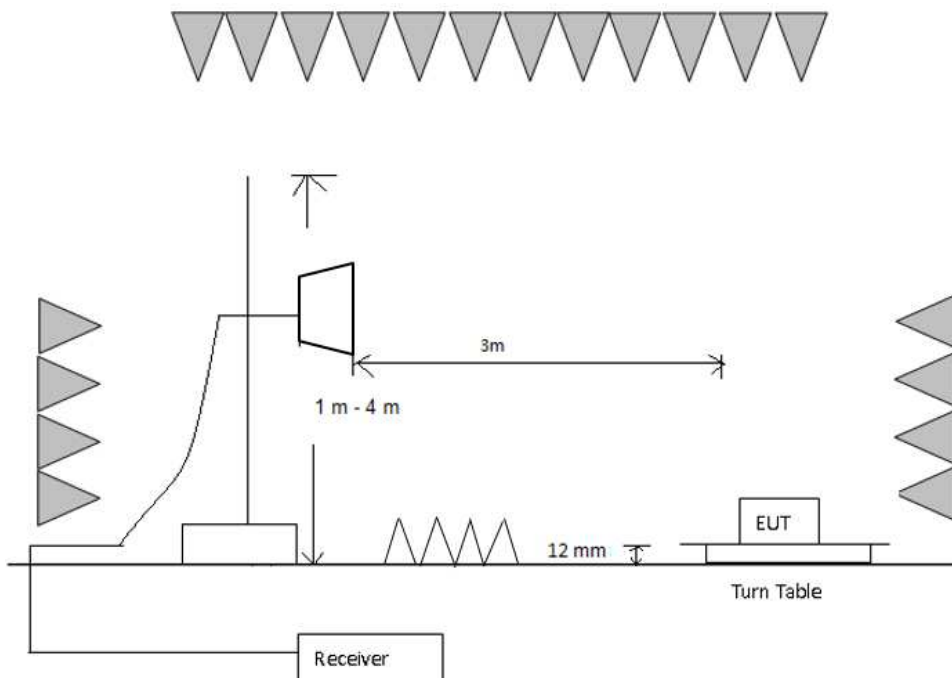

Test Procedure:

Test site with RF absorbing material covering the ground plane that met the site validation criterion called out in CISPR 16-1-4:2010 was used to perform radiated emission test above 1 GHz.

The receiver was scanned from 9 kHz to 25 GHz. When an emission was found, the table was rotated to produce the maximum signal strength. An initial pre-scan was performed for in peak detection mode using the receiver. The EUT was measured for both the Horizontal and Vertical

TEST REPORT

polarities and performed a pre-test three orthogonal planes. For intentional radiators, measurements of the variation of the input power or the radiated signal level of the fundamental frequency component of the emission, as appropriate, shall be performed with the supply voltage varied between 85% and 115% of the nominal rated supply voltage. The worst case emissions were reported.

Used Test Equipment List:

3m Semi-Anechoic Chamber, EMI Test Receiver (9 kHz~7 GHz), Signal and Spectrum Analyzer (10 Hz~40 GHz), Loop antenna (9 kHz-30 MHz). TRILOG Super Broadband test Antenna(30 MHz-3 GHz) (RX), Bouble-Ridged Waveguide Horn Antenna (800 MHz-18 GHz)(RX) and High Frequency Antenna & preamplifier(18 GHz~26.5 GHz) (RX). Refer to Clause 5 Test Equipment List for details.

802.11b mode with 1Mbps data rate

9 kHz~30 MHz Field Strength of Unwanted Emissions. Quasi-Peak Measurement

The measurements with active loop antenna were greater than 20dB below the limit, so the test data were not recorded in the test report.

Test at Channel 1 (2.412 GHz) in transmitting status

30 MHz~1 GHz Spurious Emissions .Quasi-Peak Measurement

Vertical:

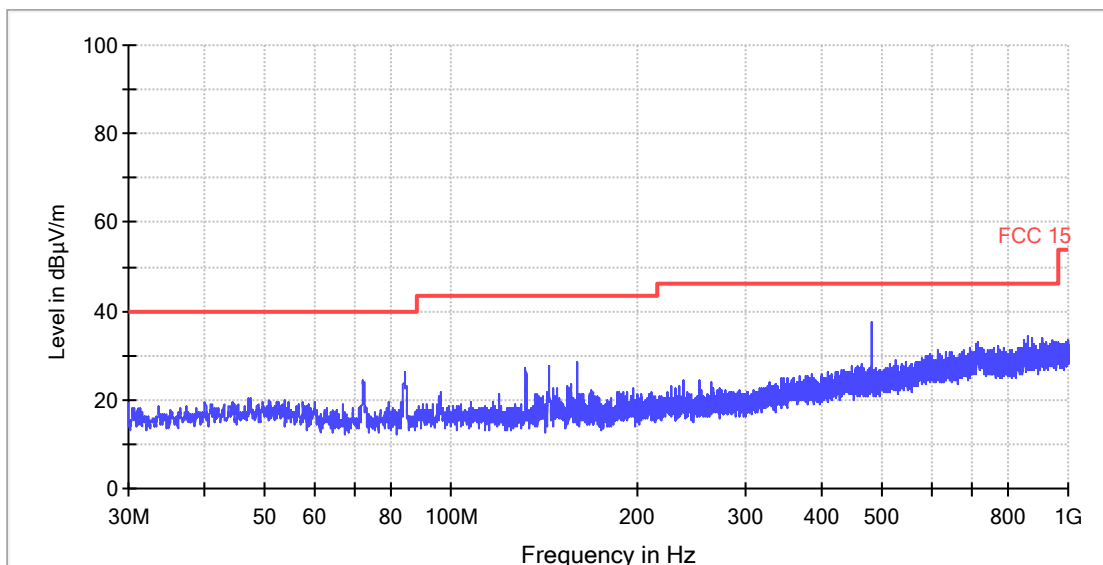

Remark:

1. Corr. (dB) = Antenna Factor (dB) + Cable Loss (dB)
2. Quasi Peak (dBµV/m) = Corr. (dB) + Read Level (dBµV)
3. Margin (dB) = Limit QPK (dBµV/m) –Quasi Peak (dBµV/m)

TEST REPORT

Horizontal:

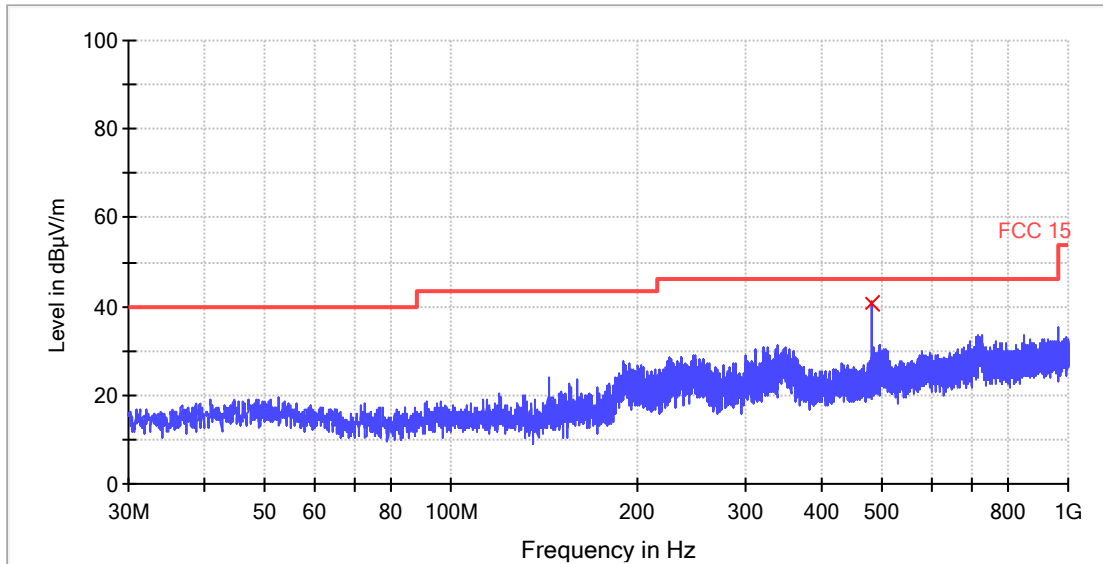

QP

Frequency (MHz)	Quasi Peak (dBµV/m)	Bandwidth (kHz)	Pol	Corr. (dB)	Margin - QPK (dB)	Limit - QPK (dBµV/m)
480.000000	40.6	120.000	H	19.3	5.4	46.0

Remark:

1. Corr. (dB) = Antenna Factor (dB) + Cable Loss (dB)
2. Quasi Peak (dBµV/m) = Corr. (dB) + Read Level (dBµV)
3. Margin (dB) = Limit QPK (dBµV/m) – Quasi Peak (dBµV/m)

TEST REPORT

1~25 GHz Radiated Emissions.

PK Measurement:

Frequency (MHz)	PK Reading Level (dB μ V)	Correction factors (dB/m)	PK Emission Level (dB μ V/m)	PK Limit (dB μ V/m)	Antenna polarization
4824	51.4	-1.1	50.3	74	H
11243	42.7	6.5	49.2	74	H
4824	51.6	-1.1	50.5	74	V
9399	45.4	4.7	50.1	74	V

AV Measurement:

Frequency (MHz)	AV Reading Level (dB μ V)	Correction factors (dB/m)	AV Emission Level (dB μ V/m)	AV Limit (dB μ V/m)	Antenna polarization
4824	/	-1.1	/	54	H
11243	/	6.5	/	54	H
4824	/	-1.1	/	54	V
9399	/	4.7	/	54	V

Remark: When Peak emission level was below AV limit, the AV emission level did not be recorded.

TEST REPORT

Restricted Bands Measurement

Horizontal

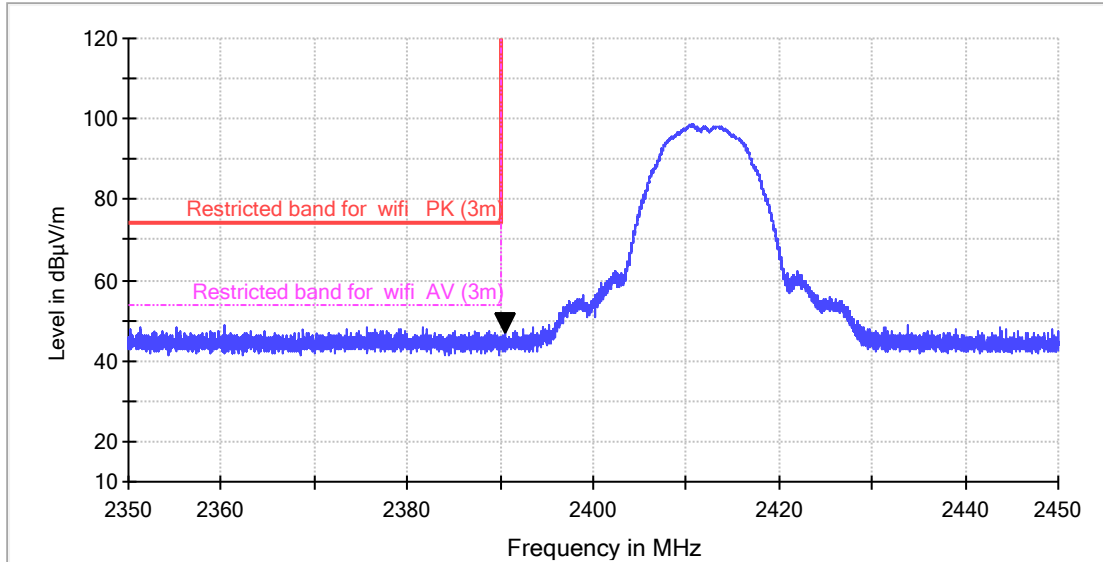

Vertical

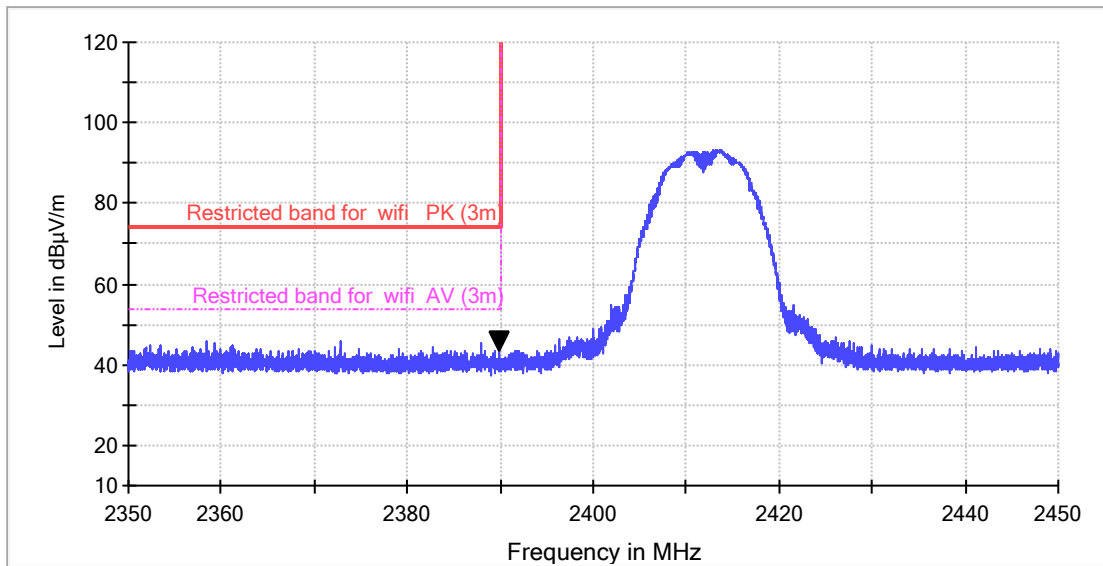

Frequency (MHz)	PK Reading Level (dBµV)	Correction factors (dB/m)	PK Emission Level (dBµV/m)	PK Limit (dBµV/m)	Antenna polarization
2390	55.5	-8.2	47.3	74	H
2390	51.9	-8.2	43.7	74	V

Remark:

When Peak emission level was below AV limit, the AV emission level did not be recorded.

TEST REPORT

Test at Channel 6 (2.437 GHz) in transmitting status
30 MHz~1 GHz Radiated Emissions .Quasi-Peak Measurement

Vertical:

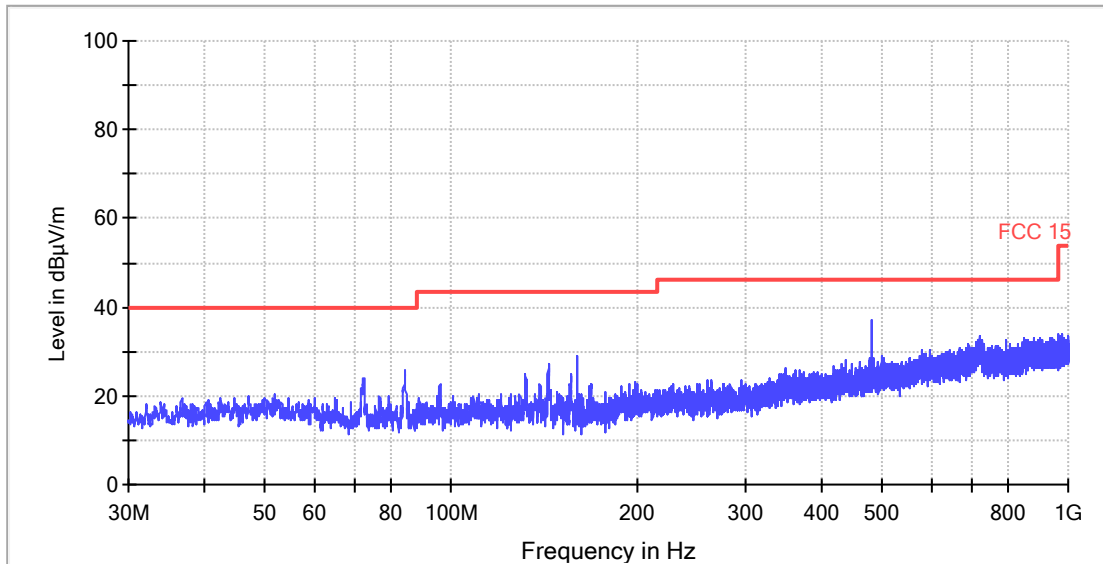

Remark:

1. Corr. (dB) = Antenna Factor (dB) + Cable Loss (dB)
2. Quasi Peak (dBµV/m) = Corr. (dB) + Read Level (dBµV)
3. Margin (dB) = Limit QPK (dBµV/m) –Quasi Peak (dBµV/m)

TEST REPORT

Horizontal:

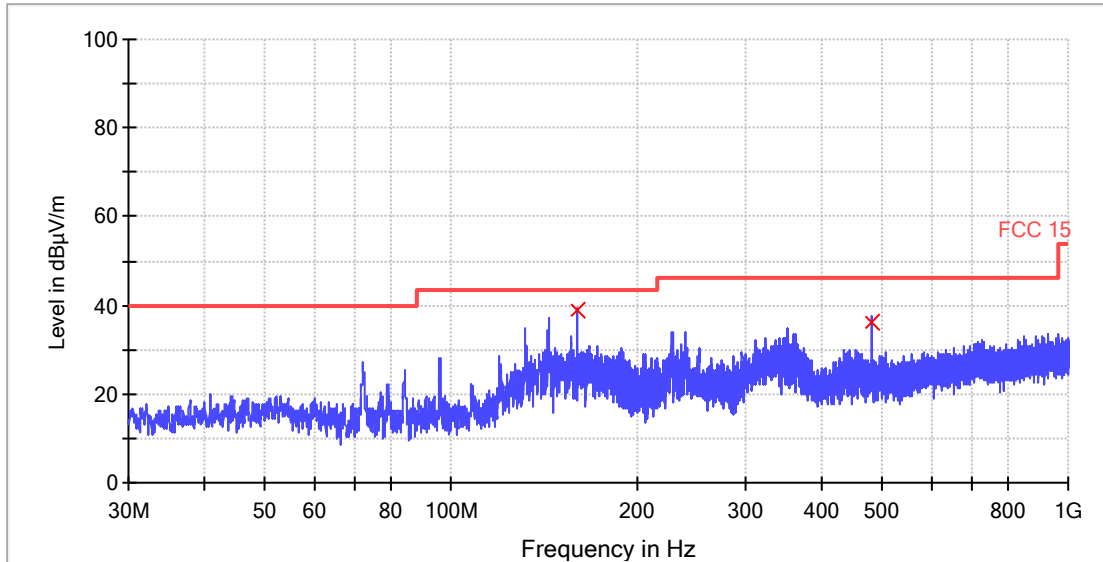

QP

Frequency (MHz)	Quasi Peak (dBµV/m)	Bandwidth (kHz)	Pol	Corr. (dB)	Margin - QPK (dB)	Limit - QPK (dBµV/m)
159.960000	39.0	120.000	H	10.4	4.5	43.5
480.000000	36.2	120.000	H	19.3	9.8	46.0

Remark:

1. Corr. (dB) = Antenna Factor (dB) + Cable Loss (dB)
2. Quasi Peak (dBµV/m) = Corr. (dB) + Read Level (dBµV)
3. Margin (dB) = Limit QPK (dBµV/m) – Quasi Peak (dBµV/m)

TEST REPORT

1~25 GHz Radiated Emissions.

PK Measurement:

Frequency (MHz)	PK Reading Level (dB μ V)	Correction factors (dB/m)	PK Emission Level (dB μ V/m)	PK Limit (dB μ V/m)	Antenna polarization
4873	50.7	-1.0	49.7	74	H
11295	42.9	6.5	49.4	74	H
4874	50.5	-1.0	49.5	74	V

AV Measurement:

Frequency (MHz)	AV Reading Level (dB μ V)	Correction factors (dB/m)	AV Emission Level (dB μ V/m)	AV Limit (dB μ V/m)	Antenna polarization
4873	/	-1.0	/	54	H
11295	/	6.5	/	54	H
4874	/	-1.0	/	54	V

Remark: When Peak emission level was below AV limit, the AV emission level did not be recorded

TEST REPORT

Test at Channel 11 (2.462 GHz) in transmitting status
30 MHz~1 GHz Radiated Emissions .Quasi-Peak Measurement

Vertical:

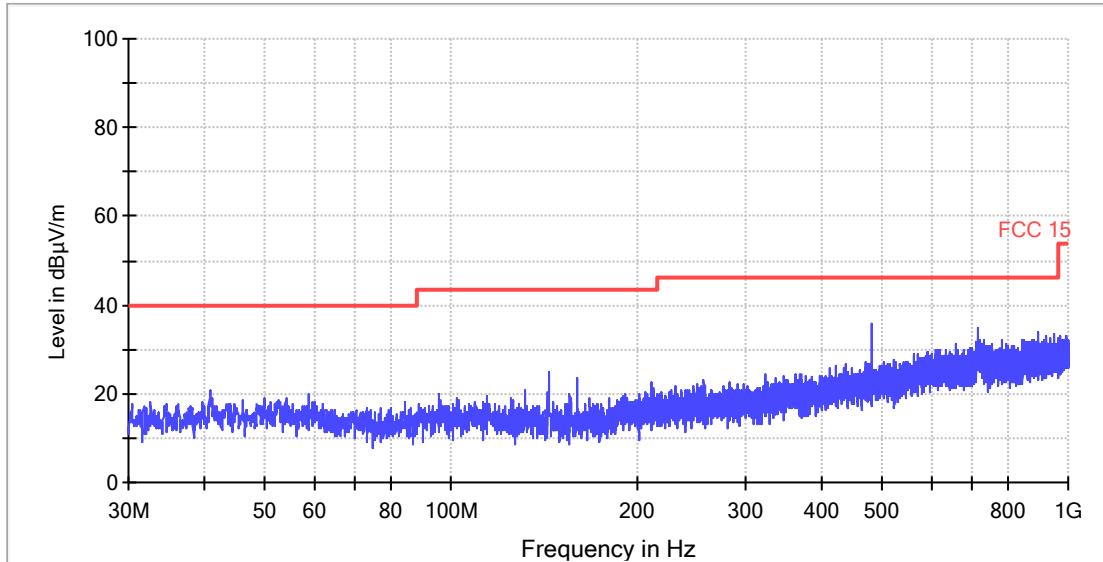

Remark:

1. Corr. (dB) = Antenna Factor (dB) + Cable Loss (dB)
2. Quasi Peak (dBµV/m) = Corr. (dB) + Read Level (dBµV)
3. Margin (dB) = Limit QPK (dBµV/m) –Quasi Peak (dBµV/m)

TEST REPORT

Horizontal:

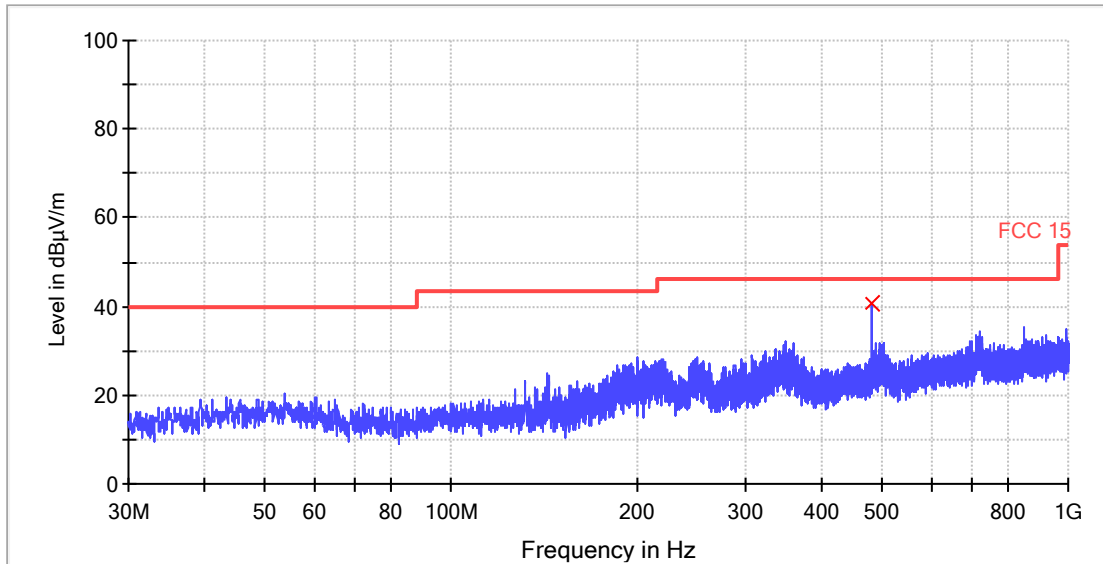

QP

Frequency (MHz)	Quasi Peak (dBµV/m)	Bandwidth (kHz)	Pol	Corr. (dB)	Margin - QPK (dB)	Limit - QPK (dBµV/m)
480.000000	40.6	120.000	H	19.3	5.4	46.0

Remark:

1. Corr. (dB) = Antenna Factor (dB) + Cable Loss (dB)
2. Quasi Peak (dBµV/m) = Corr. (dB) + Read Level (dBµV)
3. Margin (dB) = Limit QPK (dBµV/m) – Quasi Peak (dBµV/m)

TEST REPORT

1~25 GHz Radiated Emissions. Peak & Average Measurement

PK Measurement:

Frequency (MHz)	PK Reading Level (dB μ V)	Correction factors (dB/m)	PK Emission Level (dB μ V/m)	PK Limit (dB μ V/m)	Antenna polarization
4924	52.4	-0.9	51.5	74	H
11781	42.3	6.5	48.8	74	H
4924	48.5	-0.9	47.6	74	V
11934	43.1	6.6	49.7	74	V

AV Measurement:

Frequency (MHz)	AV Reading Level (dB μ V)	Correction factors (dB/m)	AV Emission Level (dB μ V/m)	AV Limit (dB μ V/m)	Antenna polarization
4924	/	-0.9	/	54	H
11781	/	6.5	/	54	H
4924	/	-0.9	/	54	V
11934	/	6.6	/	54	V

Remark: When Peak emission level was below AV limit, the AV emission level did not be recorded.

TEST REPORT

Restricted Bands Measurement
Horizontal

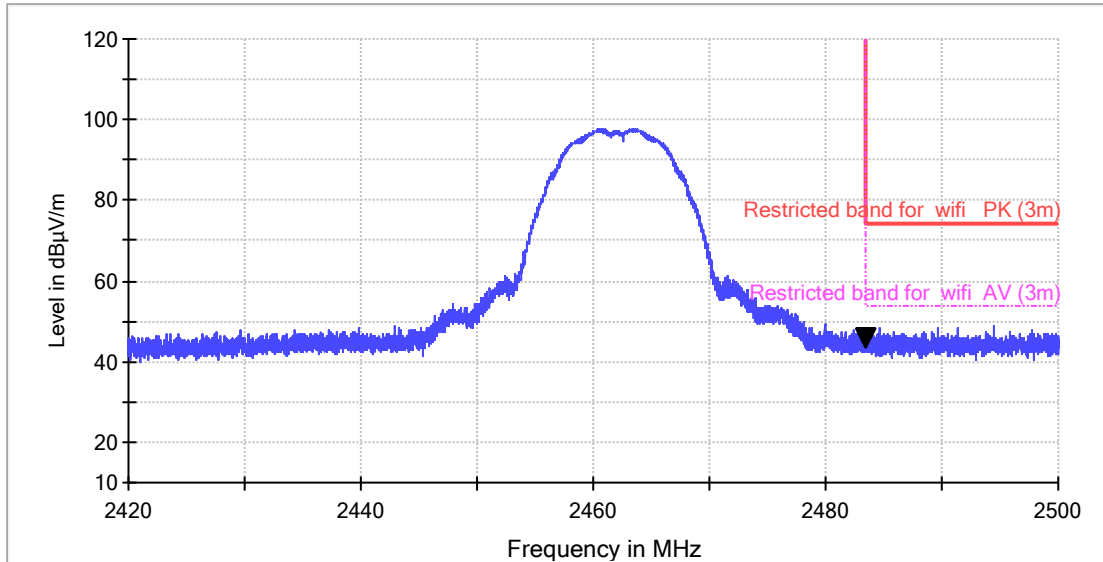

Vertical

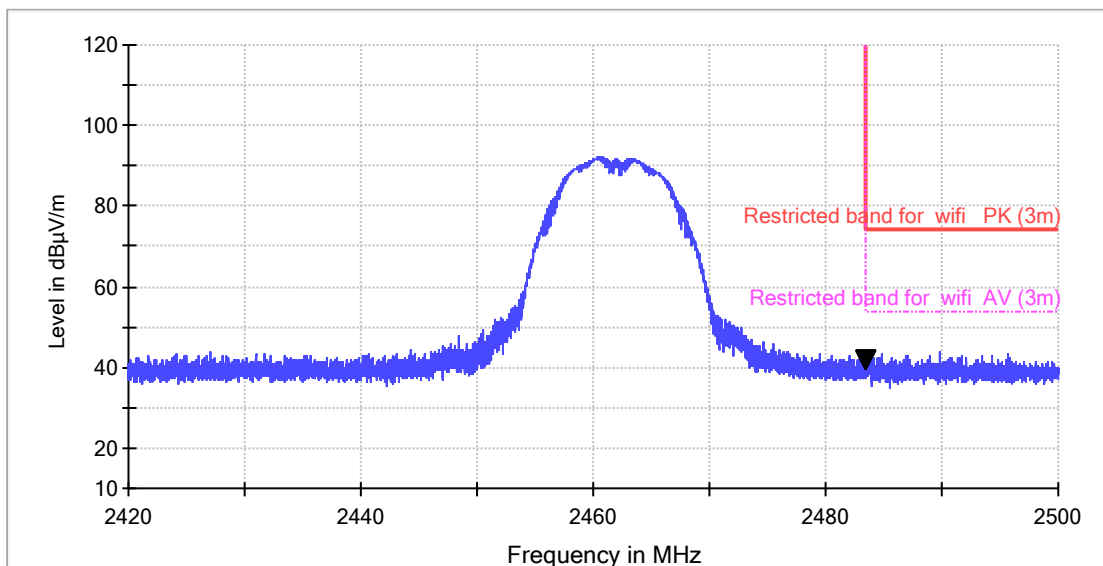

Frequency (MHz)	PK Reading Level (dBµV)	Correction factors (dB/m)	PK Emission Level (dBµV/m)	PK Limit (dBµV/m)	Antenna polarization
2483.5	51.9	-7.8	44.1	74	H
2483.5	47.6	-7.8	39.8	74	V

Remark:

When Peak emission level was below AV limit, the AV emission level did not be recorded.

TEST REPORT

802.11g mode with 6Mbps data rate

9 kHz~30 MHz Field Strength of Unwanted Emissions. Quasi-Peak Measurement

The measurements with active loop antenna were greater than 20dB below the limit, so the test data were not recorded in the test report.

Test at Channel 1 (2.412 GHz) in transmitting status

30 MHz~1 Radiated Emissions .Quasi-Peak Measurement

Vertical:

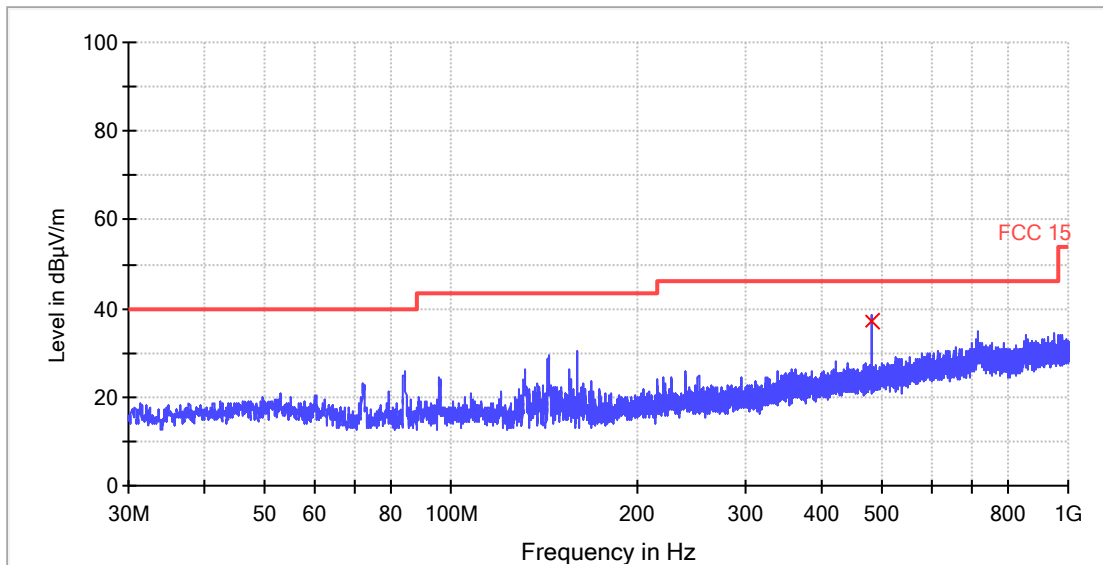

QP

Frequency (MHz)	Quasi Peak (dBµV/m)	Bandwidth (kHz)	Pol	Corr. (dB)	Margin - QPK (dB)	Limit - QPK (dBµV/m)
480.000000	37.1	120.000	V	19.3	8.9	46.0

Remark:

1. Corr. (dB) = Antenna Factor (dB) + Cable Loss (dB)
2. Quasi Peak (dBµV/m) = Corr. (dB) + Read Level (dBµV)
3. Margin (dB) = Limit QPK (dBµV/m) – Quasi Peak (dBµV/m)

TEST REPORT

Horizontal:

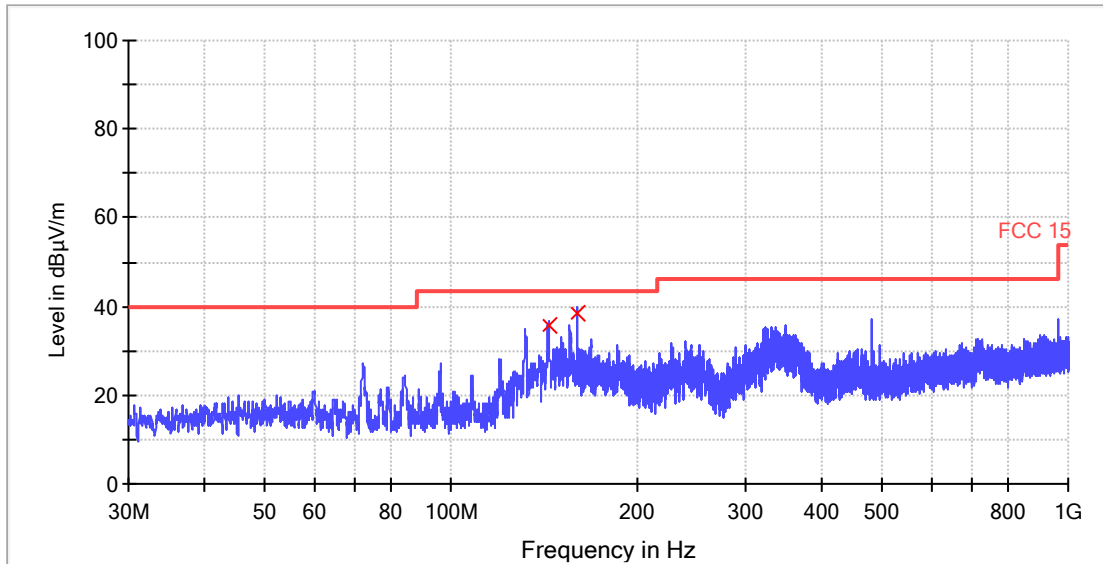

QP

Frequency (MHz)	Quasi Peak (dBµV/m)	Bandwidth (kHz)	Pol	Corr. (dB)	Margin - QPK (dB)	Limit - QPK (dBµV/m)
143.800000	35.8	120.000	H	9.9	7.7	43.5
159.960000	38.5	120.000	H	10.4	5.0	43.5

Remark:

1. Corr. (dB) = Antenna Factor (dB) + Cable Loss (dB)
2. Quasi Peak (dBµV/m) = Corr. (dB) + Read Level (dBµV)
3. Margin (dB) = Limit QPK (dBµV/m) – Quasi Peak (dBµV/m)

TEST REPORT

1~25 GHz Radiated Emissions. Peak & Average Measurement

PK Measurement:

Frequency (MHz)	PK Reading Level (dB μ V)	Correction factors (dB/m)	PK Emission Level (dB μ V/m)	PK Limit (dB μ V/m)	Antenna polarization
4819	47.0	-1.1	45.9	74	H
4825	45.8	-1.1	44.7	74	V

AV Measurement:

Frequency (MHz)	AV Reading Level (dB μ V)	Correction factors (dB/m)	AV Emission Level (dB μ V/m)	AV Limit (dB μ V/m)	Antenna polarization
4819	/	-1.1	/	54	H
4825	/	-1.1	/	54	V

Remark: When Peak emission level was below AV limit, the AV emission level did not be recorded.

TEST REPORT

Restricted Bands Measurement Horizontal

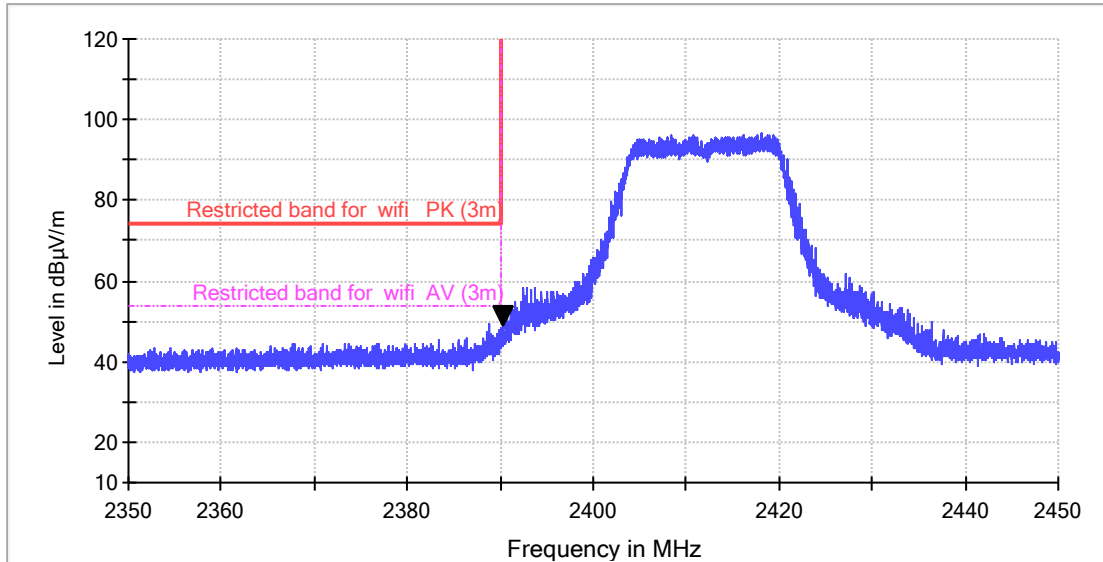

Vertical

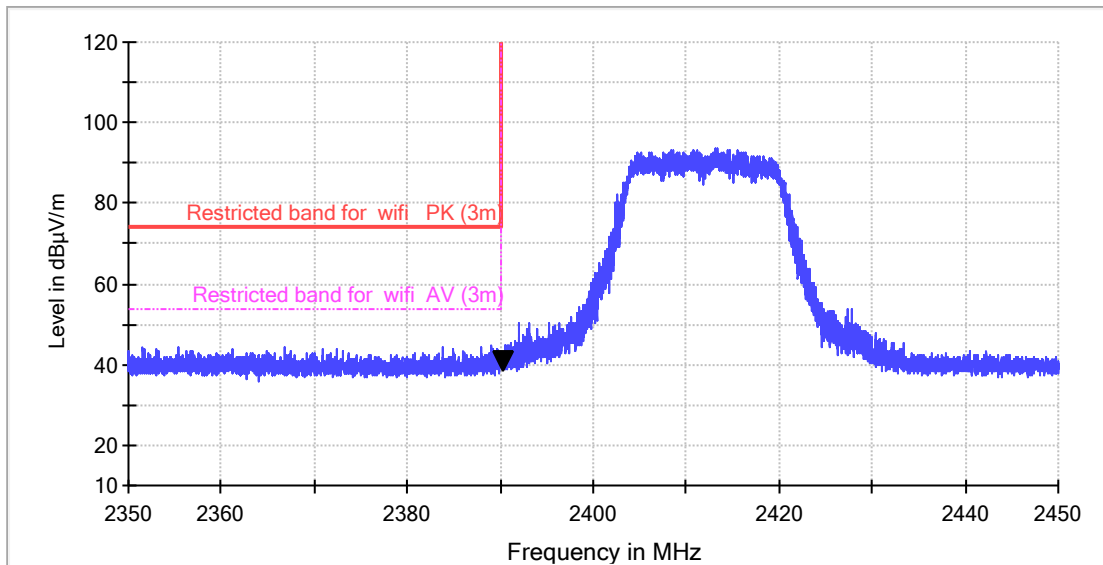

Frequency (MHz)	PK Reading Level (dBµV)	Correction factors (dB/m)	PK Emission Level (dBµV/m)	PK Limit (dBµV/m)	Antenna polarization
2390	57.5	-8.2	49.3	74	H
2390	47.2	-8.2	39.0	74	V

Remark:

When Peak emission level was below AV limit, the AV emission level did not be recorded.

TEST REPORT

Test at Channel 6 (2.437GHz) in transmitting status
30 MHz~1 GHz Radiated Emissions .Quasi-Peak Measurement

Vertical:

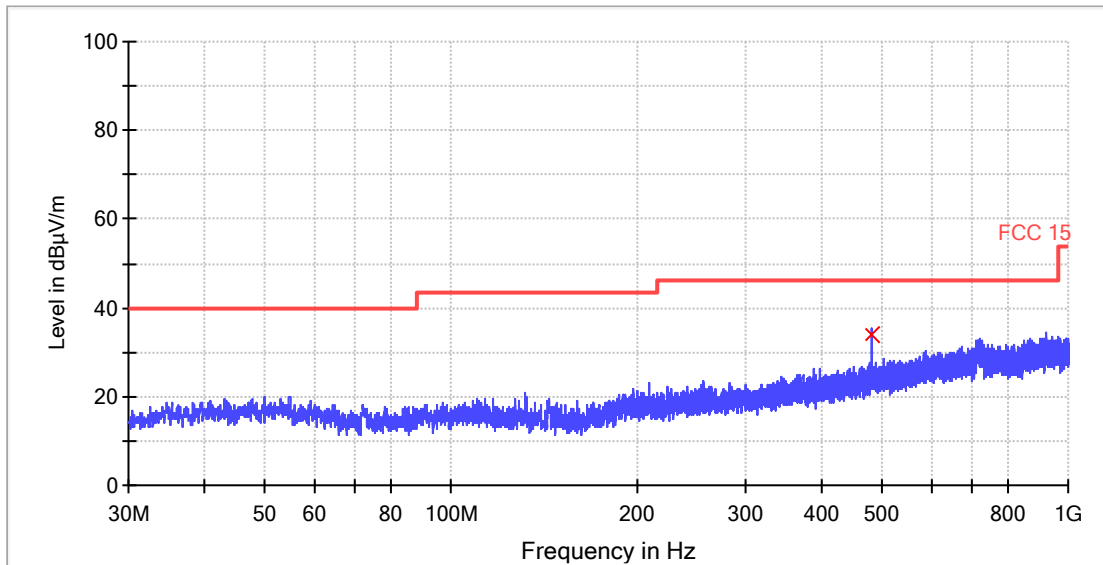

QP

Frequency (MHz)	Quasi Peak (dBµV/m)	Bandwidth (kHz)	Pol	Corr. (dB)	Margin - QPK (dB)	Limit - QPK (dBµV/m)
480.000000	34.1	120.000	V	19.3	11.9	46.0

Remark:

1. Corr. (dB) = Antenna Factor (dB) + Cable Loss (dB)
2. Quasi Peak (dBµV/m) = Corr. (dB) + Read Level (dBµV)
3. Margin (dB) = Limit QPK (dBµV/m) –Quasi Peak (dBµV/m)

TEST REPORT

Horizontal:

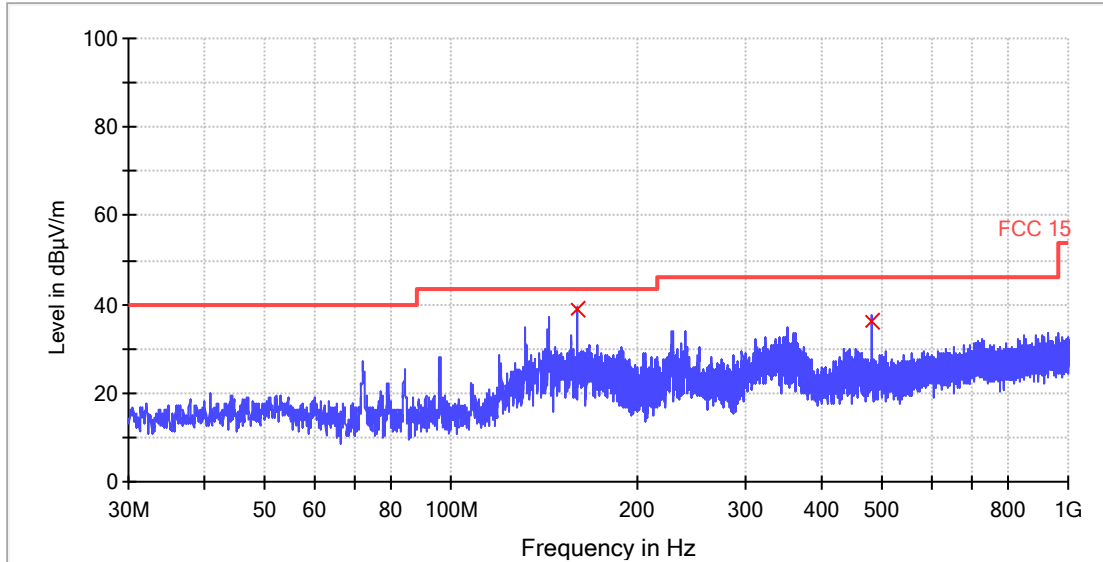

QP

Frequency (MHz)	Quasi Peak (dBµV/m)	Bandwidth (kHz)	Pol	Corr. (dB)	Margin - QPK (dB)	Limit - QPK (dBµV/m)
159.960000	39.0	120.000	H	10.4	4.5	43.5
480.000000	36.2	120.000	H	19.3	9.8	46.0

Remark:

1. Corr. (dB) = Antenna Factor (dB) + Cable Loss (dB)
2. Quasi Peak (dBµV/m) = Corr. (dB) + Read Level (dBµV)
3. Margin (dB) = Limit QPK (dBµV/m) - Quasi Peak (dBµV/m)

TEST REPORT

1~25 GHz Radiated Emissions. Peak & Average Measurement

PK Measurement:

Frequency (MHz)	PK Reading Level (dBμV)	Correction factors (dB/m)	PK Emission Level (dBμV/m)	PK Limit (dBμV/m)	Antenna polarization
4876	51.3	-1.0	50.3	74	H
4871	46.5	-1.0	45.5	74	V

AV Measurement:

Frequency (MHz)	AV Reading Level (dBμV)	Correction factors (dB/m)	AV Emission Level (dBμV/m)	AV Limit (dBμV/m)	Antenna polarization
4876	/	-1.0	/	54	H
4871	/	-1.0	/	54	V

Remark: When Peak emission level was below AV limit, the AV emission level did not be recorded.

TEST REPORT

Test at Channel 11 (2.462 GHz) in transmitting status
30 MHz~1 GHz Radiated Emissions .Quasi-Peak Measurement

Vertical:

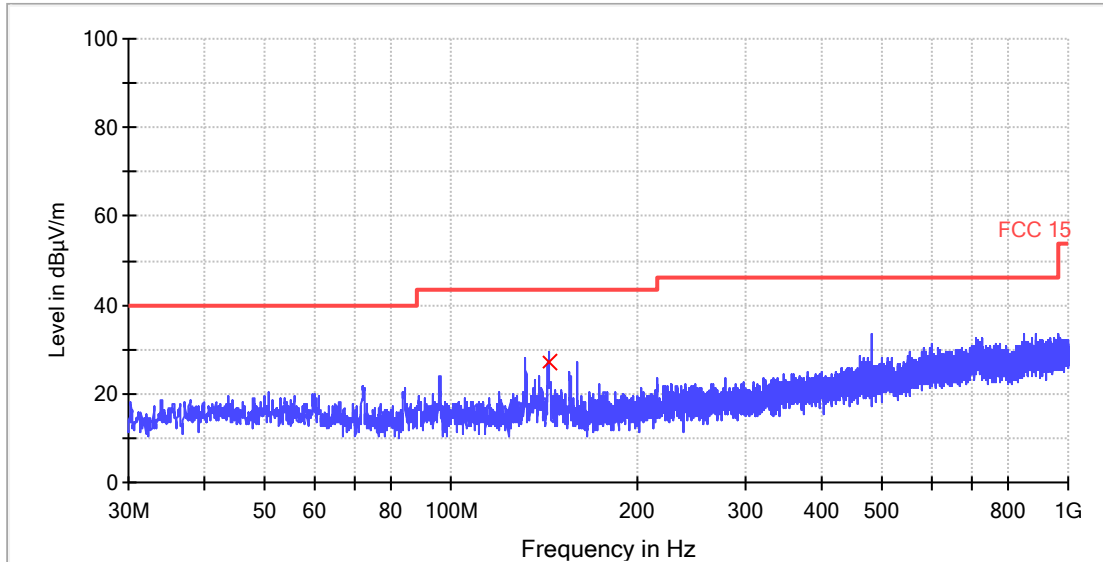

QP

Frequency (MHz)	Quasi Peak (dBµV/m)	Bandwidth (kHz)	Pol	Corr. (dB)	Margin - QPK (dB)	Limit - QPK (dBµV/m)
143.840000	27.2	120.000	V	9.9	16.3	43.5

Remark:

1. Corr. (dB) = Antenna Factor (dB) + Cable Loss (dB)
2. Quasi Peak (dBµV/m) = Corr. (dB) + Read Level (dBµV)
3. Margin (dB) = Limit QPK (dBµV/m) –Quasi Peak (dBµV/m)

TEST REPORT

Horizontal:

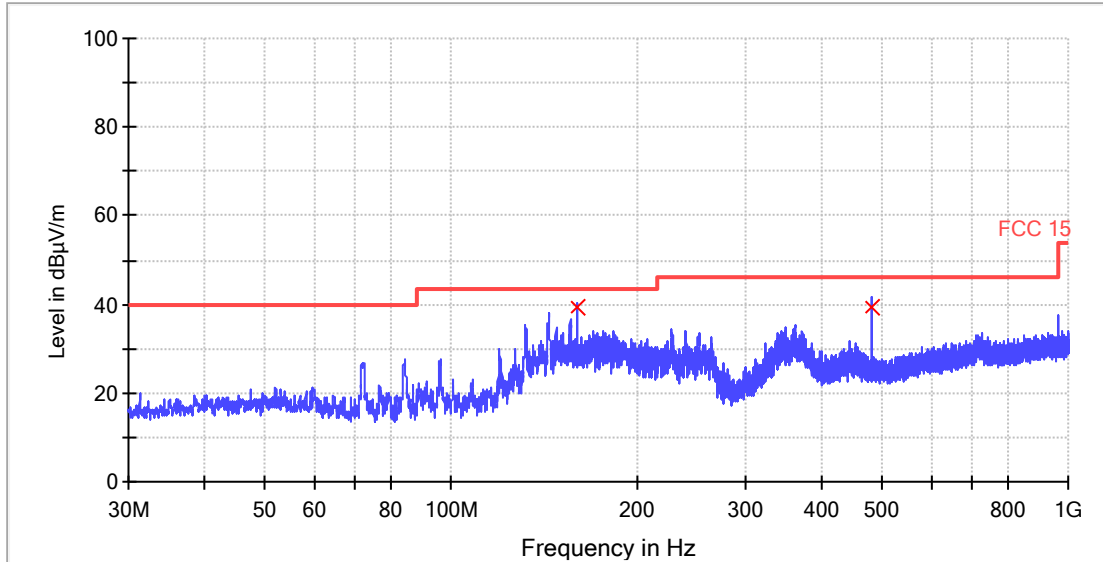

QP

Frequency (MHz)	Quasi Peak (dBµV/m)	Bandwidth (kHz)	Pol	Corr. (dB)	Margin - QPK (dB)	Limit - QPK (dBµV/m)
159.960000	39.5	120.000	H	10.4	4.0	43.5
480.000000	39.5	120.000	H	19.3	6.5	46.0

Remark:

1. Corr. (dB) = Antenna Factor (dB) + Cable Loss (dB)
2. Quasi Peak (dBµV/m) = Corr. (dB) + Read Level (dBµV)
3. Margin (dB) = Limit QPK (dBµV/m) – Quasi Peak (dBµV/m)

TEST REPORT

1~25 GHz Radiated Emissions. Peak & Average Measurement

PK Measurement:

Frequency (MHz)	PK Reading Level (dB μ V)	Correction factors (dB/m)	PK Emission Level (dB μ V/m)	PK Limit (dB μ V/m)	Antenna polarization
4917	50.8	-1.0	49.8	74	H
8108	45.1	4.0	49.1	74	H
4926	46.6	-0.9	45.7	74	V

AV Measurement:

Frequency (MHz)	AV Reading Level (dB μ V)	Correction factors (dB/m)	AV Emission Level (dB μ V/m)	AV Limit (dB μ V/m)	Antenna polarization
4917	/	-1.0	/	54	H
8108	/	4.0	/	54	H
4926	/	-0.9	/	54	V

Remark: When Peak emission level was below AV limit, the AV emission level did not be recorded.

TEST REPORT

Restricted Bands Measurement
Horizontal

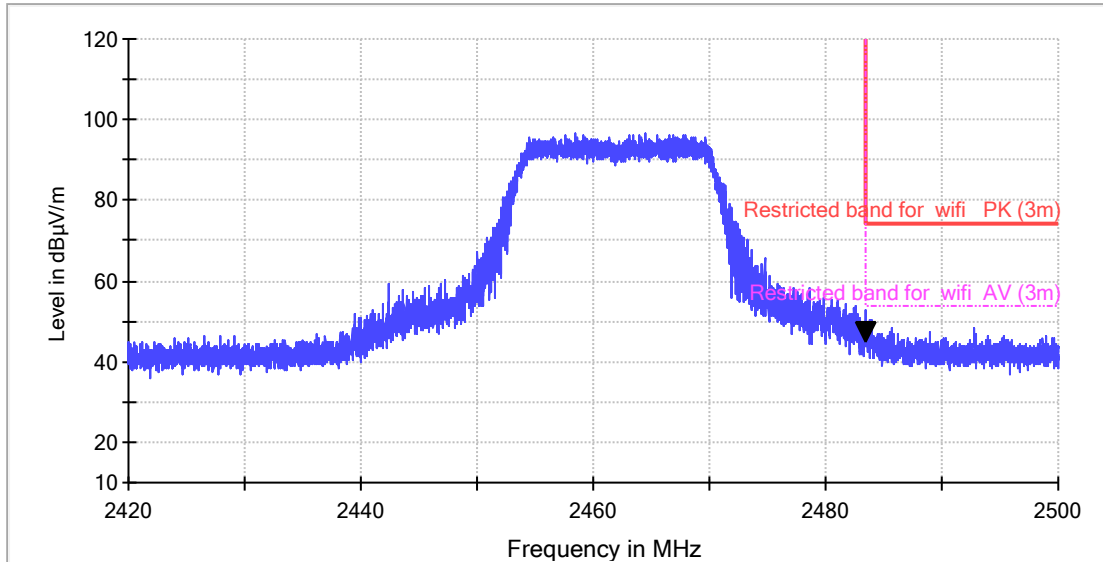

Vertical

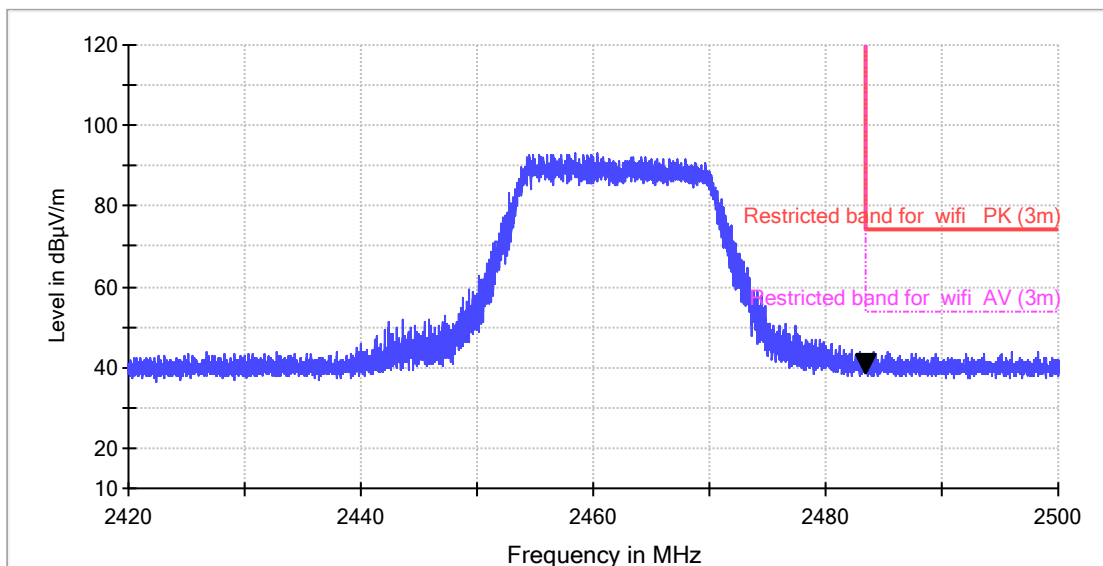

Frequency (MHz)	PK Reading Level (dBµV)	Correction factors (dB/m)	PK Emission Level (dBµV/m)	PK Limit (dBµV/m)	Antenna polarization
2483.5	52.9	-7.8	45.1	74	H
2483.5	46.6	-7.8	38.8	74	V

Remark:

When Peak emission level was below AV limit, the AV emission level did not be recorded.

TEST REPORT

802.11n (HT20) mode with 6.5Mbps data rate

9 kHz~30 MHz Field Strength of Unwanted Emissions. Quasi-Peak Measurement

The measurements with active loop antenna were greater than 20dB below the limit, so the test data were not recorded in the test report.

Test at Channel 1 (2.412 GHz) in transmitting status

30 MHz~1 GHz Radiated Emissions .Quasi-Peak Measurement

Vertical:

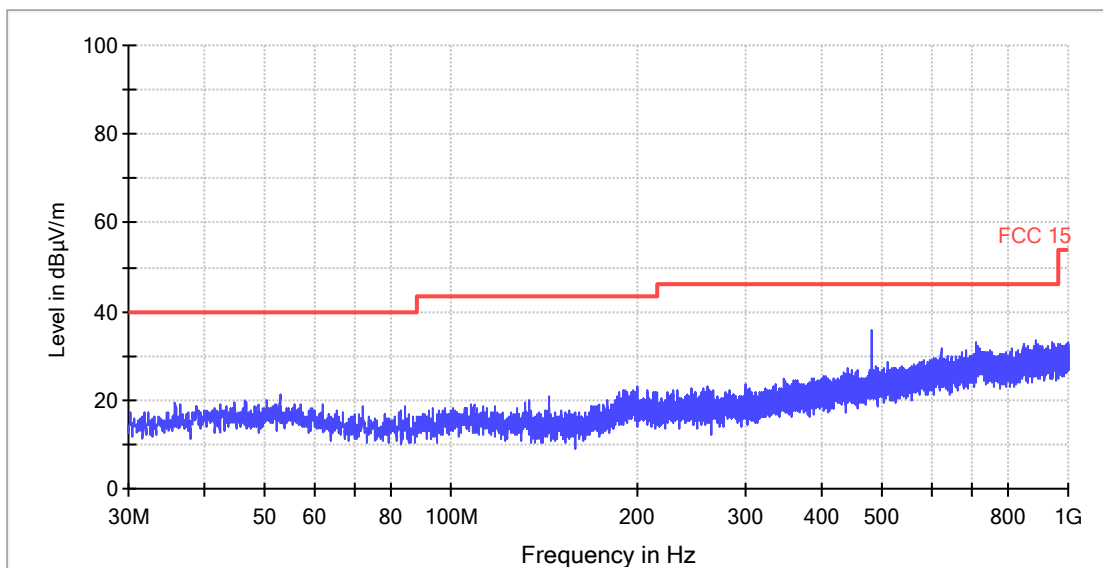

Remark:

1. Corr. (dB) = Antenna Factor (dB) + Cable Loss (dB)
2. Quasi Peak (dBµV/m) = Corr. (dB) + Read Level (dBµV)
3. Margin (dB) = Limit QPK (dBµV/m) –Quasi Peak (dBµV/m)

TEST REPORT

Horizontal:

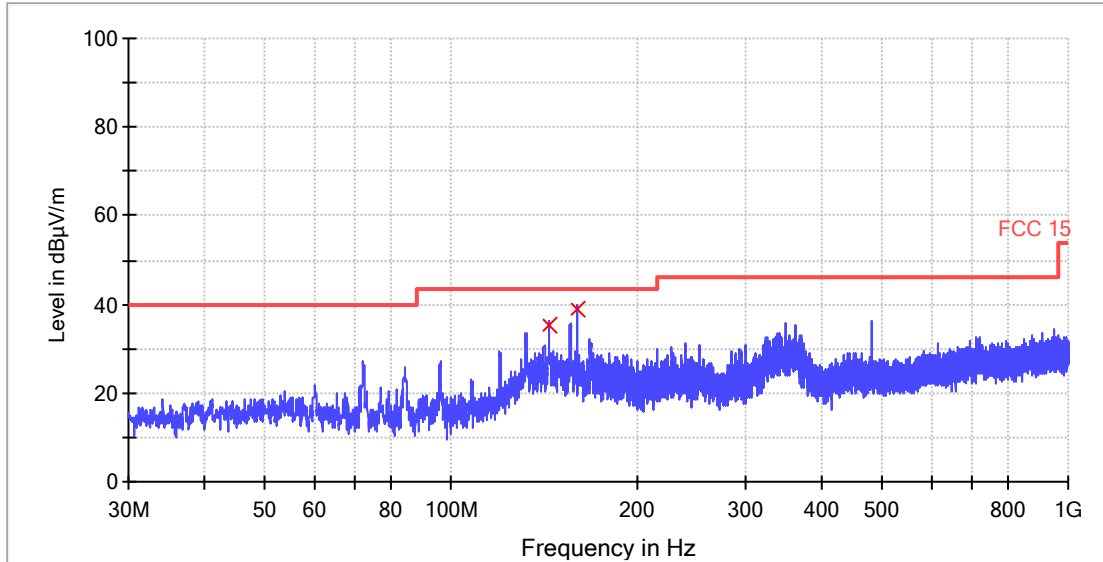

QP

Frequency (MHz)	Quasi Peak (dBµV/m)	Bandwidth (kHz)	Pol	Corr. (dB)	Margin - QPK (dB)	Limit - QPK (dBµV/m)
144.120000	35.5	120.000	H	9.9	8.0	43.5
159.960000	38.9	120.000	H	10.4	4.6	43.5

Remark:

1. Corr. (dB) = Antenna Factor (dB) + Cable Loss (dB)
2. Quasi Peak (dBµV/m) = Corr. (dB) + Read Level (dBµV)
3. Margin (dB) = Limit QPK (dBµV/m) – Quasi Peak (dBµV/m)

TEST REPORT

1~25 GHz Radiated Emissions. Peak & Average Measurement

PK Measurement:

Frequency (MHz)	PK Reading Level (dB μ V)	Correction factors (dB/m)	PK Emission Level (dB μ V/m)	PK Limit (dB μ V/m)	Antenna polarization
4835	49.3	-1.1	48.2	74	H
8010	44.2	3.9	48.1	74	H

AV Measurement:

Frequency (MHz)	AV Reading Level (dB μ V)	Correction factors (dB/m)	AV Emission Level (dB μ V/m)	AV Limit (dB μ V/m)	Antenna polarization
4835	/	-1.1	/	54	H
8010	/	3.9	/	54	H

Remark: When Peak emission level was below AV limit, the AV emission level did not be recorded.

TEST REPORT

Restricted Bands Measurement

Horizontal

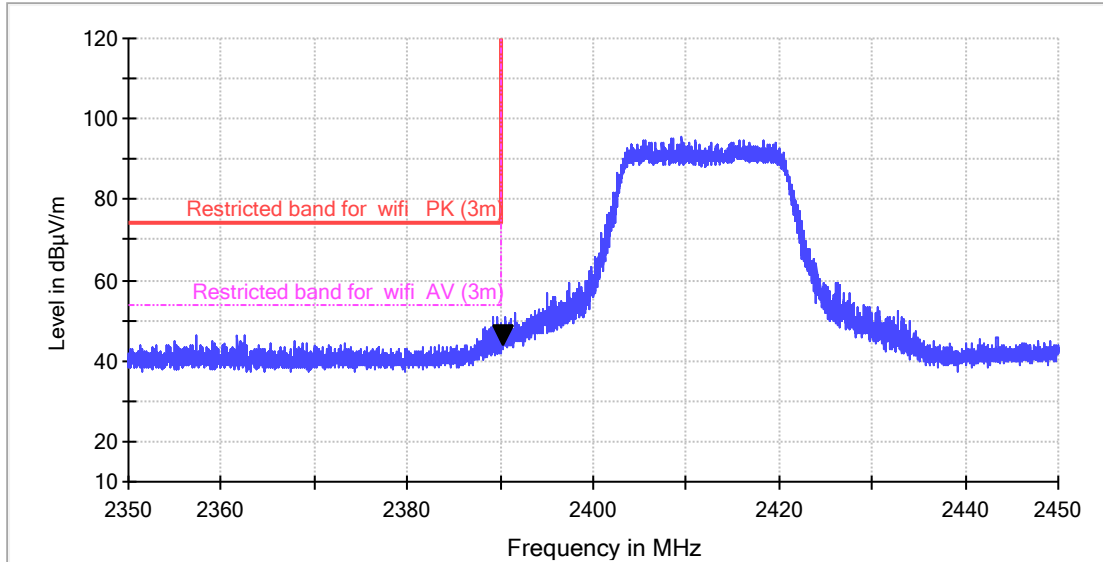

Vertical

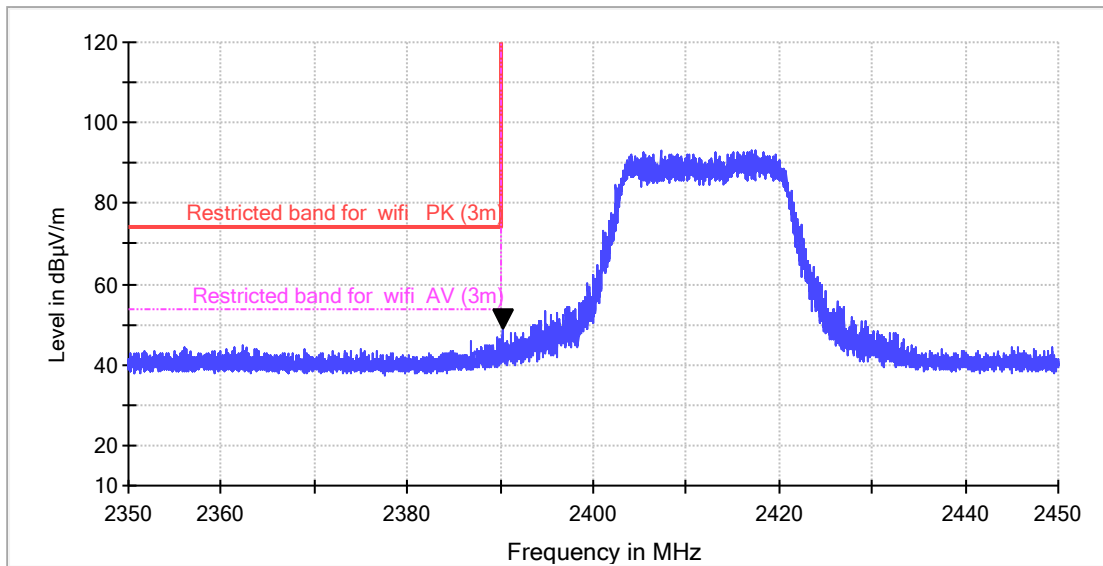

Frequency (MHz)	PK Reading Level (dBµV)	Correction factors (dB/m)	PK Emission Level (dBµV/m)	PK Limit (dBµV/m)	Antenna polarization
2390	52.4	-8.2	44.2	74	H
2390	57.5	-8.2	49.3	74	V

Remark:

When Peak emission level was below AV limit, the AV emission level did not be recorded.

TEST REPORT

Test at Channel 6 (2.437 GHz) in transmitting status

30 MHz~1 GHz Radiated Emissions .Quasi-Peak Measurement

Vertical:

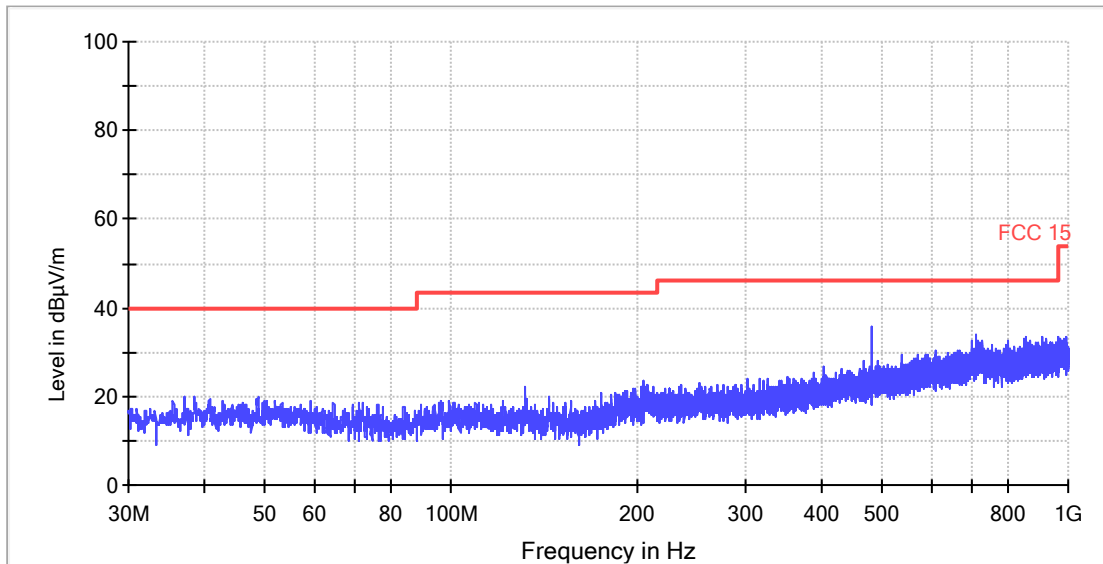

Remark:

1. Corr. (dB) = Antenna Factor (dB) + Cable Loss (dB)
2. Quasi Peak (dBµV/m) = Corr. (dB) + Read Level (dBµV)
3. Margin (dB) = Limit QPK (dBµV/m) –Quasi Peak (dBµV/m)

TEST REPORT

Horizontal:

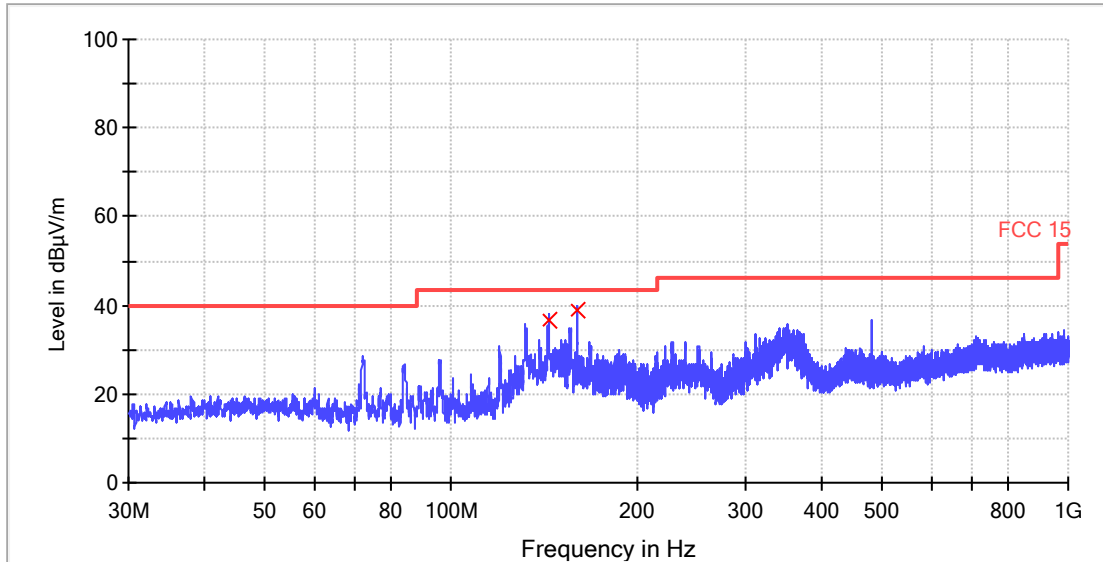

QP

Frequency (MHz)	Quasi Peak (dBµV/m)	Bandwidth (kHz)	Pol	Corr. (dB)	Margin - QPK (dB)	Limit - QPK (dBµV/m)
143.800000	36.8	120.000	H	9.9	6.7	43.5
159.960000	39.0	120.000	H	10.4	4.5	43.5

Remark:

1. Corr. (dB) = Antenna Factor (dB) + Cable Loss (dB)
2. Quasi Peak (dBµV/m) = Corr. (dB) + Read Level (dBµV)
3. Margin (dB) = Limit QPK (dBµV/m) – Quasi Peak (dBµV/m)

TEST REPORT

1~25 GHz Radiated Emissions. Peak & Average Measurement

PK Measurement:

Frequency (MHz)	PK Reading Level (dB μ V)	Correction factors (dB/m)	PK Emission Level (dB μ V/m)	PK Limit (dB μ V/m)	Antenna polarization
4874	48.6	-1.0	47.6	74	H
8070	44.0	4.0	48.0	74	H

AV Measurement:

Frequency (MHz)	AV Reading Level (dB μ V)	Correction factors (dB/m)	AV Emission Level (dB μ V/m)	AV Limit (dB μ V/m)	Antenna polarization
4874	/	-1.0	/	54	H
8070	/	4.0	/	54	H

Remark: When Peak emission level was below AV limit, the AV emission level did not be record.

TEST REPORT

Test at Channel 11 (2.462 GHz) in transmitting status
30 MHz~1 GHz Radiated Emissions .Quasi-Peak Measurement

Vertical:

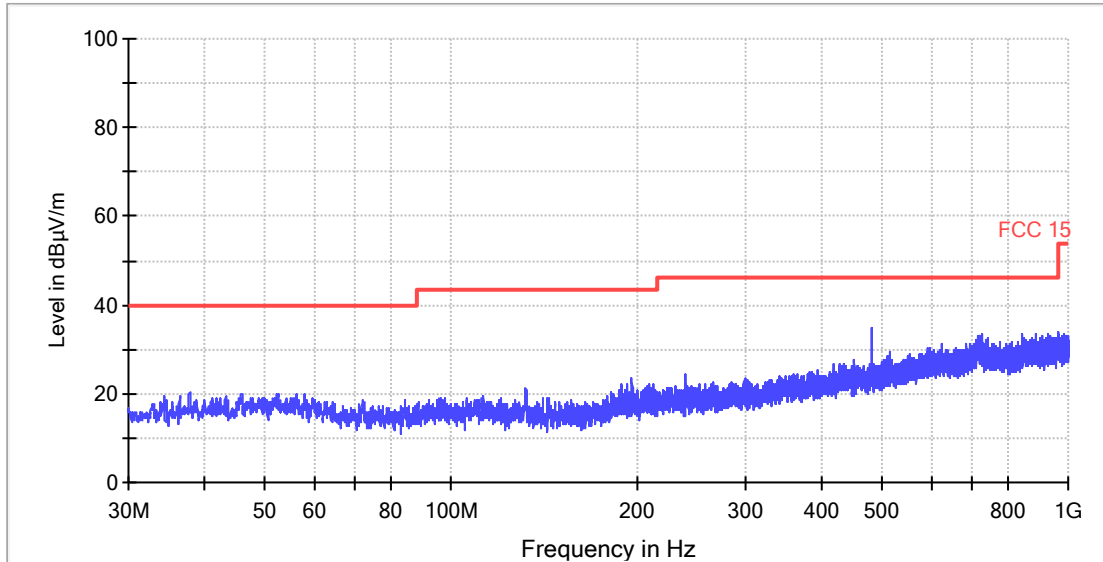

Remark:

1. Corr. (dB) = Antenna Factor (dB) + Cable Loss (dB)
2. Quasi Peak (dBµV/m) = Corr. (dB) + Read Level (dBµV)
3. Margin (dB) = Limit QPK (dBµV/m) –Quasi Peak (dBµV/m)

TEST REPORT

Horizontal:

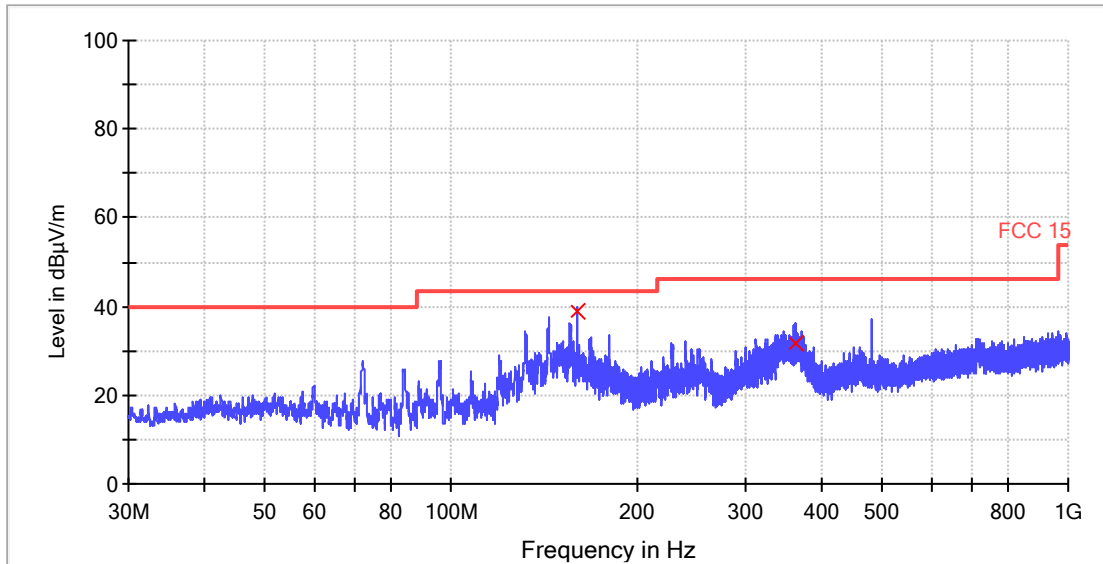

QP

Frequency (MHz)	Quasi Peak (dBµV/m)	Bandwidth (kHz)	Pol	Corr. (dB)	Margin - QPK (dB)	Limit - QPK (dBµV/m)
159.960000	38.9	120.000	H	10.4	4.6	43.5
360.520000	31.7	120.000	H	17.2	14.3	46.0

Remark:

1. Corr. (dB) = Antenna Factor (dB) + Cable Loss (dB)
2. Quasi Peak (dBµV/m) = Corr. (dB) + Read Level (dBµV)
3. Margin (dB) = Limit QPK (dBµV/m) - Quasi Peak (dBµV/m)

TEST REPORT

1~25 GHz Radiated Emissions. Peak & Average Measurement

PK Measurement:

Frequency (MHz)	PK Reading Level (dBμV)	Correction factors (dB/m)	PK Emission Level (dBμV/m)	PK Limit (dBμV/m)	Antenna polarization
4921	47.7	-0.9	46.8	74	H
11329	43.1	6.5	49.6	74	H

AV Measurement:

Frequency (MHz)	AV Reading Level (dBμV)	Correction factors (dB/m)	AV Emission Level (dBμV/m)	AV Limit (dBμV/m)	Antenna polarization
4921	/	-0.9	/	54	H
11329	/	6.5	/	54	H

Remark: When Peak emission level was below AV limit, the AV emission level did not be record.

TEST REPORT

Restricted Bands Measurement
Horizontal

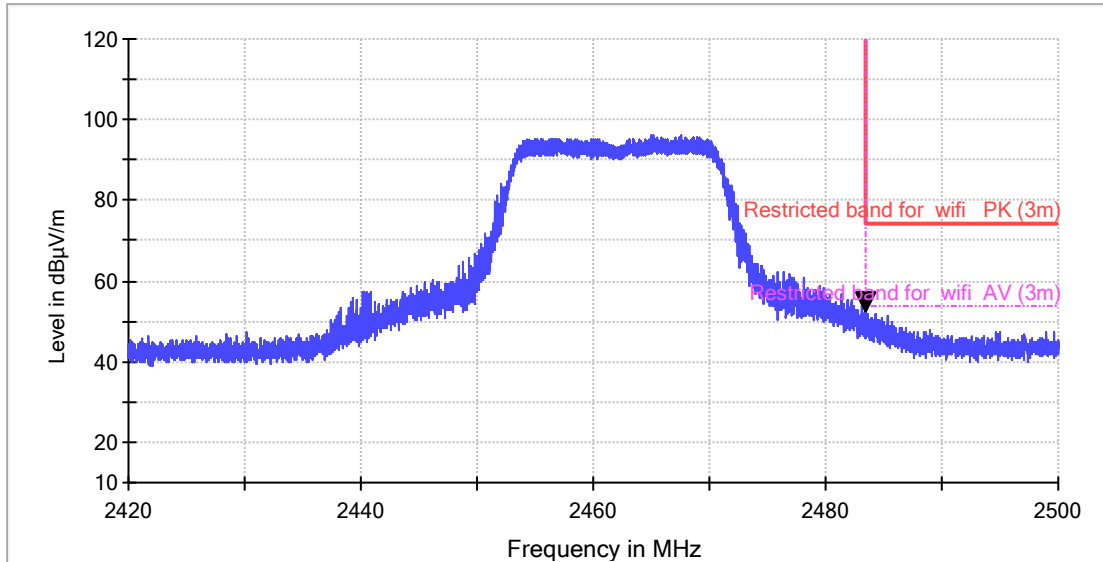

Vertical

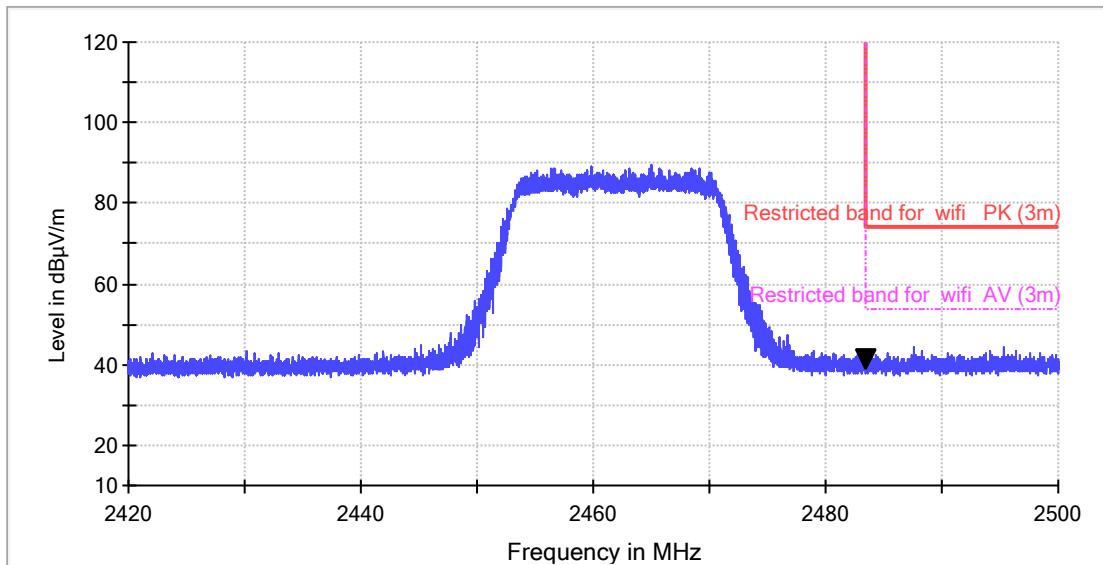

Frequency (MHz)	PK Reading Level (dBµV)	Correction factors (dB/m)	PK Emission Level (dBµV/m)	PK Limit (dBµV/m)	Antenna polarization
2483.5	60.4	-7.8	52.6	74	H
2483.5	47.0	-7.8	39.2	74	V

Remark:

When Peak emission level was below AV limit, the AV emission level did not be recorded.

TEST REPORT

4.9 Band Edges Requirement

Test Requirement:	FCC Part 15 C section 15.247 (d) In any 100 kHz bandwidth outside the frequency band in which the spread spectrum or digitally modulated intentional radiator is operating. The radio frequency power that is produced by the intentional radiator shall be at least 20 dB below that in the 100 kHz bandwidth within the band that contains the highest level of the desired power. Based on either an RF conducted or a radiated measurement. Provided the transmitter demonstrates compliance with the peak conducted power limits. If the transmitter complies with the conducted power limits based on the use of RMS averaging over a time interval, as permitted under paragraph (b)(3) of this section, the attenuation required under this paragraph shall be 30dB instead of 20dB.
Frequency Band:	2400 MHz to 2483.5 MHz
Test Method:	ANSI C63.10: Clause 11.11 and 11.13
Test Status:	Pre-Scan has been conducted to determine the worst-case mode from all possible combinations between available modulations, data rates and antenna ports (if EUT with antenna diversity architecture). Following channel(s) was (were) selected for the final test as listed below.
Test Configuration:	For Band Edges Emission in Radiated mode, Please refer to clause 4.7

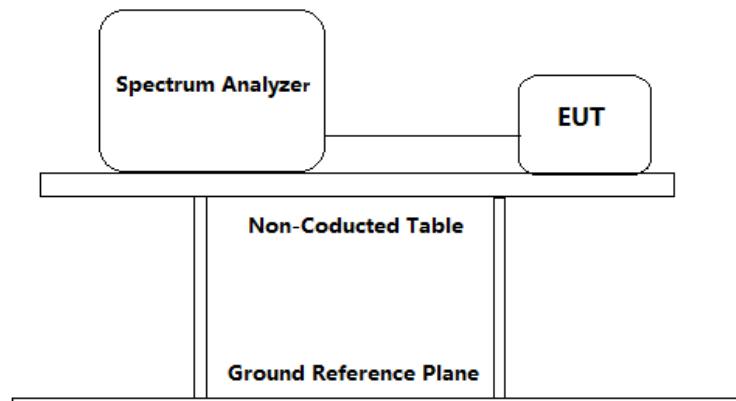

- | | |
|-----------------|--|
| Test Procedure: | For Band Edges Emission in Radiated mode, Please refer to clause 4.7 |
|-----------------|--|
1. Remove the antenna from the EUT and then connect a low RF cable from the antenna port to the spectrum analyzer.
 - a) Set instrument center frequency to the frequency of the emission to be measured (must be within 2 MHz of the authorized band edge).
 - b) Set the center frequency and span to encompass frequency range to be measured.
 - c) RBW = 100 kHz.
 - d) VBW \geq [3 \times RBW].

TEST REPORT

- e) Detector = peak.
 - f) Sweep time = auto.
 - g) Trace mode = max hold.
 - h) Allow sweep to continue until the trace stabilizes (required measurement time may increase for low-duty-cycle applications).
 - i) For radiated Band-edge emissions within a restricted band and within 2 MHz of an authorized band edge, integration method is considered.
2. Repeat until all the test status is investigated.
 3. Report the worst case.

Used Test Equipment List:

3m Semi-Anechoic Chamber, EMI Test Receiver (9 kHz~7 GHz), Signal and Spectrum Analyzer (10 Hz~40 GHz), Loop antenna (9 kHz-30 MHz). TRILOG Super Broadband test Antenna(30 MHz-3 GHz) (RX), Double-Ridged Waveguide Horn Antenna (800 MHz-18 GHz)(RX) and High Frequency Antenna & preamplifier(18 GHz~26.5 GHz) (RX). Refer to Clause 5 Test Equipment List for details.

Test result with plots as follows:

For conduct mode:

The band edges was measured and recorded Result:

The Lower Edges attenuated more than 30dB.

The Upper Edges attenuated more than 30dB.

Result plots as follows:

802.11b mode with 1 Mbps data rate

Channel1: 2.412 GHz

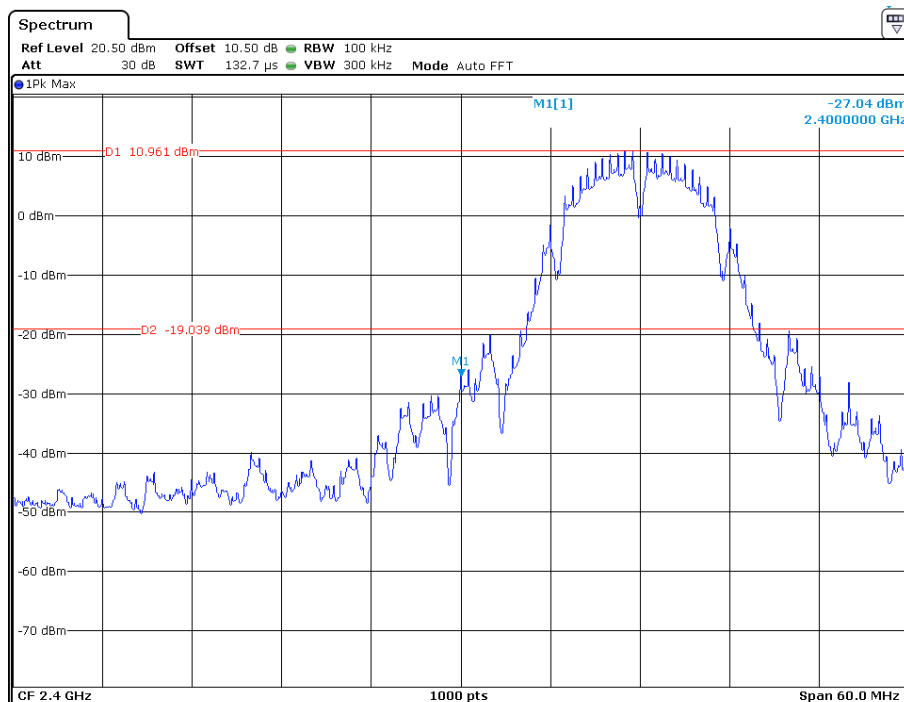

TEST REPORT

Channel 11: 2.462 GHz

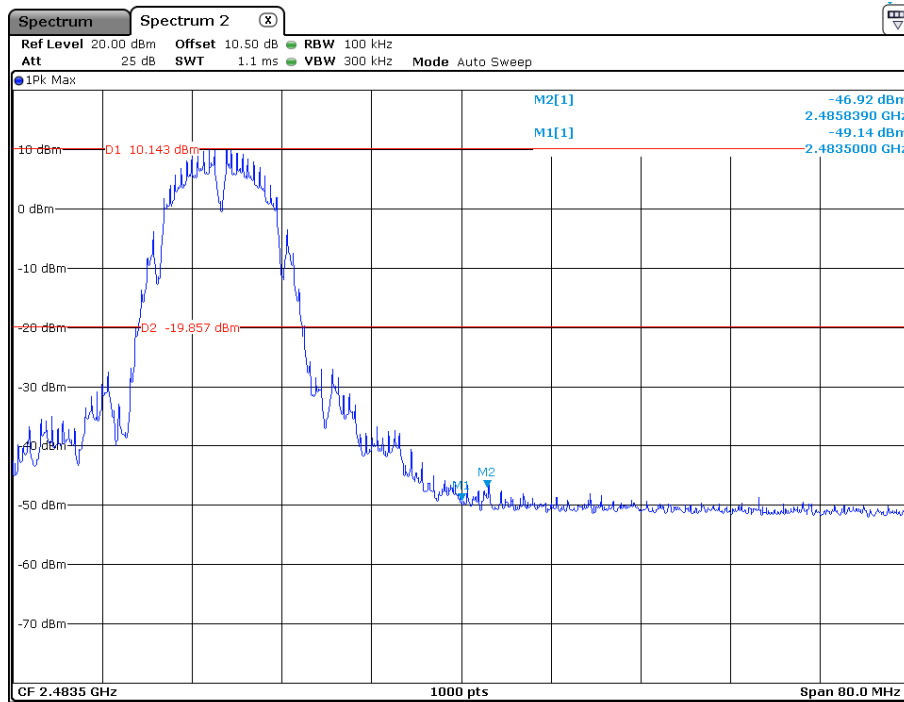

802.11g mode with 6 Mbps data rate

Channel1: 2.412 GHz

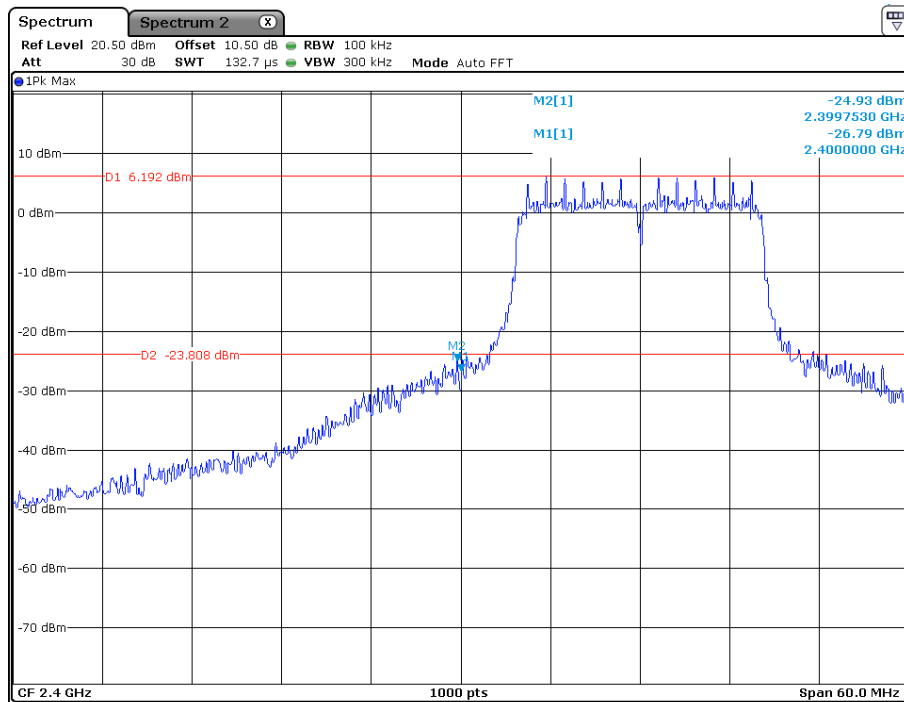

TEST REPORT

Channel 11: 2.462 GHz

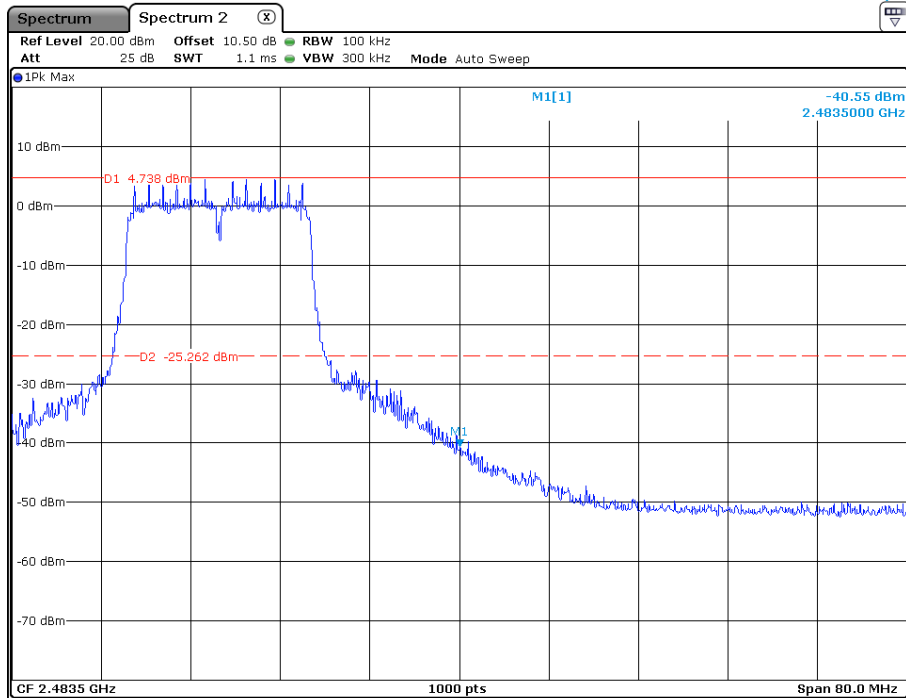

802.11n(HT20) mode with 6.5Mbps data rate

Channel 1: 2.412 GHz

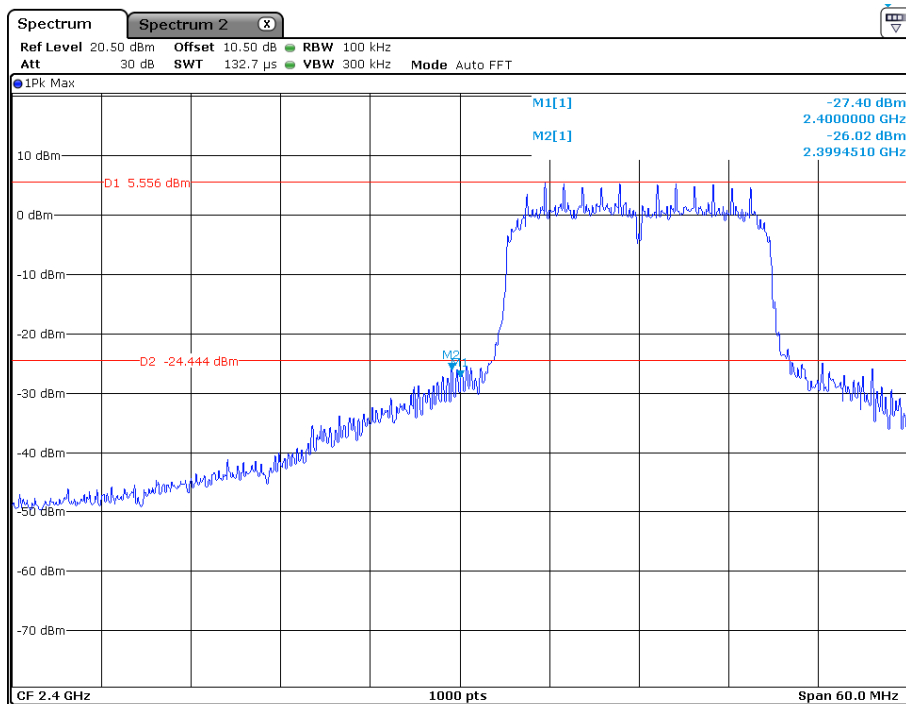

TEST REPORT

Channel 11: 2.462 GHz

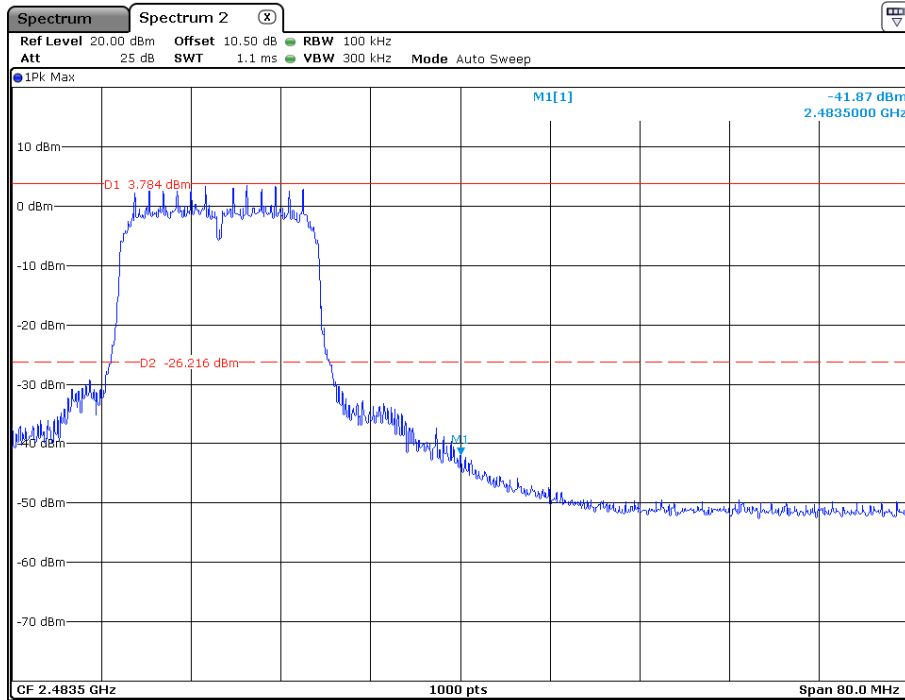

TEST REPORT

4.10 Conducted Emission Test

Test Configuration:

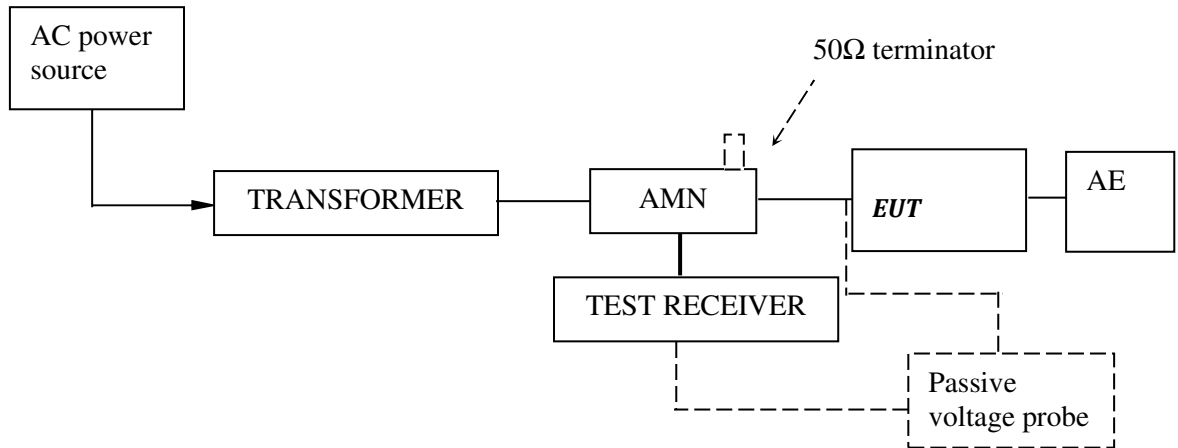

Test Setup and Procedure:

Test was performed according to ANSI C63.10 Clause 6.2. The EUT was set to achieve the maximum emission level. The mains terminal disturbance voltage was measured with the EUT in a shielded room. The EUT was connected to AC power source through an Artificial Mains Network which provides a 50Ω linear impedance Artificial hand is used if appropriate (for handheld apparatus). The load/control terminal disturbance voltage was measured with passive voltage probe if appropriate.

The table-top EUT was placed on a 0.8m high non-metallic table above earthed ground plane (Ground Reference Plane). And for floor standing EUT, was placed on a 12 mm high non-metallic supported on GRP. The EUT keeps a distance of at least 0.8m from any other of the metallic surface. The Artificial Mains Network is situated at a distance of 0.8m from the EUT.

During the test, mains lead of EUT excess 0.8m was folded back and forth parallel to the lead so as to form a horizontal bundle with a length between 0.3m and 0.4m

The bandwidth of test receiver was set at 9 kHz. The frequency range from 150 kHz to 30MHz was checked.

TEST REPORT

Test Data and Curve

At main terminal: Pass

Tested Wire: Live

Operation Mode: Continuously transmitting

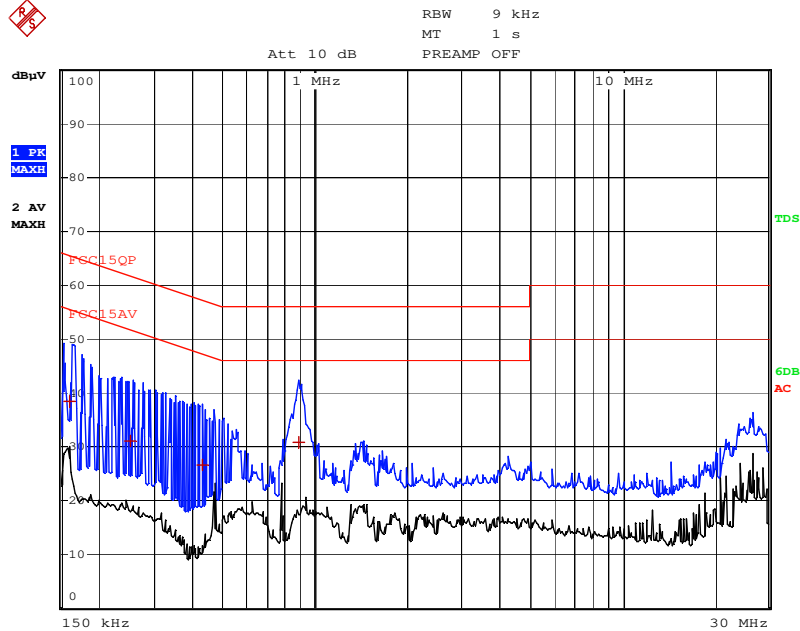

EDIT PEAK LIST (Final Measurement Results)			
Trace1:	FCC15QP		
Trace2:	FCC15AV		
Trace3:	---		
TRACE	FREQUENCY	LEVEL dBµV	DELTA LIMIT dB
1 Quasi Peak	162 kHz	38.39 L1	-26.97
1 Quasi Peak	254 kHz	31.03 L1	-30.58
1 Quasi Peak	430 kHz	26.59 L1	-30.65
1 Quasi Peak	890 kHz	30.82 L1	-25.18

Remark:

1. Corr. (dB) = LISN Factor (dB) + Cable Loss (dB)
2. Level (dBµV) = Corr. (dB) + Read Level (dBµV)
3. Delta Limit (dB) = Level (dBµV)-Limit (dBµV)

TEST REPORT

Tested Wire: Neutral

Operation Mode: Continuously transmitting

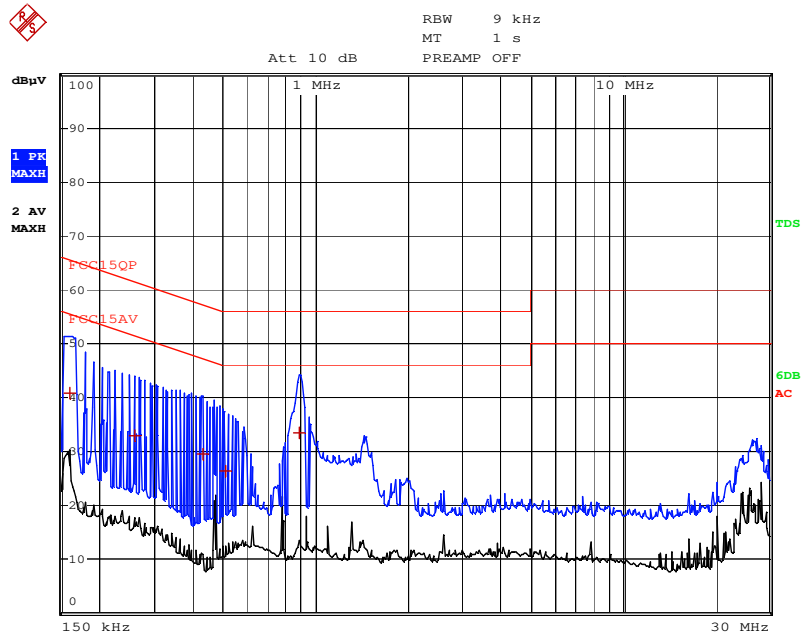

EDIT PEAK LIST (Final Measurement Results)				
TRACE		FREQUENCY	LEVEL dBµV	DELTA LIMIT dB
Trace1:	FCC15QP			
Trace2:	FCC15AV			
Trace3:	---			
1	Quasi Peak	162 kHz	40.85 L1	-24.50
1	Quasi Peak	258 kHz	32.83 L1	-28.66
1	Quasi Peak	430 kHz	29.55 L1	-27.70
1	Quasi Peak	510 kHz	26.36 L1	-29.63
1	Quasi Peak	890 kHz	33.53 L1	-22.46

Remark:

1. Corr. (dB) = LISN Factor (dB) + Cable Loss (dB)
2. Level (dBµV) = Corr. (dB) + Read Level (dBµV)
3. Delta Limit (dB) = Level (dBµV)-Limit (dBµV)

TEST REPORT

5.0 Test Equipment List

Radiated Emission/Radio

Equipment No.	Equipment	Model	Manufacturer	Cal. Due date (YYYY-MM-DD)	Calibration Interval
EM030-04	3m Semi-Anechoic Chamber	9×6×6 m ³	ETS-LINDGREN	2021/4/10	1Y
EM031-02	EMI Test Receiver (9 kHz~7 GHz)	R&S ESR7	R&S	2021/06/16	1Y
EM031-03	Signal and Spectrum Analyzer (10 Hz~40 GHz)	R&S FSV40	R&S	2021/7/6	1Y
EM011-04	Loop antenna (9 kHz-30 MHz)	HFH2-Z2	R&S	2021/6/18	1Y
EM061-03	TRILOG Super Broadband test Antenna (30 MHz-1.5 GHz) (TX)	VULB 9161	SCHWARZBECK	2021/6/18	1Y
EM033-01	TRILOG Super Broadband test Antenna(30 MHz-3 GHz) (RX)	VULB 9163	SCHWARZBECK	2021/6/18	1Y
EM033-02	Double-Ridged Waveguide Horn Antenna (800 MHz-18 GHz)(RX)	R&S HF907	R&S	2021/6/18	1Y
EM033-03	High Frequency Antenna & preamplifier(18 GHz~26.5 GHz) (RX)	R&S SCU-26	R&S	2021/4/24	1Y
EM033-04	High Frequency Antenna & preamplifier (26 GHz-40 GHz)	R&S SCU-40	R&S	2021/4/24	1Y
EM031-02-01	Coaxial cable(9 kHz-1 GHz)	N/A	R&S	2021/4/12	1Y
EM033-02-02	Coaxial cable(1 GHz-18 GHz)	N/A	R&S	2021/4/12	1Y
EM033-04-02	Coaxial cable(18 GHz~40 GHz)	N/A	R&S	2021/4/24	1Y
EM031-01	Signal Generator (9 kHz~6 GHz)	SMB100A	R&S	2021/7/02	1Y
EM040-01	Band Reject/Notch Filter	WRHFV	Wainwright	N/A	1Y
EM040-02	Band Reject/Notch Filter	WRCGV	Wainwright	N/A	1Y
EM040-03	Band Reject/Notch Filter	WRCGV	Wainwright	N/A	1Y
EM022-03	2.45 GHz Filter	BRM50702	Micro-Tronics	2021/5/10	1Y
SA016-16	Programmable Temperature & Humidity Test Chamber	MHU-800LJ	TERCHY	2021/06/16	1Y
SA016-22	Climatic Test Chamber	C7-1500	Vötsch	2021/06/16	1Y
SA012-74	Digital Multimeter	FLUKE175	FLUKE	2021/06/16	1Y
EM010-01	Regulated DC Power supply	PAB-3003A	GUANHUA	N/A	1Y
SA040-22	Regulated DC Power supply	IT6721	ITECH	2021/7/6	1Y
EM084-06	Audio Analyzer	8903B	HP	2021/4/15	1Y
EM045-01-01	EMC32 software (RE/RS)	V10.01.00	R&S	N/A	N/A
EM045-01-09	EMC32 software (328/893)	V9.26.01	R&S	N/A	N/A
EM046-06	Power Sensor	NRP6A	R&S	2021/3/12	1Y

Conducted emission at the mains terminals

Equipment No.	Equipment	Model	Manufacturer	Cal. Due date (YYYY-MM-DD)	Calibration Interval
EM080-05	EMI receiver	ESCI	R&S	2021/7/09	1Y
EM006-05	LISN	ENV216	R&S	2021/6/7	1Y
EM006-06	LISN	ENV216	R&S	2021/7/6	1Y
EM006-06-01	Coaxial cable	/	R&S	2021/4/12	1Y
EM004-04	EMC shield Room	8m×3m×3m	Zhongyu	2021/2/5	1Y

*****End of the test report*****