

RF

TEST REPORT

ISSUED BY
Shenzhen BALUN Technology Co., Ltd.



FOR
notebook

ISSUED TO
E&S International Enterprises, Inc.

7801 Hayvenhurst Avenue, Van Nuys, California 91406 USA



Tested by:

Ye Hongji

Date

Sep. 06, 2021

Approved by:

Liao Jianming

(Technical Director)

Date

Sep. 06, 2021

Report No.: BL-SZ2170442-602

EUT Name: notebook

Model Name: GWTC116-2 (refer section 2.4)

Brand Name: Gateway

Test Standard: 47 CFR Part 15 Subpart C
(refer section 3.1)

FCC ID: 2AYPE-GWTC116-2Y

Test Conclusion: Pass

Test Date: Jul. 16, 2021 ~ Jul. 21, 2021

Date of Issue: Sep. 06, 2021

NOTE: This test report of test results only related to testing samples, which can be duplicated completely for the legal use with the approval of the applicant; it shall not be reproduced except in full, without the written approval of Shenzhen BALUN Technology Co., Ltd. Any objections should be raised within thirty days from the date of issue. To validate the report, please contact us.

Revision History

<u>Version</u>	<u>Issue Date</u>	<u>Revisions Content</u>
<u>Rev. 01</u>	<u>Sep. 06, 2021</u>	<u>Initial Issue</u>

TABLE OF CONTENTS

1	ADMINISTRATIVE DATA (GENERAL INFORMATION)	5
1.1	Identification of the Testing Laboratory	5
1.2	Identification of the Responsible Testing Location	5
1.3	Laboratory Condition	5
1.4	Announce	5
2	PRODUCT INFORMATION	6
2.1	Applicant Information	6
2.2	Manufacturer Information	6
2.3	Factory Information	6
2.4	General Description for Equipment under Test (EUT)	6
2.5	Technical Information	7
2.6	Additional Instructions	8
3	SUMMARY OF TEST RESULTS	9
3.1	Test Standards	9
3.2	Verdict	9
4	GENERAL TEST CONFIGURATIONS	10
4.1	Test Environments	10
4.2	Test Equipment List	10
4.3	Measurement Uncertainty	10
4.4	Description of Test Setup	11
4.4.1	For Antenna Port Test	11
4.4.2	For AC Power Supply Port Test	11
4.4.3	For Radiated Test (Below 30 MHz)	12
4.4.4	For Radiated Test (30 MHz-1 GHz)	12
4.4.5	For Radiated Test (Above 1 GHz)	13
4.5	Measurement Results Explanation Example	14
4.5.1	For conducted test items:	14

4.5.2	For radiated band edges and spurious emission test:.....	14
5	TEST ITEMS.....	15
5.1	Antenna Requirements.....	15
5.1.1	Relevant Standards.....	15
5.1.2	Antenna Anti-Replacement Construction	15
5.1.3	Antenna Gain	15
5.2	Output Power	16
5.2.1	Test Limit.....	16
5.2.2	Test Setup.....	16
5.2.3	Test Procedure.....	16
5.2.4	Test Result	17
5.3	Occupied Bandwidth	18
5.3.1	Limit.....	18
5.3.2	Test Setup.....	18
5.3.3	Test Procedure.....	18
5.3.4	Test Result	18
5.4	Conducted Spurious Emission	19
5.4.1	Limit.....	19
5.4.2	Test Setup.....	19
5.4.3	Test Procedure.....	19
5.4.4	Test Result	20
5.5	Band Edge (Authorized-band band-edge).....	21
5.5.1	Limit.....	21
5.5.2	Test Setup.....	21
5.5.3	Test Procedure.....	21
5.5.4	Test Result	21
5.6	Conducted Emission	22
5.6.1	Limit.....	22
5.6.2	Test Setup.....	22
5.6.3	Test Procedure.....	22
5.6.4	Test Result	22
5.7	Radiated Spurious Emission	23
5.7.1	Limit.....	23

5.7.2	Test Setup	23
5.7.3	Test Procedure	23
5.7.4	Test Result	26
5.8	Band Edge (Restricted-band band-edge).....	27
5.8.1	Limit.....	27
5.8.2	Test Setup	27
5.8.3	Test Procedure	27
1.1.1	Test Result	27
5.9	Power Spectral density (PSD).....	28
5.9.1	Limit.....	28
5.9.2	Test Setup	28
5.9.3	Test Procedure	28
5.9.4	Test Result	28
ANNEX A	TEST RESULT	29
A.1	Output Power, E.I.R.P, Duty Cycle.....	29
A.2	Occupied Bandwidth	31
A.3	Conducted Spurious Emissions	33
A.4	Band Edge (Authorized-band band-edge).....	36
A.5	Conducted Emissions.....	38
A.6	Radiated Spurious Emission	40
A.7	Band Edge (Restricted-band band-edge).....	48
A.8	Power Spectral Density (PSD)	50
ANNEX B	TEST SETUP PHOTOS	51
ANNEX C	EUT EXTERNAL PHOTOS	51
ANNEX D	EUT INTERNAL PHOTOS	51

1 ADMINISTRATIVE DATA (GENERAL INFORMATION)

1.1 Identification of the Testing Laboratory

Company Name	Shenzhen BALUN Technology Co., Ltd.
Address	Block B, 1st FL, Baisha Science and Technology Park, Shahe Xi Road, Nanshan District, Shenzhen, Guangdong Province, P. R. China
Phone Number	+86 755 6685 0100

1.2 Identification of the Responsible Testing Location

Test Location	Shenzhen BALUN Technology Co., Ltd.
Address	Block B, 1st FL, Baisha Science and Technology Park, Shahe Xi Road, Nanshan District, Shenzhen, Guangdong Province, P. R. China
Accreditation Certificate	The laboratory is a testing organization accredited by FCC as a accredited testing laboratory. The designation number is CN1196.
Description	All measurement facilities used to collect the measurement data are located at Block B, FL 1, Baisha Science and Technology Park, Shahe Xi Road, Nanshan District, Shenzhen, Guangdong Province, P. R. China 518055

1.3 Laboratory Condition

Ambient Temperature	20°C to 25°C
Ambient Relative Humidity	45% to 55%
Ambient Pressure	100 kPa to 102 kPa

1.4 Announce

- (1) The test report reference to the report template version v6.9.
- (2) The test report is invalid if not marked with the signatures of the persons responsible for preparing and approving the test report.
- (3) The test report is invalid if there is any evidence and/or falsification.
- (4) The results documented in this report apply only to the tested sample, under the conditions and modes of operation as described herein.
- (5) This document may not be altered or revised in any way unless done so by BALUN and all revisions are duly noted in the revisions section.
- (6) Content of the test report, in part or in full, cannot be used for publicity and/or promotional purposes without prior written approval from the laboratory.
- (7) The laboratory is only responsible for the data released by the laboratory, except for the part provided by the applicant.

2 PRODUCT INFORMATION

2.1 Applicant Information

Applicant	E&S International Enterprises, Inc.
Address	7801 Hayvenhurst Avenue, Van Nuys, California 91406 USA

2.2 Manufacturer Information

Manufacturer	Shenzhen Yuko Technology Co., Ltd
Address	6th, A9 Bldg, Tianrui Industrial Park, Fuyuan 1st Rd, Fuyong, Baoan, Shenzhen

2.3 Factory Information

Factory	Shenzhen Yuko Technology Co., Ltd
Address	6th, A9 Bldg, Tianrui Industrial Park, Fuyuan 1st Rd, Fuyong, Baoan, Shenzhen

2.4 General Description for Equipment under Test (EUT)

EUT Name	notebook
Model Name Under Test	GWTC116-2
Series Model Name	G117, A117, G1162, G1163, G118, GWTC116-2BK, GWTC116-2BL, GWTC116-2RD, GWTC116-2GR
Description of Model Name Differentiation	Different in case only different model names.
Hardware Version	Y116GR920-GF55J
Software Version	20H2
Dimensions (Approx.)	N/A
Weight (Approx.)	N/A

2.5 Technical Information

Network and Wireless connectivity	Bluetooth (BR+EDR+BLE) WIFI 802.11b, 802.11g, 802.11n
-----------------------------------	--

The requirement for the following technical information of the EUT was tested in this report:

Modulation Technology	DTS
Modulation Type	GFSK
Product Type	<input type="checkbox"/> Mobile <input checked="" type="checkbox"/> Portable <input type="checkbox"/> Fix Location
Transfer Rate	1 Mbps
Frequency Range	The frequency range used is 2400 MHz to 2483.5 MHz.
Number of Channel	40 (at intervals of 2 MHz)
Tested Channel	0 (2402 MHz), 19 (2440 MHz), 39 (2480 MHz)
Antenna Type	PIFA Antenna
Antenna Gain	1.52 dBi (In test items related to antenna gain, the final results reflect this figure. This value is provided by the applicant.)
Antenna Impedance	50Ω
Antenna System (MIMO Smart Antenna)	N/A

2.6 Additional Instructions

EUT Software Settings:

Mode	<input checked="" type="checkbox"/> Special software is used. The software provided by client to enable the EUT under transmission condition continuously at specific channel frequencies individually.
------	--

During testing. Channel and Power Controlling Software provided by the customer was used to control the operating channel as well as the output power level. The RF output power selection is for the setting of RF output power expected by the customer and is going to be fixed on the firmware of the final end product.

Power level setup in software			
Test Software Version	Bluetooth MP Tool		
Mode	Channel	Frequency (MHz)	Soft Set
GFSK	CH0	2402	Power parameter Settings is 31
	CH19	2440	
	CH39	2480	

Run Software

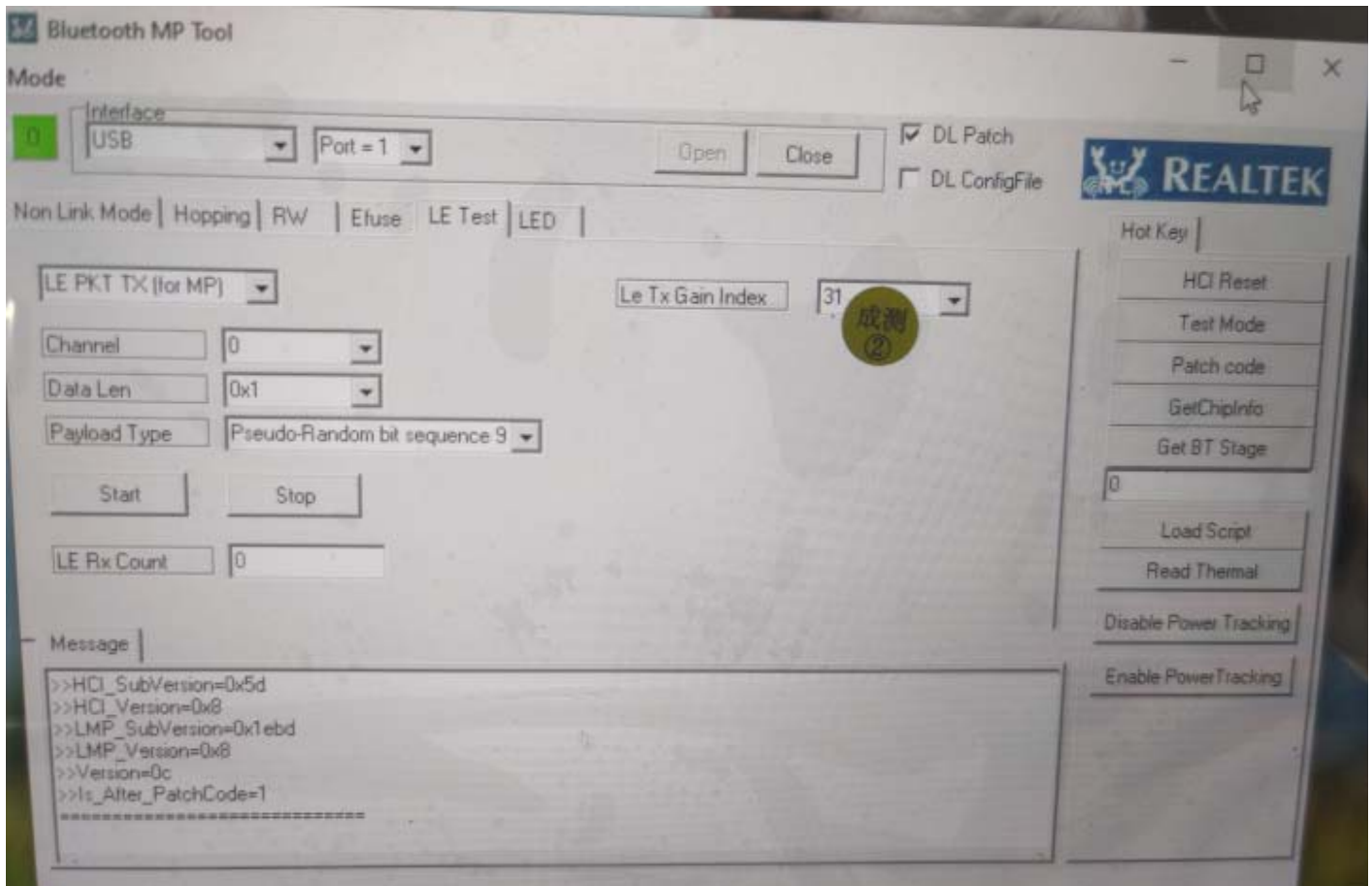

3 SUMMARY OF TEST RESULTS

3.1 Test Standards

No.	Identity	Document Title
1	47 CFR Part 15, Subpart C	Miscellaneous Wireless Communications Services
2	KDB 558074 D01 15.247 Meas Guidance v05r02	Guidance for compliance measurements on digital transmission system, frequency hopping spread spectrum system, and hybrid system devices operating under section 15.247 of the FCC rules
3	ANSI C63.10-2013	American National Standard for Testing Unlicensed Wireless Devices

3.2 Verdict

No.	Description	FCC Part No.	Channel	Test Result	Verdict
1	Antenna Requirement	15.203	N/A	--	Pass ^{Note1}
2	Output Power	15.247(b)	Low/Middle/High	ANNEX A.1	Pass
3	Occupied Bandwidth	15.247(a)	Low/Middle/High	ANNEX A.2	Pass
4	Conducted Spurious Emission	15.247(d)	Low/Middle/High	ANNEX A.3	Pass
5	Band Edge(Authorized-band band-edge)	15.247(d)	Low/ High	ANNEX A.4	Pass
6	Conducted Emission	15.207	Low/Middle/High	ANNEX A.5	Pass
7	Radiated Spurious Emission	15.209 15.247(d)	Low/Middle/High	ANNEX A.6	Pass
8	Band Edge(Restricted-band band-edge)	15.209 15.247(d)	Low/Middle/High	ANNEX A.7	Pass
9	Power spectral density (PSD)	15.247(e)	Low/Middle/High	ANNEX A.8	Pass
10	Receiver Spurious Emissions	--	--	N/A	N/A ^{Note2}

Note ¹: The EUT has a permanently and irreplaceable attached antenna, which complies with the requirement FCC 15.203.

Note ²: Only radio communication receivers operating in stand-alone mode within the band 30-960 MHz, as well as scanner receivers, are subject to Industry Canada requirements, so this test is not applicable.

4 GENERAL TEST CONFIGURATIONS

4.1 Test Environments

During the measurement, the normal environmental conditions were within the listed ranges:

Relative Humidity	45% to 55%	
Atmospheric Pressure	100 kPa to 102 kPa	
Temperature	NT (Normal Temperature)	+22°C to +25°C
Working Voltage of the EUT	NV (Normal Voltage)	7.6 V

4.2 Test Equipment List

Description	Manufacturer	Model	Serial No.	Cal. Date	Cal. Due
Spectrum Analyzer	ROHDE&SCHWARZ	FSV-40	101544	2021.04.01	2022.03.31
Bluetooth Signaling Unit	ROHDE&SCHWARZ	CMW500	142028	2021.06.01	2022.05.31
EMI Receiver	KEYSIGHT	N9038A	MY53220118	2021.06.01	2022.05.31
EMI Receiver	ROHDE&SCHWARZ	ESRP	101036	2021.06.01	2022.05.31
LISN	SCHWARZBECK	NSLK 8127	8127-687	2021.06.01	2022.05.31
Test Antenna-Loop(9 kHz-30 MHz)	SCHWARZBECK	FMZB 1519	1519-037	2019.10.29	2021.10.28
Test Antenna-Bi-Log(30 MHz-3 GHz)	SCHWARZBECK	VULB 9163	9163-624	2019.07.02	2022.07.01
Test Antenna-Horn(1-18 GHz)	SCHWARZBECK	BBHA 9120D	9120D-1917	2019.07.02	2022.07.01
Test Antenna-Horn (18-40 GHz)	A-INFO	LB-180400KF	J211060273	2021.01.05	2023.01.04
Anechoic Chamber	RAINFORD	9m*6m*6m	N/A	2017.02.21	2022.02.20
Anechoic Chamber	EMC Electronic Co., Ltd	20.10*11.60*7.35m	N/A	2018.08.08	2021.08.07
Shielded Enclosure	ChangNing	CN-130701	130703	--	--

4.3 Measurement Uncertainty

The following measurement uncertainty levels have been estimated for tests performed on the EUT as specified in CISPR 16-4-2.

This uncertainty represents an expanded uncertainty expressed at approximately the 95% confidence level using a coverage factor of k=2.

Measurement	Value
Occupied Channel Bandwidth	±2.8%
RF output power, conducted	±1.28 dB
Power Spectral Density, conducted	±1.30 dB
Unwanted Emissions, conducted	±1.84 dB
All emissions, radiated	±5.36 dB
Temperature	±0.82°C
Humidity	±4.1%

4.4 Description of Test Setup

4.4.1 For Antenna Port Test

Conducted value (dBm) = Measurement value (dBm) + cable loss (dB)

For example: the measurement value is 10 dBm and the cable loss is 0.5dB, then the conducted value (dBm) = 10 dBm + 0.5 dB = 10.5 dBm

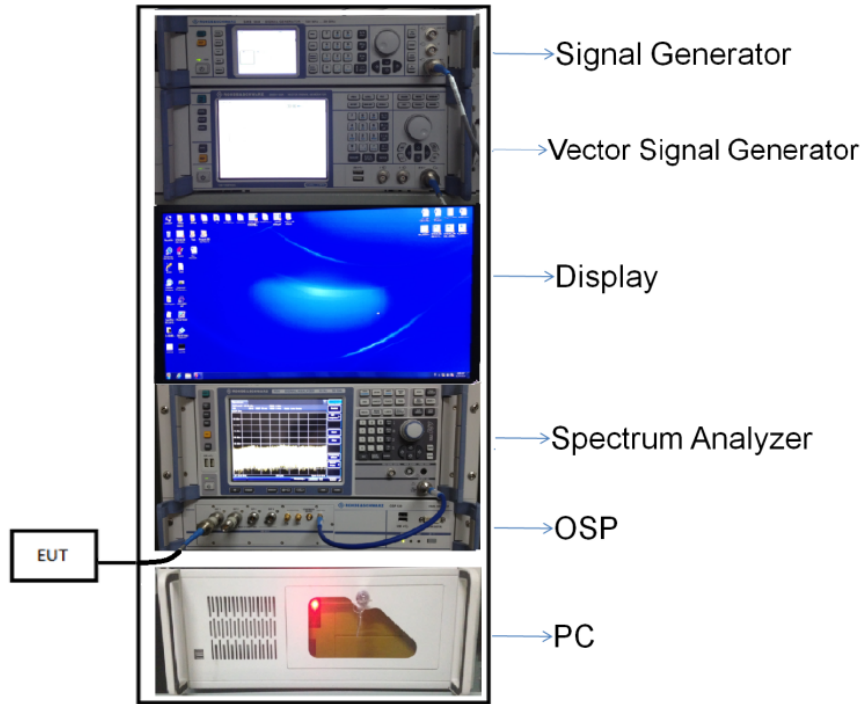

(Diagram 1)

4.4.2 For AC Power Supply Port Test

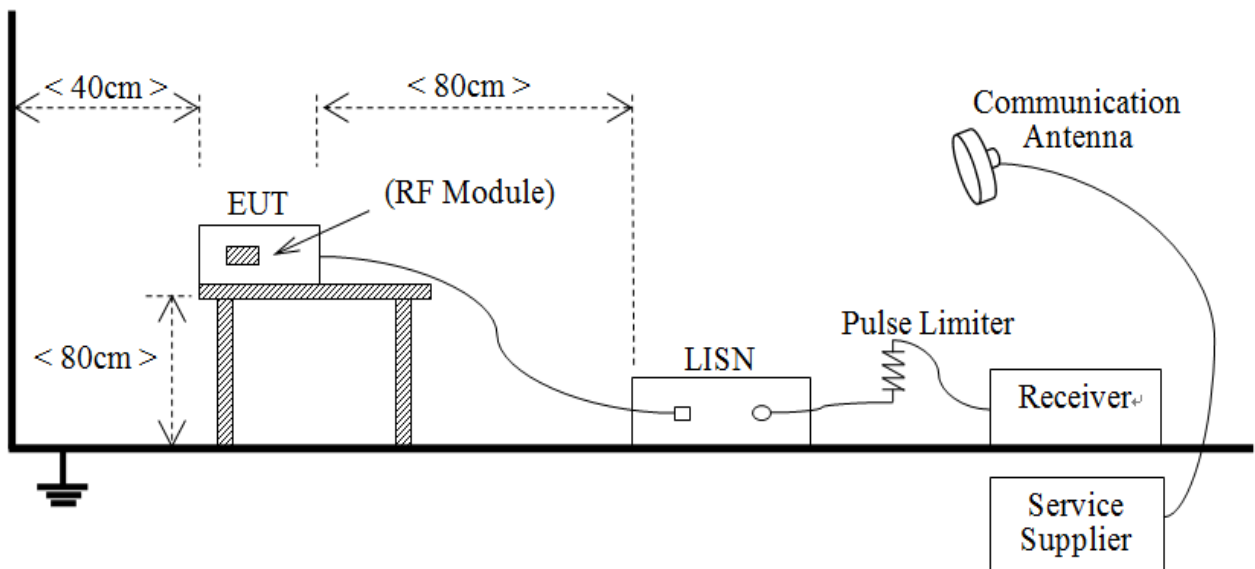

(Diagram 2)

4.4.3 For Radiated Test (Below 30 MHz)

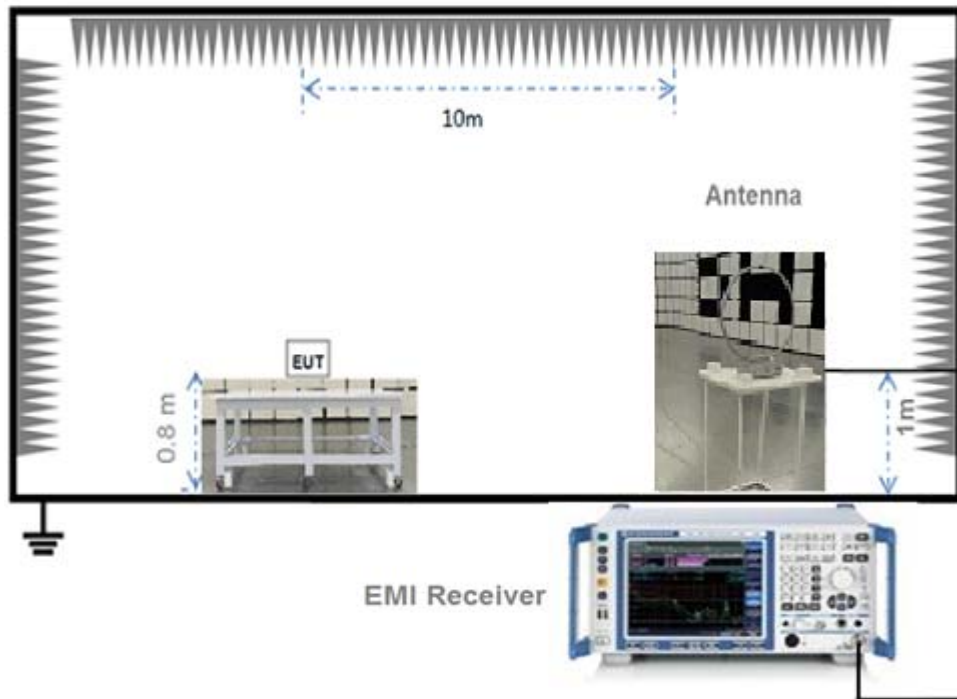

(Diagram 3)

4.4.4 For Radiated Test (30 MHz-1 GHz)

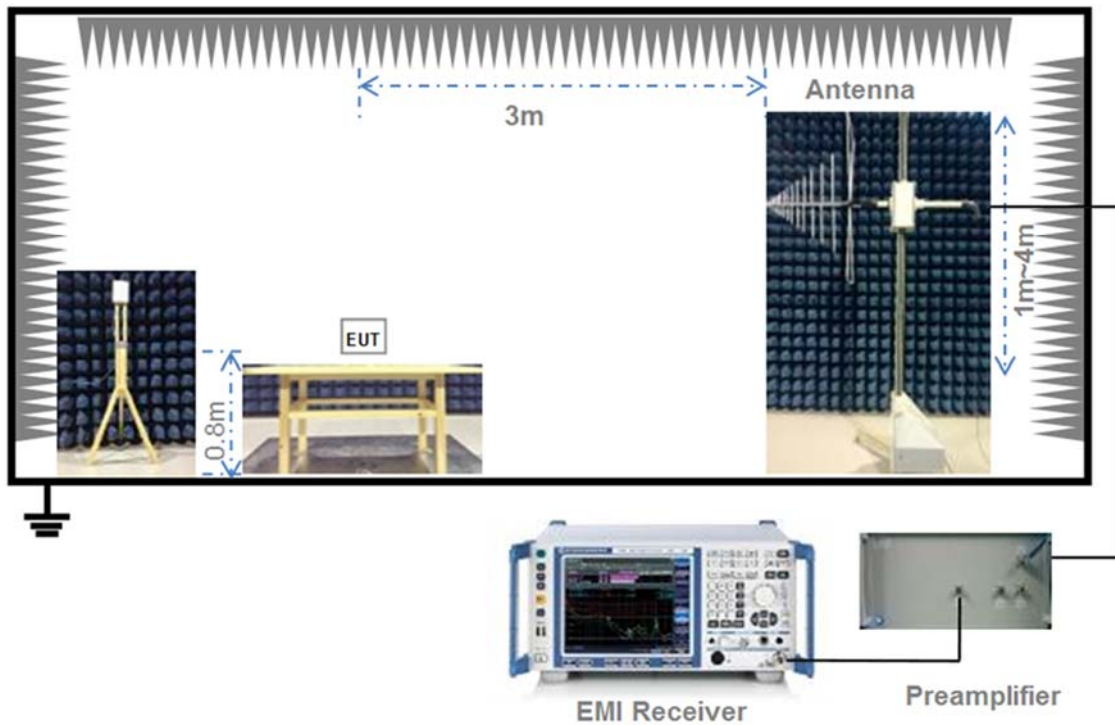

(Diagram 4)

4.4.5 For Radiated Test (Above 1 GHz)

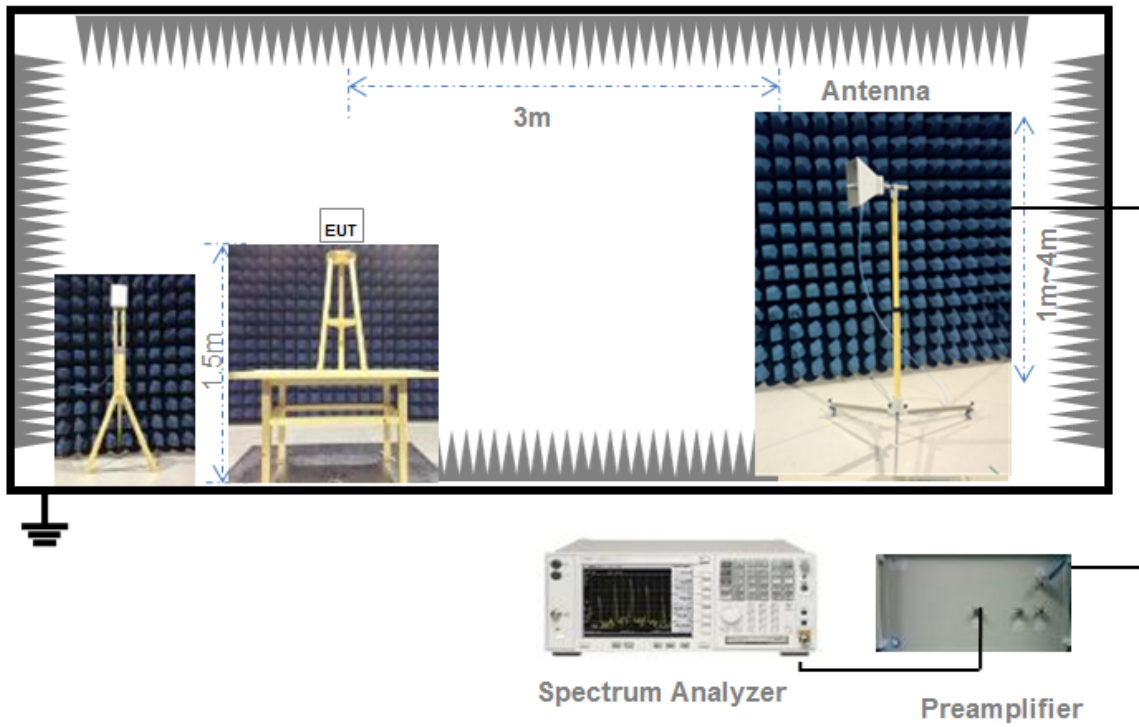

(Diagram 5)

4.5 Measurement Results Explanation Example

4.5.1 For conducted test items:

The offset level is set in the spectrum analyzer to compensate the RF cable loss and attenuator between EUT conducted output port and spectrum analyzer. With the offset compensation, the spectrum analyzer reading level is exactly the EUT RF output level.

The spectrum analyzer offset is derived from RF cable loss and attenuator factor.

Offset = RF cable loss + attenuator factor.

4.5.2 For radiated band edges and spurious emission test:

$$E = \text{EIRP} - 20\log D + 104.8$$

where:

E = electric field strength in dB μ V/m,

EIRP = equivalent isotropic radiated power in dBm

D = specified measurement distance in meters.

5 TEST ITEMS

5.1 Antenna Requirements

5.1.1 Relevant Standards

FCC §15.203 & 15.247(b); RSS-247, 5.4 (f)

An intentional radiator shall be designed to ensure that no antenna other than that furnished by the responsible party shall be used with the device. The use of a permanently attached antenna or of an antenna that uses a unique coupling to the intentional radiator shall be considered sufficient to comply with the provisions of this section. The manufacturer may design the unit so that a broken antenna can be replaced by the user, but the use of a standard antenna jack or electrical connector is prohibited. This requirement does not apply to carrier current devices or to devices operated under the provisions of § 15.211, § 15.213, § 15.217, § 15.219, or § 15.221. Further, this requirement does not apply to intentional radiators that must be professionally installed, such as perimeter protection systems and some field disturbance sensors, or to other intentional radiators which, in accordance with § 15.31(d), must be measured at the installation site. However, the installer shall be responsible for ensuring that the proper antenna is employed so that the limits in this part are not exceeded.

If directional gain of transmitting antennas is greater than 6 dBi, the power shall be reduced by the same level in dB comparing to gain minus 6 dBi. For the fixed point-to-point operation, the power shall be reduced by one dB for every 3 dB that the directional gain of the antenna exceeds 6 dBi. The use of a permanently attached antenna or of an antenna that uses a unique coupling to the intentional radiator shall be considered sufficient to comply with the FCC rule.

5.1.2 Antenna Anti-Replacement Construction

The Antenna Anti-Replacement as following method:

Protected Method	Description
The antenna is embedded in the product.	An embedded-in antenna design is used.

Reference Documents	Item
Photo	Please refer to the EUT Photo documents.

5.1.3 Antenna Gain

The antenna peak gain of EUT is less than 6 dBi. Therefore, it is not necessary to reduce maximum peak output power limit.

5.2 Output Power

5.2.1 Test Limit

FCC § 15.247(b)

For systems using digital modulation in the 902-928 MHz, 2400-2483.5 MHz, and 5725-5850 MHz bands: 1 Watt. As an alternative to a peak power measurement, compliance with the one Watt limit can be based on a measurement of the maximum conducted output power. Maximum Conducted Output Power is defined as the total transmit power delivered to all antennas and antenna elements averaged across all symbols in the signaling alphabet when the transmitter is operating at its maximum power control level. Power must be summed across all antennas and antenna elements.

RSS-247, 5.4 (d)

For DTSs employing digital modulation techniques operating in the bands 902-928 MHz and 2400-2483.5 MHz, the maximum peak conducted output power shall not exceed 1W. Except as provided in Section 5.4(5), the e.i.r.p. shall not exceed 4 W.

5.2.2 Test Setup

See section 4.4.1 for test setup description for the antenna port. The photo of test setup please refer to ANNEX B.

5.2.3 Test Procedure

a) Maximum peak conducted output power

This procedure shall be used when the measurement instrument has available a resolution bandwidth that is greater than the DTS bandwidth.

Set the RBW \geq DTS bandwidth.

Set VBW $\geq 3 \times$ RBW.

Set span $\geq 3 \times$ RBW

Sweep time = auto couple.

Detector = peak.

Trace mode = max hold.

Allow trace to fully stabilize.

Use peak marker function to determine the peak amplitude level.

b) Measurements of duty cycle

The zero-span mode on a spectrum analyzer or EMI receiver if the response time and spacing between bins on the sweep are sufficient to permit accurate measurements of the on and off times of the transmitted signal.

Set the center frequency of the instrument to the center frequency of the transmission.

Set RBW \geq OBW if possible; otherwise, set RBW to the largest available value.

Set VBW \geq RBW. Set detector = peak or average.

The zero-span measurement method shall not be used unless both RBW and VBW are $> 50/T$ and the number of sweep points across duration T exceeds 100. (For example, if VBW and/or RBW are limited to 3 MHz, then the zero-span method of measuring duty cycle shall not be used if $T \leq 16.7$ microseconds.)

5.2.4 Test Result

Please refer to ANNEX A.1.

5.3 Occupied Bandwidth

5.3.1 Limit

FCC §15.247(a); RSS-247, 5.2 (a); RSS-GEN, 6.7

Make the measurement with the spectrum analyzer's resolution bandwidth (RBW) = 100 kHz. In order to make an accurate measurement, set the span greater than RBW. The 6 dB bandwidth must be greater than 500 kHz.

5.3.2 Test Setup

See section 4.4.1 for test setup description for the antenna port. The photo of test setup please refer to ANNEX B.

5.3.3 Test Procedure

Use the following spectrum analyzer settings:

Set RBW = 100 kHz.

Set the video bandwidth (VBW) ≥ 3 RBW.

Detector = Peak.

Trace mode = max hold.

Sweep = auto couple.

Allow the trace to stabilize.

Measure the maximum width of the emission that is constrained by the frequencies associated with the two outermost amplitude points (upper and lower frequencies) that are attenuated by 6 dB relative to the maximum level measured in the fundamental emission.

5.3.4 Test Result

Please refer to ANNEX A.2.

5.4 Conducted Spurious Emission

5.4.1 Limit

FCC §15.247(d); RSS-247, 5.5

In any 100 kHz bandwidth outside the frequency band in which the spread spectrum or digitally modulated intentional radiator is operating, the radio frequency power that is produced by the intentional radiator shall be at least 20 dB below that in the 100 kHz bandwidth within the band that contains the highest level of the desired power, based on either an RF conducted or a radiated measurement.

5.4.2 Test Setup

See section 4.4.1 for test setup description for the antenna port. The photo of test setup please refer to ANNEX B.

5.4.3 Test Procedure

The DTS rules specify that in any 100 kHz bandwidth outside of the authorized frequency band, the power shall be attenuated according to the following conditions:

- a) If the maximum peak conducted output power procedure was used to demonstrate compliance as described in 9.1, then the peak output power measured in any 100 kHz bandwidth outside of the authorized frequency band shall be attenuated by at least 20 dB relative to the maximum in-band peak PSD level in 100 kHz (i.e., 20 dBc).
- b) If maximum conducted (average) output power was used to demonstrate compliance as described in 9.2, then the peak power in any 100 kHz bandwidth outside of the authorized frequency band shall be attenuated by at least 30 dB relative to the maximum in-band peak PSD level in 100 kHz (i.e., 30 dBc).
- c) In either case, attenuation to levels below the 15.209 general radiated emissions limits is not required.

The following procedures shall be used to demonstrate compliance to these limits. Note that these procedures can be used in either an antenna-port conducted or radiated test set-up. Radiated tests must conform to the test site requirements and utilize maximization procedures defined herein.

Reference level measurement:

Establish a reference level by using the following procedure:

Set instrument center frequency to DTS channel center frequency.

Set the span to ≥ 1.5 times the DTS bandwidth.

Set the RBW = 100 kHz.

Set the VBW $\geq 3 \times$ RBW.

Detector = peak.

Sweep time = auto couple.

Trace mode = max hold.

Allow trace to fully stabilize.

Use the peak marker function to determine the maximum PSD level.

Emission level measurement:

Use the following spectrum analyzer settings:

Span = wide enough to capture the peak level of the in-band emission and all spurious emissions (e.g., harmonics) from the lowest frequency generated in the EUT up through the 10th harmonic. Typically, several plots are required to cover this entire span.

Set the RBW = 100 kHz.

Set the VBW $\geq 3 \times$ RBW.

Detector = peak.

Sweep time = auto couple.

Trace mode = max hold.

Allow trace to fully stabilize.

Use the peak marker function to determine the maximum amplitude level.

Ensure that the amplitude of all unwanted emissions outside of the authorized frequency band (excluding restricted frequency bands) are attenuated by at least the minimum requirements specified in 11.1 a) or 11.1 b). Report the three highest emissions relative to the limit.

5.4.4 Test Result

Please refer to ANNEX A.3.

5.5 Band Edge (Authorized-band band-edge)

5.5.1 Limit

FCC §15.247(d); RSS-247, 5.5

In any 100 kHz bandwidth outside the frequency band in which the spread spectrum or digitally modulated intentional radiator is operating, the radio frequency power that is produced by the intentional radiator shall be at least 20 dB below that in the 100 kHz bandwidth within the band that contains the highest level of the desired power, based on either an RF conducted or a radiated measurement.

5.5.2 Test Setup

See section 4.4.1 for test setup description for the antenna port. The photo of test setup please refer to ANNEX B.

5.5.3 Test Procedure

The following procedures may be used to determine the peak or average field strength or power of an unwanted emission that is within 2 MHz of the authorized band edge. If a peak detector is utilized, use the procedure described in 13.2.1. Use the procedure described in 13.2.2 when using an average detector and the EUT can be configured to transmit continuously (i.e., duty cycle $\geq 98\%$). Use the procedure described in 13.2.3 when using an average detector and the EUT cannot be configured to transmit continuously but the duty cycle is constant (i.e., duty cycle variations are less than ± 2 percent). Use the procedure described in 13.2.4 when using an average detector for those cases where the EUT cannot be configured to transmit continuously and the duty cycle is not constant (duty cycle variations equal or exceed 2 percent).

When using a peak detector to measure unwanted emissions at or near the band edge (within 2 MHz of the authorized band), the following integration procedure can be used.

Set instrument center frequency to the frequency of the emission to be measured (must be within 2 MHz of the authorized band edge).

Set span to 2 MHz

RBW = 100 kHz.

VBW $\geq 3 \times$ RBW.

Detector = peak.

Sweep time = auto.

Trace mode = max hold.

Allow sweep to continue until the trace stabilizes (required measurement time may increase for low duty cycle applications)

Compute the power by integrating the spectrum over 1 MHz using the analyzer's band power measurement function with band limits set equal to the emission frequency (femission) ± 0.5 MHz. If the instrument does not have a band power function, then sum the amplitude levels (in power units) at 100 kHz intervals extending across the 1 MHz spectrum defined by femission ± 0.5 MHz.

5.5.4 Test Result

Please refer to ANNEX A.4.

5.6 Conducted Emission

5.6.1 Limit

FCC §15.207; RSS-GEN, 8.8

For an intentional radiator that is designed to be connected to the public utility (AC) power line, the radio frequency voltage that is conducted back onto the AC power line on any frequency within the band 150 kHz to 30 MHz shall not exceed the limits in the following table, as measured using a 50 μ H/50 Ω line impedance stabilization network (LISN).

Frequency range (MHz)	Conducted Limit (dB μ V)	
	Quai-peak	Average
0.15 - 0.50	66 to 56	56 to 46
0.50 - 5	56	46
0.50 - 30	60	50

5.6.2 Test Setup

See section 4.4.2 for test setup description for the AC power supply port. The photo of test setup please refer to ANNEX B.

5.6.3 Test Procedure

The maximum conducted interference is searched using Peak (PK), if the emission levels more than the AV and QP limits, and that have narrow margins from the AV and QP limits will be re-measured with AV and QP detectors. Tests for both L phase and N phase lines of the power mains connected to the EUT are performed. Refer to recorded points and plots below.

Devices subject to Part 15 must be tested for all available U.S. voltages and frequencies (such as a nominal 120 VAC, 50/60 Hz and 240 VAC, 50/60 Hz) for which the device is capable of operation. A device rated for 50/60 Hz operation need not be tested at both frequencies provided the radiated and line conducted emissions are the same at both frequencies.

5.6.4 Test Result

Please refer to ANNEX A.5.

5.7 Radiated Spurious Emission

5.7.1 Limit

FCC §15.209&15.247(d); RSS-GEN, 8.9; RSS-247, 5.5

Radiated emission outside the frequency band attenuation below the general limits specified in FCC section 15.209(a) is not required. In addition, radiated emissions which fall in the restricted bands, as defined in FCC section 15.205(a), must also comply with the radiated emission limits specified in FCC section 15.209(a).

According to FCC section 15.209 (a), except as provided elsewhere in this subpart, the emissions from an intentional radiator shall not exceed the field strength levels specified in the following table:

Frequency (MHz)	Field Strength ($\mu\text{V}/\text{m}$)	Measurement Distance (m)
0.009 - 0.490	2400/F(kHz)	300
0.490 - 1.705	24000/F(kHz)	30
1.705 - 30.0	30	30
30 - 88	100	3
88 - 216	150	3
216 - 960	200	3
Above 960	500	3

Note:

1. Field Strength (dB $\mu\text{V}/\text{m}$) = 20*log[Field Strength ($\mu\text{V}/\text{m}$)].
2. In the emission tables above, the tighter limit applies at the band edges.
3. For Above 1000 MHz, the emission limit in this paragraph is based on measurement instrumentation employing an average detector, measurement using instrumentation with a peak detector function, corresponding to 20dB above the maximum permitted average limit.
4. For above 1000 MHz, limit field strength of harmonics: 54dBuV/m@3m (AV) and 74dBuV/m@3m (PK).

5.7.2 Test Setup

See section 4.4.3 to 4.4.5 for test setup description for the antenna port. The photo of test setup please refer to ANNEX B.

5.7.3 Test Procedure

Since the emission limits are specified in terms of radiated field strength levels, measurements performed to demonstrate compliance have traditionally relied on a radiated test configuration. Radiated measurements remain the principal method for demonstrating compliance to the specified limits; however antenna-port conducted measurements are also now acceptable to demonstrate compliance (see below for details). When radiated measurements are utilized, test site requirements and procedures for maximizing and measuring radiated emissions that are described in ANSI C63.10 shall be followed.

Antenna-port conducted measurements may also be used as an alternative to radiated measurements for demonstrating compliance in the restricted frequency bands. If conducted measurements are performed, then proper impedance matching must be ensured and an additional radiated test for cabinet/case spurious emissions is required.

General Procedure for conducted measurements in restricted bands:

- a) Measure the conducted output power (in dBm) using the detector specified (see guidance regarding measurement procedures for determining quasi-peak, peak, and average conducted output power, respectively).
- b) Add the maximum transmit antenna gain (in dBi) to the measured output power level to determine the EIRP level (see guidance on determining the applicable antenna gain)
- c) Add the appropriate maximum ground reflection factor to the EIRP level (6 dB for frequencies ≤ 30 MHz, 4.7 dB for frequencies between 30 MHz and 1000 MHz, inclusive and 0 dB for frequencies > 1000 MHz).
- d) For devices with multiple antenna-ports, measure the power of each individual chain and sum the EIRP of all chains in linear terms (e.g., Watts, mW).
- e) Convert the resultant EIRP level to an equivalent electric field strength using the following relationship:

$$E = \text{EIRP} - 20\log D + 104.8$$

where:

E = electric field strength in dB μ V/m,

EIRP = equivalent isotropic radiated power in dBm

D = specified measurement distance in meters.

- f) Compare the resultant electric field strength level to the applicable limit.
- g) Perform radiated spurious emission test.

Quasi-Peak measurement procedure

The specifications for measurements using the CISPR quasi-peak detector can be found in Publication 16 of the International Special Committee on Radio Frequency Interference (CISPR) of the International Electrotechnical Commission.

As an alternative to CISPR quasi-peak measurement, compliance can be demonstrated to the applicable emission limits using a peak detector.

Peak power measurement procedure:

Peak emission levels are measured by setting the instrument as follows:

- a) RBW = as specified in Table 1.
- b) VBW $\geq 3 \times$ RBW.
- c) Detector = Peak.
- d) Sweep time = auto.
- e) Trace mode = max hold.
- f) Allow sweeps to continue until the trace stabilizes. (Note that the required measurement time may be longer for low duty cycle applications).

Table 1—RBW as a function of frequency

Frequency	RBW
9-150 kHz	200-300 Hz
0.15-30 MHz	9-10 kHz
30-1000 MHz	100-120 kHz
> 1000 MHz	1 MHz

If the peak-detected amplitude can be shown to comply with the average limit, then it is not necessary to perform a separate average measurement.

Trace averaging across on and off times of the EUT transmissions followed by duty cycle correction:

If continuous transmission of the EUT (i.e., duty cycle ≥ 98 percent) cannot be achieved and the duty cycle is constant (i.e., duty cycle variations are less than ± 2 percent), then the following procedure shall be used:

- a) The EUT shall be configured to operate at the maximum achievable duty cycle.
- b) Measure the duty cycle, x , of the transmitter output signal as described in section 6.0.
- c) RBW = 1 MHz (unless otherwise specified).
- d) VBW $\geq 3 \times$ RBW.
- e) Detector = RMS, if $\text{span}/(\# \text{ of points in sweep}) \leq (\text{RBW}/2)$. Satisfying this condition may require increasing the number of points in the sweep or reducing the span. If this condition cannot be satisfied, then the detector mode shall be set to peak.
- f) Averaging type = power (i.e., RMS).
 - 1) As an alternative, the detector and averaging type may be set for linear voltage averaging.
 - 2) Some instruments require linear display mode in order to use linear voltage averaging. Log or dB averaging shall not be used.
- g) Sweep time = auto.
- h) Perform a trace average of at least 100 traces.
- i) A correction factor shall be added to the measurement results prior to comparing to the emission limit in order to compute the emission level that would have been measured had the test been performed at 100 percent duty cycle. The correction factor is computed as follows:
 - 1) If power averaging (RMS) mode was used in step f), then the applicable correction factor is $10 \log(1/x)$, where x is the duty cycle.
 - 2) If linear voltage averaging mode was used in step f), then the applicable correction factor is $20 \log(1/x)$, where x is the duty cycle.
 - 3) If a specific emission is demonstrated to be continuous (≥ 98 percent duty cycle) rather than turning on and off with the transmit cycle, then no duty cycle correction is required for that emission.

NOTE: Reduction of the measured emission amplitude levels to account for operational duty factor is not permitted. Compliance is based on emission levels occurring during transmission - not on an average across on and off times of the transmitter.

Determining the applicable transmit antenna gain:

A conducted power measurement will determine the maximum output power associated with a restricted band emission; however, in order to determine the associated EIRP level, the gain of the transmitting antenna (in dBi) must be added to the measured output power (in dBm).

Since the out-of-band characteristics of the EUT transmit antenna will often be unknown, the use of a conservative antenna gain value is necessary. Thus, when determining the EIRP based on the measured conducted power, the upper bound on antenna gain for a device with a single RF output shall be selected as the maximum in-band gain of the antenna across all operating bands, or 2 dBi, whichever is greater. However, for devices that operate in multiple frequency bands while using the same transmit antenna, the highest gain of the antenna within the operating band nearest in frequency to the restricted band emission being measured may be used in lieu of the overall highest gain when the emission is at a frequency that is within 20 percent of the nearest band edge frequency, but in no case shall a value less than 2 dBi be used.

See KDB 662911 for guidance on calculating the additional array gain term when determining the effective antenna gain for a EUT with multiple outputs occupying the same or overlapping frequency ranges in the same band.

Radiated spurious emission test:

An additional consideration when performing conducted measurements of restricted band emissions is that unwanted emissions radiating from the EUT cabinet, control circuits, power leads, or intermediate circuit elements will likely go undetected in a conducted measurement configuration. To address this concern, a radiated test shall be performed to ensure that emissions emanating from the EUT cabinet (rather than the antenna port) also comply with the applicable limits.

For these cabinet radiated spurious emission measurements the EUT transmit antenna may be replaced with a termination matching the nominal impedance of the antenna. Procedures for performing radiated measurements are specified in ANSI C63.10. All detected emissions shall comply with the applicable limits.

The measurement frequency range is from 30MHz to the 10th harmonic of the fundamental frequency. The Turn Table is actuated to turn from 0° to 360°, and both horizontal and vertical polarizations of the Test Antenna are used to find the maximum radiated power. Mid channels on all channel bandwidth verified. Only the worst RB size/offset presented.

The power of the EUT transmitting frequency should be ignored.

All Spurious Emission tests were performed in X, Y, Z axis direction. And only the worst axis test condition was recorded in this test report.

Use the following spectrum analyzer settings:

Span = wide enough to fully capture the emission being measured

RBW = 1 MHz for $f \geq 1$ GHz, 100 kHz for $f < 1$ GHz

VBW \geq RBW

Sweep = auto

Detector function = peak

Trace = max hold

5.7.4 Test Result

Please refer to ANNEX A.6.

5.8 Band Edge (Restricted-band band-edge)

5.8.1 Limit

FCC §15.209&15.247(d); RSS-GEN, 8.10; RSS-247, 5.5

Radiated emission outside the frequency band attenuation below the general limits specified in FCC section 15.209(a) is not required. In addition, radiated emissions which fall in the restricted bands, as defined in FCC section 15.205(a), must also comply with the radiated emission limits specified in FCC section 15.209(a).

5.8.2 Test Setup

See section 4.4.3 to 4.4.5 for test setup description for the antenna port. The photo of test setup please refer to ANNEX B.

5.8.3 Test Procedure

The measurement frequency range is from 9 kHz to the 10th harmonic of the fundamental frequency. The Turn Table is actuated to turn from 0° to 360°, and both horizontal and vertical polarizations of the Test Antenna are used to find the maximum radiated power. Mid channels on all channel bandwidth verified. Only the worst RB size/offset presented.

The power of the EUT transmitting frequency should be ignored.

All Spurious Emission tests were performed in X, Y, Z axis direction. And only the worst axis test condition was recorded in this test report.

Use the following spectrum analyzer settings:

Span = wide enough to fully capture the emission being measured

RBW = 1 MHz for $f \geq 1$ GHz, 100 kHz for $f < 1$ GHz

VBW \geq RBW

Sweep = auto

Detector function = peak

Trace = max hold

For measurement below 1GHz, If the emission level of the EUT measured by the peak detector is 3 dB lower than the applicable limit, the peak emission level will be reported, Otherwise, the emission measurement will be repeated using the quasi-peak detector and reported.

For transmitters operating above 1 GHz repeat the measurement with an average detector.

1.1.1 Test Result

Please refer to ANNEX A.7.

5.9 Power Spectral density (PSD)

5.9.1 Limit

FCC §15.247(e); RSS-247, 5.2 (b)

The same method of determining the conducted output power shall be used to determine the power spectral density. If a peak output power is measured, then a peak power spectral density measurement is required. If an average output power is measured, then an average power spectral density measurement should be used.

The transmitter power spectral density conducted from the transmitter to the antenna shall not be greater than 8 dBm in any 3 kHz band during any time interval of continuous transmission. This power spectral density shall be determined in accordance with the provisions of Section 5.4(4), (i.e. the power spectral density shall be determined using the same method as is used to determine the conducted output power).

5.9.2 Test Setup

See section 4.4.1 (Diagram 1) for test setup description for the antenna port. The photo of test setup please refer to ANNEX B.

5.9.3 Test Procedure

Set analyzer center frequency to DTS channel center frequency.

Set the span to 1.5 times the DTS bandwidth.

Set the RBW to: $3 \text{ kHz} \leq \text{RBW} \leq 100 \text{ kHz}$.

Set the VBW $\geq 3 \text{ RBW}$.

Detector = peak.

Sweep time = auto couple.

Trace mode = max hold.

Allow trace to fully stabilize.

Use the peak marker function to determine the maximum amplitude level within the RBW.

If measured value exceeds limit, reduce RBW (no less than 3 kHz) and repeat.

5.9.4 Test Result

Please refer to ANNEX A.7.

ANNEX A TEST RESULT

A.1 Output Power, E.I.R.P, Duty Cycle

Peak Power Test Data

Channel	Measured Output Peak Power		Limit		Verdict
	GFSK(BLE)		dBm	mW	
	dBm	mW			
Low	4.26	2.67	30	1000	Pass
Middle	4.51	2.83			Pass
High	4.15	2.60			Pass

Test plots

GFSK(BLE) LOW CHANNEL

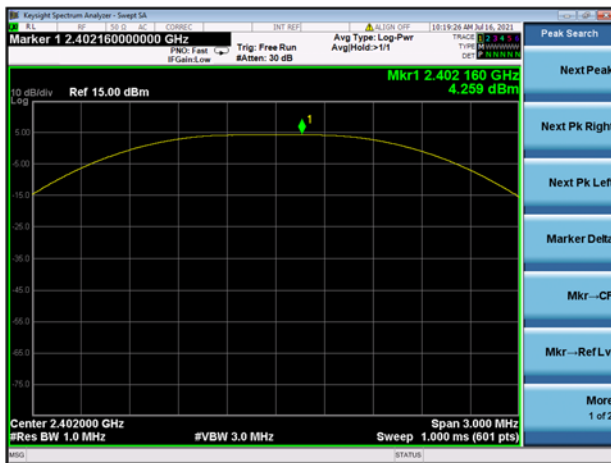

GFSK(BLE) MIDDLE CHANNEL

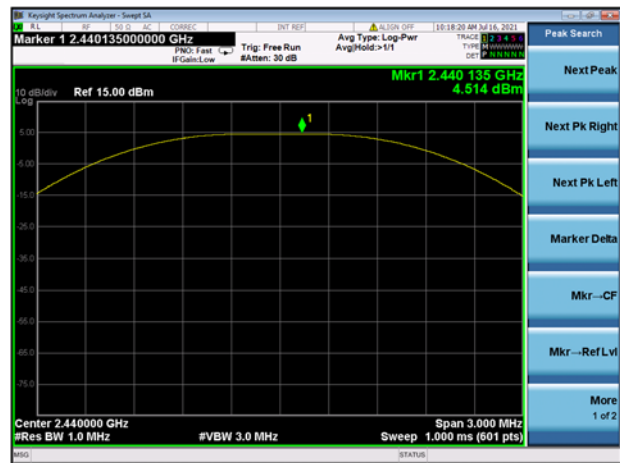

GFSK(BLE) HIGH CHANNEL

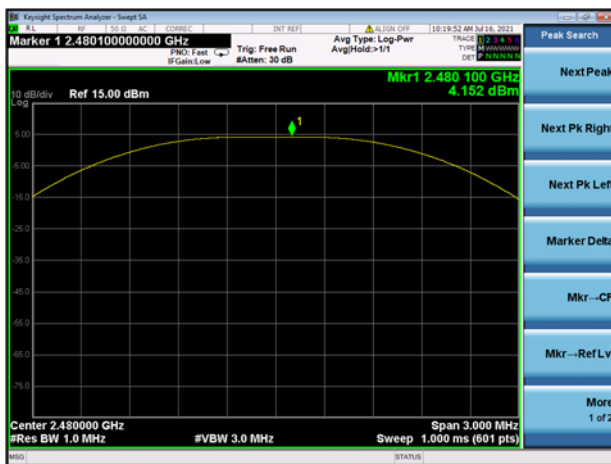

Duty Cycle Test Data

Band	On Time (ms)	On+Off Time (ms)	Duty Cycle (%)
GFSK	0.3920	0.6244	62.7800

Test plots

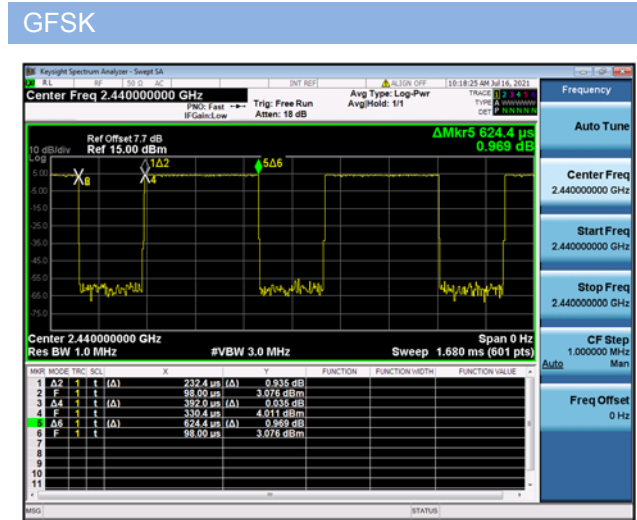

A.2 Occupied Bandwidth

Test Data

Test Mode	GFSK (BLE)		
Channel	6 dB Bandwidth (kHz)	99% Bandwidth (kHz)	6 dB Bandwidth Limits (kHz)
Low Channel	725.000	1032.700	≥500
Middle Channel	720.000	1041.800	≥500
High Channel	725.000	1047.200	≥500

Test plots

6 dB Bandwidth

GFSK (BLE) LOW CHANNEL



GFSK (BLE) MIDDLE CHANNEL



GFSK (BLE) HIGH CHANNEL



99% Bandwidth

GFSK (BLE) LOW CHANNEL

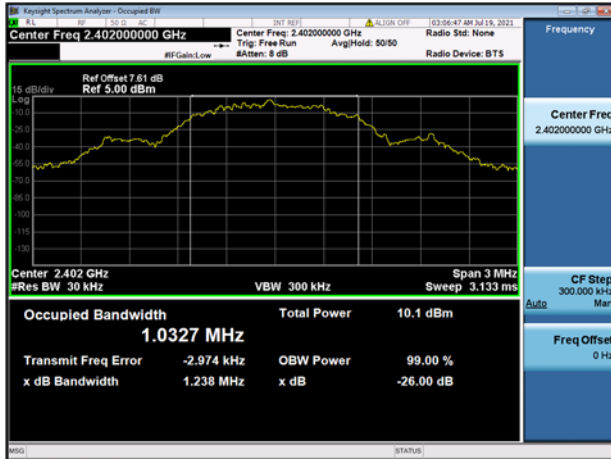

GFSK (BLE) MIDDLE CHANNEL

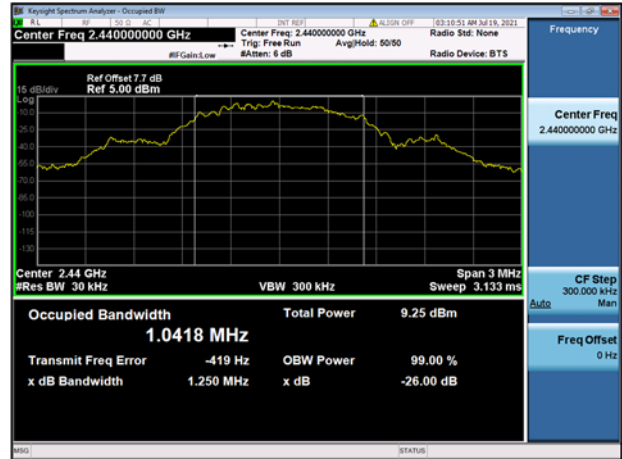

GFSK (BLE) HIGH CHANNEL

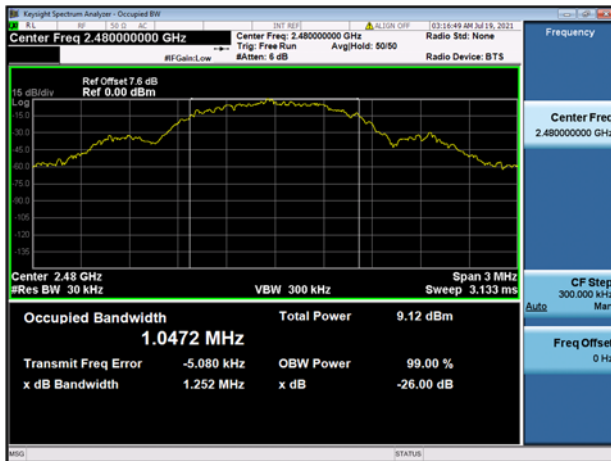

A.3 Conducted Spurious Emissions

Test Data

GFSK (BLE)				
Channel	Measured Max. Out of Band Emission (dBm)	Limit (dBm)		Verdict
		Carrier Level	Calculated 20 dBc Limit	
Low	-39.10	3.50	-16.505	Pass
Middle	-39.37	2.59	-17.415	Pass
High	-38.98	2.68	-17.323	Pass

Test Plots

GFSK (BLE) LOW CHANNEL, CARRIER LEVEL

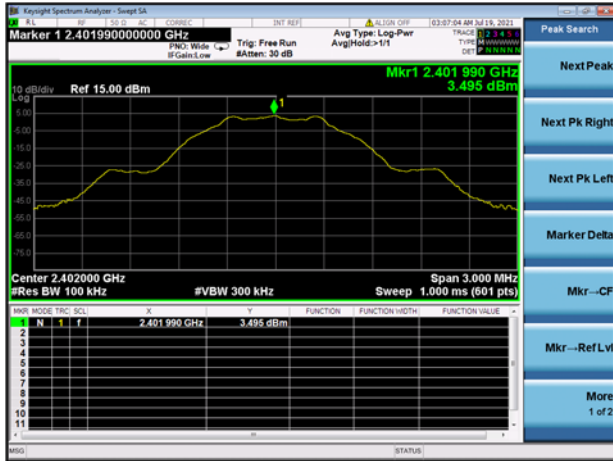

GFSK (BLE) LOW CHANNEL, SPURIOUS 30 MHz ~ 3 GHz

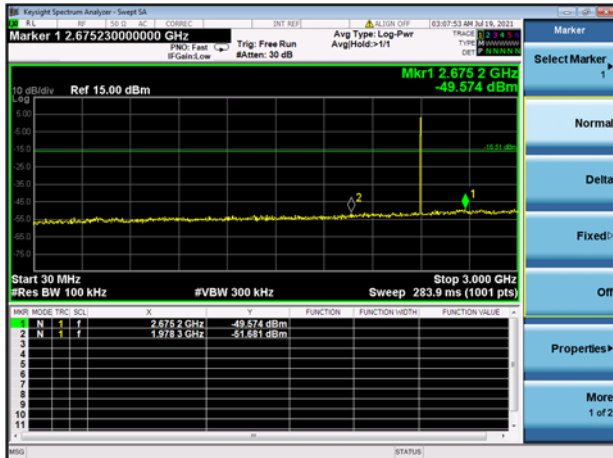

GFSK (BLE) LOW CHANNEL, SPURIOUS 2 GHz ~ 25 GHz

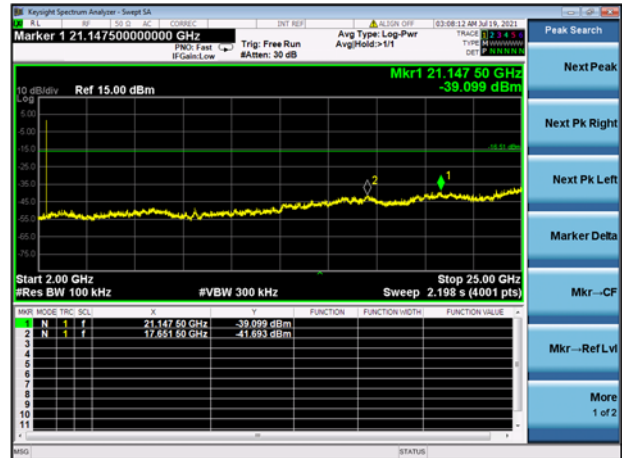

GFSK (BLE) MIDDLE CHANNEL, CARRIER LEVEL

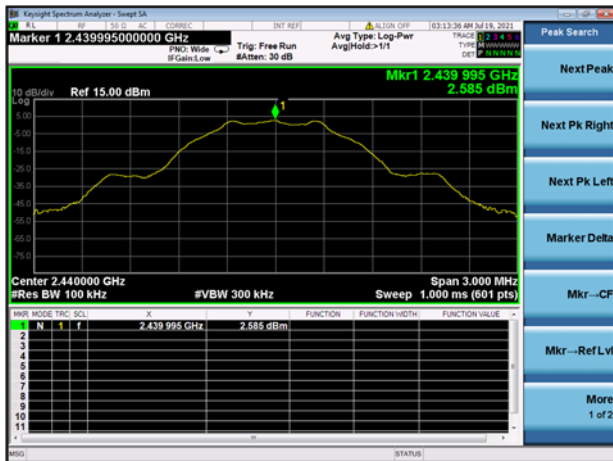

GFSK (BLE) MIDDLE CHANNEL, SPURIOUS 30 MHz ~ 3 GHz

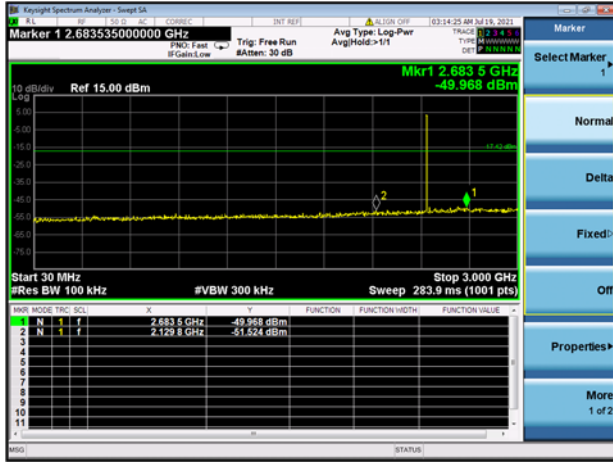

GFSK (BLE) MIDDLE CHANNEL, SPURIOUS 2 GHz ~ 25 GHz

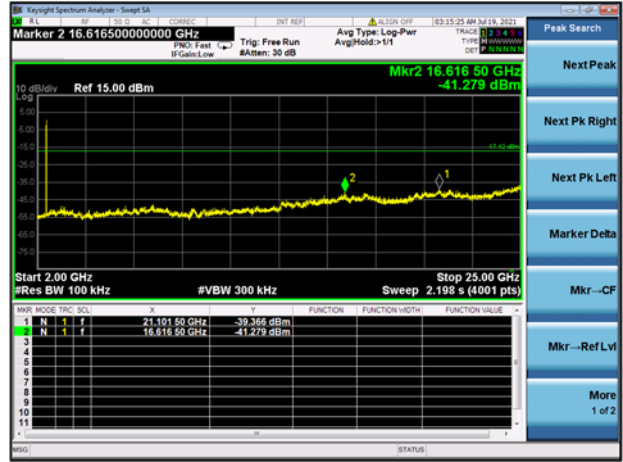

GFSK (BLE) HIGH CHANNEL, CARRIER LEVEL

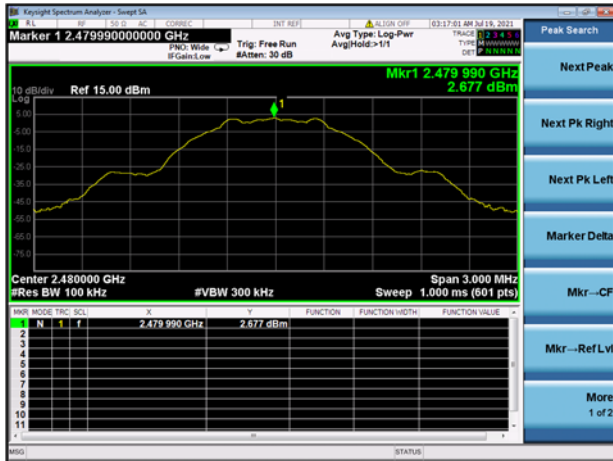

GFSK (BLE) HIGH CHANNEL, SPURIOUS 30 MHz ~ 3 GHz

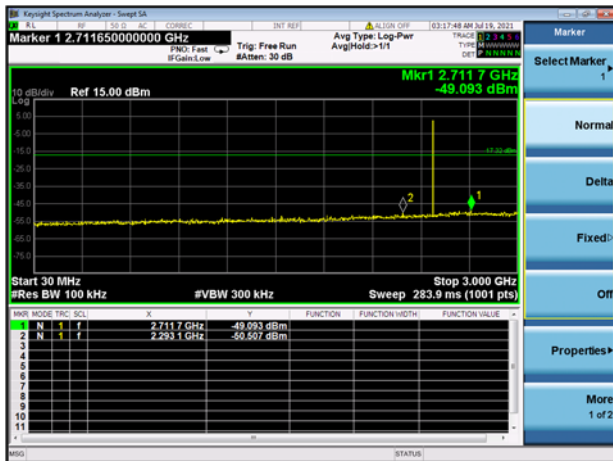

GFSK (BLE) HIGH CHANNEL, SPURIOUS 2 GHz ~ 25 GHz

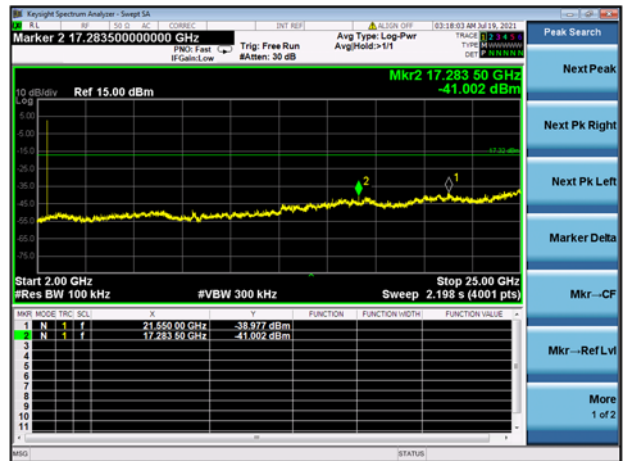

A.4 Band Edge (Authorized-band band-edge)

Note: The lowest and highest channels are tested to verify the band edge emissions. Please refer to the following the plots for emissions values.

Channel	Measured Max. Band Edge Emission (dBm)	Limit (dBm)		Verdict
		Carrier Level	Calculated 20 dBc Limit	
Low Channel	-52.78	3.50	-16.505	Pass
High Channel	-58.74	2.68	-17.323	Pass

Test Plots

LOW CHANNEL, Carrier level

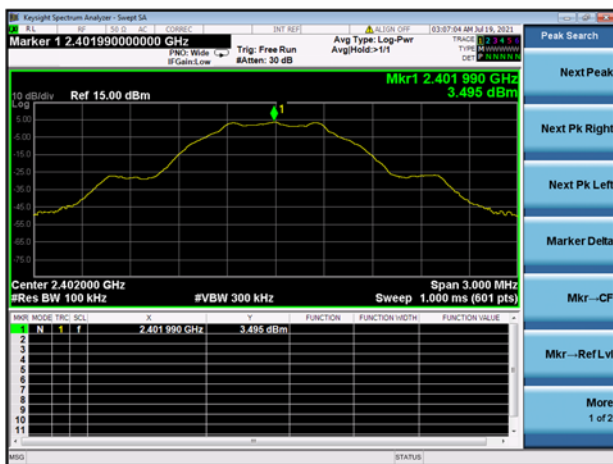

LOW CHANNEL, Reference level

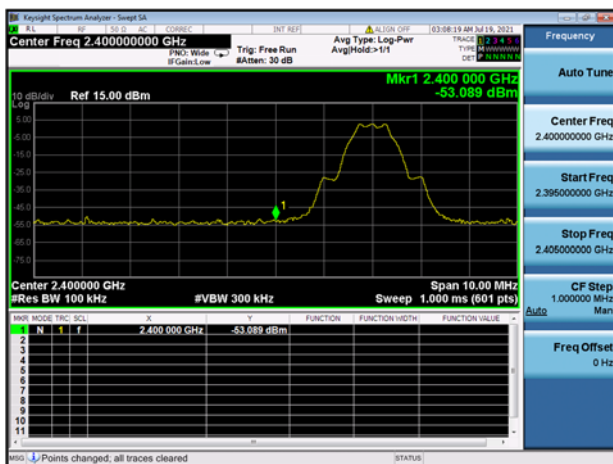

LOW CHANNEL, Band Edge

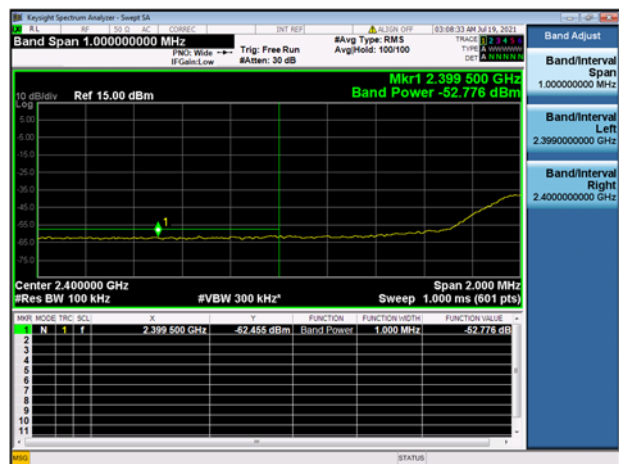

High CHANNEL, Carrier level

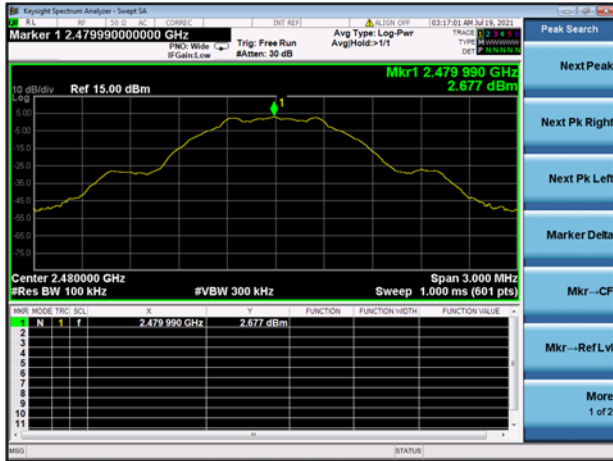

HIGH CHANNEL, Reference level

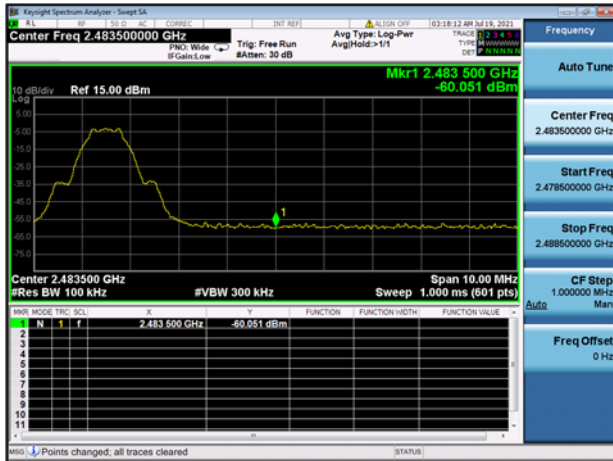

HIGH CHANNEL, Band Edge

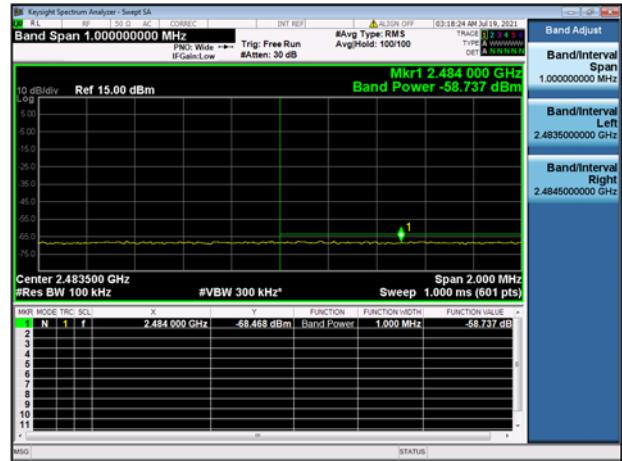

A.5 Conducted Emissions

Note¹: The EUT is working in the Normal link mode. All modes have been tested and normal link mode is worst.

Note²: Devices subject to Part 15 must be tested for all available U.S. voltages and frequencies (such as a nominal 120 VAC, 60 Hz and 240 VAC, 50 Hz) for which the device is capable of operation. So, The configuration 120 VAC, 60 Hz and 240 VAC, 50 Hz were tested respectively, but only the worst configuration (120 VAC, 60 Hz) shown here.

Note³: Results (dBuV) = Original reading level of Spectrum Analyzer (dBuV) + Factor (dB)

Test Data and Plots

PHASE L

CE Test case_FCC_CE_FCC PART 15B_Class B

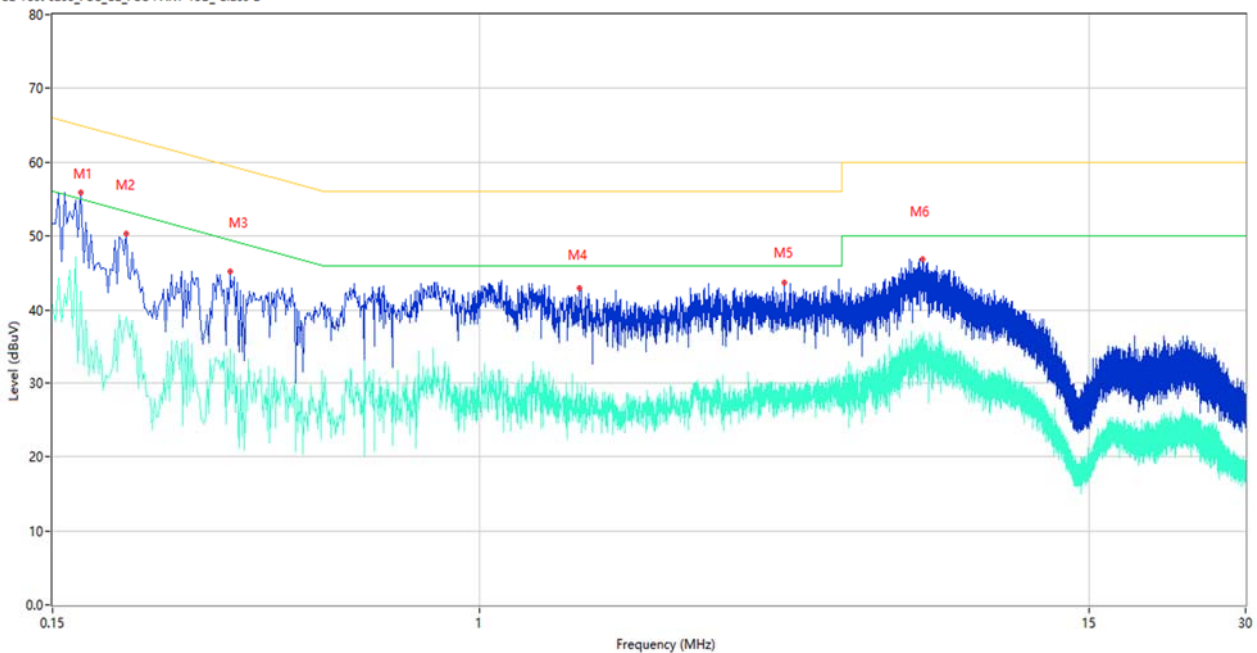

No.	Frequency (MHz)	Results (dBuV)	Factor (dB)	Limit (dBuV)	Over Limit (dB)	Detector	Line	Verdict
1	0.170	55.89	10.40	64.96	-9.07	Peak	L	Pass
1**	0.170	42.45	10.40	54.96	-12.51	AV	L	Pass
2	0.208	50.27	10.38	63.28	-13.01	Peak	L	Pass
2**	0.208	39.06	10.38	53.28	-14.22	AV	L	Pass
3	0.330	45.20	10.33	59.45	-14.25	Peak	L	Pass
3**	0.330	34.52	10.33	49.45	-14.93	AV	L	Pass
4	1.560	43.00	10.24	56.00	-13.00	Peak	L	Pass
4**	1.560	28.68	10.24	46.00	-17.32	AV	L	Pass
5	3.864	43.73	10.30	56.00	-12.27	Peak	L	Pass
5**	3.864	28.99	10.30	46.00	-17.01	AV	L	Pass
6	7.148	46.89	10.34	60.00	-13.11	Peak	L	Pass
6**	7.148	36.24	10.34	50.00	-13.76	AV	L	Pass

PHASE N

CE Test case_FCC_CE_FCC PART 15B_Class B

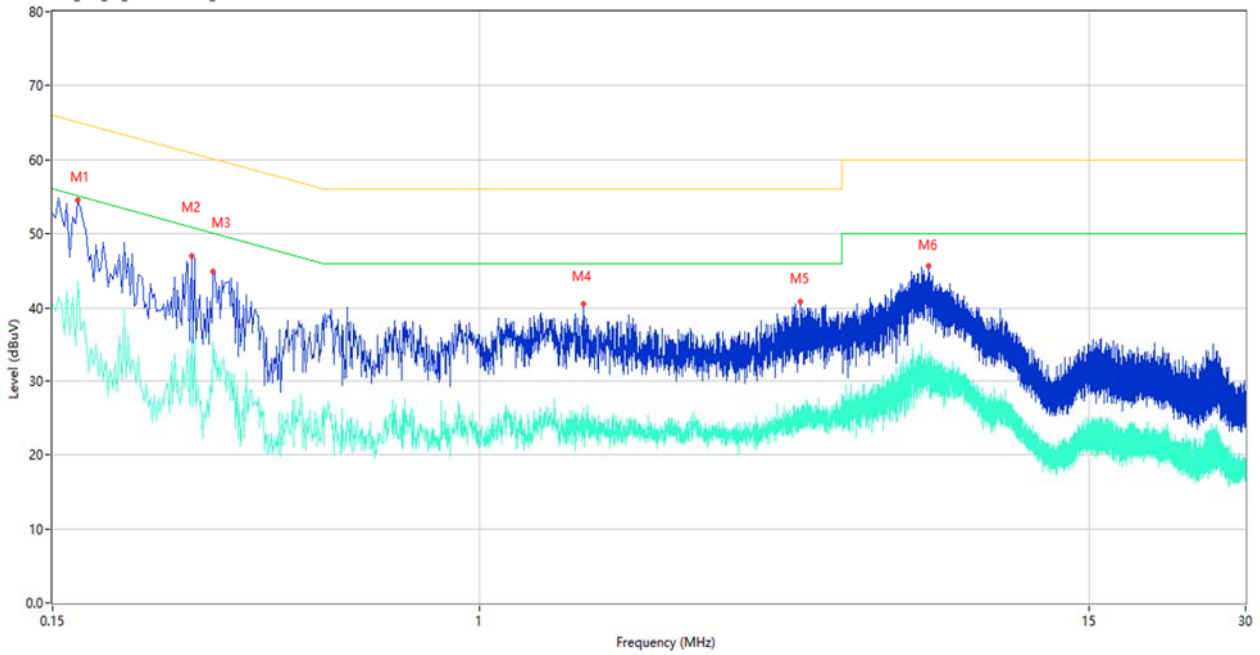

No.	Frequency (MHz)	Results (dBuV)	Factor (dB)	Limit (dBuV)	Over Limit (dB)	Detector	Line	Verdict
1	0.168	54.60	10.40	65.06	-10.46	Peak	N	Pass
1**	0.168	43.52	10.40	55.06	-11.54	AV	N	Pass
2	0.278	47.08	10.34	60.88	-13.80	Peak	N	Pass
2**	0.278	35.95	10.34	50.88	-14.93	AV	N	Pass
3	0.306	44.90	10.33	60.08	-15.18	Peak	N	Pass
3**	0.306	35.19	10.33	50.08	-14.89	AV	N	Pass
4	1.582	40.50	10.24	56.00	-15.50	Peak	N	Pass
4**	1.582	26.37	10.24	46.00	-19.63	AV	N	Pass
5	4.164	40.80	10.31	56.00	-15.20	Peak	N	Pass
5**	4.164	25.90	10.31	46.00	-20.10	AV	N	Pass
6	7.358	45.58	10.34	60.00	-14.42	Peak	N	Pass
6**	7.358	32.84	10.34	50.00	-17.16	AV	N	Pass

A.6 Radiated Spurious Emission

Note¹: The symbol of "--" in the table which means not application.

Note²: For the test data above 1 GHz, according the ANSI C63.4-2014, where limits are specified for both average and peak (or quasi-peak) detector functions, if the peak (or quasi-peak) measured value complies with the average limit, it is unnecessary to perform an average measurement.

Note³: The low frequency, which started from 9 kHz to 30 MHz, was pre-scanned and the result which was 20 dB lower than the limit line per 15.31(o) was not reported.

Note⁴: The EUT is working in the Normal link mode below 1 GHz. All modes have been tested and BLE 1M-Middle channel mode is the worst.

Note⁵: Results (dBuV/m) = Original reading level of Spectrum Analyzer (dBuV/m) + Factor (dB)

Test Data and Plots

30 MHz to 1 GHz, ANT H

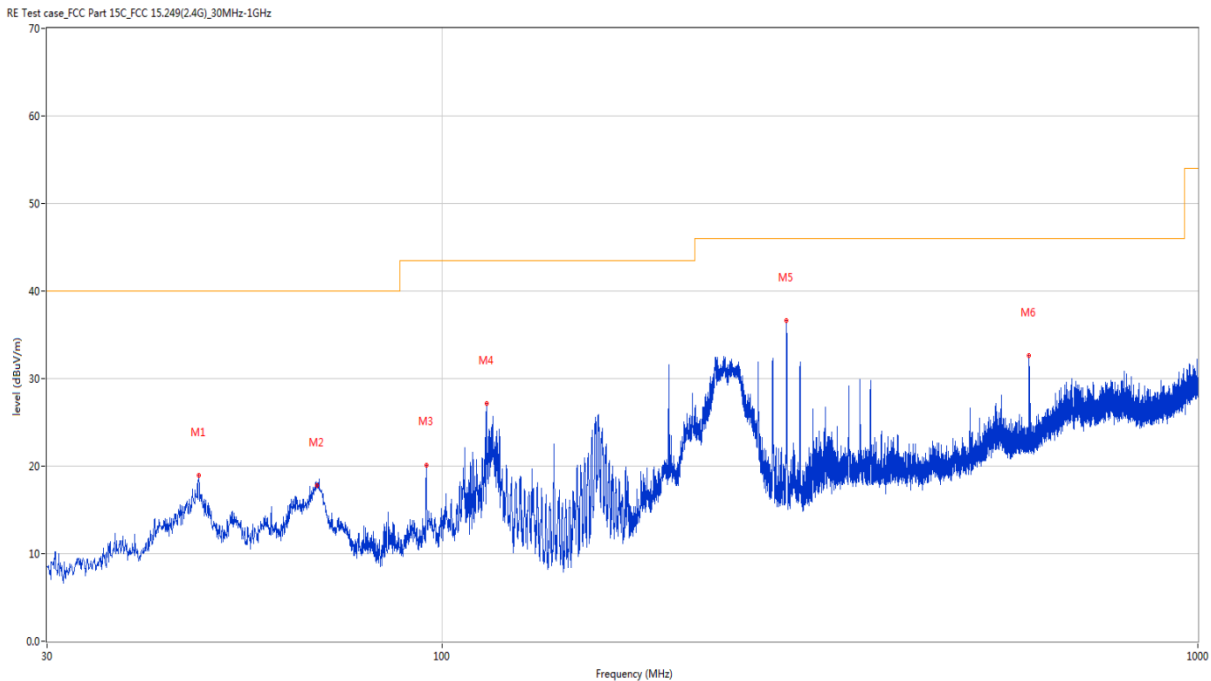

No.	Frequency (MHz)	Results (dBuV/m)	Factor (dB)	Limit (dBuV/m)	Over Limit (dB)	Detector	Table (Degree)	Height (cm)	Antenna	Verdict
1	47.605	18.46	-22.74	40.0	-21.54	Peak	0.40	100	Horizontal	Pass
2	68.267	17.65	-25.97	40.0	-22.35	Peak	360.00	100	Horizontal	Pass
3	95.329	19.82	-24.91	43.5	-23.68	Peak	360.00	200	Horizontal	Pass
4	114.487	27.16	-25.14	43.5	-16.34	Peak	136.80	200	Horizontal	Pass
5	285.595	36.60	-22.12	46.0	-9.40	Peak	163.30	100	Horizontal	Pass
6	597.450	32.60	-14.42	46.0	-13.40	Peak	360.00	200	Horizontal	Pass

30 MHz to 1 GHz, ANT V

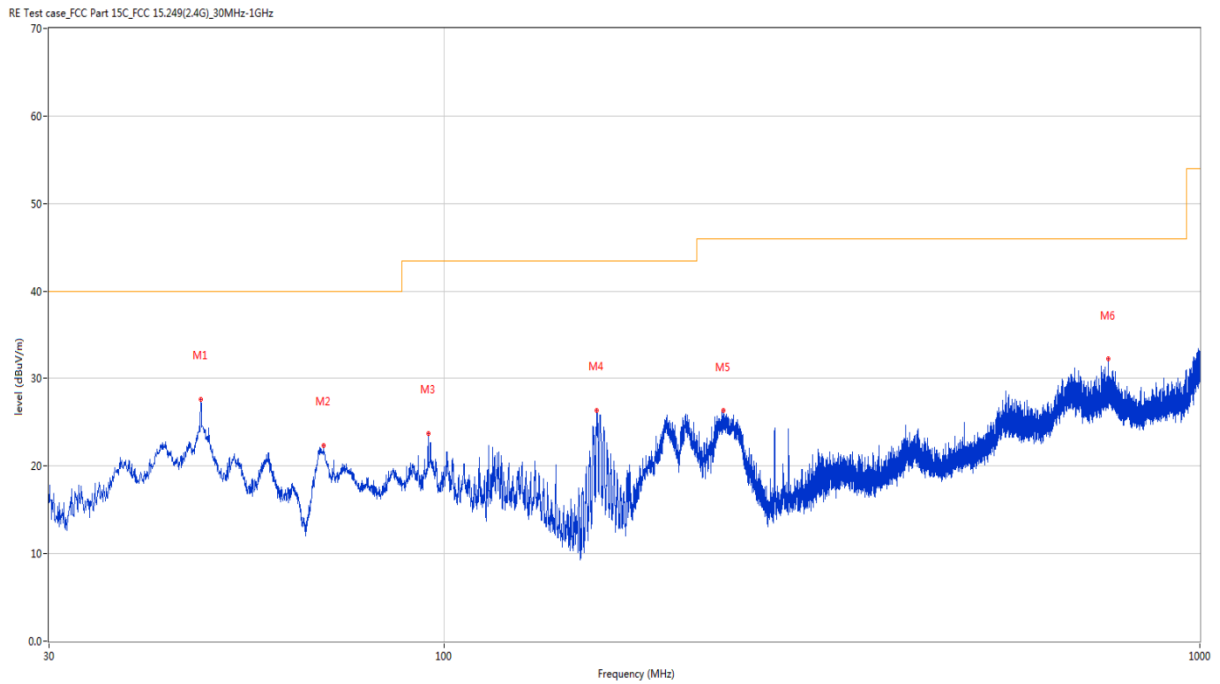

No.	Frequency (MHz)	Results (dBuV/m)	Factor (dB)	Limit (dBuV/m)	Over Limit (dB)	Detector	Table (Degree)	Height (cm)	Antenna	Verdict
1	47.605	27.58	-22.74	40.0	-12.42	Peak	196.00	100	Vertical	Pass
2	69.237	22.31	-26.69	40.0	-17.69	Peak	112.40	200	Vertical	Pass
3	95.232	23.73	-24.94	43.5	-19.77	Peak	191.10	100	Vertical	Pass
4	159.252	26.27	-27.45	43.5	-17.23	Peak	339.80	100	Vertical	Pass
5	233.991	26.26	-23.07	46.0	-19.74	Peak	101.70	200	Vertical	Pass
6	756.675	32.19	-12.36	46.0	-13.81	Peak	232.70	200	Vertical	Pass

Note 1: The marked spikes near 2400 MHz with circle should be ignored because they are Fundamental signal.

Note 2: The spurious from 18GHz-25GHz is noise only, do not show on the report.

GFSK LOW CHANNEL 1 GHz to 18 GHz, ANT H

RE Test case_FCC Part 15C_FCC 15.247(2.4G)_1GHz-18GHz

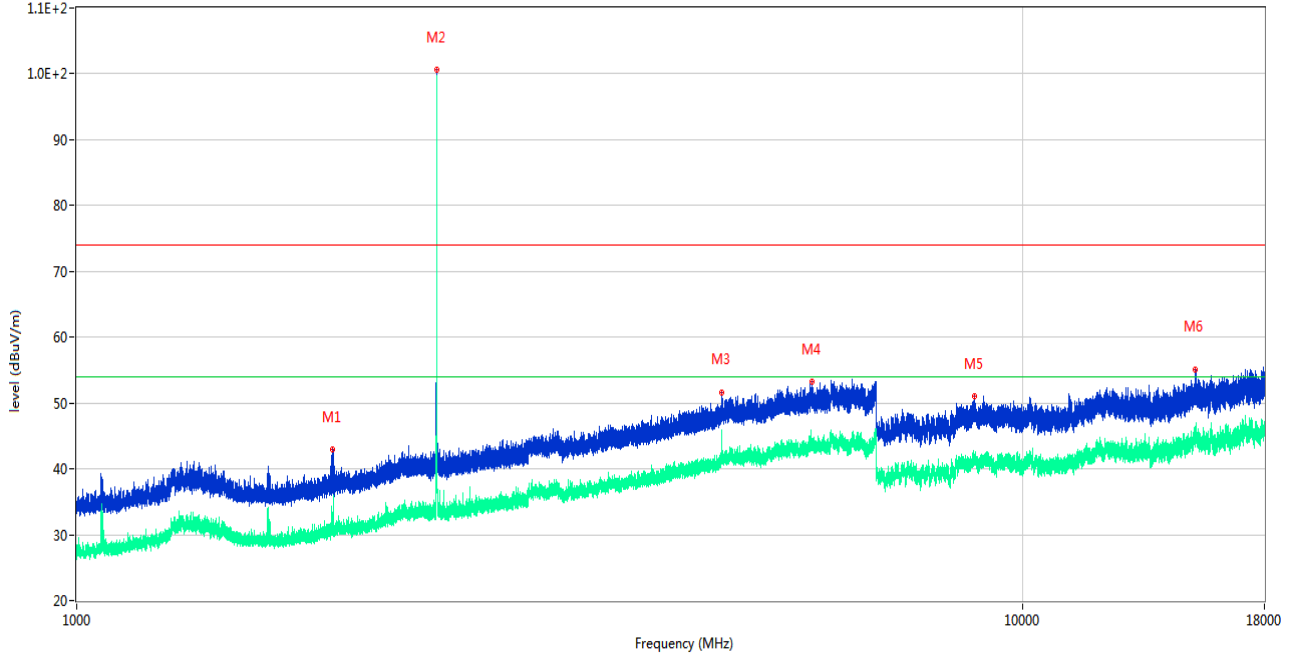

No.	Frequency (MHz)	Results (dBuV/m)	Factor (dB)	Limit (dBuV/m)	Over Limit (dB)	Detector	Table (Degree)	Height (cm)	Antenna	Verdict
1	1861.400	42.90	-16.46	74.0	-31.10	Peak	318.00	150	Horizontal	Pass
1**	1861.400	32.78	-16.46	54.0	-21.22	AV	318.00	150	Horizontal	Pass
2	2402.000	100.57	-12.26	74.0	26.57	Peak	142.00	150	Horizontal	N/A
2**	2402.000	99.39	-12.26	54.0	45.39	AV	142.00	150	Horizontal	N/A
3	4800.200	51.68	-2.55	74.0	-22.32	Peak	0.00	150	Horizontal	Pass
3**	4800.200	45.73	-2.55	54.0	-8.27	AV	0.00	150	Horizontal	Pass
4	5980.600	53.16	-1.56	74.0	-20.84	Peak	323.00	150	Horizontal	Pass
4**	5980.600	44.14	-1.56	54.0	-9.86	AV	323.00	150	Horizontal	Pass
5	8890.025	51.02	-0.93	74.0	-22.98	Peak	16.00	150	Horizontal	Pass
5**	8890.025	41.71	-0.93	54.0	-12.29	AV	16.00	150	Horizontal	Pass
6	15226.951	55.17	0.80	74.0	-18.83	Peak	296.00	150	Horizontal	Pass
6**	15226.951	44.84	0.80	54.0	-9.16	AV	296.00	150	Horizontal	Pass

GFSK LOW CHANNEL 1 GHz to 18 GHz, ANT V

RE Test case_FCC Part 15C_FCC 15.247(2.4G)_1GHz-18GHz

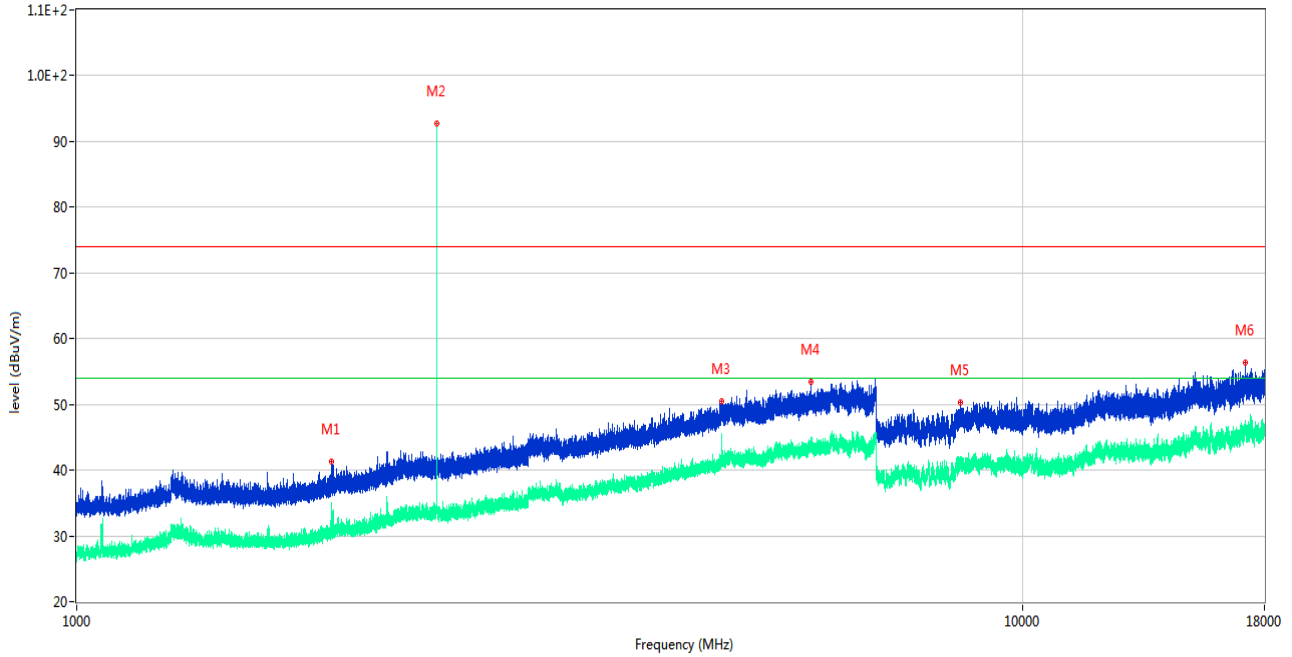

No.	Frequency (MHz)	Results (dBuV/m)	Factor (dB)	Limit (dBuV/m)	Over Limit (dB)	Detector	Table (Degree)	Height (cm)	Antenna	Verdict
1	1859.500	41.28	-16.57	74.0	-32.72	Peak	262.00	150	Vertical	Pass
1**	1859.500	30.40	-16.57	54.0	-23.60	AV	262.00	150	Vertical	Pass
2	2401.700	92.83	-12.26	74.0	18.83	Peak	167.00	150	Vertical	N/A
2**	2401.700	91.10	-12.26	54.0	37.10	AV	167.00	150	Vertical	N/A
3	4800.200	50.53	-2.55	74.0	-23.47	Peak	308.00	150	Vertical	Pass
3**	4800.200	44.86	-2.55	54.0	-9.14	AV	308.00	150	Vertical	Pass
4	5969.800	53.45	-1.05	74.0	-20.55	Peak	264.00	150	Vertical	Pass
4**	5969.800	43.56	-1.05	54.0	-10.44	AV	264.00	150	Vertical	Pass
5	8599.937	50.32	-2.22	74.0	-23.68	Peak	360.00	150	Vertical	Pass
5**	8599.937	40.88	-2.22	54.0	-13.12	AV	360.00	150	Vertical	Pass
6	17185.200	56.33	2.52	74.0	-17.67	Peak	205.00	150	Vertical	Pass
6**	17185.200	46.65	2.52	54.0	-7.35	AV	205.00	150	Vertical	Pass

GFSK MIDDLE CHANNEL 1 GHz to 18 GHz, ANT H

RE Test case_FCC Part 15C_FCC 15.247(2.4G)_1GHz-18GHz

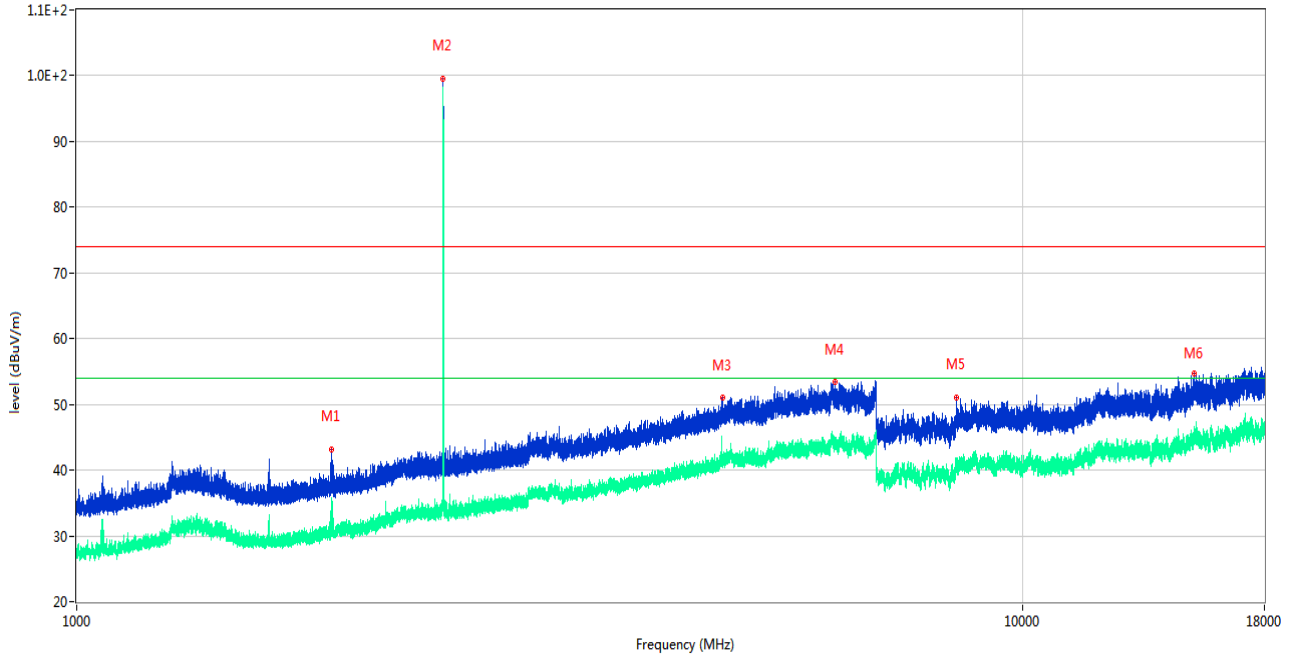

No.	Frequency (MHz)	Results (dBuV/m)	Factor (dB)	Limit (dBuV/m)	Over Limit (dB)	Detector	Table (Degree)	Height (cm)	Antenna	Verdict
1	1860.200	43.21	-16.54	74.0	-30.79	Peak	0.00	150	Horizontal	Pass
1**	1860.200	30.50	-16.54	54.0	-23.50	AV	0.00	150	Horizontal	Pass
2	2439.700	99.61	-12.64	74.0	25.61	Peak	133.00	150	Horizontal	N/A
2**	2439.700	96.80	-12.64	54.0	42.80	AV	133.00	150	Horizontal	N/A
3	4821.200	50.96	-3.42	74.0	-23.04	Peak	217.00	150	Horizontal	Pass
3**	4821.200	40.51	-3.42	54.0	-13.49	AV	217.00	150	Horizontal	Pass
4	6327.400	53.41	-1.50	74.0	-20.59	Peak	360.00	150	Horizontal	Pass
4**	6327.400	44.15	-1.50	54.0	-9.85	AV	360.00	150	Horizontal	Pass
5	8516.275	51.11	-1.46	74.0	-22.89	Peak	28.00	150	Horizontal	Pass
5**	8516.275	40.48	-1.46	54.0	-13.52	AV	28.00	150	Horizontal	Pass
6	15167.362	54.67	1.23	74.0	-19.33	Peak	349.00	150	Horizontal	Pass
6**	15167.362	45.16	1.23	54.0	-8.84	AV	349.00	150	Horizontal	Pass

GFSK MIDDLE CHANNEL 1 GHz to 18 GHz, ANT V

RE Test case_FCC Part 15C_FCC 15.247(2.4G)_1GHz-18GHz

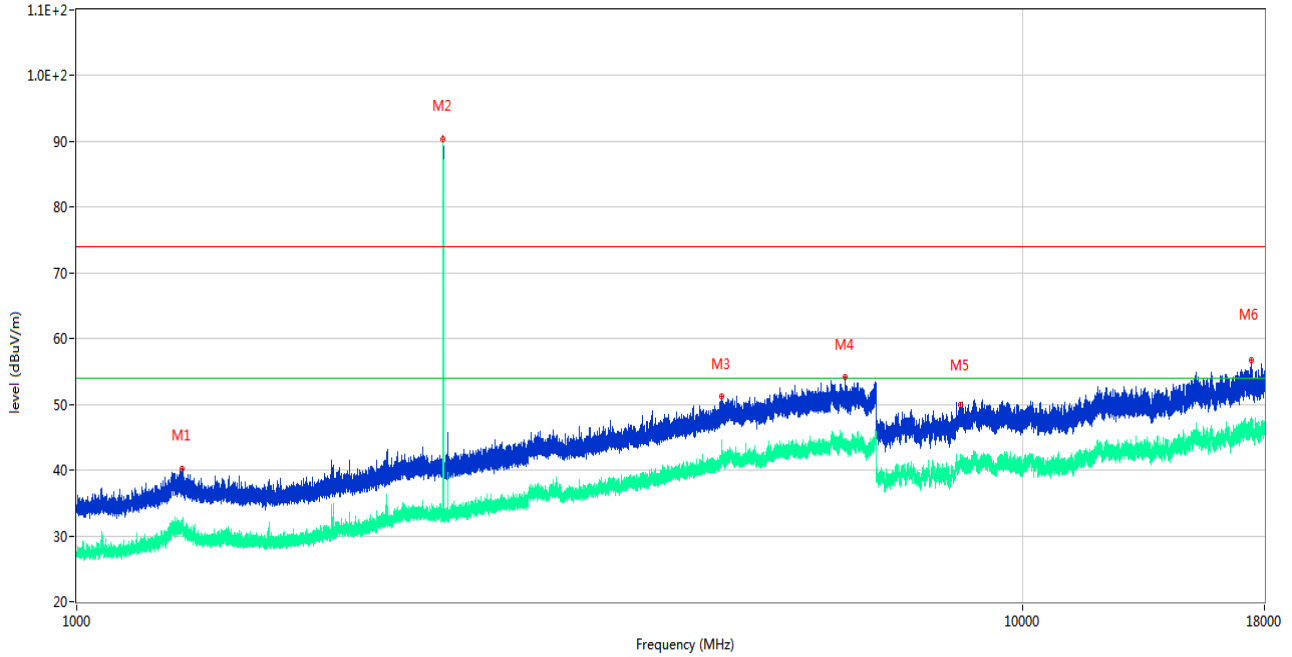

No.	Frequency (MHz)	Results (dBuV/m)	Factor (dB)	Limit (dBuV/m)	Over Limit (dB)	Detector	Table (Degree)	Height (cm)	Antenna	Verdict
1	1292.400	40.26	-17.46	74.0	-33.74	Peak	219.00	150	Vertical	Pass
1**	1292.400	31.59	-17.46	54.0	-22.41	AV	219.00	150	Vertical	Pass
2	2439.700	90.98	-12.64	74.0	16.98	Peak	107.00	150	Vertical	N/A
2**	2439.700	89.54	-12.64	54.0	35.54	AV	107.00	150	Vertical	N/A
3	4800.200	51.28	-2.55	74.0	-22.72	Peak	360.00	150	Vertical	Pass
3**	4800.200	44.55	-2.55	54.0	-9.45	AV	360.00	150	Vertical	Pass
4	6482.800	54.18	-2.01	74.0	-19.82	Peak	292.00	150	Vertical	Pass
4**	6482.800	43.81	-2.01	54.0	-10.19	AV	292.00	150	Vertical	Pass
5	8581.250	49.94	-2.09	74.0	-24.06	Peak	252.00	150	Vertical	Pass
5**	8581.250	41.72	-2.09	54.0	-12.28	AV	252.00	150	Vertical	Pass
6	17417.775	56.68	3.70	74.0	-17.32	Peak	53.00	150	Vertical	Pass
6**	17417.775	47.35	3.70	54.0	-6.65	AV	53.00	150	Vertical	Pass

GFSK HIGH CHANNEL 1 GHz to 18 GHz, ANT H

RE Test case_FCC Part 15C_FCC 15.247(2.4G)_1GHz-18GHz

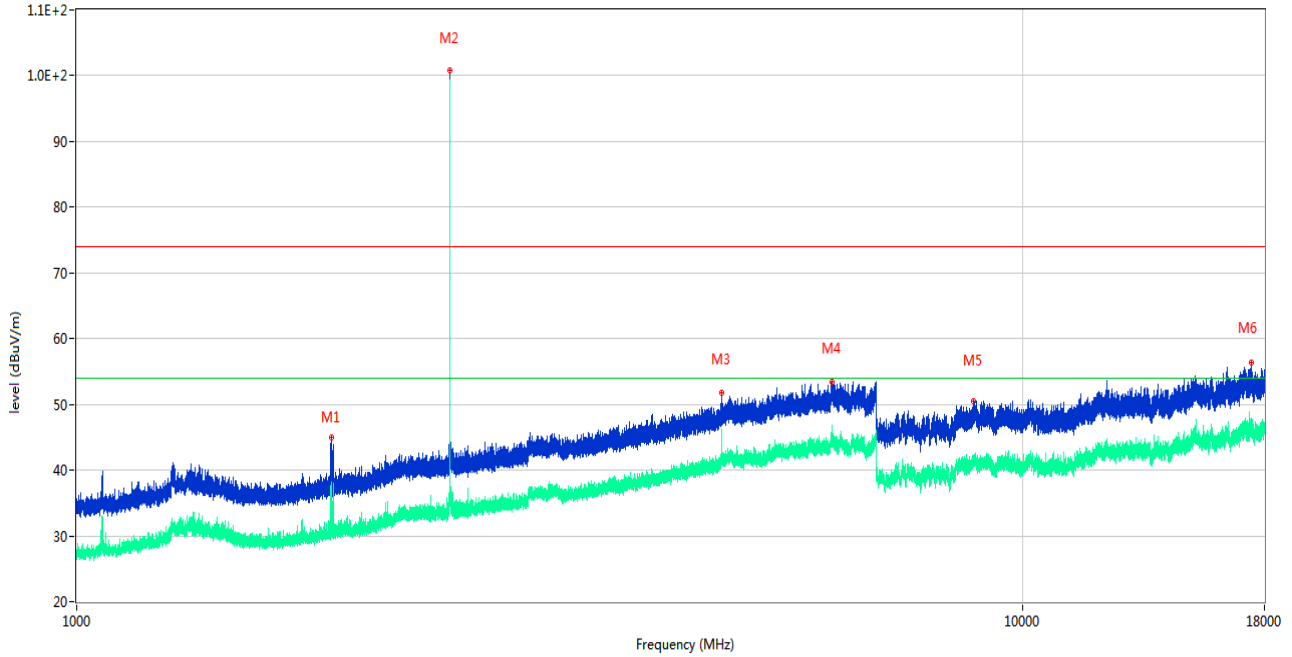

No.	Frequency (MHz)	Results (dBuV/m)	Factor (dB)	Limit (dBuV/m)	Over Limit (dB)	Detector	Table (Degree)	Height (cm)	Antenna	Verdict
1	1860.300	44.93	-16.53	74.0	-29.07	Peak	225.00	150	Horizontal	Pass
1**	1860.300	34.70	-16.53	54.0	-19.30	AV	225.00	150	Horizontal	Pass
2	2479.800	100.81	-12.43	74.0	26.81	Peak	126.00	150	Horizontal	N/A
2**	2479.800	98.64	-12.43	54.0	44.64	AV	126.00	150	Horizontal	N/A
3	4800.200	51.84	-2.55	74.0	-22.16	Peak	252.00	150	Horizontal	Pass
3**	4800.200	46.23	-2.55	54.0	-7.77	AV	252.00	150	Horizontal	Pass
4	6281.800	53.48	-0.23	74.0	-20.52	Peak	148.00	150	Horizontal	Pass
4**	6281.800	44.83	-0.23	54.0	-9.17	AV	148.00	150	Horizontal	Pass
5	8872.487	50.43	-0.83	74.0	-23.57	Peak	324.00	150	Horizontal	Pass
5**	8872.487	42.20	-0.83	54.0	-11.80	AV	324.00	150	Horizontal	Pass
6	17420.136	56.28	3.75	74.0	-17.72	Peak	1.00	150	Horizontal	Pass
6**	17420.136	47.17	3.75	54.0	-6.83	AV	1.00	150	Horizontal	Pass

GFSK HIGH CHANNEL 1 GHz to 18 GHz, ANT V

RE Test case_FCC Part 15C_FCC 15.247(2.4G)_1GHz-18GHz

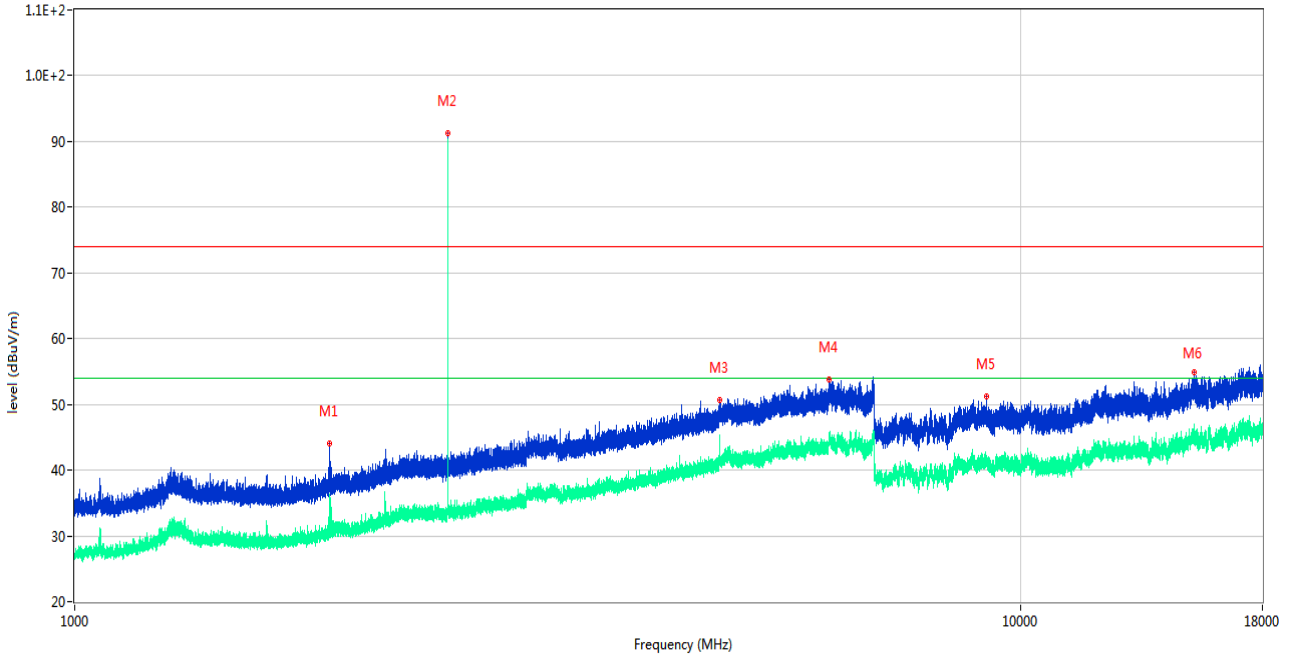

No.	Frequency (MHz)	Results (dBuV/m)	Factor (dB)	Limit (dBuV/m)	Over Limit (dB)	Detector	Table (Degree)	Height (cm)	Antenna	Verdict
1	1860.500	44.09	-16.52	74.0	-29.91	Peak	260.00	150	Vertical	Pass
1**	1860.500	36.32	-16.52	54.0	-17.68	AV	260.00	150	Vertical	Pass
2	2480.200	91.26	-12.43	74.0	17.26	Peak	143.00	150	Vertical	N/A
2**	2480.200	89.33	-12.43	54.0	35.33	AV	143.00	150	Vertical	N/A
3	4799.400	50.61	-2.55	74.0	-23.39	Peak	102.00	150	Vertical	Pass
3**	4799.400	41.60	-2.55	54.0	-12.40	AV	102.00	150	Vertical	Pass
4	6272.400	53.72	-0.22	74.0	-20.28	Peak	223.00	150	Vertical	Pass
4**	6272.400	44.26	-0.22	54.0	-9.74	AV	223.00	150	Vertical	Pass
5	9191.326	51.16	-1.28	74.0	-22.84	Peak	283.00	150	Vertical	Pass
5**	9191.326	41.37	-1.28	54.0	-12.63	AV	283.00	150	Vertical	Pass
6	15235.088	54.83	1.02	74.0	-19.17	Peak	241.00	150	Vertical	Pass
6**	15235.088	45.86	1.02	54.0	-8.14	AV	241.00	150	Vertical	Pass

A.7 Band Edge (Restricted-band band-edge)

Note 1: The lowest and highest channels are tested to verify the band edge emissions. Please refer to the following the plots for emissions values.

Note 2: The test data all are tested in the vertical and horizontal antenna which the trace is max hold. So these plots have shown the worst case.

Note 3: According the ANSI C63.10-2013, where limits are specified for both average and peak (or quasi-peak) detector functions, if the peak (or quasi-peak) measured value complies with the average limit, it is unnecessary to perform an average measurement.

Note 4: The Level (dBuV/m) has been corrected by factor.

Test plots

LOW CHANNEL

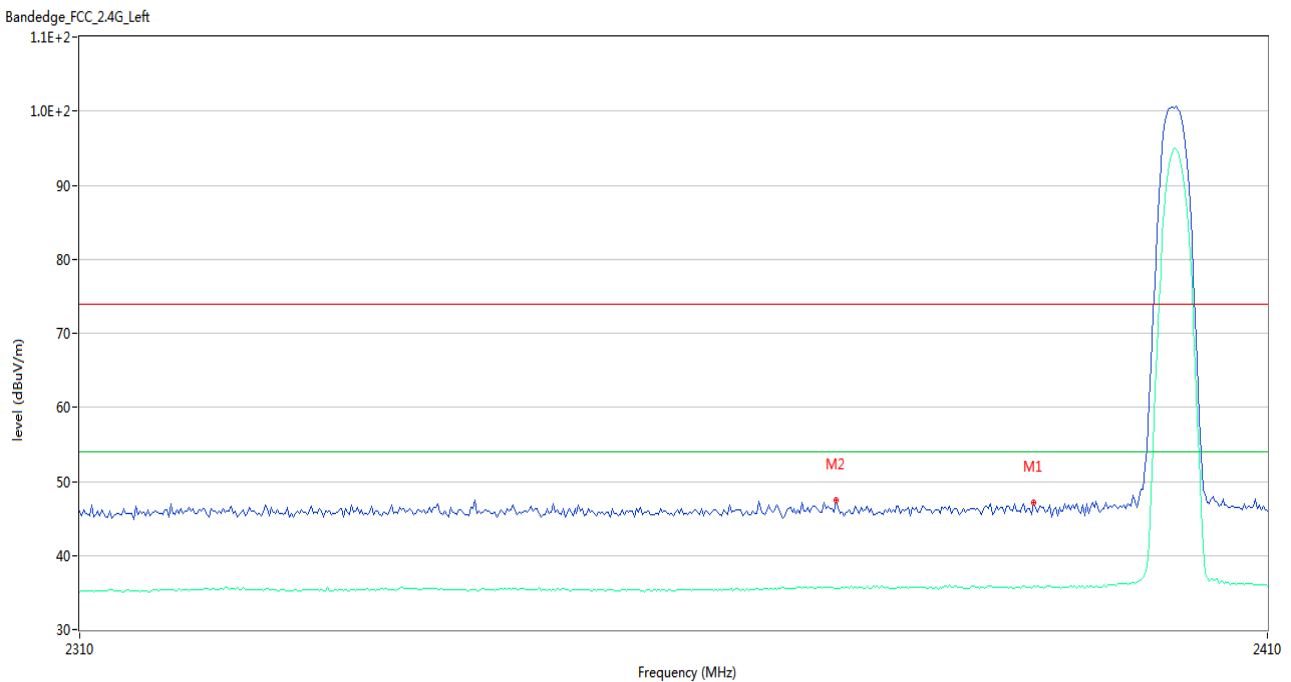

No.	Frequency (MHz)	Results (dBuV/m)	Factor (dB)	Limit (dBuV/m)	Over Limit (dB)	Detector	Table (Degree)	Height (cm)	Antenna	Verdict
1	2390.000	47.12	-12.50	74.0	-26.88	Peak	100.00	150	Horizontal	Pass
1**	2390.000	35.83	-12.50	54.0	-18.17	AV	100.00	150	Horizontal	Pass
2	2373.167	47.45	-12.55	74.0	-26.55	Peak	306.00	150	Horizontal	Pass
2**	2373.167	35.51	-12.55	54.0	-18.49	AV	306.00	150	Horizontal	Pass

HIGH CHANNEL

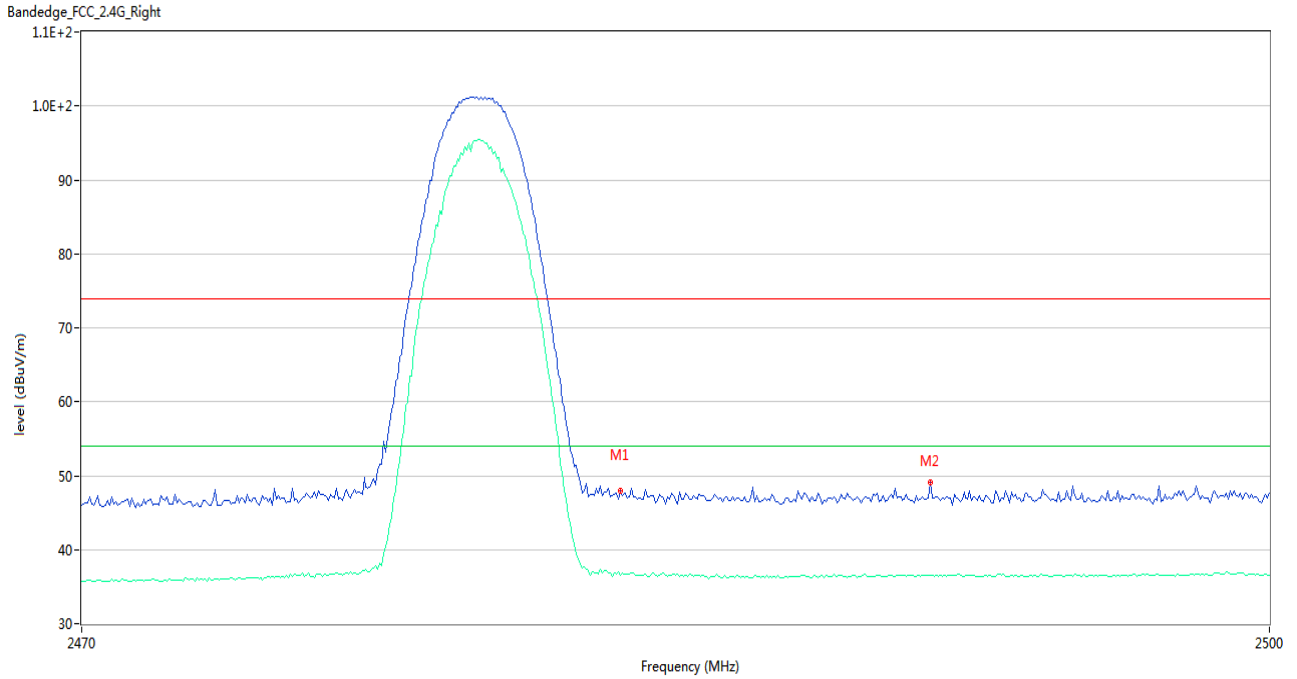

No.	Frequency (MHz)	Results (dBuV/m)	Factor (dB)	Limit (dBuV/m)	Over Limit (dB)	Detector	Table (Degree)	Height (cm)	Antenna	Verdict
1	2483.500	48.00	-12.36	74.0	-26.00	Peak	129.00	150	Horizontal	Pass
1**	2483.500	36.52	-12.36	54.0	-17.48	AV	129.00	150	Horizontal	Pass
2	2491.400	49.07	-12.04	74.0	-24.93	Peak	33.00	150	Horizontal	Pass
2**	2491.400	36.47	-12.04	54.0	-17.53	AV	33.00	150	Horizontal	Pass

A.8 Power Spectral Density (PSD)

Test Data

Channel	Spectral power density (dBm/3kHz)	Limit (dBm/3kHz)	Verdict
Low Channel	-11.456	8	Pass
Middle Channel	-12.876	8	Pass
High Channel	-10.608	8	Pass

Test plots

GFSK (BLE) LOW CHANNEL

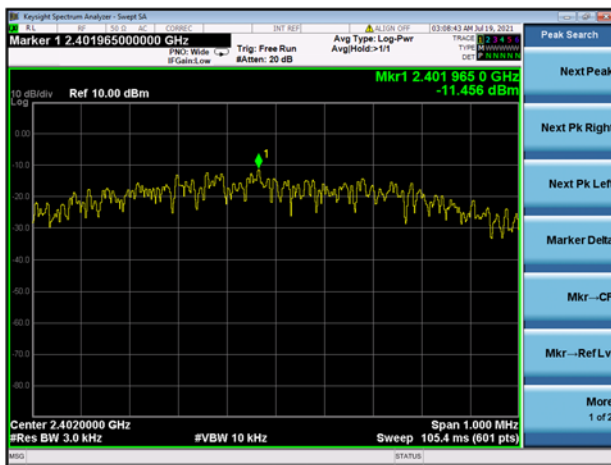

GFSK (BLE) MIDDLE CHANNEL

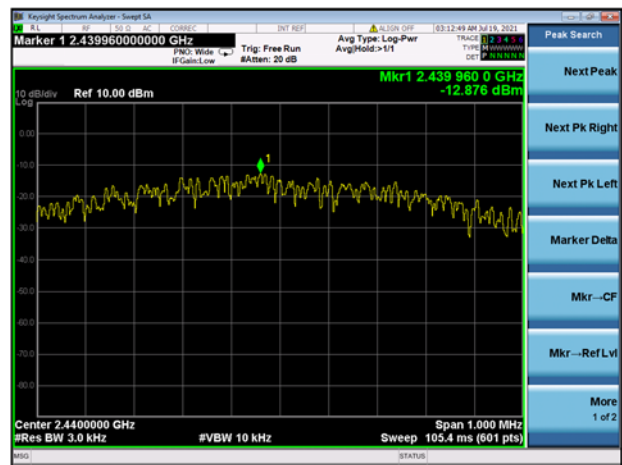

GFSK (BLE) HIGH CHANNEL

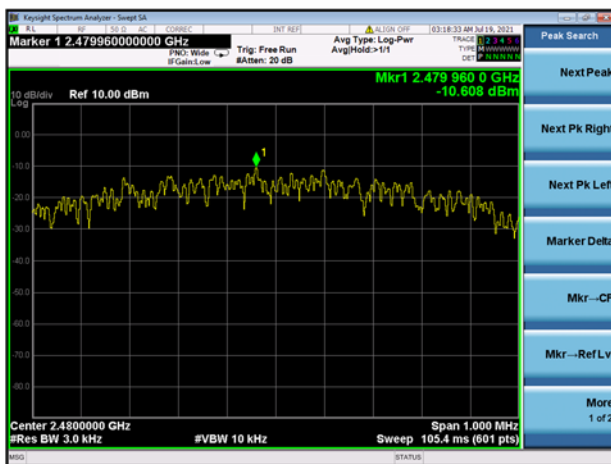

ANNEX B TEST SETUP PHOTOS

Please refer the document "BL-SZ2170442-AR.PDF".

ANNEX C EUT EXTERNAL PHOTOS

Please refer the document "BL-SZ2170442-AW.PDF".

ANNEX D EUT INTERNAL PHOTOS

Please refer the document "BL-SZ2170442-AI.PDF".

--END OF REPORT--