



Shenzhen Global Test Service Co.,Ltd.

No.7-101 and 8A-104, Building 7 and 8, DCC Cultural and Creative Garden, No.98, Pingxin North Road, Shangmugu Community, Pinghu Street, Longgang District, Shenzhen, Guangdong

FCC PART 15 SUBPART C TEST REPORT

FCC PART 15.407

Report Reference No.....: GTS20201118012-1-8

FCC ID.....: 2AYN6-GC205934

Compiled by

(position+printed name+signature) .: File administrators Peter Xiao

Supervised by

(position+printed name+signature) .: Test Engineer Moon Tan

Approved by

(position+printed name+signature) .: Manager Simon Hu



Date of issue: Jan.9, 2021

Representative Laboratory Name.: Shenzhen Global Test Service Co.,Ltd.

Address: No.7-101 and 8A-104, Building 7 and 8, DCC Cultural and Creative Garden, No.98, Pingxin North Road, Shangmugu Community, Pinghu Street, Longgang District, Shenzhen, Guangdong,China

Applicant's name.....: Dongguan Sunhans Technology Company Limited

Address: Room 1103, Building 8, Gemdale Wisdom Park, No. 95 Jiaoping Road, 523722 Tangxia, Dongguan, Guangdong,China

Test specification

Standard.....: **FCC Part 15.407: UNLICENSED NATIONAL INFORMATION INFRASTRUCTURE DEVICES**

TRF Originator.....: Shenzhen Global Test Service Co.,Ltd.

Master TRF: Dated 2014-12

Shenzhen Global Test Service Co.,Ltd. All rights reserved.

This publication may be reproduced in whole or in part for non-commercial purposes as long as the Shenzhen Global Test Service Co.,Ltd. is acknowledged as copyright owner and source of the material. Shenzhen Global Test Service Co.,Ltd. takes no responsibility for and will not assume liability for damages resulting from the reader's interpretation of the reproduced material due to its placement and context.

Test item description

Trade Mark.....: Sunhans/ eSunFi

Manufacturer: Dongguan Sunhans Technology Company Limited

Model/Type reference: SHFIM2-PROM

Listed Models: SHFIM2-PROS

Operation Frequency.....: From 5180MHz to 5240MHz/ 5745MHz to 5825MHz

Hardware Version: RL01

Software Version.....: V1.0

Rating: DC 12V by adapter

Result: **PASS**

TEST REPORT

Test Report No. : GTS20201118012-1-8	Jan.9, 2021
	Date of issue

Equipment under Test : WIFI Mesh System

Model /Type : SHFIM2-PROM

Listed model : SHFIM2-PROS

Applicant : **Dongguan Sunhans Technology Company Limited**

Address : Room 1103, Building 8, Gemdale Wisdom Park, No. 95 Jiaoping Road, 523722 Tangxia, Dongguan, Guangdong,China

Manufacturer : **Dongguan Sunhans Technology Company Limited**

Address : Room 1103, Building 8, Gemdale Wisdom Park, No. 95 Jiaoping Road, 523722 Tangxia, Dongguan, Guangdong,China

Test Result:	PASS
---------------------	-------------

The test report merely corresponds to the test sample.
It is not permitted to copy extracts of these test result without the written permission of the test laboratory.

Contents

1. TEST STANDARDS	4
2. SUMMARY	5
2.1. General Remarks	5
2.2. Product Description	5
2.3. Equipment Under Test	6
2.4. Short description of the Equipment under Test (EUT)	6
2.5. EUT operation mode	6
2.6. Block Diagram of Test Setup	6
2.7. Related Submittal(s) / Grant (s)	7
2.8. EUT Exercise Software	7
2.9. Special Accessories	7
2.10. External I/O Cable	7
2.11. Modifications	7
3. TEST ENVIRONMENT	8
3.1. Address of the test laboratory	8
3.2. Test Facility	8
3.3. Environmental conditions	8
3.4. Statement of the measurement uncertainty	8
3.5. Test Description	9
3.6. Equipments Used during the Test.....	10
4. TEST CONDITIONS AND RESULTS	11
4.1. AC Power Conducted Emission	11
4.2. Radiated Emission	13
4.3. Duty Cycle	21
4.4. Maximum Average Output Power	28
4.5. Power Spectral Density	32
4.6. 6dB Bandwidth	50
4.7. 26dBc Bandwidth	64
4.8. Band Edge Compliance.....	78
4.9. Frequency Stability.....	93
4.10. Antenna Requirement	96
5. TEST SETUP PHOTOS OF THE EUT.....	97
6. EXTERNAL AND INTERNAL PHOTOS OF THE EUT	97

1. TEST STANDARDS

The tests were performed according to following standards:

[FCC Rules Part 15.407](#): UNLICENSED NATIONAL INFORMATION INFRASTRUCTURE DEVICES.

[ANSI C63.10-2013](#): American National Standard for Testing Unlicensed Wireless Devices

[KDB789033 D02 General U-NII Test Procedures New Rules v02r01](#): UNII, U-NII, U-NII Test Procedures

2. SUMMARY

2.1. General Remarks

Date of receipt of test sample	:	Dec.25, 2020
Testing commenced on	:	Dec.25, 2020
Testing concluded on	:	Jan.9, 2021

2.2. Product Description

Product Name	WIFI Mesh System
Trade Mark	Sunhans/ eSunFi
Model/Type reference	SHFIM2-PROM
List Models	SHFIM2-PROS
Model Declaration	PCB board, structure and internal of these model(s) are the same, Only the model name is different , So no additional models were tested.
Power supply:	DC 12V by adapter
Sample ID	GTS20201118012-1-1# & GTS20201118012-1-2#
WIFI(2.4G Band)	
Frequency Range	2412MHz ~ 2462MHz
Channel Spacing	5MHz
Channel Number	11 Channel for 20MHz bandwidth(2412~2462MHz) 7 channels for 40MHz bandwidth(2422~2452MHz)
Modulation Type	802.11b: DSSS; 802.11g/n: OFDM
WIFI(5.2G Band)	
Frequency Range	5180MHz ~ 5240MHz
Channel Number	4 channels for 20MHz bandwidth(5180-5240MHz) 2 channels for 40MHz bandwidth(5190~5230MHz) 1 channels for 80MHz bandwidth(5210MHz)
Modulation Type	802.11a/n/ac: OFDM
WIFI (5.8G Band)	
Frequency Range	5745MHz ~ 5825MHz
Channel Number	5 channels for 20MHz bandwidth(5745-5825MHz) 2 channels for 40MHz bandwidth(5755~5795MHz) 1 channels for 80MHz bandwidth(5775MHz)
Modulation Type	802.11a/n/ac: OFDM
Antenna Description	Tow Internal Antennas respectively.WLAN support 2*2MIMO technology. ANT0 used for WIFI TX/RX, 5.0dBi(Max.) for 2.4G Band and 5.0dBi(Max.) for 5G Band. ANT1 used for WIFI TX/RX, 5.0dBi(Max.) for 2.4G Band and 5.0dBi(Max.) for 5G Band.

2.3. Equipment Under Test

Power supply system utilised

Power supply voltage	:	<input type="radio"/> 230V / 50 Hz	<input type="radio"/> 120V / 60Hz
		<input checked="" type="radio"/> 12 V DC	<input type="radio"/> 24 V DC
		<input type="radio"/> Other (specified in blank below)	

2.4. Short description of the Equipment under Test (EUT)

This is a WIFI Mesh System .
 For more details, refer to the user's manual of the EUT.

2.5. EUT operation mode

The application provider specific test software to control sample in continuous TX and RX.

Antenna	Chain0 (ANT0)			Chain1 (ANT1)			Simultaneously
Bandwidth Mode	20MHz	40MHz	80MHz	20MHz	40MHz	80MHz	/
IEEE 802.11a	<input checked="" type="checkbox"/>	<input type="checkbox"/>	<input type="checkbox"/>	<input checked="" type="checkbox"/>	<input type="checkbox"/>	<input type="checkbox"/>	<input type="checkbox"/>
IEEE 802.11n	<input checked="" type="checkbox"/>	<input checked="" type="checkbox"/>	<input type="checkbox"/>	<input checked="" type="checkbox"/>	<input checked="" type="checkbox"/>	<input type="checkbox"/>	<input checked="" type="checkbox"/>
IEEE 802.11ac	<input checked="" type="checkbox"/>	<input checked="" type="checkbox"/>	<input checked="" type="checkbox"/>	<input checked="" type="checkbox"/>	<input checked="" type="checkbox"/>	<input checked="" type="checkbox"/>	<input checked="" type="checkbox"/>

IEEE 802.11a/ac20/ac40/ac80/n20/n40:

UNII-1		UNII-1		UNII-1	
Channel	Frequency (MHz)	Channel	Frequency (MHz)	Channel	Frequency (MHz)
36	5180	38	5190	42	5210
40	5200	46	5230		
44	5220				
48	5240				

UNII-3		UNII-3		UNII-3	
Channel	Frequency (MHz)	Channel	Frequency (MHz)	Channel	Frequency (MHz)
149	5745	151	5755	155	5775
153	5765	159	5795		
157	5785				
161	5805				
165	5825				

The EUT has been tested under operating condition.

This test was performed with EUT in X, Y, Z position and the worst case was found when EUT in X position.
 AC main conducted emission pre-test voltage at both AC 120V/60Hz and AC 240V/50Hz, recorded worst case;
 AC main conducted emission pre-test at charge from PC modes, recorded worst case;
 Worst-case mode and channel used for 9 KHz-1000 MHz radiated emissions was the mode and channel with the highest output power, that was determined to be IEEE 802.11ac VHT20 mode (HCH).

2.6. Block Diagram of Test Setup

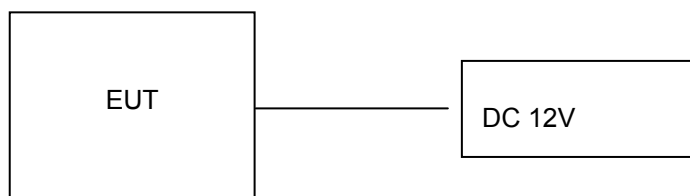

2.7. Related Submittal(s) / Grant (s)

This submittal(s) (test report) is intended for **FCC ID: 2AYN6-GC205934** filing to comply with Section 15.407 of the FCC Part 15, Subpart E Rules.

2.8. EUT Exercise Software

The system was configured for testing in a continuous transmits condition and change test channels by software (MP_TEST) provided by application.

2.9. Special Accessories

Manufacturer	Description	Model	Serial Number	Certificate
LENOVO	Tablet	DESKYOP-EUIVCNR	--	SDOC
Shenzhen Simsukian Electronics Technogy Co.,Ltd.	Adapter	SK02T-1200150Z	--	SDOC

Note: The Tablet is only used for auxiliary testing.

2.10. External I/O Cable

I/O Port Description	Quantity	Cable
DC IN Port	1	1.0M, Unscreened Cable
LAN Port	2	0.8M, Unscreened Cable

2.11. Modifications

No modifications were implemented to meet testing criteria.

3. TEST ENVIRONMENT

3.1. Address of the test laboratory

Shenzhen Global Test Service Co.,Ltd.

No.7-101 and 8A-104, Building 7 and 8, DCC Cultural and Creative Garden, No.98, Pingxin North Road, Shangmugu Community, Pinghu Street, Longgang District, Shenzhen, Guangdong, China.

3.2. Test Facility

The test facility is recognized, certified, or accredited by the following organizations:

CNAS (No. CNAS L8169)

Shenzhen Global Test Service Co., Ltd. has been assessed and proved to be in compliance with CNAS-CL01 Accreditation Criteria for Testing and Calibration Laboratories (identical to ISO/IEC 17025: 2019 General Requirements) for the Competence of Testing and Calibration Laboratories.

A2LA (Certificate No. 4758.01)

Shenzhen Global Test Service Co., Ltd. has been assessed by the American Association for Laboratory Accreditation (A2LA). Certificate No. 4758.01.

Industry Canada Registration Number. is 24189.

FCC Designation Number is CN1234.

FCC Registered Test Site Number is 165725.

IC Registration Number is 24189.

CAB identifier is CN0082.

3.3. Environmental conditions

During the measurement the environmental conditions were within the listed ranges:

Temperature:	15-35 ° C
Humidity:	30-60 %
Atmospheric pressure:	950-1050mbar

3.4. Statement of the measurement uncertainty

The data and results referenced in this document are true and accurate. The reader is cautioned that there may be errors within the calibration limits of the equipment and facilities. The measurement uncertainty was calculated for all measurements listed in this test report acc. to CISPR 16 - 4 „Specification for radio disturbance and immunity measuring apparatus and methods – Part 4: Uncertainty in EMC Measurements“ and is documented in the Shenzhen Global Test Service Co.,Ltd quality system acc. to DIN EN ISO/IEC 17025. Furthermore, component and process variability of devices similar to that tested may result in additional deviation. The manufacturer has the sole responsibility of continued compliance of the device.

Hereafter the best measurement capability for Shenzhen GTS laboratory is reported:

Test	Range	Measurement Uncertainty	Notes
Radiated Emission	30~1000MHz	4.10 dB	(1)
Radiated Emission	1~18GHz	4.32 dB	(1)
Radiated Emission	18-40GHz	5.54 dB	(1)
Conducted Disturbance	0.15~30MHz	3.12 dB	(1)

- (1) This uncertainty represents an expanded uncertainty expressed at approximately the 95% confidence level using a coverage factor of k=2.

3.5. Test Description

Applied Standard: FCC Part 15 Subpart E				
ISED Rules	Description of Test	Test Sample	Result	Remark
/	On Time and Duty Cycle	GTS20201118012-1-1#	Compliant	Note 1
§15.407(a)	Maximum Conducted Output Power	GTS20201118012-1-1#	Compliant	Note 1
§15.407(a)	Power Spectral Density	GTS20201118012-1-1#	Compliant	Note 1
§15.407(a)	26dB&6dB Bandwidth and 99% Bandwidth	GTS20201118012-1-1#	Compliant	Note 1
§15.209, §15.407(b)	Radiated Emissions	GTS20201118012-1-1# GTS20201118012-1-2#	Compliant	Note 1
§15.209, §15.407(b)	Emissions at Restricted Band	GTS20201118012-1-1# GTS20201118012-1-2#	Compliant	Note 1
§15.407(g)	Frequency Stability	GTS20201118012-1-1#	Compliant	Note 1
§15.207(a)	AC Mians Line Conducted Emissions	GTS20201118012-1-2#	Compliant	Note 1
§15.203	Antenna Requirements	GTS20201118012-1-1#	Compliant	Note 1
§15.407 §2.1091	RF Exposure	GTS20201118012-1-1#	Compliant	Note 2

Remark:

1. The measurement uncertainty is not included in the test result.
2. NA = Not Applicable; NP = Not Performed
3. Note 1 – Test results inside test report;
4. Note 2 – Test results in other test report (SAR Report).
5. We tested all test mode and recorded worst case in report

Preliminary tests were performed in different data rate to find the worst radiated emission. The data rate shown in the table below is the worst-case rate with respect to the specific test item. Investigation has been done on all the possible configurations for searching the worst cases. The following table is a list of the test modes shown in this test report.

Test Items	Mode	Data Rate
Maximum Peak Conducted Output Power	802.11a	6 Mbps
Power Spectral Density	802.11ac20/ac40/ac80 802.11n HT20/40	MCS0
6dB Bandwidth		
26dB Bandwidth		
Radiated Emission30M~1GHz& Radiated Emission 1GHz~10 th Harmonic		
Band Edge	802.11a	6 Mbps
	802.11ac20/ac40/ac80 802.11n HT20/40	MCS0

3.6. Equipments Used during the Test

Test Equipment	Manufacturer	Model No.	Serial No.	Calibration Date	Calibration Due Date
LISN	R&S	ENV216	3560.6550.08	2020/09/19	2021/09/18
LISN	R&S	ESH2-Z5	893606/008	2020/09/19	2021/09/18
EMI Test Receiver	R&S	ESPI3	101841-cd	2020/09/19	2021/09/18
EMI Test Receiver	R&S	ESCI7	101102	2020/09/19	2021/09/18
Spectrum Analyzer	Agilent	N9020A	MY48010425	2020/09/19	2021/09/18
Spectrum Analyzer	R&S	FSV40	100019	2020/09/19	2021/09/18
Vector Signal generator	Agilent	N5181A	MY49060502	2020/09/19	2021/09/18
Signal generator	Agilent	E4421B	3610AO1069	2020/09/19	2021/09/18
Climate Chamber	ESPEC	EL-10KA	A20120523	2020/09/19	2021/09/18
Controller	EM Electronics	Controller EM 1000	N/A	N/A	N/A
Horn Antenna	Schwarzbeck	BBHA 9120D	01622	2020/09/22	2021/09/21
Active Loop Antenna	Beijing Da Ze Technology Co.,Ltd.	ZN30900C	15006	2020/10/11	2021/10/10
Bilog Antenna	Schwarzbeck	VULB9163	000976	2020/05/26	2021/05/25
Broadband Horn Antenna	SCHWARZBECK	BBHA 9170	791	2020/09/19	2021/09/18
Amplifier	Schwarzbeck	BBV 9743	#202	2020/09/19	2021/09/18
Amplifier	Schwarzbeck	BBV9179	9719-025	2020/09/19	2021/09/18
Amplifier	EMCI	EMC051845B	980355	2020/09/19	2021/09/18
Temperature/Humidity Meter	Gangxing	CTH-608	02	2020/09/19	2021/09/18
High-Pass Filter	K&L	9SH10-2700/X12750-O/O	KL142031	2020/09/19	2021/09/18
High-Pass Filter	K&L	41H10-1375/U12750-O/O	KL142032	2020/09/19	2021/09/18
RF Cable(below 1GHz)	HUBER+SUHNER	RG214	RE01	2020/09/19	2021/09/18
RF Cable(above 1GHz)	HUBER+SUHNER	RG214	RE02	2020/09/19	2021/09/18
Data acquisition card	Agilent	U2531A	TW53323507	2020/09/19	2021/09/18
Power Sensor	Agilent	U2021XA	MY5365004	2020/09/19	2021/09/18
Test Control Unit	Tonscend	JS0806-1	178060067	2020/06/20	2021/06/19
Automated filter bank	Tonscend	JS0806-F	19F8060177	2020/06/20	2021/06/19
EMI Test Software	Tonscend	JS1120-1	Ver 2.6.8.0518	/	/
EMI Test Software	Tonscend	JS1120-3	Ver 2.5.77.0418	/	/
EMI Test Software	Tonscend	JS32-CE	Ver 2.5	/	/
EMI Test Software	Tonscend	JS32-RE	Ver 2.5.1.8	/	/

Note: The Cal.Interval was one year.

4. TEST CONDITIONS AND RESULTS

4.1. AC Power Conducted Emission

TEST CONFIGURATION

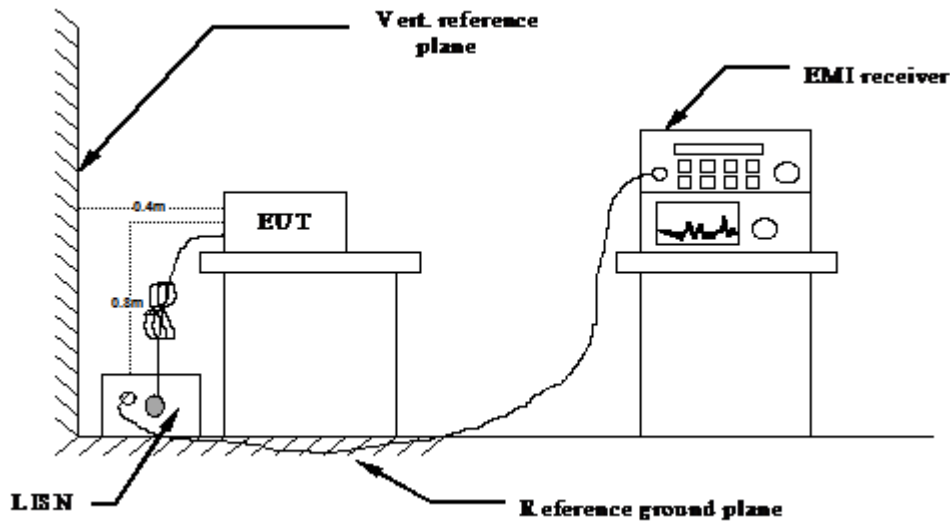

TEST PROCEDURE

- 1 The equipment was set up as per the test configuration to simulate typical actual usage per the user's manual. The EUT is a tabletop system, a wooden table with a height of 0.8 meters is used and is placed on the ground plane as per ANSI C63.10-2013.
- 2 Support equipment, if needed, was placed as per ANSI C63.10-2013
- 3 All I/O cables were positioned to simulate typical actual usage as per ANSI C63.10-2013
- 4 The EUT received DC 12V power from Computer, the PC received AC120V/60Hz and AC 240V/60Hz power through a Line Impedance Stabilization Network (LISN) which supplied power source and was grounded to the ground plane.
- 5 All support equipments received AC power from a second LISN, if any.
- 6 The EUT test program was started. Emissions were measured on each current carrying line of the EUT using a spectrum Analyzer / Receiver connected to the LISN powering the EUT. The LISN has two monitoring points: Line 1 (Hot Side) and Line 2 (Neutral Side). Two scans were taken: one with Line 1 connected to Analyzer / Receiver and Line 2 connected to a 50 ohm load; the second scan had Line 1 connected to a 50 ohm load and Line 2 connected to the Analyzer / Receiver.
- 7 Analyzer / Receiver scanned from 150 KHz to 30MHz for emissions in each of the test modes.
- 8 During the above scans, the emissions were maximized by cable manipulation.

AC Power Conducted Emission Limit

For intentional device, according to § 15.207(a) AC Power Conducted Emission Limits is as following :

Frequency range (MHz)	Limit (dBuV)	
	Quasi-peak	Average
0.15-0.5	66 to 56*	56 to 46*
0.5-5	56	46
5-30	60	50

* Decreases with the logarithm of the frequency.

TEST RESULTS

Remark: We measured Conducted Emission at all mode in AC 120V/60Hz, the worst case was recorded .

Temperature	24.5°C	Humidity	53.7%
Test Engineer	Moon Tan	Configurations	IEEE 802.11ac20 HCH

Power supply:	AC 120V/60Hz	Polarization	L
---------------	--------------	--------------	---

Test Graph

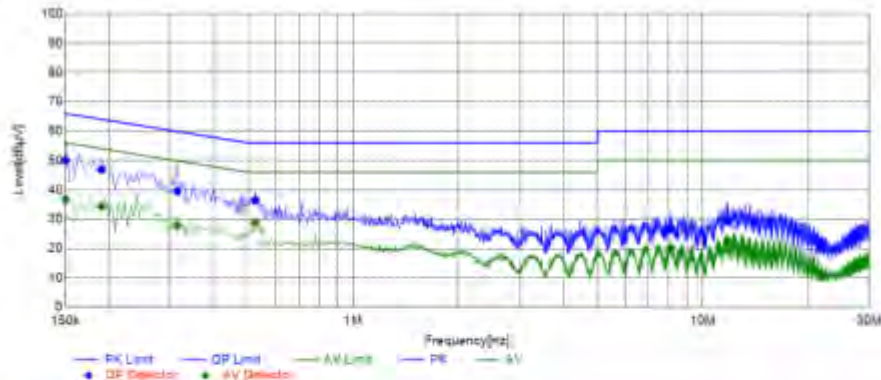

Final Data List

NO.	Frequency (MHz)	QP	AVG	Factor (dB)	QP	AVG	QP	AVG	QP	AVG	Lim	Remark
		Reading (dBµV)	Reading (dBµV)		Result (dBµV)	Result (dBµV)	Limit (dBµV)	Limit (dBµV)	Margin (dB)	Margin (dB)		
1	0.1505	39.89	26.76	10.05	49.94	36.81	65.97	55.97	16.03	19.16	L1	PASS
2	0.1906	36.81	24.45	10.06	46.87	34.51	64.01	54.01	17.14	19.50	L1	PASS
3	0.3136	29.56	17.70	9.98	39.54	27.88	59.88	49.88	20.34	22.20	L1	PASS
4	0.5250	26.23	18.72	10.06	36.29	28.78	56.00	46.00	19.71	17.22	L1	PASS
5	8.0936	15.76	9.50	10.62	26.38	20.12	60.00	50.00	33.62	29.88	L1	PASS
6	11.7526	18.49	11.71	10.82	29.31	22.53	60.00	50.00	30.69	27.47	L1	PASS

Note: 1. Result (dBµV) = Reading (dBµV) + Factor (dB).
 2. Factor (dB) = Cable loss (dB) + LISN Factor (dB).

Power supply:	AC 120V/60Hz	Polarization	N
---------------	--------------	--------------	---

Test Graph

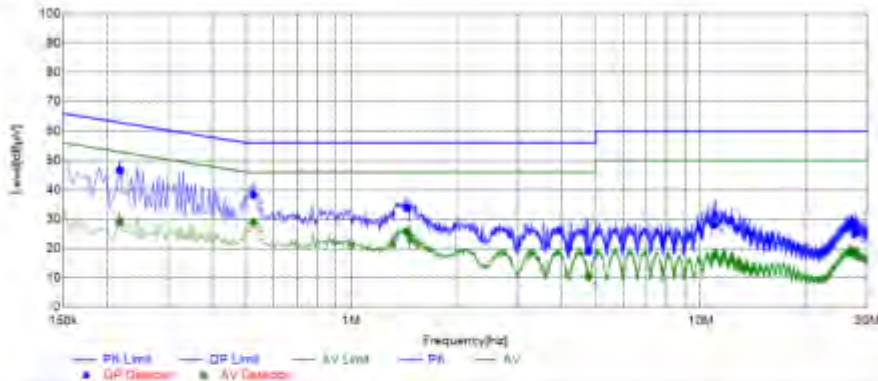

Final Data List

NO.	Frequency (MHz)	QP	AVG	Factor (dB)	QP	AVG	QP	AVG	QP	AVG	Lim	Remark
		Reading (dBµV)	Reading (dBµV)		Result (dBµV)	Result (dBµV)	Limit (dBµV)	Limit (dBµV)	Margin (dB)	Margin (dB)		
1	0.2180	36.57	18.94	10.05	46.62	28.99	62.90	52.90	16.28	23.91	N	PASS
2	0.5258	28.18	18.82	10.06	38.24	28.88	56.00	46.00	17.76	17.12	N	PASS
3	1.4393	23.66	15.65	10.10	33.76	25.75	56.00	46.00	22.24	20.25	N	PASS
4	4.7671	8.50	0.00	10.46	18.96	10.46	56.00	46.00	37.04	35.54	N	PASS
5	10.9273	17.23	6.76	10.78	27.99	17.52	60.00	50.00	32.01	32.48	N	PASS
6	27.5684	13.12	6.99	11.72	24.84	18.71	60.00	50.00	35.16	31.29	N	PASS

Note: 1. Result (dBµV) = Reading (dBµV) + Factor (dB).
 2. Factor (dB) = Cable loss (dB) + LISN Factor (dB).

4.2. Radiated Emission

TEST CONFIGURATION

Frequency range 9 KHz – 30MHz

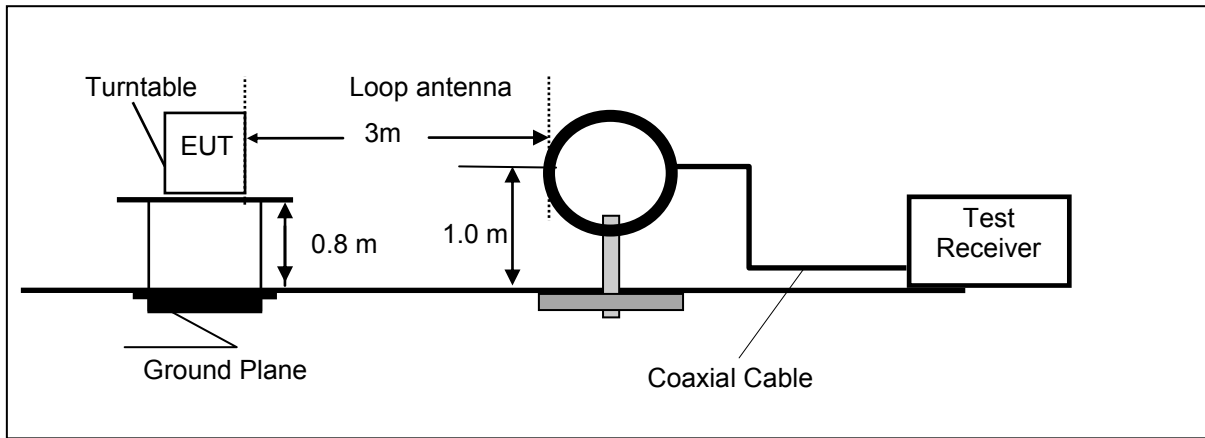

Frequency range 30MHz – 1000MHz

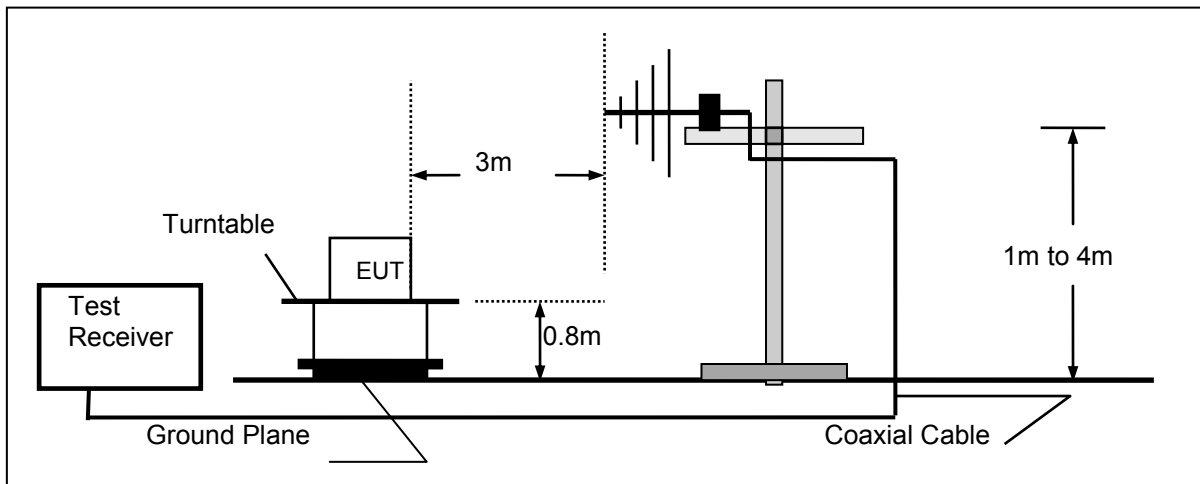

Frequency range above 1GHz

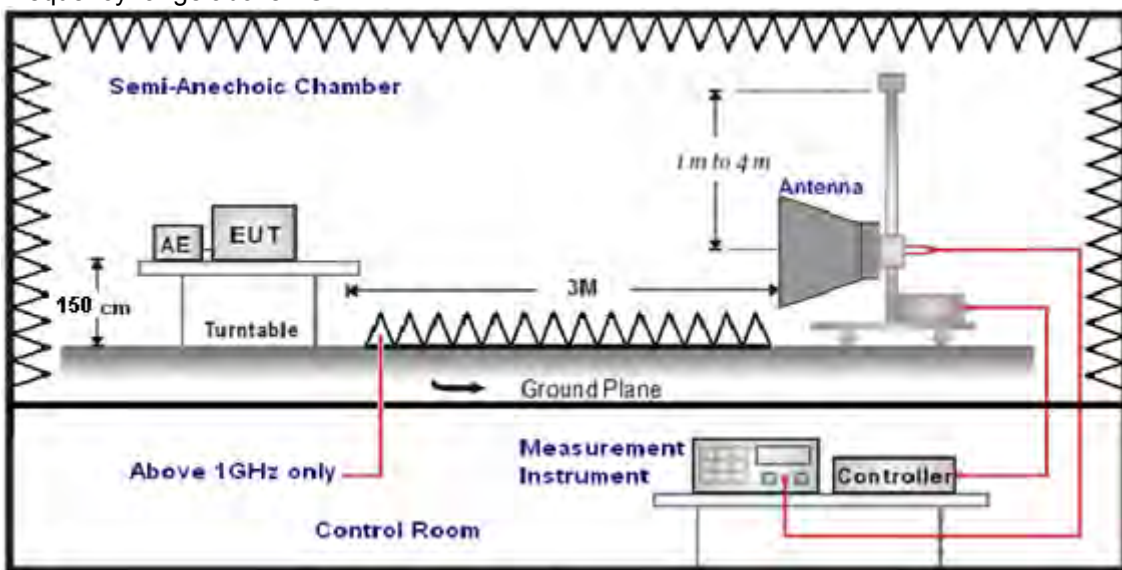

TEST PROCEDURE

1. The EUT was placed on a turn table which is 0.8m above ground plane when testing frequency range 9 KHz –1GHz;the EUT was placed on a turn table which is 1.5m above ground plane when testing above 1GHz.
2. Maximum procedure was performed by raising the receiving antenna from 1m to 4m and rotating the turn table from 0° to 360° to acquire the highest emissions from EUT.
3. And also, each emission was to be maximized by changing the polarization of receiving antenna both horizontal and vertical.
4. Repeat above procedures until all frequency measurements have been completed.
5. The EUT minimum operation frequency was 24MHz and maximum operation frequency was 5825MHz.so radiated emission test frequency band from 9KHz to 40GHz.
6. The distance between test antenna and EUT as following table states:

Test Frequency range	Test Antenna Type	Test Distance
9KHz-30MHz	Active Loop Antenna	3
30MHz-1GHz	Ultra-Broadband Antenna	3
1GHz-18GHz	Double Ridged Horn Antenna	3
18GHz-25GHz	Horn Antenna	1

7. Setting test receiver/spectrum as following table states:

Test Frequency range	Test Receiver/Spectrum Setting	Detector
9KHz-150KHz	RBW=200Hz/VBW=3KHz, Sweep time=Auto	QP
150KHz-30MHz	RBW=9KHz/VBW=100KHz, Sweep time=Auto	QP
30MHz-1GHz	RBW=120KHz/VBW=1000KHz, Sweep time=Auto	QP
1GHz-40GHz	Peak Value: RBW=1MHz/VBW=3MHz, Sweep time=Auto Average Value: RBW=1MHz/VBW=10Hz, Sweep time=Auto	Peak

Field Strength Calculation

The field strength is calculated by adding the Antenna Factor and Cable Factor and subtracting the Amplifier Gain and Duty Cycle Correction Factor(if any) from the measured reading. The basic equation with a sample calculation is as follows:

FS = RA + AF + CL - AG

Where FS = Field Strength	CL = Cable Attenuation Factor (Cable Loss)
RA = Reading Amplitude	AG = Amplifier Gain
AF = Antenna Factor	

Transd=AF +CL-AG

RADIATION LIMIT

According to §15.407 (b): Except as shown in paragraph (b)(7) of this section, the maximum emissions outside of the frequency bands of operation shall be attenuated in accordance with the following limits

Frequency (MHz)	EIRP Limit (dBm)	Equivalent Field Strength at 3m (dBµV/m)
5150-5250	-27	68.2
5250-5350	-27	68.2
5470-5725	-27	68.2
5725-5850	-27 (beyond 10MHz of the bandedge)	68.2
	-17 (within 10 MHz of band edge)	78.2

Frequency (MHz)	Distance (Meters)	Radiated (dBµV/m)	Radiated (µV/m)
0.009-0.49	3	20log(2400/F(KHz))+40log(300/3)	2400/F(KHz)
0.49-1.705	3	20log(24000/F(KHz))+ 40log(30/3)	24000/F(KHz)
1.705-30	3	20log(30)+ 40log(30/3)	30
30-88	3	40.0	100
88-216	3	43.5	150
216-960	3	46.0	200
Above 960	3	54.0	500

TEST RESULTS

Remark: We measured Radiated Emission at all mode from 30MHz to 25GHz in AC 120V/60Hz and the worst case was recorded.

Temperature	23.4°C	Humidity	54.5%
Test Engineer	Moon Tan	Configurations	IEEE 802.11ac20 HCH

For 30MHz-1GHz

Horizontal

Test Graph

Suspected List

NO	Frequency [MHz]	Reading [dBuV/m]	Factor [dB]	Result [dBuV/m]	Limit [dBuV/m]	Margin [dB]	Height [cm]	Angle [°]	Detector	Polarity	Remark
1	69.2850	39.09	-10.06	29.03	40.00	10.97	100	342	PK	Horizontal	PASS
2	196.7800	40.91	-9.12	31.79	43.50	11.71	100	172	PK	Horizontal	PASS
3	249.7050	49.05	-8.38	40.67	46.00	5.33	100	36	PK	Horizontal	PASS
4	323.9100	39.18	-7.00	32.18	46.00	13.82	100	162	PK	Horizontal	PASS
5	400.0550	39.68	-5.12	34.56	46.00	11.44	100	192	PK	Horizontal	PASS
6	810.8500	34.44	1.75	36.19	46.00	9.81	100	202	PK	Horizontal	PASS

Note:1. Result (dBuV/m) = Reading(dBuV/m) + Factor (dB) .
 2. Factor (dB) = Antenna Factor (dB/m) + Cable loss (dB) - Pre Amplifier gain (dB),

Vertical

Test Graph

Suspected List

NO	Frequency [MHz]	Reading [dBuV/m]	Factor [dB]	Result [dBuV/m]	Limit [dBuV/m]	Margin [dB]	Height [cm]	Angle [°]	Detector	Polarity	Remark
1	45.0350	37.63	-6.51	31.12	40.00	8.88	100	276	PK	Vertical	PASS
2	67.8300	41.13	-9.41	31.72	40.00	8.28	100	283	PK	Vertical	PASS
3	97.4150	40.50	-8.85	31.65	43.50	11.85	100	323	PK	Vertical	PASS
4	153.1900	39.44	-12.35	27.09	43.50	16.41	100	358	PK	Vertical	PASS
5	249.7050	43.90	-8.38	35.52	46.00	10.48	100	358	PK	Vertical	PASS
6	450.4950	32.72	-4.58	28.14	46.00	17.86	100	358	PK	Vertical	PASS

Note:1. Result (dBuV/m) = Reading(dBuV/m) + Factor (dB) .
 2. Factor (dB) = Antenna Factor (dB/m) + Cable loss (dB) - Pre Amplifier gain (dB),

For 1GHz to 40GHz
5150-5250MHz:

802.11a Mode Channel 36 5180 MHz

Item (Mark)	Freq (MHz)	Read Level (dB μ V)	Antenna Factor (dB/m)	PRM Factor dB	Cable Loss (dB)	Result Level (dB μ V/m)	Limit Line (dB μ V/m)	Margin (dB)	Detector	Polarization
1	10360	39.13	38.55	33.13	11.26	55.81	68.20	-12.39	Peak	Horizontal
1	10360	30.72	38.55	33.13	11.26	47.40	54.00	-6.60	AV	Horizontal
1	10360	40.06	38.55	33.13	11.26	56.74	68.20	-11.46	Peak	Vertical
1	10360	29.74	38.55	33.13	11.26	46.42	54.00	-7.58	AV	Vertical

802.11a Mode Channel 40 5200 MHz

Item (Mark)	Freq (MHz)	Read Level (dB μ V)	Antenna Factor (dB/m)	PRM Factor dB	Cable Loss (dB)	Result Level (dB μ V/m)	Limit Line (dB μ V/m)	Margin (dB)	Detector	Polarization
1	10400	39.19	38.55	33.13	11.26	55.87	68.20	-12.33	Peak	Horizontal
1	10400	30.21	38.55	33.13	11.26	46.89	54.00	-7.11	AV	Horizontal
1	10400	41.41	38.55	33.13	11.26	58.09	68.20	-10.11	Peak	Vertical
1	10400	28.59	38.55	33.13	11.26	45.27	54.00	-8.73	AV	Vertical

802.11a Mode Channel 48 5240 MHz

Item (Mark)	Freq (MHz)	Read Level (dB μ V)	Antenna Factor (dB/m)	PRM Factor dB	Cable Loss (dB)	Result Level (dB μ V/m)	Limit Line (dB μ V/m)	Margin (dB)	Detector	Polarization
1	10480	39.29	38.55	33.13	11.26	55.97	68.20	-12.23	Peak	Horizontal
1	10480	31.24	38.55	33.13	11.26	47.92	54.00	-6.08	AV	Horizontal
1	10480	41.00	38.55	33.13	11.26	57.68	68.20	-10.52	Peak	Vertical
1	10480	28.09	38.55	33.13	11.26	44.77	54.00	-9.23	AV	Vertical

802.11n20 Mode Channel 36 5180 MHz

Item (Mark)	Freq (MHz)	Read Level (dB μ V)	Antenna Factor (dB/m)	PRM Factor dB	Cable Loss (dB)	Result Level (dB μ V/m)	Limit Line (dB μ V/m)	Margin (dB)	Detector	Polarization
1	10360	39.19	38.55	33.13	11.26	55.87	68.20	-12.33	Peak	Horizontal
1	10360	31.49	38.55	33.13	11.26	48.17	54.00	-5.83	AV	Horizontal
1	10360	40.67	38.55	33.13	11.26	57.35	68.20	-10.85	Peak	Vertical
1	10360	29.31	38.55	33.13	11.26	45.99	54.00	-8.01	AV	Vertical

802.11n20 Mode Channel 40 5200 MHz

Item (Mark)	Freq (MHz)	Read Level (dB μ V)	Antenna Factor (dB/m)	PRM Factor dB	Cable Loss (dB)	Result Level (dB μ V/m)	Limit Line (dB μ V/m)	Margin (dB)	Detector	Polarization
1	10400	39.38	38.55	33.13	11.26	56.06	68.20	-12.14	Peak	Horizontal
1	10400	30.57	38.55	33.13	11.26	47.25	54.00	-6.75	AV	Horizontal
1	10400	41.89	38.55	33.13	11.26	58.57	68.20	-9.63	Peak	Vertical
1	10400	28.20	38.55	33.13	11.26	44.88	54.00	-9.12	AV	Vertical

802.11n20 Mode Channel 48 5240 MHz

Item (Mark)	Freq (MHz)	Read Level (dB μ V)	Antenna Factor (dB/m)	PRM Factor dB	Cable Loss (dB)	Result Level (dB μ V/m)	Limit Line (dB μ V/m)	Margin (dB)	Detector	Polarization
1	10480	40.93	38.55	33.13	11.26	57.61	68.20	-10.59	Peak	Horizontal
1	10480	31.94	38.55	33.13	11.26	48.62	54.00	-5.38	AV	Horizontal
1	10480	41.03	38.55	33.13	11.26	57.71	68.20	-10.49	Peak	Vertical
1	10480	28.10	38.55	33.13	11.26	44.78	54.00	-9.22	AV	Vertical

802.11n40 Mode Channel 38 5190 MHz

Item (Mark)	Freq (MHz)	Read Level (dB μ V)	Antenna Factor (dB/m)	PRM Factor dB	Cable Loss (dB)	Result Level (dB μ V/m)	Limit Line (dB μ V/m)	Margin (dB)	Detector	Polarization
1	10380	39.74	38.55	33.13	11.26	56.42	68.20	-11.78	Peak	Horizontal
1	10380	30.21	38.55	33.13	11.26	46.89	54.00	-7.11	AV	Horizontal
1	10380	40.71	38.55	33.13	11.26	57.39	68.20	-10.81	Peak	Vertical
1	10380	28.72	38.55	33.13	11.26	45.40	54.00	-8.60	AV	Vertical

802.11n40 Mode Channel 46 5230 MHz

Item (Mark)	Freq (MHz)	Read Level (dB μ V)	Antenna Factor (dB/m)	PRM Factor dB	Cable Loss (dB)	Result Level (dB μ V/m)	Limit Line (dB μ V/m)	Margin (dB)	Detector	Polarization
1	10460	40.51	38.55	33.13	11.26	57.19	68.20	-11.01	Peak	Horizontal
1	10460	31.80	38.55	33.13	11.26	48.48	54.00	-5.52	AV	Horizontal
1	10460	40.96	38.55	33.13	11.26	57.64	68.20	-10.56	Peak	Vertical
1	10460	29.32	38.55	33.13	11.26	46.00	54.00	-8.00	AV	Vertical

802.11ac20 Mode Channel 36 5180 MHz

Item (Mark)	Freq (MHz)	Read Level (dB μ V)	Antenna Factor (dB/m)	PRM Factor dB	Cable Loss (dB)	Result Level (dB μ V/m)	Limit Line (dB μ V/m)	Margin (dB)	Detector	Polarization
1	10360	39.39	38.55	33.13	11.26	56.07	68.20	-12.13	Peak	Horizontal
1	10360	31.74	38.55	33.13	11.26	48.42	54.00	-5.58	AV	Horizontal
1	10360	41.66	38.55	33.13	11.26	58.34	68.20	-9.86	Peak	Vertical
1	10360	29.63	38.55	33.13	11.26	46.31	54.00	-7.69	AV	Vertical

802.11ac20 Mode Channel 40 5200 MHz

Item (Mark)	Freq (MHz)	Read Level (dB μ V)	Antenna Factor (dB/m)	PRM Factor dB	Cable Loss (dB)	Result Level (dB μ V/m)	Limit Line (dB μ V/m)	Margin (dB)	Detector	Polarization
1	10400	40.27	38.55	33.13	11.26	56.95	68.20	-11.25	Peak	Horizontal
1	10400	30.77	38.55	33.13	11.26	47.45	54.00	-6.55	AV	Horizontal
1	10400	40.35	38.55	33.13	11.26	57.03	68.20	-11.17	Peak	Vertical
1	10400	28.30	38.55	33.13	11.26	44.98	54.00	-9.02	AV	Vertical

802.11ac20 Mode Channel 48 5240 MHz

Item (Mark)	Freq (MHz)	Read Level (dB μ V)	Antenna Factor (dB/m)	PRM Factor dB	Cable Loss (dB)	Result Level (dB μ V/m)	Limit Line (dB μ V/m)	Margin (dB)	Detector	Polarization
1	10480	39.99	38.55	33.13	11.26	56.67	68.20	-11.53	Peak	Horizontal
1	10480	31.13	38.55	33.13	11.26	47.81	54.00	-6.19	AV	Horizontal
1	10480	40.90	38.55	33.13	11.26	57.58	68.20	-10.62	Peak	Vertical
1	10480	29.47	38.55	33.13	11.26	46.15	54.00	-7.85	AV	Vertical

802.11ac40 Mode Channel 38 5190 MHz

Item (Mark)	Freq (MHz)	Read Level (dB μ V)	Antenna Factor (dB/m)	PRM Factor dB	Cable Loss (dB)	Result Level (dB μ V/m)	Limit Line (dB μ V/m)	Margin (dB)	Detector	Polarization
1	10380	39.66	38.55	33.13	11.26	56.34	68.20	-11.86	Peak	Horizontal
1	10380	31.02	38.55	33.13	11.26	47.70	54.00	-6.30	AV	Horizontal
1	10380	40.46	38.55	33.13	11.26	57.14	68.20	-11.06	Peak	Vertical
1	10380	28.88	38.55	33.13	11.26	45.56	54.00	-8.44	AV	Vertical

802.11ac40 Mode Channel 46 5230 MHz

Item (Mark)	Freq (MHz)	Read Level (dB μ V)	Antenna Factor (dB/m)	PRM Factor dB	Cable Loss (dB)	Result Level (dB μ V/m)	Limit Line (dB μ V/m)	Margin (dB)	Detector	Polarization
1	10460	39.89	38.55	33.13	11.26	56.57	68.20	-11.63	Peak	Horizontal
1	10460	30.20	38.55	33.13	11.26	46.88	54.00	-7.12	AV	Horizontal
1	10460	41.40	38.55	33.13	11.26	58.08	68.20	-10.12	Peak	Vertical
1	10460	28.98	38.55	33.13	11.26	45.66	54.00	-8.34	AV	Vertical

802.11ac80 Mode Channel 42 5210 MHz

Item (Mark)	Freq (MHz)	Read Level (dB μ V)	Antenna Factor (dB/m)	PRM Factor dB	Cable Loss (dB)	Result Level (dB μ V/m)	Limit Line (dB μ V/m)	Margin (dB)	Detector	Polarization
1	10420	40.29	38.55	33.13	11.26	56.97	68.20	-11.23	Peak	Horizontal
1	10420	31.10	38.55	33.13	11.26	47.78	54.00	-6.22	AV	Horizontal
1	10420	40.76	38.55	33.13	11.26	57.44	68.20	-10.76	Peak	Vertical
1	10420	28.57	38.55	33.13	11.26	45.25	54.00	-8.75	AV	Vertical

5725-5850MHz:**802.11a Mode Channel 149 5745 MHz**

Item (Mark)	Freq (MHz)	Read Level (dB μ V)	Antenna Factor (dB/m)	PRM Factor dB	Cable Loss (dB)	Result Level (dB μ V/m)	Limit Line (dB μ V/m)	Margin (dB)	Detector	Polarization
1	11490	40.37	38.55	33.13	11.26	57.05	68.20	-11.15	Peak	Horizontal
1	11490	30.92	38.55	33.13	11.26	47.60	54.00	-6.40	AV	Horizontal
1	11490	40.89	38.55	33.13	11.26	57.57	68.20	-10.63	Peak	Vertical
1	11490	28.68	38.55	33.13	11.26	45.36	54.00	-8.64	AV	Vertical

802.11a Mode Channel 157 5785 MHz

Item (Mark)	Freq (MHz)	Read Level (dB μ V)	Antenna Factor (dB/m)	PRM Factor dB	Cable Loss (dB)	Result Level (dB μ V/m)	Limit Line (dB μ V/m)	Margin (dB)	Detector	Polarization
1	11570	40.18	38.55	33.13	11.26	56.86	68.20	-11.34	Peak	Horizontal
1	11570	30.73	38.55	33.13	11.26	47.41	54.00	-6.59	AV	Horizontal
1	11570	40.91	38.55	33.13	11.26	57.59	68.20	-10.61	Peak	Vertical
1	11570	28.88	38.55	33.13	11.26	45.56	54.00	-8.44	AV	Vertical

802.11a Mode Channel 165 5825 MHz

Item (Mark)	Freq (MHz)	Read Level (dB μ V)	Antenna Factor (dB/m)	PRM Factor dB	Cable Loss (dB)	Result Level (dB μ V/m)	Limit Line (dB μ V/m)	Margin (dB)	Detector	Polarization
1	11650	40.77	38.55	33.13	11.26	57.45	68.20	-10.75	Peak	Horizontal
1	11650	31.65	38.55	33.13	11.26	48.33	54.00	-5.67	AV	Horizontal
1	11650	40.24	38.55	33.13	11.26	56.92	68.20	-11.28	Peak	Vertical
1	11650	28.42	38.55	33.13	11.26	45.10	54.00	-8.90	AV	Vertical

802.11n20 Mode Channel 149 5745 MHz

Item (Mark)	Freq (MHz)	Read Level (dB μ V)	Antenna Factor (dB/m)	PRM Factor dB	Cable Loss (dB)	Result Level (dB μ V/m)	Limit Line (dB μ V/m)	Margin (dB)	Detector	Polarization
1	11490	39.81	38.55	33.13	11.26	56.49	68.20	-11.71	Peak	Horizontal
1	11490	30.72	38.55	33.13	11.26	47.40	54.00	-6.60	AV	Horizontal
1	11490	41.36	38.55	33.13	11.26	58.04	68.20	-10.16	Peak	Vertical
1	11490	29.35	38.55	33.13	11.26	46.03	54.00	-7.97	AV	Vertical

802.11n20 Mode Channel 157_ 5785 MHz

Item (Mark)	Freq (MHz)	Read Level (dBμV)	Antenna Factor (dB/m)	PRM Factor dB	Cable Loss (dB)	Result Level (dBμV/m)	Limit Line (dBμV/m)	Margin (dB)	Detector	Polarization
1	11570	39.75	38.55	33.13	11.26	56.43	68.20	-11.77	Peak	Horizontal
1	11570	31.39	38.55	33.13	11.26	48.07	54.00	-5.93	AV	Horizontal
1	11570	41.74	38.55	33.13	11.26	58.42	68.20	-9.78	Peak	Vertical
1	11570	29.33	38.55	33.13	11.26	46.01	54.00	-7.99	AV	Vertical

802.11n20 Mode Channel 165_ 5825 MHz

Item (Mark)	Freq (MHz)	Read Level (dBμV)	Antenna Factor (dB/m)	PRM Factor dB	Cable Loss (dB)	Result Level (dBμV/m)	Limit Line (dBμV/m)	Margin (dB)	Detector	Polarization
1	11650	39.20	38.55	33.13	11.26	55.88	68.20	-12.32	Peak	Horizontal
1	11650	30.47	38.55	33.13	11.26	47.15	54.00	-6.85	AV	Horizontal
1	11650	41.97	38.55	33.13	11.26	58.65	68.20	-9.55	Peak	Vertical
1	11650	28.61	38.55	33.13	11.26	45.29	54.00	-8.71	AV	Vertical

802.11n40 Mode Channel 151_ 5755 MHz

Item (Mark)	Freq (MHz)	Read Level (dBμV)	Antenna Factor (dB/m)	PRM Factor dB	Cable Loss (dB)	Result Level (dBμV/m)	Limit Line (dBμV/m)	Margin (dB)	Detector	Polarization
1	11510	40.61	38.55	33.13	11.26	57.29	68.20	-10.91	Peak	Horizontal
1	11510	31.29	38.55	33.13	11.26	47.97	54.00	-6.03	AV	Horizontal
1	11510	41.43	38.55	33.13	11.26	58.11	68.20	-10.09	Peak	Vertical
1	11510	28.89	38.55	33.13	11.26	45.57	54.00	-8.43	AV	Vertical

802.11n40 Mode Channel 159_ 5795MHz

Item (Mark)	Freq (MHz)	Read Level (dBμV)	Antenna Factor (dB/m)	PRM Factor dB	Cable Loss (dB)	Result Level (dBμV/m)	Limit Line (dBμV/m)	Margin (dB)	Detector	Polarization
1	11590	39.78	38.55	33.13	11.26	56.46	68.20	-11.74	Peak	Horizontal
1	11590	31.67	38.55	33.13	11.26	48.35	54.00	-5.65	AV	Horizontal
1	11590	41.66	38.55	33.13	11.26	58.34	68.20	-9.86	Peak	Vertical
1	11590	29.99	38.55	33.13	11.26	46.67	54.00	-7.33	AV	Vertical

802.11ac20 Mode Channel 149_ 5745 MHz

Item (Mark)	Freq (MHz)	Read Level (dBμV)	Antenna Factor (dB/m)	PRM Factor dB	Cable Loss (dB)	Result Level (dBμV/m)	Limit Line (dBμV/m)	Margin (dB)	Detector	Polarization
1	11490	39.58	38.55	33.13	11.26	56.26	68.20	-11.94	Peak	Horizontal
1	11490	31.35	38.55	33.13	11.26	48.03	54.00	-5.97	AV	Horizontal
1	11490	40.64	38.55	33.13	11.26	57.32	68.20	-10.88	Peak	Vertical
1	11490	28.56	38.55	33.13	11.26	45.24	54.00	-8.76	AV	Vertical

802.11ac20 Mode Channel 157_ 5785 MHz

Item (Mark)	Freq (MHz)	Read Level (dBμV)	Antenna Factor (dB/m)	PRM Factor dB	Cable Loss (dB)	Result Level (dBμV/m)	Limit Line (dBμV/m)	Margin (dB)	Detector	Polarization
1	11570	40.13	38.55	33.13	11.26	56.81	68.20	-11.39	Peak	Horizontal
1	11570	30.34	38.55	33.13	11.26	47.02	54.00	-6.98	AV	Horizontal
1	11570	41.74	38.55	33.13	11.26	58.42	68.20	-9.78	Peak	Vertical
1	11570	28.51	38.55	33.13	11.26	45.19	54.00	-8.81	AV	Vertical

802.11ac20 Mode Channel 165_ 5825 MHz

Item (Mark)	Freq (MHz)	Read Level (dBμV)	Antenna Factor (dB/m)	PRM Factor dB	Cable Loss (dB)	Result Level (dBμV/m)	Limit Line (dBμV/m)	Margin (dB)	Detector	Polarization
1	11650	40.48	38.55	33.13	11.26	57.16	68.20	-11.04	Peak	Horizontal
1	11650	30.98	38.55	33.13	11.26	47.66	54.00	-6.34	AV	Horizontal
1	11650	41.75	38.55	33.13	11.26	58.43	68.20	-9.77	Peak	Vertical
1	11650	29.32	38.55	33.13	11.26	46.00	54.00	-8.00	AV	Vertical

802.11ac40 Mode Channel 151 _ 5755 MHz

Item (Mark)	Freq (MHz)	Read Level (dB μ V)	Antenna Factor (dB/m)	PRM Factor dB	Cable Loss (dB)	Result Level (dB μ V/m)	Limit Line (dB μ V/m)	Margin (dB)	Detector	Polarization
1	11510	40.70	38.55	33.13	11.26	57.38	68.20	-10.82	Peak	Horizontal
1	11510	30.30	38.55	33.13	11.26	46.98	54.00	-7.02	AV	Horizontal
1	11510	40.64	38.55	33.13	11.26	57.32	68.20	-10.88	Peak	Vertical
1	11510	29.19	38.55	33.13	11.26	45.87	54.00	-8.13	AV	Vertical

802.11ac40 Mode Channel 159 _ 5795MHz

Item (Mark)	Freq (MHz)	Read Level (dB μ V)	Antenna Factor (dB/m)	PRM Factor dB	Cable Loss (dB)	Result Level (dB μ V/m)	Limit Line (dB μ V/m)	Margin (dB)	Detector	Polarization
1	11590	39.09	38.55	33.13	11.26	55.77	68.20	-12.43	Peak	Horizontal
1	11590	31.32	38.55	33.13	11.26	48.00	54.00	-6.00	AV	Horizontal
1	11590	40.17	38.55	33.13	11.26	56.85	68.20	-11.35	Peak	Vertical
1	11590	28.61	38.55	33.13	11.26	45.29	54.00	-8.71	AV	Vertical

802.11ac80 Mode Channel 155 _ 5775 MHz

Item (Mark)	Freq (MHz)	Read Level (dB μ V)	Antenna Factor (dB/m)	PRM Factor dB	Cable Loss (dB)	Result Level (dB μ V/m)	Limit Line (dB μ V/m)	Margin (dB)	Detector	Polarization
1	11550	39.32	38.55	33.13	11.26	56.00	68.20	-12.20	Peak	Horizontal
1	11550	30.70	38.55	33.13	11.26	47.38	54.00	-6.62	AV	Horizontal
1	11550	40.00	38.55	33.13	11.26	56.68	68.20	-11.52	Peak	Vertical
1	11550	28.20	38.55	33.13	11.26	44.88	54.00	-9.12	AV	Vertical

REMARKS:

1. Result Level = Read Level + Antenna Factor + Cable loss - PRM Factor.
2. Margin = Result Level - Limit
3. The other emission levels were very low against the limit.
4. Detector AV is setting spectrum/receiver. RBW=1MHz/VBW=10Hz/Sweep time=Auto/Detector=Peak;

NOTE: All the modes have been tested and recorded worst mode in the report.(2*2MIMO)

4.3. Duty Cycle

TEST CONFIGURATION

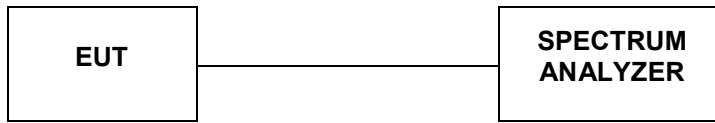

TEST PROCEDURE

According to KDB789033 D02 General U-NII Test Procedures New Rules v02r01 Duty Cycle (x), Transmission Duration (T):

- A diode detector and an oscilloscope that together have sufficiently short response time to permit accurate measurements of the on and off times of the transmitted signal
- The zero-span mode on a spectrum analyzer or EMI receiver, if the response time and spacing between bins on the sweep are sufficient to permit accurate measurements of the on and off times of the transmitted signal. Set the center frequency of the instrument to the center frequency of the transmission. Set $RBW \geq EBW$ if possible; otherwise, set RBW to the largest available value. Set $VBW \geq RBW$. Set detector = peak or average. The zerospan measurement method shall not be used unless both RBW and VBW are $> 50/T$, where T is defined in section II.B.1.a), and the number of sweep points across duration T exceeds 100. (For example, if VBW and/or RBW are limited to 3 MHz, then the zero-span method of measuring duty cycle shall not be used if $T \leq 16.7$ microseconds.)

TEST RESULTS

Temperature	23.6°C	Humidity	55.7%
Test Engineer	Moon Tan	Configurations	IEEE 802.11a/n/ac

Antenna 0:
5150-5250MHz:

802.11a Test Mode

Channel	Frequency (MHz)	Duty Cycle	Duty factor (dB)
40	5200	0.97	0.13

802.11n HT20 Test Mode

Channel	Frequency (MHz)	Duty Cycle	Duty factor (dB)
40	5200	0.97	0.13

802.11ac20 Test Mode

Channel	Frequency (MHz)	Duty Cycle	Duty factor (dB)
40	5200	0.95	0.22

802.11n HT40 Test Mode

Channel	Frequency (MHz)	Duty Cycle	Duty factor (dB)
38	5190	0.95	0.22

802.11ac40 Test Mode

Channel	Frequency (MHz)	Duty Cycle	Duty factor (dB)
38	5190	0.90	0.46

802.11ac80 Test Mode

Channel	Frequency (MHz)	Duty Cycle	Duty factor (dB)
42	5210	0.83	0.81

5725-5850MHz:**802.11a Test Mode**

Channel	Frequency (MHz)	Duty Cycle	Duty factor (dB)
157	5785	0.97	0.13

802.11n HT20 Test Mode

Channel	Frequency (MHz)	Duty Cycle	Duty factor (dB)
157	5785	0.97	0.13

802.11ac20 Test Mode

Channel	Frequency (MHz)	Duty Cycle	Duty factor (dB)
157	5785	0.95	0.22

802.11n HT40 Test Mode

Channel	Frequency (MHz)	Duty Cycle	Duty factor (dB)
151	5755	0.94	0.27

802.11ac40 Test Mode

Channel	Frequency (MHz)	Duty Cycle	Duty factor (dB)
151	5755	0.90	0.46

802.11ac80 Test Mode

Channel	Frequency (MHz)	Duty Cycle	Duty factor (dB)
155	5775	0.83	0.81

Antenna 1:**5150-5250MHz:****802.11a Test Mode**

Channel	Frequency (MHz)	Duty Cycle	Duty factor (dB)
40	5200	0.97	0.13

802.11n HT20 Test Mode

Channel	Frequency (MHz)	Duty Cycle	Duty factor (dB)
40	5200	0.97	0.13

802.11ac20 Test Mode

Channel	Frequency (MHz)	Duty Cycle	Duty factor (dB)
40	5200	0.95	0.22

802.11n HT40 Test Mode

Channel	Frequency (MHz)	Duty Cycle	Duty factor (dB)
38	5190	0.94	0.27

802.11ac40 Test Mode

Channel	Frequency (MHz)	Duty Cycle	Duty factor (dB)
38	5190	0.90	0.46

802.11ac80 Test Mode

Channel	Frequency (MHz)	Duty Cycle	Duty factor (dB)
42	5210	0.83	0.81

5725-5850MHz:

802.11a Test Mode

Channel	Frequency (MHz)	Duty Cycle	Duty factor (dB)
157	5785	0.97	0.13

802.11n HT20 Test Mode

Channel	Frequency (MHz)	Duty Cycle	Duty factor (dB)
157	5785	0.97	0.13

802.11ac20 Test Mode

Channel	Frequency (MHz)	Duty Cycle	Duty factor (dB)
157	5785	0.95	0.22

802.11n HT40 Test Mode

Channel	Frequency (MHz)	Duty Cycle	Duty factor (dB)
151	5755	0.95	0.22

802.11ac40 Test Mode

Channel	Frequency (MHz)	Duty Cycle	Duty factor (dB)
151	5755	0.90	0.46

802.11ac80 Test Mode

Channel	Frequency (MHz)	Duty Cycle	Duty factor (dB)
155	5775	0.83	0.81

Antenna 0:
5150-5250MHz:

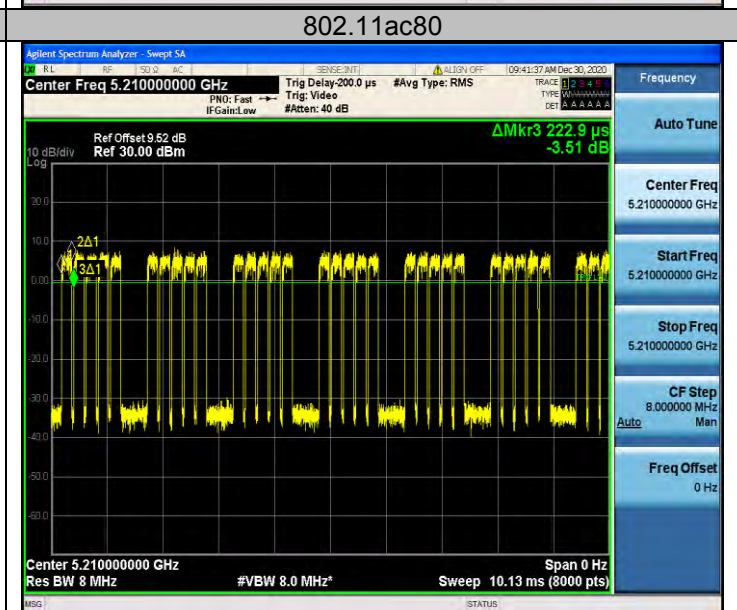
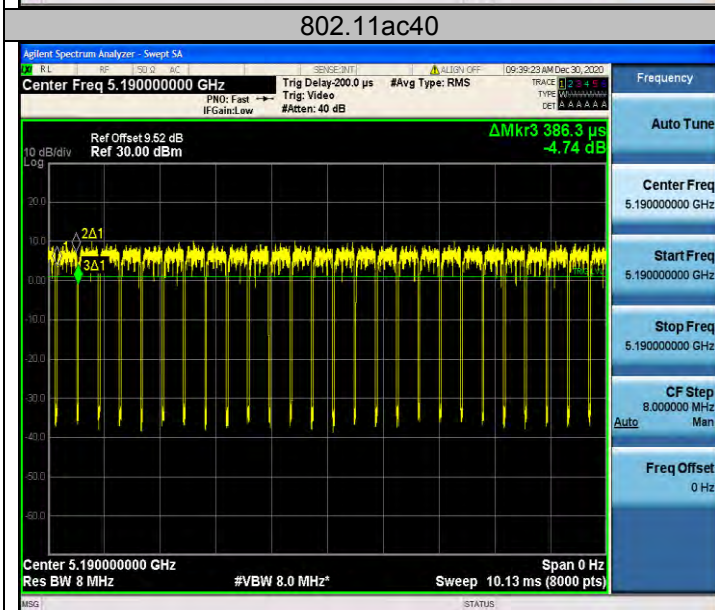
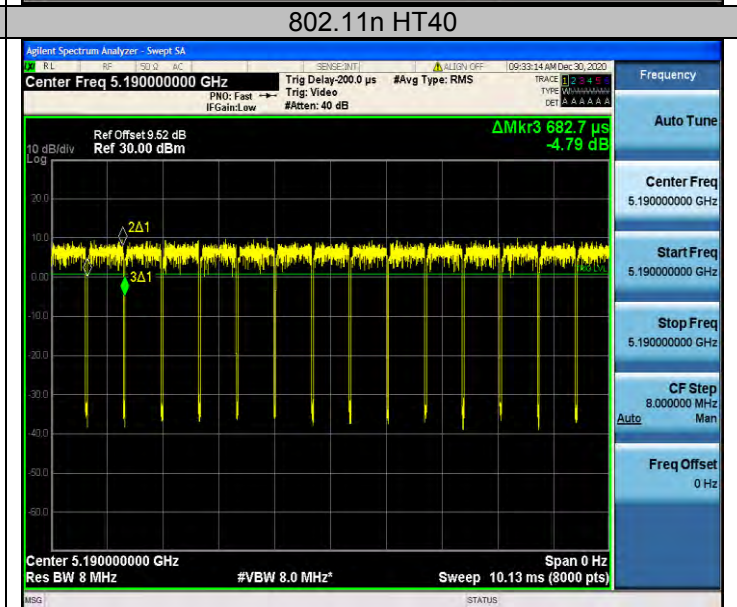
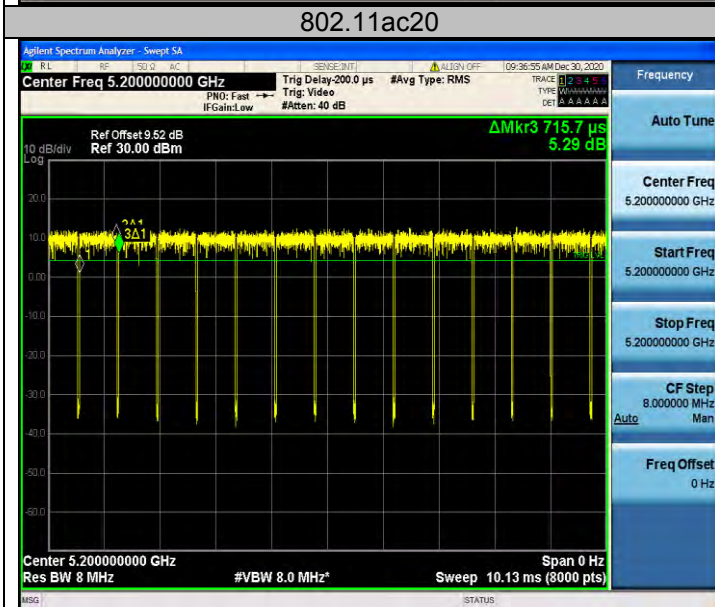
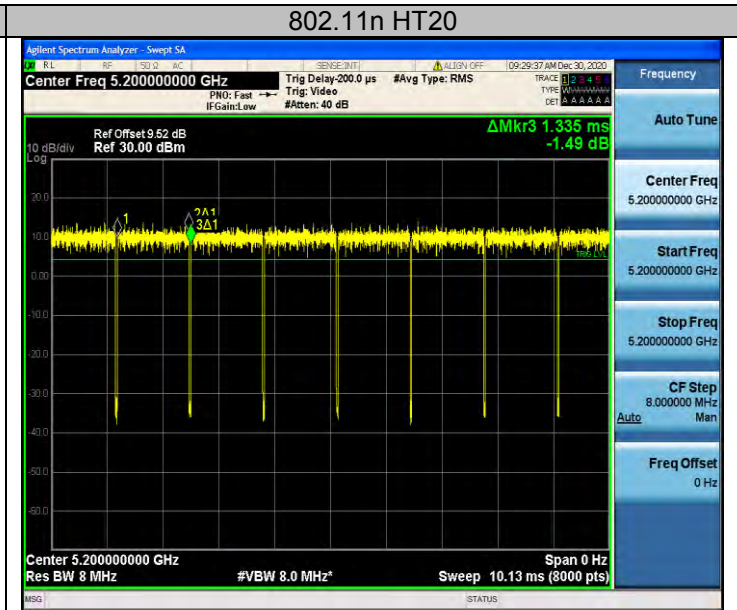
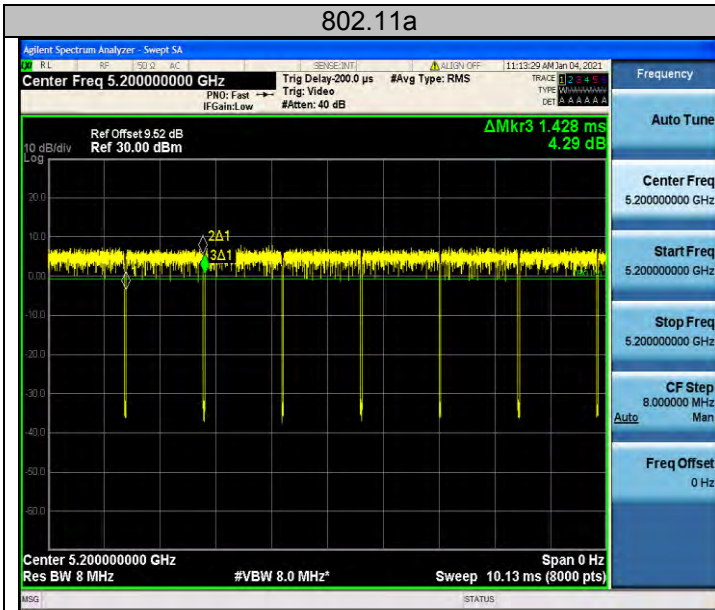

5725-5850MHz:

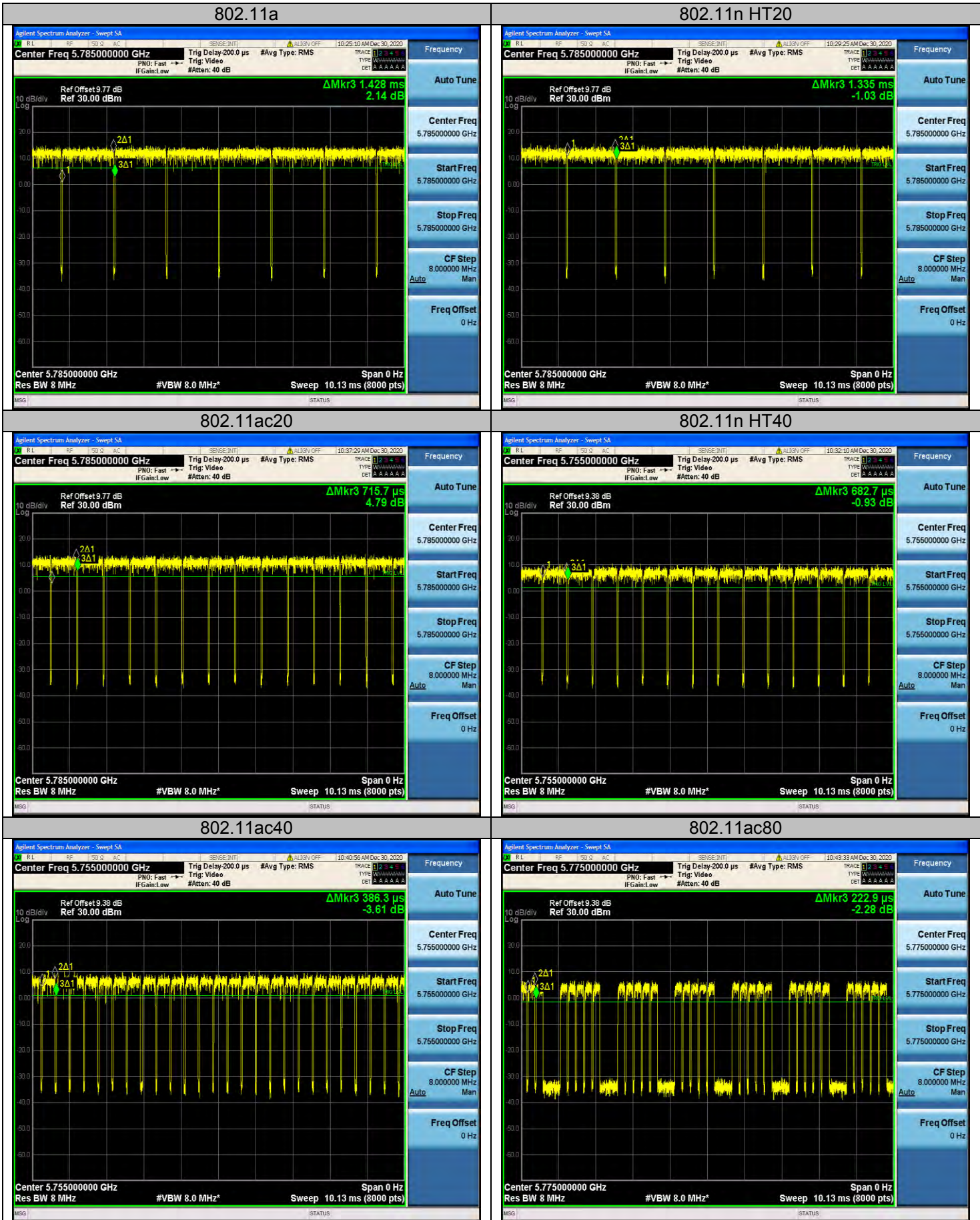

Antenna 1:
1510-5250MHz:

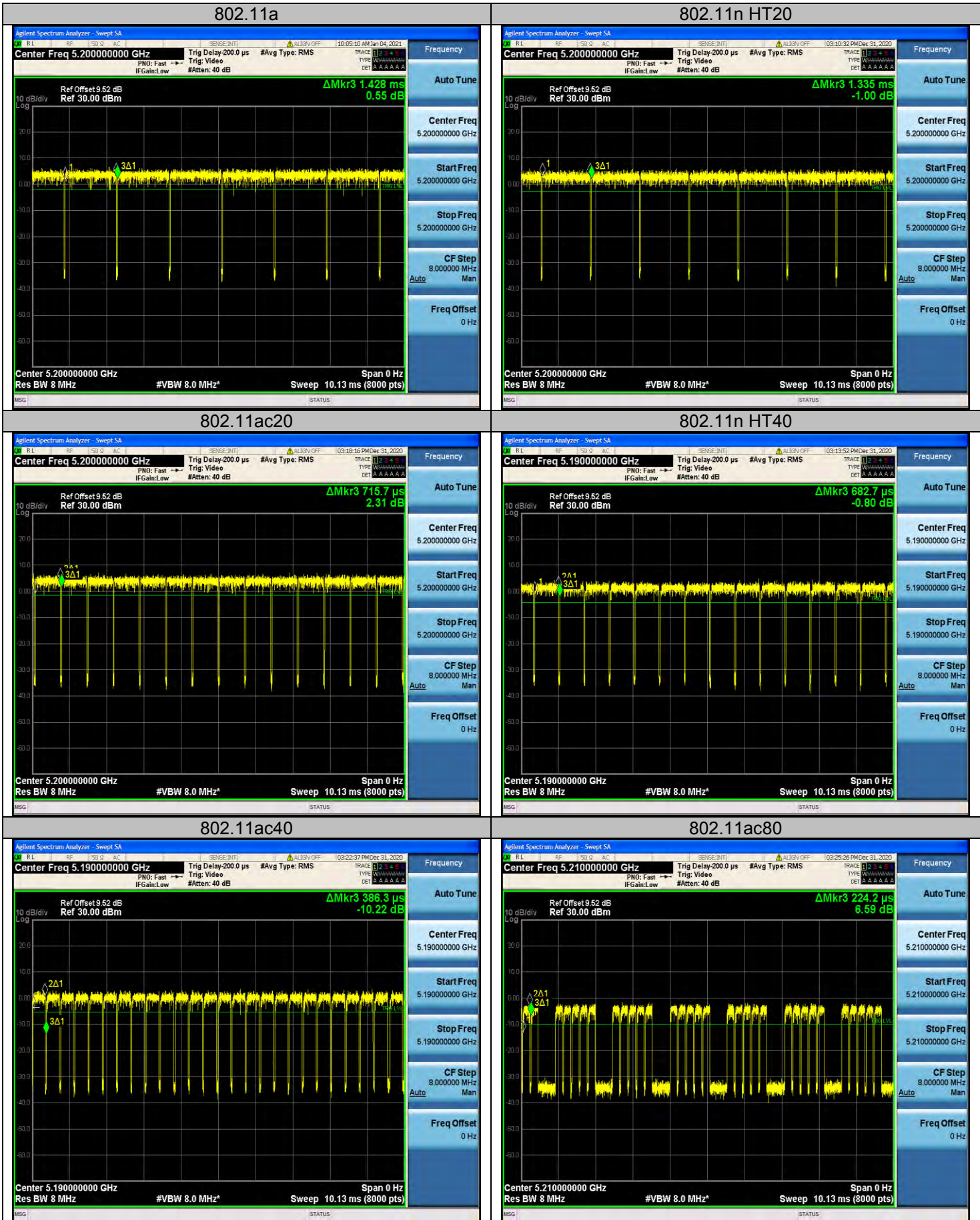

5725-5850MHz:

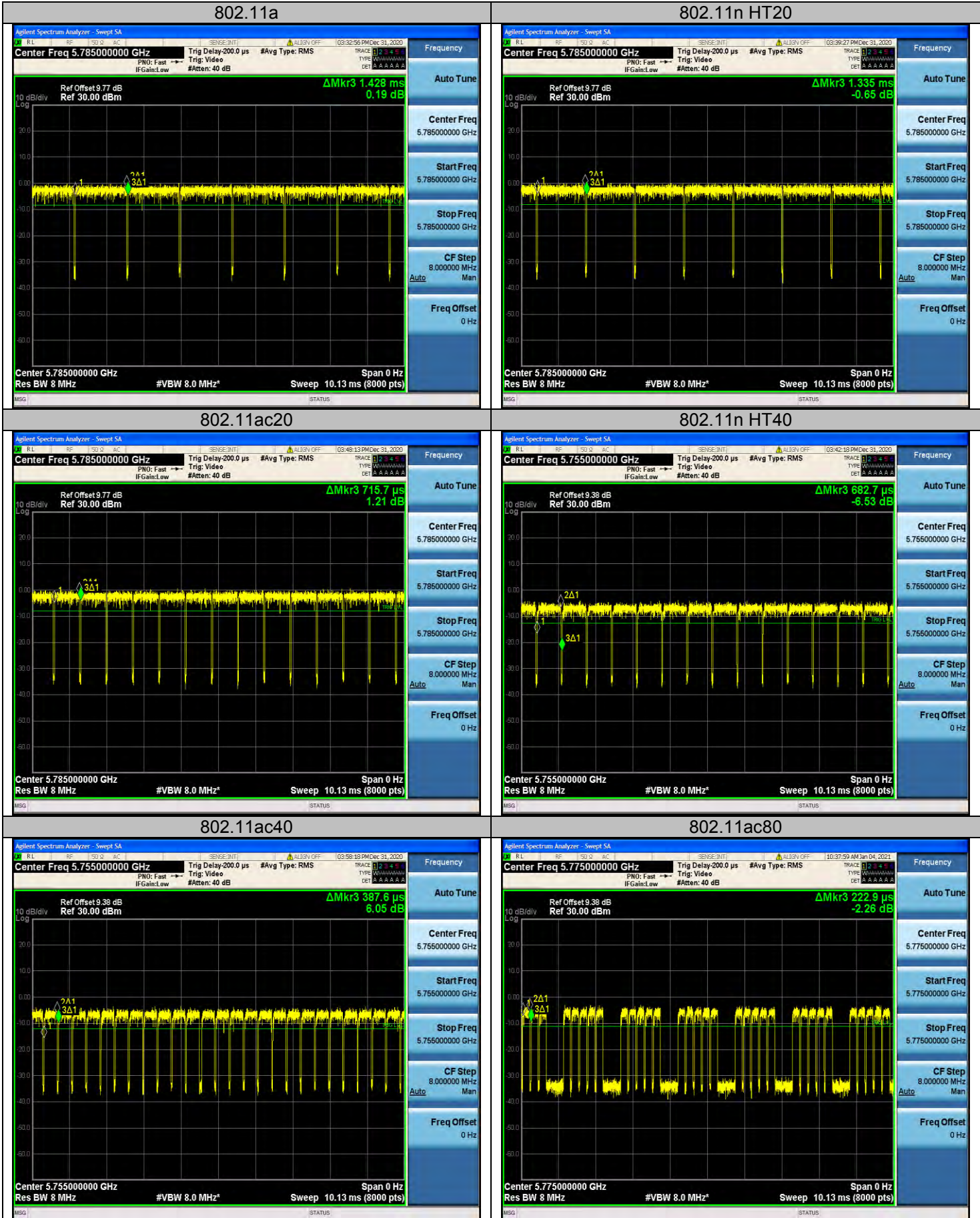

4.4. Maximum Average Output Power

TEST CONFIGURATION

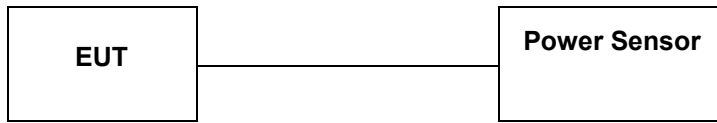

TEST PROCEDURE

According to KDB789033 D02 General U-NII Test Procedures New Rules v02r01 Measurement using a Power Meter (PM):

- a. Measurements may be performed using a wideband RF power meter with a thermocouple detector or equivalent if all of the conditions listed below are satisfied
 - 1. The EUT is configured to transmit continuously or to transmit with a constant duty cycle
 - 2. At all times when the EUT is transmitting, it must be transmitting at its maximum power control level.
 - 3. The integration period of the power meter exceeds the repetition period of the transmitted signal by at least a factor of five.
- b. If the transmitter does not transmit continuously, measure the duty cycle, x, of the transmitter output signal as described in section II.B
- c. Measure the average power of the transmitter. This measurement is an average over both the on and off periods of the transmitter.

Adjust the measurement in dBm by adding $10 \log(1/x)$ where x is the duty cycle (e.g., $10 \log(1/0.25)$ if the duty cycle is 25 percent).

LIMIT

According to §15.407(a): The maximum output power should be not exceed follow:

Frequency Range (MHz)	Limit
5150-5250	Fixed: 1 Watt (30dBm) Mobile and portable: 250mW (24dBm)
5250-5350	250mW (24dBm)
5470-5725	250mW (24dBm)
5725-5850	1 Watt (30dBm)

Note: The maximum e.i.r.p at any elevation angle above 30 degrees as measured from the horizon must not exceed 125mW(21dBm)

TEST RESULTS

Temperature	23.6°C	Humidity	55.7%
Test Engineer	Moon Tan	Configurations	IEEE 802.11a/n/ac

Antenna 0:
5150-5250MHz:

Channel	Frequency (MHz)	Output Power AV (dBm)	Duty factor (dB)	Output Power AV + Duty factor (dBm)	Limits (dBm)	Verdict
802.11a						
36	5180	14.44	0.13	14.57	30.00	PASS
40	5200	14.51	0.13	14.64	30.00	PASS
48	5240	14.68	0.13	14.81	30.00	PASS
802.11n20						
36	5180	14.62	0.13	14.75	30.00	PASS
40	5200	14.49	0.13	14.62	30.00	PASS
48	5240	14.55	0.13	14.68	30.00	PASS
802.11ac20						
36	5180	14.60	0.22	14.82	30.00	PASS
40	5200	14.57	0.22	14.79	30.00	PASS
48	5240	14.43	0.22	14.65	30.00	PASS
802.11n40						
38	5190	14.63	0.22	14.85	30.00	PASS
46	5230	14.72	0.22	14.94	30.00	PASS
802.11ac40						
38	5190	14.42	0.46	14.88	30.00	PASS
46	5230	14.66	0.46	15.12	30.00	PASS
802.11ac80						
42	5210	14.37	0.81	15.18	30.00	PASS

5725-5850MHz:

Channel	Frequency (MHz)	Output Power AV (dBm)	Duty factor (dB)	Output Power AV + Duty factor (dBm)	Limits (dBm)	Verdict
802.11a						
149	5745	14.51	0.13	14.64	30.00	PASS
157	5785	14.62	0.13	14.75	30.00	PASS
165	5825	14.52	0.13	14.65	30.00	PASS
802.11n20						
129	5745	14.48	0.13	14.61	30.00	PASS
157	5785	14.52	0.13	14.65	30.00	PASS
165	5825	14.54	0.13	14.67	30.00	PASS
802.11ac20						
149	5745	14.47	0.22	14.69	30.00	PASS
157	5785	14.56	0.22	14.78	30.00	PASS
165	5825	14.34	0.22	14.56	30.00	PASS
802.11n40						
151	5755	14.53	0.27	14.80	30.00	PASS
159	5795	14.59	0.27	14.86	30.00	PASS
802.11ac40						
151	5755	14.64	0.46	15.10	30.00	PASS
159	5795	14.49	0.46	14.95	30.00	PASS
802.11ac80						
155	5775	14.55	0.81	15.36	30.00	PASS

**Antenna 1:
5150-5250MHz:**

Channel	Frequency (MHz)	Output Power AV (dBm)	Duty factor (dB)	Output Power AV + Duty factor (dBm)	Limits (dBm)	Verdict
802.11a						
36	5180	14.72	0.13	14.85	30.00	PASS
40	5200	14.64	0.13	14.77	30.00	PASS
48	5240	14.57	0.13	14.70	30.00	PASS
802.11n20						
36	5180	14.74	0.13	14.87	30.00	PASS
40	5200	14.66	0.13	14.79	30.00	PASS
48	5240	14.69	0.13	14.82	30.00	PASS
802.11ac20						
36	5180	14.60	0.22	14.82	30.00	PASS
40	5200	14.78	0.22	15.00	30.00	PASS
48	5240	14.81	0.22	15.03	30.00	PASS
802.11n40						
38	5190	14.71	0.27	14.98	30.00	PASS
46	5230	14.66	0.27	14.93	30.00	PASS
802.11ac40						
38	5190	14.53	0.46	14.99	30.00	PASS
46	5230	14.69	0.46	15.15	30.00	PASS
802.11ac80						
42	5210	14.68	0.81	15.49	30.00	PASS

5725-5850MHz:

Channel	Frequency (MHz)	Output Power AV (dBm)	Duty factor (dB)	Output Power AV + Duty factor (dBm)	Limits (dBm)	Verdict
802.11a						
149	5745	14.55	0.13	14.68	30.00	PASS
157	5785	14.67	0.13	14.80	30.00	PASS
165	5825	14.70	0.13	14.83	30.00	PASS
802.11n20						
149	5745	14.64	0.13	14.77	30.00	PASS
157	5785	14.53	0.13	14.66	30.00	PASS
165	5825	14.62	0.13	14.75	30.00	PASS
802.11ac20						
149	5745	14.66	0.22	14.88	30.00	PASS
157	5785	14.44	0.22	14.66	30.00	PASS
165	5825	14.52	0.22	14.74	30.00	PASS
802.11n40						
151	5755	14.60	0.22	14.82	30.00	PASS
159	5795	14.43	0.22	14.65	30.00	PASS
802.11ac40						
151	5755	14.42	0.46	14.88	30.00	PASS
159	5795	14.48	0.46	14.94	30.00	PASS
802.11ac80						
155	5775	14.44	0.81	15.25	30.00	PASS

MIMO*2

5150-5250MHz:

Type	Channel	Power (dBm) ANT0	Power (dBm) ANT1	Total (dBm)	Limit (dBm)	Result
802.11n HT20	36	14.75	14.87	17.82	30.00	Pass
	40	14.62	14.79	17.72		
	48	14.68	14.82	17.76		
802.11ac20	36	14.82	14.82	17.83	30.00	Pass
	40	14.79	15.00	17.91		
	48	14.65	15.03	17.85		
802.11n HT40	38	14.85	14.98	17.93	30.00	Pass
	46	14.94	14.93	17.95		
802.11ac40	38	14.88	14.99	17.95	30.00	Pass
	46	15.12	15.15	18.15		
802.11ac80	42	15.18	15.49	18.35	30.00	Pass

5725-5850MHz:

Type	Channel	Power (dBm) ANT0	Power (dBm) ANT1	Total (dBm)	Limit (dBm)	Result
802.11n HT20	149	14.61	14.77	17.70	30.00	Pass
	157	14.65	14.66	17.67		
	165	14.67	14.75	17.72		
802.11ac20	149	14.69	14.88	17.80	30.00	Pass
	157	14.78	14.66	17.73		
	165	14.56	14.74	17.66		
802.11n HT40	151	14.80	14.82	17.82	30.00	Pass
	159	14.86	14.65	17.77		
802.11ac40	151	15.10	14.88	18.00	30.00	Pass
	159	14.95	14.94	17.96		
802.11ac80	155	15.36	15.25	18.32	30.00	Pass

Remark:

The Directional Gain= Gain of individual transmit antennas (dBi) + Array gain;
 Array gain = $10 \log(N_{ant})$, where N_{ant} is the number of transmit antennas
 Directional Gain=8.01 dBi

4.5. Power Spectral Density

TEST CONFIGURATION

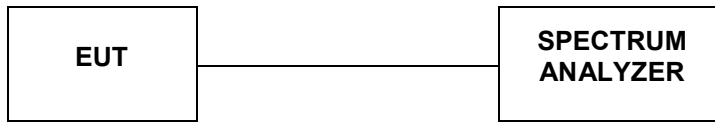

TEST PROCEDURE

According to KDB789033 D02 General U-NII Test Procedures New Rules v02r01: The rules requires “maximum power spectral density” measurements where the intent is to measure the maximum value of the time average of the power spectral density measured during a period of continuous transmission

- a. Create an average power spectrum for the EUT operating mode being tested by following the instructions in section II.E.2. for measuring maximum conducted output power using a spectrum analyzer or EMI receiver: select the appropriate test method (SA-1, SA-2, SA-3, or alternatives to each) and apply it up to, but not including, the step labeled, “Compute power...”. (This procedure is required even if the maximum conducted output power measurement was performed using a power meter, method PM.)
- b. Use the peak search function on the instrument to find the peak of the spectrum and record its value.
- c. Make the following adjustments to the peak value of the spectrum, if applicable:
 1. If Method SA-2 or SA-2 Alternative was used, add $10 \log(1/x)$, where x is the duty cycle, to the peak of the spectrum.
 2.) If Method SA-3 Alternative was used and the linear mode was used in step II.E.2.g)(viii), add 1 dB to the final result to compensate for the difference between linear averaging and power averaging.
- d. The result is the Maximum PSD over 1 MHz reference bandwidth.
- e. For devices operating in the bands 5.15-5.25 GHz, 5.25-5.35 GHz, and 5.47-5.725 GHz, the above procedures make use of 1 MHz RBW to satisfy directly the 1 MHz reference bandwidth specified in § 15.407(a)(5). For devices operating in the band 5.725-5.85 GHz, the rules specify a measurement bandwidth of 500 kHz. Many spectrum analyzers do not have 500 kHz RBW, thus a narrower RBW may need to be used. The rules permit the use of a RBWs less than 1 MHz, or 500 kHz, “provided that the measured power is integrated over the full reference bandwidth” to show the total power over the specified measurement bandwidth (i.e., 1 MHz, or 500 kHz). If measurements are performed using a reduced resolution bandwidth (< 1 MHz, or < 500 kHz) and integrated over 1 MHz, or 500 KHz bandwidth, the following adjustments to the procedures apply:
 1. Set $RBW \geq 1/T$, where T is defined in section II.B.I.a).
 2. Set $VBW \geq 3 RBW$.
 3. If measurement bandwidth of Maximum PSD is specified in 500 kHz, add $10\log(500kHz/RBW)$ to the measured result, whereas RBW (< 500 KHz) is the reduced resolution bandwidth of the spectrum analyzer set during measurement.
 4. If measurement bandwidth of Maximum PSD is specified in 1 MHz, add $10\log(1MHz/RBW)$ to the measured result, whereas RBW (< 1 MHz) is the reduced resolution bandwidth of spectrum analyzer set during measurement.
 5. Care must be taken to ensure that the measurements are performed during a period of continuous transmission or are corrected upward for duty cycle.

Note: As a practical matter, it is recommended to use reduced RBW of 100 KHz for the sections 5.c) and 5.d) above, since RBW=100 KHz is available on nearly all spectrum analyzers.
- f. Adjust the measurement in dBm by adding $10 \log(1/x)$ where x is the duty cycle (e.g., $10 \log(1/0.25)$ if the duty cycle is 25 percent).

LIMIT

According to §15.407(a): The maximum output power should be not exceed follow:

Frequency Range (MHz)	Limit
5150-5250	Other then Mobile and portable:17dBm/MHz Mobile and portable:11dBm/MHz
5250-5350	11dBm/MHz
5470-5725	11dBm/MHz
5725-5850	30dBm/500kHz

TEST RESULTS

Temperature	23.6°C	Humidity	55.7%
Test Engineer	Moon Tan	Configurations	IEEE 802.11a/n/ac

**Antenna 0:
5150-5250MHz:**
802.11a Test Mode

Channel	Frequency (MHz)	Report PSD (dBm/1MHz)	Duty factor (dB)	RBW factor (dB)	Report PSD+ Duty factor+ RBW factor (dBm/1MHz)	Limits (dBm/1MHz)	Verdict
36	5180	4.34	0.13	0	4.47	17.00	PASS
40	5200	4.11	0.13	0	4.24	17.00	PASS
48	5240	4.37	0.13	0	4.50	17.00	PASS

802.11n HT20 Test Mode

Channel	Frequency (MHz)	Report PSD (dBm/1MHz)	Duty factor (dB)	RBW factor (dB)	Report PSD+ Duty factor+ RBW factor (dBm/1MHz)	Limits (dBm/1MHz)	Verdict
36	5180	5.41	0.13	0	5.54	17.00	PASS
40	5200	4.97	0.13	0	5.10	17.00	PASS
48	5240	4.61	0.13	0	4.74	17.00	PASS

802.11ac20 Test Mode

Channel	Frequency (MHz)	Report PSD (dBm/1MHz)	Duty factor (dB)	RBW factor (dB)	Report PSD+ Duty factor+ RBW factor (dBm/1MHz)	Limits (dBm/1MHz)	Verdict
36	5180	4.38	0.22	0	4.60	17.00	PASS
40	5200	4.43	0.22	0	4.65	17.00	PASS
48	5240	4.19	0.22	0	4.41	17.00	PASS

802.11n40 Test Mode

Channel	Frequency (MHz)	Report PSD (dBm/1MHz)	Duty factor (dB)	RBW factor (dB)	Report PSD+ Duty factor+ RBW factor (dBm/1MHz)	Limits (dBm/1MHz)	Verdict
38	5190	2.42	0.22	0	2.64	17.00	PASS
46	5230	1.75	0.22	0	1.97	17.00	PASS

802.11ac40 Test Mode

Channel	Frequency (MHz)	Report PSD (dBm/1MHz)	Duty factor (dB)	RBW factor (dB)	Report PSD+ Duty factor+ RBW factor (dBm/1MHz)	Limits (dBm/1MHz)	Verdict
38	5190	2.66	0.46	0	3.12	17.00	PASS
46	5230	2.08	0.46	0	2.54	17.00	PASS

802.11ac80 Test Mode

Channel	Frequency (MHz)	Report PSD (dBm/1MHz)	Duty factor (dB)	RBW factor (dB)	Report PSD+ Duty factor+ RBW factor (dBm/1MHz)	Limits (dBm/1MHz)	Verdict
42	5210	2.71	0.81	0	3.52	17.00	PASS

5725-5850MHz:

802.11a Test Mode

Channel	Frequency (MHz)	Report PSD (dBm/300KHz)	Duty factor (dB)	RBW factor (dB)	Report PSD+ Duty factor+ RBW factor (dBm/500kHz)	Limits (dBm/500kHz)	Verdict
149	5745	2.29	0.13	2.2	4.62	30	PASS
157	5785	3.60	0.13	2.2	5.93	30	PASS
165	5825	5.98	0.13	2.2	8.31	30	PASS

802.11n HT20 Test Mode

Channel	Frequency (MHz)	Report PSD (dBm/300KHz)	Duty factor (dB)	RBW factor (dB)	Report PSD+ Duty factor+ RBW factor (dBm/500kHz)	Limits (dBm/500kHz)	Verdict
149	5745	2.39	0.13	2.2	4.72	30	PASS
157	5785	3.2	0.13	2.2	5.53	30	PASS
165	5825	5.56	0.13	2.2	7.89	30	PASS

802.11ac20 Test Mode

Channel	Frequency (MHz)	Report PSD (dBm/300KHz)	Duty factor (dB)	RBW factor (dB)	Report PSD+ Duty factor+ RBW factor (dBm/500kHz)	Limits (dBm/500kHz)	Verdict
149	5745	4.75	0.22	2.2	7.17	30	PASS
157	5785	5.76	0.22	2.2	8.18	30	PASS
165	5825	3.60	0.22	2.2	6.02	30	PASS

802.11n40Test Mode

Channel	Frequency (MHz)	Report PSD (dBm/300KHz)	Duty factor (dB)	RBW factor (dB)	Report PSD+ Duty factor+ RBW factor (dBm/500kHz)	Limits (dBm/500kHz)	Verdict
149	5755	1.48	0.27	2.2	3.95	30	PASS
157	5795	2.42	0.27	2.2	4.89	30	PASS

802.11ac40 Test Mode

Channel	Frequency (MHz)	Report PSD (dBm/300KHz)	Duty factor (dB)	RBW factor (dB)	Report PSD+ Duty factor+ RBW factor (dBm/500kHz)	Limits (dBm/500kHz)	Verdict
149	5755	1.67	0.46	2.2	4.33	30	PASS
157	5795	2.18	0.46	2.2	4.84	30	PASS

802.11ac80 Test Mode

Channel	Frequency (MHz)	Report PSD (dBm/300KHz)	Duty factor (dB)	RBW factor (dB)	Report PSD+ Duty factor+ RBW factor (dBm/500kHz)	Limits (dBm/500kHz)	Verdict
155	5775	-1.80	0.81	2.2	1.21	30	PASS

Antenna 1:
5150-5250MHz:

802.11a Test Mode

Channel	Frequency (MHz)	Report PSD (dBm/1MHz)	Duty factor (dB)	RBW factor (dB)	Report PSD+ Duty factor+ RBW factor (dBm/1MHz)	Limits (dBm/1MHz)	Verdict
36	5180	1.67	0.13	0	1.80	17.00	PASS
40	5200	1.51	0.13	0	1.64	17.00	PASS
48	5240	0.77	0.13	0	0.90	17.00	PASS

802.11n HT20 Test Mode

Channel	Frequency (MHz)	Report PSD (dBm/1MHz)	Duty factor (dB)	RBW factor (dB)	Report PSD+ Duty factor+ RBW factor (dBm/1MHz)	Limits (dBm/1MHz)	Verdict
36	5180	-0.04	0.13	0	0.09	17.00	PASS
40	5200	-0.28	0.13	0	-0.15	17.00	PASS
48	5240	-1.15	0.13	0	-1.02	17.00	PASS

802.11ac20 Test Mode

Channel	Frequency (MHz)	Report PSD (dBm/1MHz)	Duty factor (dB)	RBW factor (dB)	Report PSD+ Duty factor+ RBW factor (dBm/1MHz)	Limits (dBm/1MHz)	Verdict
36	5180	1.49	0.22	0	1.71	17.00	PASS
40	5200	1.11	0.22	0	1.33	17.00	PASS
48	5240	0.16	0.22	0	0.38	17.00	PASS

802.11n40 Test Mode

Channel	Frequency (MHz)	Report PSD (dBm/1MHz)	Duty factor (dB)	RBW factor (dB)	Report PSD+ Duty factor+ RBW factor (dBm/1MHz)	Limits (dBm/1MHz)	Verdict
38	5190	-1.07	0.27	0	-0.80	17.00	PASS
46	5230	-1.59	0.27	0	-1.32	17.00	PASS

802.11ac40 Test Mode

Channel	Frequency (MHz)	Report PSD (dBm/1MHz)	Duty factor (dB)	RBW factor (dB)	Report PSD+ Duty factor+ RBW factor (dBm/1MHz)	Limits (dBm/1MHz)	Verdict
38	5190	-1.15	0.46	0	-0.69	17.00	PASS
46	5230	-2.74	0.46	0	-2.28	17.00	PASS

802.11ac80 Test Mode

Channel	Frequency (MHz)	Report PSD (dBm/1MHz)	Duty factor (dB)	RBW factor (dB)	Report PSD+ Duty factor+ RBW factor (dBm/1MHz)	Limits (dBm/1MHz)	Verdict
42	5210	-5.79	0.81	0	-4.98	17.00	PASS

5725-5850MHz:

802.11a Test Mode

Channel	Frequency (MHz)	Report PSD (dBm/300KHz)	Duty factor (dB)	RBW factor (dB)	Report PSD+ Duty factor+ RBW factor (dBm/500kHz)	Limits (dBm/500kHz)	Verdict
149	5745	3.48	0.13	2.2	5.81	30	PASS
157	5785	4.67	0.13	2.2	7.00	30	PASS
165	5825	4.80	0.13	2.2	7.13	30	PASS

802.11n HT20 Test Mode

Channel	Frequency (MHz)	Report PSD (dBm/300KHz)	Duty factor (dB)	RBW factor (dB)	Report PSD+ Duty factor+ RBW factor (dBm/500kHz)	Limits (dBm/500kHz)	Verdict
149	5745	2.75	0.13	2.2	5.08	30	PASS
157	5785	3.98	0.13	2.2	6.31	30	PASS
165	5825	4.29	0.13	2.2	6.62	30	PASS

802.11ac20 Test Mode

Channel	Frequency (MHz)	Report PSD (dBm/300KHz)	Duty factor (dB)	RBW factor (dB)	Report PSD+ Duty factor+ RBW factor (dBm/500kHz)	Limits (dBm/500kHz)	Verdict
149	5745	2.32	0.22	2.2	4.74	30	PASS
157	5785	3.55	0.22	2.2	5.97	30	PASS
165	5825	3.81	0.22	2.2	6.23	30	PASS

802.11n40Test Mode

Channel	Frequency (MHz)	Report PSD (dBm/300KHz)	Duty factor (dB)	RBW factor (dB)	Report PSD+ Duty factor+ RBW factor (dBm/500kHz)	Limits (dBm/500kHz)	Verdict
149	5755	-0.36	0.22	2.2	2.06	30	PASS
157	5795	0.71	0.22	2.2	3.13	30	PASS

802.11ac40 Test Mode

Channel	Frequency (MHz)	Report PSD (dBm/300KHz)	Duty factor (dB)	RBW factor (dB)	Report PSD+ Duty factor+ RBW factor (dBm/500kHz)	Limits (dBm/500kHz)	Verdict
149	5755	-0.46	0.46	2.2	2.20	30	PASS
157	5795	0.08	0.46	2.2	2.74	30	PASS

802.11ac80 Test Mode

Channel	Frequency (MHz)	Report PSD (dBm/300KHz)	Duty factor (dB)	RBW factor (dB)	Report PSD+ Duty factor+ RBW factor (dBm/500kHz)	Limits (dBm/500kHz)	Verdict
155	5775	-3.31	0.81	2.2	-0.30	30	PASS

MIMO*2

5150-5250MHz:

Type	Channel	PSD (dBm/1MHz) ANT0	PSD (dBm/1MHz) ANT1	Total (dBm/1MHz)	Limit (dBm/1MHz)	Result
802.11n HT20	36	5.54	0.09	6.63	14.99	Pass
	40	5.10	-0.15	6.23		
	48	4.74	-1.02	5.76		
802.11ac 20	36	4.60	1.71	6.40	14.99	Pass
	40	4.65	1.33	6.31		
	48	4.41	0.38	5.86		
802.11n HT40	38	2.64	-0.80	4.26	14.99	Pass
	46	1.97	-1.32	3.64		
802.11ac 40	38	3.12	-0.69	4.63	14.99	Pass
	46	2.54	-2.28	3.78		
802.11ac 80	42	3.52	-4.98	4.09	14.99	Pass

5725-5850MHz:

Type	Channel	PSD (dBm/500KHz) ANT0	PSD (dBm/500KHz) ANT1	Total (dBm/500KHz)	Limit (dBm/500KHz)	Result
802.11n HT20	149	4.72	5.08	7.91	27.99	Pass
	157	5.53	6.31	8.95		
	165	7.89	6.62	10.31		
802.11ac 20	149	7.17	4.74	9.13	27.99	Pass
	157	8.18	5.97	10.22		
	165	6.02	6.23	9.14		
802.11n HT40	151	3.95	2.06	6.12	27.99	Pass
	159	4.89	3.13	7.11		
802.11ac 40	151	4.33	2.20	6.40	27.99	Pass
	159	4.84	2.74	6.93		
802.11ac 80	155	1.21	-0.30	7.91	27.99	Pass

Note:

1. The test results including the cable lose.

Remark:

The Directional Gain= Gain of individual transmit antennas (dBi) + Array gain;

Array gain = 10 log (Nant), where Nant is the number of transmit antennas

Directional Gain=8.01 dBi

Antenna 0:
5150-5250MHz:

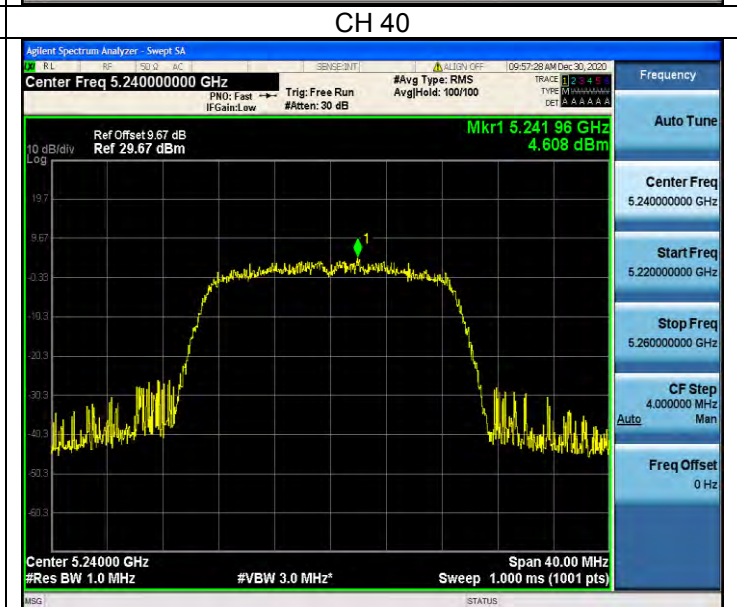
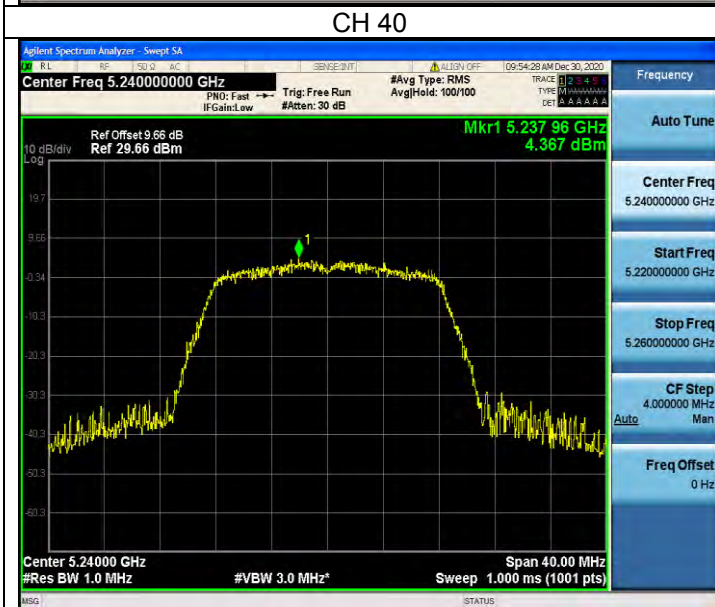
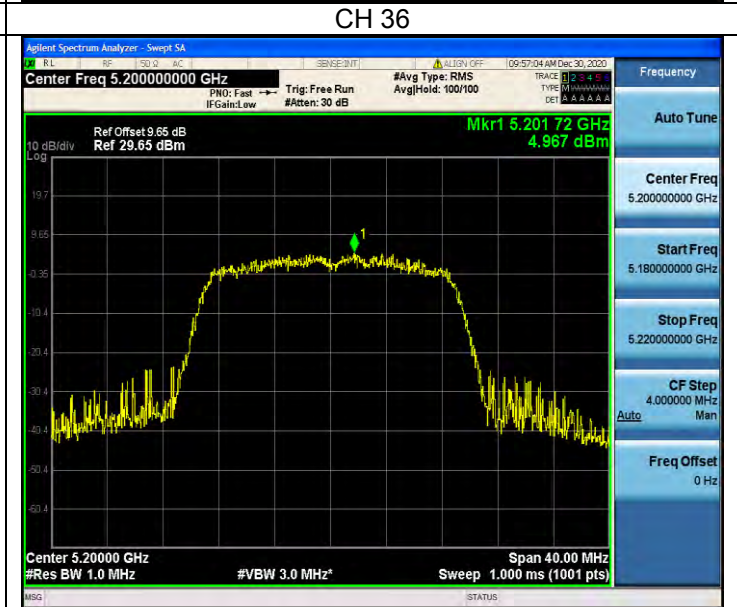
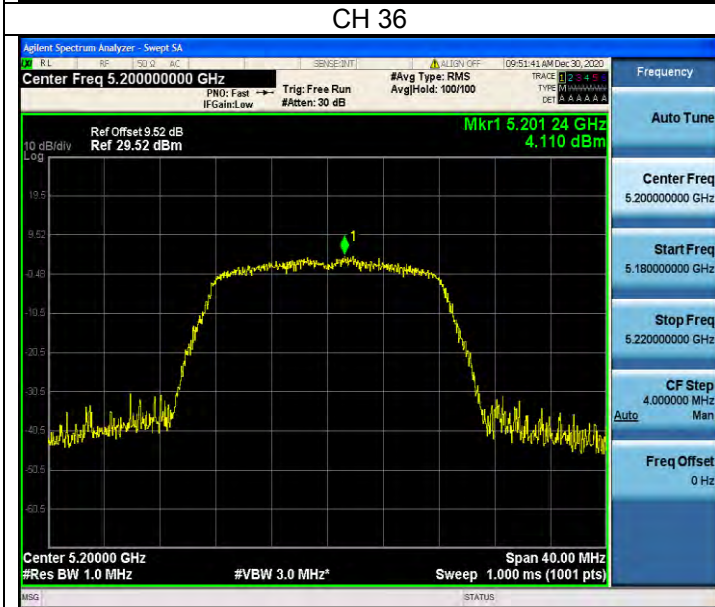
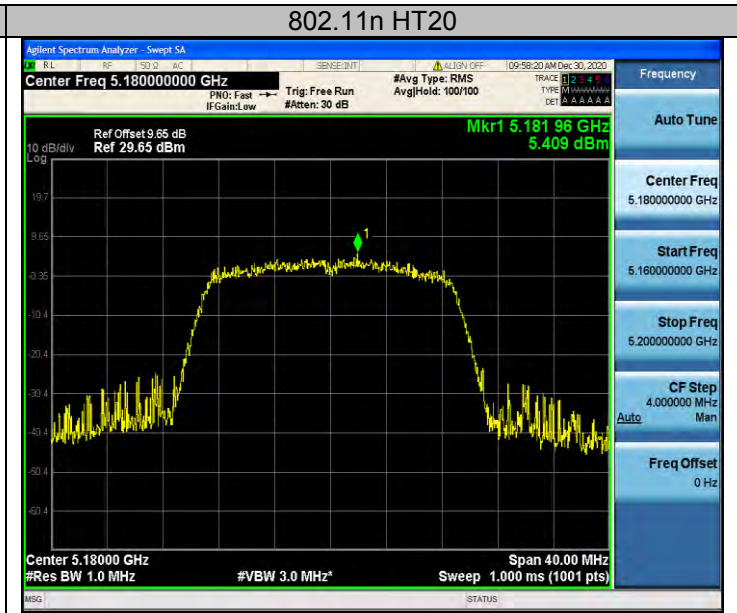
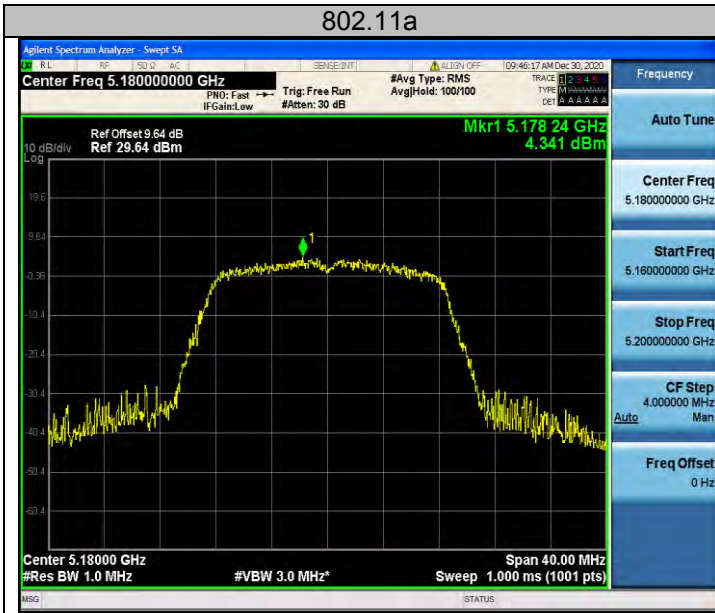

CH 48

CH 48

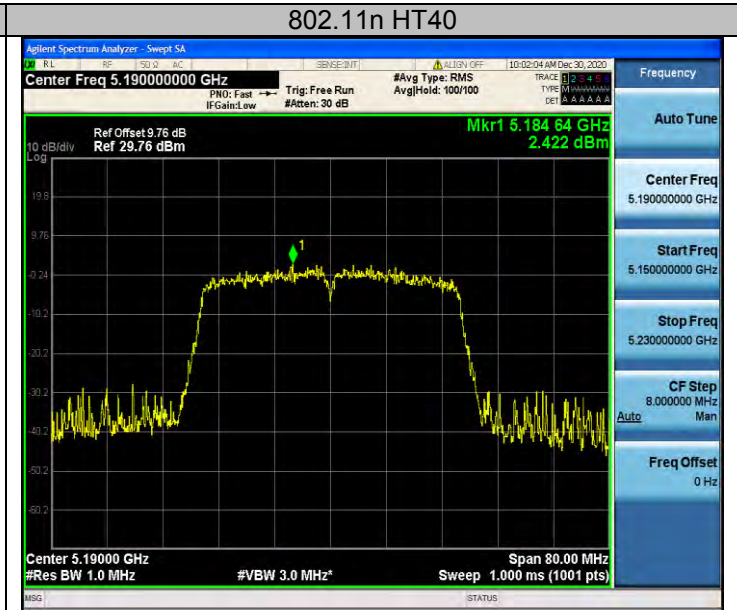
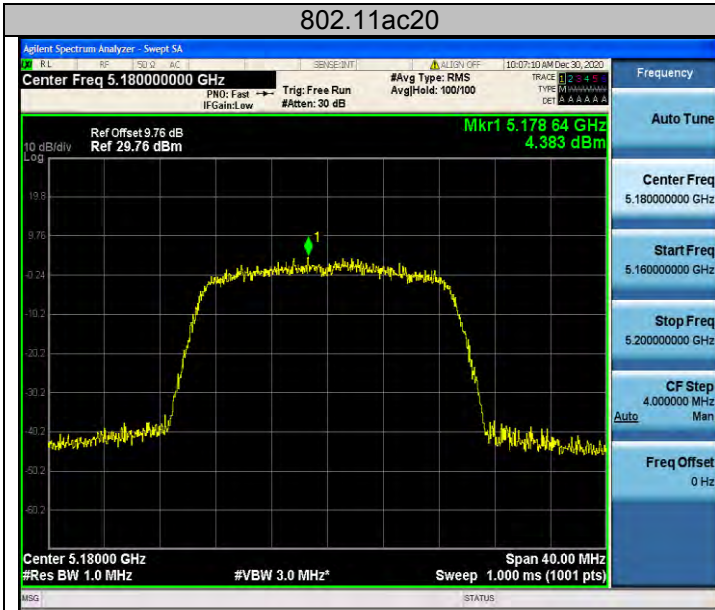

CH 36

CH 38

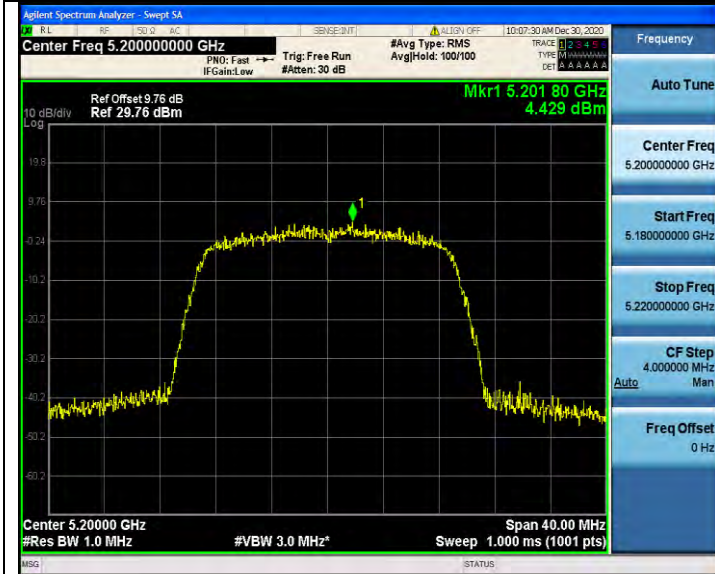

CH 40

CH 46



CH 48

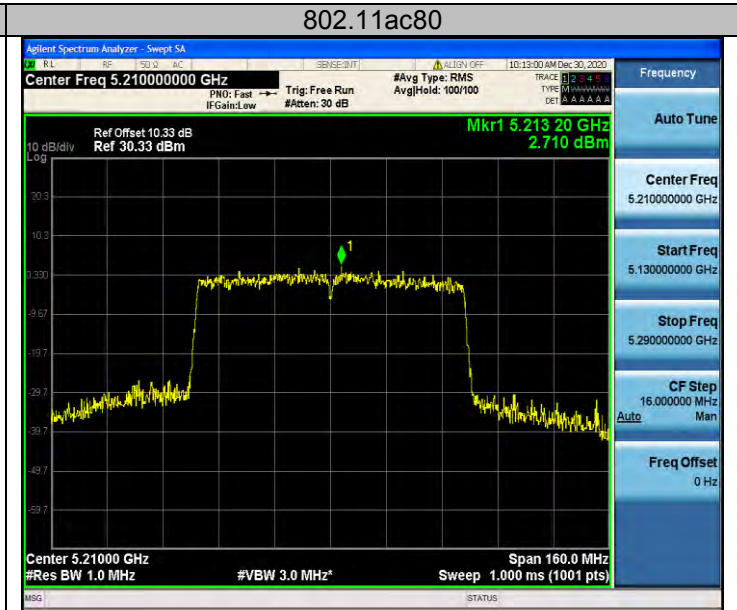
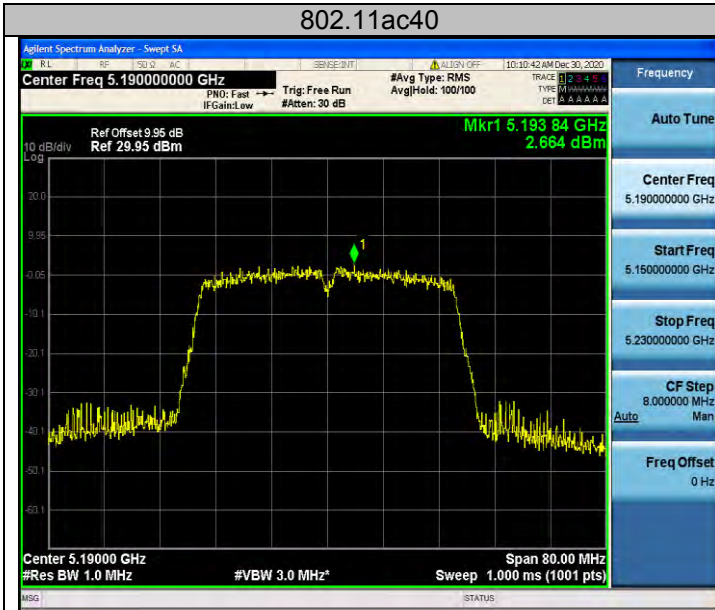

CH 38

CH 42



CH 46

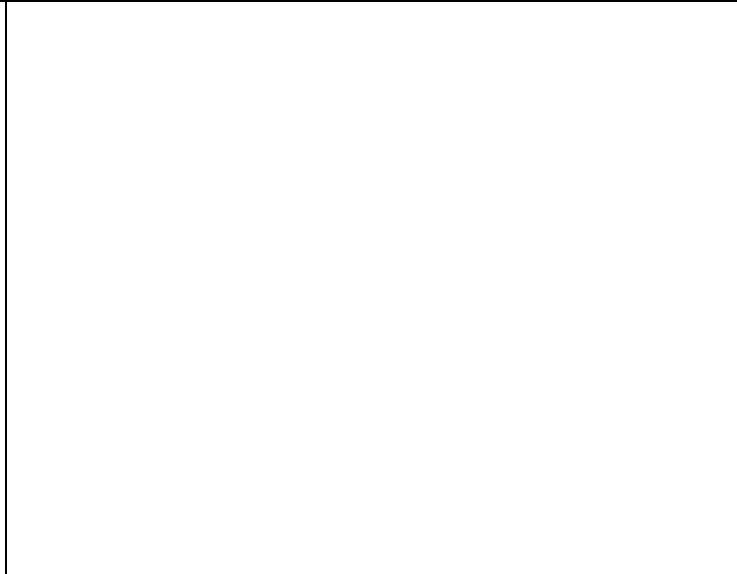

5725-5850MHz:

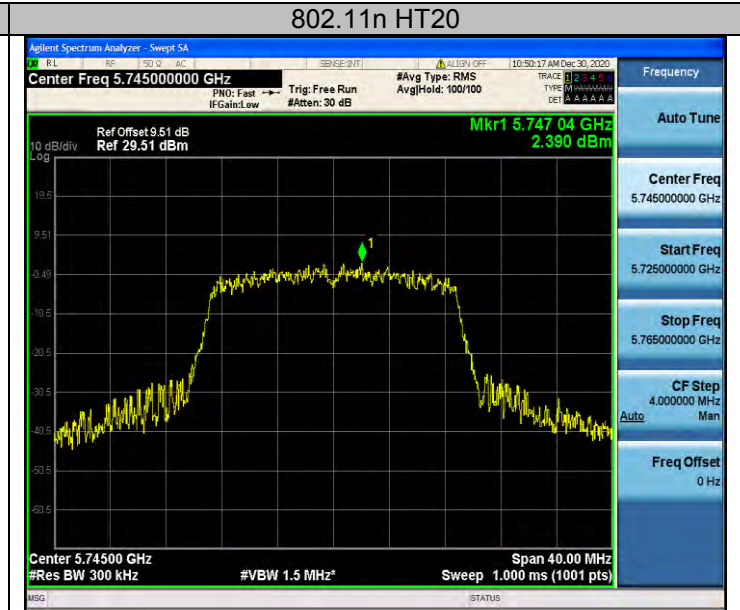
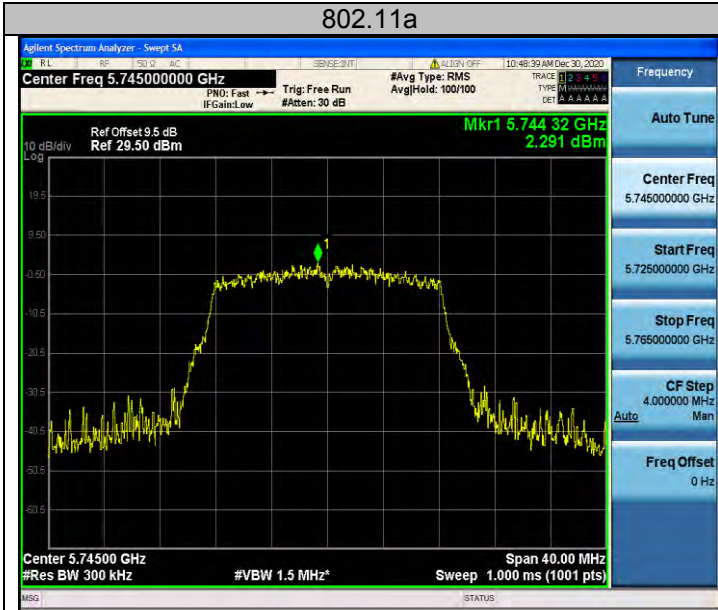

CH 149

CH 149



CH 157

CH 157



CH 165

CH 165

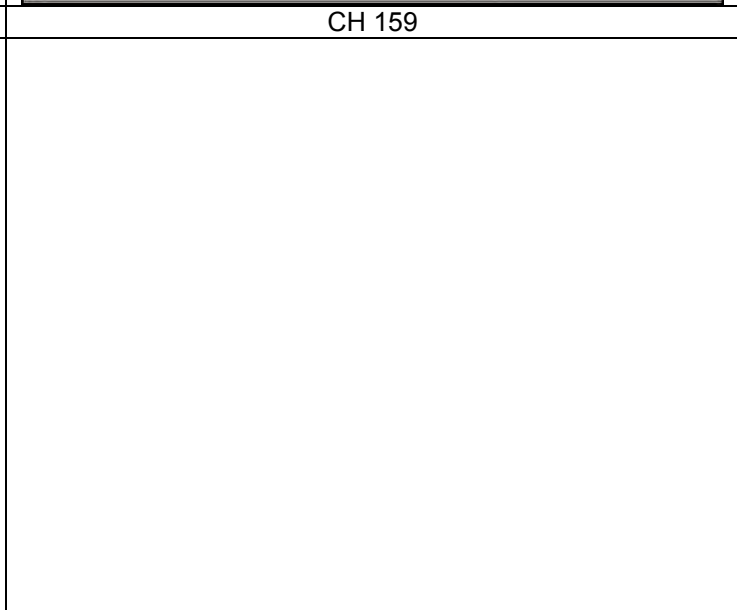
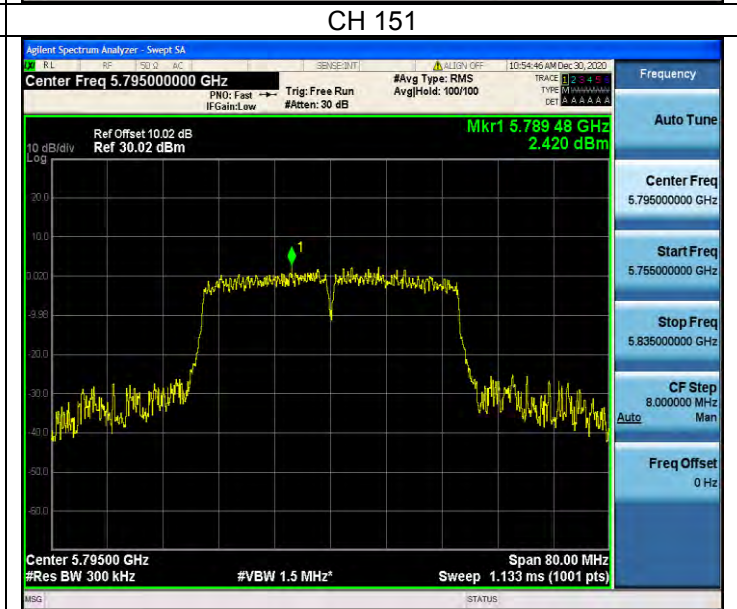
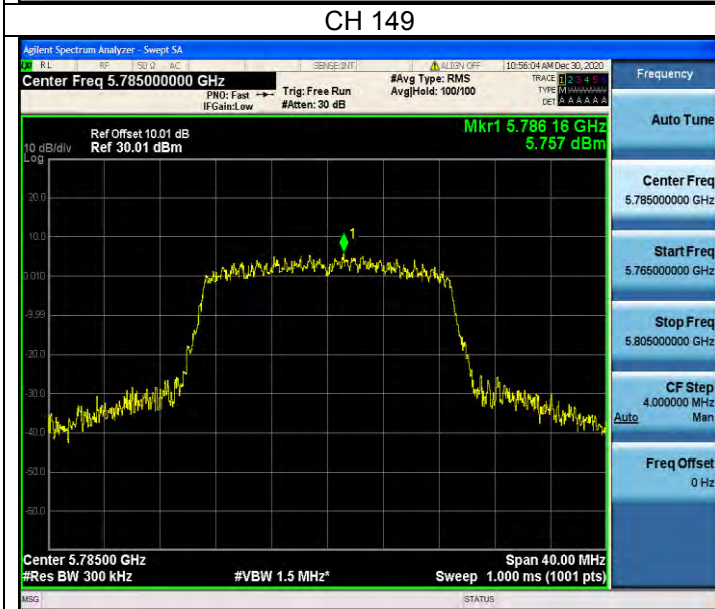
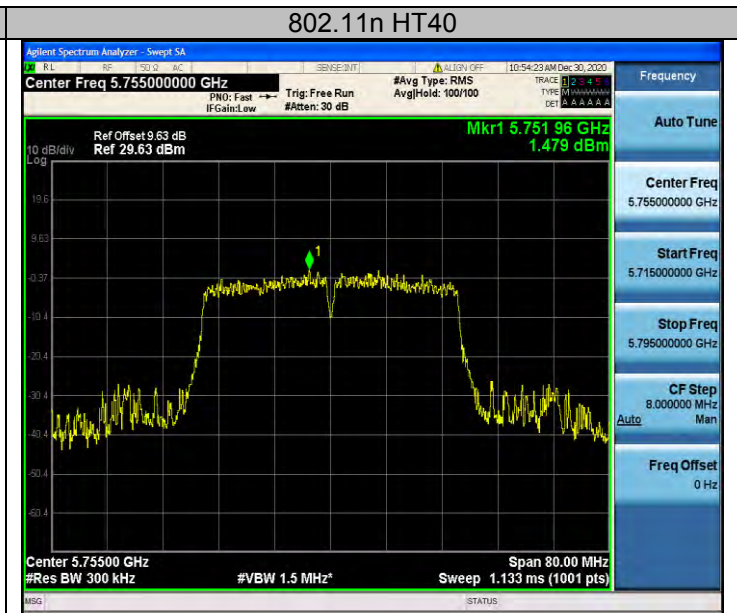

CH 165

802.11ac40

802.11ac80



CH 151

CH 155



CH 159



Antenna 1:
5150-5250MHz:

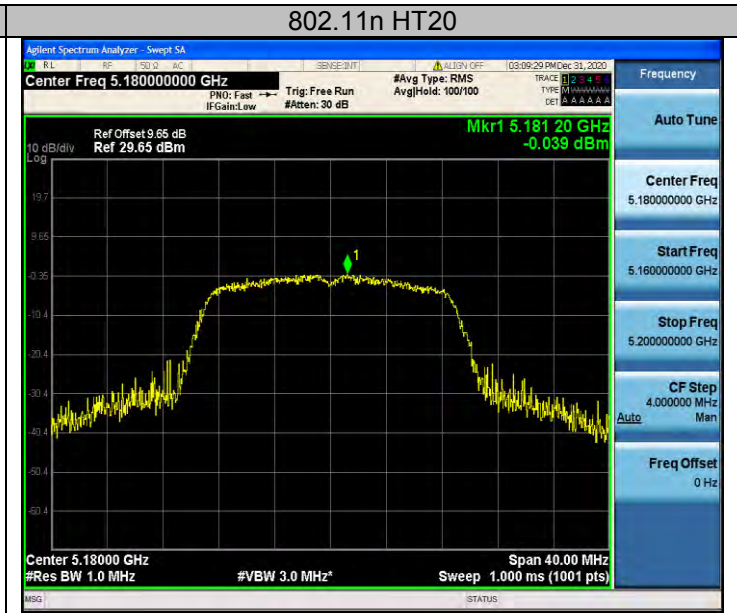
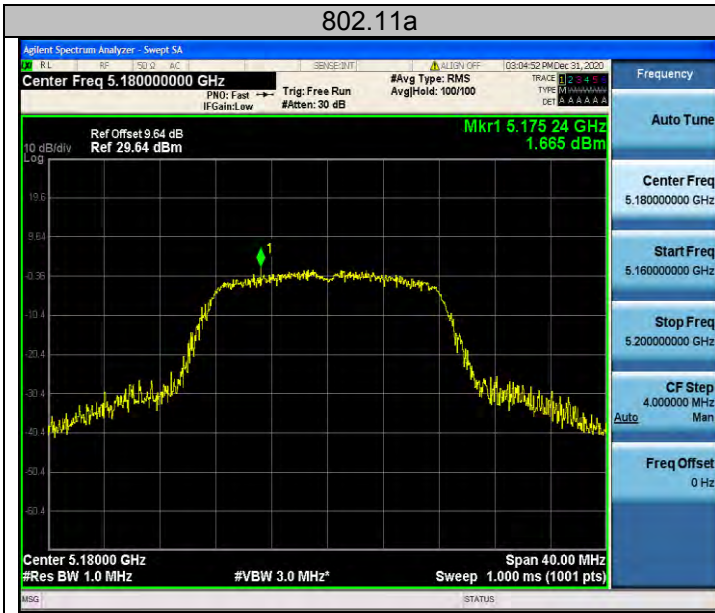

CH 36

CH 36



CH 40

CH 40

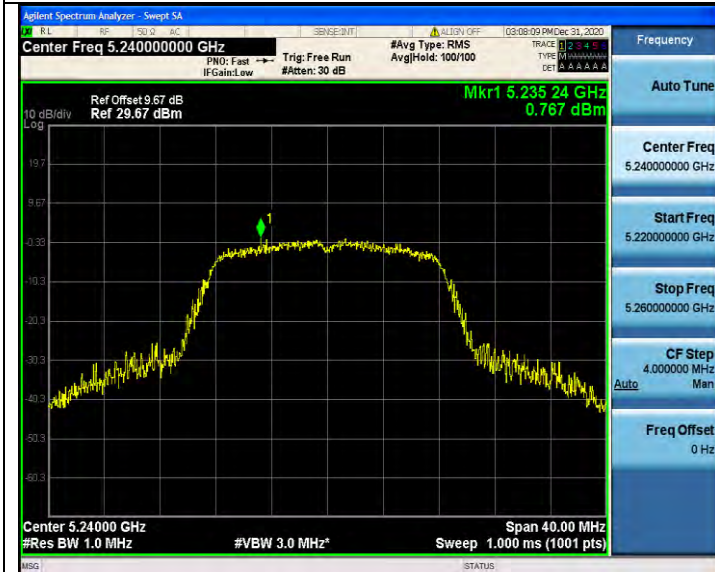

CH 48

CH 48



CH 36

CH 38



CH 40

CH 46



CH 48

802.11ac40

802.11ac80



CH 38

CH 42



CH 46



5725-5850MHz:

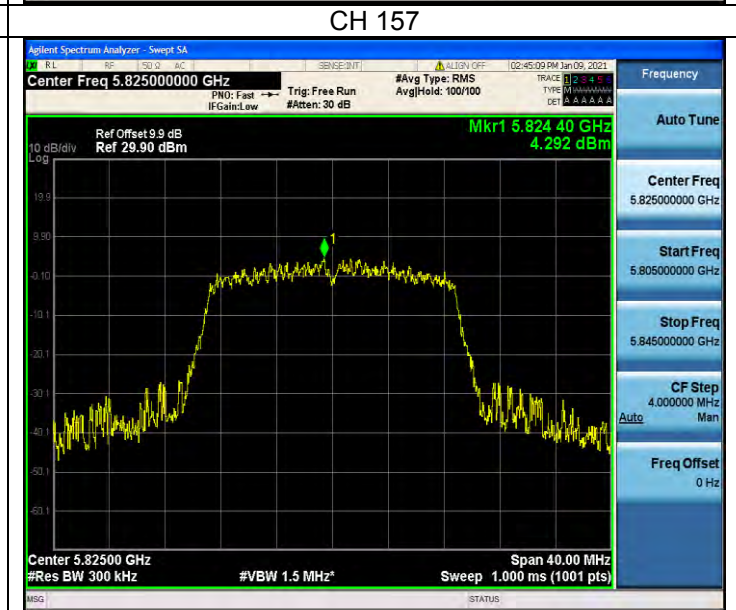
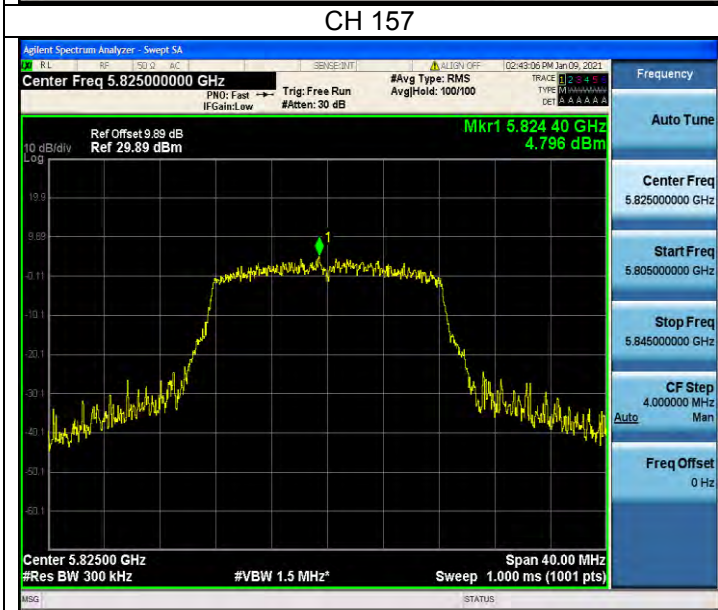
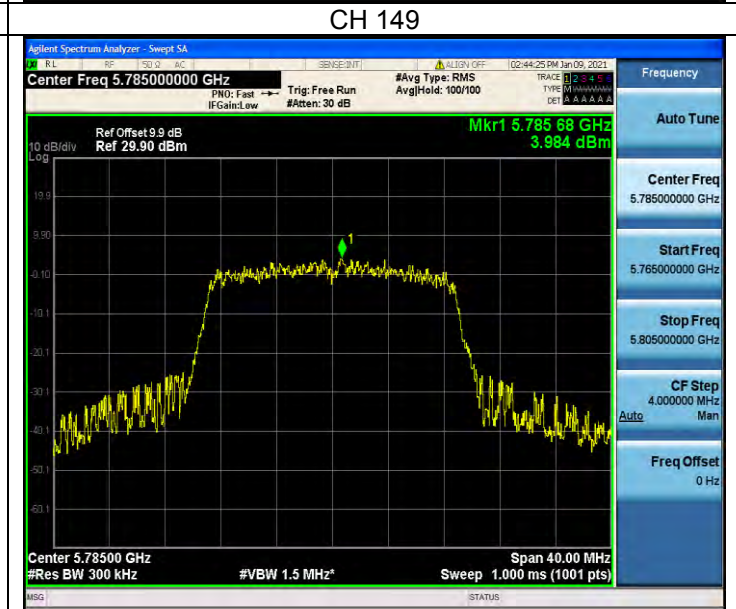
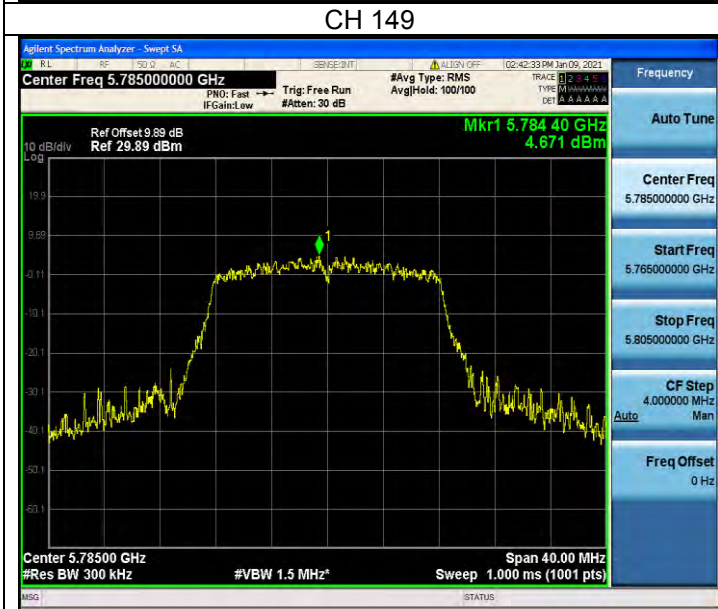
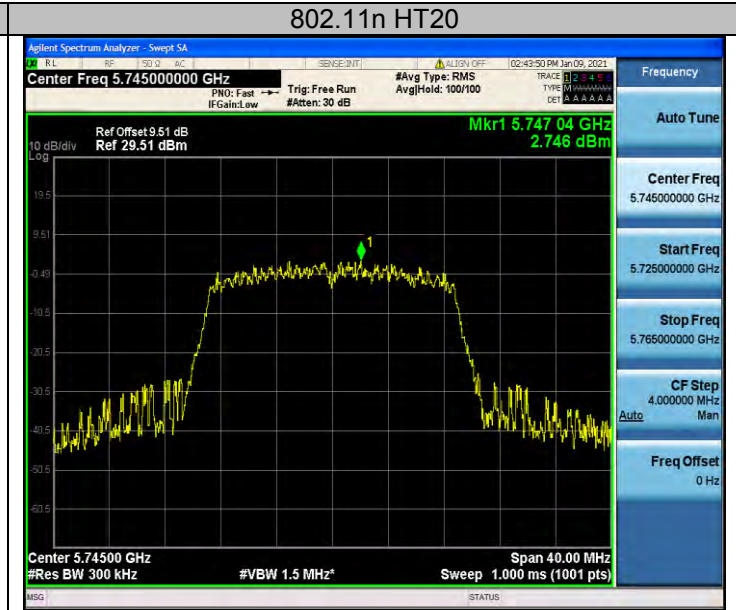
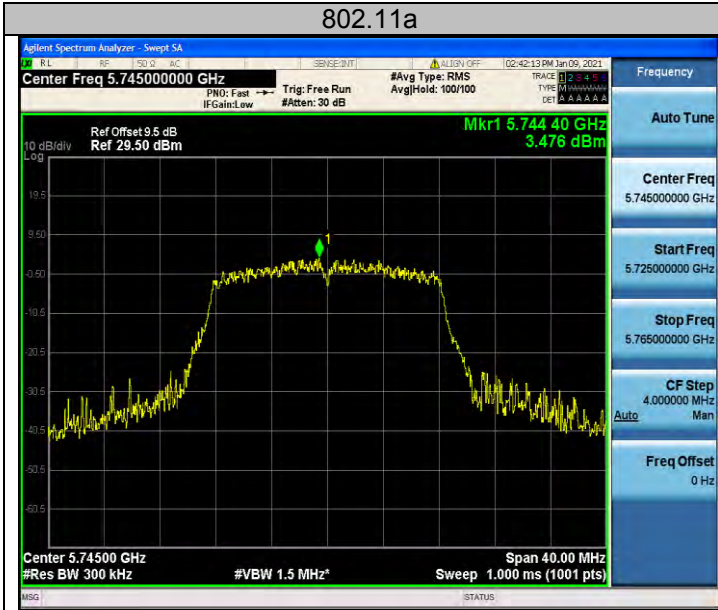

CH 165

CH 165

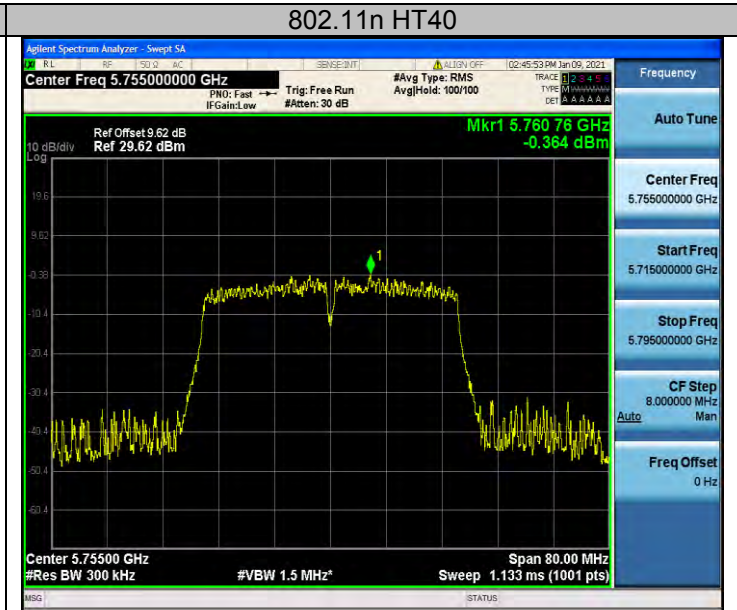
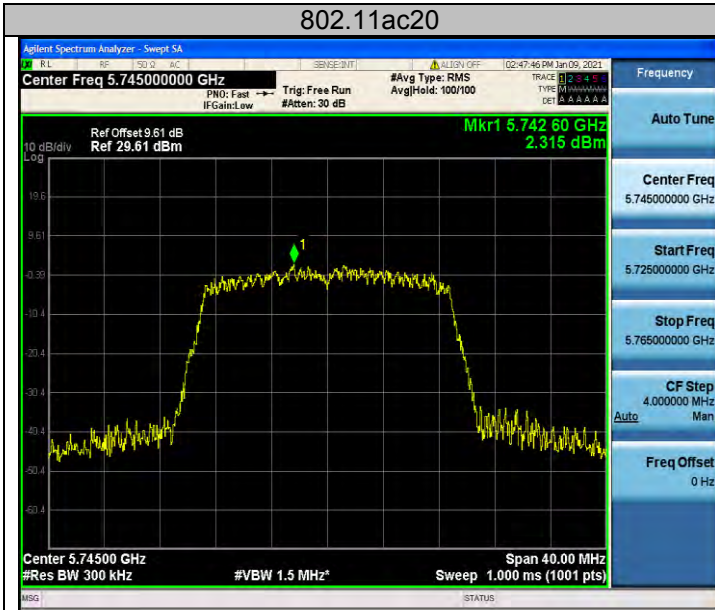

CH 149

CH 151



CH 157

CH 159



CH 165

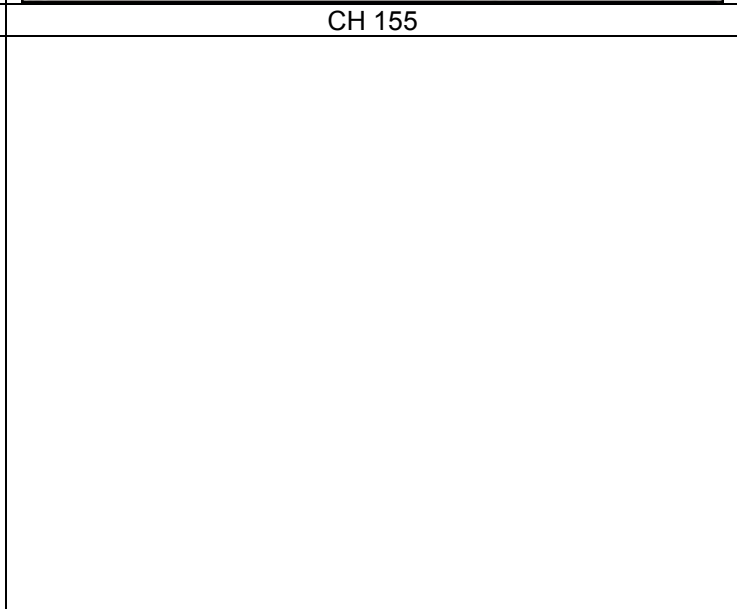
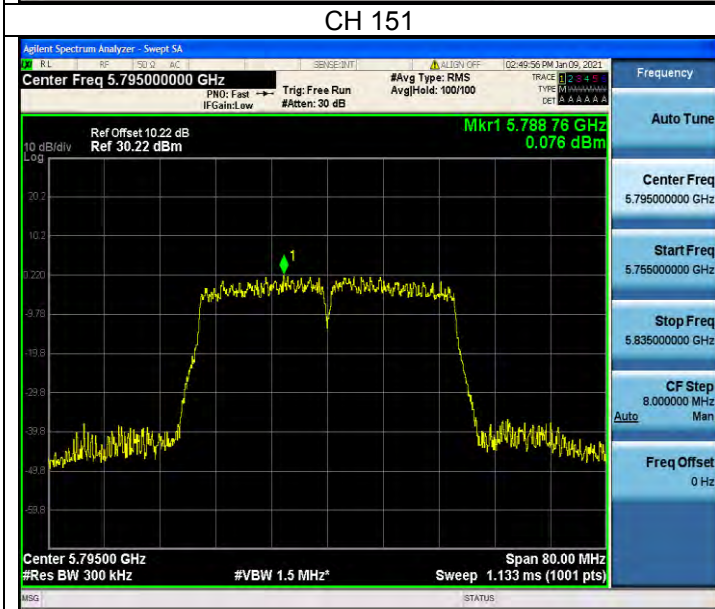
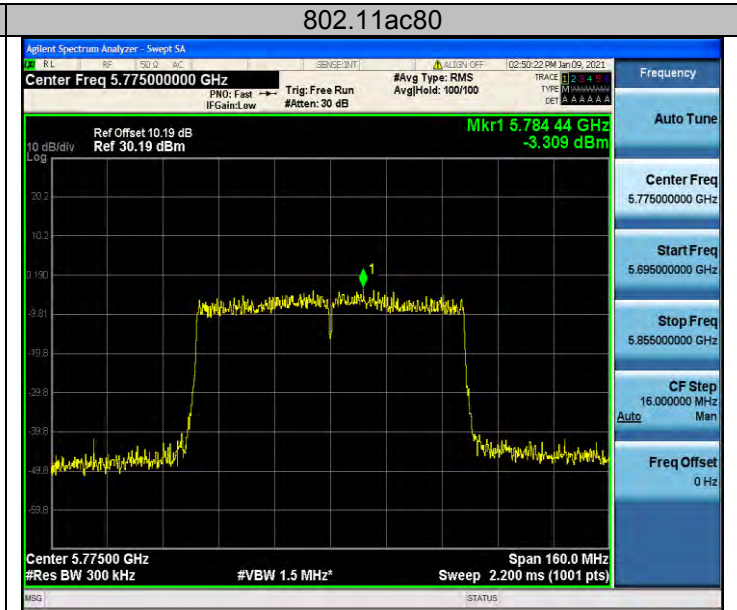
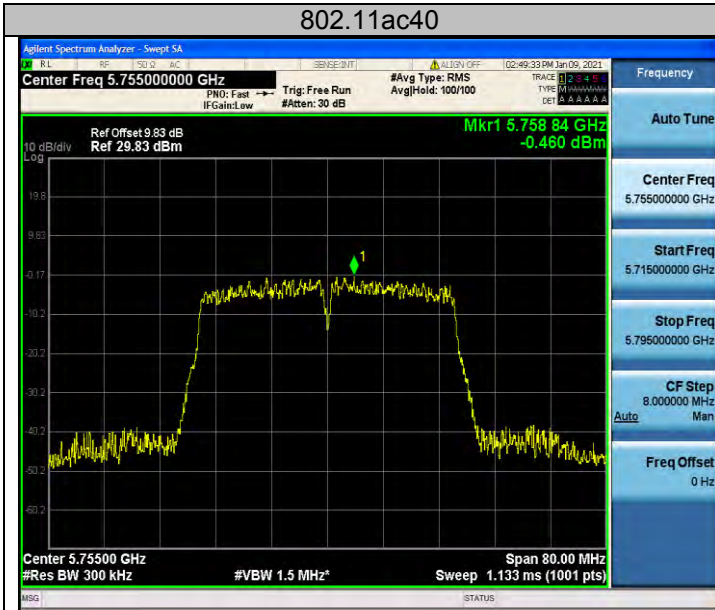

CH 159