

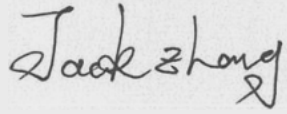

Test report No:  
2210087R-RF-US-P06V01

## FCC TEST REPORT

Product Name	Loco Tags
Trademark	System Loco
Model and /or type reference	C2PL
FCC ID	2AYMO-LT-C2PL
Applicant's name / address	System Loco Ltd Parkfield, Greaves Road, Lancaster
Test method requested, standard	FCC CFR Title 47 Part 15 Subpart C Section 15.247 ANSI C63.10: 2013 KD558074 D01 15.247 Meas Guidance v05r02 RSS-Gen Issue 5 / RSS-247 Issue 2
Verdict Summary	IN COMPLIANCE
Documented by (name / position & signature)	Tim Cao/Project Engineer 
Approved by (name / position & signature)	Jack Zhang/ Supervisor 
Date of issue	2022-01-27
Report Version	V1.1
Report template No	Template_FCC 15.247-RF-V1.0

## INDEX

	page
General conditions .....	4
Environmental conditions .....	4
Possible test case verdicts .....	5
Abbreviations .....	5
Document History .....	6
Remarks and Comments.....	6
Used Equipment .....	7
Uncertainty .....	9
1 General Information.....	10
1.1 General Description of the Item(s) .....	10
1.2 Antenna Information .....	11
1.3 Channel List .....	12
2 Description of Test Setup .....	13
2.1 Operating mode(s) used for tests.....	13
2.2 Auxiliary equipment / Test software for the EUT.....	13
2.3 Test Configuration / Block diagram used for tests .....	14
2.4 Testing process .....	15
3 Verdict summary section .....	16
3.1 Standards.....	16
3.2 Deviation(s) from the Standard(s) / Test Specification(s).....	16
3.3 Overview of results.....	17
3.4 Test Facility.....	18
4 Test Results .....	19
4.1 AC Power Line Conducted Emission .....	19
4.1.1 Limit .....	19
4.1.2 Test Setup.....	19
4.1.3 Test Procedure.....	19
4.1.4 Test Data .....	20
4.2 Emissions in restricted frequency bands .....	21
4.2.1 Limit .....	21
4.2.2 Test Setup.....	23
4.2.3 Test Procedure.....	23
4.2.4 Test Data .....	24
4.3 Emissions in non-restricted frequency band.....	32

---

4.3.1	Limit .....	32
4.3.2	Test Setup.....	32
4.3.3	Test Procedure.....	32
4.3.4	Test Data .....	33
4.4	Duty cycle .....	34
4.4.1	Limit .....	34
4.4.2	Test Setup.....	34
4.4.3	Test Procedure.....	34
4.4.4	Test Data .....	35
4.5	Radiated Emission Band Edge .....	36
4.5.1	Limit .....	36
4.5.2	Test Setup.....	36
4.5.3	Test Procedure.....	36
4.5.4	Test Data .....	37
4.6	DTS Bandwidth .....	45
4.6.1	Limit .....	45
4.6.2	Test Setup.....	45
4.6.3	Test Procedure.....	45
4.6.4	Test Data .....	46
4.7	Fundamental emission output power .....	47
4.7.1	Limit .....	47
4.7.2	Test Setup.....	47
4.7.3	Test Procedure.....	48
4.7.4	Test Data .....	49
4.8	Power Density .....	50
4.8.1	Limit:.....	50
4.8.2	Test Setup.....	50
4.8.3	Test Procedure.....	50
4.8.4	Test Data .....	51
4.9	Antenna Requirement.....	52
4.9.1	Limit:.....	52
4.9.2	Antenna Connector Construction: .....	52
5	Test setup photo and EUT Photo.....	53

## COMPETENCES AND GUARANTEES

DEKRA is a testing laboratory competent to carry out the tests described in this report.

In order to assure the traceability to other national and international laboratories, DEKRA has a calibration and maintenance program for its measurement equipment.

DEKRA guarantees the reliability of the data presented in this report, which is the result of the measurements and the tests performed to the item under test on the date and under the conditions stated in the report and it is based on the knowledge and technical facilities available at DEKRA at the time of performance of the test.

DEKRA is liable to the client for the maintenance of the confidentiality of all information related to the item under test and the results of the test.

The results presented in this Test Report apply only to the particular item under test established in this document.

**IMPORTANT:** No parts of this report may be reproduced or quoted out of context, in any form or by any means, except in full, without the previous written permission of DEKRA.

## GENERAL CONDITIONS

Test Location	No. 99, Hongye Road, Suzhou Industrial Park Suzhou, 215006, P.R. China
Date(receive sample)	Jan. 05, 2022
Date (start test)	Jan. 10, 2021
Date (finish test)	Jan. 21, 2021

1. This report is only referred to the item that has undergone the test.
2. This report does not constitute or imply on its own an approval of the product by the Certification Bodies or Competent Authorities.
3. This document is only valid if complete; no partial reproduction can be made without previous written permission of DEKRA.
4. This test report cannot be used partially or in full for publicity and/or promotional purposes without previous written permission of DEKRA.

## ENVIRONMENTAL CONDITIONS

The climatic conditions during the tests are within the limits specified by the manufacturer for the operation of the EUT and the test equipment. The climatic conditions during the tests were within the following limits:

Ambient temperature	15 °C – 35 °C
Relative Humidity air	30% - 60%

If explicitly required in the basic standard or applied product / product family standard the climatic values are recorded and documented separately in this test report.

## POSSIBLE TEST CASE VERDICTS

Test case does not apply to test object	N/A
Test object does meet requirement	P (Pass) / PASS
Test object does not meet requirement	F (Fail) / FAIL
Not measured	N/M

## ABBREVIATIONS

For the purposes of the present document, the following abbreviations apply:

EUT	: Equipment Under Test
QP	: Quasi-Peak
CAV	: CISPR Average
AV	: Average
CDN	: Coupling Decoupling Network
SAC	: Semi-Anechoic Chamber
OATS	: Open Area Test Site
BW	: Bandwidth
AM	: Amplitude Modulation
PM	: Pulse Modulation
HCP	: Horizontal Coupling Plane
VCP	: Vertical Coupling Plane
$U_N$	: Nominal voltage
$T_x$	: Transmitter
$R_x$	: Receiver
N/A	: Not Applicable
N/M	: Not Measured

## DOCUMENT HISTORY

Report No.	Version	Description	Issued Date
2210087R-RF-US-P06V01	V1.0	Initial issue of report.	2022-01-24
2210087R-RF-US-P06V01	V1.1	Page 25& 51: Update correct test data. (The test report No.: 2210087R-RF-US-P06V01 V1.1 is to replace the test report No.: 2210087R-RF-US-P06V01 V1.0, and test report 2210087R-RF-US-P06V01 V1.0 is obsoleted.)	2022-01-27

## REMARKS AND COMMENTS

1. The equipment under test (EUT) does meet the essential requirements of the stated standard(s)/test(s).
2. These test results on a sample of the device are for the purpose of demonstrating Compliance with Part 15 Subpart C Paragraph 15.247, RSS-Gen Issue 5, RSS-247 Issue 2.
3. The measurement result is considered in conformance with the requirement if it is within the prescribed limit, It is not necessary to account the uncertainty associated with the measurement result.
4. The test results presented in this report relate only to the object tested.
5. The test report shall not be reproduced without the written approval of DEKRA Testing and Certification (Suzhou) Co., Ltd.
6. This report will not be used for social proof function in China market.
7. DEKRA declines any responsibility with the following test data provided by customer that may affect the validity of result:
  - Chapter 1.1 General Description of the Item(s);
  - Chapter 1.2 Antenna Informaion;
  - Chapter 1.3 Channel List.

## USED EQUIPMENT

### AC Power Line Conducted Emission / TR1

Instrument	Manufacturer	Model No.	Serial No.	Cal. Date	Next Cal. Date
EMI Test Receiver	R&S	ESCI	100906	2021.04.28	2022.04.27
Two-Line V-Network	R&S	ENV216	101044	2021.03.20	2022.03.19
50ohm Termination	SHX	TF2	7081402	2021.09.04	2022.09.03
50ohm Termination	SHX	TF2	7081403	2021.09.04	2022.09.03
50ohm Coaxial Switch	Anritsu	MP59B	6200464462	N/A	N/A
Temperature/Humidity Meter	RTS	RTS-8S	TR1-TH	2021.07.09	2022.07.08
Dekra test software	Dekra	-	-	-	-

### Emissions in non-restricted frequency bands/ Occupied Bandwidth/ Fundamental emission output power Power Spectral Density / TR8

Instrument	Manufacturer	Model No.	Serial No.	Cal. Date	Next Cal. Date
Spectrum Analyzer	Agilent	N9010A	MY48030494	2021.07.11	2022.07.10
EXA Spectrum Analyzer	Keysight	N9010A	MY55370495	2021.03.20	2022.03.19
Coaxial Cable	Woken	A50-SMAMSMAM-1m	20111443	2021.06.10	2022.06.09
Temperature/Humidity Meter	RTS	RTS-8S	RF08	2021.07.09	2022.07.08

### Radiated Emission(30MHz-1GHz) / AC2

Instrument	Manufacturer	Model No.	Serial No.	Cal. Date	Next Cal. Date
EMI Test Receiver	R&S	ESCI	100176	2021.08.15	2022.08.14
Loop Antenna	R&S	HFH2-Z2	833799/003	2021.03.04	2022.03.03
TRILOG Broadband Antenna	SCHWARZBECK	VULB 9168	1231	2021.04.19	2022.04.18
Coaxial Cable	Huber+Suhner	RG 214	AC3-C	2021.03.31	2022.03.30
Temperature/Humidity Meter	RTS	RTS-8S	AC3-TH	2021.11.23	2022.11.22

## Radiated Emission / AC5(1GHz-40GHz)

Instrument	Manufacturer	Model No.	Serial No.	Cal. Date	Next Cal. Date
EXA Spectrum Analyzer	Keysight	N9010A	MY55370495	2021.03.20	2022.03.19
Amplifier	Keleto	LNPA	SK20190225	2021.09.26	2022.09.25
Pre-Amplifier	EMCI	EMC184045SE	980263	2021.05.22	2022.05.21
DRG Horn Antenna	ETS-Lindgren	3117	167055	2021.08.06	2022.08.05
Broad-Band Horn Antenna	Schwarzbeck	BBHA9170	294	2021.04.19	2022.04.18
Coaxial Cable	Huber+Suhner	SUCOFLEX 106	AC5-C2	2021.03.31	2022.03.30
Coaxial Cable	ROSENBERGER	LA1-C011-2000/3000	AC5-40G	2021.03.20	2022.03.19



## UNCERTAINTY

Uncertainties have been calculated according to the DEKRA internal document. The reported expanded uncertainties are based on a standard uncertainty multiplied by a coverage factor of  $k=2$ , providing a level of confidence of approximately 95% .

Test item	Uncertainty
AC Power Line Conducted Emission	9kHz~150kHz: 2.80dB 150kHz~30MHz: 2.40dB
Peak Power Output	$\pm 1.27$ dB
Radiated Emission(30MHz~1GHz)	Horizontal: 30MHz~200MHz: 3.50 dB 300MHz~1GHz: 3.60 dB Vertical: 30MHz~200MHz: 3.60 dB 300MHz~1GHz: 3.50 dB
Radiated Emission(1GHz~26.5GHz)	Horizontal: 1GHz~18GHz: 5.00 dB Vertical: 1GHz~18GHz: 4.80 dB
RF antenna conducted test	$\pm 1.27$ dB
Radiated Emission Band Edge	$\pm 3.9$ dB
DTS Bandwidth	$\pm 150$ Hz
Occupied Bandwidth	$\pm 1$ kHz
Power Density	$\pm 1.27$ dB

# 1 GENERAL INFORMATION

## 1.1 General Description of the Item(s)

Product Name..... :	Loco Tags
Model No. .... :	C2PL
Trademark ..... :	System Loco
FCC ID ..... :	2AYMO-LT-C2PL
Manufacturer..... :	System Loco Ltd
Manufacturer address ..... :	Parkfield, Greaves Road, Lancaster
Factory ..... :	Qisda Corp
Factory Address..... :	169 Zhujiang Road, New District, Suzhou

Wireless specification..... :	BLE
Operating frequency range(s)	2400~2483.5MHz
Type of Modulation..... :	GFSK
Data Rate ..... :	1Mbps
Number of channel..... :	3

Rated power supply .....	Voltage and Frequency	
	<input type="checkbox"/>	AC: 220 – 240 V, 50/60 Hz
	<input type="checkbox"/>	AC: 100 – 240 V, 50/60 Hz
	<input type="checkbox"/>	DC: 5 V
	<input checked="" type="checkbox"/>	Battery: 4.8 Vdc
Mounting position..... :	<input checked="" type="checkbox"/>	Table top equipment
	<input type="checkbox"/>	Wall/Ceiling mounted equipment
	<input type="checkbox"/>	Floor standing equipment
	<input type="checkbox"/>	Hand-held equipment
	<input type="checkbox"/>	Other: .....

## 1.2 Antenna Information

Antenna model / type number.....:	SZ22-001-R01		
Antenna serial number .....	N/A		
Antenna Delivery .....	<input checked="" type="checkbox"/>	1TX + 1RX	
	<input type="checkbox"/>	2TX + 2RX	
	<input type="checkbox"/>	Others:.....	
Antenna technology.....:	<input checked="" type="checkbox"/>	SISO	
	<input type="checkbox"/>	MIMO	<input type="checkbox"/> CDD
			<input type="checkbox"/> Beam-forming
Antenna Type.....:	<input type="checkbox"/>	External	<input type="checkbox"/> Dipole
			<input type="checkbox"/> Sectorized
	<input checked="" type="checkbox"/>	Internal	<input type="checkbox"/> Ceramic Chip
			<input type="checkbox"/> PIFA
			<input checked="" type="checkbox"/> PCB
			<input type="checkbox"/> Others.....
Antenna Gain.....:	2.68 dBi		

### 1.3 Channel List

Working Frequency of Each Channel:							
Channel	Frequency	Channel	Frequency	Channel	Frequency	Channel	Frequency
37	2402 MHz	38	2426MHz	39	2480 MHz	--	--

Note: The General Description of the Item, antenna information and Channel List for the EUT in clause 1 are provided and confirmed by the client.

## 2 DESCRIPTION OF TEST SETUP

### 2.1 Operating mode(s) used for tests

During the tests the following operating mode(s) has(have) been used.

Test Mode For Bluetooth	Mode 1: Transmit by BLE
-------------------------	-------------------------

### 2.2 Auxiliary equipment / Test software for the EUT

Auxiliary equipment	Type / Version	Manufacturer	Supplied by
Notebook	Think pad L440	Lenovo	Adapter
software	Type / Version	Manufacturer	Supplied by
SecureCRT	N/A	N/A	N/A

### 2.3 Test Configuration / Block diagram used for tests

Test setup Diagram- Radiated Test

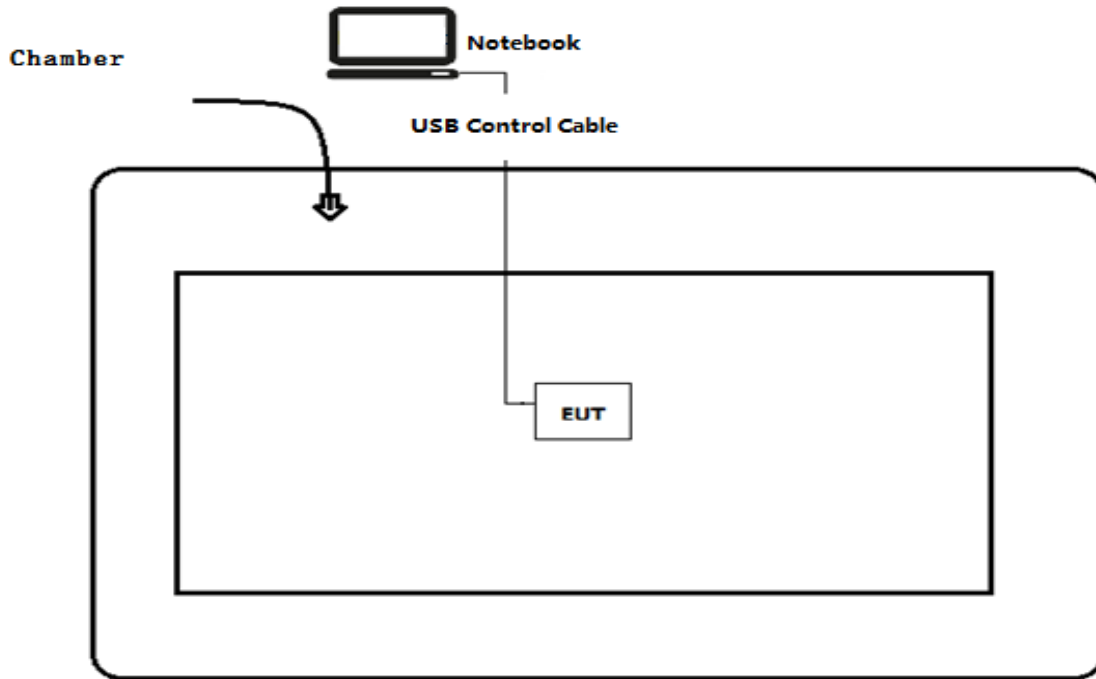

Test setup Diagram- Conducted test

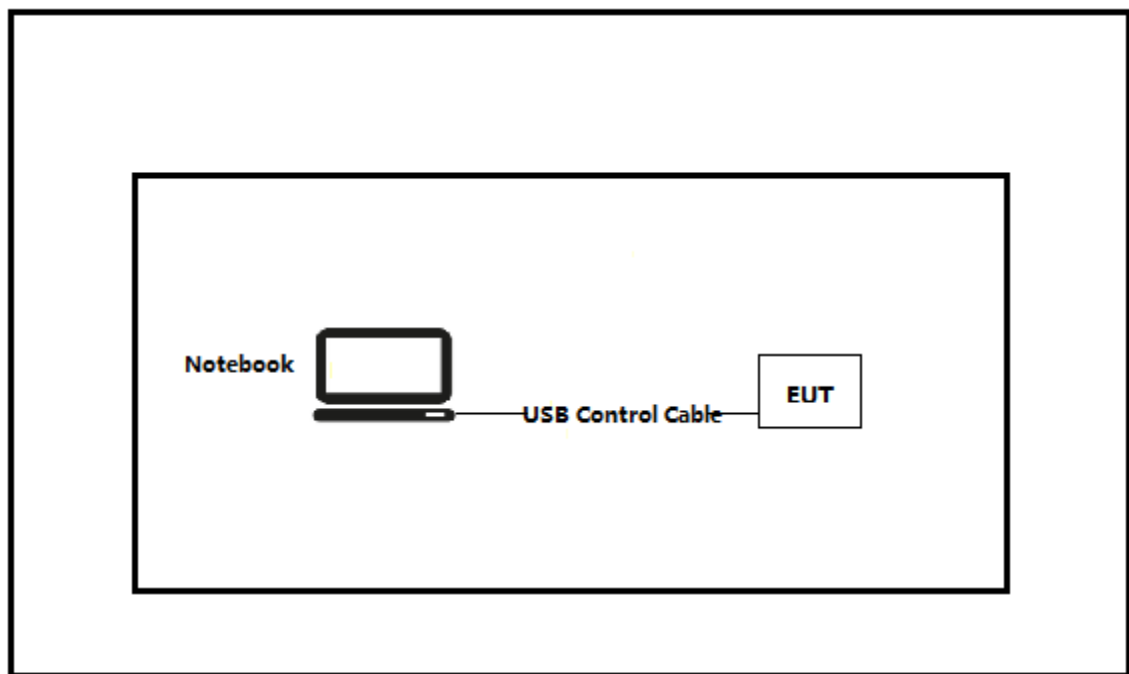

## 2.4 Testing process

1	Setup the EUT as shown in Section 2.3.
2	Run the software "SecureCRT" on the notebook computer.
3	Configure the test mode, the test channel, and the data rate.
4	Verify that the EUT works properly.

### 3 VERDICT SUMMARY SECTION

This chapter presents an overview of standards and results. Refer to the next chapters for details of measured test results and applied test levels.

#### 3.1 Standards

Standard	Year	Description
FCC CFR Title 47 Part 15 Subpart C Section 15.247	2020	Operation within the bands 902–928 MHz, 2400–2483.5 MHz, and 5725–5850 MHz.
ANSI C63.10	2013	American National Standard of Procedures for Compliance Testing of Unlicensed Wireless Devices
KDB 558074 D01 v05r02	2019	Guidance for performing compliance measurements on Digital Transmission System (DTS) operating under section 15.247

#### 3.2 Deviation(s) from the Standard(s) / Test Specification(s)

The following deviation(s) was / were made from the published requirements of the listed standards: N/A.

*(Please define the deviations from the standard(s) if applicable)*



### 3.3 Overview of results

Requirement – Test case	Basic standard(s)	Verdict	Remark
AC Power Line Conducted Emission	FCC 15.207	N/A	---
Emissions in restricted frequency bands	FCC 15.247(b)(3)	PASS	---
Duty cycle	ANSI C63.10:2013	PASS	---
Emissions in non-restricted frequency bands	FCC 15.247(d), FCC 15.209	PASS	---
Radiated Emission Band Edge	FCC 15.247(d)	PASS	---
Fundamental emission output power	FCC 15.247(d), FCC 15.209	PASS	---
DTS Bandwidth	FCC 15.247(a)(2)	PASS	---
Power Spectral Density	FCC 15.247(e)	PASS	---
Antenna Requirement	FCC 15.203	PASS	---

---

### 3.4 Test Facility

USA : FCC Designation Number: CN1199

## 4 TEST RESULTS

### 4.1 AC Power Line Conducted Emission

VERDICT: N/A

#### 4.1.1 Limit

Standard		
FCC Part 15 Subpart C Paragraph 15.207		
Frequency range [MHz]	Limit: QP [dB(μV) <sup>1)</sup>	Limit: AV [dB(μV) <sup>1)</sup>
0,15 - 0,50	66 - 56 <sup>2)</sup>	56 - 46 <sup>2)</sup>
0,50 - 5,0	56	46
5,0 - 30	60	50

<sup>1)</sup> At the transition frequency, the lower limit applies.

<sup>2)</sup> The limit decreases linearly with the logarithm of the frequency.

**NOTE 1:** The exclusion band for transmitters shall be considered for transmitters operating at frequencies below 30 MHz.

**NOTE 2:** Where the AC output port is directly connected (or via a circuit breaker) to the AC power input port of the EUT the AC power output port need not to be tested.

#### 4.1.2 Test Setup

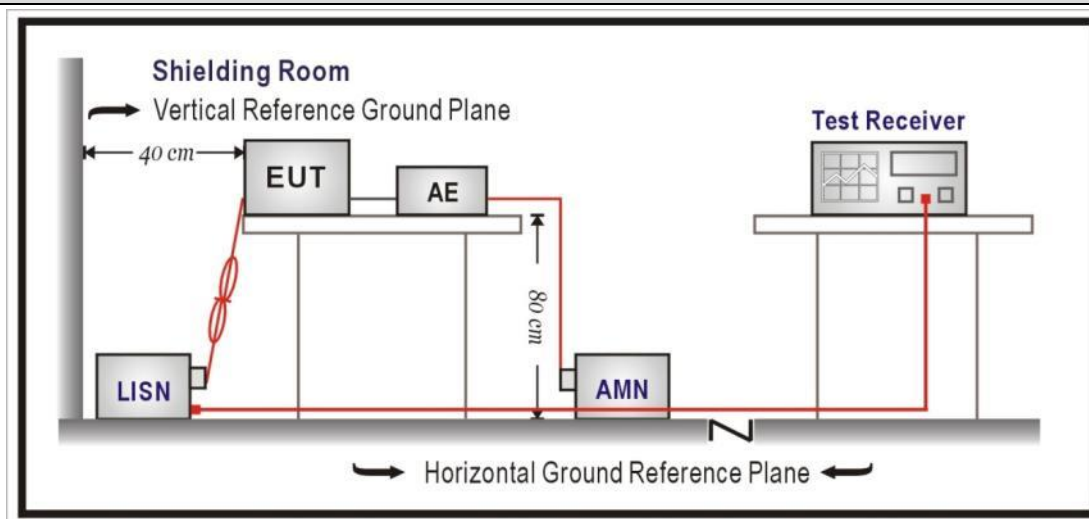

#### 4.1.3 Test Procedure

References Rule	Chapter	Item
<input checked="" type="checkbox"/> ANSI C63.10-2013	6.2	Standard test method for ac power-line conducted emissions from unlicensed wireless devices

#### 4.1.4 Test Data

Note: This device is battery powered, so this item is not applicable.

**4.2 Emissions in restricted frequency bands****VERDICT: PASS****4.2.1 Limit****Standard**

FCC Part 15 Subpart C Paragraph 15.207

## Restricted Bands of operation

Frequency (MHz)	Frequency (MHz)	Frequency (MHz)	Frequency (GHz)
0.090 – 0.110	16.42 – 16.423	399.9 – 410	4.5 – 5.15
0.495 – 0.505	16.69475 – 16.69525	608 – 614	5.35 – 5.46
2.1735 – 2.1905	16.80425 – 16.80475	960 – 1240	7.25 – 7.75
4.125 – 4.128	25.5 – 25.67	1300 – 1427	8.025 – 8.5
4.17725 – 4.17775	37.5 – 38.25	1435 – 1626.5	9.0 – 9.2
4.20725 – 4.20775	73 – 74.6	1645.5 – 1646.5	9.3 – 9.5
6.215 – 6.218	74.8 – 75.2	1660 – 1710	10.6 – 12.7
6.26775 – 6.26825	108 – 121.94	1718.8 – 1722.2	13.25 – 13.4
6.31175 – 6.31225	123 – 138	2200 – 2300	14.47 – 14.5
8.291 – 8.294	149.9 – 150.05	2310 – 2390	15.35 – 16.2
8.362 – 8.366	156.52475 – 156.52525	2483.5 – 2500	17.7 – 21.4
8.37625 – 8.38675	156.7 – 156.9	2690 – 2900	22.01 – 23.12
8.81425 – 8.81475	162.0125 – 167.17	3260 – 3267	23.6 – 24.0
12.29 – 12.293	167.72 – 173.2	3332 – 3339	31.2 – 31.8
12.51975 – 12.52025	240 – 285	3345.8 – 3358	36.43 – 36.5
12.57675 – 12.57725	322 – 335.4	3600 – 4400	
13.36 – 13.41			

Restricted Band Emissions Limit			
Frequency (MHz)	Field strength (μV/m)	Field strength (dBμV/m)	Measurement distance (m)
0.009 - 0.49	2400/F(kHz)	48.5 – 13.8	300 <sup>(Note 1)</sup>
0.49 - 1.705	24000/F(kHz)	33.8 - 23	30 <sup>(Note 1)</sup>
1.705 - 30	30	29.5	30 <sup>(Note 1)</sup>
30 - 88	100	40	3 <sup>(Note 2)</sup>
88 - 216	150	43.5	3 <sup>(Note 2)</sup>
216 - 960	200	46	3 <sup>(Note 2)</sup>
Above 960	500	54	3 <sup>(Note 2)</sup>

Note 1: At frequencies below 30 MHz, measurements may be performed at a distance closer than that specified in the regulations; however, an attempt should be made to avoid making measurements in the near field. Pending the development of an appropriate measurement procedure for measurements performed below 30 MHz, when performing measurements at a closer distance than specified, the results shall be extrapolated to the specified distance by either making measurements at a minimum of two distances on at least one radial to determine the proper extrapolation factor or by using the square of an inverse linear distance extrapolation factor (40 dB/decade).

Note 2: At frequencies at or above 30 MHz, measurements may be performed at a distance other than what is specified provided: measurements are not made in the near field except where it can be shown that near field measurements are appropriate due to the characteristics of the device; and it can be demonstrated that the signal levels needed to be measured at the distance employed can be detected by the measurement equipment.

Measurements shall not be performed at a distance greater than 30 meters unless it can be further demonstrated that measurements at a distance of 30 meters or less are impractical. When performing measurements at a distance other than that specified, the results shall be extrapolated to the specified distance using an extrapolation factor of 20 dB/decade (inverse linear-distance for field strength measurements; inverse-linear-distance-squared for power density measurements).

### 4.2.2 Test Setup

30MHz-1GHz Test Setup:

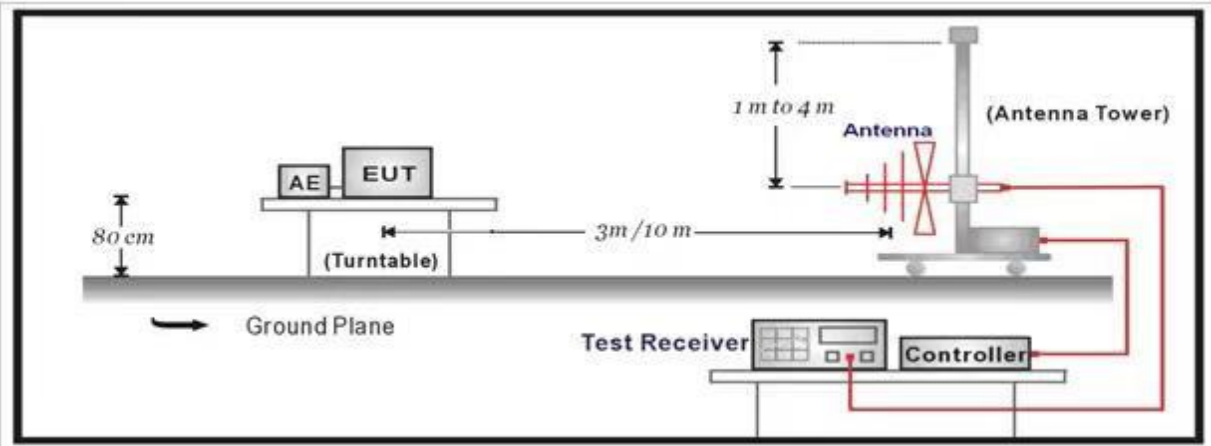

Above 1GHz Test Setup:

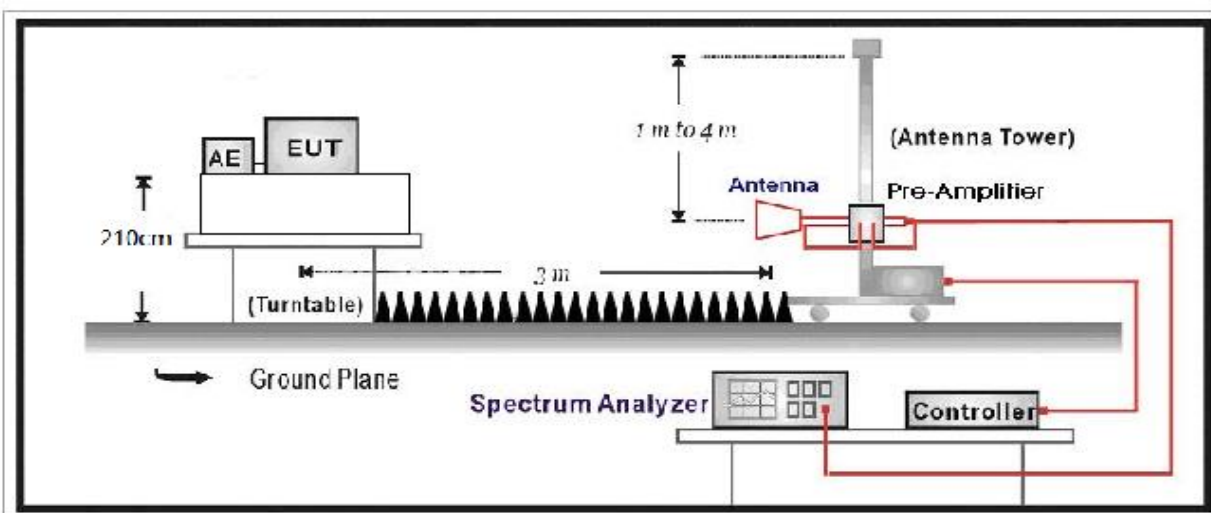

### 4.2.3 Test Procedure

	References Rule	Chapter	Description
<input checked="" type="checkbox"/>	ANSI C63.10	11.12	Emissions in restricted frequency bands
	<input checked="" type="checkbox"/> ANSI C63.10	11.12.1	Radiated emission measurements
	<input checked="" type="checkbox"/> ANSI C63.10	11.12.2.7	Radiated spurious emission test
	<input checked="" type="checkbox"/> ANSI C63.10	6.4	Radiated emissions from unlicensed wireless devices below 30 MHz
	<input checked="" type="checkbox"/> ANSI C63.10	6.5	Radiated emissions from unlicensed wireless devices in the frequency range of 30 MHz to 1000 MHz
	<input checked="" type="checkbox"/> ANSI C63.10	6.6	Radiated emissions from unlicensed wireless devices above 1 GHz

**4.2.4 Test Data**

Profile: 2210087R	Page No.: 1
Engineer: Carlos shen	
Site: AC5	Time: 2022/01/20 - 11:28
Limit: FCC_Part15.209_RE(3m)	Margin: 0
Probe: Horn_3117_00123988_(1-18GHz)	Polarity: Vertical
EUT: C2PL	Power: Battery
Note: Mode 1:Transmit at 2402MHz by ble	

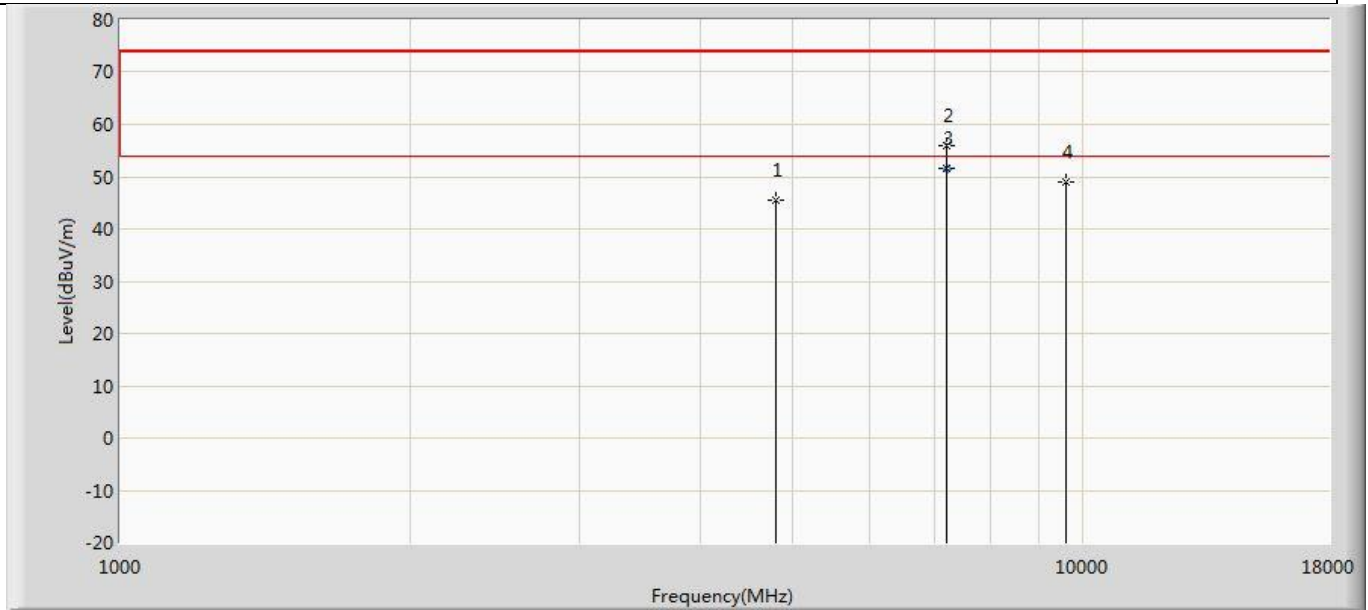

No	Mark	Frequency (MHz)	Measure Level (dBuV/m)	Reading Level (dBuV)	Over Limit (dB)	Limit (dBuV/m)	Factor (dB)	Type
1		4804.000	45.633	51.775	-28.367	74.000	-6.143	PK
2		7205.000	56.050	58.356	-17.950	74.000	-2.306	PK
3	*	7206.000	51.658	53.980	-2.342	54.000	-2.322	AV
4		9608.000	48.997	46.546	-25.003	74.000	2.451	PK



Profile: 2210087R	Page No.: 2
Engineer: Carlos shen	
Site: AC5	Time: 2022/01/20 - 11:28
Limit: FCC_Part15.209_RE(3m)	Margin: 0
Probe: Horn_3117_00123988_(1-18GHz)	Polarity: Horizontal
EUT: C2PL	Power: Battery
Note: Mode 1:Transmit at 2402MHz by ble	

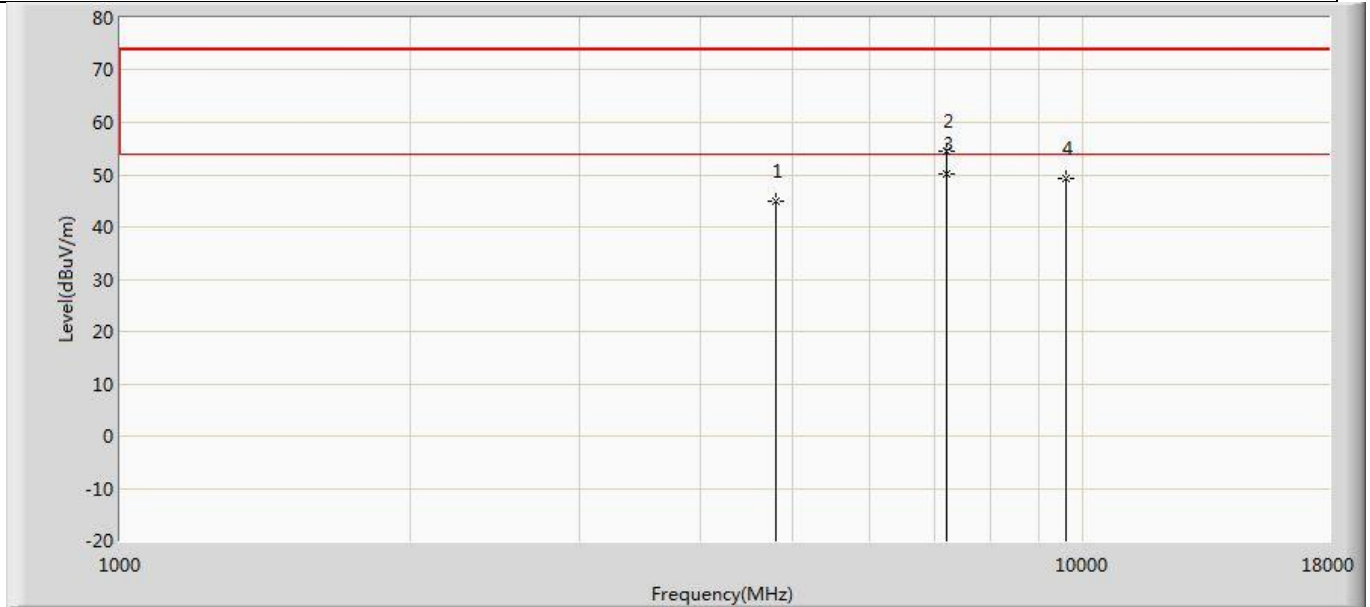

No	Mark	Frequency (MHz)	Measure Level (dBuV/m)	Reading Level (dBuV)	Over Limit (dB)	Limit (dBuV/m)	Factor (dB)	Type
1		4804.000	44.817	50.959	-29.183	74.000	-6.143	PK
2	*	7205.000	54.498	56.804	-19.502	74.000	-2.306	PK
3		7206.000	50.021	52.343	-23.979	74.000	-2.322	AV
4		9608.000	49.253	46.802	-24.747	74.000	2.451	PK

Profile: 2210087R	Page No.: 3
Engineer: Carlos shen	
Site: AC5	Time: 2022/01/20 - 11:28
Limit: FCC_Part15.209_RE(3m)	Margin: 0
Probe: Horn_3117_00123988_(1-18GHz)	Polarity: Vertical
EUT: C2PL	Power: Battery
Note: Mode 1: Transmit at 2426MHz by ble	

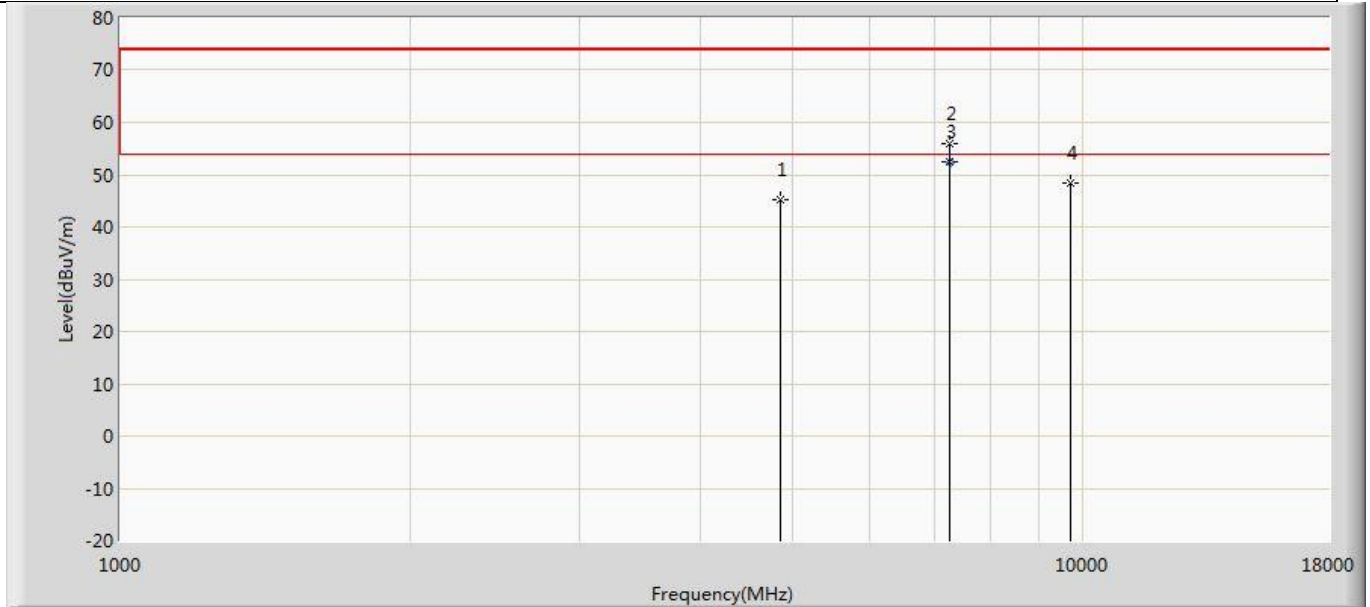

No	Mark	Frequency (MHz)	Measure Level (dBuV/m)	Reading Level (dBuV)	Over Limit (dB)	Limit (dBuV/m)	Factor (dB)	Type
1		4852.000	45.329	50.963	-28.671	74.000	-5.634	PK
2		7278.000	55.799	57.634	-18.201	74.000	-1.835	PK
3	*	7278.000	52.474	54.309	-1.526	54.000	-1.835	AV
4		9704.000	48.294	46.958	-25.706	74.000	1.336	PK

Profile: 2210087R	Page No.: 4
Engineer: Carlos shen	
Site: AC5	Time: 2022/01/20 - 11:28
Limit: FCC_Part15.209_RE(3m)	Margin: 0
Probe: Horn_3117_00123988_(1-18GHz)	Polarity: Horizontal
EUT: C2PL	Power: Battery
Note: Mode 1: Transmit at 2426MHz by ble	

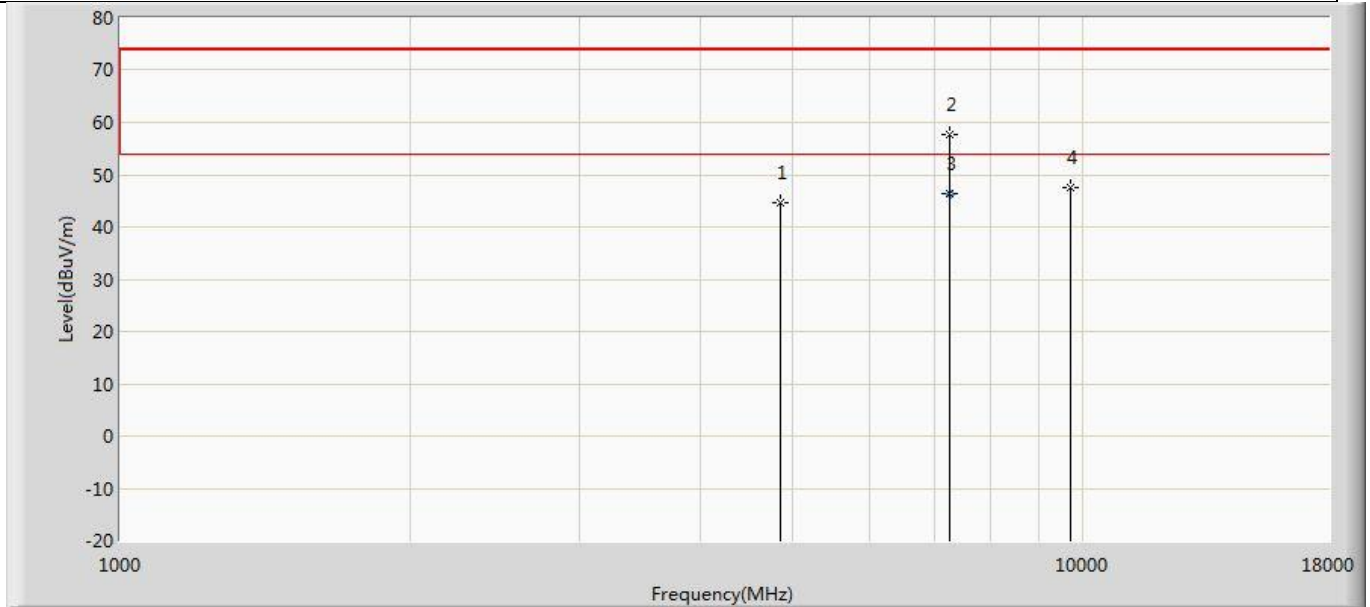

No	Mark	Frequency (MHz)	Measure Level (dBuV/m)	Reading Level (dBuV)	Over Limit (dB)	Limit (dBuV/m)	Factor (dB)	Type
1		4852.000	44.770	50.404	-29.230	74.000	-5.634	PK
2		7278.000	57.688	59.523	-16.312	74.000	-1.835	PK
3	*	7278.000	46.251	48.086	-7.749	54.000	-1.835	AV
4		9704.000	47.527	46.191	-26.473	74.000	1.336	PK

Profile: 2210087R	Page No.: 5
Engineer: Carlos shen	
Site: AC5	Time: 2022/01/20 - 11:28
Limit: FCC_Part15.209_RE(3m)	Margin: 0
Probe: Horn_3117_00123988_(1-18GHz)	Polarity: Vertical
EUT: C2PL	Power: Battery
Note: Mode 1:Transmit at 2480MHz by ble	

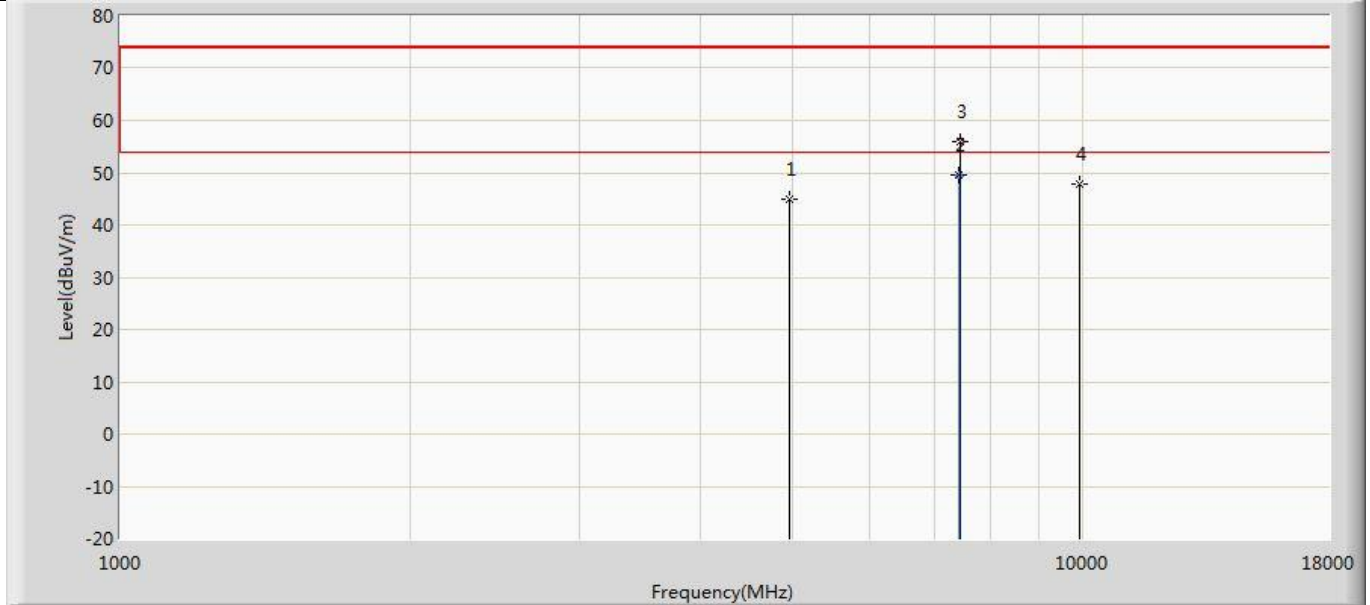

No	Mark	Frequency (MHz)	Measure Level (dBuV/m)	Reading Level (dBuV)	Over Limit (dB)	Limit (dBuV/m)	Factor (dB)	Type
1		4960.000	44.986	50.352	-29.014	74.000	-5.365	PK
2	*	7440.000	49.599	52.462	-4.401	54.000	-2.863	AV
3		7443.000	55.836	58.773	-18.164	74.000	-2.937	PK
4		9920.000	47.926	47.010	-26.074	74.000	0.916	PK

Profile: 2210087R	Page No.: 6
Engineer: Carlos shen	
Site: AC5	Time: 2022/01/20 - 11:28
Limit: FCC_Part15.209_RE(3m)	Margin: 0
Probe: Horn_3117_00123988_(1-18GHz)	Polarity: Horizontal
EUT: C2PL	Power: Battery
Note: Mode 1:Transmit at 2480MHz by ble	

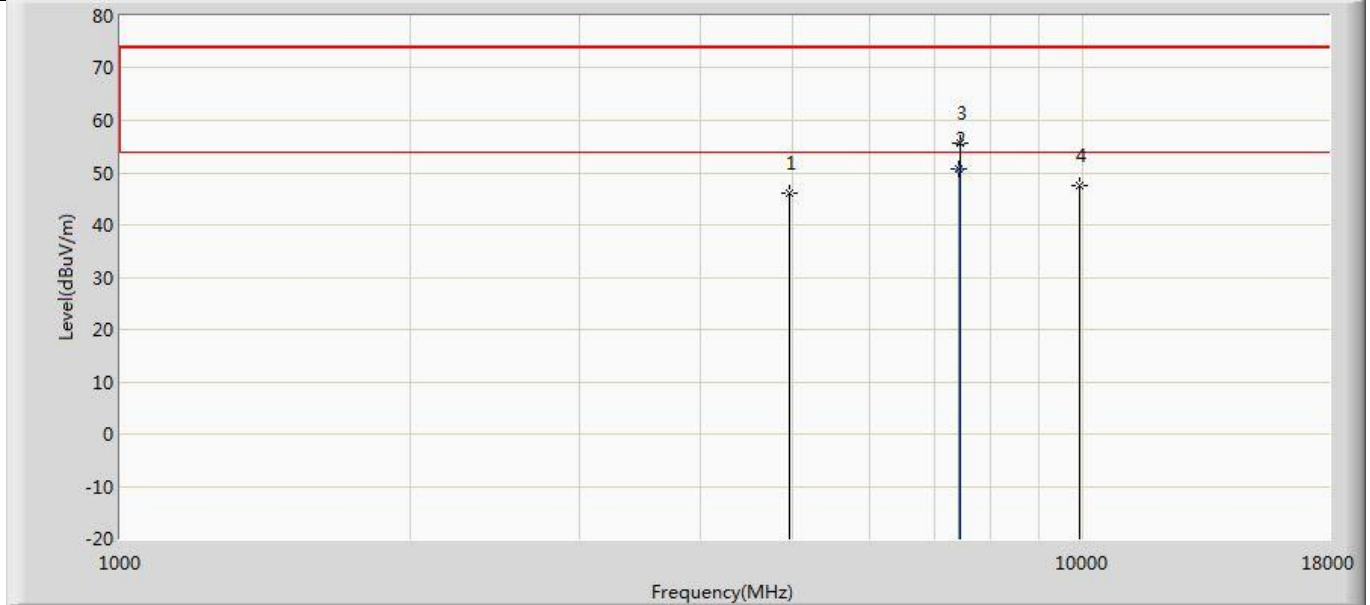

No	Mark	Frequency (MHz)	Measure Level (dBuV/m)	Reading Level (dBuV)	Over Limit (dB)	Limit (dBuV/m)	Factor (dB)	Type
1		4960.000	46.057	51.423	-27.943	74.000	-5.365	PK
2	*	7440.000	50.806	53.669	-3.194	54.000	-2.863	AV
3		7443.000	55.757	58.694	-18.243	74.000	-2.937	PK
4		9920.000	47.648	46.732	-26.352	74.000	0.916	PK

**The worst case of emissions in restricted frequency bands below 1GHz:**

Profile: 2210087R	Page No.: 35
Engineer: Carlos shen	
Site: AC2	Time: 2021/12/17 - 03:57
Limit: FCC_Part15.209_RE(3m)	Margin: 0
Probe: AC2_3M(30-1000M)	Polarity: Horizontal
EUT: C2PL	Power: Battery
Note: Mode1	

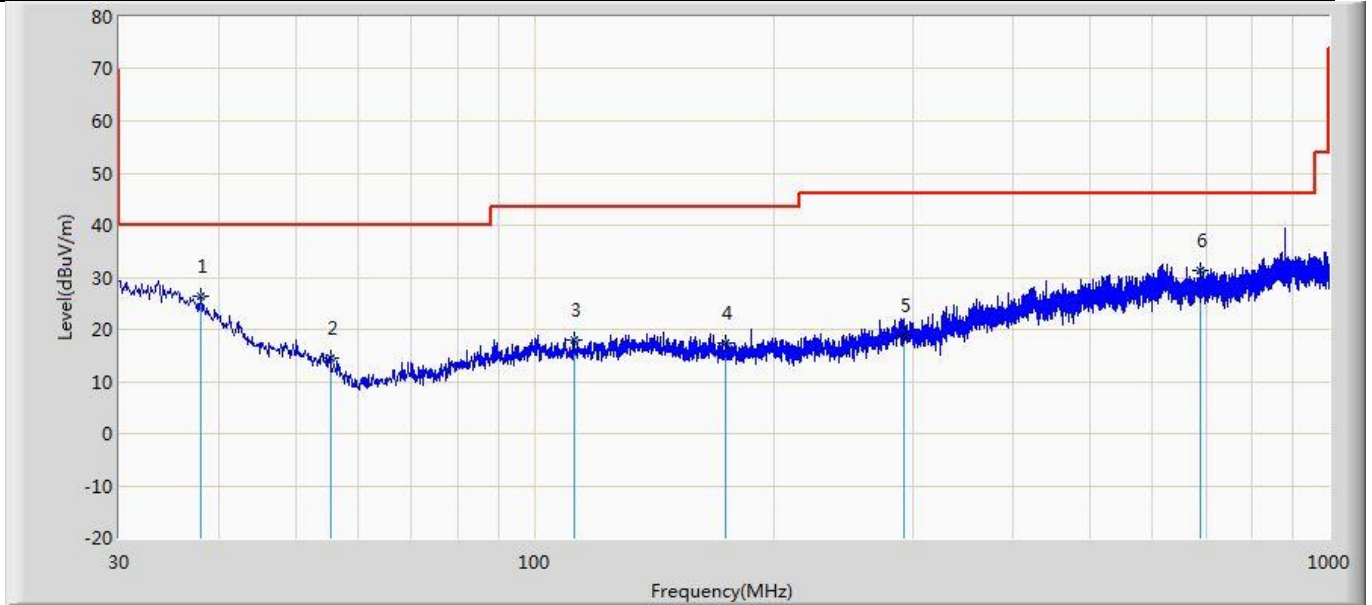

No	Mark	Frequency (MHz)	Measure Level (dBuV/m)	Reading Level (dBuV)	Over Limit (dB)	Limit (dBuV/m)	Factor (dB)	Type
1	*	38.002	26.298	2.182	-13.702	40.000	24.116	QP
2		55.341	14.624	1.430	-25.376	40.000	13.194	QP
3		112.086	18.001	1.571	-25.499	43.500	16.431	QP
4		173.681	17.446	0.347	-26.054	43.500	17.099	QP
5		292.021	18.875	-1.664	-27.125	46.000	20.540	QP
6		688.751	31.401	2.133	-14.599	46.000	29.268	QP

Profile: 2210087R	Page No.: 36
Engineer: Carlos shen	
Site: AC2	Time: 2021/12/17 - 03:59
Limit: FCC_Part15.209_RE(3m)	Margin: 0
Probe: AC2_3M(30-1000M)	Polarity: Vertical
EUT: C2PL	Power: Battery
Note: Mode1	

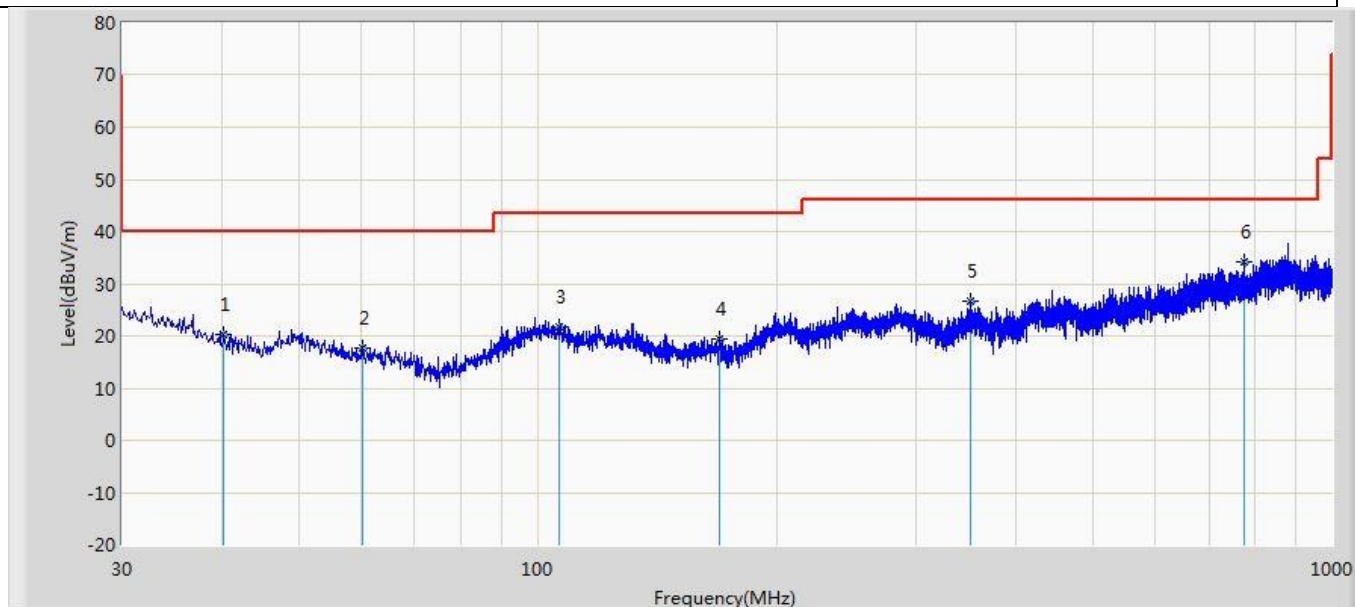

No	Mark	Frequency (MHz)	Measure Level (dBuV/m)	Reading Level (dBuV)	Over Limit (dB)	Limit (dBuV/m)	Factor (dB)	Type
1		40.306	20.305	1.397	-19.695	40.000	18.907	QP
2		60.312	17.825	1.653	-22.175	40.000	16.172	QP
3		106.509	21.824	-0.052	-21.676	43.500	21.876	QP
4		169.680	19.554	0.623	-23.946	43.500	18.931	QP
5		350.949	26.735	1.818	-19.265	46.000	24.917	QP
6	*	774.354	34.278	3.390	-11.722	46.000	30.887	QP

Note:

1. All Readings below 1GHz are Quasi-Peak, above are performed with peak and/or average measurements as necessary.
2. " \* ", means this data is the worst emission level.
3. Measurement Level = Reading Level + Factor(Probe+Cable-Amp).

**4.3 Emissions in non-restricted frequency band**

**VERDICT: PASS**

**4.3.1 Limit**

<b>Standard</b>	FCC Part 15 Subpart C Paragraph 15.247(d)	
RF Output power (Detection methods)	Limit(dB)	
RF Output power(Average detector)	30dBc(Note1)	
RF Output power(PK detector)	20dBc(Note2)	

Note 1: If maximum conducted (average) output power was used to demonstrate compliance as described in 9.2, then the peak power in any 100 kHz bandwidth outside of the authorized frequency band shall be attenuated by at least 30 dB relative to the maximum in-band peak PSD level in 100 kHz (i.e., 30 dBc).

Note 2: If the maximum peak conducted output power procedure was used, then the peak output power measured in any 100 kHz bandwidth outside of the authorized frequency band shall be attenuated by at least 20 dB relative to the maximum in-band peak PSD level in 100 kHz (i.e., 20 dBc).

**4.3.2 Test Setup**

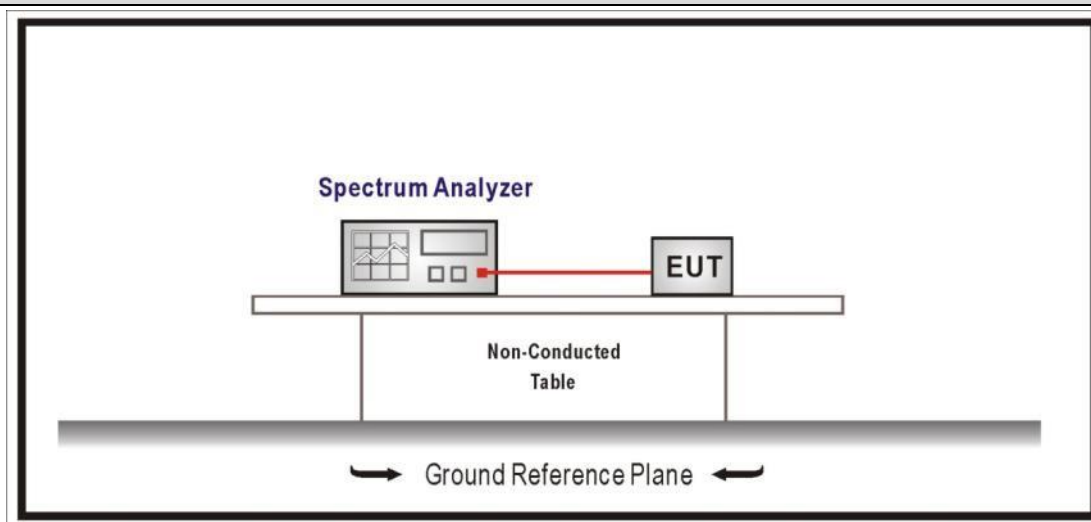

**4.3.3 Test Procedure**

References Rule	Chapter	Description
<input checked="" type="checkbox"/> ANSI C63.10	11.11	Emissions in non-restricted frequency bands
<input checked="" type="checkbox"/> ANSI C63.10	11.11.1	General
<input checked="" type="checkbox"/> ANSI C63.10	11.11.2	Reference level measurement
<input checked="" type="checkbox"/> ANSI C63.10	11.11.3	Emission level measurement



### 4.3.4 Test Data

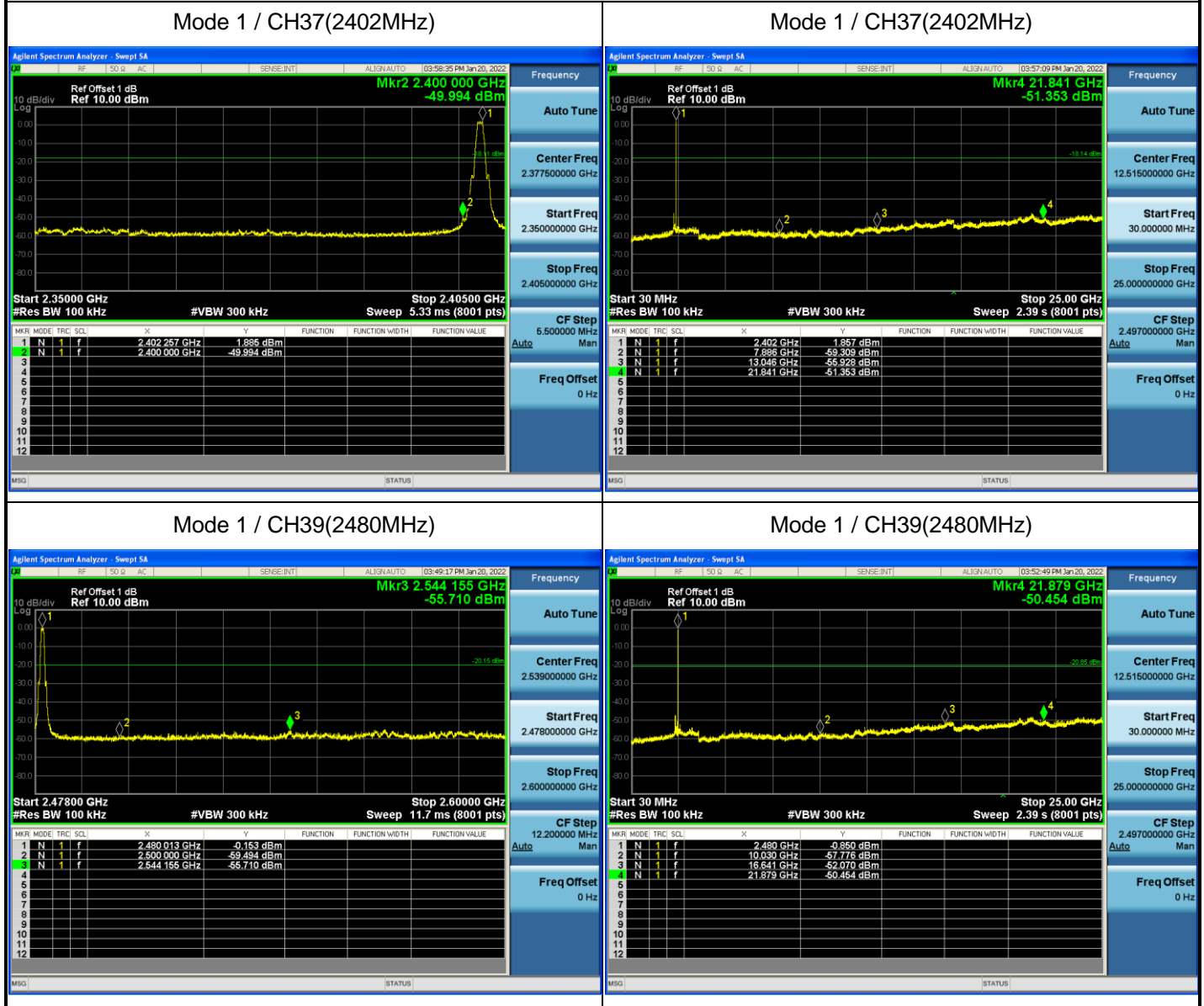

<b>4.4 Duty cycle</b>	<b>VERDICT: PASS</b>
-----------------------	----------------------

<b>4.4.1 Limit</b>
N/A

**4.4.2 Test Setup**

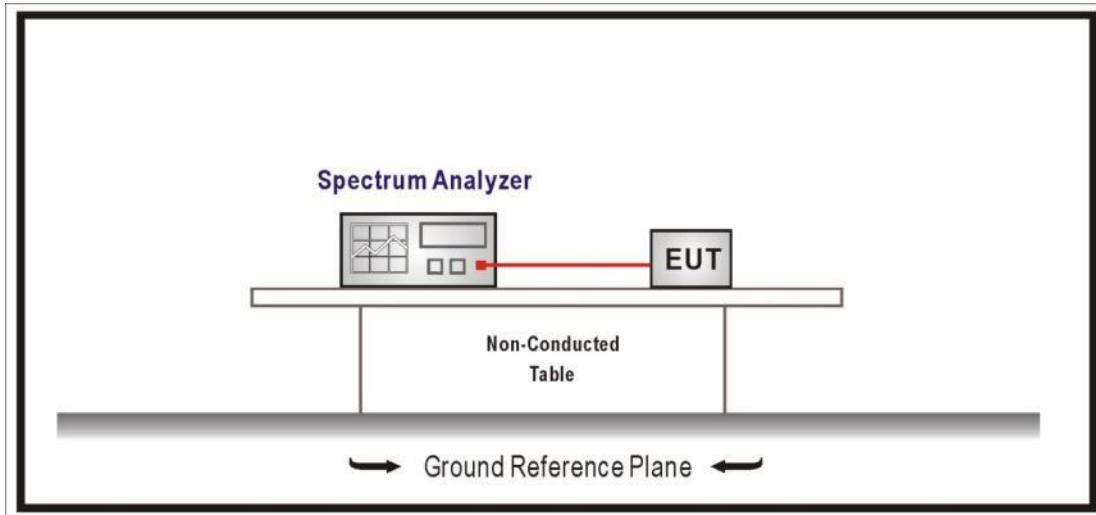

**4.4.3 Test Procedure**

References Rule	Chapter	Description
<input checked="" type="checkbox"/> ANSI C63.10	11.6	Duty cycle (D), transmission duration (T), and maximum power control level

**4.4.4 Test Data**

Test Mode	Tx On (ms)	VBW (kHz)	Tx On + Tx Off (ms)	Duty Cycle
Mode 1	N/A	0.01	N/A	100%

Note 1: T means the minimum transmission duration over which the transmitter is on and is transmitting at its maximum power control level for the tested mode of operation.

Note 2: According to KDB 558074, when test for Radiated Emission Band Edge and Radiated Emission, for average detector set:  $VBW \geq 1/T$  will be used.

Mode 1 CH39 2480MHz

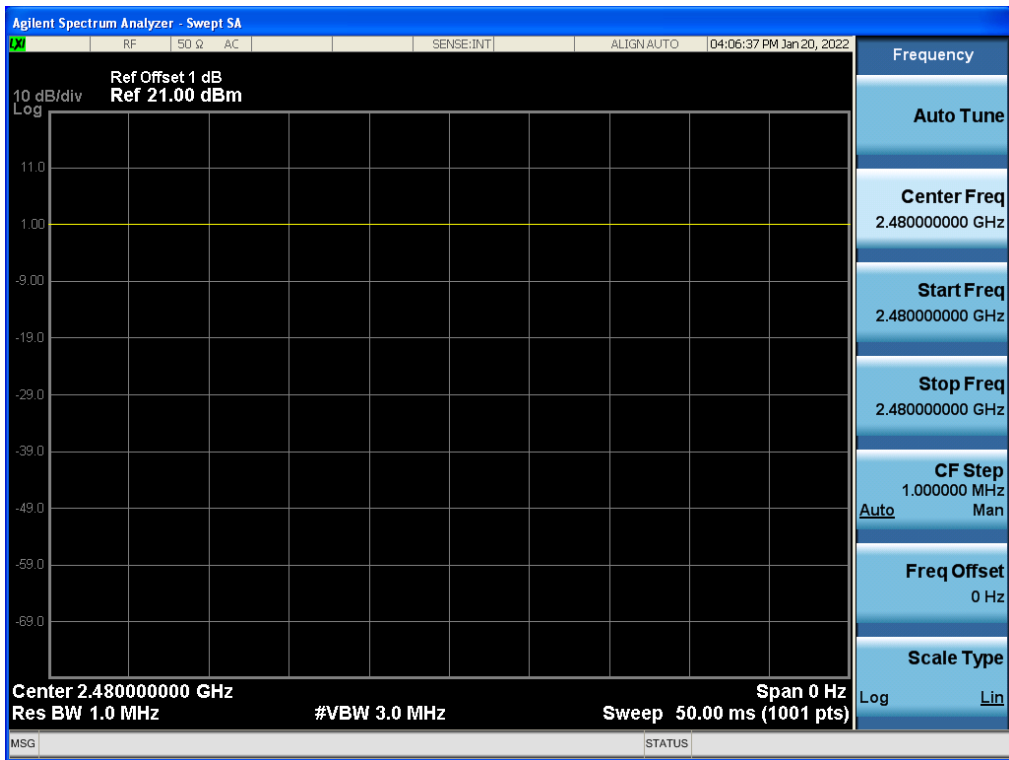

**4.5 Radiated Emission Band Edge**

**VERDICT: PASS**

**4.5.1 Limit**

<b>Standard</b>		FCC Part 15 Subpart C Paragraph 15.247(d) , 15.209		
Frequency bands (MHz)	Detector	Limit (dBµV/m)	RBW (MHz)	Distance (m)
2310-2390	PK	74	1	3
2483.5-2500	AV	54	1	3

Note: The field strength of emissions appearing within these frequency bands shall not exceed the limits.

**4.5.2 Test Setup**

Above 1GHz Test Setup:

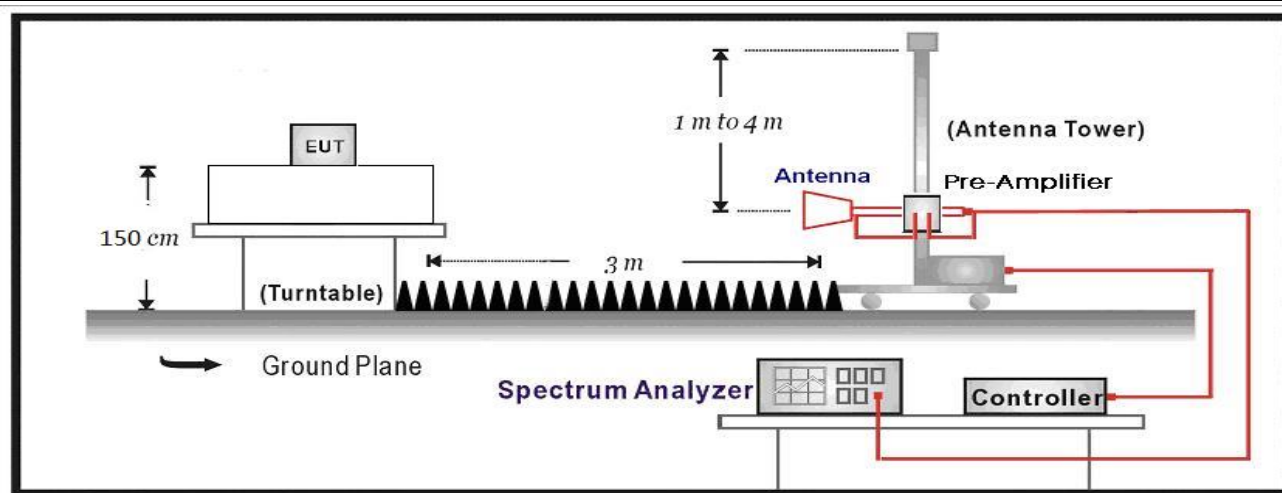

**4.5.3 Test Procedure**

	References Rule	Chapter	Description
<input checked="" type="checkbox"/>	ANSI C63.10	6.10	Band-edge testing
	<input checked="" type="checkbox"/> ANSI C63.10	6.10.5	Restricted-band band-edge measurements
	<input type="checkbox"/> ANSI C63.10	6.10.6	Marker-delta method
<input checked="" type="checkbox"/>	ANSI C63.10	11.12	Emissions in restricted frequency bands
	<input checked="" type="checkbox"/> ANSI C63.10	11.12.1	Radiated emission measurements
	<input checked="" type="checkbox"/> ANSI C63.10	11.12.2.7	Radiated spurious emission test
<input type="checkbox"/>	ANSI C63.10	6.4	Radiated emissions from unlicensed wireless devices below 30 MHz
<input type="checkbox"/>	ANSI C63.10	6.5	Radiated emissions from unlicensed wireless devices in the frequency range of 30 MHz to 1000 MHz
<input checked="" type="checkbox"/>	ANSI C63.10	6.6	Radiated emissions from unlicensed wireless devices above 1 GHz

**4.5.4 Test Data**

Profile: 2210087R	Page No.: 1
Engineer: Carlosshen	
Site: AC5	Time: 2022/01/20 - 09:33
Limit: FCC_Part15.209_RE(3m)	Margin: 0
Probe: Horn_3117_00123988_(1-18GHz)	Polarity: Horizontal
EUT: C2PL	Power: Battery
Note: Mode 1:Transmit at 2402MHz by ble	

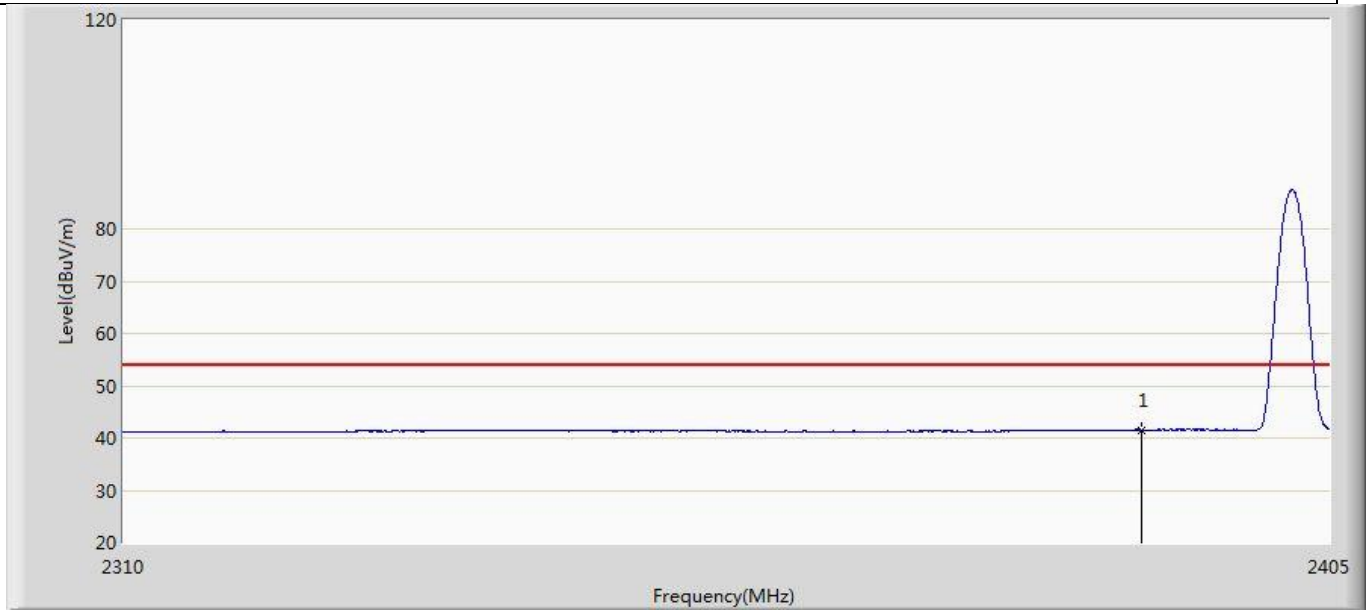

No	Mark	Frequency (MHz)	Measure Level (dBuV/m)	Reading Level (dBuV)	Over Limit (dB)	Limit (dBuV/m)	Factor (dB)	Type
1	*	2390.000	41.569	3.264	-12.431	54.000	38.305	AV

Profile: 2210087R	Page No.: 2
Engineer: Carlosshen	
Site: AC5	Time: 2022/01/20 - 09:37
Limit: FCC_Part15.209_RE(3m)	Margin: 0
Probe: Horn_3117_00123988_(1-18GHz)	Polarity: Horizontal
EUT: C2PL	Power: Battery
Note: Mode 1:Transmit at 2402MHz by ble	

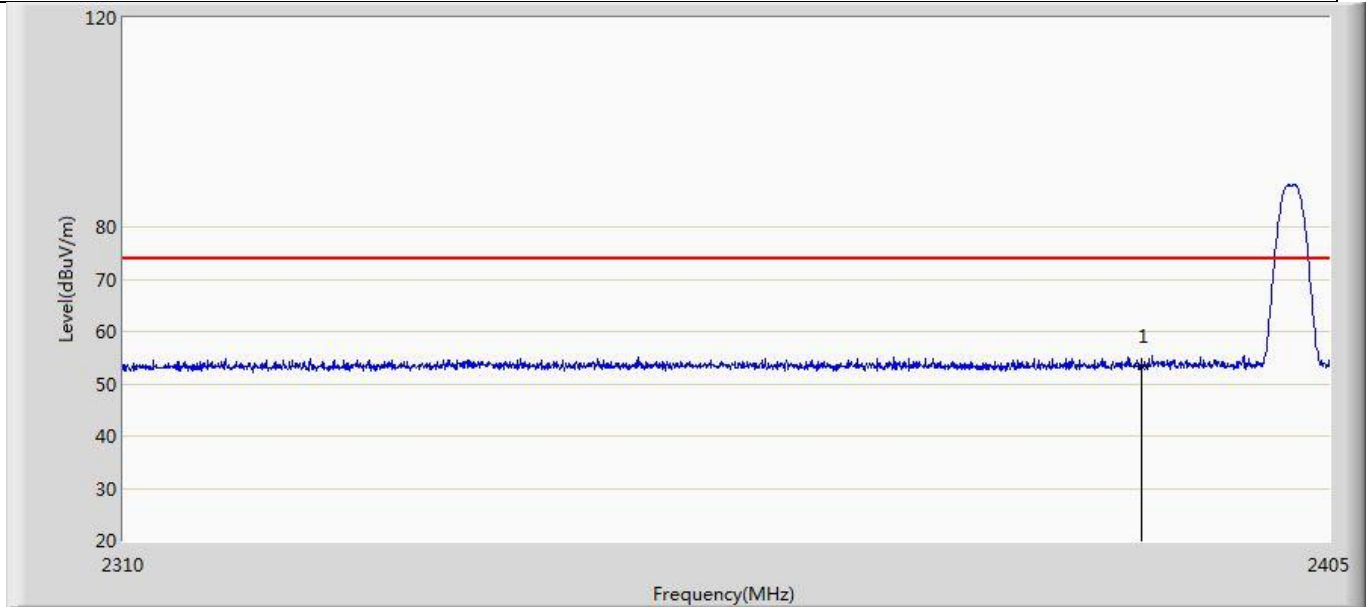

No	Mark	Frequency (MHz)	Measure Level (dBuV/m)	Reading Level (dBuV)	Over Limit (dB)	Limit (dBuV/m)	Factor (dB)	Type
1	*	2390.000	53.395	15.090	-20.605	74.000	38.305	PK

Profile: 2210087R	Page No.: 3
Engineer: Carlosshen	
Site: AC5	Time: 2022/01/20 - 09:41
Limit: FCC_Part15.209_RE(3m)	Margin: 0
Probe: Horn_3117_00123988_(1-18GHz)	Polarity: Vertical
EUT: C2PL	Power: Battery
Note: Mode 1:Transmit at 2402MHz by ble	

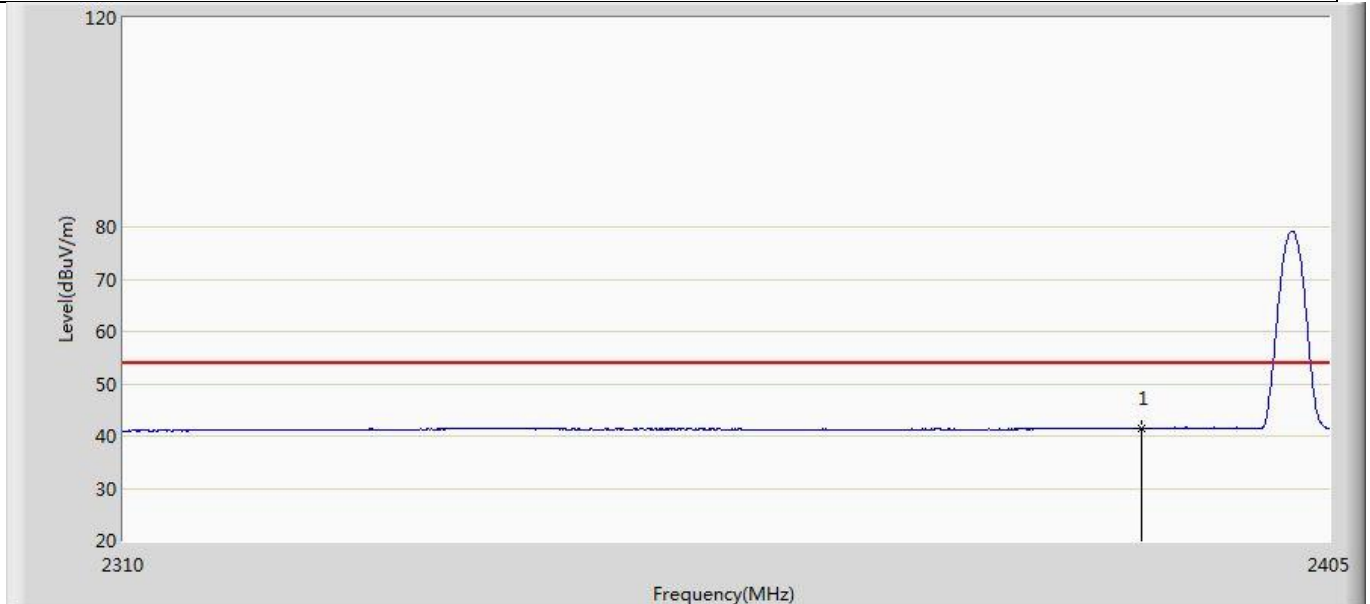

No	Mark	Frequency (MHz)	Measure Level (dBuV/m)	Reading Level (dBuV)	Over Limit (dB)	Limit (dBuV/m)	Factor (dB)	Type
1	*	2390.000	41.513	3.208	-12.487	54.000	38.305	AV

Profile: 2210087R	Page No.: 4
Engineer: Carlosshen	
Site: AC5	Time: 2022/01/20 - 09:43
Limit: FCC_Part15.209_RE(3m)	Margin: 0
Probe: Horn_3117_00123988_(1-18GHz)	Polarity: Vertical
EUT: C2PL	Power: Battery
Note: Mode 1:Transmit at 2402MHz by ble	

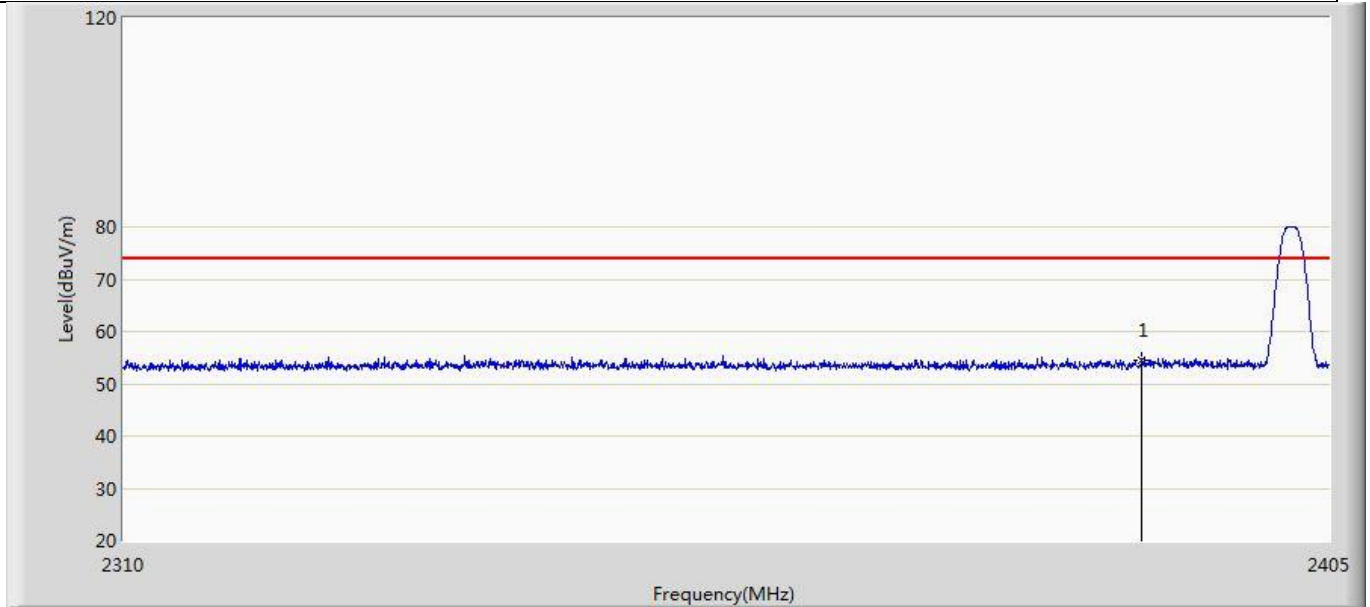

No	Mark	Frequency (MHz)	Measure Level (dBuV/m)	Reading Level (dBuV)	Over Limit (dB)	Limit (dBuV/m)	Factor (dB)	Type
1	*	2390.000	54.574	16.269	-19.426	74.000	38.305	PK



Profile: 2210087R	Page No.: 5
Engineer: Carlosshen	
Site: AC5	Time: 2022/01/20 - 09:44
Limit: FCC_Part15.209_RE(3m)	Margin: 0
Probe: Horn_3117_00123988_(1-18GHz)	Polarity: Horizontal
EUT: C2PL	Power: Battery
Note: Mode 1:Transmit at 2480MHz by ble	

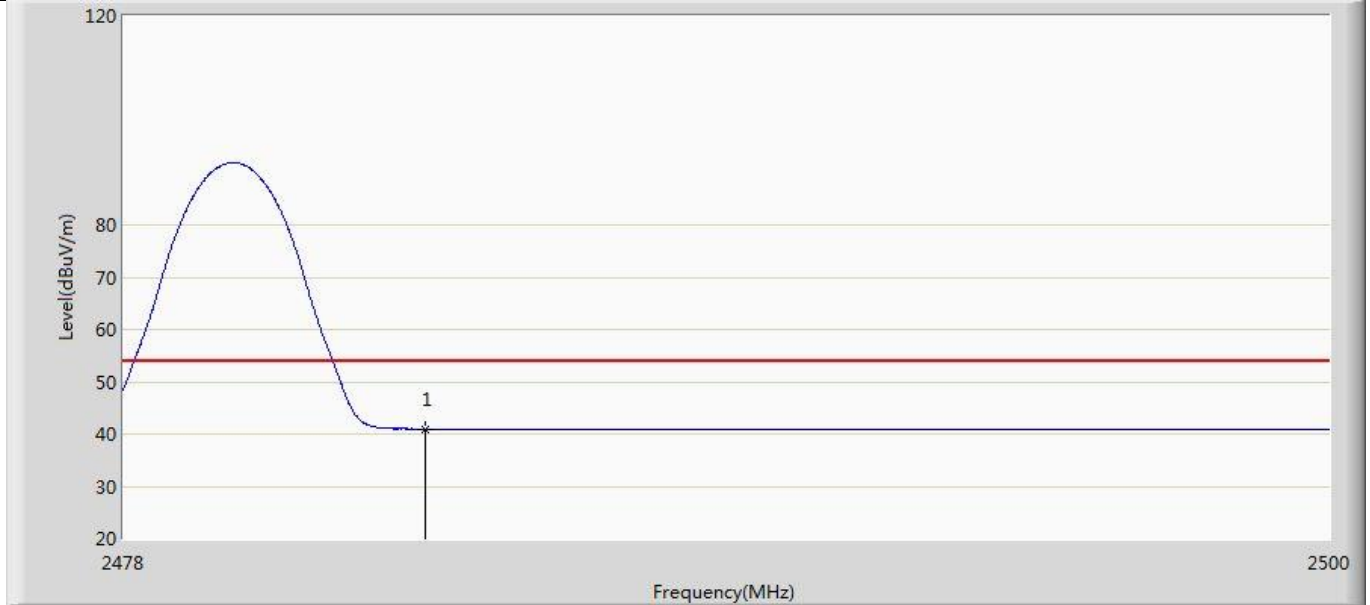

No	Mark	Frequency (MHz)	Measure Level (dBuV/m)	Reading Level (dBuV)	Over Limit (dB)	Limit (dBuV/m)	Factor (dB)	Type
1	*	2483.500	40.912	2.458	-13.088	54.000	38.453	AV

Profile: 2210087R	Page No.: 6
Engineer: Carlosshen	
Site: AC5	Time: 2022/01/20 - 09:59
Limit: FCC_Part15.209_RE(3m)	Margin: 0
Probe: Horn_3117_00123988_(1-18GHz)	Polarity: Horizontal
EUT: C2PL	Power: Battery
Note: Mode 1:Transmit at 2480MHz by ble	

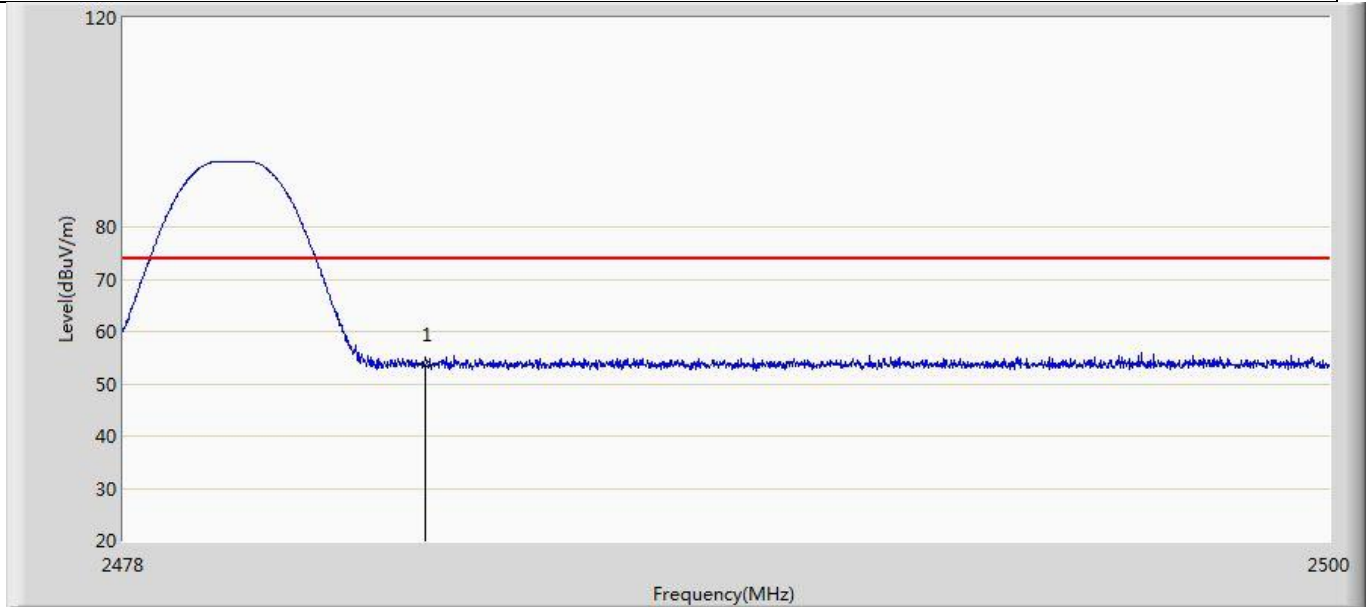

No	Mark	Frequency (MHz)	Measure Level (dBuV/m)	Reading Level (dBuV)	Over Limit (dB)	Limit (dBuV/m)	Factor (dB)	Type
1	*	2483.500	53.753	15.299	-20.247	74.000	38.453	PK

Profile: 2210087R	Page No.: 7
Engineer: Carlosshen	
Site: AC5	Time: 2022/01/20 - 10:00
Limit: FCC_Part15.209_RE(3m)	Margin: 0
Probe: Horn_3117_00123988_(1-18GHz)	Polarity: Vertical
EUT: C2PL	Power: Battery
Note: Mode 1:Transmit at 2480MHz by ble	

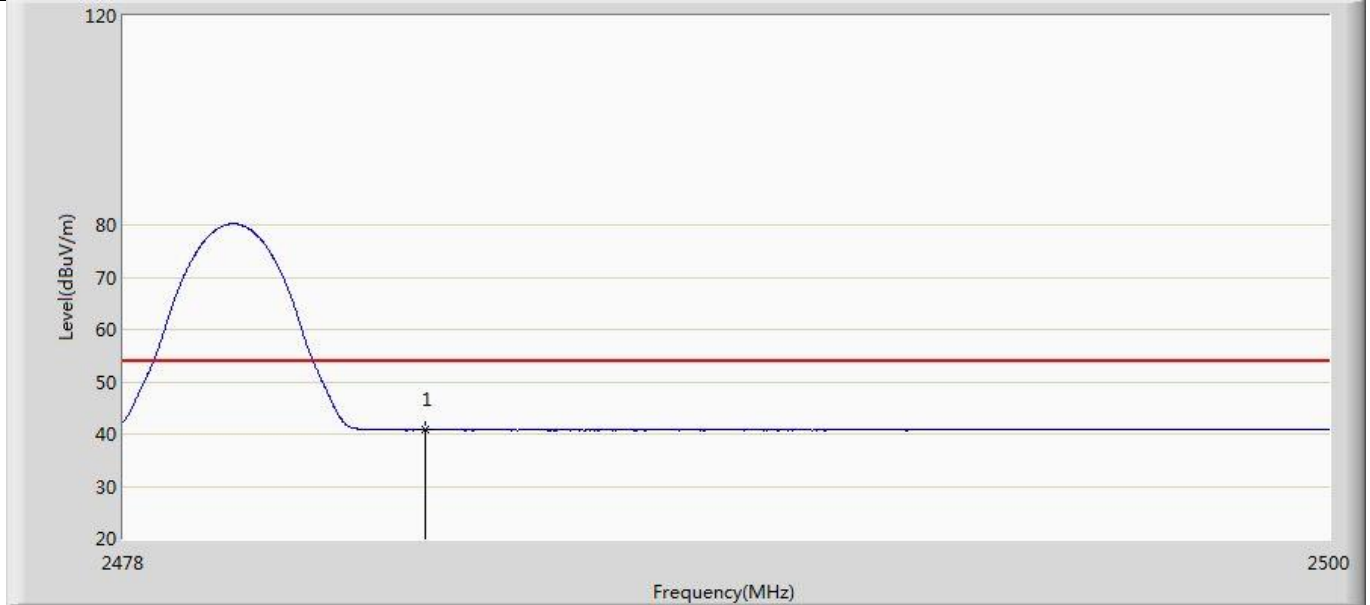

No	Mark	Frequency (MHz)	Measure Level (dBuV/m)	Reading Level (dBuV)	Over Limit (dB)	Limit (dBuV/m)	Factor (dB)	Type
1	*	2483.500	40.730	2.276	-13.270	54.000	38.453	AV

Profile: 2210087R	Page No.: 8
Engineer: Carlosshen	
Site: AC5	Time: 2022/01/20 - 10:01
Limit: FCC_Part15.209_RE(3m)	Margin: 0
Probe: Horn_3117_00123988_(1-18GHz)	Polarity: Vertical
EUT: C2PL	Power: Battery
Note: Mode 1:Transmit at 2480MHz by ble	

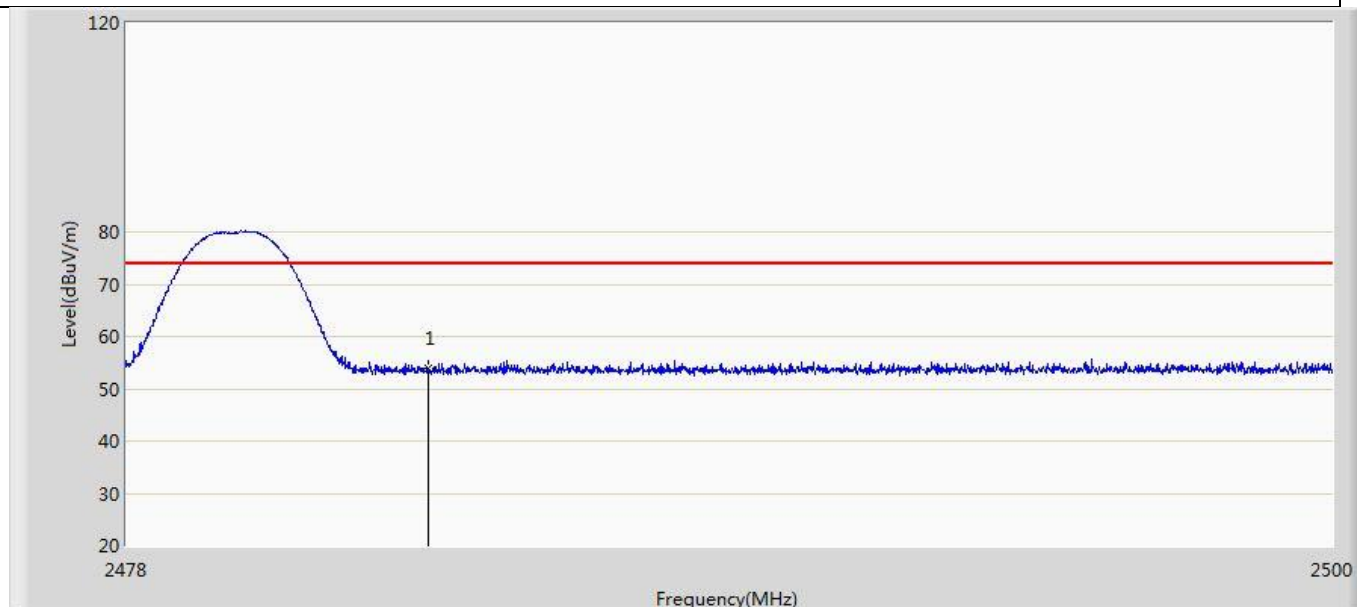

No	Mark	Frequency (MHz)	Measure Level (dBuV/m)	Reading Level (dBuV)	Over Limit (dB)	Limit (dBuV/m)	Factor (dB)	Type
1	*	2483.500	54.045	15.591	-19.955	74.000	38.453	PK

Note:

1. Measured Level = Reading Level + Factor.
2. This limit applies for using average detector, if the test result on peak is lower than average limit, then average measurement needn't be performed.
3. As the radiated emission was performed, so conducted emission was not tested.

<b>4.6 DTS Bandwidth</b>	<b>VERDICT: PASS</b>
--------------------------	----------------------

**4.6.1 Limit**

<b>Standard</b>	FCC Part 15 Subpart C Paragraph 15.247 (a)(2)
Systems using digital modulation techniques operate in the 2400-2483.5 MHz. The minimum 6 dB bandwidth shall be at least 500 kHz	

**4.6.2 Test Setup**

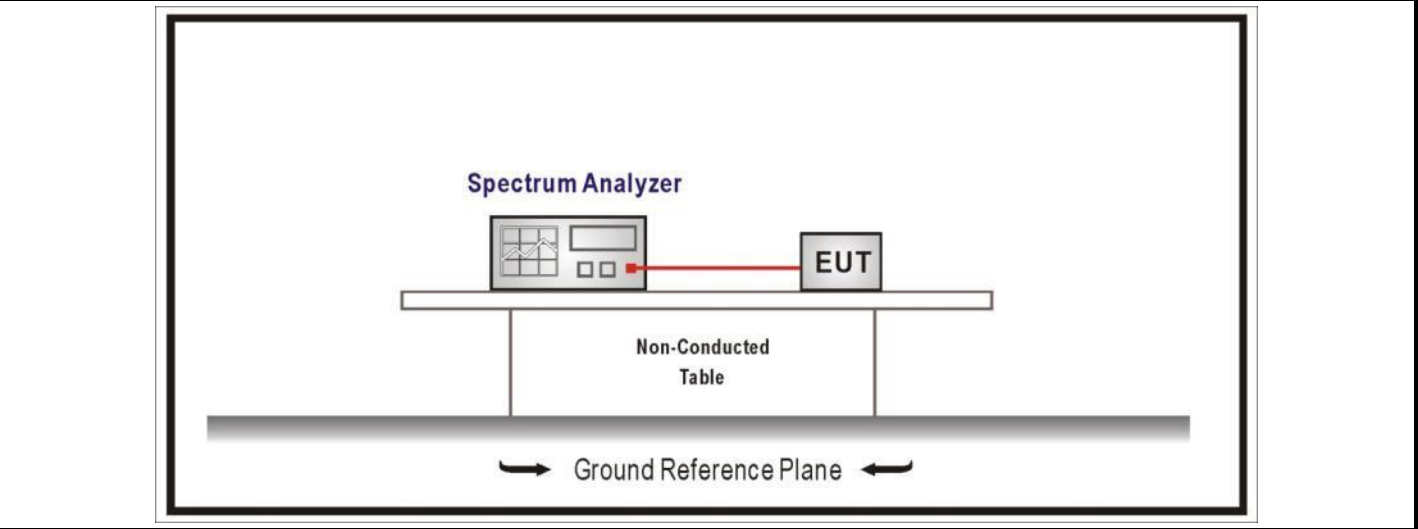

**4.6.3 Test Procedure**

	Reference Rule	Chapter	Description
<input checked="" type="checkbox"/>	ANSI C63.10	11.8	DTS bandwidth
<input type="checkbox"/>	ANSI C63.10	11.8.1	Option 1
<input checked="" type="checkbox"/>	ANSI C63.10	11.8.2	Option 2

### 4.6.4 Test Data

Mode	CH.	Test Freq. (MHz)	99% Occupied Bandwidth (kHz)	6dB Occupied Bandwidth (kHz)	Limit for 6dB Occupied Bandwidth (kHz)	Result
1	37	2402	1321.0	730.0	>500	Pass
	38	2426	1311.0	734.4	>500	Pass
	39	2480	1329.0	669.4	>500	Pass

Note : The worst case of Occupied Bandwidth as below:

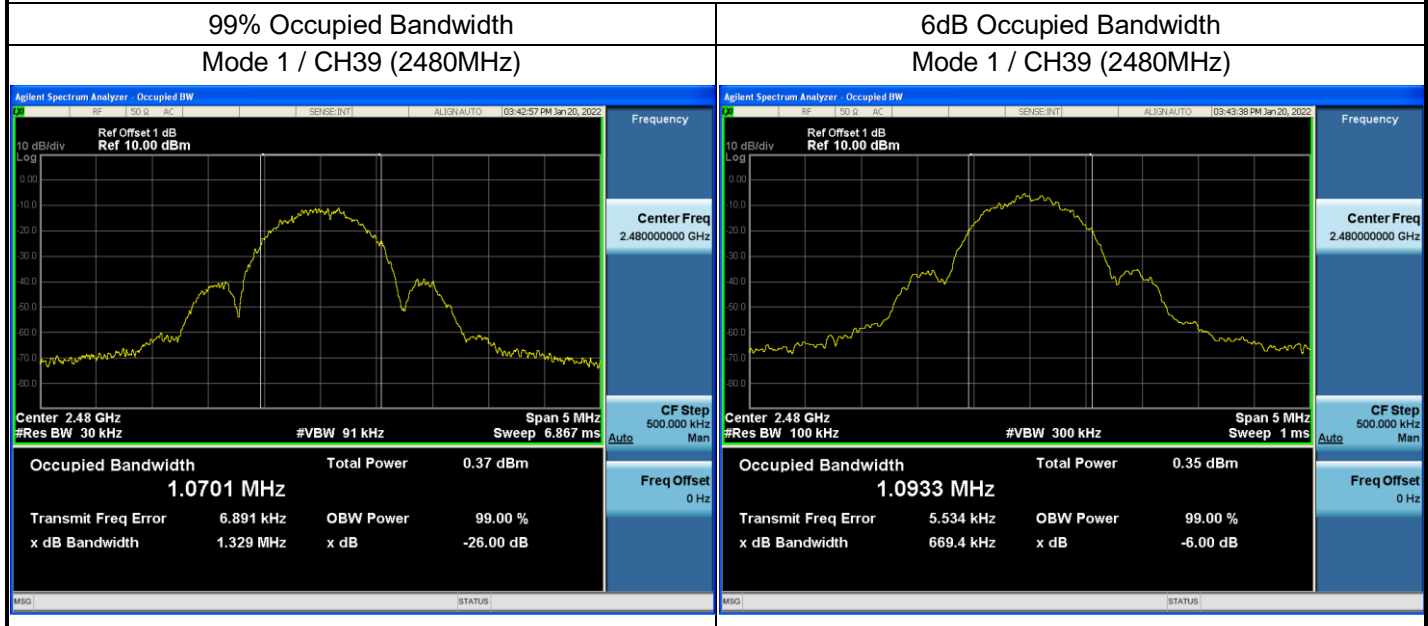

<b>4.7 Fundamental emission output power</b>	<b>VERDICT: PASS</b>
--	----------------------

**4.7.1 Limit**

Standard	FCC Part 15 Subpart C Paragraph 15.247 (b)(3)	
<input checked="" type="checkbox"/> GTX < 6dBi	Pout ≤ 30dBm	
<input type="checkbox"/> GTX > 6dBi		
<input type="checkbox"/> Non-Fix point-point	Pout ≤ 30 - (GTX - 6)	
<input type="checkbox"/> Fix point-point	Pout ≤ 30 - [(GTX - 6)]/3	
<input type="checkbox"/> Point-to-multipoint	Pout ≤ 30 - (GTX - 6)	
<input type="checkbox"/> Overlap Beams	Pout ≤ 30 - [(GTX - 6)]/3	
<input type="checkbox"/> Aggregate power transmitted simultaneously on all beams	Pout ≤ 30 - [(GTX - 6)]/3	
<input type="checkbox"/> single directional beam	Pout ≤ 30 - [(GTX - 6)]/3 + 8dB	

Note 1 : GTX directional gain of transmitting antennas.  
 Note 2 : Pout is maximum peak conducted output power .

**4.7.2 Test Setup**

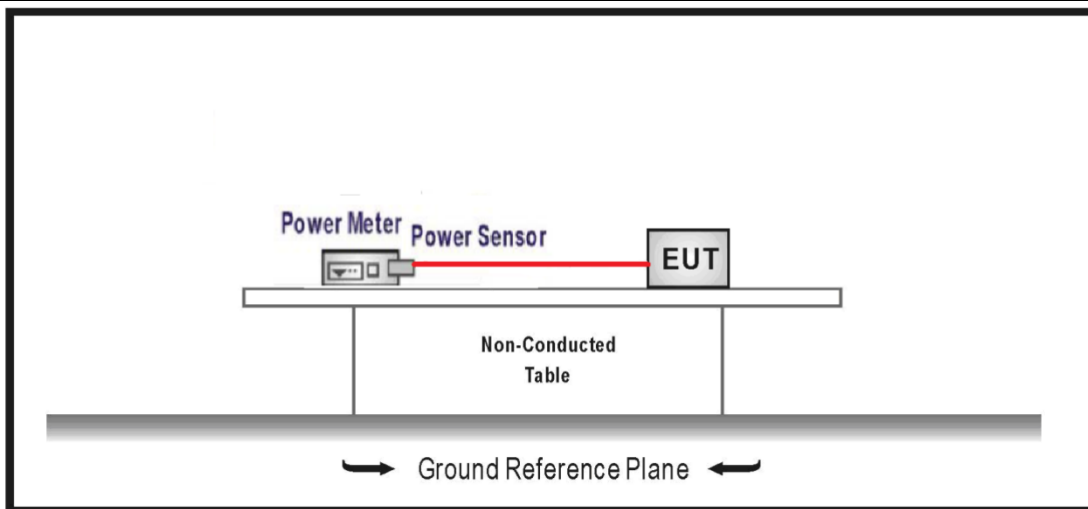

4.7.3 Test Procedure				
	References Rule		Chapter	Description
<input checked="" type="checkbox"/>	ANSI C63.10		11.9	Fundamental emission output power
	<input checked="" type="checkbox"/>	ANSI C63.10	11.9.1	Maximum peak conducted output power
	<input type="checkbox"/>	ANSI C63.10	11.9.1.1	RBW ≥ DTS bandwidth
	<input type="checkbox"/>	ANSI C63.10	11.9.1.2	Integrated band power method
	<input type="checkbox"/>	ANSI C63.10	11.9.1.3	PKPM1 Peak power meter method
	<input type="checkbox"/>	ANSI C63.10	11.9.2	Maximum conducted (average) output power
	<input type="checkbox"/>	ANSI C63.10	11.9.2.2	Measurement using a spectrum analyzer (SA)
	<input type="checkbox"/>	ANSI C63.10	11.9.2.2.2	Method AVGSA-1(Duty cycle≥98%)
	<input type="checkbox"/>	ANSI C63.10	11.9.2.2.3	Method AVGSA-1A(Duty cycle≥98%)
	<input type="checkbox"/>	ANSI C63.10	11.9.2.2.4	Method AVGSA-2(Duty cycle≤98%)
	<input type="checkbox"/>	ANSI C63.10	11.9.2.2.5	Method AVGSA-2A(Duty cycle≤98%)
	<input type="checkbox"/>	ANSI C63.10	11.9.2.2.4	Method AVGSA-3
	<input type="checkbox"/>	ANSI C63.10	11.9.2.2.5	Method AVGSA-3A
	<input checked="" type="checkbox"/>	ANSI C63.10	11.9.2.3	Measurement using a power meter (PM)
	<input checked="" type="checkbox"/>	ANSI C63.10	11.9.2.3.1	Method AVGPM
	<input type="checkbox"/>	ANSI C63.10	11.9.2.3.2	Method AVGPM-G



#### 4.7.4 Test Data

Mode	Channel	Test Frequency (MHz)	Power Output (dBm)	Limit (dBm)	Result
Mode 1	37	2402	2.75	≤30	Pass
	38	2426	1.69	≤30	Pass
	39	2480	1.02	≤30	Pass

**4.8 Power Density**

**VERDICT: PASS**

**4.8.1 Limit:**

**Standard** FCC Part 15 Subpart C Paragraph 15.247 (b)(3)

Power Spectral Density ≤ 8dBm/3kHz

**4.8.2 Test Setup**

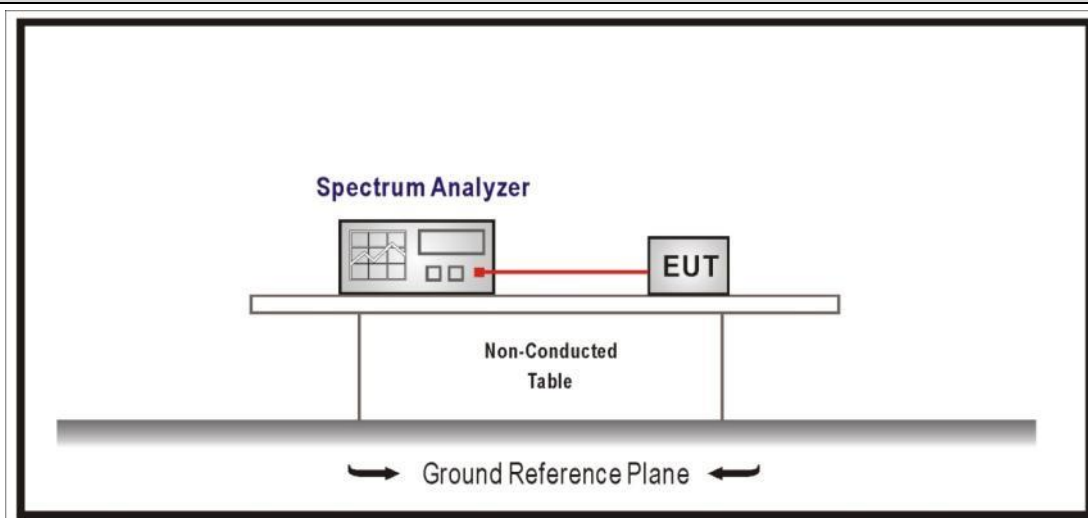

**4.8.3 Test Procedure**

	References Rule	Chapter	Description
<input checked="" type="checkbox"/>	ANSI C63.10	11.10	Maximum power spectral density level in the fundamental emission
<input checked="" type="checkbox"/>	ANSI C63.10	11.10.2	Method PKPSD (peak PSD)
<input type="checkbox"/>	ANSI C63.10	11.10.3	Method AVGPSD-1(Duty cycle ≥ 98%)
<input type="checkbox"/>	ANSI C63.10	11.10.4	Method AVGPSD-1A(Duty cycle ≥ 98%)
<input type="checkbox"/>	ANSI C63.10	11.10.5	Method AVGPSD-2(Duty cycle < 98%)
<input type="checkbox"/>	ANSI C63.10	11.10.6	Method AVGPSD-2A(Duty cycle < 98%)
<input type="checkbox"/>	ANSI C63.10	11.10.7	Method AVGPSD-3
<input type="checkbox"/>	ANSI C63.10	11.10.8	Method AVGPSD-3A

**4.8.4 Test Data**

Mode	Channel	Test Frequency (MHz)	Measurement PSD (dBm/3kHz)	Limit (dBm/3kHz)	Result
Mode 1	37	2402	-10.953	≤8	Pass
	38	2426	-11.472	≤8	Pass
	39	2480	-12.372	≤8	Pass

Note : The worst case of PSD as below:

Mode 1 / CH37(2402MHz)

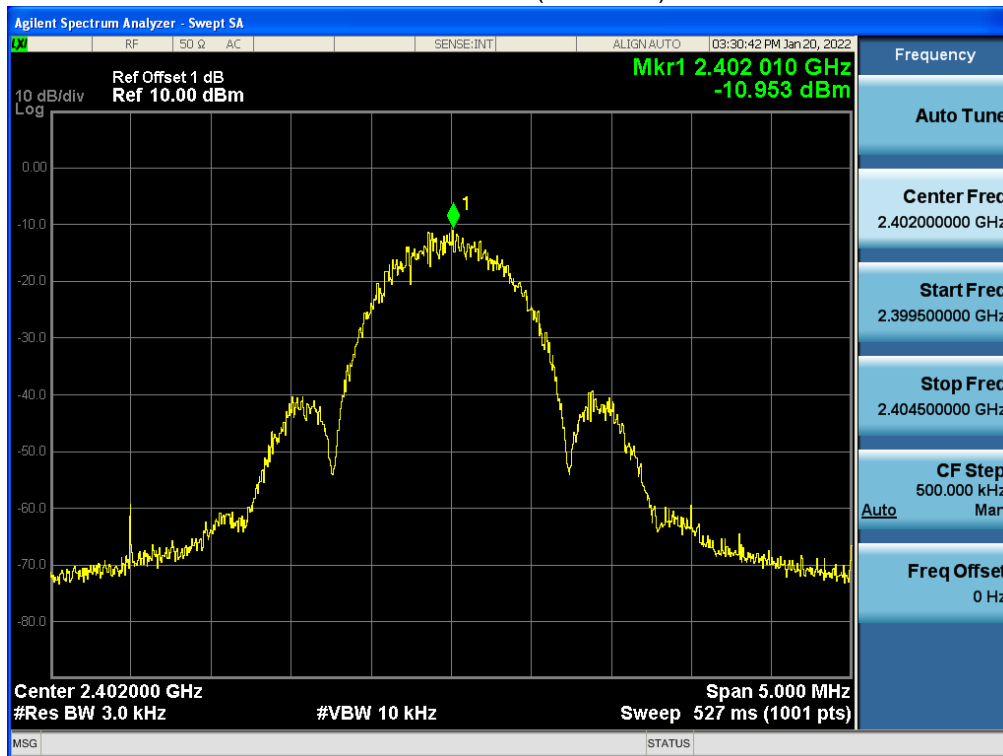

**4.9 Antenna Requirement**

**VERDICT: PASS**

**4.9.1 Limit:**

<b>Standard</b>	FCC Part 15 Subpart C Paragraph 15.203
-----------------	--

An intentional radiator shall be designed to ensure that no antenna other than that furnished by the responsible party shall be used with the device. The use of a permanently attached antenna or of an antenna that uses a unique coupling to the intentional radiator shall be considered sufficient to comply with the provisions of this section. The manufacturer may design the unit so that a broken antenna can be replaced by the user, but the use of a standard antenna jack or electrical connector is prohibited. This requirement does not apply to carrier current devices or to devices operated under the provisions of §15.211, §15.213, §15.217, §15.219, or §15.221. Further, this requirement does not apply to intentional radiators that must be professionally installed, such as perimeter protection systems and some field disturbance sensors, or to other intentional radiators which, in accordance with §15.31(d), must be measured at the installation site. However, the installer shall be responsible for ensuring that the proper antenna is employed so that the limits in this part are not exceeded.

**4.9.2 Antenna Connector Construction:**

- |                                     |  |
|-------------------------------------|--|
| <input checked="" type="checkbox"/> | The use of a permanently attached antenna                        |
| <input type="checkbox"/>            | The antenna use of a unique coupling to the intentional radiator |
| <input type="checkbox"/>            | The use of a nonstandard antenna jack or electrical connector    |

Please refer to the attached document "Internal Photograph" to show the antenna connector.

---

## 5 TEST SETUP PHOTO AND EUT PHOTO

Remark: The test setup photo and EUT Photo please see appendix.

\_\_\_\_\_ The End \_\_\_\_\_