

EMC Test Report**Application for FCC Grant of Equipment Authorization
Canada Certification****Innovation, Science and Economic Development Canada
RSS-Gen Issue 5 / RSS-247 Issue 2
FCC Part 15 Subpart C****Model: 550-135-100**

FCC ID: 2AYMA550135100

APPLICANT: Apptricity Corporation
220 E. Las Colinas Blvd, Suite 400
Irving, TX 75039TEST SITE(S): National Technical Systems
41039 Boyce Road.
Fremont, CA. 94538-2435

IC SITE REGISTRATION #: 2845B-3; 2845B-4, 2845B-5, 2845B-7

PROJECT NUMBER: PR124075

REPORT DATE: January 29, 2021

FINAL TEST DATES: October 29, 2020 and January 4 and 11, 2021

TOTAL NUMBER OF PAGES: 44



This report and the information contained herein represent the results of testing of only those articles / products identified in this document and selected by the client. The tests were performed to specifications and/or procedures selected by the client. National Technical Systems (NTS) makes no representations expressed or implied that such testing fully demonstrates efficiency, performance, reliability, or any other characteristic of the articles being tested, or similar products. This report should not be relied upon as an endorsement or certification by NTS of the equipment tested, nor does it present any statement whatsoever as to its merchantability or fitness of the test article or similar products, for a particular purpose. This report shall not be reproduced except in full without written approval from NTS.

VALIDATING SIGNATORIES

PROGRAM MGR

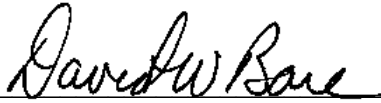

David W. Bare
Chief Engineer

TECHNICAL REVIEWER:



David W. Bare
Chief Engineer

FINAL REPORT PREPARER:



David Guidotti
Senior Technical Writer

QUALITY ASSURANCE DELEGATE



Gary Izard
Senior Technical Writer



REVISION HISTORY

Rev#	Date	Comments	Modified By
-	January 29, 2021	First release	

TABLE OF CONTENTS

COVER PAGE.....1

VALIDATING SIGNATORIES2

REVISION HISTORY3

TABLE OF CONTENTS4

SCOPE.....5

OBJECTIVE5

STATEMENT OF COMPLIANCE.....6

DEVIATIONS FROM THE STANDARDS.....6

TEST RESULTS SUMMARY7

 DIGITAL TRANSMISSION SYSTEMS (2400 – 2483.5MHZ)7

 MEASUREMENT UNCERTAINTIES.....9

EQUIPMENT UNDER TEST (EUT) DETAILS.....10

 GENERAL.....10

 OTHER EUT DETAILS.....10

 ANTENNA SYSTEM10

 ENCLOSURE.....10

 MODIFICATIONS.....10

 SUPPORT EQUIPMENT.....10

 EUT INTERFACE PORTS11

 EUT OPERATION11

TEST SITE.....12

 GENERAL INFORMATION.....12

 CONDUCTED EMISSIONS CONSIDERATIONS12

 RADIATED EMISSIONS CONSIDERATIONS12

MEASUREMENT INSTRUMENTATION13

 RECEIVER SYSTEM.....13

 INSTRUMENT CONTROL COMPUTER.....13

 LINE IMPEDANCE STABILIZATION NETWORK (LISN).....13

 FILTERS/ATTENUATORS14

 ANTENNAS.....14

 ANTENNA MAST AND EQUIPMENT TURNTABLE.....14

 INSTRUMENT CALIBRATION.....14

TEST PROCEDURES15

 EUT AND CABLE PLACEMENT15

 CONDUCTED EMISSIONS.....15

 RADIATED EMISSIONS.....15

 CONDUCTED EMISSIONS FROM ANTENNA PORT19

 BANDWIDTH MEASUREMENTS19

 SPECIFICATION LIMITS AND SAMPLE CALCULATIONS.....20

 GENERAL TRANSMITTER RADIATED EMISSIONS SPECIFICATION LIMITS20

 OUTPUT POWER LIMITS – DIGITAL TRANSMISSION SYSTEMS21

 TRANSMIT MODE SPURIOUS RADIATED EMISSIONS LIMITS – FHSS AND DTS SYSTEMS.....21

 SAMPLE CALCULATIONS - CONDUCTED EMISSIONS22

 SAMPLE CALCULATIONS - RADIATED EMISSIONS.....22

 SAMPLE CALCULATIONS - FIELD STRENGTH TO EIRP CONVERSION.....23

APPENDIX A TEST EQUIPMENT CALIBRATION DATA24

APPENDIX B TEST DATA25

END OF REPORT44

SCOPE

An electromagnetic emissions test has been performed on the Apptricity Corporation model 550-135-100, pursuant to the following rules:

RSS-GEN Issue 5 “General Requirements for Compliance of Radio Apparatus”
RSS 247 Issue 2 “Digital Transmission Systems (DTSs), Frequency Hopping Systems (FHSS) and Licence-Exempt Local Area Network (LE-LAN) Devices”
FCC Part 15 Subpart C

Conducted and radiated emissions data has been collected, reduced, and analyzed within this report in accordance with measurement guidelines set forth in the following reference standards and as outlined in National Technical Systems test procedures:

ANSI C63.10-2013
FCC DTS Measurement Guidance KDB558074

The intentional radiator above has been tested in a simulated typical installation to demonstrate compliance with the relevant Industry Canada performance and procedural standards.

Final system data was gathered in a mode that tended to maximize emissions by varying orientation of EUT, orientation of power and I/O cabling, antenna search height, and antenna polarization.

Every practical effort was made to perform an impartial test using appropriate test equipment of known calibration. All pertinent factors have been applied to reach the determination of compliance.

National Technical Systems is accredited by the A2LA, certificate number 0214.26, to perform the test(s) listed in this report, except where noted otherwise.

OBJECTIVE

The primary objective of the manufacturer is compliance with the regulations outlined in the previous section.

Prior to marketing in the USA, all unlicensed transmitters and transceivers require certification. Receive-only devices operating between 30 MHz and 960 MHz are subject to either certification or a manufacturer’s declaration of conformity, with all other receive-only devices exempt from the technical requirements.

Prior to marketing in Canada, Class I transmitters, receivers and transceivers require certification. Class II devices are required to meet the appropriate technical requirements but are exempt from certification requirements.

Certification is a procedure where the manufacturer submits test data and technical information to a certification body and receives a certificate or grant of equipment authorization upon successful completion of the certification body's review of the submitted documents. Once the equipment authorization has been obtained, the label indicating compliance must be attached to all identical units, which are subsequently manufactured.

Maintenance of compliance is the responsibility of the manufacturer. Any modification of the product which may result in increased emissions should be checked to ensure compliance has been maintained (i.e., printed circuit board layout changes, different line filter, different power supply, harnessing or I/O cable changes, etc.).

STATEMENT OF COMPLIANCE

The tested sample of Apptricity Corporation model 550-135-100 complied with the requirements of the following regulations:

RSS-GEN Issue 5 “General Requirements for Compliance of Radio Apparatus”
RSS 247 Issue 2 “Digital Transmission Systems (DTSS), Frequency Hopping Systems (FHSS) and Licence-Exempt Local Area Network (LE-LAN) Devices”
FCC Part 15 Subpart C

Maintenance of compliance is the responsibility of the manufacturer. Any modifications to the product should be assessed to determine their potential impact on the compliance status of the device with respect to the standards detailed in this test report.

The test results recorded herein are based on a single type test of Apptricity Corporation model 550-135-100 and therefore apply only to the tested sample. The sample was selected and prepared by Marci Haslam of Apptricity Corporation.

DEVIATIONS FROM THE STANDARDS

No deviations were made from the published requirements listed in the scope of this report.

TEST RESULTS SUMMARY

DIGITAL TRANSMISSION SYSTEMS (2400 – 2483.5MHz)

FCC Rule Part	RSS Rule Part	Description	Measured Value / Comments	Limit / Requirement	Result
15.247(a)	RSS 247 5.2	Digital Modulation	Systems uses GFSK modulation	System must utilize a digital transmission technology	Complies
15.247 (a) (2)	RSS 247 5.2 (1)	6dB Bandwidth	0.61 MHz	>500kHz	Complies
15.247 (b) (3)	RSS 247 5.4 (4)	Output Power (multipoint systems)	21.4 dBm (0.138 Watts) EIRP = 0.275 W <small>Note 1</small>	1Watt, EIRP limited to 4 Watts.	Complies
15.247(e)	RSS 247 5.2 (2)	Power Spectral Density	5.0 dBm/3kHz	8dBm/3kHz	Complies
15.247(d)	RSS 247 5.5	Antenna Port Spurious Emissions 30MHz – 25 GHz	> -20dBc	< -20dBc	Complies
15.247(d) / 15.209	RSS 247 5.5	Radiated Spurious Emissions 30MHz – 25 GHz	46.2 dBμV/m @ 3819.6 MHz (-7.8 dB)	Refer to the limits section (p20) for restricted bands, all others < -20dBc	Complies

Note 1: EIRP calculated using antenna gains of 3 dBi for the highest EIRP system.

GENERAL REQUIREMENTS APPLICABLE TO ALL BANDS

FCC Rule Part	RSS Rule part	Description	Measured Value / Comments	Limit / Requirement	Result (margin)
15.203	-	RF Connector		Unique or integral antenna required	Complies
15.407 (b) (6)	RSS-Gen Table 4	AC Conducted Emissions	Testing was not performed as the EUT is powered from internal batteries		
15.247 (i) 15.407 (f)	RSS 102	RF Exposure Requirements	Refer to MPE calculations in separate exhibit, RSS 102 declaration and User Manual statements.	Refer to OET 65, FCC Part 1 and RSS 102	Complies
-	RSS-Gen 6.8	User Manual		Statement for products with detachable antenna	Complies
-	RSS-Gen 8.4	User Manual		Statement for all products	Complies
-	RSP-100 RSS-Gen 6.7	Occupied Bandwidth	1.09 MHz	Information only	N/A

MEASUREMENT UNCERTAINTIES

ISO/IEC 17025 requires that an estimate of the measurement uncertainties associated with the emissions test results be included in the report. The measurement uncertainties given below are based on a 95% confidence level and were calculated in accordance with UKAS document LAB 34.

Measurement Type	Measurement Unit	Frequency Range	Expanded Uncertainty
RF power, conducted (power meter)	dBm	25 to 7000 MHz	± 0.52 dB
RF power, conducted (Spectrum analyzer)	dBm	25 to 7000 MHz	± 0.7 dB
Conducted emission of transmitter	dBm	25 to 26500 MHz	± 0.7 dB
Conducted emission of receiver	dBm	25 to 26500 MHz	± 0.7 dB
Radiated emission (substitution method)	dBm	25 to 26500 MHz	± 2.5 dB
Radiated emission (field strength)	dBμV/m	25 to 1000 MHz	± 3.6 dB
		1000 to 40000 MHz	± 6.0 dB
Conducted Emissions (AC Power)	dBμV	0.15 to 30 MHz	± 2.4 dB

EQUIPMENT UNDER TEST (EUT) DETAILS

GENERAL

The Apptricity Corporation model 550-135-100 is a BlueTooth Tag. Since the EUT could be placed in any position during operation, the EUT was treated as tabletop equipment during testing to simulate the end-user environment. The electrical rating of the EUT is 3.2 Volts supplied from internal batteries.

The samples were received on October 23, and December 4, 2020 and tested on October 29, 2020 and January 4 and 11, 2021. The following samples were used for testing:

Company	Model	Description	Serial Number	FCC ID
Apptricity Corp	550-135-100	BT Tag	DDD8FA45BE95	2AYMA550135100
Apptricity Corp	550-135-100	BT Tag	D799F36E212C	2AYMA550135100
Apptricity Corp	550-135-100	BT Tag	None	2AYMA550135100

OTHER EUT DETAILS

The following EUT details should be noted: Samples always transmit on three channels (Low, Mid and High).

ANTENNA SYSTEM

The antenna system consists of integral PCB mounted 3dBi antenna.

ENCLOSURE

The EUT enclosure is primarily constructed of plastic. It measures approximately 7 cm wide by 4.4 cm deep by 2.2 cm high.

MODIFICATIONS

The EUT required the following modifications in order to comply with the emission specifications.

Mod. #	Test	Date	Modification
1	Radiated Emissions	11/5/2020	R4 was changed from 0 ohms to 5.8 ohms and R6 and R7 were populated with 870 ohm resistors
2	Radiated Emissions	12/22/2020	R4 changed back to 0 ohms, R6 and R7 not populated. A tuned filter was added to the RF output.

SUPPORT EQUIPMENT

No support equipment was used during testing.

EUT INTERFACE PORTS

The I/O cabling configuration during testing was as follows:

Port		Cable(s)		
From	To	Description	Shielded/Unshielded	Length(m)
None	-	-	-	-

EUT OPERATION

During emissions testing the EUT was transmitting at an accelerated rate on three channels at maximum power.

TEST SITE

GENERAL INFORMATION

Final test measurements were taken at the test sites listed below. Pursuant to section 2.948 of the FCC’s Rules and section 6.2 of RSS-GEN, NTS has been recognized as an accredited test laboratory by the Commission and Innovation, Science and Economic Development Canada. A description of the facilities employed for testing is maintained by NTS.

Site	Company / Registration Numbers		Location
	FCC	Canada	
Chamber 4 & 7	US1031	2845B (Wireless Test Lab #US0027)	41039 Boyce Road Fremont, CA 94538-2435

ANSI C63.4 recommends that ambient noise at the test site be at least 6 dB below the allowable limits. Ambient levels are below this requirement. The test site(s) contain separate areas for radiated and conducted emissions testing. Results from testing performed in this chamber have been correlated with results from an open area test site. Considerable engineering effort has been expended to ensure that the facilities conform to all pertinent requirements of ANSI C63.4.

CONDUCTED EMISSIONS CONSIDERATIONS

Conducted emissions testing is performed in conformance with ANSI C63.10. Measurements are made with the EUT connected to the public power network through a nominal, standardized RF impedance, which is provided by a line impedance stabilization network, known as a LISN. A LISN is inserted in series with each current-carrying conductor in the EUT power cord.

RADIATED EMISSIONS CONSIDERATIONS

The FCC has determined that radiation measurements made in a shielded enclosure are not suitable for determining levels of radiated emissions. Radiated measurements are performed in an open field environment or in a semi-anechoic chamber. The test sites are maintained free of conductive objects within the CISPR defined elliptical area incorporated in ANSI C63.4 guidelines and meet the Normalized Site Attenuation (NSA) requirements of ANSI C63.4.

MEASUREMENT INSTRUMENTATION

RECEIVER SYSTEM

An EMI receiver as specified in CISPR 16-1-1 is used for emissions measurements. The receivers used can measure over the frequency range of 9 kHz up to 2000 MHz. These receivers allow both ease of measurement and high accuracy to be achieved. The receivers have Peak, Average, and CISPR (Quasi-peak) detectors built into their design so no external adapters are necessary. The receiver automatically sets the required bandwidth for the CISPR detector used during measurements. If the repetition frequency of the signal being measured is below 20Hz, peak measurements are made in lieu of Quasi-Peak measurements.

For measurements above the frequency range of the receivers, a spectrum analyzer is utilized because it provides visibility of the entire spectrum along with the precision and versatility required to support engineering analysis. Average measurements above 1000MHz are performed on the spectrum analyzer using the linear-average method with a resolution bandwidth of 1 MHz and a video bandwidth of 10 Hz, unless the signal is pulsed in which case the average (or video) bandwidth of the measuring instrument is reduced to onset of pulse desensitization and then increased.

INSTRUMENT CONTROL COMPUTER

Software is used to view and convert receiver measurements to the field strength at an antenna or voltage developed at the LISN measurement port, which is then compared directly with the appropriate specification limit. This provides faster, more accurate readings by performing the conversions described under Sample Calculations within the Test Procedures section of this report. Results are printed in a graphic and/or tabular format, as appropriate. A personal computer is used to record all measurements made with the receivers. The software used for radiated and conducted emissions measurements is NTS EMI Test Software (rev 2.10)

LINE IMPEDANCE STABILIZATION NETWORK (LISN)

Line conducted measurements utilize a fifty microhenry Line Impedance Stabilization Network as the monitoring point. The LISN used also contains a 250 uH CISPR adapter. This network provides for calibrated radio frequency noise measurements by the design of the internal low pass and high pass filters on the EUT and measurement ports, respectively.

FILTERS/ATTENUATORS

External filters and precision attenuators are often connected between the receiving antenna or LISN and the receiver. This eliminates saturation effects and non-linear operation due to high amplitude transient events.

ANTENNAS

A loop antenna is used below 30 MHz. For the measurement range 30 MHz to 1000 MHz either a combination of a biconical antenna and a log periodic or a bi-log antenna is used. Above 1000 MHz, horn antennas are used. The antenna calibration factors to convert the received voltage to an electric field strength are included with appropriate cable loss and amplifier gain factors to determine an overall site factor, which is then programmed into the test receivers or incorporated into the test software.

ANTENNA MAST AND EQUIPMENT TURNTABLE

The antennas used to measure the radiated electric field strength are mounted on a non-conductive antenna mast equipped with a motor-drive to vary the antenna height. Measurements below 30 MHz are made with the loop antenna at a fixed height of 1m above the ground plane.

ANSI C63.10 specifies that the test height above ground for table mounted devices shall be 80 centimeters for testing below 1 GHz and 1.5m for testing above 1 GHz. Floor mounted equipment shall be placed on the ground plane if the device is normally used on a conductive floor or separated from the ground plane by insulating material from 3 to 12 mm if the device is normally used on a non-conductive floor as specified in ANSI C63.4. During radiated measurements, the EUT is positioned on a motorized turntable in conformance with this requirement.

INSTRUMENT CALIBRATION

All test equipment is regularly checked to ensure that performance is maintained in accordance with the manufacturer's specifications. All antennas are calibrated at regular intervals with respect to tuned half-wave dipoles. An exhibit of this report contains the list of test equipment used and calibration information.

TEST PROCEDURES

EUT AND CABLE PLACEMENT

The regulations require that interconnecting cables be connected to the available ports of the unit and that the placement of the unit and the attached cables simulate the worst case orientation that can be expected from a typical installation, so far as practicable. To this end, the position of the unit and associated cabling is varied within the guidelines of ANSI C63.10, and the worst-case orientation is used for final measurements.

CONDUCTED EMISSIONS

Conducted emissions are measured at the plug end of the power cord supplied with the EUT. Excess power cord length is wrapped in a bundle between 30 and 40 centimeters in length near the center of the cord. Preliminary measurements are made to determine the highest amplitude emission relative to the specification limit for all the modes of operation. Placement of system components and varying of cable positions are performed in each mode. A final peak mode scan is then performed in the position and mode for which the highest emission was noted on all current carrying conductors of the power cord.

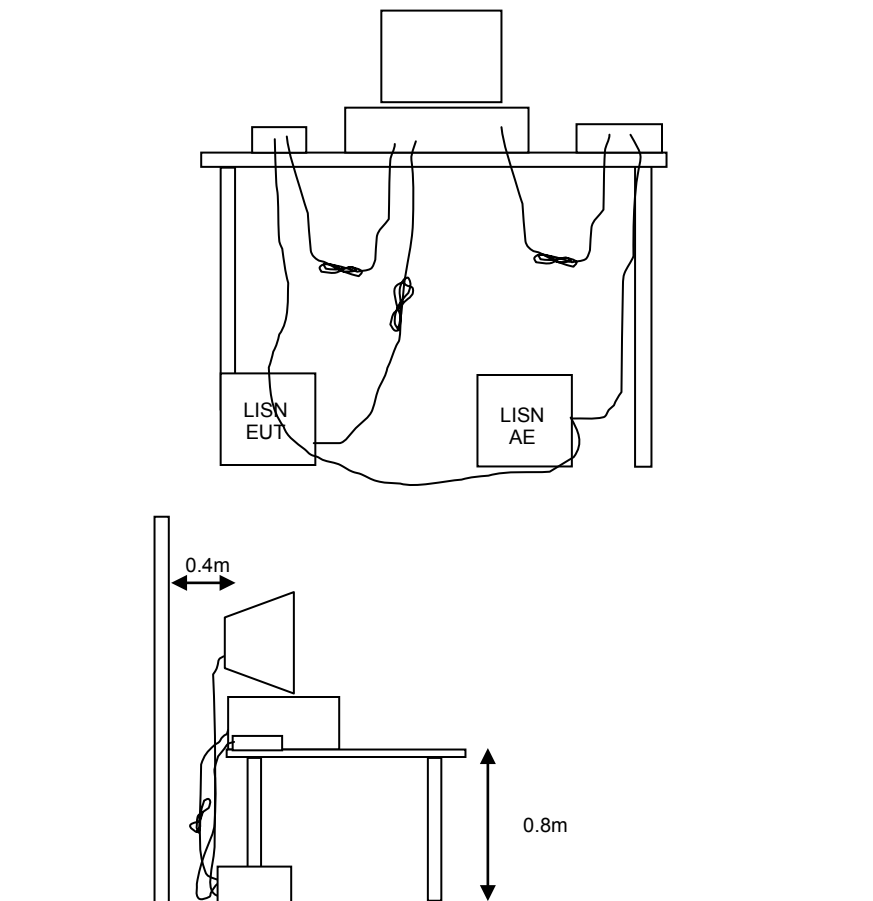

Figure 1 Typical Conducted Emissions Test Configuration

RADIATED EMISSIONS

A preliminary scan of the radiated emissions is performed in which all significant EUT frequencies are identified with the system in a nominal configuration. At least two scans are performed, one scan for each antenna polarization (horizontal and vertical; loop parallel and perpendicular to the EUT). During the preliminary scans, the EUT is rotated through 360°, the antenna height is varied (for measurements above 30 MHz) and cable positions are varied to determine the highest emission relative to the limit. Preliminary scans may be performed in a fully anechoic chamber for the purposes of identifying the frequencies of the highest emissions from the EUT.

A speaker is provided in the receiver to aid in discriminating between EUT and ambient emissions. Other methods used during the preliminary scan for EUT emissions involve scanning with near field magnetic loops, monitoring I/O cables with RF current clamps, and cycling power to the EUT.

Final maximization is a phase in which the highest amplitude emissions identified in the spectral search are viewed while the EUT azimuth angle is varied from 0 to 360 degrees relative to the receiving antenna. The azimuth, which results in the highest emission is then maintained while varying the antenna height from one to four meters (for measurements above 30 MHz, measurements below 30 MHz are made with the loop antenna at a fixed height of 1m). The result is the identification of the highest amplitude for each of the highest peaks. Each recorded level is corrected in the receiver using appropriate factors for cables, connectors, antennas, and preamplifier gain.

When testing above 18 GHz, the receive antenna is located at 1 meter from the EUT and the antenna height is restricted to a maximum of 2.5 meters.

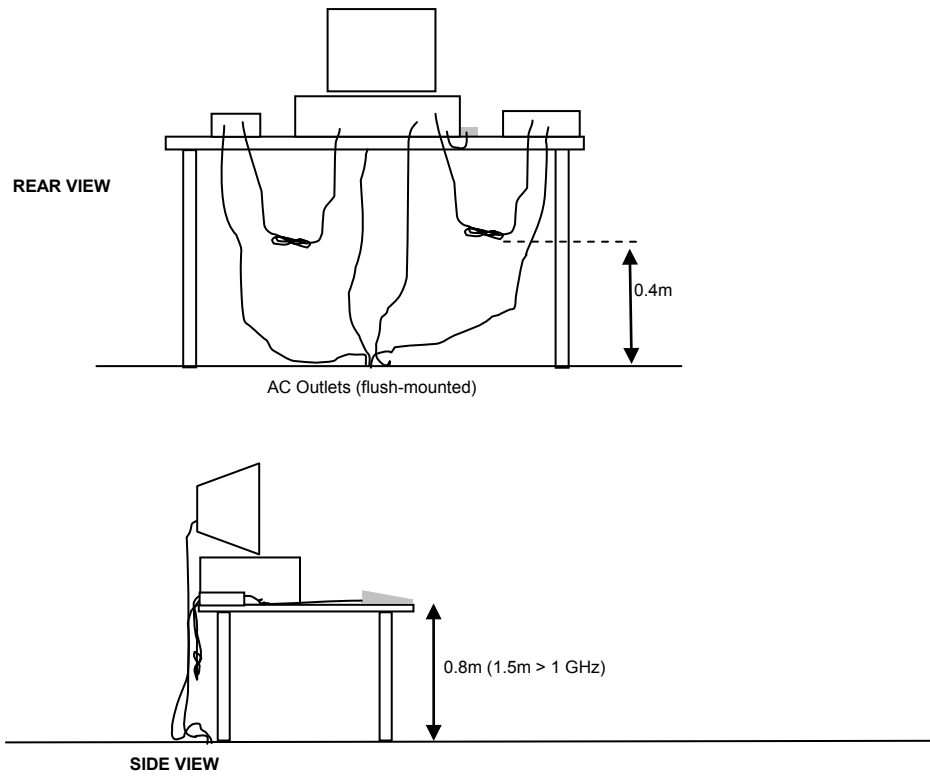

Typical Test Configuration for Radiated Field Strength Measurements

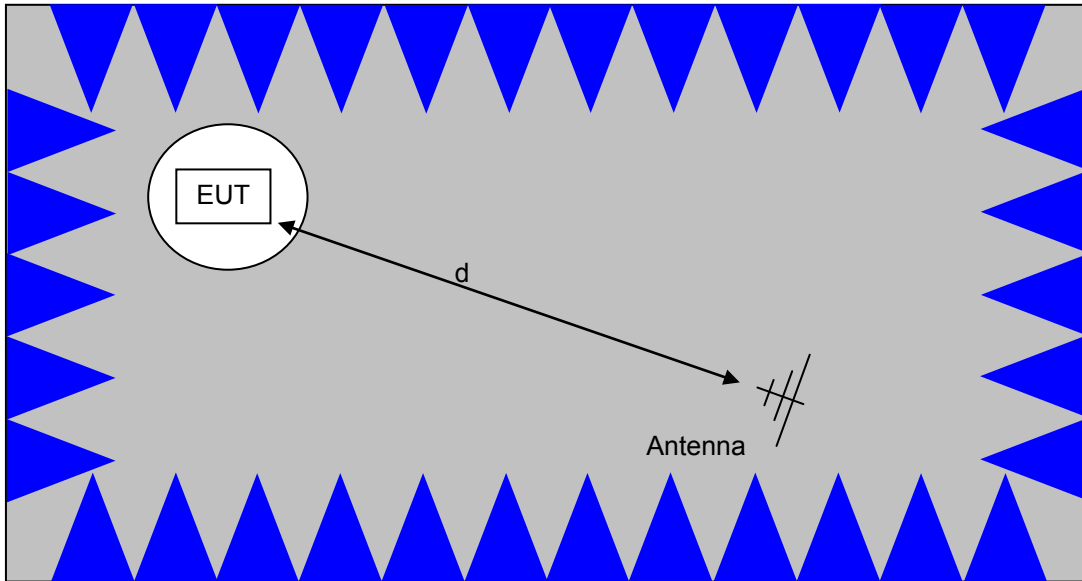

The anechoic materials on the walls and ceiling ensure compliance with the normalized site attenuation requirements of CISPR 16 / CISPR 22 / ANSI C63.4 for an alternate test site at the measurement distances used.

Floor-standing equipment is placed on the floor with insulating supports between the unit and the ground plane.

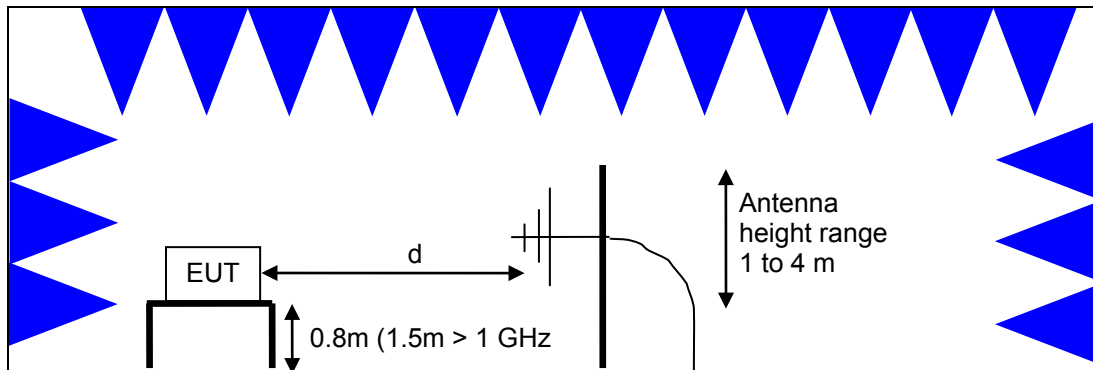

Test Configuration for Radiated Field Strength Measurements
Semi-Anechoic Chamber, Plan and Side Views

CONDUCTED EMISSIONS FROM ANTENNA PORT

Direct measurements of power, bandwidth and power spectral density are performed, where possible, with the antenna port of the EUT connected to either the power meter or spectrum analyzer via a suitable attenuator and/or filter. These are used to ensure that the front end of the measurement instrument is not overloaded by the fundamental transmission.

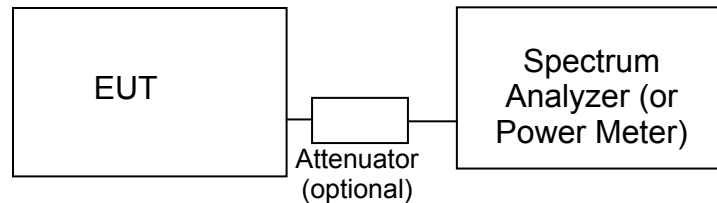

Test Configuration for Antenna Port Measurements

Measurement bandwidths (video and resolution) are set in accordance with the relevant standards and NTS Silicon Valley's test procedures for the type of radio being tested. When power measurements are made using a resolution bandwidth less than the signal bandwidth the power is calculated by summing the power across the signal bandwidth using either the analyzer channel power function or by capturing the trace data and calculating the power using software. In both cases the summed power is corrected to account for the equivalent noise bandwidth (ENBW) of the resolution bandwidth used.

If power averaging is used (typically for certain digital modulation techniques), the EUT is configured to transmit continuously. Power averaging is performed using either the built-in function of the analyzer or, if the analyzer does not feature power averaging, using external software. In both cases the average power is calculated over a number of sweeps (typically 100). When the EUT cannot be configured to continuously transmit then either the analyzer is configured to perform a gated sweep to ensure that the power is averaged over periods that the device is transmitting or power averaging is disabled and a max-hold feature is used.

If a power meter is used to make output power measurements the sensor head type (peak or average) is stated in the test data table.

BANDWIDTH MEASUREMENTS

The 6dB, 20dB, 26dB and/or 99% signal bandwidth are measured using the bandwidths recommended by ANSI C63.10 and RSS GEN.

SPECIFICATION LIMITS AND SAMPLE CALCULATIONS

The limits for conducted emissions are given in units of microvolts, and the limits for radiated emissions are given in units of microvolts per meter at a specified test distance. Data is measured in the logarithmic form of decibels relative to one microvolt, or dB microvolts (dBuV). For radiated emissions, the measured data is converted to the field strength at the antenna in dB microvolts per meter (dBuV/m). The results are then converted to the linear forms of uV and uV/m for comparison to published specifications.

For reference, converting the specification limits from linear to decibel form is accomplished by taking the base ten logarithm, then multiplying by 20. These limits in both linear and logarithmic form are as follows:

GENERAL TRANSMITTER RADIATED EMISSIONS SPECIFICATION LIMITS

The table below shows the limits for the spurious emissions from transmitters that fall in restricted bands¹.

Frequency Range (MHz)	Limit (uV/m)	Limit (dBuV/m @ 3m)
0.009-0.490	2400/F _{KHz} @ 300m	67.6-20*log ₁₀ (F _{KHz}) @ 300m
0.490-1.705	24000/F _{KHz} @ 30m	87.6-20*log ₁₀ (F _{KHz}) @ 30m
1.705 to 30	30 @ 30m	29.5 @ 30m
30 to 88	100 @ 3m	40 @ 3m
88 to 216	150 @ 3m	43.5 @ 3m
216 to 960	200 @ 3m	46.0 @ 3m
Above 960	500 @ 3m	54.0 @ 3m

¹ The restricted bands are detailed in FCC 15.205 and RSS-Gen Table 7

OUTPUT POWER LIMITS – DIGITAL TRANSMISSION SYSTEMS

The table below shows the limits for output power and output power density. Where the signal bandwidth is less than 20 MHz the maximum output power is reduced to the power spectral density limit plus 10 times the log of the bandwidth (in MHz).

Operating Frequency (MHz)	Output Power	Power Spectral Density
902 – 928	1 Watt (30 dBm)	8 dBm/3kHz
2400 – 2483.5	1 Watt (30 dBm)	8 dBm/3kHz
5725 – 5850	1 Watt (30 dBm)	8 dBm/3kHz

The maximum permitted output power is reduced by 1dB for every dB the antenna gain exceeds 6dBi. For FCC, fixed point to point applications using the 2400-2483.5 MHz band may use antennas with more than 6 dBi gain but output power is reduced by 1 dB for every 3dB that the antenna gain exceeds 6 dBi. For Canada, fixed point-to-point applications using the 2400-2483.5 MHz band are not subject to this restriction. Fixed point-to-point applications using the 5725 – 5850 MHz band are also not subject to this restriction. Certification of DTS systems operating in the 5725-5850 MHz band is no longer allowed under FCC Rules per §15.37(h).

TRANSMIT MODE SPURIOUS RADIATED EMISSIONS LIMITS – FHSS and DTS SYSTEMS

The limits for unwanted (spurious) emissions from the transmitter falling in the restricted bands are those specified in the general limits sections of FCC Part 15 and RSS GEN. All other unwanted (spurious) emissions shall be at least 20dB below the level of the highest in-band signal level (30dB if the power is measured using the sample detector/power averaging method).

SAMPLE CALCULATIONS - CONDUCTED EMISSIONS

Receiver readings are compared directly to the conducted emissions specification limit (decibel form) as follows:

$$R_r - S = M$$

where:

R_r = Receiver Reading in dBuV

S = Specification Limit in dBuV

M = Margin to Specification in +/- dB

SAMPLE CALCULATIONS - RADIATED EMISSIONS

Receiver readings are compared directly to the specification limit (decibel form). The receiver internally corrects for cable loss, preamplifier gain, and antenna factor. The calculations are in the reverse direction of the actual signal flow, thus cable loss is added and the amplifier gain is subtracted. The Antenna Factor converts the voltage at the antenna coaxial connector to the field strength at the antenna elements.

A distance factor, when used for electric field measurements above 30MHz, is calculated by using the following formula:

$$F_d = 20 * \text{LOG}_{10} (D_m/D_s)$$

where:

F_d = Distance Factor in dB

D_m = Measurement Distance in meters

D_s = Specification Distance in meters

For electric field measurements below 30MHz the extrapolation factor is either determined by making measurements at multiple distances or a theoretical value is calculated using the formula:

$$F_d = 40 * \text{LOG}_{10} (D_m/D_s)$$

Measurement Distance is the distance at which the measurements were taken and Specification Distance is the distance at which the specification limits are based. The antenna factor converts the voltage at the antenna coaxial connector to the field strength at the antenna elements.

The margin of a given emission peak relative to the limit is calculated as follows:

$$R_c = R_r + F_d$$

and

$$M = R_c - L_s$$

where:

R_r = Receiver Reading in dBuV/m

F_d = Distance Factor in dB

R_c = Corrected Reading in dBuV/m

L_s = Specification Limit in dBuV/m

M = Margin in dB Relative to Spec

SAMPLE CALCULATIONS - FIELD STRENGTH TO EIRP CONVERSION

Where the radiated electric field strength is expressed in terms of the equivalent isotropic radiated power (eirp), or where a field strength measurement of output power is made in lieu of a direct measurement, the following formula is used to convert between eirp and field strength at a distance of d (meters) from the equipment under test:

$$E = \frac{1000000 \sqrt{30 P}}{d} \quad \text{microvolts per meter}$$

where P is the eirp (Watts)

For a measurement at 3m the conversion from a logarithmic value for field strength (dBuV/m) to an eirp power (dBm) is -95.3dB.

Appendix A Test Equipment Calibration Data

<u>Manufacturer</u>	<u>Description</u>	<u>Model</u>	<u>Asset #</u>	<u>Calibrated</u>	<u>Cal Due</u>
Radiated Emissions, 30 - 1,000 MHz, 29-Oct-20					
National Technical Systems	NTS EMI Software (rev 2.10)	N/A	WC022452	N/A	
Rohde & Schwarz	EMI Test Receiver, 20 Hz-7 GHz	ESIB 7	WC064492	7/1/2020	7/1/2021
Sunol Sciences Com-Power	Biconilog, 30-3000 MHz Preamplifier, 1-1000 MHz	JB3 PAM-103	WC064573 WC064733	12/3/2019 7/31/2020	12/3/2021 7/31/2021
Radiated Emissions, 1,000 - 25,000 MHz, 04-Jan-21					
National Technical Systems	NTS EMI Software (rev 2.10)	N/A	WC022452	N/A	
Hewlett Packard	Spectrum Analyzer (Red)	8564E (84125C)	WC055584	10/9/2020	10/9/2021
Hewlett Packard	Microwave Preamplifier Head, 18-40 GHz (Red)	84125C EMI Test Head	WC055586	10/20/2020	10/20/2021
EMCO	Horn Antenna	3115	WC062584	6/5/2019	6/5/2021
A. H. Systems	Antenna, Horn, 18-40GHz	SAS-574	WC064553	10/19/2020	10/19/2022
Hewlett Packard	Microwave Preamplifier, 1-26.5GHz	8449B	WC068124	12/2/2020	12/2/2021
Hewlett Packard	High Pass filter, 3.5 GHz	P/N 84300-80038	WC064434	1/7/2020	1/7/2021
Radiated Emissions, 11-Jan-21					
National Technical Systems	NTS EMI Software (rev 2.10)	N/A	WC022452	N/A	
Hewlett Packard	Spectrum Analyzer (Red)	8564E (84125C)	WC055584	10/9/2020	10/9/2021
EMCO	Horn Antenna	3115	WC062584	6/5/2019	6/5/2021
Hewlett Packard	Microwave Preamplifier, 1-26.5GHz	8449B	WC068124	12/2/2020	12/2/2021
Rhode & Schwarz	EMI Test Receiver 20Hz-26.5GHz	ESI	WC071498	5/4/2020	5/4/2021
K&L Microwave	Filter, High Pass	11SH10	WC072564	11/20/2020	11/2/2021
Radio Antenna Port (Power and Spurious Emissions), 11-Jan-21					
National Technical Systems	NTS Capture Analyzer Software (rev 4.0)	N/A	WC022706	N/A	
Rhode & Schwarz	EMI Test Receiver 20Hz-26.5GHz	ESI	WC071498	5/4/2020	5/4/2021
SM Electronics	Attenuator	SA18B-10	WC072177	N/A	

Appendix B Test Data

TL124075-RA Pages 26 – 43



EMC Test Data

Client:	Appticity Corporation	PR Number:	PR124075
Product:	BT Tag	T-Log Number:	TL124075-RA
System Configuration:	-	Project Manager:	Christine Krebill
Contact:	Marci Haslam	Project Engineer:	David Bare
Emissions Standard(s):	FCC Part 15.247, RSS-247	Class:	
Immunity Standard(s):	-	Environment:	Radio

EMC Test Data

For The

Appticity Corporation

Product

BT Tag

Date of Last Test: 1/11/2021



EMC Test Data

Client:	Apptivity Corporation	PR Number:	PR124075
Model:	BT Tag	T-Log Number:	TL124075-RA
		Project Manager:	Christine Krebill
Contact:	Marci Haslam	Project Engineer:	David Bare
Standard:	FCC Part 15.247, RSS-247	Class:	N/A

RSS-247 and FCC 15.247 (DTS) Antenna Port Measurements Power, PSD, Bandwidth and Spurious Emissions

Test Specific Details

Objective: The objective of this test session is to perform final qualification testing of the EUT with respect to the specification listed above.

Date of Test: 1/11/2021
 Test Engineer: David Bare
 Test Location: Fremont Chamber #4

Config. Used: 1
 Config Change: Used power supply instead of batteries
 EUT Voltage: 3.2VDC

General Test Configuration

The EUT was connected to the spectrum analyzer or power meter via a suitable attenuator. All measurements were made on a single chain.
 All measurements have been corrected to allow for the external attenuators used.

Ambient Conditions: Temperature: 19 °C
 Rel. Humidity: 45 %

Summary of Results

Run #	Pwr setting	Test Performed	Limit	Pass / Fail	Result / Margin
1	Max	Output Power	15.247(b)	Pass	21.4 dBm
2	Max	Power spectral Density (PSD)	15.247(d)	Pass	5.0 dBm/3kHz
3	Max	Minimum 6dB Bandwidth	15.247(a)	Pass	0.61 MHz
3	Max	99% Bandwidth	RSS GEN	-	1.09 MHz
4	Max	Spurious emissions	15.247(b)	Pass	> -20dBc

Modifications Made During Testing

No modifications were made to the EUT during testing
 The sample was modified by adding a coaxial pigtail to the output to facilitate testing.

Deviations From The Standard

No deviations were made from the requirements of the standard.

Procedure Comments:

Measurements performed in accordance with ANSI C63.10

Sample Notes

Sample S/N: CC6C6E9A1AF5



EMC Test Data

Client: Appticity Corporation	PR Number: PR124075
Model: BT Tag	T-Log Number: TL124075-RA
Contact: Marci Haslam	Project Manager: Christine Krebill
Standard: FCC Part 15.247, RSS-247	Project Engineer: David Bare
	Class: N/A

Run #1: Output Power

Power Setting ²	Frequency (MHz)	Output Power		Antenna Gain (dBi)	Result	EIRP		Output Power	
		(dBm) ¹	mW			dBm	W	(dBm) ³	mW
Max	2402	20.2	104.7	3.0	Pass	23.2	0.209		
Max	2426	20.4	109.6	3.0	Pass	23.4	0.219		
Max	2480	21.4	138.0	3.0	Pass	24.4	0.275		

- Note 1: Output power measured using a spectrum analyzer with peak detector and RBW = 3 MHz, VBW = 10 MHz, spurious limit is thus -20dBc.
- Note 2: Power setting - the software power setting used during testing, included for reference only.
- Note 3: Power measured using average power meter (non-gated) and if included is included for reference only.

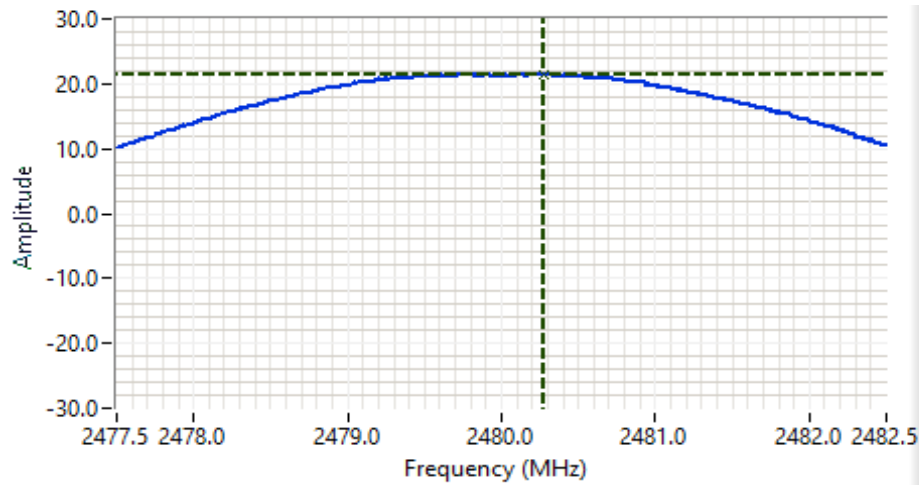

Analyzer Settings

Rohde&Schwarz,ESI
 CF: 2480.000 MHz
 SPAN: 5.000 MHz
 RB: 3.000 MHz
 VB: 10.000 MHz
 Detector: POS
 Attn: 70 DB
 RL Offset: 10.0 DB
 Sweep Time: 5.0ms
 Ref Lvl: 30.0 DBM

Comments

Cursor	2480.27551	21.4	
	0.000000	0.0	





EMC Test Data

Client: Aptricity Corporation	PR Number: PR124075
Model: BT Tag	T-Log Number: TL124075-RA
Contact: Marci Haslam	Project Manager: Christine Krebill
Standard: FCC Part 15.247, RSS-247	Project Engineer: David Bare
	Class: N/A

Run #2: Power spectral Density

Power Setting	Frequency (MHz)	PSD	Limit	Result
		(dBm/3kHz) ^{Note 1}	dBm/3kHz	
Max	2402	3.1	8.0	Pass
Max	2426	3.2	8.0	Pass
Max	2480	5.0	8.0	Pass

Note 1: Test performed per method PKSPD, in KDB 558074. Power spectral density measured using: 3kHz ≤ RBW ≤ 100kHz, VBW=3*RBW, peak detector, span = 1.5*DTS BW, auto sweep time, max hold.

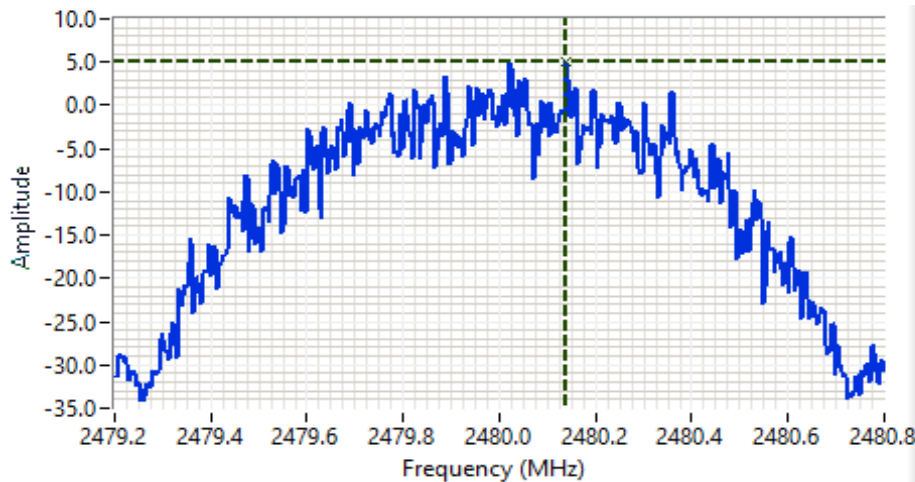

Analyzer Settings

Rohde&Schwarz,ESI
 CF: 2480.000 MHz
 SPAN: 1.600 MHz
 RB: 3.00 kHz
 VB: 30.0 kHz
 Detector: POS
 Attn: 70 DB
 RL Offset: 10.0 DB
 Sweep Time: 0.5s
 Ref Lvl: 30.0 DBM

Comments

Cursor 2480.139479 5.0

0.000000 0.0





EMC Test Data

Client: Appticity Corporation	PR Number: PR124075
Model: BT Tag	T-Log Number: TL124075-RA
Contact: Marci Haslam	Project Manager: Christine Krebill
Standard: FCC Part 15.247, RSS-247	Project Engineer: David Bare
	Class: N/A

Run #3: Signal Bandwidth

Power Setting	Frequency (MHz)	Bandwidth (MHz)		RBW Setting (MHz)	
		6dB	99%	6dB	99%
Max	2402	0.609	1.090	0.1	0.03
Max	2426	0.637	1.080	0.1	0.03
Max	2480	0.629	1.074	0.1	0.3

Note 1: DTS BW: RBW=100kHz, VBW ≥ 3*RBW, peak detector, max hold, auto sweep time, Span 2-5 times measured BW.
 99% BW: RBW=1-5% of 99%BW, VBW ≥ 3*RBW, peak detector, max hold, auto sweep time. Span 1.5-5 times OBW.

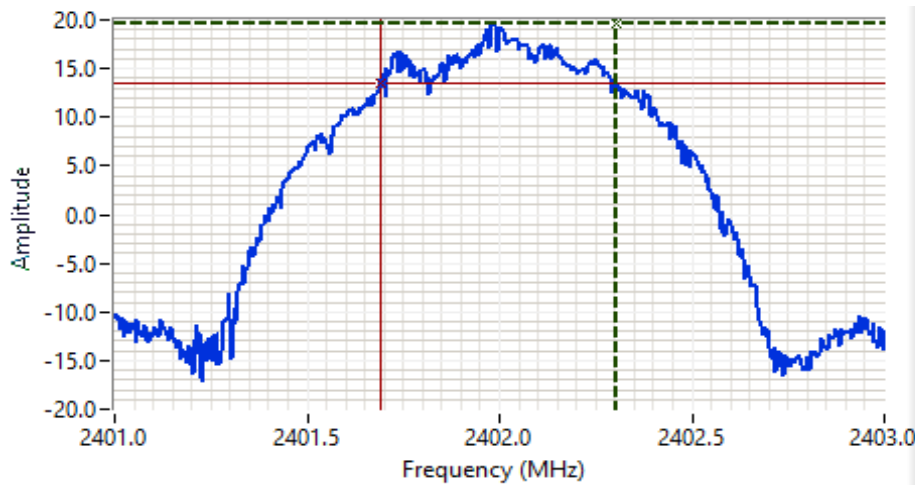

Analyzer Settings
 Rohde&Schwarz,ESI
 CF: 2402.000 MHz
 SPAN: 2.000 MHz
 RB: 100 kHz
 VB: 1.000 MHz
 Detector: POS
 Attn: 60 DB
 RL Offset: 10.0 DB
 Sweep Time: 5.0ms
 Ref Lvl: 20.0 DBM
 Comments
 6dB BW: 609 kHz

Cursor 2402.302605 19.5

Cursor 2401.693387 13.5

Delta Freq. 609 kHz

Delta Amplitude 6.0





EMC Test Data

Client: Aptricity Corporation	PR Number: PR124075
Model: BT Tag	T-Log Number: TL124075-RA
Contact: Marci Haslam	Project Manager: Christine Krebill
Standard: FCC Part 15.247, RSS-247	Project Engineer: David Bare
	Class: N/A

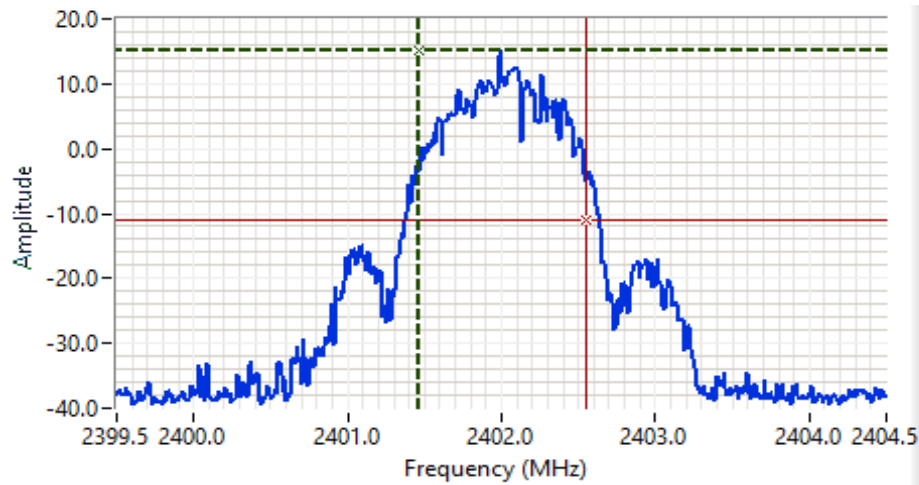

Analyzer Settings

- Rohde&Schwarz, ESI
- CF: 2402.000 MHz
- SPAN: 5.000 MHz
- RB: 30.0 kHz
- VB: 300 kHz
- Detector: POS
- Attn: 60 DB
- RL Offset: 10.0 DB
- Sweep Time: 14.0ms
- Ref Lvl: 20.0 DBM

Comments

99% power BW: 1.090 MHz

Cursor	2401.460000	15.1		Delta Freq.	1.090
Cursor	2402.550000	-10.9		Delta Amplitude	26.0





EMC Test Data

Client:	Appticity Corporation	PR Number:	PR124075
Model:	BT Tag	T-Log Number:	TL124075-RA
Contact:	Marci Haslam	Project Manager:	Christine Krebill
Standard:	FCC Part 15.247, RSS-247	Project Engineer:	David Bare
		Class:	N/A

Run #4a: Out of Band Spurious Emissions

Frequency (MHz)	Power Setting	Mode	Limit	Result
2402	Max	BLE	-20dBc	Pass
2426	Max	BLE	-20dBc	Pass
2480	Max	BLE	-20dBc	Pass

RBW = 200 Hz and VBW = 1 kHz for 30kHz to 150 kHz plots.

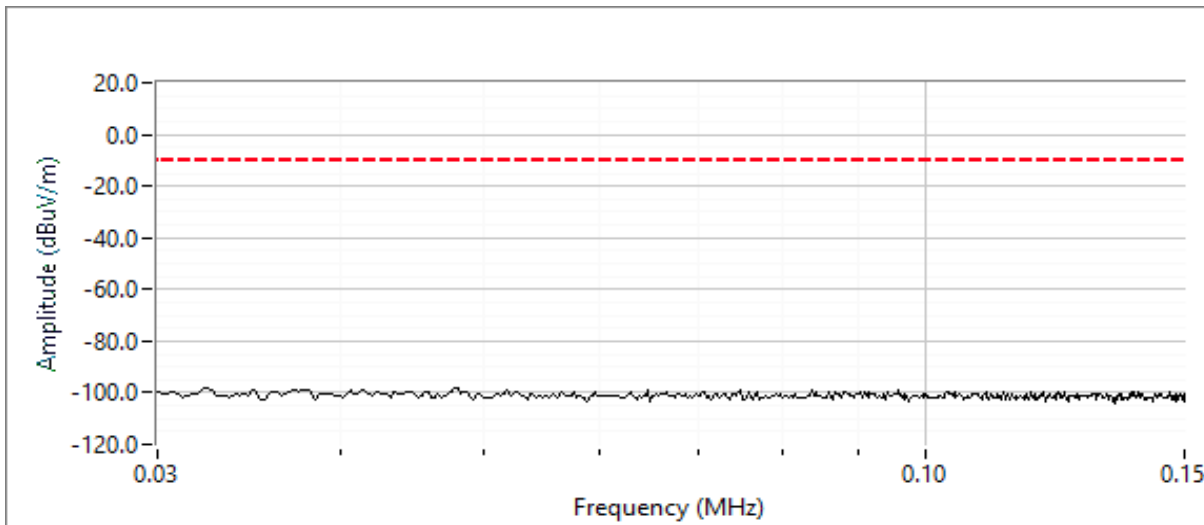



EMC Test Data

Client:	Appticity Corporation	PR Number:	PR124075
Model:	BT Tag	T-Log Number:	TL124075-RA
Contact:	Marci Haslam	Project Manager:	Christine Krebill
Standard:	FCC Part 15.247, RSS-247	Project Engineer:	David Bare
		Class:	N/A

RBW = 10 kHz and VBW = 30 kHz for 150 kHz to 30 MHz plots.

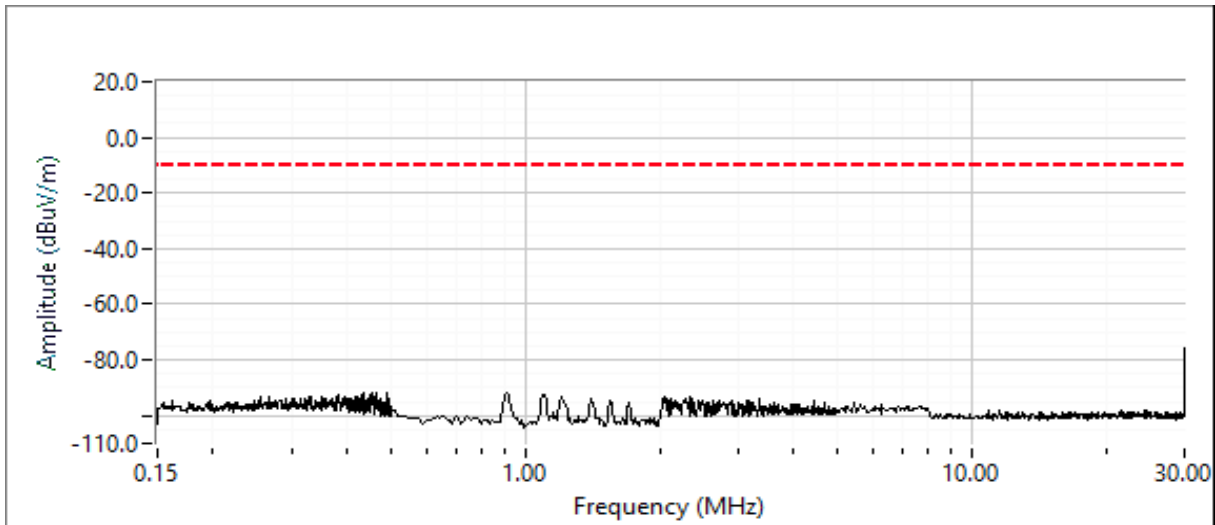

RBW = 100 kHz and VBW = 300 kHz for 30 MHz to 25 GHz plots.

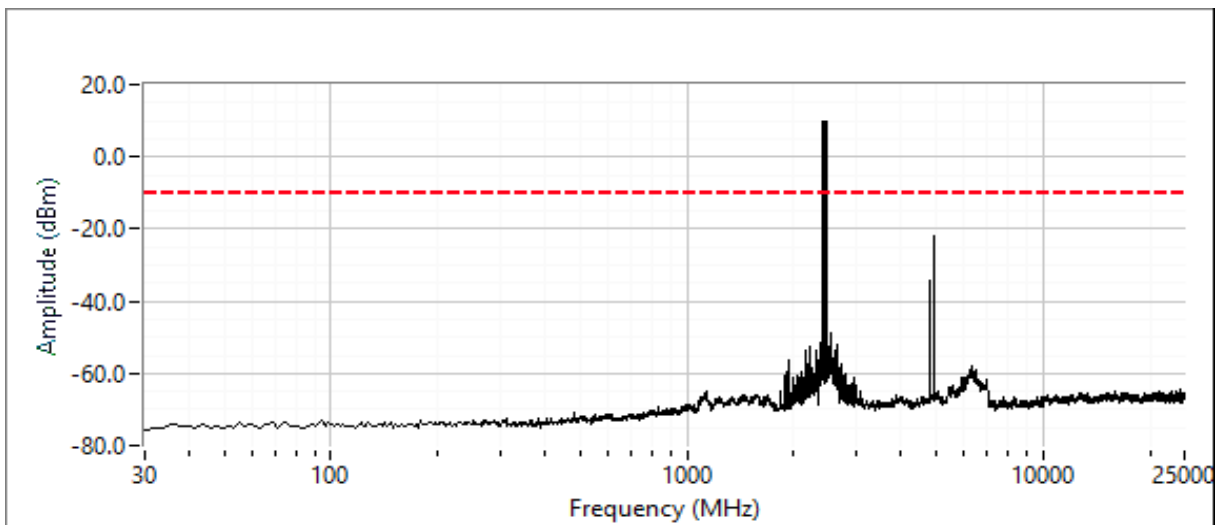



EMC Test Data

Client:	Appticity Corporation	PR Number:	PR124075
Model:	BT Tag	T-Log Number:	TL124075-RA
Contact:	Marci Haslam	Project Manager:	Christine Krebill
Standard:	FCC Part 15.247, RSS-247	Project Engineer:	David Bare
		Class:	N/A

Additional plot showing compliance with -20dBc limit from 2390 MHz to 2400 MHz. Radiated measurements used to show compliance with the limits in the restricted band below 2390 MHz.

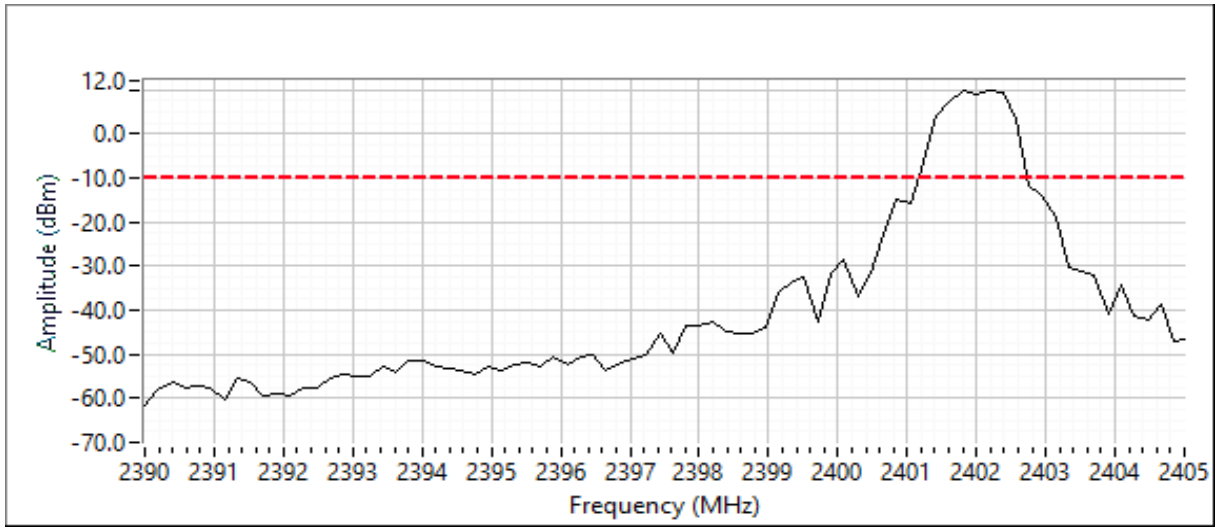



EMC Test Data

Client:	Appticity Corporation	PR Number:	PR124075
Model:	BT Tag	T-Log Number:	TL124075-RA
Contact:	Marci Haslam	Project Manager:	Christine Krebill
Standard:	FCC Part 15.247, RSS-247	Project Engineer:	David Bare
		Class:	N/A

RSS-247 and FCC 15.247 (DTS) Radiated Spurious Emissions

Test Specific Details

Objective: The objective of this test session is to perform final qualification testing of the EUT with respect to the specification listed above.

General Test Configuration

The EUT and all local support equipment were located on the turntable for radiated spurious emissions testing. For radiated emissions testing the measurement antenna was located 3 meters from the EUT, unless otherwise noted.

Ambient Conditions: Temperature: 19 °C
Rel. Humidity: 45 %

Summary of Results - Device Operating in the 2400-2483.5 MHz Band

Run #	Channel	Power Setting	Test Performed	Limit	Result / Margin
1	37 2402MHz	Max	Restricted Band Edge (2390 MHz)	FCC Part 15.209 / 15.247(d)	55.3 dBµV/m @ 2371.4 MHz (-18.7 dB)
	39 2480MHz	Max	Restricted Band Edge (2483.5 MHz)	FCC Part 15.209 / 15.247(d)	62.3 dBµV/m @ 2483.9 MHz (-11.7 dB)

Modifications Made Prior To Testing

The following modifications were made to the EUT prior to testing in order to facilitate measurements for the standard:
The duty cycle was increased from one transmission per second to 40 transmissions per second.
A tuned filter was added to the RF output.

Deviations From The Standard

No deviations were made from the requirements of the standard.

Sample Notes

Sample S/N: None

Date of Test: 01/11/21
Test Engineer: David Bare
Test Location: Fremont Chamber #4

Config. Used: 1
Config Change: None
EUT Voltage: Battery



EMC Test Data

Client:	Appticity Corporation	PR Number:	PR124075
Model:	BT Tag	T-Log Number:	TL124075-RA
Contact:	Marci Haslam	Project Manager:	Christine Krebill
Standard:	FCC Part 15.247, RSS-247	Project Engineer:	David Bare
		Class:	N/A

Procedure Comments:

Measurements performed in accordance with ANSI C63.10

Peak measurements performed with: RBW=1MHz, VBW=3MHz, peak detector, max hold, auto sweep time

Unless otherwise stated/noted, emission has a duty cycle $\geq 98\%$ and was measured using RBW=1MHz, VBW=10Hz, peak detector, linear voltage average, auto sweep time, max hold.

Mode	Data Rate	Duty Cycle (x)	Constant DC?	T (ms)	Pwr Cor Factor*	Lin Volt Cor Factor**	Min VBW for FS (Hz)
BLE	1 Mb/s	0.03	No	0.59	15.3	30.6	1695

Measurement Specific Notes:

Note 1:	Emission in non-restricted band, but limit of 15.209 used.
Note 2:	Emission in non-restricted band, the limit was set 30dB below the level of the fundamental and measured in 100kHz.
Note 3:	Emission has a duty cycle $\geq 98\%$, average measurement performed: RBW=1MHz, VBW=3MHz, RMS, Power averaging, auto sweep, trace average 100 traces
Note 4:	Emission has constant duty cycle $< 98\%$, average measurement performed: RBW=1MHz, VBW> $> 1/T$ but not less than 10Hz, peak detector, linear averaging, auto sweep, trace average 100 traces, measurement corrected by Linear voltage correction factor
Note 5:	Emission has constant duty cycle $< 98\%$, average measurement performed: RBW=1MHz, VBW=3MHz, RMS, Power averaging, auto sweep, trace average 100 traces, measurement corrected by Pwr correction factor
Note 6:	Emission has non constant duty cycle $< 98\%$, average measurement performed: RBW=1MHz, VBW> $> 1/T$, peak detector, linear voltage average, sweep time auto, max hold. Max hold for $50*(1/DC)$ traces
Note 7:	Emission has non constant duty cycle $< 98\%$, average measurement performed: RBW=1MHz, VBW> $> 1/T$, RMS detector, sweep time auto, max hold. Max hold for $50*(1/DC)$ traces
Note 8:	Emission has non constant duty cycle $< 98\%$, average value computed from peak value using 20 dB correction factor as duty cycle in use is less than 10%.
Note 9:	Plots of the average and peak bandedge do not account for any duty cycle correction. Refer to the tabular results for final measurements.
Note:	Based on preliminary testing the highest spurious emissions were obtained with the EUT on its side.



EMC Test Data

Client: Appticity Corporation	PR Number: PR124075
Model: BT Tag	T-Log Number: TL124075-RA
Contact: Marci Haslam	Project Manager: Christine Krebill
Standard: FCC Part 15.247, RSS-247	Project Engineer: David Bare
	Class: N/A

Run #1: Radiated Bandedge Measurements

Band Edge Signal Field Strength - Direct measurement of field strength

Frequency MHz	Level dB μ V/m	Pol V/H	15.209 / 15.247		Detector Pk/QP/Avg	Azimuth degrees	Height meters	Comments
			Limit	Margin				
2483.870	62.3	H	74.0	-11.7	Peak	350	1.5	POS; RB 1 MHz; VB: 3 MHz
2483.870	42.3	H	54.0	-11.7	Avg	350	1.5	POS; RB 1 MHz; VB: 3 MHz;Note 8

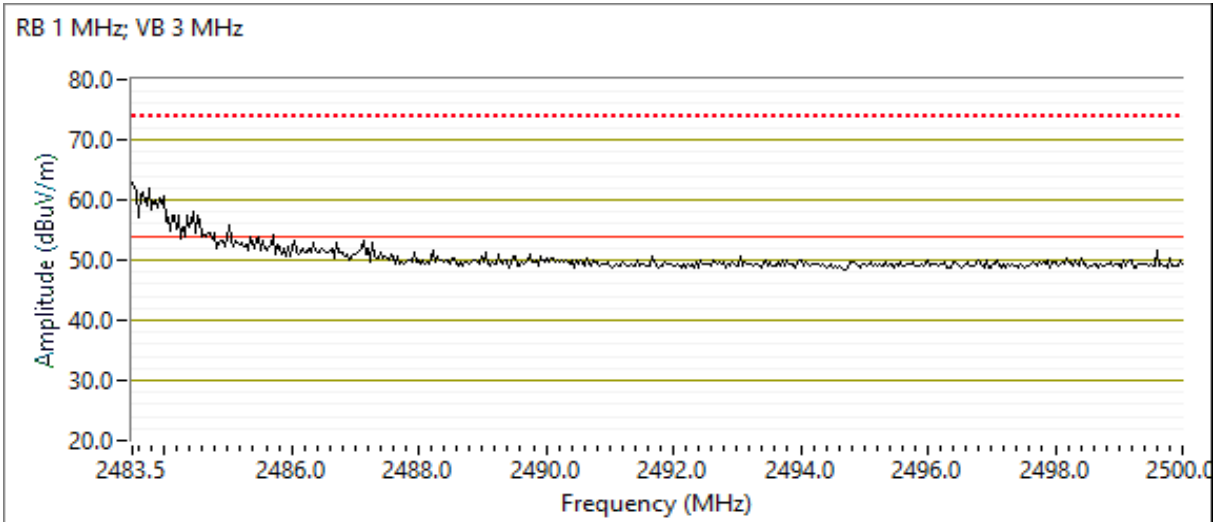



EMC Test Data

Client:	Appticity Corporation	PR Number:	PR124075
Model:	BT Tag	T-Log Number:	TL124075-RA
Contact:	Marci Haslam	Project Manager:	Christine Krebill
Standard:	FCC Part 15.247, RSS-247	Project Engineer:	David Bare
		Class:	N/A

Band Edge Signal Field Strength - Direct measurement of field strength

Frequency MHz	Level dB μ V/m	Pol V/H	15.209 / 15.247		Detector Pk/QP/Avg	Azimuth degrees	Height meters	Comments
			Limit	Margin				
2371.430	55.3	H	74.0	-18.7	Peak	355	1.5	POS; RB 1 MHz; VB: 3 MHz
2371.430	35.3	H	54.0	-18.7	Avg	355	1.5	POS; RB 1 MHz; VB: 3 MHz;Note 8

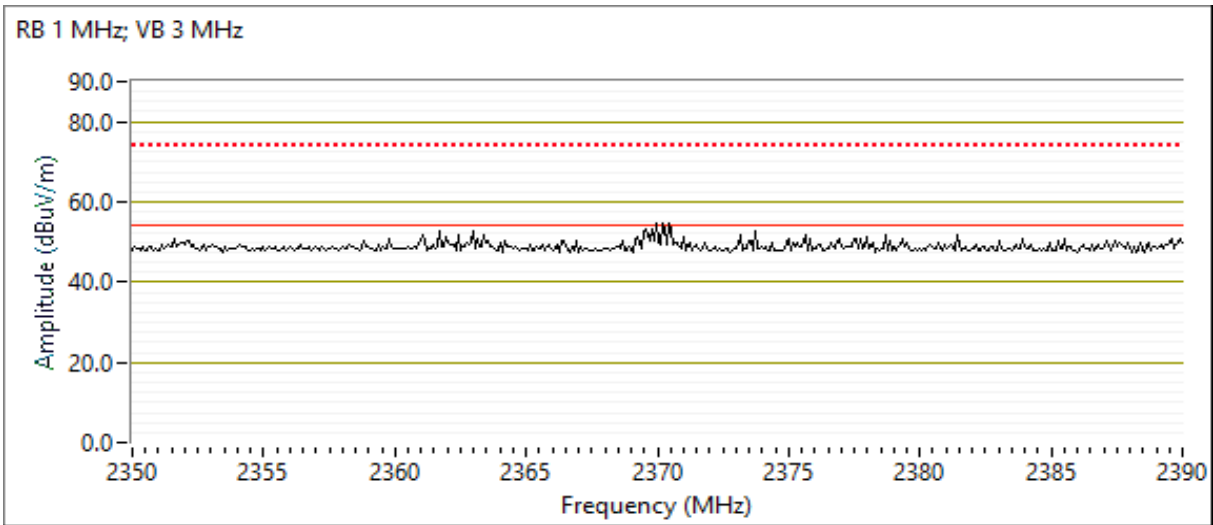



EMC Test Data

Client:	Appticity Corporation	PR Number:	PR124075
Model:	BT Tag	T-Log Number:	TL124075-RA
Contact:	Marci Haslam	Project Manager:	Christine Krebill
Standard:	FCC Part 15.247, RSS-247	Project Engineer:	David Bare
		Class:	N/A

RSS-247 and FCC 15.247 (DTS) Radiated Spurious Emissions

Test Specific Details

Objective: The objective of this test session is to perform final qualification testing of the EUT with respect to the specification listed above.

General Test Configuration

The EUT and all local support equipment were located on the turntable for radiated spurious emissions testing.

For radiated emissions testing the measurement antenna was located 3 meters from the EUT, unless otherwise noted.

Ambient Conditions:

Temperature: 19 °C
Rel. Humidity: 45 %

Summary of Results - Device Operating in the 2400-2483.5 MHz Band

Run #	Channel	Power Setting	Test Performed	Limit	Result / Margin
1	37, 38 & 39	Max	Radiated Emissions, 1 - 25 GHz	FCC Part 15.209 / 15.247(c)	46.2 dBµV/m @ 3819.6 MHz (-7.8 dB)

Modifications Made Prior To Testing

The following modifications were made to the EUT prior to testing in order to facilitate measurements for the standard:
The duty cycle was increased from one transmissions per second to 40 transmissions per second.
A tuned filter was added to the RF output.

Deviations From The Standard

No deviations were made from the requirements of the standard.

Sample Notes

Sample S/N: None



EMC Test Data

Client:	Appticity Corporation	PR Number:	PR124075
Model:	BT Tag	T-Log Number:	TL124075-RA
Contact:	Marci Haslam	Project Manager:	Christine Krebill
Standard:	FCC Part 15.247, RSS-247	Project Engineer:	David Bare
		Class:	N/A

Procedure Comments:

Measurements performed in accordance with ANSI C63.10
 Peak measurements performed with: RBW=1MHz, VBW=3MHz, peak detector, max hold, auto sweep time
 Unless otherwise stated/noted, emission has duty cycle $\geq 98\%$ and was measured using RBW=1MHz, VBW=10Hz, peak detector, linear voltage average, auto sweep time, max hold.
 2.4GHz band reject filter used for emissions except for in band measurements.

Mode	Data Rate	Duty Cycle (x)	Constant DC?	T (ms)	Pwr Cor Factor*	Lin Volt Cor Factor**	Min VBW for FS (Hz)
BLE	1 Mb/s	0.03	No	0.59	15.3	30.6	1695

Measurement Specific Notes:

Note 1:	Emission in non-restricted band, but limit of 15.209 used.
Note 2:	Emission in non-restricted band, the limit was set 30dB below the level of the fundamental and measured in 100kHz.
Note 3:	Emission has a duty cycle $\geq 98\%$, average measurement performed: RBW=1MHz, VBW=3MHz, RMS, Power averaging, auto sweep, trace average 100 traces
Note 4:	Emission has constant duty cycle $< 98\%$, average measurement performed: RBW=1MHz, VBW $> 1/T$ but not less than 10Hz, peak detector, linear averaging, auto sweep, trace average 100 traces, measurement corrected by Linear voltage correction factor
Note 5:	Emission has constant duty cycle $< 98\%$, average measurement performed: RBW=1MHz, VBW=3MHz, RMS, Power averaging, auto sweep, trace average 100 traces, measurement corrected by Pwr correction factor
Note 6:	Emission has non constant duty cycle $< 98\%$, average measurement performed: RBW=1MHz, VBW $> 1/T$, peak detector, linear voltage average, sweep time auto, max hold. Max hold for $50*(1/DC)$ traces
Note 7:	Emission has non constant duty cycle $< 98\%$, average measurement performed: RBW=1MHz, VBW $> 1/T$, RMS detector, sweep time auto, max hold. Max hold for $50*(1/DC)$ traces
Note 8:	Emission has non constant duty cycle $< 98\%$, average value computed from peak value using 20 dB correction factor as duty cycle in use is less than 10%.
Note:	Based on preliminary testing the highest spurious emissions were obtained with the EUT on its side.



EMC Test Data

Client: Appticity Corporation	PR Number: PR124075
Model: BT Tag	T-Log Number: TL124075-RA
Contact: Marci Haslam	Project Manager: Christine Krebill
Standard: FCC Part 15.247, RSS-247	Project Engineer: David Bare
	Class: N/A

Run #1: Radiated Spurious Emissions, 1,000 - 25,000 MHz.

Date of Test: 01/04/21

Test Engineer: David Bare

Test Location: Fremont Chamber #4

Config. Used: 1

Config Change: None

EUT Voltage: Battery

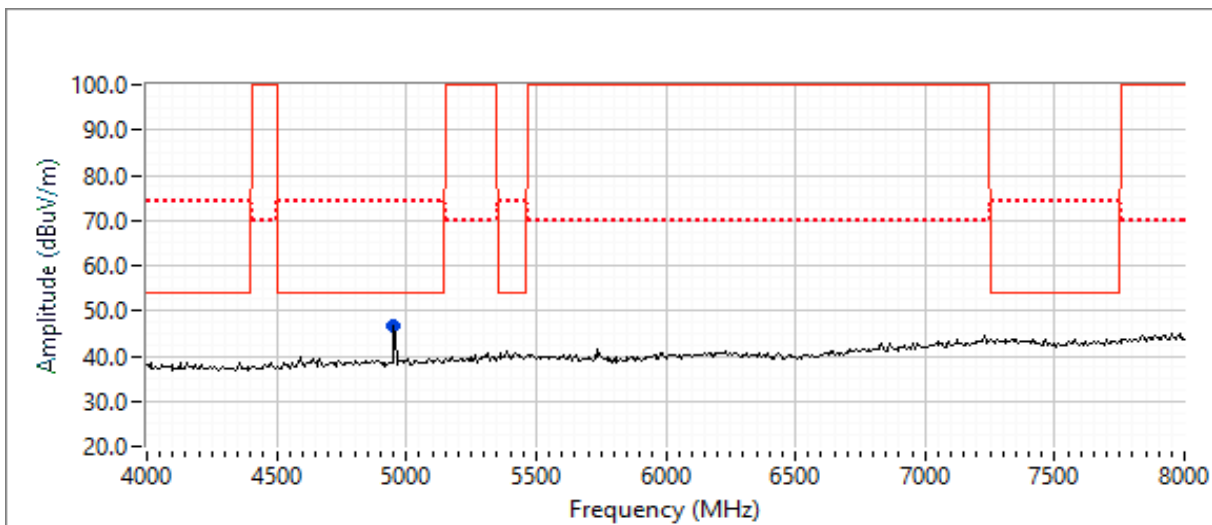
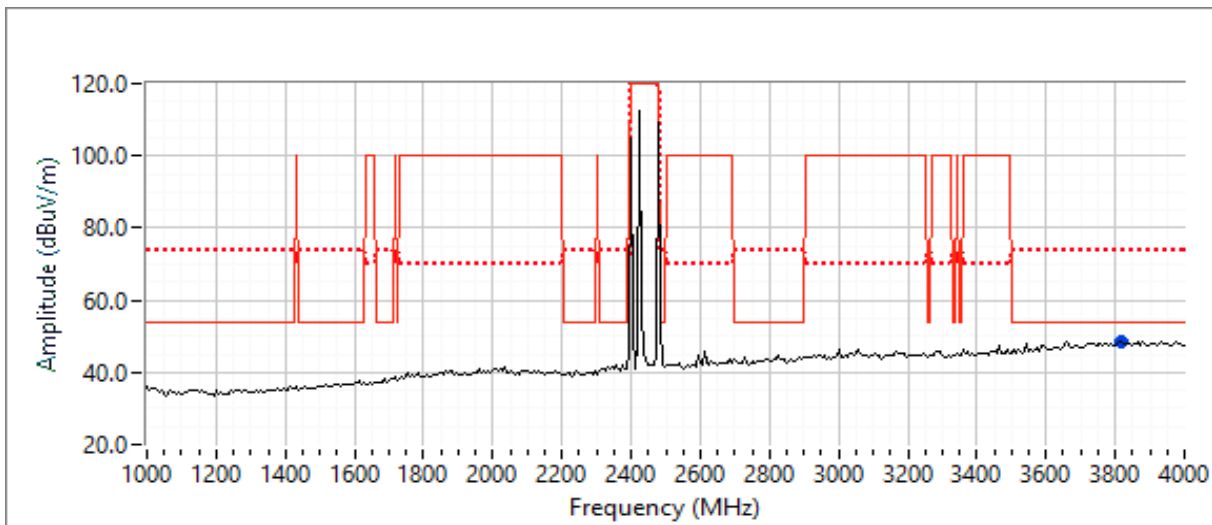



EMC Test Data

Client:	Appticity Corporation	PR Number:	PR124075
Model:	BT Tag	T-Log Number:	TL124075-RA
Contact:	Marci Haslam	Project Manager:	Christine Krebill
Standard:	FCC Part 15.247, RSS-247	Project Engineer:	David Bare
		Class:	N/A

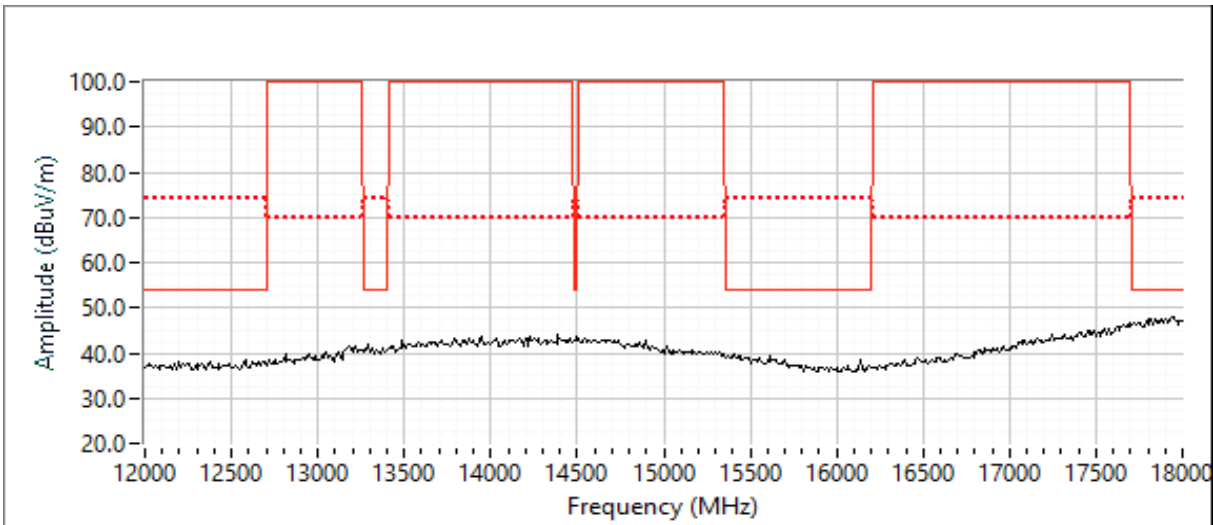
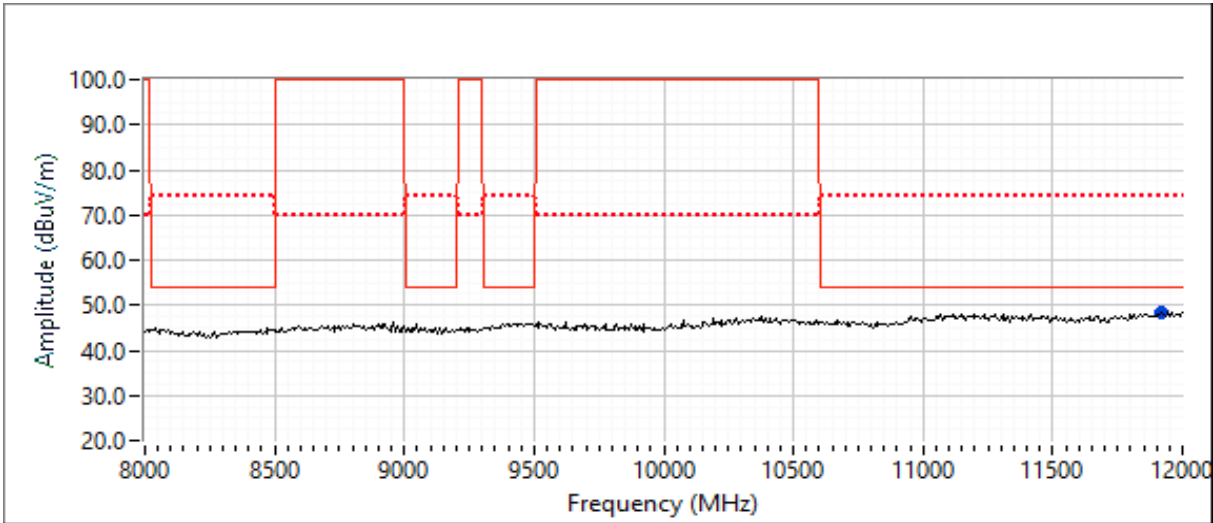



EMC Test Data

Client:	Apptricity Corporation	PR Number:	PR124075
Model:	BT Tag	T-Log Number:	TL124075-RA
Contact:	Marci Haslam	Project Manager:	Christine Krebill
Standard:	FCC Part 15.247, RSS-247	Project Engineer:	David Bare
		Class:	N/A

Frequency MHz	Level dB μ V/m	Pol V/H	15.209 / 15.247		Detector Pk/QP/Avg	Azimuth degrees	Height meters	Comments
			Limit	Margin				
2402.000	110.6	H	-	-	PK	0	1.85	RB 100 kHz;VB 300 kHz;Peak
2426.000	114.4	H	-	-	PK	0	1.85	RB 100 kHz;VB 300 kHz;Peak
2480.000	108.8	H	-	-	PK	0	1.85	RB 100 kHz;VB 300 kHz;Peak
3819.640	46.2	V	54.0	-7.8	PK	350	1.63	RB 1 MHz;VB 3 MHz;Peak
4804.310	49.6	H	74.0	-24.4	PK	219	1.22	RB 1 MHz;VB 3 MHz;Peak
4804.310	29.6	H	54.0	-24.4	AVG	219	1.22	RB 1 MHz;VB 3 MHz;Peak;Note 8
4851.770	51.3	H	74.0	-22.7	PK	223	1.31	RB 1 MHz;VB 3 MHz;Peak
4851.770	31.3	H	54.0	-22.7	AVG	223	1.31	RB 1 MHz;VB 3 MHz;Peak;Note 8
4958.570	50.2	H	74.0	-23.8	PK	226	1.33	RB 1 MHz;VB 3 MHz;Peak
4958.570	30.2	H	54.0	-23.8	AVG	226	1.33	RB 1 MHz;VB 3 MHz;Peak;Note 8
7438.940	52.1	H	74.0	-21.9	PK	219	1.56	RB 1 MHz;VB 3 MHz;Peak
7438.940	32.1	H	54.0	-21.9	PK	219	1.56	RB 1 MHz;VB 3 MHz;Peak
11921.470	43.2	H	54.0	-10.8	AVG	46	1.50	RB 1 MHz;VB 10 Hz;Peak
11918.970	55.6	H	74.0	-18.4	PK	46	1.50	RB 1 MHz;VB 3 MHz;Peak

Note:	Scans made between 18 - 25 GHz with the measurement antenna moved around the EUT 30cm from the device indicated there were no significant emissions in this frequency range.
Note:	Measurements at 3819.64MHz and 11921.47MHz are of the noise floor of the test equipment as no emission of the EUT was observed at these frequencies.



End of Report

This page is intentionally blank and marks the last page of this test report.