

FCC - TEST REPORT

Report Number : **68.950.22.0646.01** Date of Issue: June 20, 2022

Model : **T4HiU2110/37k, T4HiU2201/37kA, T4HiU2202/37kA, T4HiU2208/37kA, Streamer V3 BLE, STRMBLE03**

Product Type : Bluetooth Remote Control

Applicant : Tech4Home International, Lda

Address : Startup Madeira – Campus da Penteada, 9020-105 Funchal,
PORTUGAL

Production Facility : Tech4Home International, Lda

Address : Startup Madeira – Campus da Penteada, 9020-105 Funchal,
PORTUGAL

Test Result : **Positive** **Negative**

Total pages including Appendices : 28

Any use for advertising purposes must be granted in writing. This technical report may only be quoted in full. This report is the result of a single examination of the object in question and is not generally applicable evaluation of the quality of other products in regular production. For further details, please see testing and certification regulation, chapter A-3.4.



1 Table of Contents

1	Table of Contents.....	2
2	Details about the Test Laboratory	3
3	Description of the Equipment under Test.....	4
4	Summary of Test Standards	5
5	Summary of Test Results.....	6
6	General Remarks.....	7
7	Test Setups	8
8	Systems test configuration	9
9	Technical Requirement.....	10
9.1	Conducted Emission	10
9.2	Conducted peak output power.....	11
9.3	6dB bandwidth	13
9.4	Power spectral density	15
9.5	Spurious RF conducted emissions.....	17
9.6	Band edge.....	21
9.7	Spurious radiated emissions for transmitter	23
10	Test Equipment List.....	27
11	System Measurement Uncertainty	28



2 Details about the Test Laboratory

Details about the Test Laboratory

Test Site 1

Company name: TÜV SÜD Certification and Testing (China) Co., Ltd. Shenzhen Branch
Building 12&13, Zhiheng Wisdomland Business Park,
Nantou Checkpoint Road 2, Nanshan District,
Shenzhen City, 518052,
P. R. China

FCC Registration Number: 514049

FCC Designation Number: CN5009

Telephone: 86 755 8828 6998

Fax: 86 755 8828 5299

3 Description of the Equipment under Test

Product:	Bluetooth Remote Control
Test Model No.:	T4HiU2110/37k
FCC ID:	2AYLW-STRMBLE03
Ratings:	3.0VDC (Supplied by 2 x 1.5VDC "AAA" size non-rechargeable batteries)
RF Transmission Frequency:	2402MHz-2480MHz
No. of Operated Channel:	40
Modulation:	GFSK
Antenna Type:	Integrated Antenna
Antenna Gain:	0 dBi
Description of the EUT:	The Equipment Under Test is Bluetooth Remote Control with BLE function (Bluetooth edition: 5.0, bite rate: 1Mbit/s). The BLE TX and RX frequency is 2402MHz-2480MHz.



4 Summary of Test Standards

Test Standards	
FCC Part 15 Subpart C 10-1-2020 Edition	PART 15 - RADIO FREQUENCY DEVICES Subpart C - Intentional Radiators

All the test methods were according to KDB558074 D01 DTS Meas Guidance v05r02 and ANSI C63.10 (2013).

5 Summary of Test Results

Technical Requirements				
FCC Part 15 Subpart C				
Test Condition		Pages	Test Result	Test Site
§15.207	Conducted emission AC power port	See note 1	Not Applicable	Site 1
§15.247(b)(1)	Conducted AV output power for FHSS	--	N/A	--
§15.247(b)(3)	Conducted peak output power for DTS	11	Pass	Site 1
§15.247(e)	Power spectral density	15	Pass	Site 1
§15.247(a)(2)	6dB bandwidth	13	Pass	Site 1
§15.247(a)(1)	20dB Occupied bandwidth	--	N/A	--
§15.247(a)(1)	Carrier frequency separation	--	N/A	--
§15.247(a)(1)(iii)	Number of hopping frequencies	--	N/A	--
§15.247(a)(1)(iii)	Dwell Time	--	N/A	--
§15.247(d)	Spurious RF conducted emissions	17	Pass	Site 1
§15.247(d)	Band edge	21	Pass	Site 1
§15.247(d) & §15.209 & §15.205	Spurious radiated emissions for transmitter	23	Pass	Site 1
§15.203	Antenna requirement	See note 2	Pass	--

Remark 1: N/A – Not Applicable.

Note 1: The EUT is powered by DC battery, therefore no test requirements for AC power port.

Note 2: The EUT uses an Integrated Antenna 0dBi max. According to §15.203, it is considered sufficiently to comply with the provisions of this section.



6 General Remarks

Remarks

This submittal(s) (test report) is intended for FCC ID: 2AYLW-STRMBLE03 complies with Section 15.205, 15.209, 15.247 of the FCC Part 15, Subpart C Rules.

All the models are all identical except for the outlook/color, So EMC testing was applied on T4HiU2110/37k, other models are deemed to fulfill relevant EMC requirement without further testing.

SUMMARY:

All tests according to the regulations cited on page 5 were

- Performed

- **Not** Performed

The Equipment under Test

- **Fulfills** the general approval requirements.

- **Does not** fulfill the general approval requirements.

Sample Received Date: May 19, 2022

Testing Start Date: May 31, 2022

Testing End Date: June 10, 2022

- TÜV SÜD Certification and Testing (China) Co., Ltd. Shenzhen Branch -

Reviewed by:

Prepared by:

Tested by:

John Zhi
EMC Section Manager



Grace Gao
EMC Project Engineer

Louise Liu
EMC Test Engineer

7 Test Setups

7.1 Radiated test setups

Below 1GHz

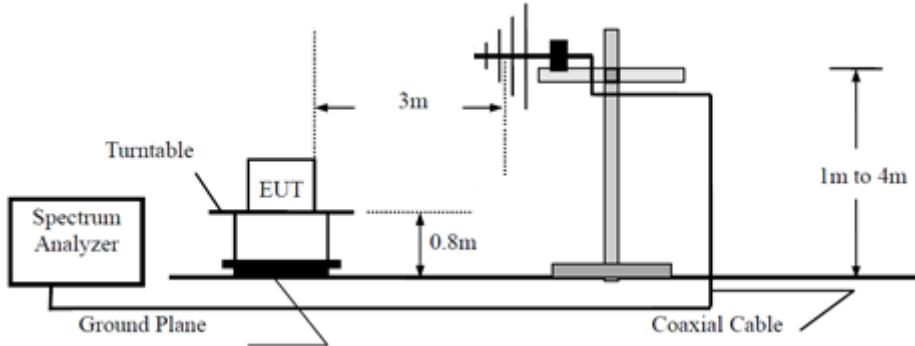

Above 1GHz

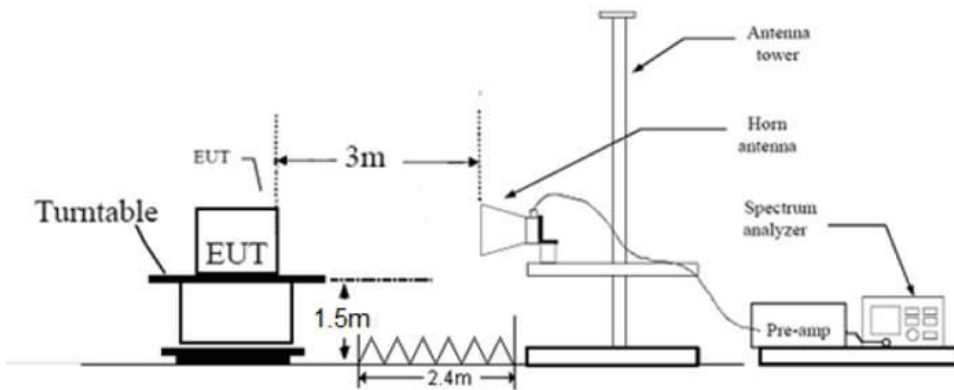

7.2 Conducted RF test setups

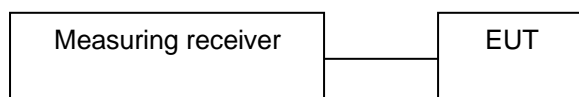

7.3 AC Power Line Conducted Emission test setups

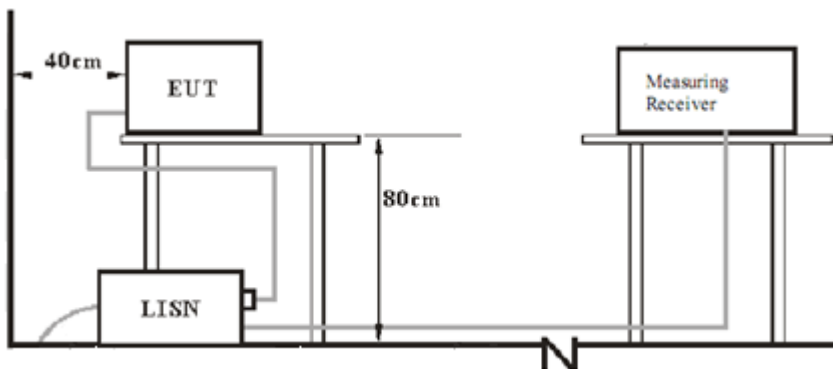

8 Systems test configuration

Auxiliary Equipment Used during Test:

Description	Manufacturer	Model no.	S/N
---	---	---	---
---	---	---	---
---	---	---	---

Test software information:

Test Software Version	Telink EMI_Test tool	
Modulation	Setting TX Power	Packet Type
GFSK	3.8dBm	PRBS9

The system was configured to channel 0, 19, and 39 for the test.

9 Technical Requirement

9.1 Conducted Emission

Test Method

1. The EUT was placed on a table, which is 0.8m above ground plane
2. The power line of the EUT is connected to the AC mains through a Artificial Mains Network (A.M.N.).
3. Maximum procedure was performed to ensure EUT compliance
4. A EMI test receiver is used to test the emissions from both sides of AC line

Limit

Frequency MHz	QP Limit dB μ V	AV Limit dB μ V
0.150-0.500	66-56*	56-46*
0.500-5	56	46
5-30	60	50

*Decreasing line

Test Results

N/A

9.2 Conducted peak output power

Test Method

1. The EUT was placed on 0.8m height table, the RF output of EUT was connected to the test receiver by RF cable. The path loss was compensated to the results for each measurement.
2. Use the following spectrum analyzer settings:
RBW > the 6dB bandwidth of the emission being measured, VBW \geq 3RBW, Span \geq 3RBW
Sweep = auto, Detector function = peak, Trace = max hold.
3. Allow the trace to stabilize. Use the marker-to-peak function to set the marker to the peak of the emission. The indicated level is the peak output power.

Limits

According to §15.247 (b) (1), conducted peak output power limit as below:

Frequency Range MHz	Limit W	Limit dBm
2400-2483.5	≤ 1	≤ 30

Test Results

Frequency MHz	Conducted peak Output Power dBm	Result
Top channel 2402MHz	4.20	Pass
Middle channel 2440MHz	4.25	Pass
Bottom channel 2480MHz	4.04	Pass

Test Graphs

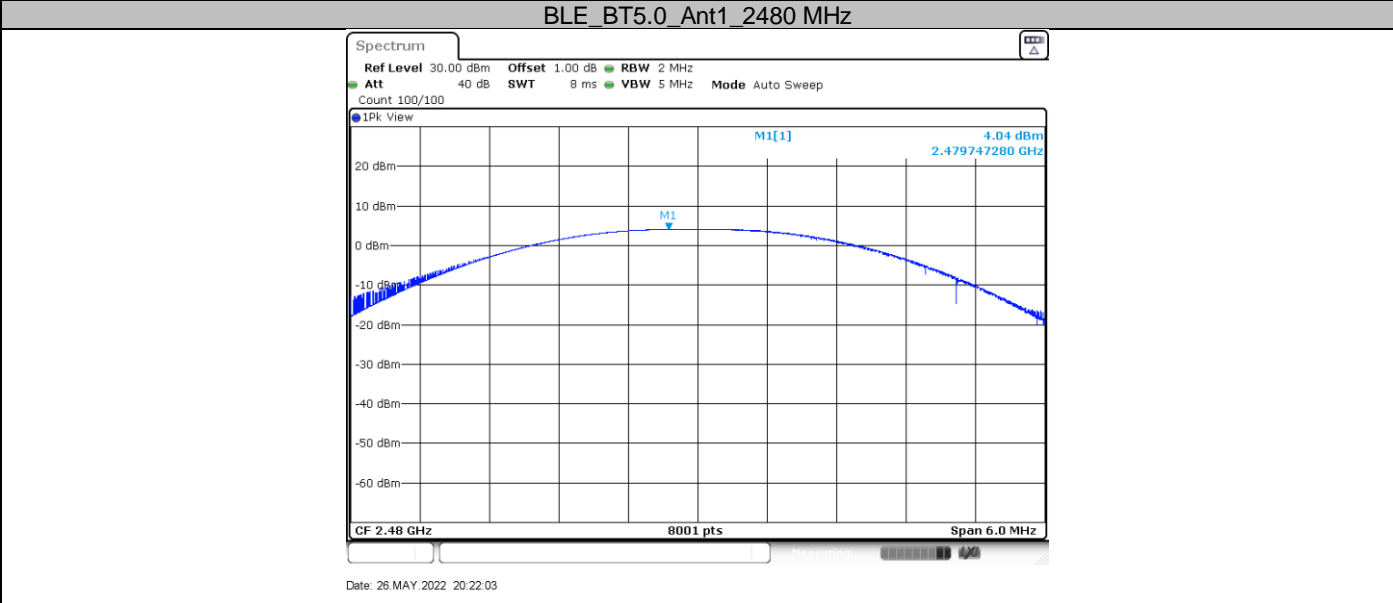
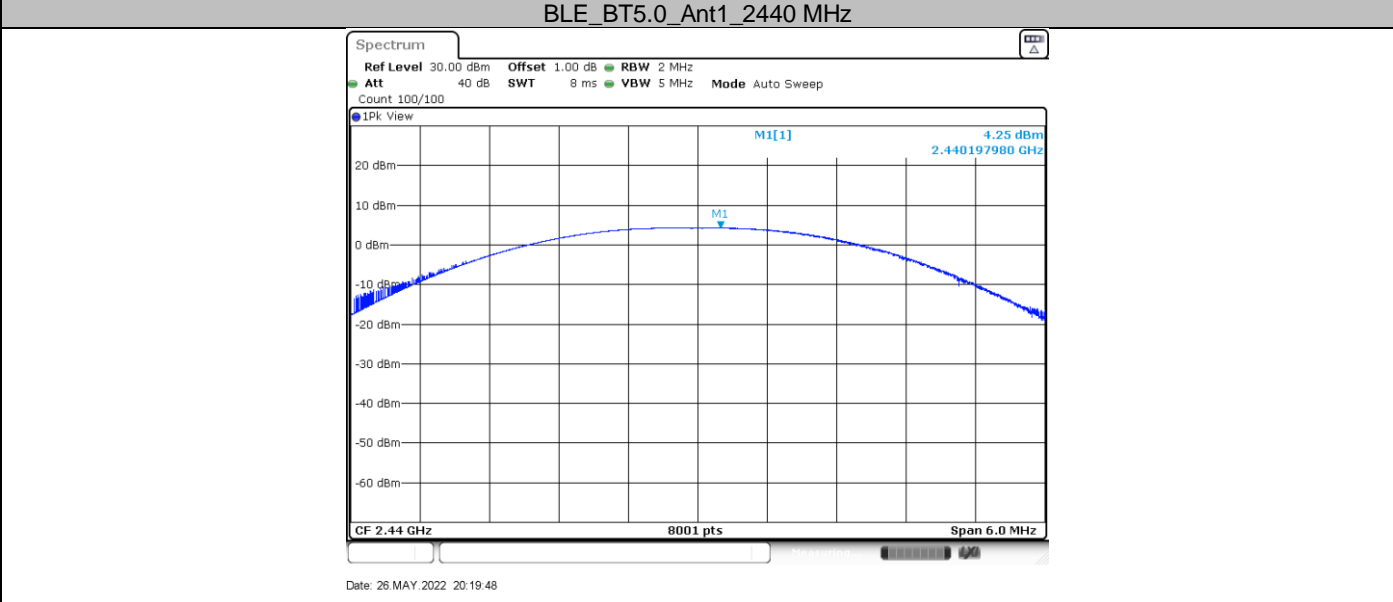
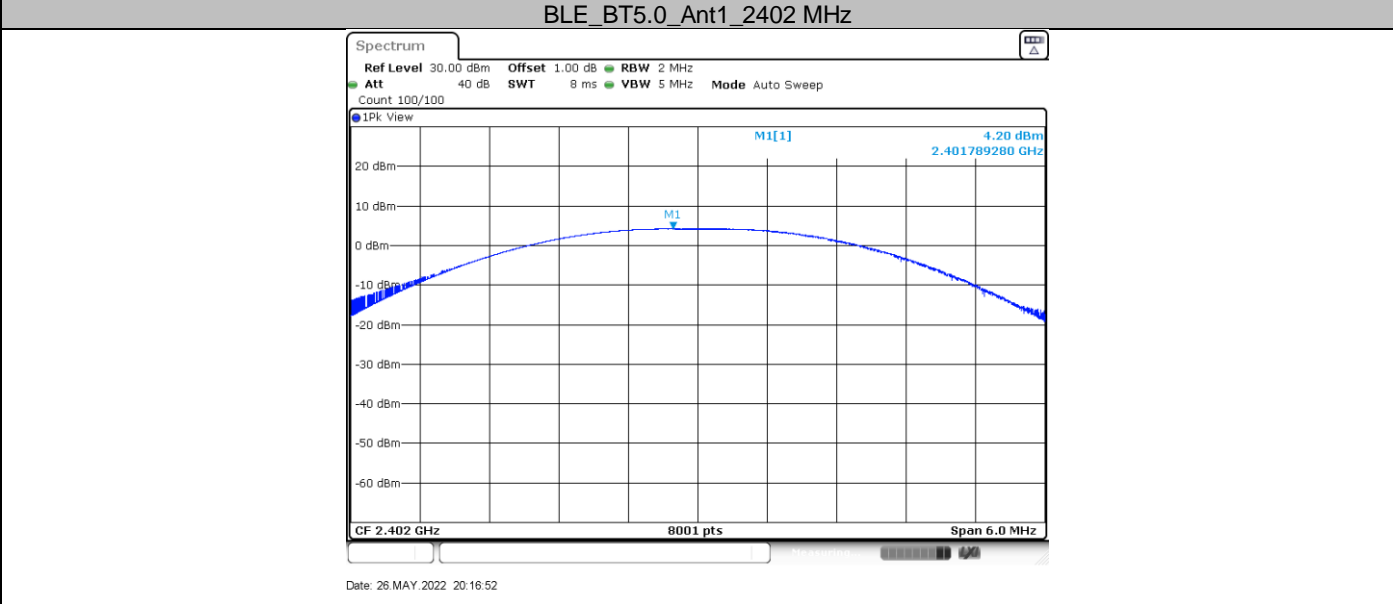



9.3 6dB bandwidth

Test Method

1. Use the following spectrum analyzer settings:
RBW=100K, VBW≥3RBW, Sweep = auto, Detector function = peak, Trace = max hold
2. Use the automatic bandwidth measurement capability of an instrument, may be employed using the X dB bandwidth mode with X set to 6 dB, care shall be taken so that the bandwidth measurement is not influenced by any intermediate power nulls in the fundamental emission that might be ≥ 6 dB.
3. Allow the trace to stabilize, record the X dB Bandwidth value.

Limit

Limit [kHz]

≥500

Test Results

Test Mode	Channel (MHz)	Result (MHz)	Limit (KHz)	Verdict
BLE (GFSK)	2402	1.039	≥500	PASS
BLE (GFSK)	2440	1.039	≥500	PASS
BLE (GFSK)	2480	1.039	≥500	PASS

Test Graphs

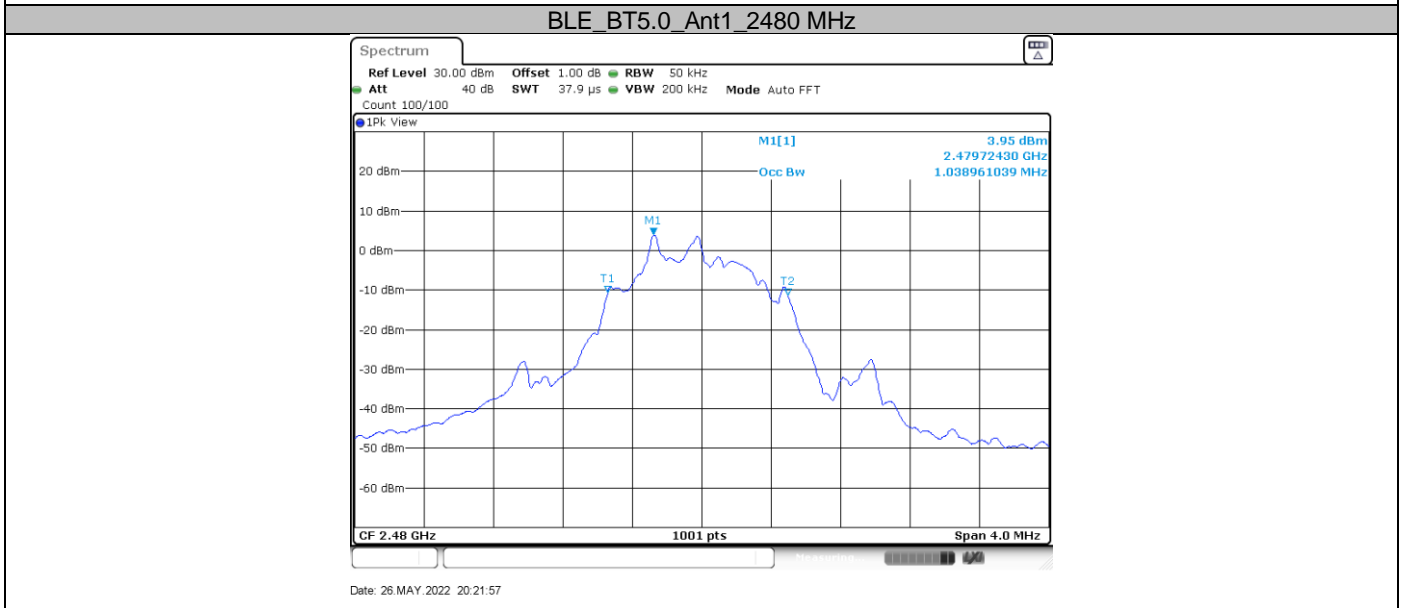
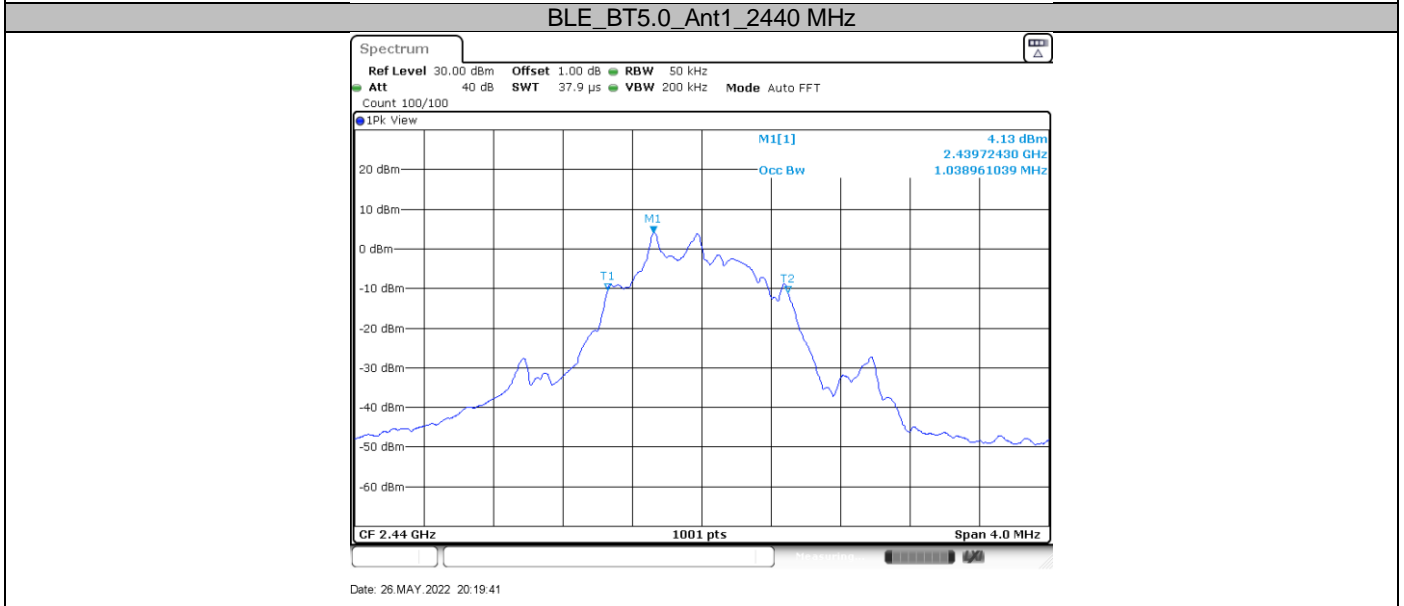
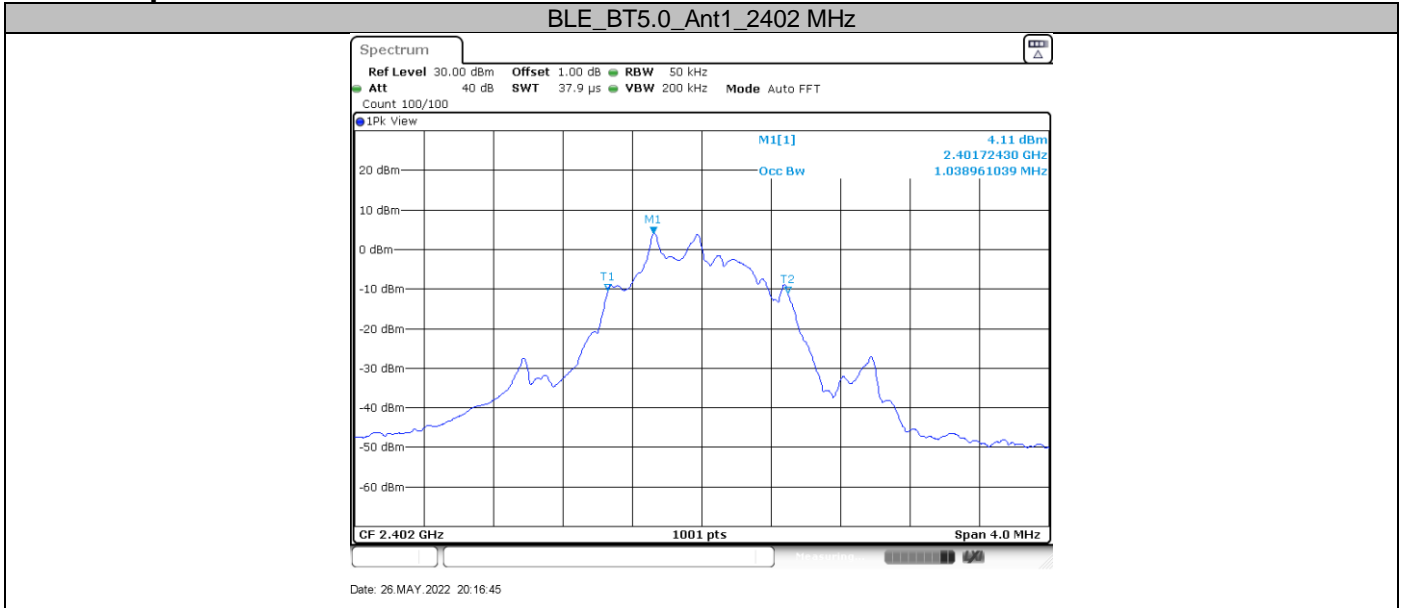

9.4 Power spectral density

Test Method

This procedure shall be used if maximum peak conducted output power was used to demonstrate compliance:

1. Set analyzer center frequency to DTS channel center frequency. RBW=3kHz, VBW \geq 3RBW, Span=1.5 times DTS bandwidth, Detector=Peak, Sweep=auto, Trace= max hold.
2. Allow trace to fully stabilize, use the peak marker function to determine the maximum amplitude level within the RBW.
3. Repeat above procedures until other frequencies measured were completed.

Limit

Limit [dBm/3KHz]

 ≤ 8

Test Results

Test Mode	Channel [MHz]	Result [dBm/3KHz]	Limit [dBm/3KHz]	Verdict
BLE (GFSK)	2402	3.22	8	PASS
BLE (GFSK)	2440	3.36	8	PASS
BLE (GFSK)	2480	3.08	8	PASS

Test Graphs

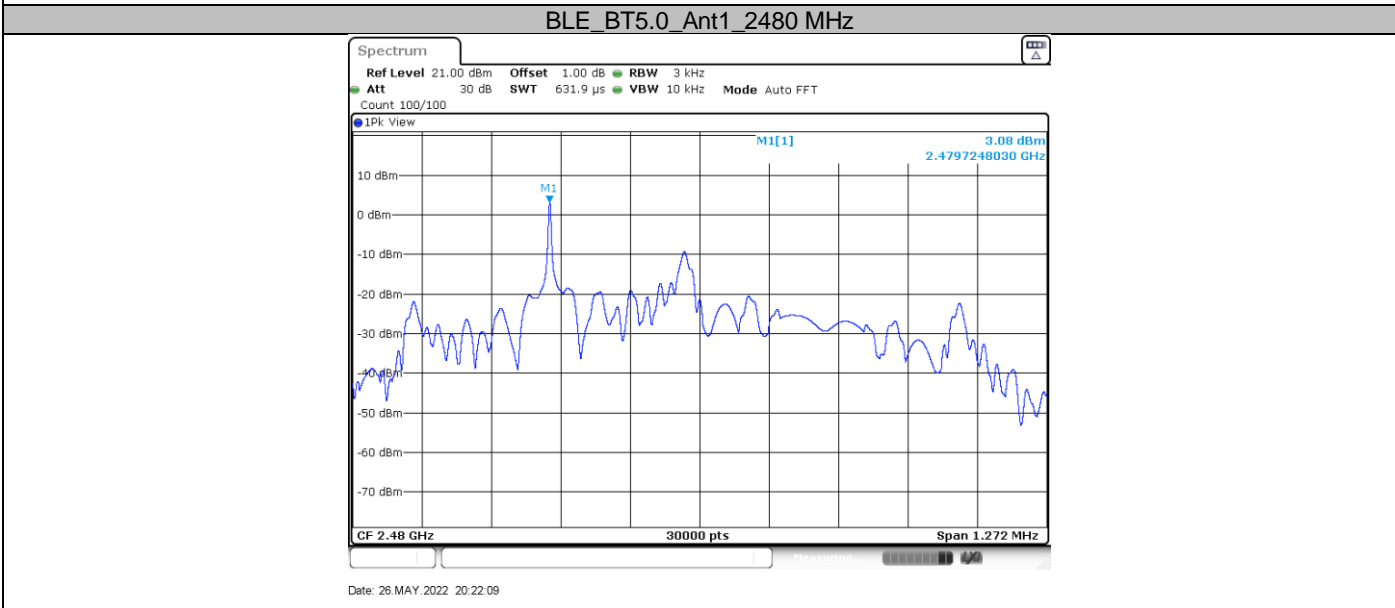
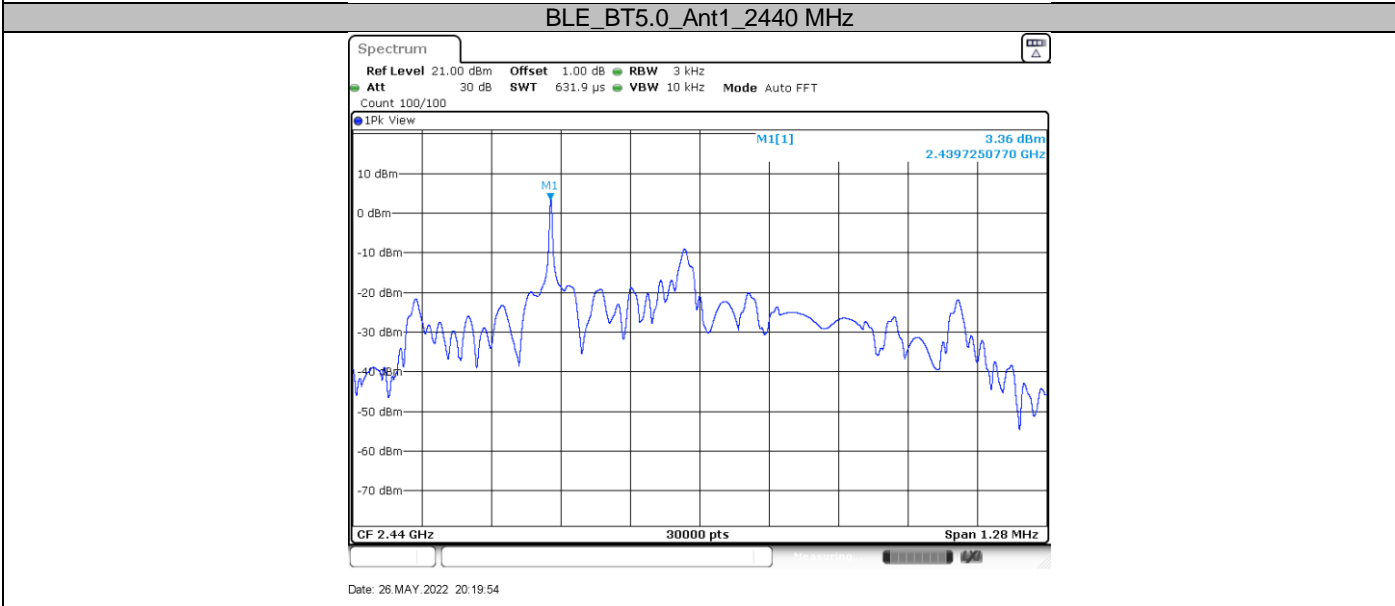
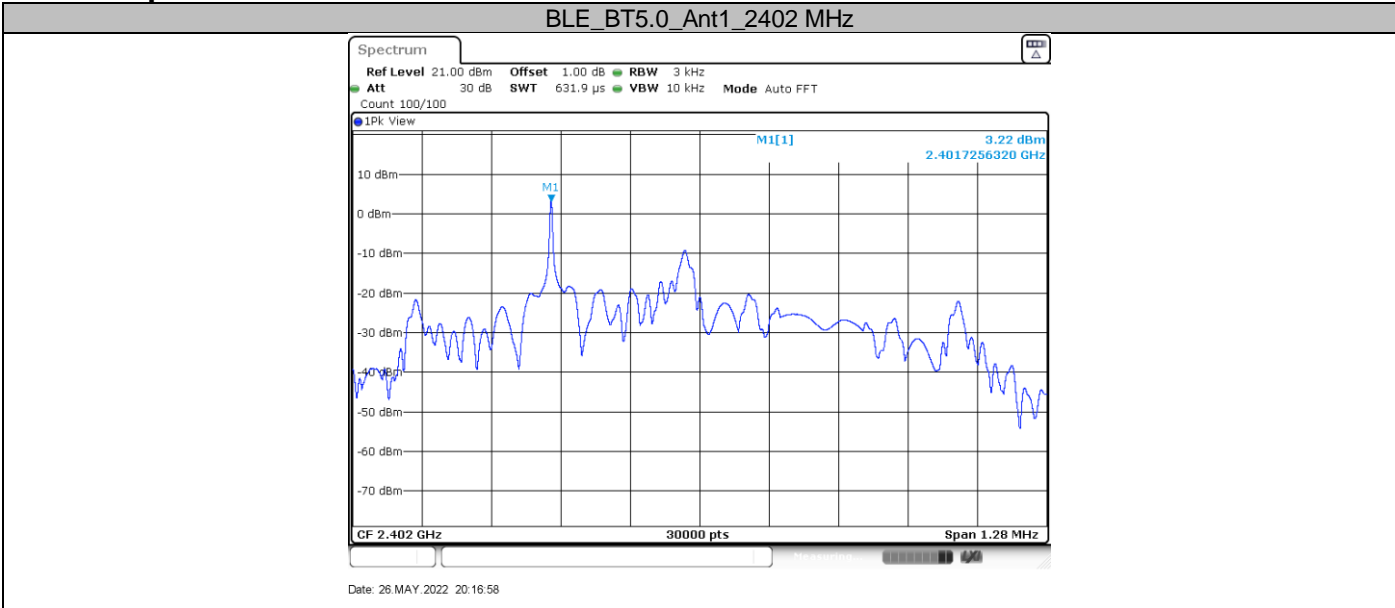



9.5 Spurious RF conducted emissions

Test Method

1. Establish a reference level by using the following procedure:
 - a. Set RBW=100 kHz. VBW≥3RBW. Detector =peak, Sweep time = auto couple, Trace mode = max hold.
 - b. Allow trace to fully stabilize, use the peak marker function to determine the maximum PSD level.
2. Use the maximum PSD level to establish the reference level.
 - a. Set the center frequency and span to encompass frequency range to be measured.
 - b. Use the peak marker function to determine the maximum amplitude level. Ensure that the amplitude of all unwanted emissions outside of the authorized frequency band (excluding restricted frequency bands) are attenuated by at least the minimum requirements, report the three highest emissions relative to the limit.
3. Repeat above procedures until other frequencies measured were completed.

Limit

Frequency Range MHz	Limit (dBc)
30-25000	-20

Test Results

Test Mode	Antenna	Channel (MHz)	Freq Range [MHz]	Ref Level [dBm]	Result [dBm]	Limit [dBm]	Verdict
BLE (GFSK)	Ant1	2402	Reference	4.09	4.09	---	PASS
			30~1000	30~1000	-65.52	<=-15.91	PASS
			1000~26500	1000~26500	-51.61	<=-15.91	PASS
		2440	Reference	4.23	4.23	---	PASS
			30~1000	30~1000	-65.55	<=-15.77	PASS
			1000~26500	1000~26500	-51.89	<=-15.77	PASS
		2480	Reference	3.95	3.95	---	PASS
			30~1000	30~1000	-64.82	<=-16.05	PASS
			1000~26500	1000~26500	-52.7	<=-16.05	PASS

Test Graphs

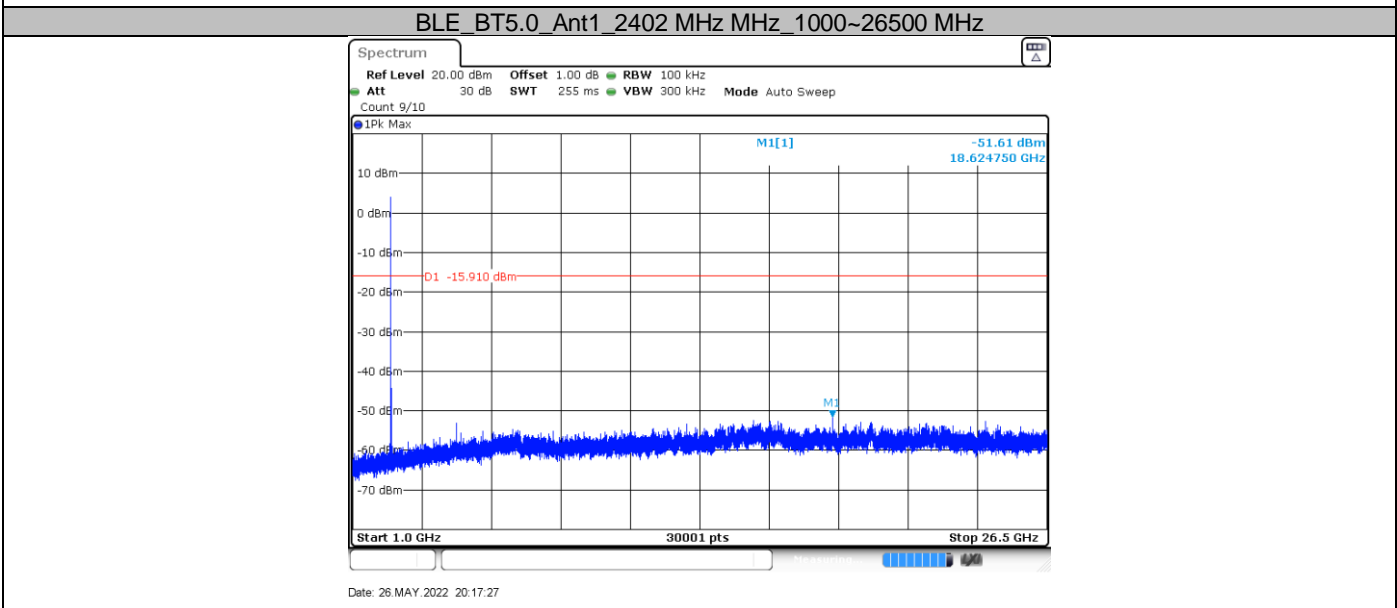
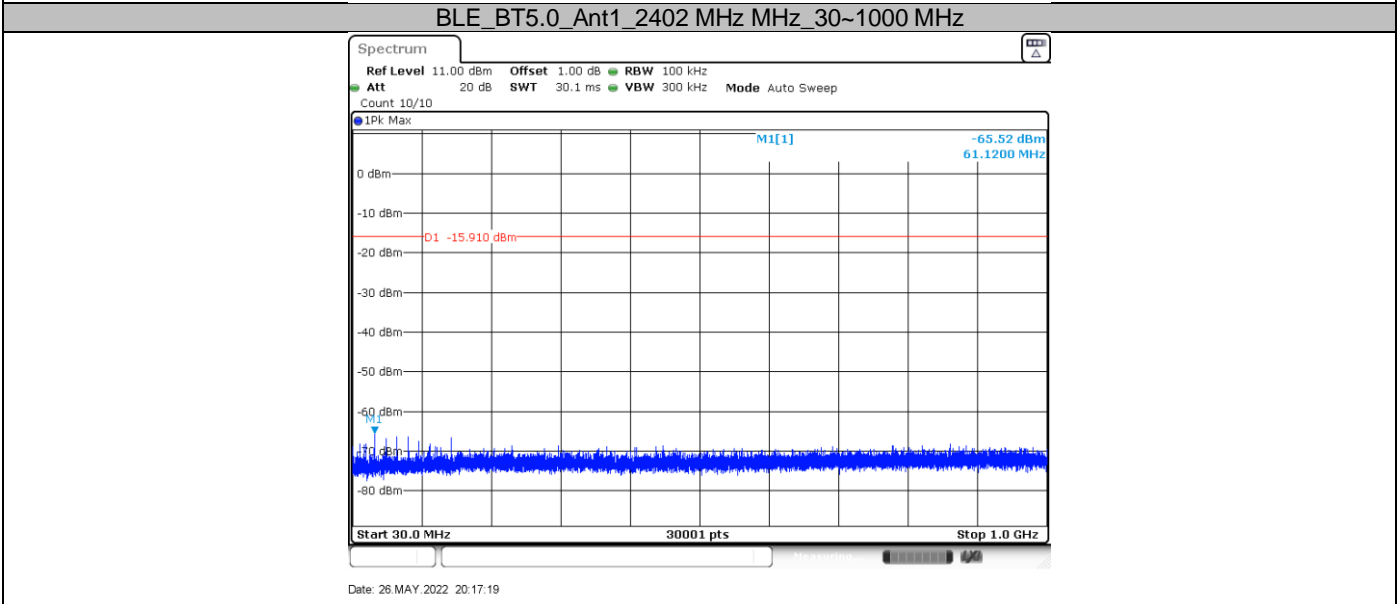
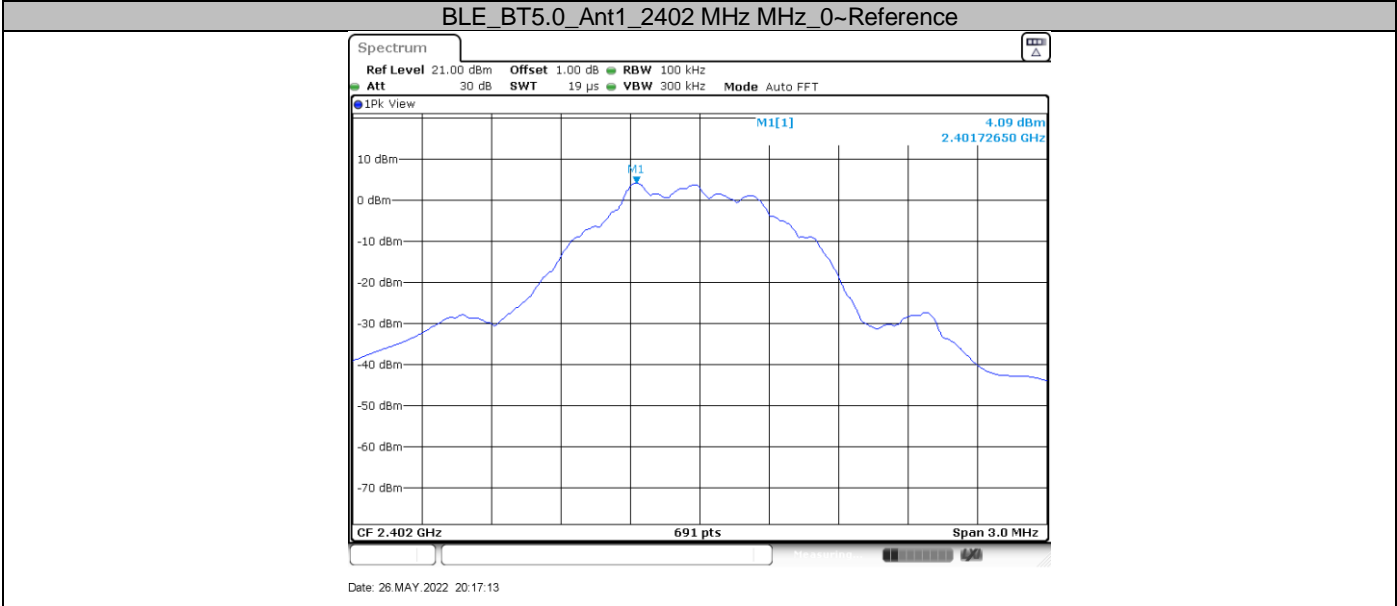

BLE_BT5.0_Ant1_2440 MHz MHz_0~Reference

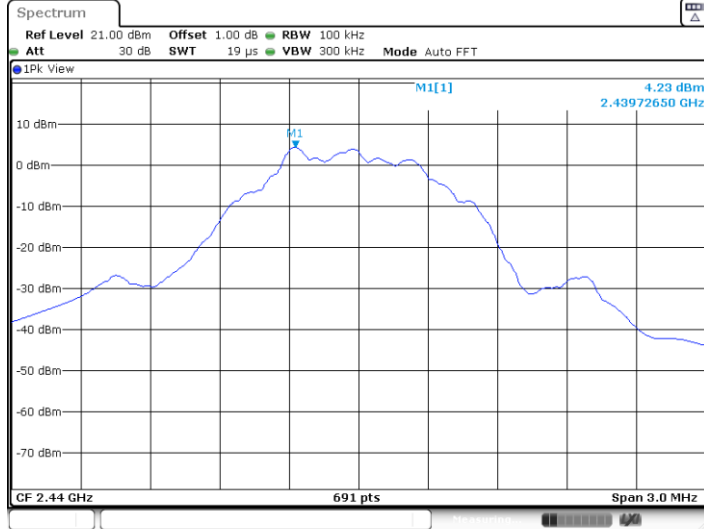

Date: 26 MAY 2022 20:19:59

BLE_BT5.0_Ant1_2440 MHz MHz_30~1000 MHz

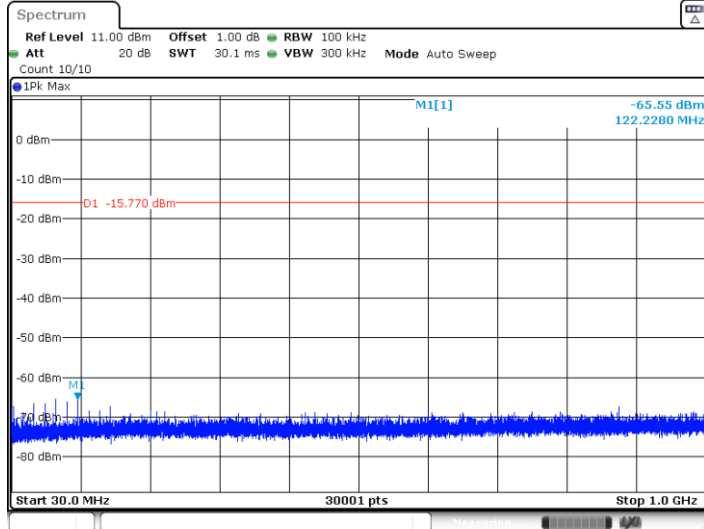

Date: 26 MAY 2022 20:20:05

BLE_BT5.0_Ant1_2440 MHz MHz_1000~26500 MHz

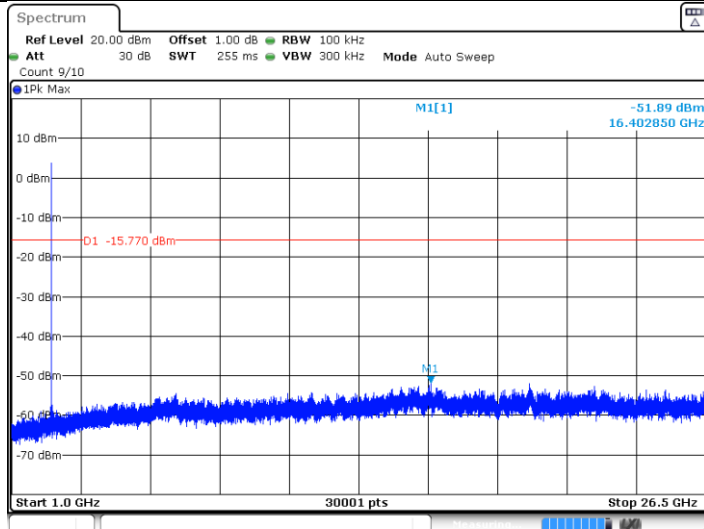

Date: 26 MAY 2022 20:20:13

BLE_BT5.0_Ant1_2480 MHz MHz_0~Reference

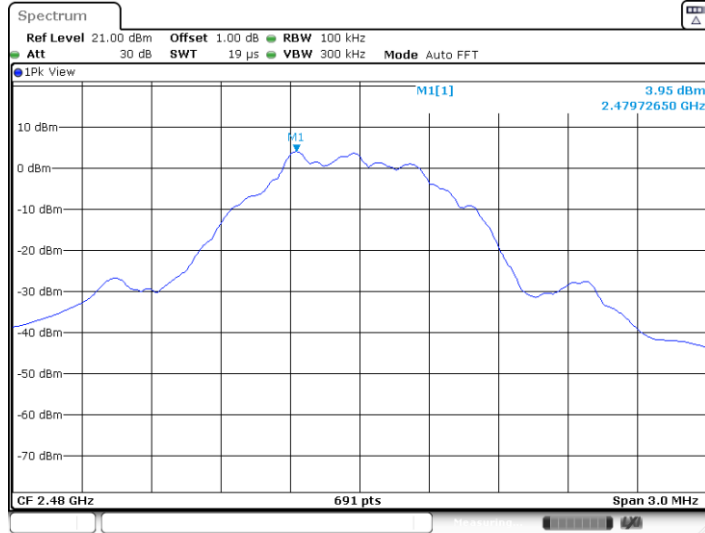

Date: 26 MAY 2022 20:22:24

BLE_BT5.0_Ant1_2480 MHz_30~1000 MHz

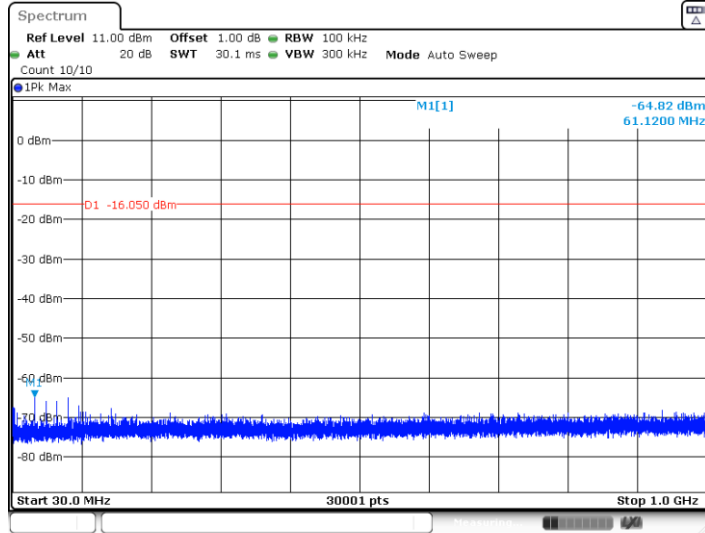

Date: 26 MAY 2022 20:22:30

BLE_BT5.0_Ant1_2480 MHz_1000~26500 MHz

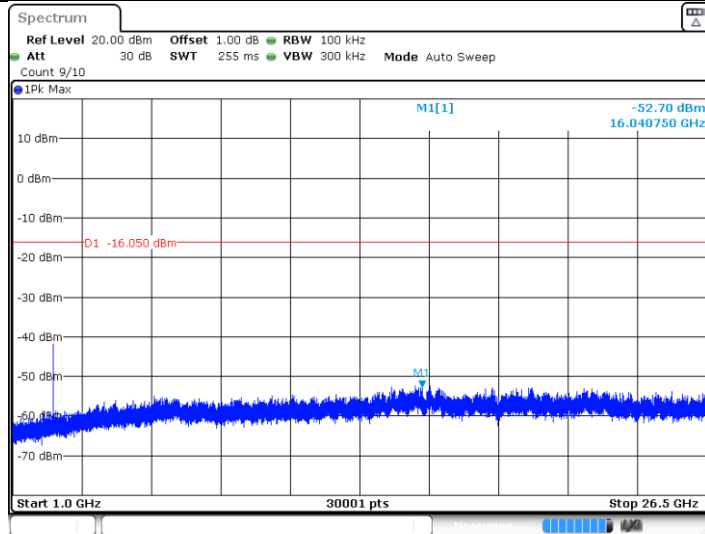

Date: 26 MAY 2022 20:22:38

9.6 Band edge

Test Method

- 1 Use the following spectrum analyzer settings:
Span = wide enough to capture the peak level of the in-band emission and all spurious
RBW = 100 kHz, VBW ≥ RBW, Sweep = auto, Detector function = peak, Trace = max hold.
- 2 Allow the trace to stabilize, use the peak and delta measurement to record the result.
- 3 The level displayed must comply with the limit specified in this Section.

Limit

Frequency Range MHz	Limit (dBc)
30-25000	-20

Test Results

Test Mode	Antenna	Ch Name	Channel [MHz]	Ref Level [dBm]	Result [dBm]	Limit [dBm]	Verdict
BLE (GFSK)	Ant1	Low	2402	4.13	-42.95	<=-15.87	PASS
		High	2480	3.81	-39.68	<=-16.19	PASS

Test Graphs

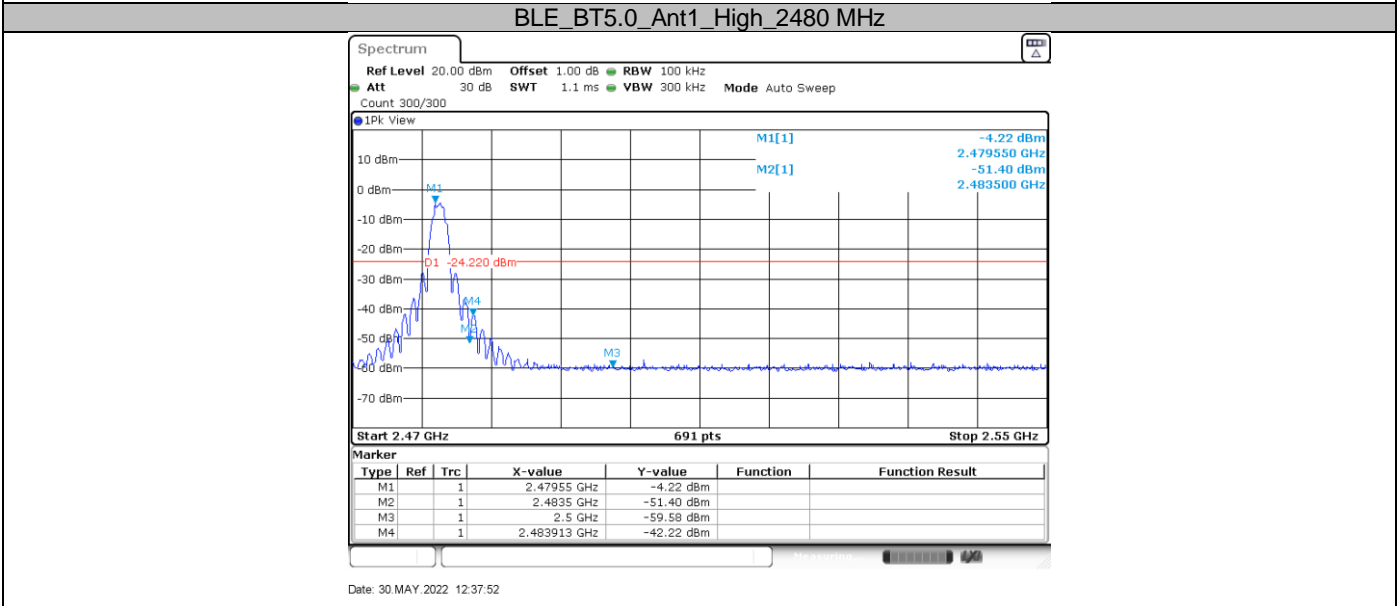
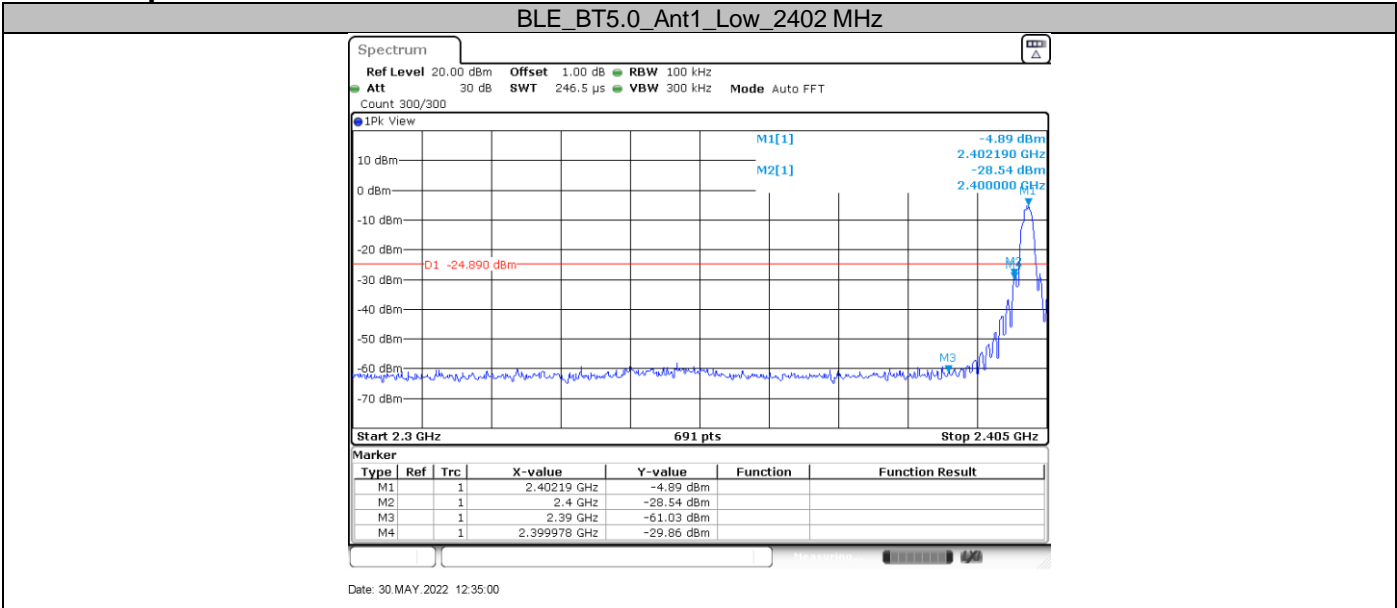

9.7 Spurious radiated emissions for transmitter

Test Method

- 1: The EUT was placed on a turn table which is 1.5m above ground plane for above 1GHz and 0.8m above ground for below 1GHz at 3 meter chamber room for test. The table was rotated 360 degrees to determine the position of the highest radiation.
- 2: The EUT was set 3 meters away from the interference – receiving antenna, which was mounted on the top of a variable – height antenna tower.
- 3: The height of antenna is varied from one meter to four meters above the ground to determine the maximum value of the field strength. Both horizontal and vertical polarizations of the antenna are set to make the measurement.
- 4: For each suspected emission, the EUT was arranged to its worst case and then the antenna was tuned to heights from 1 meter to 4 meters and the rotatable table was turned from 0 degrees to 360 degrees to find the maximum reading.
- 5: Use the following spectrum analyzer settings According to C63.10:

For Below 1GHz

Use the following spectrum analyzer settings:

Span = wide enough to capture the peak level of the in-band emission and all spurious
RBW = 100 KHz to 120KHz, VBW \geq RBW for peak measurement, Sweep = auto, Detector function = peak, Trace = max hold.

For Peak unwanted emissions Above 1GHz:

Span = wide enough to capture the peak level of the in-band emission and all spurious
RBW = 1MHz, VBW \geq RBW for peak measurement, Sweep = auto, Detector function = peak, Trace = max hold.

Procedures for average unwanted emissions measurements above 1000 MHz

- a) RBW = 1 MHz.
- b) VBW \geq [3 \times RBW].
- c) Detector = RMS (power averaging), if [span / (# of points in sweep)] \leq RBW / 2. Satisfying this condition can require increasing the number of points in the sweep or reducing the span. If the condition is not satisfied, then the detector mode shall be set to peak.
- d) Averaging type = power (i.e., rms) (As an alternative, the detector and averaging type may be set for linear voltage averaging. Some instruments require linear display mode to use linear voltage averaging. Log or dB averaging shall not be used.)
- e) Sweep time = auto.
- f) Perform a trace average of at least 100 traces if the transmission is continuous. If the transmission is not continuous, then the number of traces shall be increased by a factor of 1 / D, where D is the duty cycle. For example, with 50% duty cycle, at least 200 traces shall be averaged. (If a specific emission is demonstrated to be continuous—i.e., 100% duty cycle—then rather than turning ON and OFF with the transmit cycle, at least 100 traces shall be averaged.)
- g) If tests are performed with the EUT transmitting at a duty cycle less than 98%, then a correction factor shall be added to the measurement results prior to comparing with the emission limit, to compute the emission level that would have been measured had the test been performed at 100% duty cycle. The correction factor is computed as follows:
 - 1) If power averaging (rms) mode was used in the preceding step e), then the correction factor is [10 log (1 / D)], where D is the duty cycle. For example, if the transmit duty cycle was 50%, then 3 dB shall be added to the measured emission levels.
 - 2) If linear voltage averaging mode was used in the preceding step e), then the correction

factor is $[20 \log (1 / D)]$, where D is the duty cycle. For example, if the transmit duty cycle was 50%, then 6 dB shall be added to the measured emission levels.

3) If a specific emission is demonstrated to be continuous (100% duty cycle) rather than turning ON and OFF with the transmit cycle, then no duty cycle correction is required for that emission.

Limit

The radio emission outside the operating frequency band shall be at least 20 dB below that in the 100 kHz bandwidth within the band that contains the highest level of the desired power. Radiated emissions which fall in the restricted bands, as defined in section 15.205, must comply with the radiated emission limits specified in section 15.209.

Frequency MHz	Field Strength uV/m	Field Strength dB μ V/m	Detector
30-88	100	40	QP
88-216	150	43.5	QP
216-960	200	46	QP
960-1000	500	54	QP
Above 1000	500	54	AV
Above 1000	5000	74	PK

Spurious radiated emissions for transmitter

According to C63.10, if the peak (or quasi-peak) measured value complies with the average limit, it is unnecessary to perform an average measurement, so AV emission value did not show in below table if the peak value complies with average limit.

Transmitting spurious emission test result as below:

2402MHz (30MHz – 1GHz)

Frequency MHz	Emission Level dBuV/m	Polarization	Limit dB μ V/m	Margin dB	Detector	Corr. dB/m	Result
927.371250	34.53	Horizontal	46.00	11.47	QP	32.66	Pass
894.755000	34.12	Vertical	46.00	11.88	QP	32.29	Pass

2402MHz (Above 1GHz)

Frequency MHz	Emission Level dBuV/m	Polarization	Limit dB μ V/m	Margin dB	Detector	Corr. dB/m	Result
2382.500000*	48.17	Horizontal	74.00	25.83	PK	-5.65	Pass
2389.000000*	46.57	Vertical	74.00	27.43	PK	-5.62	Pass

2440MHz (30MHz – 1GHz)

Frequency MHz	Emission Level dBuV/m	Polarization	Limit dB μ V/m	Margin dB	Detector	Corr. dB/m	Result
--	--	Horizontal	--	--	QP	--	Pass
--	--	Vertical	--	--	QP	--	Pass

2440MHz (Above 1GHz)

Frequency MHz	Emission Level dBuV/m	Polarization	Limit dB μ V/m	Margin dB	Detector	Corr. dB/m	Result
9759.000000*	49.99	Horizontal	74.00	24.01	PK	13.14	Pass
4012.000000*	46.41	Vertical	74.00	27.59	PK	1.47	Pass

2480MHz (30MHz – 1GHz)

Frequency MHz	Emission Level dBuV/m	Polarization	Limit dB μ V/m	Margin dB	Detector	Corr. dB/m	Result
--	--	Horizontal	--	--	QP	--	Pass
--	--	Vertical	--	--	QP	--	Pass

2480MHz (Above 1GHz)

Frequency MHz	Emission Level dBuV/m	Polarization	Limit dB μ V/m	Margin dB	Detector	Corr. dB/m	Result
2500.000000*	48.47	Horizontal	74.00	25.53	9.21	-4.89	Pass
11439.000000*	45.47	Vertical	74.00	28.53	PK	13.16	Pass

Remark:

- (1) "*" means the emission(s) appear within the restrict bands shall follow the requirement of section 15.205.
- (2) Data of measurement within this frequency range shown "--" in the table above means the reading of emissions are the noise floor or attenuated more than 10dB below the permissible limits or the field strength is too small to be measured.
- (3) Level=Reading Level + Correction Factor
Above 1GHz: Corrector factor = Antenna Factor + Cable Loss- Amplifier Gain
Below 1GHz: Corrector factor = Antenna Factor + Cable Loss
(The Reading Level is recorded by software which is not shown in the sheet)

10 Test Equipment List

Radiated Emission Test 1# Test

DESCRIPTION	MANUFACTURER	MODEL NO.	EQUIPMENT ID	SERIAL NO.	CAL INTERVAL (YEAR)	CAL. DUE DATE
EMI Test Receiver	Rohde & Schwarz	ESR 7	68-4-74-19-001	102176	1	2023-5-27
Trilog Super Broadband Test Antenna	Schwarzbeck	VULB 9163	68-4-80-14-002	707	1	2022-7-23
Horn Antenna	Rohde & Schwarz	HF907	68-4-80-14-005	102294	1	2022-6-23
Loop Antenna	Rohde & Schwarz	HFH2-Z2	68-4-80-14-006	100398	1	2022-8-25
Pre-amplifier	Rohde & Schwarz	SCU 18	68-4-29-14-001	102230	1	2023-5-28
Attenuator	Mini-circuits	UNAT-6+	68-4-81-21-001	15542	1	2023-5-27
3m Semi-anechoic chamber	TDK	SAC-3 #1	68-4-90-14-001	----	2	2023-5-28
Test software	Rohde & Schwarz	EMC32	68-4-90-14-001-A10	Version10.35.02	N/A	N/A

RF Conducted Test

DESCRIPTION	MANUFACTURER	MODEL NO.	EQUIPMENT ID	SERIAL NO.	CAL INTERVAL (YEAR)	CAL. DUE DATE
Signal Generator	Rohde & Schwarz	SMB100A	68-4-48-14-001	108272	1	2023-5-27
Vector Signal Generator	Rohde & Schwarz	SMBV100A	68-4-48-18-001	262825	1	2023-5-27
Communication Synthetical Test Instrument	Rohde & Schwarz	CMW 270	68-4-48-18-003	101251	1	2023-5-27
Signal Analyzer	Rohde & Schwarz	FSV40	68-4-74-14-004	101030	1	2023-5-27
Vector Signal Generator	Rohde & Schwarz	SMU 200A	68-4-48-14-003	105324	1	2023-5-27
RF Switch Module	Rohde & Schwarz	OSP120/OSP-B157	68-4-93-14-003	101226/100851	1	2023-5-27
Power Splitter	Weinschel	1580	68-4-85-14-001	SC319	1	2023-5-28
10dB Attenuator	Weinschel	4M-10	68-4-81-14-003	43152	1	2023-5-28
10dB Attenuator	R&S	DNF	68-4-81-14-004	DNF-001	1	2023-5-27
10dB Attenuator	R&S	DNF	68-4-81-14-005	DNF-002	1	2023-5-27
10dB Attenuator	R&S	DNF	68-4-81-14-006	DNF-003	1	2023-5-27
10dB Attenuator	R&S	DNF	68-4-81-14-007	DNF-004	1	2023-5-27
Test software	Rohde & Schwarz	EMC32	68-4-48-14-003-A10	Version 10.60.10	N/A	N/A
Test software	Tonscend	System for BT/WIFI	68-4-74-14-006-A13	Version 2.6.77.0518	N/A	N/A
Shielding Room	TDK	TS8997	68-4-90-19-003	----	3	2022-11-07

11 System Measurement Uncertainty

For a 95% confidence level, the measurement expanded uncertainties for defined systems, in accordance with the recommendations of ISO 17025 were:

System Measurement Uncertainty	
Items	Extended Uncertainty
Uncertainty for Radiated Spurious Emission 25MHz-3000MHz	Horizontal: 4.35dB; Vertical: 4.44dB;
Uncertainty for Radiated Spurious Emission 3000MHz-18000MHz	Horizontal: 4.30dB; Vertical: 4.29dB;
Uncertainty for Radiated Spurious Emission 18000MHz-40000MHz	Horizontal: 4.51dB; Vertical: 4.50dB;
Uncertainty for Conducted RF test with TS 8997	RF Power Conducted: 1.31dB Frequency test involved: 0.6×10 ⁻⁷ or 1%

Measurement Uncertainty Decision Rule

Determination of conformity with the specification limits is based on the decision rule according to IEC Guide 115: 2007, clause 4.4.3 and 4.5.1.