

2.4GHz 3216 Chip Antenna: RANT3216F245C01



Application:

WLAN, 802.11b/g, Bluetooth, WLAN, etc...

Features

SMD, high reliability, ultra Impact, Omni-directional...



Part number Information

RANT 3216 F 245 C 01
(A) (B) (C) (D) (E) (F)

(A) Product Type	Chip Antenna
(B) Size Code	3.2x1.6mm(±0.2mm)
(C) Material	High K material
(D) Frequency	2.4 ~ 2.5GHz
(E) Feeding mode	PIFA & Single Feeding
(F) Antenna type	Type=01

Electrical Specification

Working Frequency Range	2400 ~2500 MHz
Bandwidth	120 MHz (Min.)
Peak Gain	1.15 dBi (Typ.)
Impedance	50 Ohm
Return loss	10 dB (Min)
Polarization	Linear
Azimuth Beamwidth	Omni-directional
Operation Temperature(°C)	-40 ~85 °C
Resistance to Soldering Heats	10sec. (@ 280°C)
Termination	Ni / Au (Leadless)

The specification is defined on EVB.

Dimension and Terminal Configuration

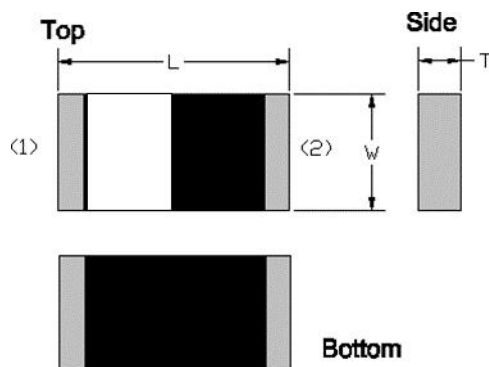

Dimension (mm)	
L	3.20 ± 0.20
W	1.60 ± 0.20
T	0.45 ± 0.20

No.	Terminal Name
1	Feeding/GNG
2	GND/Feeding

Evaluation Board Reference

PCB Dimension	Antenna Layout Reference
	Unit :mm

Electrical Characteristics

Return Loss & Radiation

Return Loss

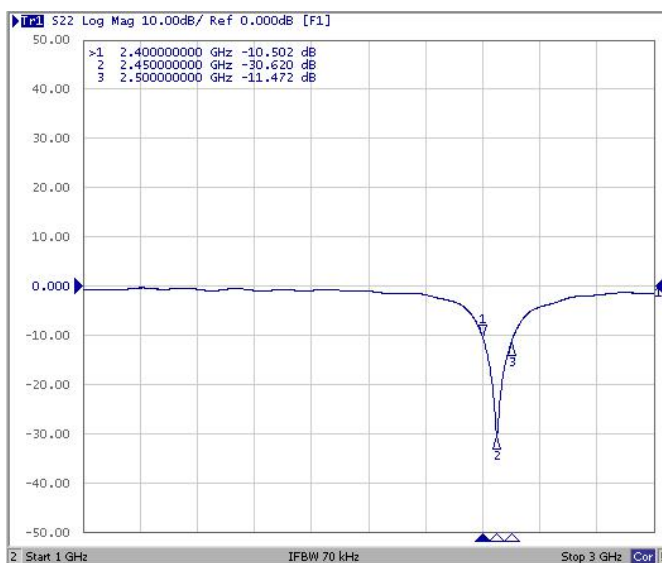

Frequency(MHz)	S11 (dB)
2400	-10.50
2450	-30.62
2500	-11.47

Radiation

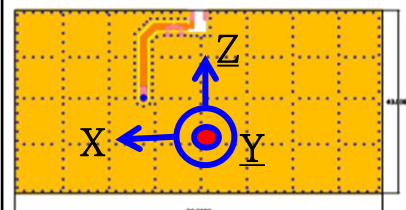
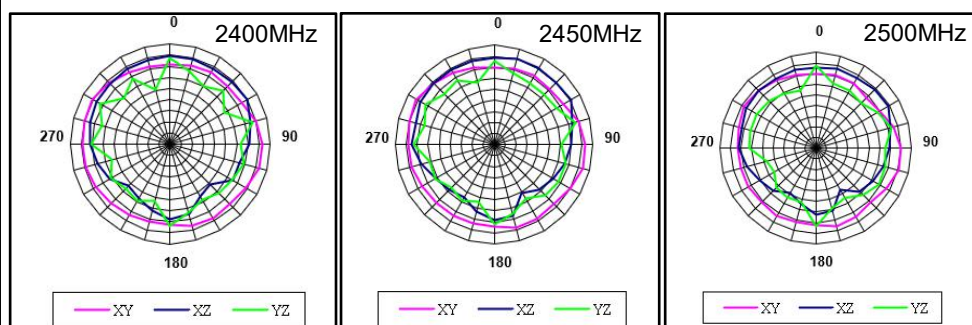

	2400MHz	2450MHz	2500MHz
Efficiency	82.52%	85.26%	83.01%
Peak Gain	1.15 dBi	1.24 dBi	1.19 dBi
Directivity	1.89 dBi	1.97 dBi	1.91 dBi

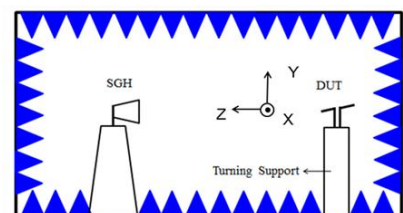

Taping Specifications

Reel and Taping Specification

Reel Specification

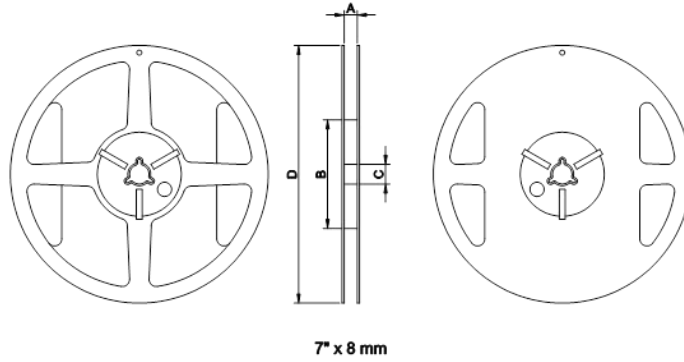

TYPE	SIZE		A	B	C	D
3216	7"	5K/Reel	9.0±0.5	60±2	13.5±0.5	178±2

Tapping Specification

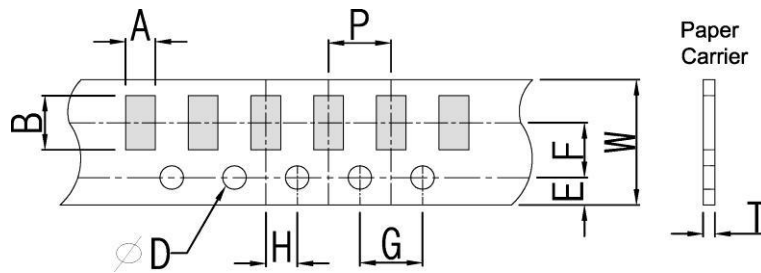

Packaging	Type	A	B	W	E	F	G	H	T	ψ D	P
Paper Type	3216	1.90±0.20	3.50±0.20	8.0±0.20	1.75±0.10	3.5±0.05	4.0±0.10	2.0±0.05	0.75±0.10	1.50±0.10	4.0±0.1

2.4GHz 3216 Chip Antenna: RANT3216F245C01



Reliability Table

Test Item	Procedure	Requirements Ceramic Type	Remark (Reference)
Electrical Characterization		Fulfill the electrical specification	User Spec.
Thermal Shock	<ol style="list-style-type: none"> 1. Preconditioning: 50 ± 10°C / 1 hr , then keep for 24 ± 1 hrs at room temp. 2. Initial measure: Spec: refer Initialspec. 3. Rapid change of temperature test: -30°C to +85°C; 100 cycles; 15 minutes at Lower category temperature; 15 minutes at Upper category temperature. 	No Visible Damage. Fulfill the electrical specification.	MIL-STD-202 107
Temperature Cycling	<ol style="list-style-type: none"> 1. Initial measure: Spec: refer Initialspec. 2. 100 Cycles (-30°C to +85°C), Soak Mode=1 (2 Cycle/hours). 3. Measurement at 24 ± 2Hours after test condition. 	No Visible Damage. Fulfill the electrical specification.	JESD22 JA104
High Temperature Exposure	<ol style="list-style-type: none"> 1. Initial measure: Spec: refer Initialspec. 2. Unpowered; 500hours @ T=+85°C. 3. Measurement at 24 ± 2 hours aftertest. 	No Visible Damage. Fulfill the electrical specification.	MIL-STD-202 108
Low Temperature Storage	<ol style="list-style-type: none"> 1. Initial measure: Spec: refer Initialspec. 2. Unpowered: 500hours @ T=-30°C. 3. Measurement at 24 ± 2 hours aftertest. 	No Visible Damage. Fulfill the electrical specification.	MIL-STD-202 108
Solderability (SMD Bottom Side)	Dipping method: <ol style="list-style-type: none"> a. Temperature: 235 ± 5°C b. Dipping time: 3 ± 0.5s 	The solder should cover over 95% of the critical area of bottom side.	IEC 60384-21/22 4.10
Soldering Heat Resistance (RSH)	Preheating temperature: 150 ± 10°C. Preheating time: 1~2 min. Solder temperature: 260 ± 5°C. Dipping time: 5 ± 0.5s	No Visible Damage.	IEC 60384-21/22 4.10
Vibration	5g's for 20 min., 12 cycles each of 3 orientations Note: Use 8"X5" PCB .031" thick 7 secure points on, one long side and 2 secure points at corners of opposite sides. Parts mounted within 2" from any secure point. Test from 10-2000 Hz.	No Visible Damage.	MIL-STD-202 Method 204
Mechanical Shock	Three shocks in each direction shall be applied along the three mutually perpendicular axes of the test specimen (18 shocks) Peak value: 1,500g's Duration: 0.5ms Velocity change: 15.4 ft/s Waveform: Half-sine	No Visible Damage.	MIL-STD-202 Method 213
Humidity Bias	<ol style="list-style-type: none"> 1. Humidity: 85% R.H., Temperature: 85 ± 2 °C. 2. Time: 500 ± 24 hours. 3. Measurement at 24 ± 2hrs after test condition. 	No Visible Damage. Fulfill the electrical specification.	MIL-STD-202 Method 106

2.4GHz 3216 Chip Antenna: RANT3216F245C01

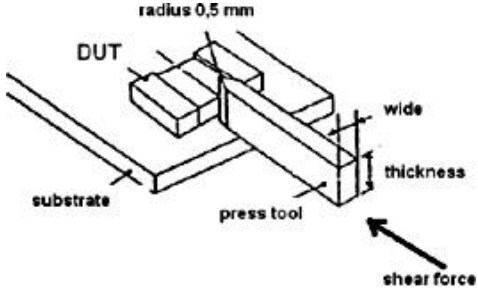
Board Flex (SMD)	<p>1. Mounting method: IR-Reflow. PCB Size (L:100 × W:40 × T:1.6mm)</p> <p>2. Apply the load in direction of the arrow until bending reaches 2 mm.</p>	<p>No Visible Damage.</p>	<p>AEC-Q200 005</p>
Adhesion	<p>Force of 1.8Kg for 60 seconds.</p> 	<p>No Visible Damage Magnification of 20X or greater may be employed for inspection of the mechanical integrity of the device body terminals and body/terminal junction.</p>	<p>AEC-Q200 006</p>
Physical Dimension	<p>Any applicable method using x10 magnification, micrometers, calipers, gauges, contour projectors, or other measuring equipment, capable of determining the actual specimen dimensions.</p>	<p>In accordance with specification.</p>	<p>JESD22 JB100</p>

Revision History

Revision	Date	Content
1	2019/03/01	New Datasheet
2	2020/02/22	Add 2D radiation characteristic